

| | | | |
|----------|-----------------|-------------------|---------------|
| Model | V-CE621CAS | | |
| Language | English+Chinese | | |
| Page | 27 | Color(cover/body) | 1/1 |
| Material | Weight 100g | Size(W*H) | 150×220(mm) |
| Date | 2009.05.05 | Designer | ZHANGDONGYUE |
| Part No. | MFL57903824 | Description | Owners Manual |

Chage Record

| No. | Change content | ECO No. | Date | Designer | Confirm |
|-----|----------------|---------|------|----------|---------|
| ① | | | | | |
| ② | | | | | |
| ③ | | | | | |
| ④ | | | | | |
| ⑤ | | | | | |
| ⑥ | | | | | |
| ⑦ | | | | | |
| ⑧ | | | | | |
| ⑨ | | | | | |



使用说明书



吸尘器

强劲吸力

V-CE621CAS

中文 → 1-22页

English → Page 23-43

售后服务电话



使用前请仔细阅读说明书，阅读完后请妥善保管以备需要时查阅。

目 录

| | |
|-------------------------------------|-------|
| 产品规格 | 2 |
| 使用前注意事项 | 3-6 |
| 吸尘器的组装 | 7 |
| 部分名称与连接方法 | |
| 附件 | |
| 角落刷头、尖细嘴的使用方法 | 8 |
| 震动刷头使用方法与清洗方法 | 9 |
| 集尘桶的拆卸 / 清理方法 | 10 |
| 灰尘分离器的清理方法 | |
| 集尘桶、灰尘分离器的清理安装方法 | 11 |
| 清洗方法 | |
| 安装方法 | |
| 电机保护过滤器的拆卸 / 洗涤 / 安装方法 | 12 |
| 拆卸方法 | |
| 清洗方法 | |
| 排气过滤器的拆卸 / 清洁 / 安装方法 | 13 |
| 拆卸方法 | |
| 清洗方法 | |
| 安装方法 | |
| 蒸汽吸尘器的基本使用方法 | 14 |
| 补充水的方法 | |
| 粘贴抹布的方法 | |
| 真空清扫 / 蒸汽清扫 / 真空蒸汽同时清扫 | 15 |
| 地板 / 一般地面清扫 | 16 |
| 补充水的方法 | 17 |
| 使用完后保管方法 | 18 |
| 故障通告前需确认事项 | 19-21 |
| 装箱单 | 22 |

产品规格

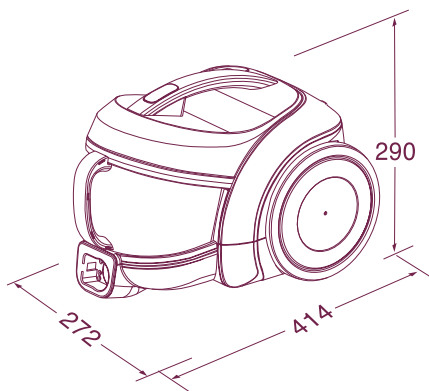

型号: V-CE621CAS
额定电压: 220V~ 50Hz
额定功率: 2050W
最大功率: 2250W
吸率: 320W
净重: 5.3Kg
集尘容量: 1.5L
外形尺寸: 272mm x 414mm x 290mm
本产品执行标准: GB4706.1-2005
GB4706.7-2004
GB17625.1-2003
GB4343-2003

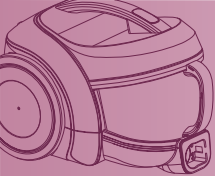

※ 为了提高产品质量而进行的外观及设计规格上的变更将不再另行通知。



使用前注意事项

使用前注意事项

忽视说明而导致的错误操作将会对您造成不同程度的损害，请认真阅读以下提示说明。

-  **危险** 此标识表明违反标记事项时，会立刻发生严重伤害或死亡现象。
-  **警告** 此标识表明违反标记事项时，有可能发生严重伤害或死亡现象。
-  **注意** 此标识表明违反此标记事项时，有可能发生财产损失或轻微伤害。

危险

请不要在易燃液体附近使用吸尘器，以免发生火灾。



插拔电源插头时，请先关闭电源开关，以免发生火灾或触电的危险。请不要用湿手触摸电源插头，以防触电。（不要在220V以外的电源上使用产品）



警告

请不要让大头钉等金属物存留在软管、机体延长管内，否则会造成短路故障。请不要吸入头发团、大纸团等物品，否则容易堵塞软管，如有堵管现象，请及时清理。

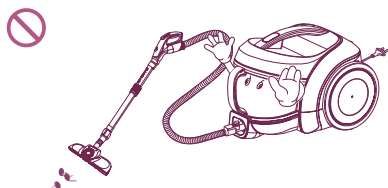

为避免发生火灾或触电的危险，在清扫时，注意不要让机体吸入液体、刀片、火种以及水泥、石膏粉、装修完了后的锯末等小微粒。

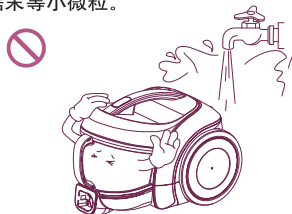

15A以上的电流请单独使用插线板，在一个插线板上同时使用多种电器可能会引发火灾。建议不要使用电源线延长线，以免引起不必要的危险。本吸尘器最大电流为6A。

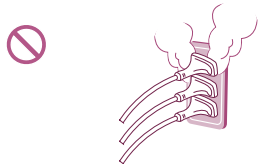

长时间不使用电器时，请记住拔掉电源插头；正处于通电时，请您不要离开。

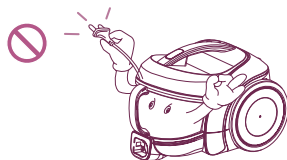

使用前注意事项

警告

在原木地板、喷涂地面或瓷砖等地面上使用时，需要注意：1.长期将蒸汽刷头放置在固定位置时，一些地板可能会发生热变色、热变形等；2.使用湿抹布时，地板缝隙中可能会渗入水分，对地板造成影响。

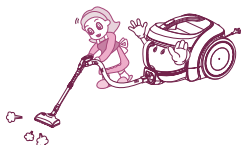

在未切断电源的情况下，或蒸汽刷头在使用过程中，禁止打开注水口盖子，或进行注水。否则高温水蒸汽或热水溢出，会发生烫伤事故。



本产品发生高温的水蒸气，使用前必须确认地面材质可否适用。请咨询于厂商。禁止用手或脚触摸蒸汽刷头的底部。



禁止用水或其他洗涤剂清洗蒸汽刷头表面和底部，否则会损坏产品或发生漏电等事故。

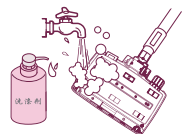

清洁地板时，蒸汽刷头必须粘贴抹布使用，否则，地面材料在高温蒸汽下可能会发生变色、变形等；清洁地毯时，去掉抹布使用。



禁止将蒸汽刷头长时间停留在一个地方或长时间在同一地方反复使用蒸汽刷头。否则高温水蒸气可能会引起地面热变色或热变形等。



在未切断电源的情况下，蒸汽刷头在使用过程中或刚使用完之后，禁止将刷头翻转或倾斜。因为此时高温水蒸汽在喷射当中，会发生烫伤事故。

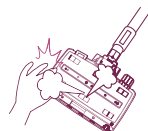

禁止使用其他合成洗涤剂、化学物质或液体来代替水注入刷头。这样会损伤产品或发生爆炸等事故。



散热或使用中暂时休息时，必须将蒸汽刷头放置在指定的托盘上。否则，热的刷头长期直接放置在地板上，可能会对地板造成影响。



儿童，老人等不了解产品的人群，禁止使用。会发生烫伤的事故。



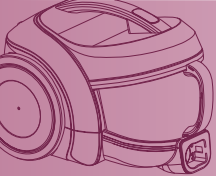

使用前注意事项

警告

蒸汽刷头使用时或加热状态下，禁止触摸蒸汽刷头表面。否则会发生烫伤等事故。

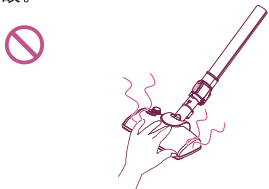

蒸汽软管和伸缩管内部有电气连接部件，因此禁止用于吸水或用水清洗。请定期确认软管和伸缩管有无异常，若有损坏应终止使用，并联系售后服务部门。



禁止蒸气冲向人、动物以及容纳电气部件的装置，避免发生烫伤等危险。

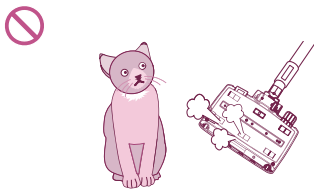

粘贴或更换抹布时，必须在关机之后，用抹布板装卸。开机状态下更换抹布会发生地面损伤和烫伤等事故。

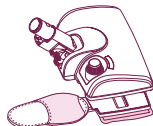

在开机状态下或吸尘器使用过程中，如果“漏电卡断器”发生作用，应立即停止使用，并联系售后服务中心。

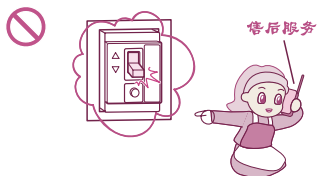

使用前注意事项

警告

请不要让电源线与吸尘器接近电暖器等热源,以免使机体变形或发生火灾。请您不要使用破损的电源和插头,如有破损,必须由指定维修站更换。

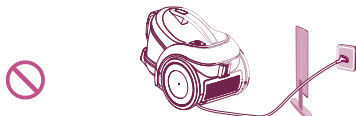

请不要让儿童把吸尘器及组件,如延长管等当做玩具,以防止意外。



请不要在吸入口和排气口堵塞时,继续长时间运作,否则可能造成机体变形或损坏。

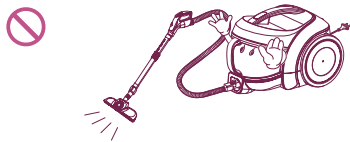

使用过程中,延长管和机体会产生静电的可能,请您使用时注意。



注意

非专业维修人员请勿开机修理。



注意不要使电源线夹在门缝里或用电源线提拉吸尘器,防止电源线受损。



请您注意保护自身安全,使身体各部位远离吸尘器吸口或活动部位。



清洁地毯的时候,必须去掉抹布后使用。



请不要弯曲、践踏、拉拽软管,如软管受损,请不要继续使用。请不要用重物或尖刃物压线。

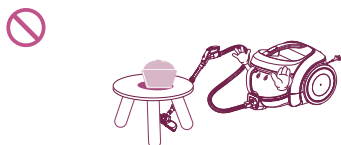

集尘筒集满时,请您正确开启集尘筒清理。请您注意不要在没安装集尘筒或过滤网时使用吸尘器。

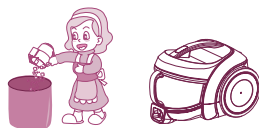

收卷电线时,请拿住电源插头后再按动卷线器按钮。请不要将电源线拉至红色警告线以外,否则可能损坏电源线或不能回卷。收线时请注意插头,以免损坏周围物品。

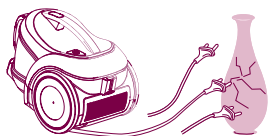

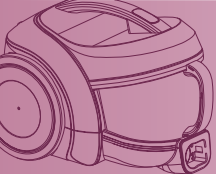

吸尘器的组装

部分名称与连接方法

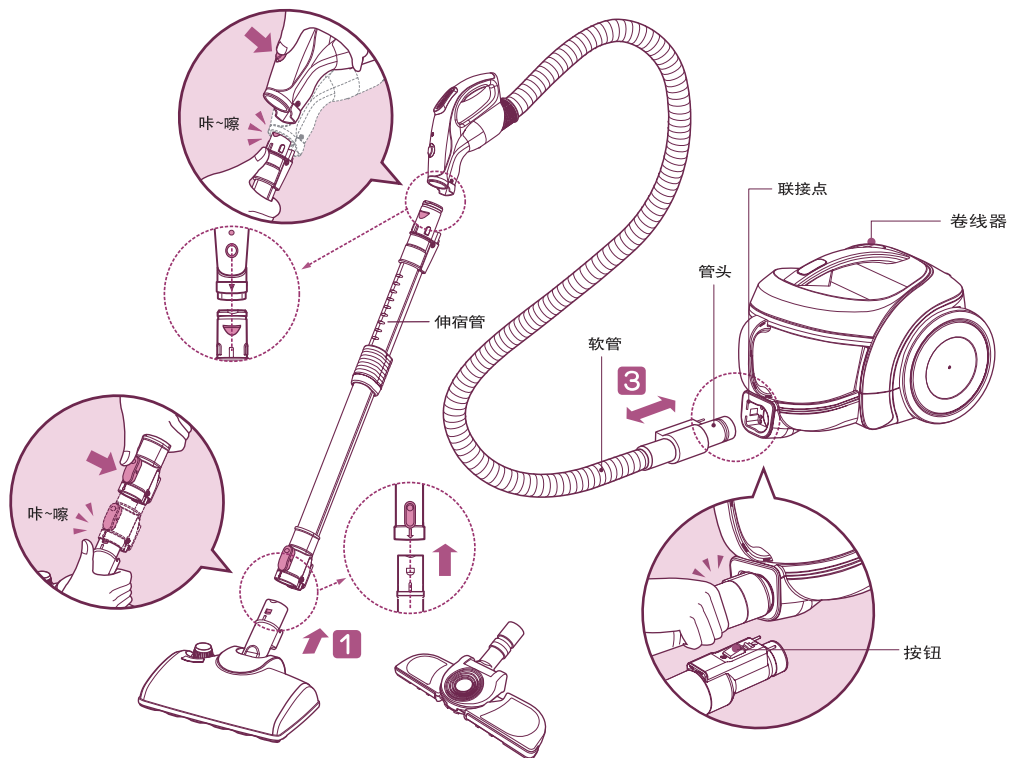

附件



角落刷头，尖细嘴的使用方法

角落刷头的使用方法

- ▶ 将刷头连接到伸缩管上。
- ▶ 按下刷头分离按键，可以取下刷头。

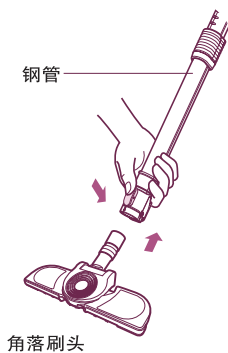

尖吸嘴

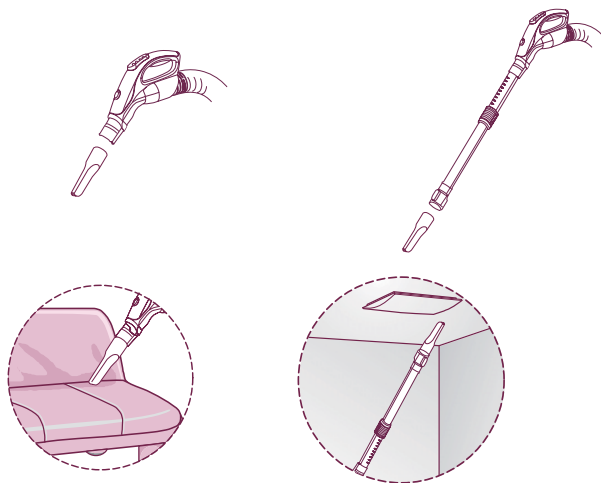

- ▶ 尖吸嘴可以用来清理房间角落等不易清理到的地方。

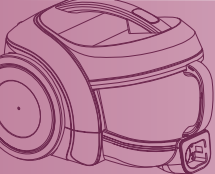

震动刷头使用方法与清洗方法

震动刷头使用方法

请按图示使用

组合

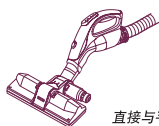

直接与手柄组合

使用



最大

手柄调节至“最大”档。根据织物种类不同，吸力大小要有所改变，应视情况不同来调节控制键。

最佳效果清扫方法

● 床、床褥、厚棉被

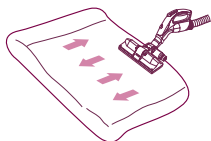

● 薄被、毛毯

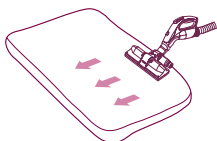

清扫薄被时，下面垫一个厚被，效果更理想！

- 若震动拍不运作，可轻轻向地面敲打刷头后再使用。
- 如还不震动，检查一下振动拍是否被棉絮卡住或需要调大吸力。
- 吸地毯时，根据地毯种类的不同，也会有发生不震动的可能性，所以最好专用于清扫床上用品。
- 集尘筒集满灰尘或吸力减小，震动幅度相应减小时，应注意及时清理滤芯。

震动刷头清洗方法

▶ 用水清洗吸入口，有可能导致振动器故障。



1 清洁过程中集尘瓶内灰尘较多时，按2~3次按钮。（可彻底去除灰尘）



2 清洁结束后集尘瓶内灰尘较多时，握住集尘瓶向逆时针方向转动拆卸。



3 倒掉集尘瓶内的灰尘。



4 握住集尘瓶，对准凸起部，按顺时针方向转动安装。

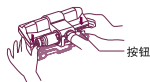

5 按下吸入口背面的按钮，卸下底板。



6 用抹布擦拭吸入口的污染面。



7 用水冲洗卸下的底板后，置于阴凉处晾干。



8 整齐地放置底板的振动板。

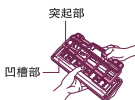

9 将突起部插入凹槽部内。



10 向下按，确保底板安装正确。

集尘桶的拆卸/清理方法

- 注意：**
- 集尘量达到集尘桶上标记的MAX线时，清理集尘桶。
 - 集尘量超过MAX时，吸入力可能降低。

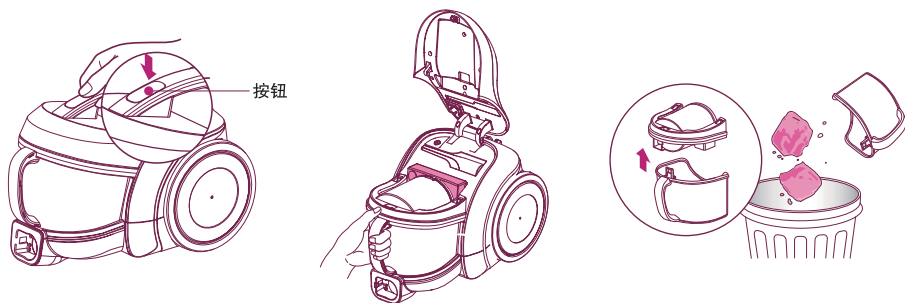

- 1 按住主机盖按钮，打开主机盖。
- 2 握住集尘桶手柄，取下集尘桶。
- 3 打开集尘桶的盖子，倒掉灰尘。

灰尘分离器的清理方法

- 注意：**
- 清洁集尘桶时，检查灰尘分离器内部。
 - 灰尘分离器内部有很多废纸、塑料等异物时，可能降低吸入力，请及时清理灰尘分离器。



- 1 检查灰尘分离器内部是否有灰尘。
- 2 握住灰尘分离器盖的手柄拆卸盖子。



- 3 倒掉灰尘。
- 4 堵住灰尘分离器盖的小孔，抖掉灰尘。

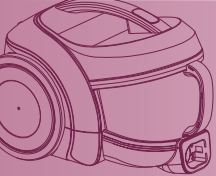

集尘桶、灰尘分离器的清洗/安装方法

清洗方法

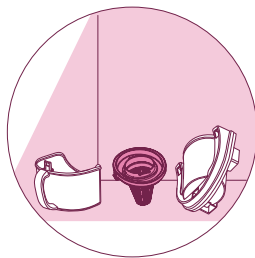

- 冲洗干净集尘桶、灰尘分离器、灰尘分离器盖。
- 在阴凉、通风处干燥一天左右，待完全干燥再使用。

安装方法

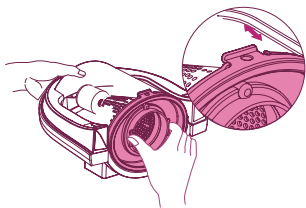

- 1 对准灰尘分离器盖的突起部和灰尘分离器槽后安装盖子。

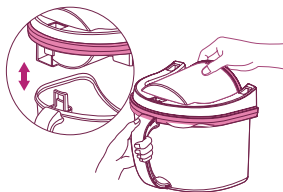

- 2 安装灰尘分离器和集尘桶。

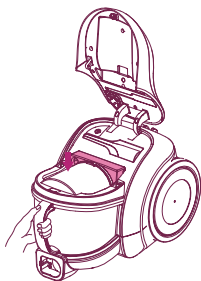

- 3 将集尘桶安装在吸尘器上。

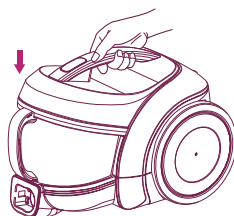

- 4 握住主机移动手柄，盖上吸尘器的盖子。

注意：● 吸尘器盖子没有完全盖好的情况下握住手柄移动吸尘器时，盖子有可能被打开，而导致产品的损坏及集尘桶掉落，所以请务必确认盖子是否盖好，在听到咔的一声响后，证明已经盖好。

● 在没有安装灰尘分离器盖的情况下使用吸尘器时，有可能出现噪音变大、吸入力急剧降低的现象，所以请务必再次确认是否安装好。

电机保护过滤器的拆卸/洗涤/安装方法

拆卸方法

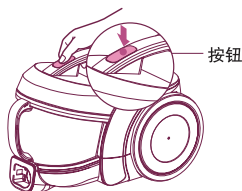

1 按住主机盖按钮，打开主机盖。

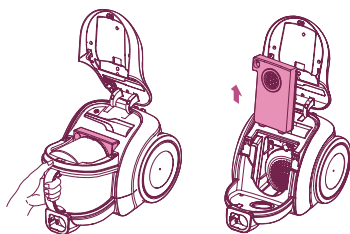

2 拆卸集尘桶后，从主机取出电机保护过滤器。

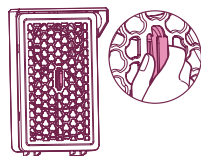

3 握住过滤器外壳手柄，从过滤器盖分离。

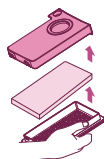

4 取出电机保护过滤器。

清洗方法



1 冲洗干净



2 彻底去除水分

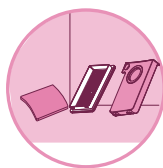

3 在阴凉、通风处干燥一天左右，待完全干燥后再使用。

注意：• 安装方法与拆卸方法相反。

• 在没有安装电机保护过滤器的情况下使用吸尘器时，可能出现噪音变大、灰尘进入电机，导致产品寿命缩短等现象，所以请再次确认安装情况。

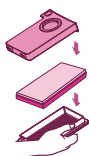

1 将电机保护过滤器装入过滤器外壳内。



2 盖上过滤器盖。

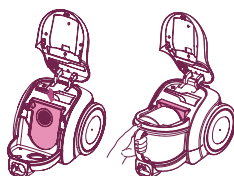

3 将组装好的过滤器插入过滤器安装部位后安装集尘桶。

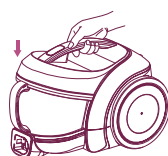

4 握住主机的移动手柄，盖上吸尘器盖。

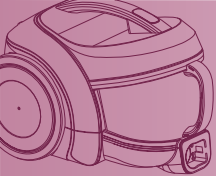

排气过滤器的拆卸/清洁/安装方法

拆卸方法

- ▶ 排气过滤器至少半年清洗一次或根据使用频率酌情清理。

排气过滤器盖按钮

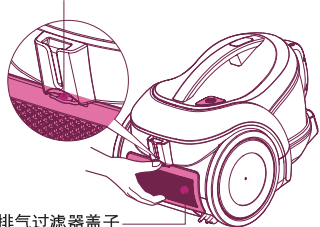

排气过滤器盖子

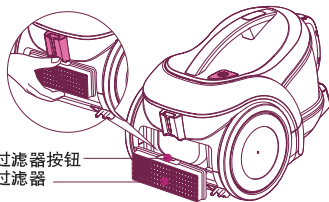

排气过滤器按钮
排气过滤器

清洁方法



- 1 抖动排气过滤器进行清洁。

安装方法

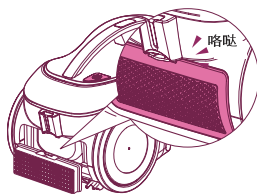

- 2 放入排气过滤器，按钮处有“咯哒”声时，表示排气过滤器盖安装准确。

蒸汽吸尘器的基本使用方法

使用蒸汽吸尘器可以同时进行真空吸尘和蒸汽吸尘。

组装及电源开、关

蒸气吸尘时，必须握住蒸气安全按钮使用。

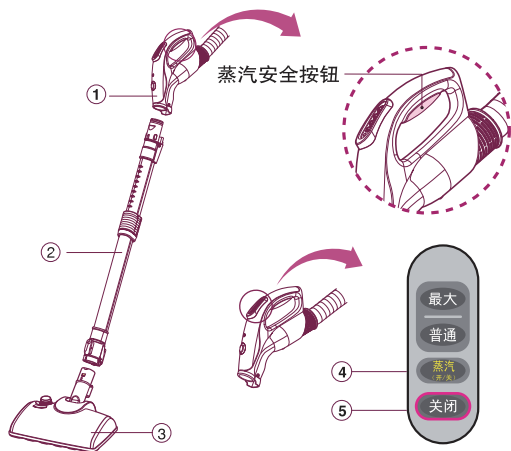

- 1 伸缩管2和蒸汽刷头3的端子部位对准之后，完全组装至有咔嚓的声音为止。蒸汽刷头和伸缩管不完全结合时，会有刷头脱落或不发出蒸汽等现象产生。
- 2 软管1和伸缩管2完全组装至有咔嚓的声音为止。
- 3 再次按下蒸汽按钮4或按停止按钮5，则刷头停止产生蒸汽。



注意：蒸汽吸尘时为了避免发生安全事故，若30秒未按蒸汽安全按钮，则视为吸尘工作结束，吸尘器自动切断电源。若要继续使用，需再次按下蒸汽按钮4。蒸汽刷头最初动作时，若未按住蒸汽安全按钮，则持续动作180秒后自动切断电源。

*按下蒸汽按钮4，2分30秒后可以开始使用，到3分钟之后，可以用眼看到蒸汽。

补充水的方法

- ▶ 补充水时，先拔掉插头，将软管手柄放在地面上，然后再打开蒸汽刷头的注水口。



- ▶ 用量杯盛250ml水，注入蒸汽刷头，盖紧注水口（详细事项参考第17页）。根据蒸汽刷头使用方法、使用时间不同，濡湿抹布的时间可能不同。

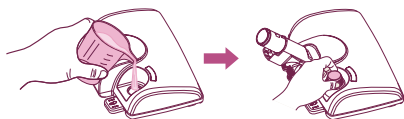

粘贴抹布的方法

- ▶ 粘贴抹布时，必须先切断蒸汽电源。先将抹布粘贴在抹布板上，再将抹布板安装在蒸汽刷头上。抹布板可能是热的，要注意烫伤。

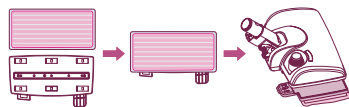

- ▶ 将吸嘴和抹布板对准之后，从上面压下刷头，听到咔嚓声之后结合完毕。只有将抹布粘贴在抹布板上，抹布板才能与蒸汽刷头吸嘴结合。

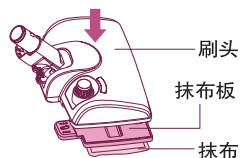

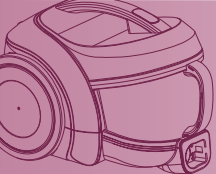

真空清扫/蒸气清扫/真空蒸气 同时清扫

真空清扫

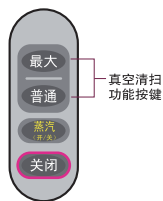
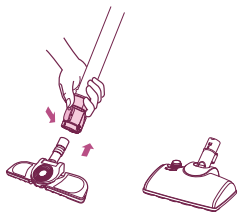

- ▶ 将角落刷头或蒸汽刷头连接在伸缩管上。

- ▶ 使用功能调节中的“最大”或“普通”模式进行清扫，清扫结束后按“关闭”键停止动作。

蒸气清扫

* 蒸气清扫时刷头倾斜，出来一部分水不属于故障。

* 蒸气清扫时不要把刷头翻过来，可能出水和高温蒸汽导致危险。

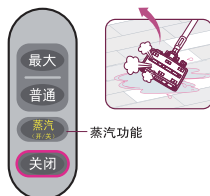
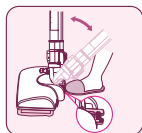
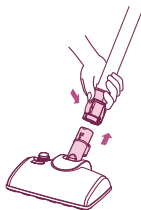

- ▶ 将角落刷头或蒸汽刷头连接在伸缩管上。
- ▶ 延长管按照箭头的方向向上拔，有咔嚓声之后，延长管固定住。按住蒸汽吸嘴按键之后，延长管可自由使用。

- ▶ 按功能调节中的“蒸汽”键，发生蒸气以后进行清扫，清扫结束后按“关闭”键或再按一次“蒸汽”键停止动作。

真空蒸气清扫

* 真空蒸气清扫只有在蒸汽刷头上可以使用。

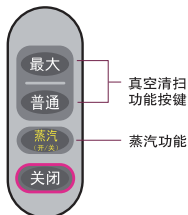
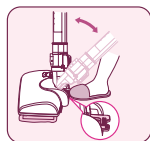
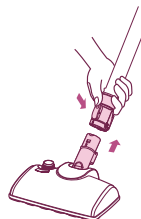

- ▶ 蒸气刷头连接在伸缩管上。
- ▶ 延长管按照箭头的方向向上拔，有咔嚓声之后，延长管固定住。按住蒸气吸嘴按键之后，延长管可自由使用。

- ▶ 若要真空清扫和蒸气清扫同时进行，分别按真空清扫用按键和蒸气清扫用按键，则2种清扫可同时进行。按关闭键动作停止。

地板 / 一般地面清扫

- ▶ 先将抹布粘贴在抹布板上，再连接到蒸汽刷头上。清扫地板、地面时，若不使用抹布，蒸汽刷头的高温会导致地面发生材质变色、变形等损坏。因此，必须粘贴好抹布方可使用。

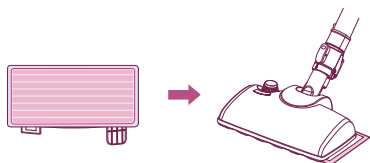

- ▶ 开启蒸汽刷头，产生蒸汽之后，可以开始清扫工作。



清扫地毯时

- ▶ 清扫地毯、沙发时，必须将抹布板从蒸汽刷头上取下来。若带着抹布使用，地毯、沙发表面可能受损，而且会影响抹布在抹布板上的粘贴。

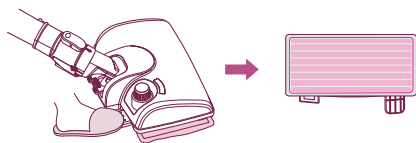

- ▶ 开启蒸汽刷头，产生蒸汽之后，可以开始清扫工作。

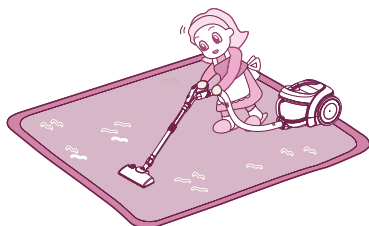

去除久渍/地面的污渍时

- ▶ 先将抹布粘贴在抹布板上，再连接到蒸汽刷头上。

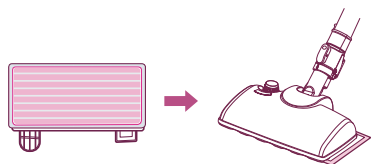

- ▶ 一次性清扫不净时，可以反复几次。但是，长时间在同一位置使用蒸汽刷头，可能会损伤地面。

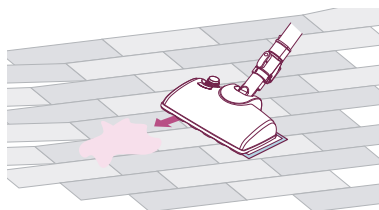

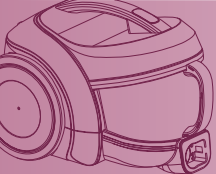

补充水的方法

注意：为了防止有异物进入水槽，注水时应使用净水。补充水之前，必须先切断电源，拔出电源插头，将软管手柄放置在地面上，然后再将水注入。

▶ 刷头上的“补充水”指示灯亮时，应停止蒸汽刷头的清扫工作，拔出电源插头。

▶ 打开刷头的注水口，用量杯补充适量的水（250ml）。

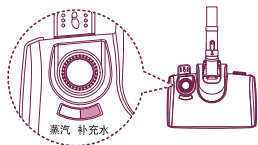

▶ 刷头的注水口如图盖紧盖子。向右旋转到有咔嚓咔嚓声音为止。

▶ 补充水之后，重新打开电源，刷头上“补充水”指示灯亮，等待30秒~1分钟之后，“补充水”指示灯灭，“蒸汽”指示灯亮，此时可以继续清扫工作。

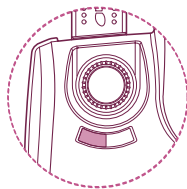
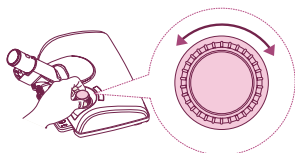

更换、洗涤抹布的方法

注意：更换抹布必须在切断电源之后进行。

▶ 将抹布板从蒸汽刷头上取下，更换抹布时，将抹布白色的一面粘贴在抹布板上。

▶ 使用过后的抹布用肥皂或洗涤剂洗净，在荫凉处完全干燥之后方可再次使用。

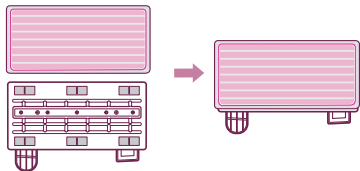

注意

- 使用未完全干燥的抹布，会有触电的危险，机体也可能受损。
- 在正确的位置粘贴抹布，注意避免堵住蒸汽刷头的吸入口。
- 根据蒸汽刷头的使用时间或使用时间不同，濡湿抹布的时间会有所不同。这时，更换干净的抹布会使清扫工作更容易。

使用完后保管方法

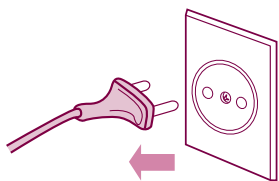

- ▶ 关闭开关，拔掉电源插头。



- ▶ 使用过的抹布，及时清洗、晾干。否则，长时间放置，会有异味产生。

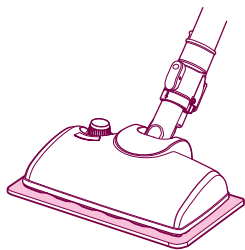

- ▶ 蒸汽刷头必须放置在指定的垫板上保管。不要将热的刷头直接放置在地面上，否则会损坏地面。

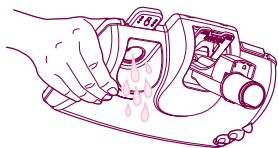

- ▶ 长时间不使用时，应将刷头里剩余的水分完全清空。注意，清空水分应该在刷头完全冷却之后进行。否则，会有烫伤的危险，产品也会受损。清空水分时，应先将刷头与伸缩管分离。

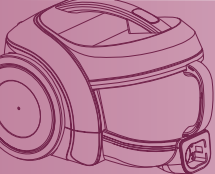

故障通告前确认事项

故障通告前请先确认

- ▶ 如果您怀疑产品发生故障，请先确认故障发生原因，再与售后服务中心或代理商联系，以确保检修的效率。

不出蒸汽？

1 阶段

确认插头是否通电？

如无异常，确认伸缩管，刷头结合是否正常。

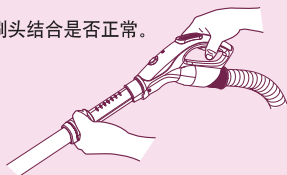

2 阶段

先确认刷头上的“补充水”指示灯是否亮起。

若是，则需要用量杯向蒸汽刷头内补充水。

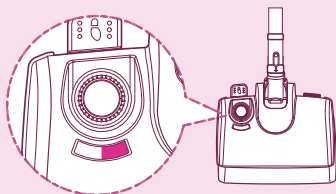

3 阶段

确认使用时是否握住了蒸汽安全按钮。进行蒸汽清扫时，需要握住蒸汽安全按钮。出于安全上的考虑，当不按蒸汽安全按钮时间达到30秒以上时，蒸汽刷头会自动切断电源。

*出于安全上的考虑，本产品设有蒸汽安全按钮，握住软管手柄时，可以很自然的按住蒸汽安全按钮。若没有握住蒸汽安全按钮，刷头会自动切断电源。若要重新启动刷头，需要再次按下蒸汽按钮，并在30秒内握住蒸汽安全按钮。

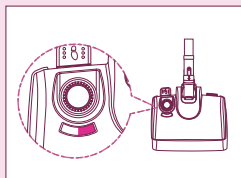

▶ 蒸汽刷头自动切断电源时



▶ 重新按下蒸汽按钮

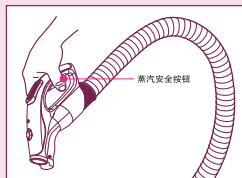

▶ 进行蒸汽清扫时，需要握住蒸汽安全按钮。

*出于安全上的考虑，当不按蒸汽安全按钮时间达到30秒以上时，蒸汽刷头会自动切断电源。

故障通告前需确认事项

故障通告前请先确认

- ▶ 如果您怀疑产品发生故障，请先确认故障发生原因，再与售后服务中心或代理商联系，以确保检修的效率。

现象:

吸力突然下降，并发出报警声！

噪音加大
软管收缩



吸力忽然下降

吸尘器求助:

请检查集尘筒和吸入口



处理要领

- 1 查看集尘筒灰尘是否集满，如果是，请及时清理集尘筒。



- 2 请确认集尘筒滤芯是否堵塞
过滤器堵塞时会发出异常声，请及时清洗。



- 3 检查吸入口时，需将吸力调节到最大。

第一步

将伸缩管与刷头分离后，检查有无阻塞，如发现问题请立即清理。

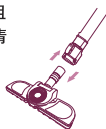

如果还有问题，请进行第二步。

第二步

分离手柄与伸缩管，检查有无阻塞，如有阻塞，请将伸缩管收短，清除异物。



如果还有问题，请进行第三步。

第三步

检查软管是否阻塞，将吸力调至最强，用手堵住管口，反复几次。



如果还有问题，请清理一下滤芯。



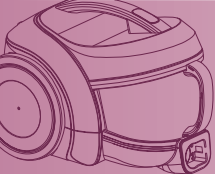









故障通告前需确认事项

故障通告前请先确认

- 如果您怀疑产品发生故障，请先确认故障发生原因，再与售后服务中心或代理商联系，以确保检修的效率。

| 故障 | 检查 | 措施 |
|---|--|---|
| 吸尘器为何不能工作?  | <ul style="list-style-type: none">● 电源插头是否插上?● 电源插座有电吗?● 软管是否插上?● 电机热保护处于开启期间。 | <ul style="list-style-type: none">● 请将电源插牢 (本产品适用于220V电压)。● 确认插座是否有电。● 将软管插牢。● 2小时后重新启动。 |
| 机体内有噪音。  | <ul style="list-style-type: none">● 吸尘器吸力过大或电机高速运转时所发出的声音，不属于异常情况，请正常使用。● 如果不是正常的电机响声，而是异常的噪音，请打电话与维修中心联系。 | |
| 机体发出报警声。  | <ul style="list-style-type: none">● 集尘筒已满。● 集尘筒滤芯堵塞。● 吸入口阻塞。● 伸缩管阻塞。● 软管阻塞。 | <ul style="list-style-type: none">● 清理集尘筒。● 用软毛刷轻轻刷滤芯，用水冲洗后放置于阴凉处风干一天。● 将吸入的异物取出再使用。● 将伸缩管内异物取出后再使用。● 将软管内异物取出后再使用。 |
| 机体出现异味。  | <ul style="list-style-type: none">● 电机运作时，用于固定电机的橡胶圈会受热而产生少量气味，不会影响运作或使机器发生损坏。● 机器不小心吸入一些水或集尘筒长期不清理时，会有一些异味排出，此时应及时清理集尘筒。 | |
| 震动刷头不运作或震幅过小。  | <ul style="list-style-type: none">● 震动刷头是用于清扫床上用品、沙发等织物时使用的。● 清扫地毯时，请使用大刷头。● 检查底盘是否正确地与刷头结合。● 清扫薄织物时，请在下面垫上厚被褥。● 请确认集尘筒和吸入口各部位是否有阻塞现象。● 吸力下降也可能使震幅减小。 | |
| 电源线不能全部卷入机体，电源线不能全部拉出。  | <ul style="list-style-type: none">● 将电源线拉出一部分后重新卷入。● 请用力将电源线拉出，不会损坏电源线。● 由于线在内部互相缠绕或夏季周围温度过高所致。● 由于线在内部折曲或未缠在卷线器上，启动卷线器后，能正常运作。 | |
| 机体或排出的气体过热。  | <ul style="list-style-type: none">● 吸力是否正常? | <ul style="list-style-type: none">● 从机体内排出的热气，是由电机导热产生的热量所致，属正常温度，请继续使用。 |
| 软管内壁过脏。  | <ul style="list-style-type: none">● 请勿将水吸入，水与灰尘混合吸入后，有可能弄脏管壁。 | |

装箱单

装箱单

| | |
|------------|----|
| 吸尘器 | 一台 |
| 说明书 | 一本 |
| 尖细嘴 | 一个 |
| 蒸汽刷头 | 一个 |
| 震动刷头 | 一个 |
| 软管 | 一根 |
| 伸缩管 | 一根 |
| 角落刷头 | 一个 |
| 量杯 | 一个 |
| 抹布 | 三块 |
| 垫板 | 一块 |
| 保修卡 | 一份 |

Table of contents

| | |
|---|-------|
| Product specifications | 23 |
| Attention before using the appliance | 24-27 |
| Assembling the Cleaner | 28 |
| Parts description and assembly | |
| Accessories | |
| Using the Accessories | 29 |
| Using and cleaning the Sani Punch | 30 |
| Using the Sani Punch | |
| Cleaning the Sani Punch | |
| How to separate or empty the dust box | 31 |
| How to empty the dust separator | |
| How to clean and assemble the dust box and separator | 32 |
| Cleaning | |
| Assembling | |
| How to separate, clean and assemble the protection filter of the motor | 33 |
| Disassembling | |
| Cleansing | |
| Cleaning exhaust filter | 34 |
| Basic use method of the steam vacuum cleaner | 35 |
| Assembling & power switch | |
| Water-filling method | |
| Duster-sticking method | |
| Vacuum cleaning/steam cleaning/steam vacuum cleaning | 36 |
| Floor/ordinary ground cleaning | 37 |
| Water filling method | 38 |
| Maintenance Methods | 39 |
| If you have a problem | 40-42 |
| Packing List | 43 |

Product specifications

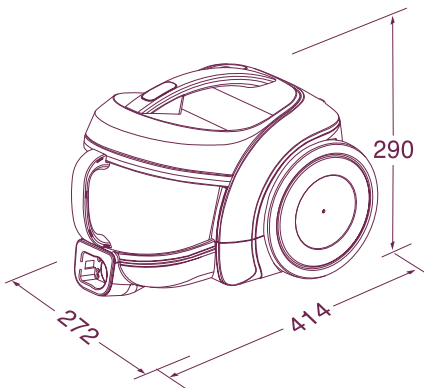

Model: V-CE621CAS

220V~ 50Hz

IEC: 2050W

MAX: 2250W

Suction Power: 320W

Net Weight: 5.3Kg

Dust Capacity: 1.5L

Dimension: 272mm x 414mm x 290mm

This appliance complies with the following GB Directives:

GB4706.1-2005

GB4706.7-2004

GB17625.1-2003

GB4343-2003

※ You will not be informed otherwise of any changes in appearance and standard deriving from improvement of product quality.

Attention before using the appliance

Attention before using the appliance

Please read all the following information, which contains important instructions for the safety, the use of the appliance.



DANGER

May immediately cause serious injury or death.



WARNING

May possibly cause serious injury or death.



ATTENTION

May possibly cause losses of property or light injury.



DANGER

Do not pick up anything that is burning or smoking, such as cigarettes, matches or hot ashes.



Please turn off the power before pulling out the plug to prevent fire or electric shock. Never handle plug or appliance with wet hands. (Do not use the appliance on the power above 220V.)

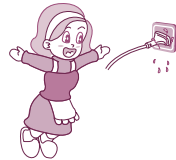

WARNING

Avoid picking up hard, sharp objects with the cleaner. They may damage the cleaner and the tank.

Do not vacuum the objects like hair ball or big paper ball, otherwise the hose is possibly blocked up. Please clear the hose in time when it is blocked.

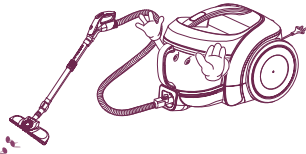

To avoid the danger of fire or electric shock, do not vacuum liquid, blade, flammable substances, or small particles like cement and gesso in cleaning.

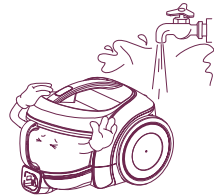

Independently use a socket when the current is $\geq 15A$. It may cause fire when many electric appliances share one socket. In order to avoid the needless danger, you had better not use the prolonged thread of power cord. The current at most 6A is allowed.

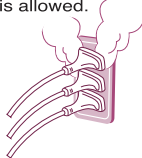

Unplug cleaner when not in use. Turn off all controls before unplugging.

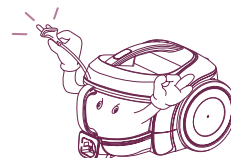

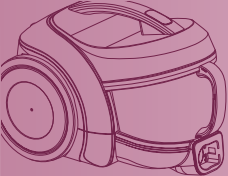

Attention before using the appliance



Caution

When used for cleaning the wood floor, painted floor or tile floor, please pay attention to following items:

1. some floors will change the color and deform due to the heat. 2. When the wet duster is used, the floor chink may be permeated by water, so that the floor may be damaged.

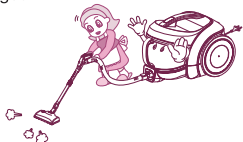

As the power is on, or the steam brush head is used, never open the water filling cover, or fill the water; otherwise, you will be scalded due to overflowing of the hot water.



Before use the hot water steam produced by this product, please inquire your floor manufacturer so as to confirm whether the floor material is applicable to such hot water steam. Never touch the bottom of steam brush head with your hands or feet, or you will be scalded.



Never use water or other detergent to clean the surface and bottom of the steam brush head; otherwise, it may be damaged or electric leakage may occur.



As cleaning the floor, the steam brush head must be attached with duster, or the floor material may change the color or deform due to hot steam, while the duster shall be removed as cleaning the carpet.



Never leave the steam brush head at the same position for a long period of time or use the brush head repeatedly at the same place because the floor may change the color or deform due to the heat arising from high temperature and steam.



As the power is on, or the steam brush head is used or has been just used, never reverse or tilt the brush head; otherwise, you will be scalded due to the injection of hot water steam.



The brush head shall be filled with water rather than the other synthesized detergent, chemical substance or liquid; otherwise, the product will be damaged or explosion may occur.



When heat rejection or having a break, the steam brush head shall be placed on the tray as specified rather than on the floor, or it may damage the floor.

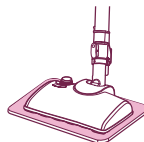

The product shall not be used by the children, the aged and the persons who are unfamiliar with it, so as to avoid scalding.



Attention before using the appliance



Caution

When the steam brush head is used or under heating, never touch the surface of the steam brush head, so as to avoid the scalding.

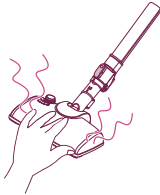

Never use the steam hose and drawtube to suck the water or they shall not be cleaned with water because electrical connecting parts are installed inside such hose and drawtube. Please check the hose and drawtube on a regular basis. They shall not be used in case of damaged. In this case, please contact the after-sales service department.

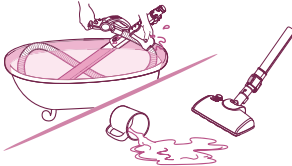

Never let the steam face to the person, animal and the devices where the electrical parts are installed, so as to avoid scalding.

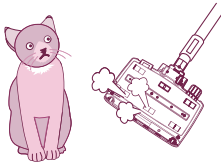

For the attachment or change of the duster, the vacuum cleaner must be closed. If the duster is changed when the vacuum cleaner is under operation, the floor will be damaged and scalding may occur.

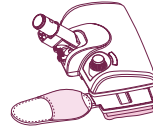

When the power is on or the vacuum cleaner is under use, the "electric leakage breaker" will call into play, the vacuum cleaner shall be closed immediately and please contact the after-sales service center.

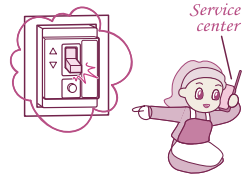

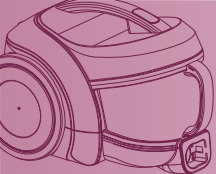

Attention before using the appliance



WARNING

Do not let the power cord near the electric heater or other heat source, lest that the cleaner should be deformed or it should cause fire. Do not use the appliance when the power cord or plug is damaged. The damaged power cord or plug must be replaced in the approved service station.



Close supervision is necessary when any appliance is used by or near children. Do not allow vacuum cleaner to be used as a toy or to run unattended at any time.



Do not operate the appliance for long when the nozzle inlet or nozzle outlet is blocked, which may have it deformed or damaged.



In using the appliance, pay attention to the electrostatic effect generated on the telescopic tube and cleaner body.



ATTENTION

Do not allow the non-professional maintenance people to repair.

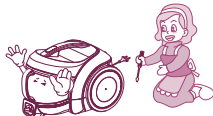

Do not pull or carry by cord, use cord as a handle, close door on cord or pull cord around sharp edges or corners. Do not run appliance over cord. Keep cord away from heated surfaces.

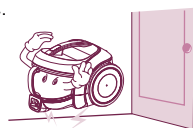

Keep hair, loose clothing, fingers, feet and all parts of body away from the nozzle or movable portion.



The duster must be removed before cleaning the carpet.



Do not bend, stamp on, or drag the hose. Do not continue to use the hose if it is damaged. Do not use any heavy or sharp object to press the power cord.



Do not use without dust tank or filters in place. Change tank frequently when picking up very fine materials such as powder.



In winding the power cord, hold the plug before pressing the button of the cord reel. Do not pull the power cord beyond the red warning line, otherwise the power cord may be damaged or unable to be wound up. Pay attention to the plug in winding the cord to avoid damaging the surrounding objects.

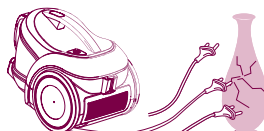

Assembling the Cleaner

Parts description and assembly

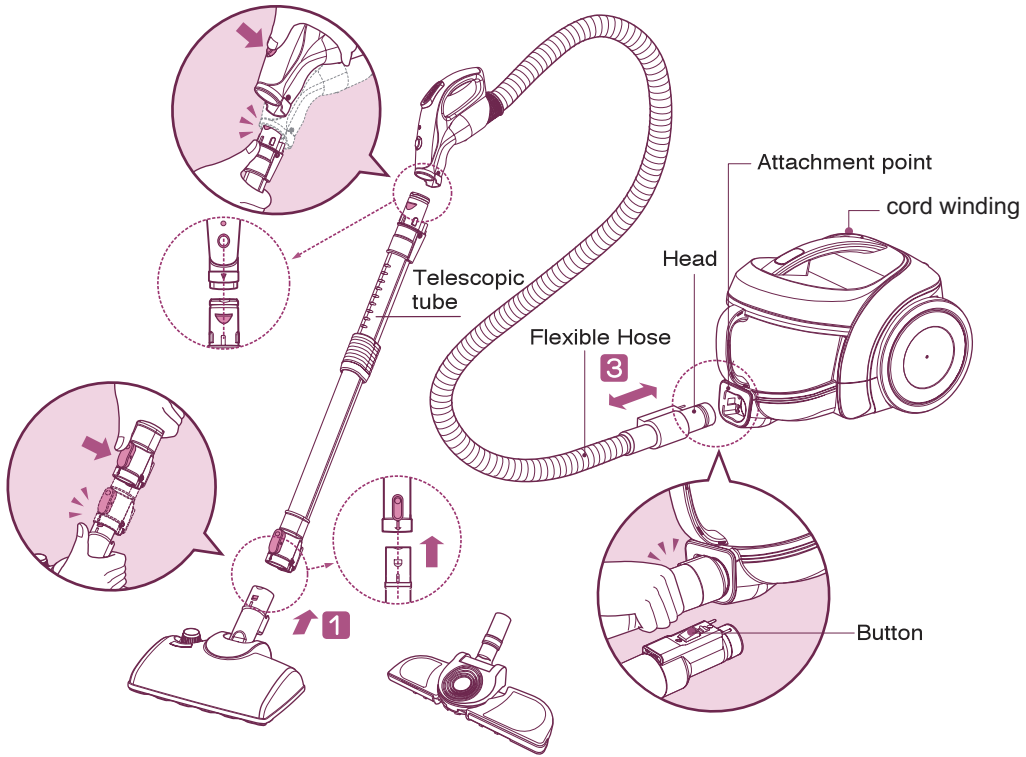

Accessories

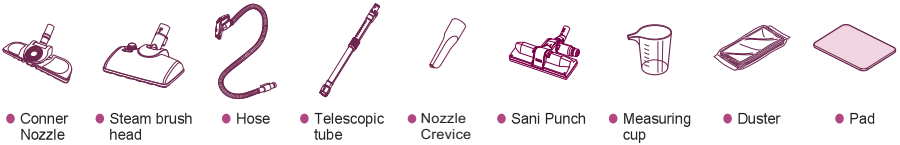

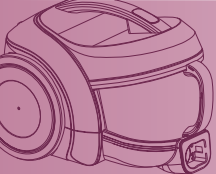

Using the Accessories

Using Corner Nozzle

- ▶ Connect the Corner Nozzle to Telescopic Pipe.
- ▶ Press the Nozzle Separate Button to Separate the nozzle.

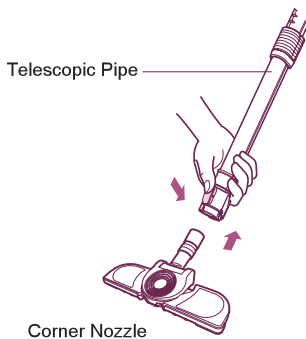

Nozzle, Crevice

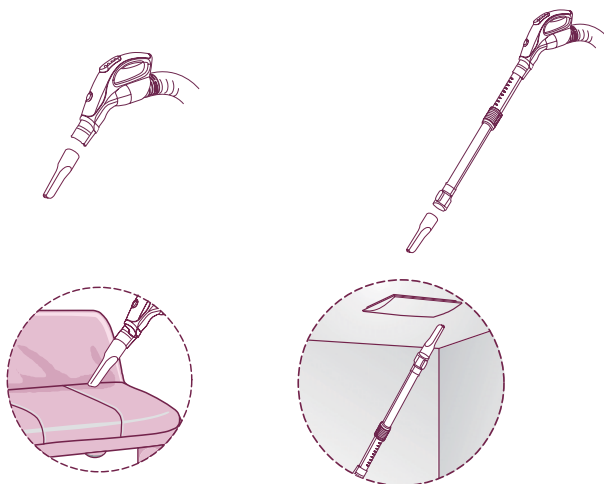

- ▶ Nozzle, Crevice can be used for cleaning the place hard to reach.

Using and cleaning the Sani Punch

Using the Sani Punch

Use it as shown in the diagram

Assembling



Using



最大

Set the suction power control switch to “最大” before vacuuming. Depending on the type of bedding, handing may be awkward or it may cause a lot of noise.

If this is the case, adjust the suction power control switch to a lower setting.

Effective cleaning

• bed, bedding, heavy blanket

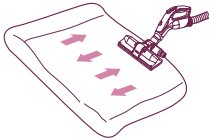

• Light blanket & sheet

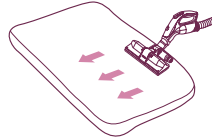

To increase cleaning efficiency for light blankets, lay on top of a bulky blanket and then clean.

- If the punch bar does not move, lift the nozzle slightly off the surface.
- If it does not move, even after doing this, check if the suction power is too low or if the nozzle base is clogged with a foreign object.
- This Sani Punch nozzle is for effective cleaning of beds and blankets to remove mites and dust.

Cleaning the Sani Punch

► The vibrator may break down due to the cleansing of the inhaler with water.

- 1 If the dust settles in the box while cleaning, press the button 2 or 3 times. (It will remove most of the dust.)
- 2 After the cleaning, if there are lots of dusts in the box, separate the box from the inhaler by turning it anticlockwise.
- 3 Empty the box.
- 4 Aim at the Spiral, Fix the box into the inhaler by turning it clockwise.
- 5 Separate the bottom plate by pressing the buttons in the back.
- 6 Clean the dirty body of the inhaler carefully with a cloth.
- 7 Wash the separated bottom plate and dry it in the shade.
- 8 Arrange the vibrator in order.
- 9 Insert the joining spiral into the groove.
- 10 Attach the bottom plate properly by pressing down.

How to separate or empty the dust box

- Warning:**
- Empty the box when the dust settles up to the MAX line.
 - Too much dust beyond this line may reduce the inhaling power.

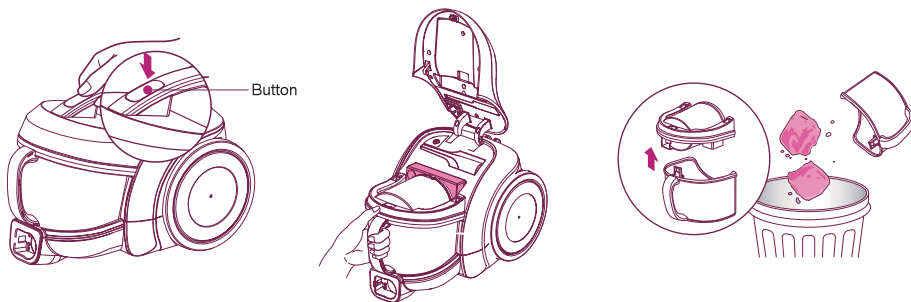

- 1 Uncover by pressing the button.
- 2 Detach the dust box by holding its handle.
- 3 Empty the dust box.

How to empty the dust separator

- Warning:**
- Check the inside of the dust separator when cleaning the dust box.
 - Clean the inside of the dust separator, because too much foreign substance such as waste paper or plastic in the dust separator may reduce the inhaling power.



- 1 Check if the dust has settled in the dust separator.
- 2 Separate the cover by holding its handle.



- 3 Empty the separator.
- 4 Remove the dust from the small holes in the cover of the separator.

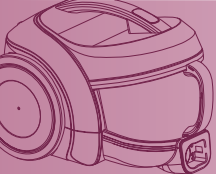

How to clean and assemble the dust box and separator

Cleaning



- Cleanse the dust box, separator and its cover with running water.

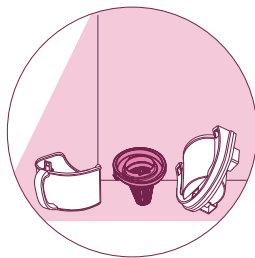

- Dry them in the well-ventilated shade for a day before using.

Assembling

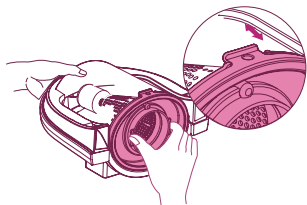

- 1 Attach the cover by inserting the spiral in the cover into the groove.

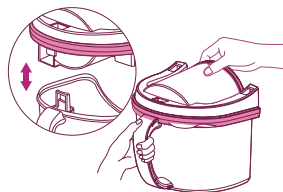

- 2 Assemble the dust separator and box.

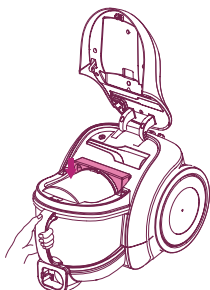

- 3 Attach the assembled dust box to the body of the cleaner.

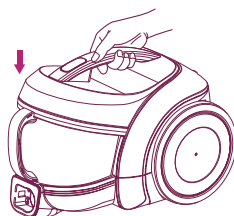

- 2 Cover the cleaner by holding the carrying handle of the body.

Warning:

- If you move the cleaner by holding the carrying handle with the cover not fully closed, the cover may open, causing damage to the parts and the dust box. So check if the cover has been properly closed.
- If you use the cleaner without assembling the cover of the dust separator, it will increase the noise and reduce the inhaling power when cleaning. So check the assembling once again.

How to separate, clean and assemble the protection filter of the motor

Disassembling

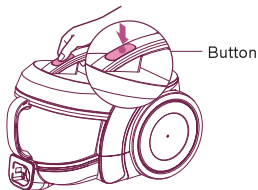

1 Uncover by pressing the button.

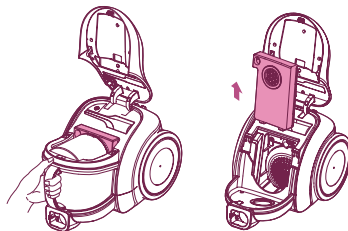

2 Detach the protection filter of the motor from the body after disassembling the dust box.

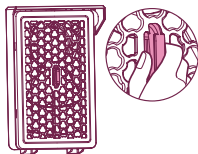

3 Separate it from the filter cover by holding the handle of the case.

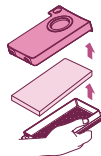

4 Detach the filter.

Cleaning



1 Clean with running water.



2 Remove the water completely.

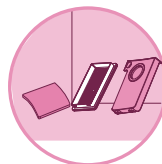

3 Dry in the well-ventilated shade for a day before using.

Warning: • Assembling is done in reverse order of disassembling.

• If you use the cleaner without assembling the protection filter of the motor, noise increases and dust gets into the motor when cleaning, thus leading to the shorter life of the cleaner. So check the assembling once again.

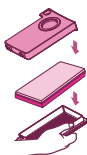

1 Put the filter into the case.



2 Cover the filter.

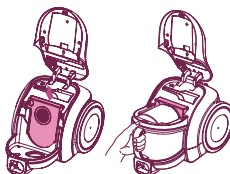

3 Mount the assembled filter and assemble the dust box.

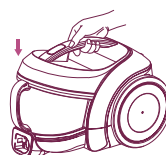

4 Cover the cleaner by holding the carrying handle of the body.

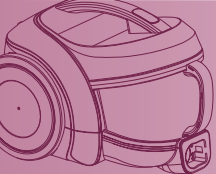

How to separate, clean and assemble exhaust filter

Disassembling

- ▶ The exhaust filter should be cleaned at least once half a year.
Allow exhaust filter to dry in a shaded location for a dry.

Cover button of the exhaust filter

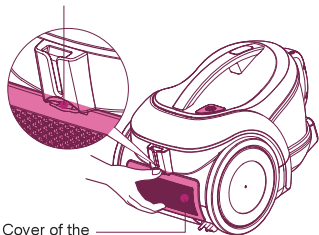

Cover of the exhaust filter

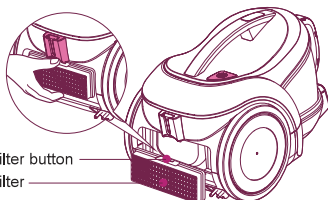

Exhaust filter button
Exhaust filter

Cleansing

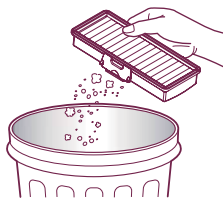

- 1 Shake off the exhaust filter.

Assembling

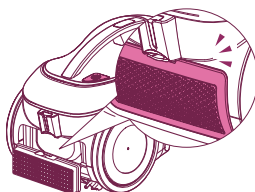

- 2 Insert the exhaust filter and join the cover properly until you hear the click of the button.

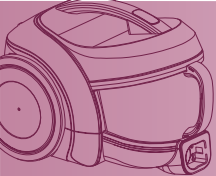

Basic use method of the steam vacuum cleaner

The steam vacuum cleaner could realize vacuum cleaning and steam cleaning in the meantime.

Assembling & power switch

Steam safety button shall be held when using steam vacuum cleaning.



- 1 The terminals of both the drawtube 2 and the steam brush head 3 shall be aimed and completely assembled until the clicking sound; otherwise it may incur the brush head coming off or discontinuity of steam.
- 2 The hose 1 and the drawtube 2 shall be completely assembled until the clicking sound.
- 3 Re-press the steam button 4 or press the stop button 5 to stop supplying steam from the brush head.



Note: To prevent any safety accidents when using the steam vacuum cleaner, the cleaner shall automatically power off if you don't press the steam safety button in 30 seconds; Re-press the steam button 4 to continue. In case the steam safety button isn't pressed when the steam brush head is set in motion, the cleaner shall automatically power off in 180 seconds.

* The cleaner could be put into use in 2.5 minutes after pressing the steam button 4 and you could see steam in 3 minutes.

Water-filling method

- ▶ When filling water, the cleaner shall be unplugged with the hose handle on the floor. After that, you could open the water inlet on the steam brush head.



- ▶ Fill 250ml water into the steam brush head with the measuring cup and then fasten the cover (Please refer to Page 38 for the detailed instruction). The time to moisten the duster may differ as for different usage or duration of the steam brush head



Duster-sticking method

- ▶ The cleaner shall be powered off when sticking the duster. Stick the duster on the duster board, and then fix on the steam brush head. Caution of burn when the duster board may still be hot.

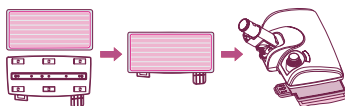

- ▶ Aim the suction nozzle at the duster board, and then press down the brush head until the clicking sound. As long as the duster is properly stuck on the duster board, the board could be connected with the suction nozzle of the steam brush head.

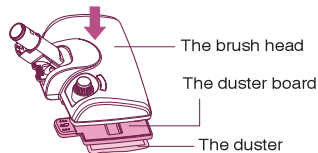

Vacuum cleaning / steam cleaning / steam vacuum cleaning

Vacuum cleaning

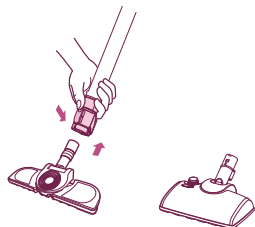

- ▶ Connect the steam brush head with the drawtube.



The function buttons for vacuum cleaning

- ▶ Press the “最大” or “普通” button , then the vacuum cleaner will begin to work.

Steam cleaning

* It is not fault if there was some water come out when steam nozzle tilted while steam cleaning.

* It is dangerous if you overturn the steam nozzle. There will be some high temperature water and steam.

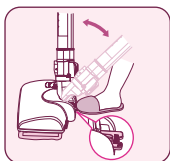
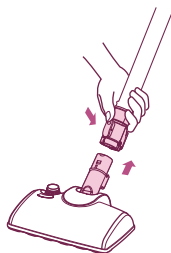

The steam button

- ▶ Connect the steam brush head with the drawtube.
- ▶ Press the “最大” or “普通” button , then the vacuum cleaner will begin to work.

- ▶ Press the vacuum cleaning button and steam cleaning button respectively to activate steam vacuum cleaning in the meantime; press the stop button to stop such function.

Steam vacuum cleaning

* Only steam nozzle connected, the steam vacuum cleaning is allowed.

- ▶ Connect the steam brush head with the drawtube.
- ▶ Pull up the extended tube as per the arrow tip until the clicking sound. Press the steam suction nozzle button, thus the extended tube could be used as required;

- ▶ Press the vacuum cleaning button and steam cleaning button respectively to activate steam vacuum cleaning in the meantime; press the stop button to stop such function.

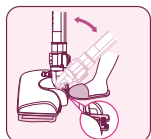
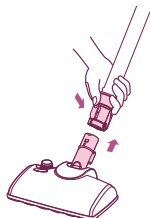

The function buttons for vacuum cleaning

The steam button

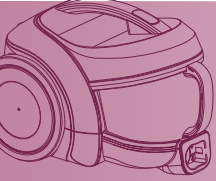

Floor / ordinary ground cleaning

- ▶ Stick the duster on the duster board, and then connect with the steam brush head. Missing of duster may cause discoloration or distortion of the floors due to high temperature of the steam brush head. So, the duster shall be properly stuck before use.

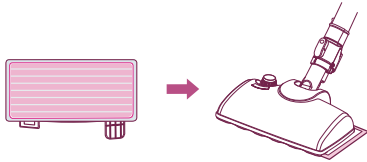

- ▶ Switch on the steam brush head and start cleaning after steaming.



Carpet cleaning

- ▶ The duster board shall be taken off from the steam brush head when cleaning the carpets or sofa; if not, the surfaces of carpets or sofa may be damaged or the duster may not be properly stuck on the board.

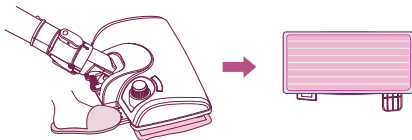

- ▶ Switch on the steam brush head and start cleaning after steaming.

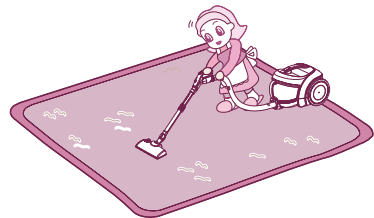

Stains removing / floor stains cleaning

- ▶ Stick the duster on the duster board, and then connect with the steam brush head;

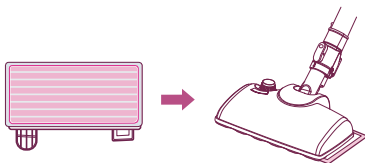

- ▶ Repeat cleaning if it is impossible to clean up the stains once, but the use of steam brush head on the same position for a long period may damage the floors.

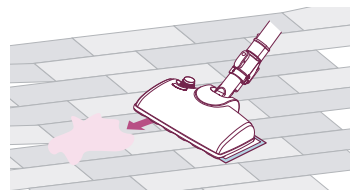

Water filling method



Note: Purified water shall be used for fear of any dirt flowing into the cistern of the vacuum cleaner. Before filling water, the cleaner shall be powered off and unplugged from the socket; also, hose handle shall be put on the floor.

- ▶ When the indicator of “Water filling” on the brush head flashes, you shall stop cleaning with the steam brush head and unplug from the socket.
- ▶ Open the water inlet on the brush head and fill proper water with the measuring cup (250ml).

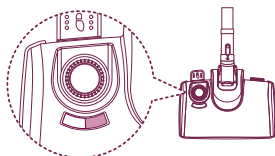

- ▶ Fasten the water inlet cover on the brush head as per the figure, revolving toward right until the clicking sound.
- ▶ When you power on the cleaner after filling water, the indicator of “Water filling” lights up for 30 seconds to 1 minute. You could continue cleaning after the indicator of “steam” lights up.

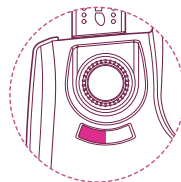
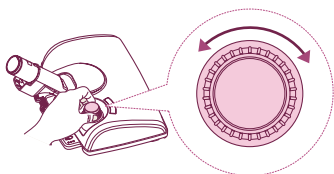

Method for replacing or washing the duster



Note: The duster shall be replaced after power off.

- ▶ Take off the duster board from the steam brush head. When replacing the duster, you shall stick the duster with the white side on the board.
- ▶ Take off the duster board from the steam brush head. When replacing the duster, you shall stick the duster with the white side on the board.

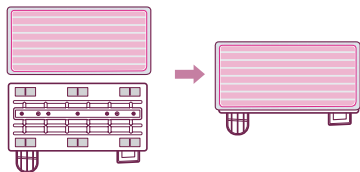

Note:

- Use of duster without completely drying may incur electric shock or damage the cleaner.
- Stick the duster properly, for fear of blocking the suction hole of the steam brush head.
- The time to moisten the duster may differ as for different usage or duration of the steam brush head; replacing a clean duster may make the cleaning easier.

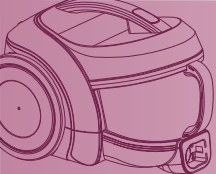

Maintenance Methods

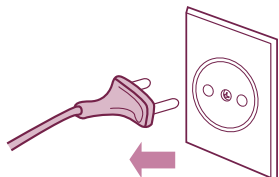

- ▶ Turn off the switch and unplug from the socket.



- ▶ Clean and dry the used duster immediately; otherwise it may lead to peculiar smell if placing for some time.

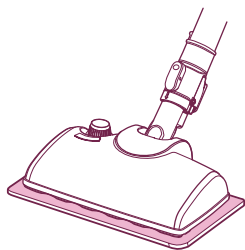

- ▶ The steam brush head shall be maintained on the specific pad rather than directly on the floor when it is still hot; otherwise it may damage the floor.

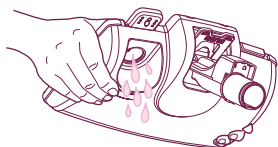

- ▶ The remaining water in the brush head shall be completely dried, if the cleaner stays idle for a long period. Note: such maintenance shall be done after the brush head is completely cooled up; otherwise it may incur burns or damage the cleaner. Also, the drawtube shall be separated from the brush head first.

If you have a problem

Please check before notifying malfunction

- ▶ If you doubt the product meets with malfunction, please check the cause of such malfunction before contacting with the after-sales service center or agent, so as to ensure efficiency of repair.

Stop steaming?

Phase I

Check whether the indicator of “Water-filling” flashes; if so, it is necessary to fill water into the steam brush head with the measuring cup.

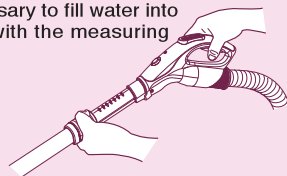

Phase 2

Check whether the indicator of “Water filling” flashes. If so, please fill water into the steam brush head with the measuring cup.

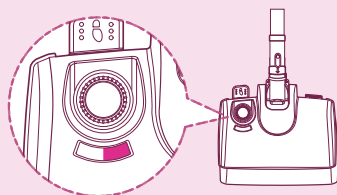

Phase 3

Check whether the steam safety button is held when using steam cleaning. On the account of safety, the steam brush head shall automatically power off when the steam safety button is not held for more than 30 seconds.

* On the account of safety, this product is designed with a steam safety button. When holding the hose handle, it is easy to hold the steam safety button; if not, the steam brush head shall automatically power off. Re-press the steam button and hold the steam safety button in 30 seconds to restart the steam brush head.

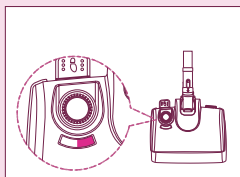

- ▶ When the steam brush head automatically powers off,

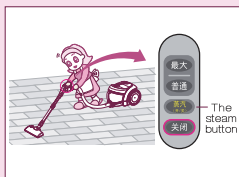

- ▶ Re-press the steam button;

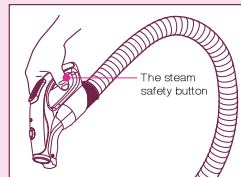

- ▶ When using steam-cleaning, the steam safety button shall be held.

* On the account of safety, the steam brush head shall automatically power off when the steam safety button is not held for more than 30 seconds.

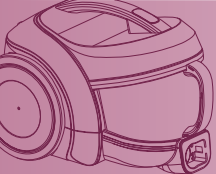

If you have a problem

If you have a problem

- ▶ If a minor problem occurs, it usually can be solved quite easily when the cause is found by using the check list below.

Problem:
Suction is weakened and alarm.

The noise increases and the hose shrink.

Suction power is abruptly weakened.



Help:

Check the dust tank and suction inlet.



Solution

- 1 Dust tank full.
Empty dust tank.



Is it full? Empty the dust tank in time!

- 2 Motor filter dirty.
Clean the motor filter with brush and water, allow to dry and replace in cleaner.



Is the filter OK? Then check the suction inlet.

- 3 When checking the suction inlet, adjust the suction level to the maximum.

First step

Turn cleaner off and disconnect from electrical outlet, then disconnect nozzle from telescopic tube. Check if it is blocked, and remove any blockages.

If there is still a problem, proceed the second step.

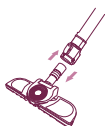

Second step

Disconnect the telescopic tube from hose. Check if it is blocked, and remove any blockages.

If there is still a problem, proceed the third step.



Third step

Plug cleaner in, turn on, and check hose end for suction. Remove any obstructions.









If there is also a problem, clean the filter.



If you have a problem

Please check before notifying malfunction

- If you doubt the product meets with malfunction, please check the cause of such malfunction before contacting with the after-sales service center or agent, so as to ensure efficiency of repair.

| Malfunction | Check | Troubleshooting |
|---|--|--|
| <p>The vacuum does not work?</p>  | <ul style="list-style-type: none"> • Is the plug inserted? • Is the socket powered on? • If the hose inserted? • If the motor heat protection opened? | <ul style="list-style-type: none"> • Insert the plug tight (This product is applicable for 220V) • Verify the power of socket is on • Insert the hose tight • Restart in 2 hours |
| <p>The vacuum does not work?</p>  | <ul style="list-style-type: none"> • When the vacuum cleaner's suction is too large or the motor is under high speed running, they do not belong to the abnormal conditions. So, please use the vacuum cleaner properly. • If it is the noise rather than the normal motor sound, please phone the repair center. | |
| <p>Abnormal sound exists inside the vacuum cleaner</p>  | <ul style="list-style-type: none"> • The duster collector is filled up. • The filter is clogged. • Suction inlet is jammed. • Drawtube is clogged. • Hose is clogged. | <ul style="list-style-type: none"> • Clean out the dust collector. • Purge the sponge filter with water and air-dry in the shady and cool place for one day. • Take out the sucked objects before use. • Take out the objects inside the drawtube before use. • Take out the objects inside the hose before use. |
| <p>Peculiar smell exists inside the vacuum cleaner</p>  | | <ul style="list-style-type: none"> • When the motor is running, the rubber band used for fixing the motor will produce a little smell due to the heat, but it will not affect the operation or damage the machine. • When the machine sucks some water accidentally or the dust collector is not cleaned for a long period of time, the peculiar smell will be produced. So, clean up the dust collector timely. |
| <p>Vibration brush head does not work or the amplitude of vibration is too small.</p>  | <ul style="list-style-type: none"> • The vibration brush head is used for cleaning the fabric such as bedclothes and sofa. • The big brush head shall be used for cleaning the carpet. • Check whether the chassis is properly. • When cleaning the thin fabric, please pad the thick bedclothes hereunder. • As cleaning the carpet, sometimes, the machine may not work due to affection from the carpet materials. So, please carry out the operation as required • Please confirm whether obstruction exists at the dust collector and suction inlet. • The amplitude of vibration may be reduced due to the decrease of suction. | |
| <p>The power cord can not be scrolled thoroughly into the vacuum cleaner or the power cord can not be fully pulled.</p>  | <ul style="list-style-type: none"> • Pull out part of the power cord and then re-scroll it. • Please put forth your strength to pull out the power cord, which will not be damaged. • The power cord entwined inside the machine or it is caused by high temperature in the summer. • The cord is bended inside the machine or not coiled around the winder. After the winder is started, the normal operation could be realized. | |
| <p>The vacuum cleaner or the discharged air is too heat.</p>  | <ul style="list-style-type: none"> • Is the suction normal? | <ul style="list-style-type: none"> • The heat air discharged from the machine is arising from the heat produced by motor. So, the temperature is normal, please use the machine continuously. |
| <p>Inner wall of the hose is too dirt.</p> | <ul style="list-style-type: none"> • Never suck the water because after mixing of the water and dust, the tube wall will be polluted and the motor will be damaged. | |

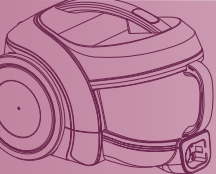

Packing List

Packing List

| | |
|-----------------------|---|
| Vacuum Cleaner | 1 |
| Owner's Manual | 1 |
| Nozzle, Crevice | 1 |
| Steam Nozzle | 1 |
| Sani Punch | 1 |
| Hose | 1 |
| Telescopic tube | 1 |
| Conner Nozzle | 1 |
| Measuring cup | 1 |
| Duster | 3 |
| Pads | 1 |
| Warranty Card | 1 |

如有问题

瞬间感动 Moment Of Truth
LG 售后

请打电话



400-819-9999

售后热线



LG 电子 (天津) 电器有限公司

地址: 中国·天津市北辰区兴淀公路

传真: 022-26903476

邮编: 300402

全国技术服务中心服务咨询电话: 400-819-9999



<http://cn.lge.com>

P/No.: MFL57903824