



**Model : HT564DG (HT564DG-D0P, SH54DG-F/W)**

Full HD up-scaling (1080p) (Go to page 6)	Home theater Speaker ez Set-up (Go to page 15)	USB Direct Recording (Go to page 17)
Made for iPod (Go to page 18)	Portable In (Go to page 19)	



**iPod is a trademark of Apple Inc., registered in the U.S. and other countries.**

 As an ENERGY STAR® Partner, LG has determined that this product or product models meet the ENERGY STAR® guidelines for energy efficiency.

ENERGY STAR® is a U.S. registered mark.



P/NO : MFL60020746

English
DEUTSCH
FRANÇAIS
NEDERLANDS
SLOVENŠČINA
ITALIANO
ESPAÑOL
ΕΛΛΗΝΙΚΑ
PORTUGUÊS

## Safety Precaution



**CAUTION** : TO REDUCE THE RISK OF ELECTRIC SHOCK DO NOT REMOVE COVER (OR BACK) NO USER-SERVICEABLE PARTS INSIDE REFER SERVICING TO QUALIFIED SERVICE PERSONNEL.



This lightning flash with arrowhead symbol within an equilateral triangle is intended to alert the user to the presence of uninsulated dangerous voltage within the product's enclosure that may be of sufficient magnitude to constitute a risk of electric shock to persons.



The exclamation point within an equilateral triangle is intended to alert the user to the presence of important operating and maintenance (servicing) instructions in the literature accompanying the product.

**WARNING** : TO PREVENT FIRE OR ELECTRIC SHOCK HAZARD, DO NOT EXPOSE THIS PRODUCT TO RAIN OR MOISTURE.

**WARNING** : Do not install this equipment in a confined space such as a book case or similar unit.

**CAUTION**: Do not block any ventilation openings. Install in accordance with the manufacturer's instructions.

Slots and openings in the cabinet are provided for ventilation and to ensure reliable operation of the product and to protect it from over heating. The openings shall be never be blocked by placing the product on a bed, sofa, rug or other similar surface. This product shall not be placed in a built-in installation such as a bookcase or rack unless proper ventilation is provided or the manufacturer's instruction has been adhered to.

**CAUTION** : This product employs a Laser System.

To ensure proper use of this product, please read this owner's manual carefully and retain it for future reference. Shall the unit require maintenance, contact an authorized service center.

Use of controls, adjustments or the performance of procedures other than those specified herein may result in hazardous radiation exposure.

To prevent direct exposure to laser beam, do not try to open the enclosure. Visible laser radiation when open. DO NOT STARE INTO BEAM.

**CAUTION**: The apparatus shall not be exposed to water (dripping or splashing) and no objects filled with liquids, such as vases, shall be placed on the apparatus.

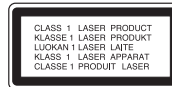

### CAUTION concerning the Power Cord

**Most appliances recommend they be placed upon a dedicated circuit ;**

That is, a single outlet circuit which powers only that appliance and has no additional outlets or branch circuits. Check the specification page of this owner's manual to be certain.

Do not overload wall outlets. Overloaded wall outlets, loose or damaged wall outlets, extension cords, frayed power cords, or damaged or cracked wire insulation are dangerous. Any of these conditions could result in electric shock or fire. Periodically examine the cord of your appliance, and if its appearance indicates damage or deterioration, unplug it, discontinue use of the appliance, and have the cord replaced with an exact replacement part by an authorized service center.

Protect the power cord from physical or mechanical abuse, such as being twisted, kinked, pinched, closed in a door, or walked upon. Pay particular attention to plugs, wall outlets, and the point where the cord exits the appliance.

To disconnect power from the mains, pull out the mains cord plug. When installing the product, ensure that the plug is easily accessible.



### Disposal of your old appliance

1. When this crossed-out wheeled bin symbol is attached to a product it means the product is covered by the European Directive 2002/96/EC.
2. All electrical and electronic products should be disposed of separately from the municipal waste stream via designated collection facilities appointed by the government or the local authorities.
3. The correct disposal of your old appliance will help prevent potential negative consequences for the environment and human health.
4. For more detailed information about disposal of your old appliance, please contact your city office, waste disposal service or the shop where you purchased the product.



**CE** This product is manufactured to comply with EMC Directive 2004/108/EC and Low Voltage Directive 2006/95/EC.

### European representative :

LG Electronics Service Europe B.V.  
Veluwezoom 15, 1327 AE Almere, The Netherlands  
(Tel : +31-036-547-8940)

# Welcome to your new DVD Receiver

## Contents

	Setting up . . . . .	4
	Hooking up the unit . . . . .	5-7
	Main Unit . . . . .	7
	Remote control . . . . .	8
	OSD Initial language settings - Optional . . . . .	9
	Initial Setting the Area Code - Optional . . . . .	9
	Adjusting the general settings . . . . .	9-11
	2.1 Speaker Setup . . . . .	10
	Enjoying a preprogrammed sound field . . . . .	11
	Displaying Disc Information . . . . .	12
	Playing a disc or file . . . . .	12-14
	Viewing photo files . . . . .	14
	Listening to the radio . . . . .	15
	Home theater Speaker ez Set-up . . . . .	15
	Using an USB device . . . . .	16
	Recording to USB . . . . .	17
	Playing the iPod . . . . .	18
	Listening to music from your portable player or external device . . . . .	19
	Other operations . . . . .	19
	Language Codes . . . . .	20
	Area Codes . . . . .	20
	Troubleshooting . . . . .	21
	Types of Playable Discs . . . . .	22
	Specifications . . . . .	23

### Precautions in using the touch buttons

- Use the touch buttons with clean and dry hands.
  - In a humid environment, wipe out any moisture on the touch buttons before using.
- Do not press the touch buttons hard to make it work.
  - If you apply too much strength, it can damage the sensor of the touch buttons.
- Touch the button that you want to work in order to operate the function correctly.
- Be careful not to have any conductive material such as metallic object on the touch buttons. It can cause malfunctions.

- "Made for iPod" means that an electronic accessory has been designed to connect specifically to iPod and has been certified by the developer to meet Apple performance standards.
- Apple is not responsible for the operation of this device or its compliance with safety and regulatory standards



### What is SIMPLINK?

Some functions of this unit are controlled by TV's remote control when this unit and LG TV with SIMPLINK are connected through HDMI connection.

- Controllable functions by LG TV's remote control; Play, Pause, Scan, Skip, Stop, Power Off, etc.
- Refer to the TV owner's manual for the details of SIMPLINK function.
- LG TV with SIMPLINK function has the logo as shown above.
- Use a higher version cable than 1.2A HDMI cable.

## Setting up

The speakers are detached from the speaker stands.

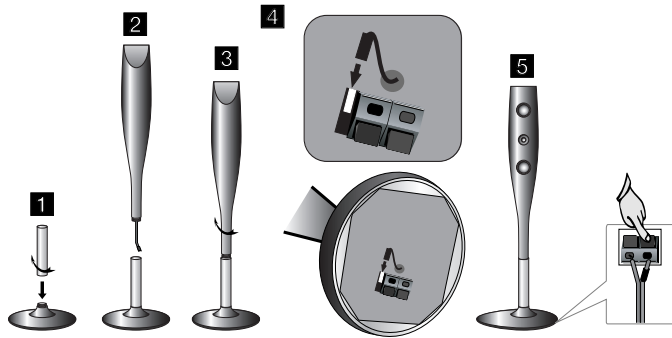

### Assembling the Speakers

- 1** Fix the post to the base by rotating the post.
- 2** Draw the connector cable through the hole on the stand.
- 3** Fix the speaker to the stand by rotating the speaker.
- 4** Connect the connector cable between the speaker and base.
- 5** Connect the speaker cord to the appropriate terminals on the speaker.

## Attaching the speakers to the DVD receiver

- 1** **You will have received 3 speaker cables.**  
Each one is colour-coded by a band near each end and connects one of the 3 speakers to the DVD receiver.

- 2** **Connect the wires to the DVD receiver.**  
Match each wire's coloured band to the same coloured connection terminal on the rear of the DVD receiver. To connect the cable to the DVD receiver, press each plastic finger pad to open the connection terminal. Insert the wire and release the finger pad.

Connect the black end of each wire to the terminals marked -(minus) and the other end to the terminals marked + (plus).

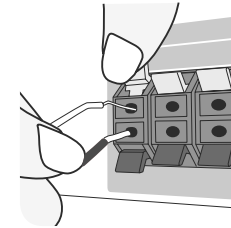

- 3** **Connect the wires to the speakers.**  
Connect the other end of each wire to the correct speaker according to the colour coding:

Main Unit	SPEAKER	POSITION
FRONT R	Red	In front of you, to the right of the screen.
SUB WOOFER	Orange	This can be placed in any front position.
FRONT L	White	In front of you, to the left of the screen.

To connect the cable to the speakers, press each plastic finger pad to open the connection terminals on the base of each speaker. Insert the wire and release the finger pad.

### Be careful of the following

Be careful to make sure children do not put their hands or any objects into the \*speaker duct.

\*Speaker duct: A hall for plentiful bass sound on speaker cabinet(enclosure).

Use the rear speaker at least 30 CM away from either TV screen or PC monitor.

## Hooking up the unit

### 1 Connect jacks on the unit and your TV (DVD player or Digital Device etc.) using the cables.

Check the jacks of your TV, and choose the **A**, **B** or **C** connection. Picture quality improves in order from **A** to **C**.

#### SCART connection (A)

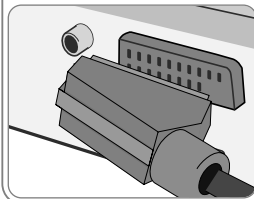

Connect the TO TV jack on the unit and your TV using the SCART cable.

#### Component Video connection (B)

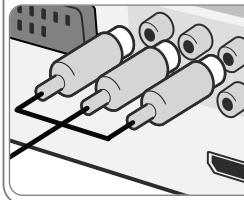

Connect the COMPONENT VIDEO (PROGRESSIVE SCAN) OUTPUT jacks on the unit to the corresponding input jacks on your TV using a Y PB PR cable.

#### FM connection

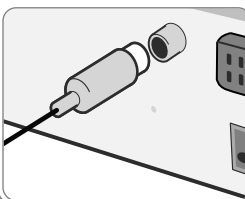

FM - Connect the FM aerial. The reception will be its best when the two loose ends of the aerial are in a straight and horizontal line.

#### Audio In connection

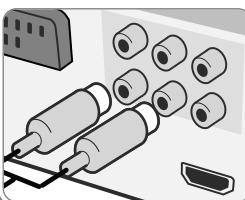

The unit's Audio jacks are colour coded (red for right audio and white for left audio). If your TV has only one output for audio (mono), connect it to the left (white) audio jack on the unit.

#### Video Out connection (A)

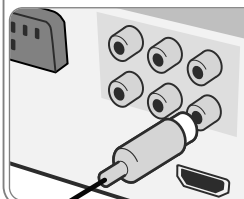

Connect the VIDEO OUTPUT (MONITOR) jack on the unit to the corresponding input jack on your TV using a Video cable.

### 2 Plug the power cord into the power source.

## Hooking up the unit

### Resolution Setting

You can change the resolution for component video and HDMI output. Press **RESOLUTION** repeatedly to select the desired resolution - 480i (or 576i), 480p (or 576p), 720p, 1080i, 1080p. The resolution may not be selected depending on the connection or TV.

- Depending on your TV, some of the resolution settings may result in the picture disappearing or an abnormal picture appearing. In this case, press **RESOLUTION** repeatedly until the picture re-appears.

**You can set 1080p video resolution to enjoy Full HD picture quality. (Full HD up-scaling)**

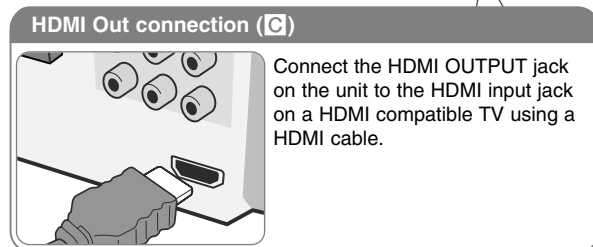
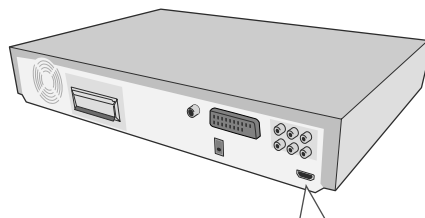

### Available resolution according to connection

Displayed resolution in display window and outputted resolution may differ according to connection type.

[HDMI OUT]: 1080p, 1080i, 720p and 480p (or 576p) and 480i (or 576i)

[COMPONENT VIDEO OUT]: 480p (or 576p) and 480i (or 576i)

[VIDEO OUT]: 480i (or 576i)

[SCART]: 576i

### Notes on HDMI Out connection

- If your TV does not accept your resolution setting, abnormal picture appears on the screen. ("TV do not support" will appear in screen) Please read owner's manual for TV, and then set the resolution that your TV can accept.
- Changing the resolution when the unit is connected with HDMI connector may result in malfunctions. To solve the problem, turn off the unit and then turn it on again.
- When you connect a HDMI or DVI compatible device make sure of the following :
  - Try switching off the HDMI/ DVI device and this unit. Next, switch on the HDMI/ DVI device and leave it for around 30 seconds, then switch on this unit.
  - The connected device's video input is set correctly for this unit.
  - The connected device is compatible with 720X480i(576i), 720X480p(576p), 1280X720p, 1920X1080i or 1920X1080p video input.
  - The 1080p, 720p and 480p(576p) resolutions are the progressive scan applied resolution.
- Not all HDCP-compatible DVI devices will work with this unit.
  - The picture will not be displayed properly with non-HDCP device.

### Enjoying audio from an external source and selecting the function

You can enjoy audio from an external source through your unit. And You can select the function.

Press **FUNCTION** repeatedly to select the desired input source and the function (DVD/CD, USB, OSD IPOD, IPOD, AUX, AUX OPT, TV-AUDIO, PORTABLE, FM).

## Hooking up the unit

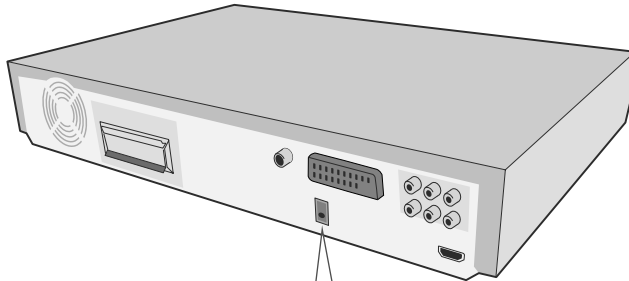

**Digital Audio in connection**

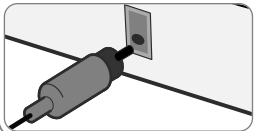

Connect the unit's OPTICAL IN jack to the optical out to jack on your TV (or Digital Device etc.)

## Main Unit

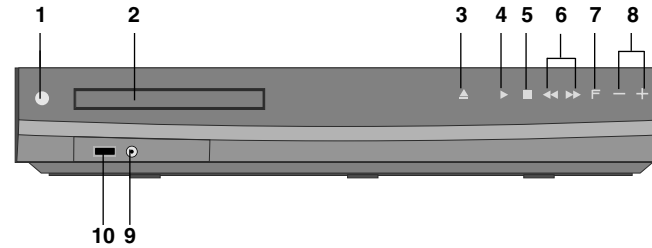

- 1 Power (⏻/⏻)**  
Turns the unit on and off.
- 2 DVD/CD Disc Drawer**
- 3 Open/Close (⏮)**
- 4 Play/Pause (▶/⏸)**
- 5 Stop (■)**
- 6 TUNING, Skip / Search (⏪⏩)**
- 7 Function (F)**  
Selects the function and input source.  
(DVD/CD, USB, OSD IPOD, IPOD, AUX, AUX OPT, TV-AUDIO, PORTABLE, FM)
- 8 Volume (-/+)**  
Controls the volume when using any function.
- 9 PORT. (Portable) IN port**  
You can enjoy music from portable device on your unit.
- 10 USB port**  
You can play video, image and sound files by connecting the USB device.

## Remote control

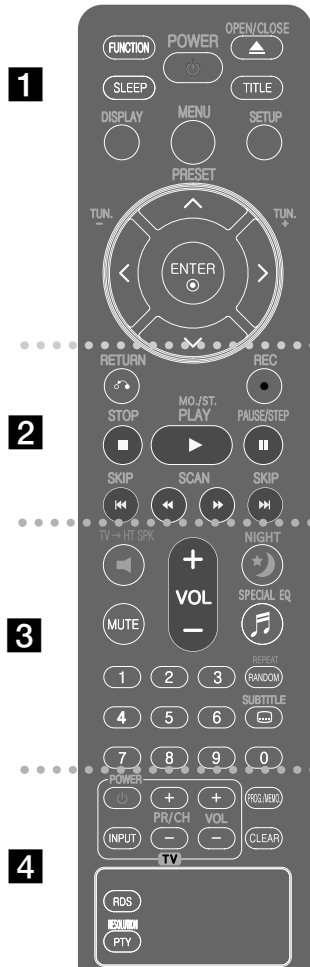

8

**1**

**FUNCTION** : Selects the function and input source. (DVD/CD, USB, OSD IPOD, IPOD, AUX, AUX OPT, TV-AUDIO, PORTABLE, FM)

**SLEEP** : Sets the System to turn off automatically at a specified time. (Dimmer : The front panel display is dimmed.)

**POWER** : Switches the unit ON or OFF.

**OPEN/CLOSE** : Opens and closes the disc Drawer.

**TITLE** : If the current DVD title has a menu, the title menu appears on the screen. Otherwise, the disc menu may not appear.

**DISPLAY** : Accesses On-Screen Display.

**MENU** : Accesses the menu on a DVD disc.

**SETUP** : Accesses or removes setup menu

**PRESET (Λ V)** : Selects programme of Radio.

**TUN. (-/+)** : Tunes in the desired radio station.

**Λ V <> (up/ down/ left/ right)**: Used to navigate on-screen displays.

**ENTER** : Acknowledges menu selection.

**2**

**RETURN (↶)** : moving backwards in the menu.or exited the setup menu.

**REC (●)** : USB Direct Recording

**STOP (■)** : Stops playback or recording.

**PLAY (▶), MO./ST.** : Starts playback. Selects Mono/ Stereo

**PAUSE/STEP (⏸)** : Pause playback

**SKIP (⏮ / ⏭)** : Go to next or previous chapter/ track/ file.

**SCAN (⏪/⏩)** : Search backward or forward.

### Put the batterie into the remote control

Make sure that the + (plus) and – (minus) on the battery match those on the remote control.

**3**

**TV→HT SPK (Home theater Speaker ez Set-up)** : Press TV→HT SPK to select the AUX OPT directly

**MUTE** : To mute the sound.

**VOL (Volume) (+/-)** : Adjusts speaker volume.

**NIGHT** : The night mode is to improve listenalbe at lower volumes. (NIGHT↔NATURAL)

**SPECIAL EQ (EQUALIZER effect)** : You can choose sound impressions.

**REPEAT/RANDOM** : To select a play mode.(Repeat, Random)

**SUBTITLE** : During playback, press SUBTITLE repeatedly to select a desired subtitle language .

**0-9 numerical buttons** : Selects numbered options in a menu.

**4**

**TV Control buttons** : Controls the TV. (LG TV only)

### Controlling the TV.

You can control the sound level, input source, and power switching of LG TVs as well. Hold POWER (TV) and press PR/CH (+/-) button repeatedly until the TV turns on or off.

**PROG./MEMO.** : Accesses or removes Program menu.

**CLEAR** : Removes a track number on the Program List.

**RESOLUTION** : Sets the output resolution for HDMI and COMPONENT VIDEO OUT jacks.

**RDS** : Radio Data System.

**PTY** : Views the various displays of the RDS



### OSD Initial language settings - Optional

During the first use of this unit, the initial language setup menu appears on your TV screen. You must complete initial language selection before using the unit. English will be selected as the initial language.

	ON REMOTE
<b>1 Turn the power on :</b> The language list appears	<b>POWER</b>
<b>2 Select the language :</b>	<b>^ V &lt; &gt;</b>
<b>3 Press :</b>	<b>ENTER</b>
<b>4 To confirm press :</b>	<b>&lt; &gt; and ENTER</b>

### Initial Setting the Area Code - Optional

When you use this unit for the first time, you have to set the Area Code as shown below.

	ON REMOTE
<b>1 Display setup menu :</b>	<b>SETUP</b>
<b>2 Select LOCK menu on the first level:</b>	<b>^ V</b>
<b>3 Move to second level :</b> The activated Area Code appears on the second level. :	<b>&gt;</b>
<b>4 Move to the third level :</b>	<b>&gt;</b>
<b>5 Enter a new password :</b>	<b>numerical buttons (0-9) and ENTER</b>
<b>6 Recheck the entered new password :</b>	<b>numerical buttons (0-9) and ENTER</b>
<b>7 Select a code for a geographic area :</b> After select, Rating and Password will be activated. (page 20)	<b>^ V &lt; and ENTER</b>
<b>8 To confirm what you press :</b> Make sure to finish setting the Area Code before leaving the setup menu if you cannot set the rating and Password	<b>ENTER</b>

### Adjusting the general settings

	ON REMOTE
<b>1 Display setup menu :</b>	<b>SETUP</b>
<b>2 Select a desired option on the first level :</b>	<b>^ V</b>
<b>3 Move to the second level :</b>	<b>&gt;</b>
<b>4 Select a desired option on the second level :</b>	<b>^ V</b>
<b>5 Move to the third level :</b>	<b>&gt;</b>
<b>6 Change the setting :</b>	<b>^ V, ENTER</b>

### Adjusting the settings - more you can do

#### Adjusting the language settings

**Menu Language** – Select a language for the Setup menu and on-screen display.

**Disc Audio/ Disc Subtitle/ Disc Menu** – Select a language for the Disc Audio/ Disc Subtitle/ Disc Menu.

[Original] : Refers to the original language in which the disc was recorded.

[Others] : To select another language, press number buttons then **ENTER** to enter the corresponding 4-digit number according to the language code list in the reference chapter (see page 20). If you make a mistake before pressing **ENTER**, press **CLEAR**.

[Off] (for Disc Subtitle) : Turn off Subtitle.

### Adjusting the display settings

**TV Aspect** – Select which screen aspect to use based on the shape of your TV screen.

[4:3] : Select when a standard 4:3 TV is connected.

[16:9] : Select when a 16:9 wide TV is connected.

**Display Mode** – If you selected 4:3, you'll need to define how you would like widescreen programs and films to be displayed on your TV screen.

[Letterbox] : This displays a widescreen picture with black bands at the top and bottom of the screen.

[Panscan] : This fills the entire 4:3 screen, cropping the picture as necessary.

**TV Output Select** – Select an option according to the TV connection type.

[RGB] : When your TV is connected with the SCART jack.

[YPbPr] : When your TV is connected with the

COMPONENT/ PROGRESSIVE SCAN jacks on the unit.

- If you change TV Output Select to RGB from YPbPr on the setup menu especially when connecting the unit in the way of component video connection, the screen turns black. In that case, connect the video cable to MONITOR jack and select YPbPr on the setup menu again.

### Adjusting the audio settings

**DRC (Dynamic Range Control)** – Make the sound clear when the volume is turned down (Dolby Digital only). Set to [On] for this effect.

**Vocal** – Select [On] to mix karaoke channels into normal stereo.

This function is effective for multi-channel karaoke DVDs only.

**HD AV Sync** - Sometimes Digital TV encounters a delay between picture and sound. If this happens you can compensate by setting a delay on the sound so that it effectively 'waits' for the picture to arrive: this is called HD AV Sync. Use **^ V** (on the remote control) to scroll up and down through the delay amount, which you can set at anything between 0 and 300m sec.

## 2.1 Speaker Setup

	ON REMOTE
<b>1 Open the settings menu:</b>	<b>SETUP</b>
<b>2 Select to the audio icon:</b>	<b>^ V</b>
<b>3 Select right to enter the audio menu, then select 2.1 Speaker Setup:</b>	<b>&gt; ^ V ENTER</b>
<b>4 Select the speaker you want to adjust:</b>	<b>&lt; &gt;</b>
	
<b>5 Select a option and change the settings:</b>	<b>^ V &lt; &gt;</b>
<b>6 Set the output level (volume) of a speaker:</b> from -5dB to +5dB. The speaker size setting are fixed, so you cannot change the setting.	<b>&lt; &gt;</b>
<b>7 If you connect speakers to your unit, setting the Distance lets the speakers to know how far the sound has to travel to reach your set listening point. This allows the sound from each speaker to reach the listener at the same time.</b>	<b>&lt; &gt;</b>
<b>8 Test the signals of each speaker:</b> Adjust the volume to your taste according to these signals.	<b>&lt; &gt;</b>
<b>9 Save your settings and exit the Setup menu:</b>	<b>RETURN</b>

### Adjusting the lock settings

To access the lock options, you must enter the 4-digit password. If you have not yet entered a password you are prompted to do so. Enter a 4-digit password then press **ENTER**. Enter it again then press **ENTER** to verify. If you make a mistake while entering number, press **CLEAR** then correct it. If you forget your password you can reset it. First, remove the disc in the unit. Press **SETUP** to display the Setup menu. Input '210499' and press **ENTER**. The password has now been cleared.

**Rating** – Select a rating level. The lower the level, the stricter the rating. Select [Unlock] to deactivate the rating.

**Password** – Sets or changes the password for lock settings.

**[New]** : Enter a new 4-digit password using the numerical buttons then press **ENTER**. Enter the password again to confirm.

**[Change]** : Enter the new password twice after entering the current password.

**Area Code** – Select a code for a geographic area as the playback rating level. This determines which area's standards are used to rate DVDs controlled by the parental lock. See the Area Codes on page 20.

### Adjusting the others settings

**DivX(R) VOD** – We provide you with the DivX® VOD (Video On Demand) registration code that allows you to rent and purchase videos using the DivX® VOD service.

For more information, visit [www.divx.com/vod](http://www.divx.com/vod).

Press **ENTER** when [DivX(R) VOD] is highlighted and you can view the registration code of the unit.

### Enjoying a pre-programmed sound field

This system has a number of pre-set surround sound fields. You can select a desired sound mode by using **SPECIAL EQ/ NIGHT**. You can change the **SPECIAL EQ/ NIGHT** using **< >** arrow key while the **SPECIAL EQ/ NIGHT** information is displayed on.

The displayed items for the Equalizer may be different depending on sound sources and effects.





ON DISPLAY	Description
NATURAL	You can enjoy comfortable and natural sound.
AUTO EQ	Realizes the sound equalizer that is the most similar to the genre of which is included in the MP3 ID3 tag of song files.
POP CLASSIC JAZZ ROCK	This program lends an enthusiastic atmosphere to the sound, giving you the feeling you are at an actual rock pop, jazz or classic concert.
MP3 OPT	This function is optimized for compressible MP3, WMA file. It improves the bass sound.
BASS	Reinforce the treble, bass and surround sound effect.
CLEAR VOICE	This program make Voice sound clear, improving the quality of voice sound.
GAME EQ	You can enjoy more virtual sound while playing video games.
NIGHT MODE	This may be useful when you want to watch movies at low volumes late at night.
CINEMA MODE	You can enjoy more virtual sound while watching movies.
VIRTUAL	You can enjoy more virtual surround sound.
NORMAL(OFF)	You can enjoy the sound without equalizer effect

## Displaying Disc Information

	ON REMOTE
1 Press DISPLAY :	DISPLAY
2 Select an item :	▲ ▼
3 Adjust the Display menu settings :	< >
4 To return the exit :	DISPLAY

### Displaying Disc Information - more you can do

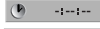
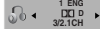
You can select an item by pressing ▲ ▼ and change or select the setting by pressing < >.

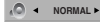
	Current title (or track/ file) number/ total number of titles (or tracks/ files)
	Current chapter number/ total number of chapters
	Elapsed playing time
	Selected audio language or channel
	Selected subtitle
	Selected angle/ total number of angles
	Selected sound mode

### Symbol Used in this Manual

All discs and file listed below	<b>ALL</b>	MP3 files	<b>MP3</b>
DVD and finalized DVD±R/RW	<b>DVD</b>	WMA files	<b>WMA</b>
DivX files	<b>DivX</b>	Audio CDs	<b>ACD</b>

## Playing a Disc or file

	ON REMOTE
1 Insert a disc on unit :	▲ OPEN/CLOSE
2 Select a DVD/CD :	FUNCTION
3 Adjust the menu settings : or Select a file from the menu :	▲ ▼ < > ▲ ▼
4 Start the Disc playing :	▶ PLAY
5 To stop the Disc playing :	■ STOP

### Playing a Disc or file - more you can do

#### Playing a DVD that has a menu **DVD**

Most DVDs now have menus which load first before the film begins to play. You can navigate these menus using ▲ ▼ < > to highlight an option. Press **PLAY** (▶) to select.

#### Skipping to the next/ previous chapter/ track/ file **ALL**

Press **SKIP** (▶▶) to move to the next chapter/ track/ file.  
Press **SKIP** (◀◀) to return to the beginning of the current chapter/ track/ file.  
Press **SKIP** (◀◀) twice briefly to step back to the previous chapter/ track/ file.

#### Pausing playback **ALL**

Press **PAUSE/STEP** (||) to pause playback. Press **PLAY** (▶) to continue playback.

#### Frame-by-Frame playback **DVD** **DivX**

Press **PAUSE/STEP** (||) repeatedly to play title Frame-by-Frame.

#### Playing repeatedly or randomly **ALL**

Press **REPEAT/RANDOM** repeatedly, and the current title, chapter or track will be played back repeatedly or randomly. To return to normal playback, press **REPEAT/RANDOM** repeatedly.

- Random play mode : only music files.

**Fast forward or fast reverse** **ALL**

Press **SCAN** (◀◀ or ▶▶) to play fast forward or fast reverse during playback. You can change the playback speed by pressing **SCAN** (◀◀ or ▶▶) repeatedly. Press **PLAY** (▶) to continue play at normal speed.

**Selecting a subtitle language** **DVD** **DivX**

During playback, press **SUBTITLE** (☐) repeatedly to select a desired subtitle language.

**Slow down the playing speed** **DVD** **DivX**

While playback is paused, press **SCAN** (◀◀ or ▶▶) to slow down forward or reverse playback. You can change the various playback speed by pressing **SCAN** (◀◀ or ▶▶) repeatedly. Press **PLAY** (▶) to continue play at normal speed. The DivX file cannot be slow down reverse playback.

**1.5 times faster playback** **DVD**

Press **PLAY** (▶) when a DVD is already playing to watch and listen to a DVD 1.5 times faster than normal playback speed. "▶ x1.5" will appear in the screen. Press **PLAY** (▶) again to return to normal playback speed.

**Viewing the Title menu** **DVD**

Press **TITLE** to display the disc's title menu, if available.

**Starting play from selected time** **DVD** **DivX**

Searches for the starting point of entered time code. Press **DISPLAY** then select clock icon. Enter a time then press **ENTER**. For example, to find a scene at 1 hour, 10 minutes, and 20 seconds, enter "11020" by using numerical buttons and press **ENTER**. If you enter the wrong number, press **CLEAR** to enter again.

**Last Scene Memory** **DVD**

This unit memorizes the last scene from the last disc that is viewed. The last scene remains in memory even if you remove the disc from the player or switch off (Stand-by mode) the unit. If you load a disc that has the scene memorized, the scene is automatically recalled.

**Mixed disc or USB Flash Drive – DivX, MP3/ WMA and JPEG**

When playing a disc or USB Flash Drive containing with DivX, MP3/ WMA and JPEG files together, you can select menu of files which you would like to play by pressing **MENU**. If "This file has non-supported type" pops up, select and appropriate file by pressing **MENU**.

**Viewing the DVD MENU** **DVD**

Press **MENU** to display the disc menu, if available.

**Changing the character set to display DivX® subtitle correctly** **DivX**

If the subtitle does not display properly during playback, press and hold **SUBTITLE** for about 3 seconds then press < > or **SUBTITLE** to select another language code until the subtitle is displayed properly and then press **ENTER**.

**DivX file requirement** **DivX**

**DivX disc compatibility with this player is limited as follows :**

- Available resolution: within 720x576 (W x H) pixels
- The file name of the DivX subtitle should be entered within 45 characters.
- If there is impossible code to express in the DivX file, it may be displayed as " \_ " mark on the display.
- Frame rate : less than 30 fps
- If the video and audio structure of recorded files is not interleaved, either video or audio is outputted.
- Playable DivX file : ".avi", ".mpg", ".mpeg", ".divx"
- Playable Subtitle format : SubRip (\*.srt/ \*.txt), SAMI (\*.smi), SubStation Alpha (\*.ssa/ \*.txt), MicroDVD (\*.sub/ \*.txt), SubViewer 2.0 (\*.sub/ \*.txt)
- Playable Codec format : "DIVX3.xx", "DIVX4.xx", "DIVX5.xx", "MP4V3", "3IVX".
- Playable Audio format : "AC3", "DTS", "PCM", "MP3", "WMA".
- Sampling frequency : within 32 - 48 kHz (MP3), within 32 - 48kHz (WMA)
- Bit rate: within 32 - 320kbps (MP3), 40 - 192kbps (WMA)
- For Discs formatted in Live file system, you can not it on this player.
- If the name of movie file is different from that of the subtitle file, during playback of a DivX file, subtitle may not be display.
- If you play a DivX file differ from DivX spec, it may not operate normally.

**Creating your own program** **ACD** **MP3** **WMA**

You can play the contents of a disc in the order you want by arranging the order of the musics on the disc. To add a music(s) on the program list, press **PROG./MEMO.** to enter the program edit mode (Ⓜ mark appears on the menu). Select a desired music on the [List] by using the **▲ ▼** then press **ENTER** to add the music to the program list. Select music from the program list then press **ENTER** to start programmed playback. To clear a music from the program list, select the music you want to clear by using the **▲ ▼** then press **CLEAR** in program edit mode. To clear all music from the program list, select [Clear All] then press **ENTER** in program edit mode. The program is cleared when the disc is removed or the unit is turned off.

**Displaying file information (ID3 TAG)** **MP3**

While playing an MP3/ WMA file containing file information, you can display the information by pressing **DISPLAY** repeatedly.

**MP3/ WMA music file requirement**

MP3/ WMA disc compatibility with this player is limited as follows :

- Sampling frequency : within 32 - 48 kHz (MP3), within 32 - 48kHz (WMA)
- Bit rate : within 32 - 320kbps (MP3), 40 - 192kbps (WMA)
- Support Version : v2, v7, v8, v9
- Maximum files : Under 999.
- File extensions : “.mp3”/ “.wma”
- CD-ROM file format : ISO9660/ JOLIET
- We recommend that you use Easy-CD Creator, which creates an ISO 9660 file system.

**Viewing photo files**

	ON REMOTE
1 Insert a disc on unit :	▲ OPEN/CLOSE
2 Select a DVD/CD :	FUNCTION
3 Select a photo file :	▲ ▼
4 Display the selected file in full screen :	▶ PLAY
5 To return to the menu :	■ STOP

**Viewing photo files - more you can do****Viewing photo files as a slide show**

Use **▲ ▼ < >** to highlight (🖼) icon then press **PLAY (▶)** to start slide Show. You can change slide show speed using **< >** when (🕒) icon is highlighted. Depending on the size and resolution of JPEG files, it may take longer for slide show to be set.

**Skipping to the next/ previous photo**

Press **SKIP (◀◀ or ▶▶)** or **< >** to view the previous/ next photo.

**Rotating a photo**

Use **▲ ▼** to rotate the photo in full screen counterclockwise or clockwise while viewing a photo in full screen.

**Pausing a slide show**

Press **PAUSE/STEP (⏸)** to pause a slide show. Press **PLAY (▶)** or **PAUSE/STEP (⏸)** to continue the slide show.

**Listening to music during slide show**

You can listen to music during slide show, if the disc contain music and photo files together. Use **▲ ▼ < >** to highlight (🎵) icon then press **PLAY (▶)** to start slide show. This function is available only in disc.

**Photo file requirement**

JPEG disc compatibility with this player is limited as follows :

- Max pixel in width : 2760 x 2048 pixel
- Maximum files : Under 999.
- Some discs may not operate due to a different recording format or the condition of disc.
- File extensions: “.jpg”
- CD-ROM file format : ISO9660/ JOLIET

## Listening to the radio

Be sure that FM aerials are connected.

	ON REMOTE
<b>1 Turn the power on :</b>	<b>POWER</b>
<b>2 Select FM :</b>	<b>FUNCTION</b>
<b>3 Select a radio station :</b>	<b>TUN.-/+</b>
<b>4 To 'save' a radio station :</b> A preset number will show in the display.	<b>PROG./MEMO.</b>
<b>5 Select the preset number :</b> Up to 50 radio stations can be saved.	<b>PRESET ^ V</b>
<b>6 To confirm press :</b>	<b>PROG./MEMO.</b>
<b>7 To select a 'saved' station input the preset number :</b>	<b>PRESET ^ V</b>

## Listening to the radio - more you can do

### Looking for radio stations automatically

Press and hold **TUN.-/ TUN.+** for more than a second. The tuner will scan automatically and stop when it finds a radio station.

### Deleting all the saved stations

Press and hold **PROG./MEMO.** for two seconds. ERASE ALL will flash up on the DVD receiver display. Press **PROG./MEMO.** to erase all saved radio stations.

### Improving poor FM reception

Press **PLAY (▶) (MO./ST.)** on the remote control. This will change the tuner from stereo to mono and usually improve the reception.

## Seeing information about a radio station

The FM tuner is supplied with the RDS (Radio Data System) facility. This shows information about the radio station being listened to. Press RDS repeatedly to cycle through the various data types. :

- PS** (Programme Service Name)  
The name of the channel will appear in the display
- PTY** (Programme Type Recognition)  
The programme type (e.g. Jazz or News) will appear in the display.
- RT** (Radio Text)  
A text message contains special information from the broadcast station. This text may scroll across the display.
- CT** (Time controlled by the channel)  
This shows the time and date as broadcast by the station.

## Home theater Speaker ez Set-up

Listen to sound from TV, DVD and Digital Device with 2.1 (or 2)ch mode. Even in power off mode, if you press **TV→HT SPK**, then power is on and automatically changed to AUX OPT mode.

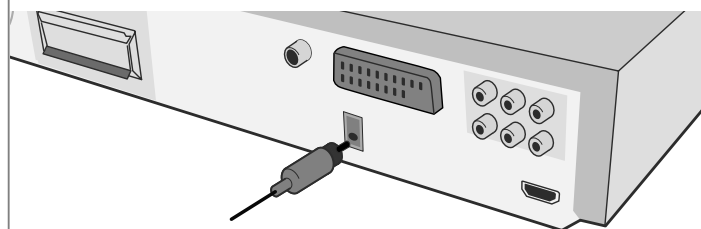

	ON REMOTE
<b>1 Connect</b> the unit's OPTICAL IN jack to jack on optical out of your TV (or Digital Device etc.):	-
<b>2 Select the AUX OPT:</b> To select the AUX OPT directly	<b>TV→HT SPK</b>
<b>3 Listen sound with 2.1 (or 2)ch speaker.:</b>	-
<b>4 To escape from AUX OPT:</b> Function is returned to previous one.	<b>TV→HT SPK</b>

## Using an USB device

You can enjoy media files saved on an USB device by connecting the USB device to the USB port of the unit.  
If you want to operate other function, see the CD playback section.

	ON REMOTE
<b>1 Connect the USB device to the USB port of the unit.</b>	-
<b>2 Select the USB function</b>	<b>FUNCTION</b>
<b>3 Select a file you want to play</b>	<b>^ V</b>
<b>4 Start your media playing</b>	<b>▶ PLAY</b>
<b>5 To stop, press</b>	<b>■ STOP</b>
<b>6 Before disconnecting the portable USB device, change to any other function.</b>	<b>FUNCTION</b>

### Compatible USB Devices

- MP3 Player : Flash type MP3 player.
- USB Flash Drive : Devices that support USB2.0 or USB1.1.
- The USB function of this unit does not support all USB devices.

### USB device requirement

- Devices which require additional program installation when you have connected it to a computer, are not supported.

### Look out for the follows.

- **Do not extract the USB device while in operation.**
- For a large capacity USB, it may take longer than a few minute to be searched
- To prevent data loss, back up all data.
- If you use a USB extension cable or USB hub, the USB device is not recognized.
- Using NTFS file system is not supported. (Only FAT(16/32) file system is supported.
- This unit is not supported when the total number of files is 1000 or more.
- External HDD, Card readers, Locked devices, or hard type usb devices are not supported.
- USB port of the unit cannot be connected to PC. The unit can not be used as a storage device.



Recording to USB	
	ON REMOTE
<b>1 Connect the USB device to the unit</b>	-
<b>2 Select a mode in which you want to record</b> (ex. CD/ TUNER...) <b>Play back a sound source first</b> If you want to record desired music file in Disc to USB, record after playing back the file.	<b>FUNCTION</b>  ▲ V and ► <b>PLAY</b>
<b>3 Start the recording</b>	● <b>REC</b>
<b>4 To stop recording, press</b>	■ <b>STOP</b>

## Recording to USB - more you can do

### Recording Music file in disc source to USB

#### One track recording

If the USB recording is played during playback of the CD, the one track/ file would be recording into the USB.

#### All tracks recording

If the recording button is pressed at the CD stop, all tracks/ files would be recording.

- The files in the sub-folders are not recorded during all track recording.
- If you want to all tracks recording during playback, press stop twice. check the "■" on the screen.

#### Program list recording

USB records after creating your own program if you want to record the track you want (AUDIO CD Only).

### When you are recording, look out for the following

- You can check the recording percentage rate for the USB record on the screen during the recording.(AUDIO CD or MP3/ WMA CD only)
- During recording MP3/ WMA, there is no sound.
- When you stop recording during playback, the file that has been recorded at that time will be stored.(AUDIO CD Only)
- Do not remove the USB device during USB recording. If not, an incomplete file may be made and not deleted on PC.
- If USB recording does not work, the message like "NO USB", "ERROR", "USB FULL" or "NO REC" is displayed on the display window.
- Multi card reader device or external HDD can not be used for USB recording.
- A file is recorded by 128Mbyte (about 2 hours) when you record for a long term. There are recorded less than 4 files.
- When you stop recording during playback, the file will not be stored.
- In the state CD-G, DTS disc USB record is not operated
- You may not record more than 999 files.
- **It'll be stored as follows.**

AUDIO CD	MP3/ WMA	The other sources (Tuner, AUX, Portable)
<pre> ■ CD_REC        --- TRK_001    --- TRK_002        --- ⋮                     </pre>	<pre> ■ FILE_REC        --- 001_ABC(File name)    --- 002_DEF(File name)        --- ⋮                     </pre>	<pre> ■ EXT_REC        --- AUDIO_001    --- AUDIO_002        --- ⋮                     </pre>

The making of unauthorized copies of copy-protected material, including computer programs, files, broadcasts and sound recordings, may be an infringement of copyrights and constitute a criminal offense. This equipment should not be used for such purposes.

**Be responsible  
Respect copyrights**

## Playing the iPod

**For detail refer to iPod guide.**

**iPod mode:** You can operate your iPod by using the supplied remote control and directly control on your iPod.

**OSD iPod mode:** You can operate your iPod by controlling OSD menu on the TV screen with supplied remote control. The controls on your iPod are not operational in the OSD iPod mode.

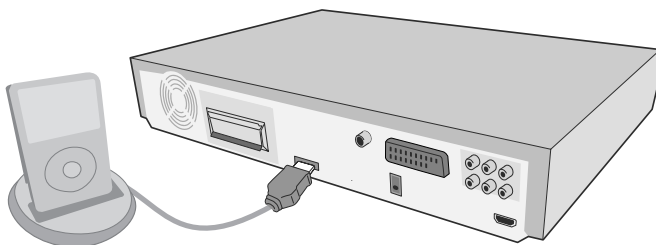

	ON REMOTE
<b>1 Connect the iPod dock on the rear of the unit.:</b>	-
<b>2 Connect your iPod to the dock.:</b>	-
<b>3 Turn the power on:</b>	<b>POWER</b>
<b>4 Select the OSD iPod or iPod function:</b>	<b>FUNCTION</b>
<b>5 Select the menu:</b> If you want to move backwards in the menu, press MENU	<b>^ V and ENTER</b>
<b>6 Select a file:</b>	<b>^ V</b>
<b>7 Start the file playing:</b>	<b>▶ PLAY or ENTER</b>
<b>8 To stop the file playing:</b>	<b>■ STOP</b>
<b>9 Before disconnecting the iPod, change to any other function by pressing:</b>	<b>FUNCTION</b>
<b>10 Remove the iPod:</b>	-

## Playing the iPod - more you can do

### Pausing playback

Press **PAUSE/STEP (||)** or **PLAY (▶)** to pause playback. Press **PAUSE/STEP (||)** or **PLAY (▶)** to continue playback.

### Skipping to the next/previous file

Press **SKIP (▶▶)** to move to the next file.

Press **SKIP (◀◀)** to return to the beginning of the current file.

Press **SKIP (◀◀)** twice briefly to step back to the previous file.

### Fast forward or fast reverse

Audio files: During playback, press and hold **SCAN (◀◀ or ▶▶)** and then release at a point you want.

Video files: During playback, press **SCAN (◀◀ or ▶▶)**. Press **PLAY (▶)** continue play at normal speed.

### Playing repeatedly

Press **REPEAT/RANDOM** repeatedly to select an item to be repeated. The current file will be played back repeatedly. To return to normal playback, press **REPEAT/RANDOM** repeatedly. (On video files, this function is not available.)

### iPod message **OSD iPod mode**

**“Please, check your iPod”** - If the power of your iPod is insufficient or the iPod is misconnected or unknown device. Reset the iPod if the iPod is not operating normally (Refer to <http://www.apple.com/support/>)

**“Connect Video Out(only composite) from the HTS to the TV and switch TV input accordingly.”**, **“Please, Control through an iPod’s display.”** - When you connect the unit and TV to COMPONENT VIDEO OUT or HDMI OUT, connect the unit and TV to VIDEO OUT.

### Compatible iPod

- When the unit is connected with dock connector may result in malfunctions
- Compatibility with your iPod may vary depending on the type of your iPod.
- Depending on your iPod's software version, it may not be possible to control your iPod from the unit. We recommend installing the latest software version.

### When you use iPod, look out for the following

- Interference may happen depending on iPod devices.
- The video files are outputted only when you connect the unit to VIDEO OUT.
- Connect the end on the cable with the marked “▼” facing downwards to rear on the unit.
- Be careful not to put iPod dock strongly into the unit when connecting or disconnecting it. But the cable may be damaged.

## Listening to music from your portable player or external device

The unit can be used to play the music from many types of portable player or external device.

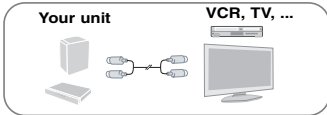
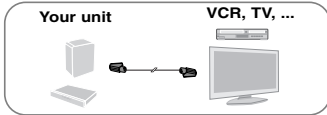
	ON REMOTE
<p><b>1 Connect the portable player to the PORT.IN(PORTABLE IN) connector of the unit.</b></p>  <p style="text-align: center;"><b>Or</b></p> <p><b>Connect the external device to the AUX connector of the unit.</b>                      &gt; If your TV has only one output for audio(MONO), connect it to the left(white) audio jack on the unit.</p>  <p style="text-align: center;"><b>Or</b></p> <p><b>Connect the TO TV jack on the unit and your TV using the SCART cable.</b></p> 	-
<b>2 Turn the power on</b>	<b>POWER</b>
<b>3 Select the PORTABLE, AUX or TV-AUDIO (SCART) function</b>	<b>FUNCTION</b>
<b>4 Turn the portable external device and start it playing</b>	-

## Other operations

### Fall asleep while listening to your player

Press **SLEEP** one or more times to select delay time between 10 and 180 minutes, after the player will turn off.

To check the remaining time, press **SLEEP**. To cancel the sleep function, press **SLEEP** repeatedly until "SLEEP 10" appears, and then press **SLEEP** once again while "SLEEP 10" is displayed.

### DIMMER

Press **SLEEP** once. The LED (Light-emitting diode) of front panel is turned off and the display window will be darkened by half. To cancel it, press **SLEEP** repeatedly until dim off.

### Screen Saver

The screen saver appears when you leave the unit in Stop mode for about five minutes.

### System Select - Optional

You must select the appropriate system mode for your TV system. If "NO DISC" appears in the display window, press and hold **PAUSE/STEP (|||)** on the remote control for more than five seconds to be able to select a system. (PAL/NTSC)

## Language Codes

Use this list to input your desired language for the following initial settings: Disc Audio, Disc Subtitle, Disc Menu.

Language	Code	Language	Code	Language	Code	Language	Code	Language	Code	Language	Code
Afar	6565	Croatian	7282	Hausa	7265	Lingala	7678	Quechua	8185	Tajik	8471
Afrikaans	6570	Czech	6783	Hebrew	7387	Lithuanian	7684	Rhaeto-Romance	8277	Tamil	8465
Albanian	8381	Danish	6865	Hindi	7273	Macedonian	7775	Rumanian	8279	Telugu	8469
Ameharic	6577	Dutch	7876	Hungarian	7285	Malagasy	7771	Russian	8285	Thai	8472
Arabic	6582	English	6978	Icelandic	7383	Malay	7783	Samoan	8377	Tonga	8479
Armenian	7289	Esperanto	6979	Indonesian	7378	Malayalam	7776	Sanskrit	8365	Turkish	8482
Assamese	6583	Estonian	6984	Interlingua	7365	Maori	7773	Scots Gaelic	7168	Turkmen	8475
Aymara	6588	Faroese	7079	Irish	7165	Marathi	7782	Serbian	8382	Twi	8487
Azerbaijani	6590	Fiji	7074	Italian	7384	Moldavian	7779	Serbo-Croatian	8372	Ukrainian	8575
Bashkir	6665	Finnish	7073	Japanese	7465	Mongolian	7778	Shona	8378	Urdu	8582
Basque	6985	French	7082	Kannada	7578	Nauru	7865	Sindhi	8368	Uzbek	8590
Bengali; Bangla	6678	Frisian	7089	Kashmiri	7583	Nepali	7869	Singhalese	8373	Vietnamese	8673
Bhutani	6890	Galician	7176	Kazakh	7575	Norwegian	7879	Slovak	8375	Volapük	8679
Bihari	6672	Georgian	7565	Kirghiz	7589	Oriya	7982	Slovenian	8376	Welsh	6789
Breton	6682	German	6869	Korean	7579	Panjabi	8065	Spanish	6983	Wolof	8779
Bulgarian	6671	Greek	6976	Kurdish	7585	Pashto, Pushto	8083	Sudanese	8385	Xhosa	8872
Burmese	7789	Greenlandic	7576	Laotian	7679	Persian	7065	Swahili	8387	Yiddish	7473
Byelorussian	6669	Guarani	7178	Latin	7665	Polish	8076	Swedish	8386	Yoruba	8979
Chinese	9072	Gujarati	7185	Latvian, Lettish	7686	Portuguese	8084	Tagalog	8476	Zulu	9085

## Area Codes







Choose a area code from this list.

Area	Code	Area	Code	Area	Code	Area	Code	Area	Code	Area	Code
Afghanistan	AF	Costa Rica	CR	Greenland	GL	Maldives	MV	Paraguay	PY	Sri Lanka	LK
Argentina	AR	Croatia	HR	Hong Kong	HK	Mexico	MX	Philippines	PH	Sweden	SE
Australia	AU	Czech Republic	CZ	Hungary	HU	Monaco	MC	Poland	PL	Switzerland	CH
Austria	AT	Denmark	DK	India	IN	Mongolia	MN	Portugal	PT	Taiwan	TW
Belgium	BE	Ecuador	EC	Indonesia	ID	Morocco	MA	Romania	RO	Thailand	TH
Bhutan	BT	Egypt	EG	Israel	IL	Nepal	NP	Russian Federation	RU	Turkey	TR
Bolivia	BO	El Salvador	SV	Italy	IT	Netherlands	NL	Saudi Arabia	SA	Uganda	UG
Brazil	BR	Ethiopia	ET	Jamaica	JM	Netherlands Antilles	AN	Senegal	SN	Ukraine	uaw
Cambodia	KH	Fiji	FJ	Japan	JP	New Zealand	NZ	Singapore	SG	United States	US
Canada	CA	Finland	FI	Kenya	KE	Nigeria	NG	Slovak Republic	SK	Uruguay	UY
Chile	CL	France	FR	Kuwait	KW	Norway	NO	Slovenia	SI	Uzbekistan	UZ
China	CN	Germany	DE	Libya	LY	Oman	OM	South Africa	ZA	Vietnam	VN
Colombia	CO	Great Britain	GB	Luxembourg	LU	Pakistan	PK	South Korea	KR	Zimbabwe	ZW
Congo	CG	Greece	GR	Malaysia	MY	Panama	PA	Spain	ES		

## Troubleshooting

PROBLEM	CAUSE	CORRECTION
No power	The power cord is disconnected.	Plug the power cord into the wall outlet securely.
No picture	The TV is not set to receive the DVD signal.	Select the appropriate video input mode on the TV so the picture from the DVD Receiver appears on the TV screen.
	The video cables are not connected securely.	Connect the video cables securely to both the TV and DVD Receiver.
There is little or no sound	Equipment connected via the audio cable is not set to receive DVD signal output.	Select the correct input mode of the audio receiver so you can hear the sound from the DVD receiver.
	The audio cables are not connected to the speakers or receiver securely.	Connect the audio cables into the connection terminals correctly.
	The audio cables are damaged.	Replace with a new audio cable.
The DVD picture quality is poor	The disc is dirty.	Clean the disc using a soft cloth with outward strokes.
A DVD/CD will not play	No disc is inserted.	Insert a disc
	An unplayable disc is inserted.	Insert a playable disc (check the disc type, colour system and regional code).
	The disc is inserted upside down.	Place the disc with the label or printed side facing upwards.
	The menu is open on screen.	Press SETUP to close the menu screen.
	There is a parental lock which prevents the playback of DVDs with a certain rating.	Enter your password or change the rating level.
Humming noise heard while a DVD or CD is playing	The disc is dirty.	Clean the disc using a soft cloth with outward strokes.
	The DVD receiver is located too close to the TV, causing feedback.	Move DVD receiver and audio components further away from your TV.
Radio stations can't be tuned in properly	The antenna is positioned or connected poorly.	Check the antenna connection and adjust its position. Attach an external aerial if necessary.
	The signal strength of the radio station is too weak.	Tune to the station manually.
	No stations have been preset or preset stations have been cleared (when tuning by scanning preset channels).	Preset some radio stations, see page 15 for details.
The remote control doesn't work well / at all	The remote is not pointed directly at the DVD receiver.	Point the remote directly at the unit.
	The remote is too far from the DVD receiver.	Use the remote within 23 feet (7m) of the DVD receiver.
	There is an obstacle in the path between the remote control and the unit.	Remove the obstacle.
	The batteries in the remote control are flat.	Replace the batteries with new ones.

## Types of Playable Discs

Type	Logo
<b>DVD-VIDEO</b> : Discs such as movies that can be purchased or rented.	
<b>DVD-R</b> : Video mode and finalized only	
<b>DVD-RW</b> : Video mode and finalized only DVD VR format that have been finalized can not be played in this unit	
<b>DVD+R</b> : Video mode only Supports the double layer disc also	
<b>DVD+RW</b> : Video mode only	
<b>Audio CD</b> : Music CDs or CD-R/ CD-RW in music CD format that can be purchased.	

This unit plays DVD±R/ RW and CD-R/ RW that contains audio titles, DivX, MP3, WMA and/ or JPEG files. Some DVD±RW/ DVD±R or CD-RW/ CD-R cannot be played on this unit due to the recording quality or physical condition of the disc, or the characteristics of the recording device and authoring software.

“Dolby”, “Pro Logic”, and the double-D symbol are trademarks of Dolby Laboratories.  
Manufactured under license from Dolby Laboratories.

Manufactured under license under U.S. Patent #'s: 5,451,942; 5,956,674; 5,974,380; 5,978,762; 6,487,535 & other U.S. and worldwide patents issued & pending. DTS and DTS Digital Surround are registered trademarks and the DTS logos and Symbol are trademarks of DTS, Inc. © 1996-2007 DTS, Inc. All Rights Reserved.

HDMI, the HDMI logo and High-Definition Multimedia Interface are trademarks or registered trademarks of HDMI licensing LLC.

### About the Symbol Display

“” may appear on your TV display during operation and indicates that the function explained in this owner’s manual is not available on that specific DVD video disc.

### Regional Codes

This unit has a regional code printed on the rear of the unit. This unit can play only DVD discs labeled same as the rear of the unit or “ALL”.

- Most DVD discs have a globe with one or more numbers in it clearly visible on the cover. This number must match your unit’s regional code or the disc cannot play.
- If you try to play a DVD with a different regional code from your player, the message “Check Regional Code” appears on the TV screen.

### Copyrights

It is forbidden by law to copy, broadcast, show, broadcast via cable, play in public, or rent copyrighted material without permission. This product features the copy protection function developed by Macrovision. Copy protection signals are recorded on some discs. When recording and playing the pictures of these discs picture noise will appear. This product incorporates copyright protection technology that is protected by U.S. patents and other intellectual property rights. Use of this copyright protection technology must be authorized by Macrovision, and is intended for home and other limited viewing uses only unless otherwise authorized by Macrovision. Reverse engineering or disassembly is prohibited.

CONSUMERS SHOULD NOTE THAT NOT ALL HIGH DEFINITION TELEVISION SETS ARE FULLY COMPATIBLE WITH THIS PRODUCT AND MAY CAUSE ARTIFACTS TO BE DISPLAYED IN THE PICTURE. IN CASE OF 525 OR 625 PROGRESSIVE SCAN PICTURE PROBLEMS, IT IS RECOMMENDED THAT THE USER SWITCH THE CONNECTION TO THE ‘STANDARD DEFINITION’ OUTPUT. IF THERE ARE QUESTIONS REGARDING OUR TV SET COMPATIBILITY WITH THIS MODEL 525p AND 625p UNIT, PLEASE CONTACT OUR CUSTOMER SERVICE CENTER.

You have to set the disc format option to [Mastered] in order to make the discs compatible with the LG players when formatting rewritable discs. When setting the option to Live File System, you cannot use it on LG players.  
(Mastered/ Live File System : Disc format system for Windows Vista)

## Specifications

### General

Power supply	200 – 240V, 50/ 60Hz
Power consumption	70W
Net Weight	3.7 kg
External dimensions (W x H x D)	430 x 73 x 303 mm
Operating conditions Temperature	5°C to 35°C, Operation status: Horizontal
Operating humidity	5% to 85%
Laser	Semiconductor laser, wavelength 650 nm

### Tuner FM

FM Tuning Range	87.5 - 108.0 MHz
FM Intermediate Frequency	128 kHz

### Amplifier

Stereo mode	150 W + 150 W (4Ω at 1 kHz, THD 10 %)
Subwoofer*	200 W (3Ω at 30 Hz, THD 10 %)

### Speakers

	Front Speaker	Passive Subwoofer
Type	2 Way 3 Speaker	1Way1Speaker
Impedance	4 Ω	3 Ω
Rated Input Power	150 W	200 W
Max. Input Power	300 W	400 W
Net Dimensions (W x H x D)	300 x 1265 x 300 mm	216 x 405 x 360 mm
Net Weight	5.0 kg	7.3 kg

Designs and specifications are subject to change without prior notice.

