

Safety Precaution



CAUTION: TO REDUCE THE RISK OF ELECTRIC SHOCK DO NOT REMOVE COVER (OR BACK) NO USER-SERVICEABLE PARTS INSIDE REFER SERVICING TO QUALIFIED SERVICE PERSONNEL.



This lightning flash with arrowhead symbol within an equilateral triangle is intended to alert the user to the presence of uninsulated dangerous voltage within the product's enclosure that may be of sufficient magnitude to constitute a risk of electric shock to persons.



The exclamation point within an equilateral triangle is intended to alert the user to the presence of important operating and maintenance (servicing) instructions in the literature accompanying the product.

WARNING: TO PREVENT FIRE OR ELECTRIC SHOCK HAZARD, DO NOT EXPOSE THIS PRODUCT TO RAIN OR MOISTURE.

WARNING: Do not install this equipment in a confined space such as a book case or similar unit.

CAUTION: Do not block any ventilation openings. Install in accordance with the manufacturer's instructions.

Slots and openings in the cabinet are provided for ventilation and to ensure reliable operation of the product and to protect it from over heating. The openings should be never be blocked by placing the product on a bed, sofa, rug or other similar surface. This product should not be placed in a built-in installation such as a bookcase or rack unless proper ventilation is provided or the manufacturer's instruction has been adhered to.

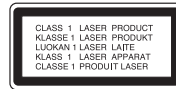

CAUTION: This product employs a Laser System.

To ensure proper use of this product, please read this owner's manual carefully and retain it for future reference. The unit require maintenance, contact an authorized service center. Use of controls, adjustments or the performance of procedures other than those specified herein may result in hazardous radiation exposure. To prevent direct exposure to laser beam, do not try to open the enclosure. Visible laser radiation when open. **DO NOT STARE INTO BEAM.**

CAUTION: The apparatus not be exposed to water (dripping or splashing) and no objects filled with liquids, such as vases, be placed on the apparatus.

CAUTION concerning the Power Cord

Most appliances recommend they be placed upon a dedicated circuit;

That is, a single outlet circuit which powers only that appliance and has no additional outlets or branch circuits. Check the specification page of this owner's manual to be certain.

Do not overload wall outlets. Overloaded wall outlets, loose or damaged wall outlets, extension cords, frayed power cords, or damaged or cracked wire insulation are dangerous. Any of these conditions could result in electric shock or fire.

Periodically examine the cord of your appliance, and if its appearance indicates damage or deterioration, unplug it, discontinue use of the appliance, and have the cord replaced with an exact replacement part by an authorized servicer. Protect the power cord from physical or mechanical abuse, such as being twisted, kinked, pinched, closed in a door, or walked upon. Pay particular attention to plugs, wall outlets, and the point where the cord exits the appliance.

To disconnect power from the mains, pull out the mains cord plug. When installing the product, ensure that the plug is easily accessible.

This device is equipped with a portable battery or accumulator.

Safe way to remove the battery or the battery from the equipment:

Remove the old battery or battery pack, follow the steps in reverse order than the assembly. To prevent contamination of the environment and bring on possible threat to human and animal health, the old battery or the battery put it in the appropriate container at designated collection points. Do not dispose of batteries or battery together with other waste. It is recommended that you use local, free reimbursement systems batteries and accumulators.

The battery shall not be exposed to excessive heat such as sunshine, fire or the like.





Disposal of your old appliance

1. When this crossed-out wheeled bin symbol is attached to a product it means the product is covered by the European Directive 2002/96/EC.
2. All electrical and electronic products should be disposed of separately from the municipal waste stream via designated collection facilities appointed by the government or the local authorities.
3. The correct disposal of your old appliance will help prevent potential negative consequences for the environment and human health.
4. For more detailed information about disposal of your old appliance, please contact your city office, waste disposal service or the shop where you purchased the product.



ENGLISH

Contents

 Setting up	3
Main unit	3
Remote control	4
 Listening to CDs	5
Listening to the radio	5-6
Listening to music from your external device	6
Using an USB device	6
Setting the Clock	7
Enjoying a pre-programmed sound field	7
Recording to USB	8
 Troubleshooting	9
Specifications	9

The making of unauthorized copies of copy-protected material, including computer programs, files, broadcasts and sound recordings, may be an infringement of copyrights and constitute a criminal offense. This equipment should not be used for such purposes.

Be responsible
Respect copyrights

*VOLUME Adjustment



Move your finger around the touch wheel.

Precautions in using the touch buttons

- Use the touch buttons with clean and dry hands. In a humid environment, wipe out any moisture on the touch buttons before using.
- Do not press the touch buttons hard to make it work. If you apply too much strength, it can damage the sensor of the touch buttons.
- Touch the button that you want to work in order to operate the function correctly.
- Be careful not to have any conductive material such as metallic object on the touch buttons, and it can cause malfunctions.

Before connecting, operating or adjusting this product, please read this instruction booklet carefully and completely.

Setting up

1 Connection of the front speakers

Connect the speaker cables to the speaker terminals. Connect the black end of each wire to the terminals marked - (minus) and the other end to the terminals marked + (plus).

2 Fit the AM loop aerial to its stand (AM optional)

Connect the AM loop aerial to the unit.

3 Connect the FM aerial

The reception will be at its best when the two loose ends of the aerial are in a straight line and horizontal.

4 Plug the power plug into a wall socket

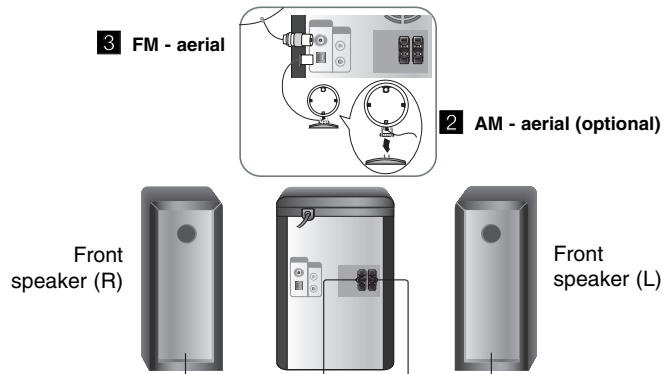

NOTES:

- If TV screen becomes discolored do not place speakers within 30cm from TV.
- Be sure to match the speaker cord to the appropriate terminal on the components: + to + and - to -. If the cords are reversed, the sound will be distorted and will lack base.

Be careful of the following

Be careful to make sure children not to put their hands or any objects into the *speaker duct.

*speaker duct : A hole for plentiful bass sound on speaker cabinet(enclosure).

3

Main unit

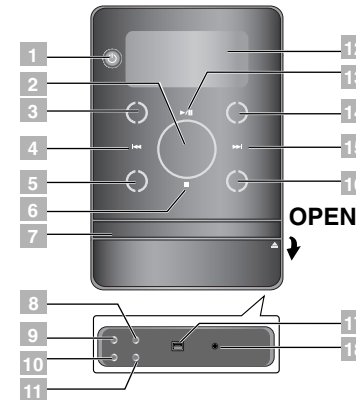

1. Power on/ off
2. **VOLUME**
Controls the volume when using any function.
3. **FUNC.**
Changes the functions
4. (SKIP)
TUN. (-) (TUNER)
5. **USB REC.**
Recording to USB
6.
Stops playback or recording
7. **DISC TRAY**
8. **EQ master/ DEMO** button
9. **CLOCK**
For setting the clock and checking the time.
10. **TIMER**
With the TIMER function you can turn CD, USB play and TUNER reception on or off at a desired time.
11. **SET/ RDS(OPTIONAL)**
Confirms the time you have selected when setting the clock.
12. **Display window**
13. **PLAY/PAUSE**
MO./ ST. (MONO/ STEREO)
14. **XDSS plus**
(Extreme Dynamic Sound System)
Reinforce the treble, bass and surround effect.
MP3 Opt.
Optimizes compressible MP3 files so that it improves the bass sound.
15. (SKIP)
TUN. (+) (TUNER)
16. (OPEN/ CLOSE)
17. **USB connector**
18. **PHONES**
(Headphone jack : \varnothing 3.5mm)

Remote control

	POWER on/ off
SLEEP	Fall asleep while listening to your unit Press SLEEP one or more times to select delay time between 10 and 180 minutes.
INFO	See information about your music. MP3/ WMA files often come with tags. The tag gives the Title, Artist, Album or Time information.
REPEAT /RANDOM	Listen to your tracks repeatedly or randomly.
	Selects the radio station. Searchs for a section within a track. Skips Fast backward or Forward.
	Starts or pauses playback (MONO/ STEREO)
	Stops playback or recording
RDS/ PTY (optional)	RDS (Radio Data System) Searchs radio stations by radio type
	Recording button
F (FUNCTION)	Changes the functions.
EQ	Sound quality adjustment You can choose sound impressions.
LG EQ	You can select a Natural or Local Specialization equalizer effect by using LG EQ.
	Searchs for a folder of MP3/ WMA files When a CD containing MP3/ WMA files in several folders is being played, press FOLDER•PRESET selects the folder you want to play. Choose a 'preset number' for a radio station.
VOL	Controls the volume when using any function.
PROGRAM/ MEMO.	For storing radio stations If you have saved radio stations using PROGRAM/MEMO. , you can scroll through them and select one. Listens to your tracks in any order
	Temporarily stop the sound Press the button again to return to the sound.



Put the battery into the remote control

Make sure for the + (plus) and - (minus) on the battery to be matched on the remote control. (size AAA)

Listening to CDs

Audio CD and MP3/ WMA CD can be played back in this unit.

	ON UNIT	ON REMOTE
1. Open the CD door	▲	-
2. Insert the CD: Label facing up.	-	-
3. Close the CD door	▲	-
4. Select the CD function: The display will show the total number of tracks (files).	FUNC.	FUNCTION
5. Start the CD playing	▶/	▶/
6. To stop a CD playing	■	■

Listening to CDs - More you can do

Searching for a section within a track

Hold **I◀◀/▶▶** on the unit or **I◀◀/▶▶** on the remote control during playback and release it at the point you want to listen to.

Program list

You can play up to 20 tracks on a CD in order.

- 1 Insert a CD and wait for it to be read.
- 2 Press **PROGRAM/MEMO.** on the remote control in stop status.
- 3 Press **I◀◀/▶▶** on the unit or **I◀◀/▶▶** on the remote control to select a track.
- 4 Press **PROGRAM/MEMO.** again to save and select a next track.
- 5 Press **▶/||** to play the programmed music files.
- 6 To clear your selection, press **■**, **PROGRAM/MEMO.** and then **■**.

About MP3/ WMA

MP3/WMA Disc compatibility with this unit is limited as follows:

- Sampling Frequency : 32 - 48 kHz (MP3), 32 - 48 kHz (WMA)
- Bit rate : 32 - 320 kbps (MP3), 40 - 320 kbps (WMA)
- CD-R physical format should be "ISO 9660/ JOLIET"
- If you record MP3/WMA files using the software which cannot create a FILE SYSTEM, for example "Direct-CD" etc., it is impossible to playback MP3 files. We recommend that you use "Easy-CD Creator", which creates an ISO 9660 file system.
- Do not use special letters such as "/: * ? " < >" etc.
- Even if the total number of files on the disc has more than 1000, it will only be shown up to 999

Listening to the radio

Make sure both the FM and AM (optional) aerials are connected.

	ON UNIT	ON REMOTE
1. Select either FM or AM (optional)	FUNC.	FUNCTION
2. Select the radio station	I◀◀/▶▶	TUN- / TUN+
3. To 'save' a radio station: A preset number will show in the display.	-	PROGRAM/MEMO.
4. Select the preset number	-	FOLDER*PRESET
5. To confirm press: Up to 50 radio stations can be saved.	-	PROGRAM/MEMO.
6. To select a 'saved' station	-	FOLDER*PRESET

Listening to the radio - More you can do

Looking for radio stations automatically

- 1 Press and hold **I◀◀/▶▶** on the unit or **TUN- / TUN+** on the remote control for more than 0.5 second.
- 2 The tuner will scan automatically and stop when it finds a radio station.

Deleting all the saved stations

- 1 Press and hold **PROGRAM/MEMO.** on the remote control for two seconds. "ERASE ALL" shows.
- 2 Press **PROGRAM/MEMO.** on the remote control to erase all the saved stations.

Improving poor FM reception

Press **▶/||** (MONO/STEREO) on the remote control. This will change the tuner from stereo to mono and usually improve the reception.

See information about your radio stations - OPTIONAL

The FM tuner is supplied with the Radio Data System (RDS) facility. This shows the letters **RDS** on the display, plus information about the radio station being listened to. Press **RDS** on the remote control several times to view the information.

PTY - Programme Type, such as News, Sport, Jazz.

RT - Radio Text, the name of the radio station.

CT - Time Control, the time at the location of the radio station.

PS - Programme Service name, the name of channel.

You can search the radio stations by programme type by pressing **RDS**. The display will show the last PTY in use. Press **PTY** one or more times to select your preferred programme type. Press and hold **◀◀/▶▶**. The tuner will search automatically. When a station is found the search will stop.

Listening to music from your external device

The unit can be used to play the music from many types of external device.

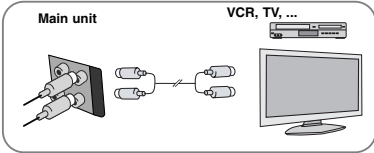
	ON UNIT	ON REMOTE
<p>1. Connect the external device to the AUX IN connector of the unit. > If your TV has only one output for audio(MONO). connect it to the left(white) audio jack on the unit.</p> 	-	-
2. Turn the power on.	⏻	⏻
3. Select the AUX function.	FUNC.	FUNCTION
4. Turn on the external device and start it playing.	-	-

Using an USB device

You can enjoy media files saved on an USB device by connecting the USB device to the USB port of the unit. If you want to operate other function, see the CD playback section.

	ON UNIT	ON REMOTE
1. Connect the USB device to the USB port of the unit.	-	-
2. Select the USB function.	FUNC.	FUNCTION
3. Select a file you want to play.	-	-
4. Start your media playing.	▶/	▶/
5. To stop, press	■	■
6. Before disconnecting the portable USB device, change to any other function.	FUNC.	FUNCTION

Compatible USB Devices

- MP3 Player : Flash type MP3 player.
- USB Flash Drive : Devices that support USB 2.0 or USB 1.1.
- The USB function may not be available depending on devices.

USB device requirement

- Devices which require additional program installation when you have connected it to a computer, are not supported.

Look out for the follows.

- **Do not extract the USB device while in operation.**
- For a large capacity USB, it may take longer than a few minute to be searched.
- To prevent data loss, back up all data.
- If you use a USB extension cable or USB hub, the USB device is not recognized.
- Using NTFS file system is not supported. (Only FAT(16/ 32) file system is supported.
- This unit is not supported when the total number of files is 1000 or more.
- External HDD, Locked devices or hard type USB devices are not supported.
- USB port of the unit can not be connected to PC. This unit can not be used as a storage device.

Setting the Clock

	ON UNIT
1. Turn the power on	
2. Press for at least 2 seconds	CLOCK
3. Choose from either: AM 12:00 (for an am and pm display) or 0:00 (for a 24 hour display).	
4. Confirm your selection	SET
5. Select the hours	
6. Press	SET
7. Select the minutes	
8. Press	SET

Using your player as an alarm clock

- Turn the power on.
- Press and hold **TIMER**. Each function, EX) TUNER, CD.... flashes.
- Press **SET** when the function you want to be woken by is showing.
- Choose one of them by pressing **SET**.
- "ON TIME" will be displayed. Then you can set the time you want the alarm to go on. Press to change the hours and minutes and **SET** to save.
- "OFF TIME" will be displayed. Then, you can set the time you want the function to stop. Press to change the hours and minutes and press **SET** to save.
- You will be shown the volume (VOL) you want to be woken by. Use to change the volume and **SET** to save. The clock icon "" shows that the alarm is set.
- Press **TIMER** button 2times. You can check the setting status.

Notes:

- If you set the clock time, you can check the time by pressing **CLOCK** even when the player is turned off.
- If you set the clock time and alarm, you can check the alarm icon "" by pressing **CLOCK** even when the player is turned off.

DIMMER

Press **SLEEP** once. The LED (Light-emitting diode) of front panel is turned off and the display window will be darkened by half. To cancel it, press **SLEEP** repeatedly until dim off.

Enjoying a pre-programmed sound field

This system has a number of pre-set surround sound fields. You can select a desired sound mode by using **EQ/ LG EQ/ EQ master**. The displayed items for the Equalizer may be different depending on sound sources and effects.

ON DISPLAY	Description
NATURAL	You can enjoy comfortable and natural sound.
Local Specialization equalizer	Regionally optimized sound effect.(DANGDUT/ ARABIC/ PERSIAN/ INDIA/ REGUETON/ MERENGUE / SALSA/ SAMBA)
AUTO EQ	Realizes the sound equalizer that is the most similar to the genre of which is included in the MP3 ID3 tag of song files.
POP CLASSIC JAZZ ROCK	This program lends an enthusiastic atmosphere to the sound, giving you the feeling you are at an actual rock, pop, jazz or classic concert.
MP3 Opt.	This function is optimized for compressible MP3 file. It improves the bass sound.
XDSS (ON)	Reinforce the treble, bass and surround sound effect.
VIRTUAL	You can enjoy moe virtual surround sound.
NORMAL(OFF)	You can enjoy the sound without equalizer effect.

Recording to USB

You can record a various sound source to USB.

	ON UNIT	ON REMOTE
1. Connect the USB device to the unit.	-	-
2. Select a mode in which you want to record. Play back a sound source first.	FUNC.	FUNCTION
3. Start the recording.	USB REC.	● REC
4. To stop recording, press	■	■

Recording to USB - More you can do

Recording Music file in disc source to USB

One track recording -

If the USB recording is started during playback of the CD, the one track/ file would be recording into the USB.

All tracks recording -

If the recording button is pressed at the CD stop, all tracks/ files would be recording.

Program list recording -

USB records after creating your own program if you want to record the track you want.

Pausing recording

During recording, press **USB REC.** to pause recording. Press **● REC** to continue recording. (Only Radio/ AUX)

To select recording bit rate and speed

- 1 Press **USB REC.** on the player or **● REC** on the remote control for longer than 3 seconds.
- 2 Use **◀ / ▶** on the player or **◀ / ▶** on the remote control to select the bit rate.
- 3 Press **USB REC.** or **● REC** again to select the recording speed.

4 Use **◀ / ▶** or **◀ / ▶** to select a desired recording speed.

X 1 SPEED (96kbps, 128kbps, 192kbps, 256kbps)

- You can listen to music while recording it. (Audio CD Only)

X 2 SPEED (96kbps, 128kbps)

- You can just recording the music file. (Audio CD Only)

5 Press **USB REC.** or **● REC** to finish the setting.

When you are recording, look out for the following

- You can check the recording percentage rate for the USB record on the screen during the recording. (MP3/ WMA CD only)
- During recording MP3/ WMA, there is no sound.
- When you stop recording during playback, the file that has been recorded at that time will be stored.(Audio CD only)
- Do not remove the USB device or turn off the unit during USB recording. If not, an incomplete file may be made and not deleted on PC.
- If USB recording does not work, the message like "NO USB", "ERROR", "USB FULL" or "NO REC" is displayed on the display window.
- For the discs recorded in the format of DTS disc, USB recording is not supported.
- Multi card reader device or External HDD can not be used for USB recording.
- A file is recorded by 128Mbyte when you record for a long term.
- When you stop recording during playback, the file will not be stored.
- In the state CD-G, DTS disc USB record is not operated.
- You may not record more than 999files.
- **It'll be stored as follows.**

AUDIO CD	MP3/ WMA	The other sources
■ CD_REC TRK 001 TRK 002 	■ FILE_REC (File name) (File name) 	■ EXT_REC AUDIO_001 AUDIO_002

Troubleshooting		
Symptom	Cause	Correction
General		
No power.	The power cord is not plugged in.	Plug in the power cord.
	Check whether electricity failed.	Check the condition by operating other electronic devices.
No sound.	Check whether you select right function.	Press FUNCTION and check the selected function.
CD		
The unit does not start playback.	An unplayable disc is inserted.	Insert a playable disc.
	The disc is dirty.	Clean the disc.
RADIO		
Radio stations cannot be tuned in.	The antenna is positioned or connected poorly.	Connect the antenna securely.
Remote control		
The remote control does not work properly.	The remote control is too far from the unit.	Operate the remote control within about 23 ft (7 m).
	There is an obstacle in the path of the remote control and the unit.	Remove the obstacle.
	The battery in the remote control is exhausted.	Replace the battery with new one.

Specifications	
General	
Power supply	Refer to main label.
Power consumption	Refer to main label.
Net Weight	3.1 kg
External dimensions (WxHxD)	170 x 228 x 250 mm
Operating temperature	5 °C to 35 °C
Operating humidity	5% to 85 %
Tuner	
FM Tuning Range	87,5 - 108,0 MHz or 87,50 - 108,00 MHz
AM Tuning Range (optional)	522 - 1620 kHz or 522 - 1710 kHz or 520 - 1710 kHz
Amplifier	
Output Power	30 W + 30 W
T.H.D	0.7 %
Frequency Response	60 - 20000 Hz
Signal-to-noise ratio	75 dB
CD	
Frequency response	40 - 20000 Hz
Signal-to-noise ratio	75 dB
Dynamic range	80 dB
Speakers (FAS64F)	
Type	2 Way 2 Speaker
Impedance	4 Ω
Rated Input Power	30 W
Max. Input Power	60 W
Net Dimensions (WxHxD)	128 x 234 x 240 mm
Net Weight (1EA)	2.2 kg

Designs and specifications are subject to change without notice.

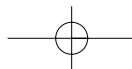
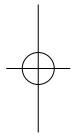
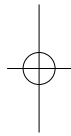
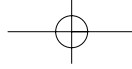



	Телефон	Режим работы	Интернет
Россия	8-800-200-7676	Круглосуточно	http://www.lg.com
Беларусь	8-820-0071-1111		
Латвия	8-0003-271		
Литва	8-800-30-800		
Эстония	800-9990		
Украина	0-800-303-000	8:00 - 21:00 (Пн.-Пят.) 9:00 - 18:00 (Суб., Вс.)	
Казахстан	8-8000-805-805	9:00 - 18:00 (Пн.-Пят.) 9:00 - 18:00 (Суб.)	
	2255 (для мобильных телефонов)		
Кыргызстан	8-0000-710-005	Круглосуточно	
Узбекистан			