

Model	VC1014NND		
Language	Chinese+English		
Page	20	Color(cover/body)	4/2
Material	128g铜板/100g 胶版	Size(W*H)	150X220(mm)
Date	2010.11.17	Designer	Nie Lin
Part No.	MFL67021704	Description	Owner's manual

Chage Record

No.	Change content	ECO No.	Date	Designer	Confirm
①	Change the product sepecifications and delete the hose holder according to QA group's request .	ACTT008754	10.12.01	Nie Lin	CYT
②					
③					
④					
⑤					
⑥					
⑦					
⑧					
⑨					

使用说明书

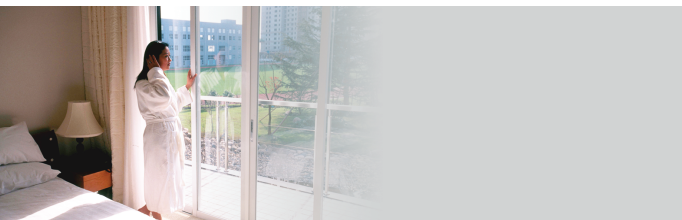

吸尘器

强劲吸力

VC1014NND

中文 → 1-10 页
English → Page 11-19

售后服务电话



使用前请仔细阅读说明书，阅读完后请妥善保管以备需要时查阅。

目录

产品规格	2
使用前注意事项	3-4
吸尘器的组装与吸力调节	5
部分名称与连接方法	
附件	
吸力调节	
各种附件刷头的使用及清洁方法	6
毛刷、尖吸嘴、鸭嘴的使用	
地板地毯刷头使用及清洁方法	
集尘桶/电机保护过滤海绵的拆卸、清洗及安装方法	7
机器的正确保管	8
故障通告前需确认事项	8-9
装箱单	10

产品规格

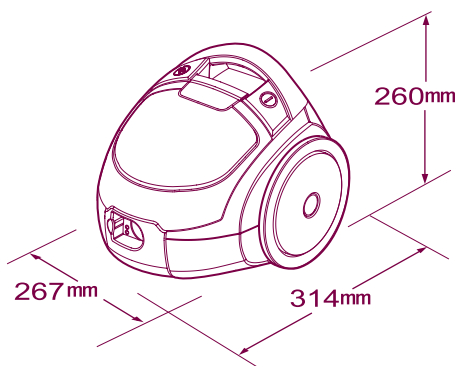

型号: VC1014NND

额定电压: 220V~50Hz

额定功率: 1200W

最大功率: 1400W

吸率: 220W

净重: 4.0KG

外形尺寸: 314mmX267mmX260mm

本产品执行标准: GB4706.1-2005

GB4706.7-2004

GB17625.1-2003

GB4343.1-2009

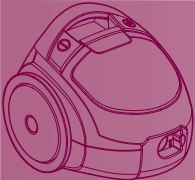

※ 为了提高产品质量而进行的外观及设计规格上的变更将不再另行通知。



使用前注意事项

使用前注意事项

忽视说明而导致的错误操作将会对您造成不同程度的损害，请认真阅读以下提示说明。

-  **危险** 此标识表明违反标记事项时，会立刻发生严重伤害或死亡现象。
-  **警告** 此标识表明违反标记事项时，有可能发生严重伤害或死亡现象。
-  **注意** 此标识表明违反此标记事项时，有可能发生财产损失或轻微伤害。

危险

请不要在易燃液体附近使用吸尘器，以免发生火灾。



插拔电源插头时，请先关闭电源开关，以免发生火灾或触电的危险。请不要用湿手触摸电源插头，以防触电。更不能在手指接触插头上金属部分的时候插拔电源线插头。（不要在220V以外的电源上使用产品）



警告

15A以上的电流请单独使用插线板，在一个插线板上同时使用多种电器可能会引发火灾。建议不要使用电源线延长线，以免引起不必要的危险。本吸尘器最大电流为6A。



请不要让大头钉等金属物存留在软管、机体延长管内。

请不要吸入头发团、大纸团等物品，否则容易堵塞软管，如有堵管现象，请及时清理。

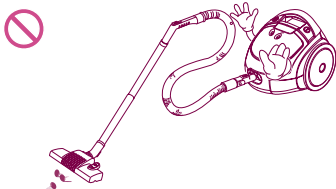

长时间不使用电器时，请记住拔掉电源插头。正处于通电时，请您不要离开。



为避免发生火灾或触电的危险，在清扫。在清扫时，注意不要让机体吸入液体、刀片、火种以及火泥、石膏粉等小微粒。

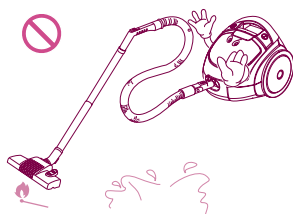

使用前注意事项

警告

请不要让电源线与吸尘器接近电暖器等热源，以免使机体变形或发生火灾。请您不要使用破损的电源和插头，如有破损，必须由指定维修站更换。

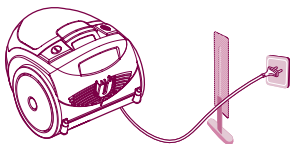

请不要弯曲、践踏、拉拽软管，如软管受损，请不要继续使用。请不要用重物或尖锐物压线。

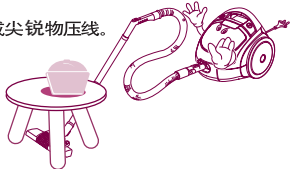

请不要在吸入口和排气口堵塞时，继续长时间运作，否则可能造成机体变形或损坏。

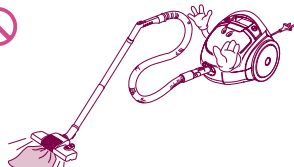

非专业维修人员请勿开机修理。

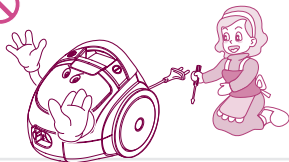

注意

使用过程中，延长管和机体有产生静电的可能，请您使用时注意。

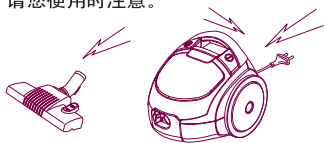

注意不要使电源线夹在门缝里或用电源线提拉吸尘器，防止电源线受损。请不要经常弯曲电源线或只抓住电源线来拔插头。

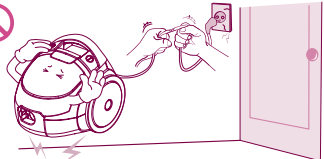

收卷电线时，请拿住电源插头后再按动卷线器按钮。

请不要将电源线拉至红色警告线以外，否则可能损坏电源线或不能回卷。

收线时请注意插头，以免损坏周围物品。



请不要让儿童把吸尘器及组件，如延长管等当做玩具，以防止意外。



集尘桶集满至Max线后请及时清理，请您正确开启集尘桶清理。请您注意不要在没安装集尘桶或过滤海绵网时使用吸尘器。

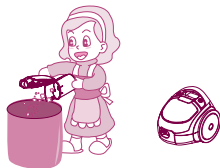

请您注意保护自身安全，使身体各部位远离吸尘器吸口或活动部位。



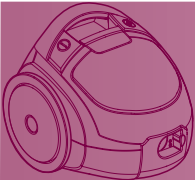

吸尘器的组装与吸力调节

吸尘器的组装

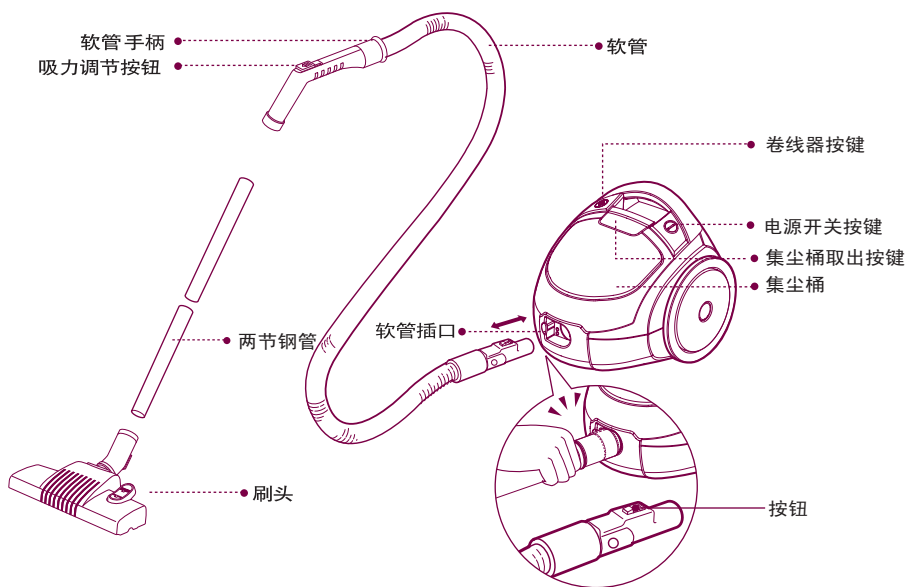

附件



毛刷



尖吸嘴



鸭嘴



地板地毯刷头



两节钢管



软管

吸力调节

请按图示使用

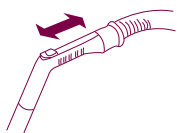

软管手柄处有一个手动的可控制气流的吸力调节按钮，使您可以简单方便地调节吸力大小。

各种附件刷头的使用方法

毛刷、尖吸嘴、鸭嘴的使用

请按图示使用

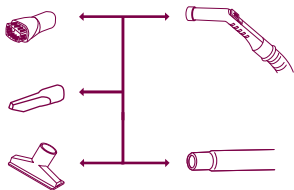

使用方法



- ▶ 鸭嘴是用来对饰物、床垫等物品进行吸除的。
- ▶ 毛刷用于吸扫画框、家具边沿、书籍和其它不规则的表面。
- ▶ 尖吸嘴是用来吸扫一般不容易接触的地方，如有蜘蛛网的地方或沙发垫子之间的缝隙等。

地板地毯刷头使用方法

▶ 一般情况下使用

适用性

- 适用于瓷砖，木地板等硬地环境和地毯，毯子等软物质环境。

使用方法

- 根据清洁地板类型，改变刷头踏板位置，满足您的不同需要，给您带来更多方便。

⚠ 注意：当在硬地板（瓷砖，水泥地，木地板等）上使用时，请务必按住踏板，放出刷子，当地毯上使用，收回刷子即可。

组合

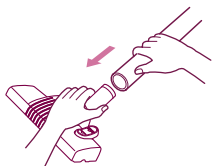

使用

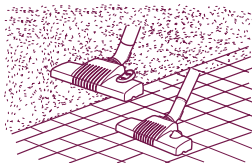

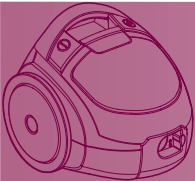

集尘桶/电机保护过滤海绵的拆卸、清洗及安装方法

当吸尘器设在最大功率时，如吸嘴不能正常工作，则需要清理集尘桶，并清洗电机保护过滤海绵。

集尘桶的拆装及清洗方法

- ▶ 关闭电源，拔下插头，按下集尘桶取出按键。
- ▶ 按住集尘桶盖打开按键，翻开集尘桶盖。手提集尘桶手柄，从机体内取出集尘桶。

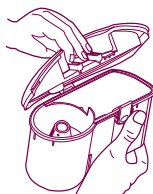
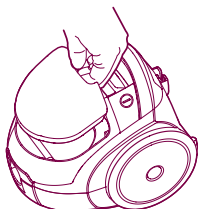

- ▶ 倾倒入集尘桶里面的灰尘后，用冷水清洗集尘桶，打开桶盖放置在阴凉处风干。扣好集尘桶盖后，如箭头所示方向装入机体。

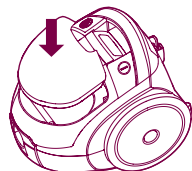
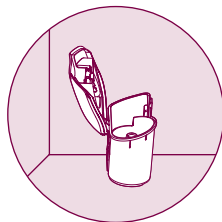

电机保护过滤海绵的拆装及清洗方法

- ▶ 按照箭头所示方向从机体内取出电机保护过滤海绵。请至少每月清洗一次，或根据使用频率酌情处理。每次清洁集尘桶的同时，建议同时清洗过滤海绵，并放置在阴凉处风干后装入机体。

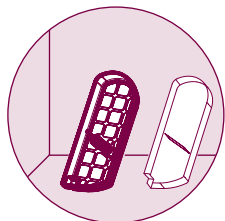
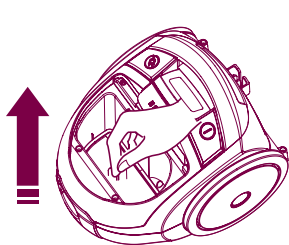

机器的正确保管/故障通告前需确认事项

机器的正确保管

- ▶ 拔掉插头，按下卷线器按钮，收起电源线。
- ▶ 当储存吸尘器时，应使用放置槽。

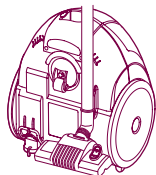
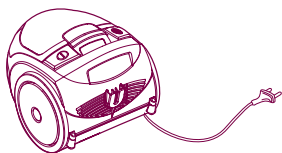

* 如电源线不能完全收回机体内时，请按下卷线器按钮，拉出一部分线后再重新收回。

故障通告前请先确认

- ▶ 如果您怀疑产品发生故障，请先确认故障发生原因，再与售后服务中心或代理商联系，以确保检修的效率。

故障	检查	措施
吸尘器为何不能工作? 	<ul style="list-style-type: none">● 电源插头是否插上?● 电源插座有电吗?● 软管是否插上?● 电机热保护处于开启期间。	<ul style="list-style-type: none">● 请将电源插牢(本产品适用于220V电压)。● 确认插座是否有电。● 将软管插牢。● 2小时后重新启动。
机体内有噪音。 	<ul style="list-style-type: none">● 吸尘器吸力过大或电机高速运转时所发出的声音，不属于异常情况，请正常使用。● 如果不是正常的电机响声，而是异常的噪音，请打电话与维修中心联系。	<ul style="list-style-type: none">● 集尘桶已满。● 电机保护过滤海绵堵塞。● 吸入口阻塞。● 两节钢管阻塞。● 软管阻塞。
机体出现异味。 	<ul style="list-style-type: none">● 电机运作时，用于固定电机的橡胶圈会受热而产生少量气味，不会影响运作或使机器发生损坏。● 机器不小心吸入一些水或集尘桶长期不清理时，会有一些异味排出，此时应及时清理集尘桶。	<ul style="list-style-type: none">● 清理集尘桶。● 用水冲洗后放置于阴凉处风干一天。● 将吸入的异物取出后再使用。● 将两节钢管内异物取出后再使用。● 将软管内异物取出后再使用。
电源线不能全部卷入机体，电源线不能全部拉出。 	<ul style="list-style-type: none">● 将电源线拉出一部分后重新卷入。● 请用力将电源线拉出，不会损坏电源线。● 由于线在内部互相缠绕或夏季周围温度过高所致。● 由于线在内部折曲或未缠在卷线器上，启动卷线器后，能正常运作。	
机体或排出的气体过热。 	<ul style="list-style-type: none">● 吸力是否正常?	<ul style="list-style-type: none">● 从机体内排出的热气，是由电机导热产生的热量所致，属正常温度，请继续使用。
软管内壁过脏。 	<ul style="list-style-type: none">● 请勿将水吸入，水与灰尘混合吸入后，有可能弄脏管壁。	

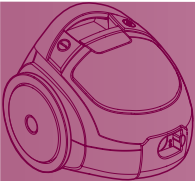

故障通告前需确认事项

故障通告前请先确认

- ▶ 如果您怀疑产品发生故障，请先确认故障发生原因，再与售后服务中心或代理商联系，以确保检修的效率。

现象:

噪音加大
软管收缩



吸力忽然
下降

吸尘器求助:

请检查集尘桶
和吸入口



处理要领

- ① 查看集尘桶灰尘是否集满（到达MAX处），如果是，请及时清理集尘桶。



已经满了吗？请及
时清理集尘桶哦！

- ② 请确认电机保护过滤海绵是否堵塞
过滤海绵堵塞时会发出异常声，请及时清洗。



过滤海绵有问题吗？
那么检查一下吸入口。

- ③ 检查吸入口时，需将吸力调节到最大。

第一步

将两节钢管与刷头分离后，检查有无阻塞，如发现问题请立即清理。



如果还有问题，
请进行第二步。



第二步

分离手柄与两节钢管，检查有无阻塞，如有阻塞，请将两节钢管收短，清除异物。



如果还有问题，
请进行第三步。



第三步

检查软管是否阻塞，将吸力调至最强，用手堵放管口，反复几次。

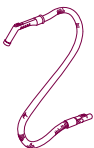

如果还有问题，
请清理一下过滤
海绵。



装箱单

装箱单

吸尘器	一台
说明书	一本
鸭嘴	一个
毛刷	一个
尖吸嘴	一个
软管	一根
钢管	两根
地板地毯刷头	一个
保修卡	一份

Table of contents

Product specifications	11
Attention before using the appliance	12-13
Assembling and adjusting the Cleaner	14
Parts description and assembly	
Accessories	
Adjusting the cleaner	
Using and cleaning method of all the accessory nozzles	15
Using Upholstery Nozzle & Dust Brush & Crevice Tool	
Using and cleaning method floor-carpet nozzle	
How to separate, clean and assembly the dust tank and the motor protection filter ..	16
How to keep the vacuum cleaner	17
Check before reporting the trouble	17-18
Packing List	19

Product specifications

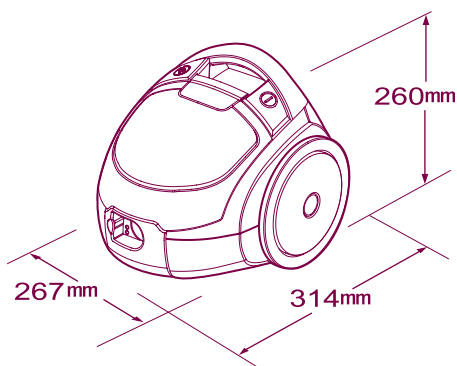

Model: VC1014NND
Voltage rating : 220V~50Hz
IEC : 1200W
Max : 1400W
Suction power : 220W
Net weight: 4.0KG
Dimension: 314mmX267mmX260mm
This appliance complies with the following
GB directives: GB4706.1-2005
GB4706.7-2004
GB17625.1-2003
GB4343.1-2009

※ You will not be informed if any changes in appearance and standard deriving for improvement of product quality.

Attention before using the appliance

Attention before using the appliance

Please read all the following information, which contains important instructions for the safety, the use of the appliance.



DANGER

May immediately cause serious injury or death.



WARNING

May possibly cause serious injury or death.



ATTENTION

May possibly cause losses of property or light injury.



DANGER

Do not pick up anything that is burning or smoking, such as cigarettes, matches or hot ashes.

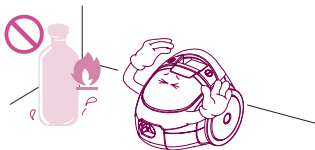

Please turn off the power before pulling out the plug to prevent fire or electric shock. Never handle plug or appliance with wet hands. Do not put the finger on the metal position of plug when plugging into. (Do not use the appliance on the power above 220V.)



WARNING

Independently use a socket when the current is $\geq 15A$. It may cause fire when many electric appliances share one socket. In order to avoid the needless danger, you had better not use the prolonged thread of power cord. The current at most 6A is allowed.

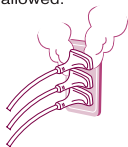

Avoid picking up hard, sharp objects with the cleaner. They may damage the cleaner and the tank.

Do not vacuum the objects like hair ball or big paper ball, otherwise the hose is possibly blocked up. Please clear the hose in time when it is blocked.

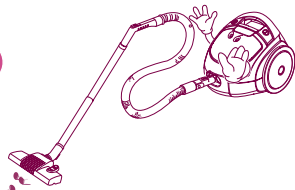

Unplug cleaner when not in use. Turn off all controls before unplugging.



To avoid the danger of fire or electric shock, do not vacuum liquid, blade, flammable substances, or small particles like cement and gesso in cleaning.



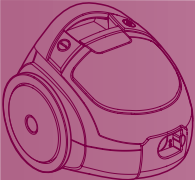

Attention before using the appliance

! WARNING

Do not let the power cord near the electric heater or other heat source, lest that the cleaner should be deformed or it should cause fire. Do not use the appliance when the power cord or plug is damaged.

The damaged power cord or plug must be replaced in the approved service station.



Do not bend, stamp on, or drag the hose. Do not continue to use the hose if it is damaged. Do not use any heavy or sharp object to press the power cord.

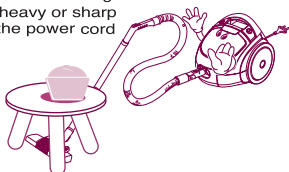

Do not operate the appliance for long when the nozzle inlet or nozzle outlet is blocked, which may have it deformed or damaged.

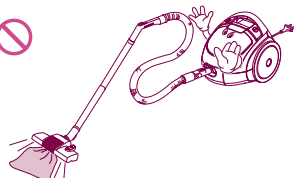

Do not allow the non-professional maintenance people to repair.

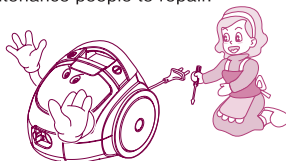

! ATTENTION

In using the appliance, pay attention to the electrostatic effect generated on the telescopic tube and cleaner body.

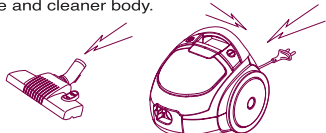

Do not pull or carry by cord, use cord as a handle, close door on cord or pull cord around sharp edges or corners. Do not run appliance over cord. Keep cord away from heated surfaces.

And do not bend power cord continually or only grasp it when removing the plug from socket.

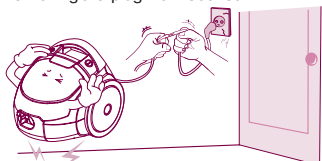

In winding the power cord, hold the plug before pressing the button of the cord reel. Do not pull the power cord beyond the red warning line, otherwise the power cord may be damaged or unable to be wound up. Pay attention to the plug in winding the cord to avoid damaging the surrounding objects.

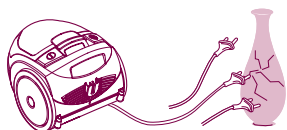

Close supervision is necessary when any appliance is used by or near children. Do not allow vacuum cleaner to be used as a toy or to run unattended at any time.



Empty and clean dust tank when the dust arrive at Max line.

Do not use without dust tank or filters in place. Clean the tank frequently when picking up very fine materials such as powder.



Keep hair, loose clothing, fingers, feet and all parts of body away from the nozzle or movable portion.

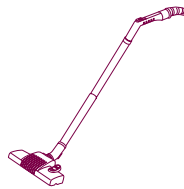

Assembling and adjusting the Cleaner

Parts description and assembly

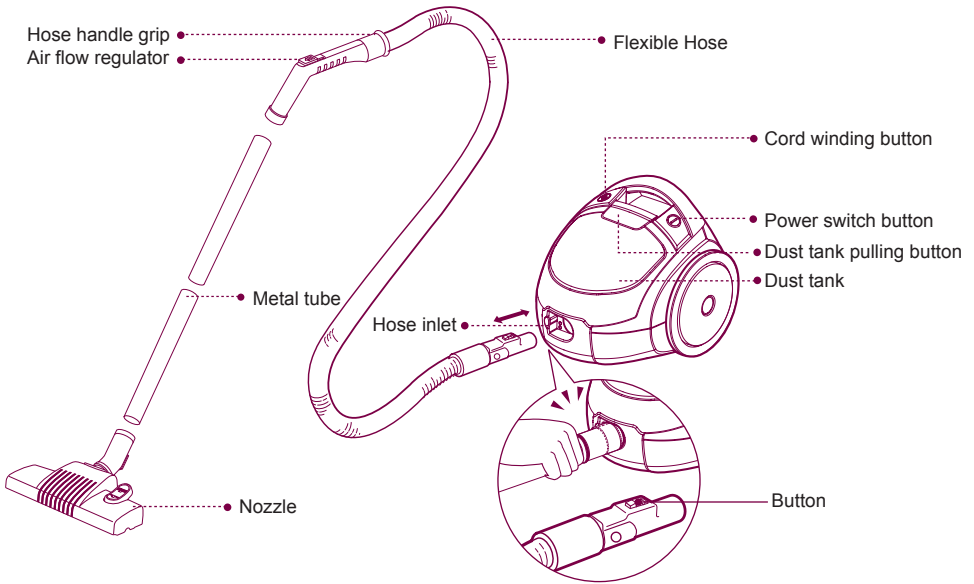

Accessories						
	Dust Brush	Crevice Tool	Upholstery Nozzle	Floor-carpet Nozzle	Metal Tube	Flexible Hose

Adjusting the Cleaner

Use it as shown in the diagram

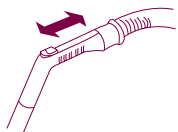

The flexible hose handle has a manual air flow regulator which allows you to briefly reduce the suction level.

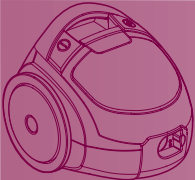

Using method of all the accessory nozzles

Using Upholstery Nozzle & Dust Brush & Crevice Tool

Use it as shown in the diagram

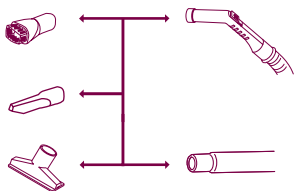

Using method



- ▶ Upholstery nozzle can be used to clean the place hard to reach.
- ▶ Dust brush can be used to clean the gap of sofa cushion or the place with cobweb and other place hard to reach.
- ▶ Crevice tool can be used to clean the picture frame, furniture brim, book and other irregular surface.

Using method floor-carpet nozzle

- ▶ Using generally

Applicability

- Floor-carpet nozzle can be used to tile, wood floor ,and other hard floor , carpet and other soft floor.

Using

- According to cleaning the type of floor, change the place of the nozzle pedal to satisfied your different requirements , and give you many convenience .

- ⚠ Attention: Using on the hard floor(tile, concrete floor, wood floor), please must be push the nozzle pedal, put out the nozzle. Using on the carpet, please take back the nozzle.

Assembling

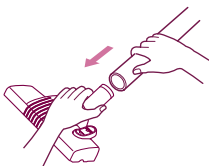

Using

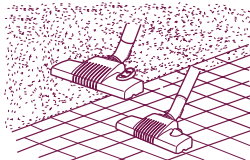

How to separate, clean and assembly the dust tank and the motor protection filter

How to separate, clean and assembly the dust tank

- ▶ After turning off the appliance and unplug it, press the pushing button on the appliance and hold the tank handle, then raise the tank.
- ▶ Press the locking button and then open the cover of dust tank.

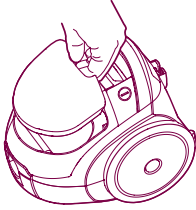

- ▶ Washing dust tank with cold water after emptying the dust. Open the cover of dust tank and dry it fully in shade so that moisture is removed entirely.

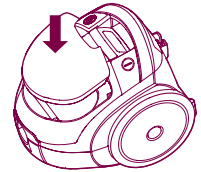
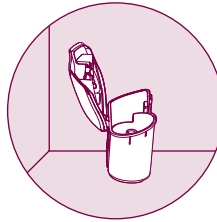
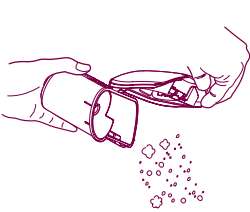

How to separate, clean and assembly the motor protection filter

- ▶ Take out the motor protection filter from the appliance along the arrow direction. Please clean it at least once month or based on the using frequency. Suggest cleaning the motor protection filter and dry it fully in shade so that moisture is removed entirely.

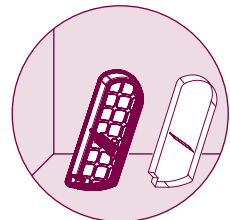
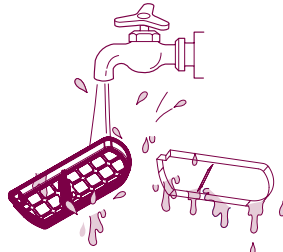
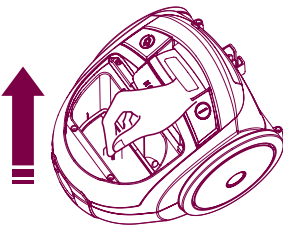

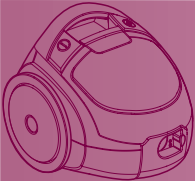

How to keep the vacuum cleaner/Check before notifying malfunction

How to keep the vacuum cleaner



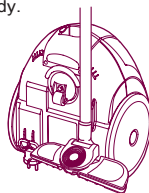
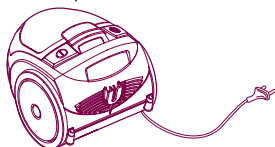

- ▶ Unplug from socket and press the cord winding button to retract the power cord.
- ▶ Insert nozzle into the groove in the back or at the bottom of the body.

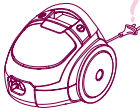

* Please extract a little power cord and press the cord winding button again when the cord can not arrive the restoration.

Check before reporting the trouble

- ▶ If you doubt the product meets with malfunction, please check the cause of such malfunction before contacting with the after-sales service center or agent, so as to ensure efficiency of repair.

Malfunction	Check	Troubleshooting
<p>The vacuum does not work?</p> 	<ul style="list-style-type: none"> • Is the plug inserted? • Is the socket powered on? • If the hose inserted? • If the motor heat protection opened? 	<ul style="list-style-type: none"> • Insert the plug tight (This product is applicable for 220V) • Verify the power of socket is on • Insert the hose tight • Restart in 2 hours
<p>The vacuum does not work?</p> 	<ul style="list-style-type: none"> • When the vacuum cleaner's suction is too large or the motor is under high speed running, they do not belong to the abnormal conditions. So, please use the vacuum cleaner properly. • If it is the noise rather than the normal motor sound, please phone the repair center. 	<ul style="list-style-type: none"> • Clean out the dust collector. • Purge the sponge filter with water and air-dry in the shady and cool place for one day. • Take out the sucked objects before use. • Take out the objects inside the metal tube before use. • Take out the objects inside the hose before use.
<p>Peculiar smell exists inside the vacuum cleaner</p> 	<ul style="list-style-type: none"> • When the motor is running, the rubber band used for fixing the motor will produce a little smell due to the heat, but it will not affect the operation or damage the machine. • When the machine sucks some water accidentally or the dust collector is not cleaned for a long period of time, the peculiar smell will be produced. So, clean up the dust collector timely. 	
<p>The power cord can not be scrolled thoroughly into the vacuum cleaner or the power cord can not be fully pulled.</p> 	<ul style="list-style-type: none"> • Pull out part of the power cord and then re-scroll it. • Please put forth your strength to pull out the power cord, which will not be damaged. • The power cord entwined inside the machine or it is caused by high temperature in the summer. • The cord is bended inside the machine or not coiled around the winder. After the winder is started, the normal operation could be realized. 	
<p>The vacuum cleaner or the discharged air is too heat.</p> 	<ul style="list-style-type: none"> • Is the suction normal? 	<ul style="list-style-type: none"> • The heat air discharged from the machine is arising from the heat produced by motor. So, the temperature is normal, please use the machine continuously.
<p>Inner wall of the hose is too dirt.</p>	<ul style="list-style-type: none"> • Never suck the water because after mixing of the water and dust, the tube wall will be polluted and the motor will be damaged. 	

How to keep the vacuum cleaner

If you have a problem

- If a minor problem occurs, it usually can be solved quite easily when the cause is found by using the check list below.

Problem:

The noise increases and the hose shrink.



Suction power is abruptly weakened.

Help:

Check the dust tank and suction inlet.



Solution

- 1 Dust tank full. (Arrive at MAX line)
Empty dust tank.



Is it full? Empty the dust tank in time!

- 2 Motor filter dirty.
Clean the motor filter with brush and water, allow to dry and replace in cleaner.



Is the filter OK? Then check the suction inlet.

- 3 When checking the suction inlet, adjust the suction level to the maximum.

First step

Turn cleaner off and disconnect from electrical outlet, then disconnect nozzle from metal tube. Check if it is blocked, and remove any blockages.

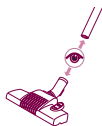

If there is still a problem, proceed the second step.



Second step

Disconnect the metal tube from hose. Check if it is blocked, and remove any blockages.

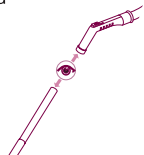

If there is still a problem, proceed the third step.



Third step

Plug cleaner in, turn on, and check hose end for suction. Remove any obstructions.

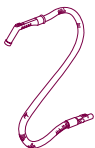

If there is also a problem, clean the filter.



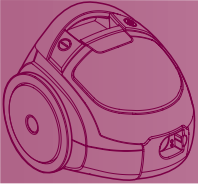

Packing List

Packing List

Vacuum Cleaner	1
Owner's Manual	1
Upholstery Nozzle	1
Dust Brush	1
Crevice tool	1
Flexible hose	1
Metal tube	2
Floor-carpet nozzle	1
Card service	1

如有问题

瞬间感动 Moment Of Truth
LG 售后

请打电话



400-819-9999

售后热线

一号通

LG 电子 (天津)电器有限公司

地址: 中国·天津市北辰区津围公路9号

传真: 022-26903476

邮编: 300402

全国技术服务中心服务咨询电话: 400-819-9999



<http://www.lg.com/cn>