

FM11-LGEMK-14G_ENG



DIGITAL MUSIC PLAYER OWNER'S MANUAL

MODEL: FM11

MF-FM11S1K / FM11S2K / FM11S5K

MF-FM11S1W / FM11S2W / FM11S5W

**Before connecting, operating or adjusting this product,
please read this instruction booklet carefully and completely.**

**Designs and specifications are subject to change
without notice for improvement.**





Contents

Feature	3	<input type="checkbox"/> To Search the Files	16
Precaution	4	<input type="checkbox"/> Local Repeat Function	16
Name of Each part	5	<input type="checkbox"/> Record Mode : MicroPhone	17
<input type="checkbox"/> Front / Rear Panel	5	<input type="checkbox"/> Record Mode : LineIN	18
<input type="checkbox"/> Left / Right / Bottom Panel	5	<input type="checkbox"/> Voice Mode	18
Display Window	6	<input type="checkbox"/> FM Mode	19
<input type="checkbox"/> LCD Display	6	<input type="checkbox"/> Add to Preset	19-20
Installing Software	7-10	<input type="checkbox"/> Load Preset	20
<input type="checkbox"/> Operation Circumstances	7	<input type="checkbox"/> Auto Scan	21
<input type="checkbox"/> Installing the device Software	7-8	<input type="checkbox"/> Exit to MUSIC mode from FM mode	21
<input type="checkbox"/> Firmware Upgrade	9	<input type="checkbox"/> Delete One FM Radio Stations	22
<input type="checkbox"/> Recovery Mode	10	<input type="checkbox"/> Delete All FM Radio Stations	22
Connecting Devices	11-12	<input type="checkbox"/> FM Radio Recording	23
<input type="checkbox"/> Connecting USB Cable	11	<input type="checkbox"/> Playback FM Radio record	23
<input type="checkbox"/> Disconnecting USB Cable	11	<input type="checkbox"/> Navigation Mode	24
<input type="checkbox"/> Installing Battery	12	<input type="checkbox"/> Setting Mode	25
<input type="checkbox"/> Connecting Earphone	12	<input type="checkbox"/> Equalizer Function	25
Before Operation	13-14	<input type="checkbox"/> Repeat Function	26
<input type="checkbox"/> Downloading Files	13	<input type="checkbox"/> Contrast Function	26
<input type="checkbox"/> Power On	14	<input type="checkbox"/> Backlight Function	26
<input type="checkbox"/> Power Off	14	<input type="checkbox"/> Power Savings Function	27
<input type="checkbox"/> Adjust Volume	14	<input type="checkbox"/> Record Settings Function	27-28
<input type="checkbox"/> Hold Function	14	<input type="checkbox"/> Load default Function	29
MENU Operation	15-26	<input type="checkbox"/> Language Function	29
<input type="checkbox"/> MENU Mode	15	<input type="checkbox"/> Exit Function	29
<input type="checkbox"/> Music Mode	15	<input type="checkbox"/> Erasing Files	30
<input type="checkbox"/> To Play Files	15	<input type="checkbox"/> About	30
<input type="checkbox"/> To pause Files	15	Specifications	31
<input type="checkbox"/> To Skip the Files	16		



Feature

Removable Storage Device

You can easily copy and paste files to the player using Windows Explorer.

USB 2.0 Support

USB 2.0 transmits data with a speed of 480Mbps that is 40 times faster than USB1.1.

Voice Recording

You can make high quality voice recordings.

FM Reception

Listening to an FM program is made easy with Auto Search and Frequency.

Upgrading Firmwares

It can become the continuous improvement of the function and the various setting up this product.

MP3, WMA, Playback

- **MP3** is MPEG1 Layer3 audio format. MP3 is a well known, high quality digital audio format. MP3 files can be compressed up to 12 times the original wave file size.
- **WMA** (Windows Media Audio code) is the highest quality in terms of a sound and music. WMA provides all type of the best sounds from 8kHz to 48 kHz.



Precaution



Never attempt to disjoin or repair the product yourself.



Never use the product for other purposes than those described in this guide.



Note that malfunctions may occur if you use the product in places where static electricity occurs frequently.



Avoid to leave the product in hot or humid place.



Take special attention when touching the product box, owners manual and accessories to avoid cuts.



If the product emits an unusual odor or excessive heat, or you notice anything else that seems unusual, do not use the product and contact our Customer Service Center.



Pay attention to the USB cable direction when connecting the product to PC. The PC or the product may be damaged if you connect the USB cable in the wrong direction. Never use damaged or worn USB cable.



Do not use the product near water. Do not touch this product with wet hands.



Be sure to back up your data files. The files on the player may be deleted while using the product. We are not responsible for any damaged or lost files that are not saved on your PC. Customer Service Center does not back up your data while servicing.



Avoid to use headphone or earphone while driving a vehicle, motorcycle, riding a bicycle, getting exercise or working in dangerous areas. Not only is it dangerous, but also illegal in some areas.



Name of Each part

Front / Rear Panel

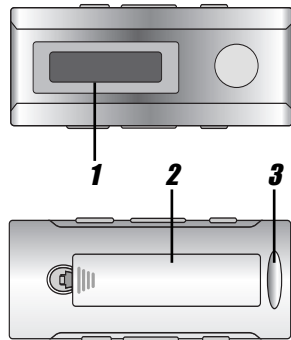

- 1** LCD
- 2** Battery Cover
- 3** Necklace connector
- 4** USB Port
- 5** Hold switch (HOLD)
- 6** SKIP / SEARCH ◀◀ ▶▶ button
FM radio frequency ◀◀ ▶▶ button
- 7** MENU button
A-B Repeat button
- 8** LINE-IN Socket

Left / Right / Bottom Panel

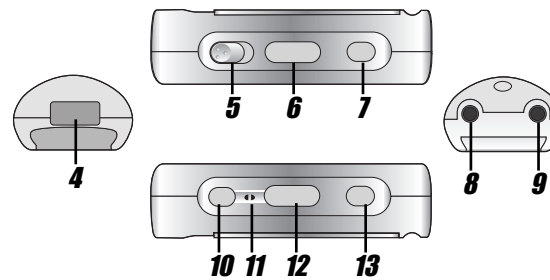

- 9** Earphone Socket
- 10** STOP/OFF ■ button / Preset Up
RETURN button
- 11** Microphone (MIC)
- 12** Volume (-/+) button
- 13** PLAY / PAUSE ▶|| button / Preset Down



Display Window

LCD Display

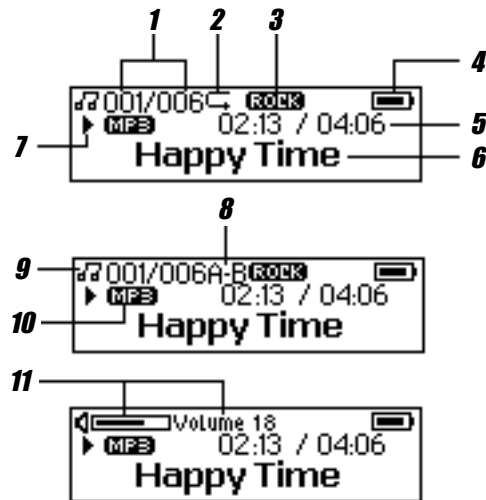

- 1** Track Number / Total Track
- 2** Repeat indicator
- 3** Equalizer indicator
- 4** Battery indicator
- 5** Elapsed Time / Track Time
- 6** File information
- 7** PLAY / PAUSE / STOP / REC indicator
- 8** A-B Repeat indicator
- 9** Music Mode / Voice Mode indicator
- 10** Music Type indicator
- 11** Volume indicator



Installing Software

Operation Circumstances

Your MP3 Player needs the following minimal system requirements for your computer.

- OS : Windows ME / 2000 / XP
- CPU : At least Pentium - 133MHz
- Memory : At least 32MB
- HDD Space : At least 100MB
- Video Card : 640 x 480 Mode, At least High Color(16bit)
- USB Port
- CD-ROM Drive

You can update the install software for Windows ME/2000/XP available etc. from an internet website by LG Electronics Inc. Refer to the following sample contact procedure;

<http://www.lge.com> → Service Site → Select Your COUNTRY
→ Product Support → Device Driver

Note

- Windows ME, Windows 2000, and Windows XP operating systems support USB 2.0 storage without additional setup. Windows Explorer may be employed to use the product as a portable storage device without installing any other information.
- Device driver installation is required for windows 98SE operating.

Installing the device Software

1 Insert the software CD into drive D:\ (CD ROM drive).
The install will run automatically.

2 Click the "Installation Driver" button in the installation window.



3 Click the "Next" button in the installation window.



4 Read about the license agreement and select "Yes".





Installing Software (Continued)

- 5** Select the installation folder and click the "Next" button.

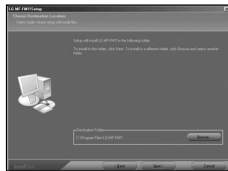

- 6** Set the path of program folder and then click the "Next" button.



- 7** Installation is progressing.

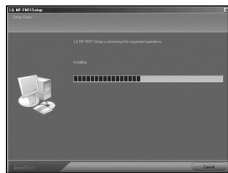

- 8** Click the "Finish" button when the installation complete screen is displayed.

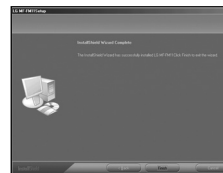

- 9** You must reboot your computer to complete the install.





Installing Software (Continued)

Firmware Upgrade

You can upgrade FIRMWARE to add, change or improve the functions of the player, in which the Firmware means its Operating System.

- 1 Visit the company website (www.lge.com) to check if there is an upgraded version available for the player.
- 2 Connect one end with the USB port on the back of your PC and then plug the other end into the USB connector of your Player.
- 3 Choose Program -> LG -> FM11 -> Firmware Update in the "Start" menu to start the firmware upgrade process.

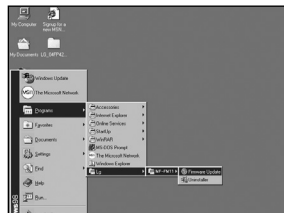

- 4 The utility will start to search the MP3 player. Please wait until the Firmware Download window appears.

- 5 Click the "Start" button to start.

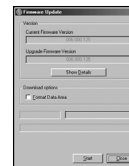

Note

Format Data Area option:
When not selected : Updates the firmware only.
If selected : Updates the firmware and formats the storage space.

- 6 The firmware will be transferred to the player. Please wait until it has finished.

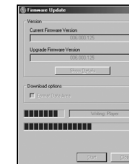

- 7 Click the "Close" button to exit.

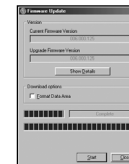

Note

If the utility can not find the MP3 player even after searching for several minutes, please cancel the searching, and redo the steps from step 1 and make sure that the MP3 player is put into Recovery mode.

Installing Software (Continued)

Recovery Mode

- 1 Take out the battery from battery compartment.
- 2 Press and hold the play button. Do not release it until step 4.
- 3 Plug the MP3 player into the USB port of your computer.
- 4 Hold for 5 seconds and release the play button.
- 5 Leave the MP3 player in the USB port for the next step.
- 6 Choose Program -> LG -> FM11 -> Firmware Update in the "Start" menu to start the firmware upgrade process.

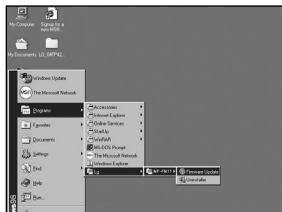

- 7 The utility will start to search the MP3 player. Please wait until the Firmware Download window appears.

- 8 Click the "Start" button to start.

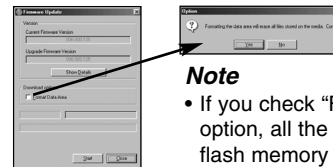

Note

- If you check "Format Data Area" option, all the data stored in the flash memory is deleted.

- 9 The firmware will be transferred to the player. Please wait until it has finished.

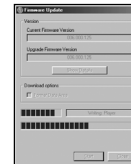

- 10 Click the "Close" button to exit.

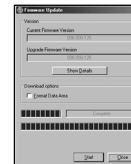



Connecting Devices

Connecting USB Cable

- 1 Connect one end with the USB port on the back of your PC and then plug the other end into the USB connector of your MP3 Player.

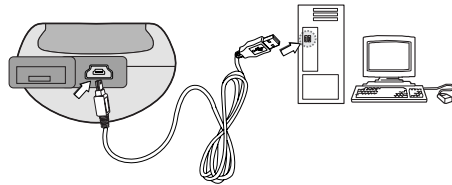

- 2 The icon is displayed in the PC tray if successfully connected.



- 3 The following screen is displayed in the product LCD.

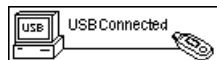

Disconnecting USB Cable

Wait until you get a message saying that you can safely unplug the device before disconnecting the USB cable.

- 1 The safe remove icon is in the system tray next to the clock.



- 2 Click on the icon to eject the player from the computer and select the 'Safely remove' message.
- 3 There will be a message indicating that it is now safe to disconnect the player.
- 4 You can now go ahead and unplug the USB cable from the player.



Connecting Devices (Continued)

Installing Battery

1 Open the battery cover.

2 Insert the battery.

Make sure to match the + and - on the batteries to the marks inside the battery compartment.

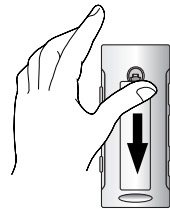

Note

- Improper use of batteries may cause battery leakage and corrosion.
- If battery leakage occurs, wipe the battery liquid from the battery compartment, then insert new battery.

Connecting Earphone

Connect the earphones to the earphone socket of the player.

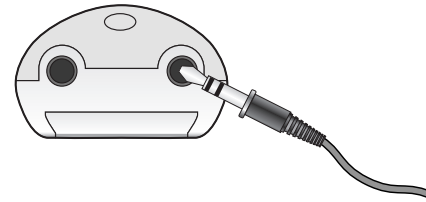



Before Operation

Downloading Files

- 1 Connect one end with the USB port on the back of your PC and then plug the other end into the USB connector of your Player.**
- 2 Open Windows Explorer on PC.**
Portable Disk is displayed in Window Explorer.
- 3 Select the file you want to save, then drag and drop it to the portable disk.**
The saved files will be played in the order of file name as they appear.

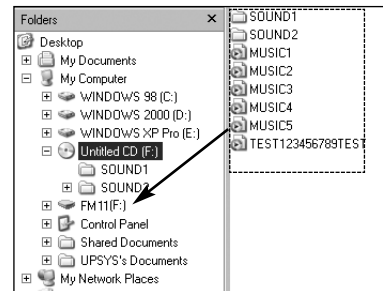

Note

- Don't remove the USB port while uploading or downloading a files.
- Time display appearing on the display part when playing VBR file may vary and there may be some difference from actual time (both progress time and VBR are displayed at the same time when playing file).



Before Operation (Continued)

Power On



To turn on, press the ►|| button.

Power Off

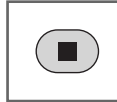

To turn off, press the ■ button for more than 2 seconds on the pause mode.

Adjust Volume

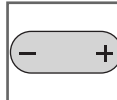

You can adjust the volume by pressing volume +/- buttons.

- The volume level can be adjusted by 31 steps. (Min, 01~29, Max)
- The volume changes by 1 level when you press the button briefly, and it changes rapidly when you press and hold the button.

Hold Function

This function locks the main unit to prevent it from operating when you accidentally press a button.

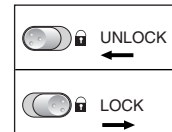

- Power automatically turns off after the "Holding" display appears for about a second if powering on in the holding position.

- The word "Holding" display for 2 seconds and disappears whenever pressing the operation button.



MENU Operation

MENU Mode



1 Press the MENU(M) button for more than 2 seconds to enter menu.

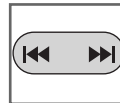

2 Press **◀▶** button to select a menu you want.



3 Press MENU(M) button.
The selected menu will be appeared.

Note

- To cancel mode switching and return to the previous mode, press **■** button.
- If you don't press any buttons within about 5 seconds in the menu, it will return to the main screen.

Music Mode

A mode to listen to the music files stored in the MUSIC memory.

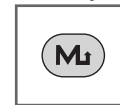

Select "Music" in the menu.

- If there is no music file existed, a message saying "No Files" will appear in the display.

To Play Files

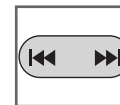

1 Press **◀▶** button to select a file you want.

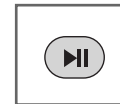

2 Press **▶||** button to play a file.

To Pause Files



Press **▶||** button during file playing.
To resume playback, press this button again.



MENU Operation (Continued)

To Skip the Files

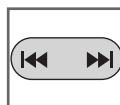

To skip the next file

Press briefly the ►► button on the main unit to select the next file.



To skip the previous file

Press briefly the ◀◀ button on the main unit within 5 seconds of playing time.

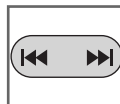

To return the beginning of the current file

Press briefly the ◀◀ button on the main unit after 5 seconds of playing time.

To Search the Files

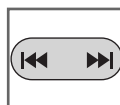

Press left or right for more than 2 seconds the ◀◀ ►► button during file playing.

Note

- When you play the low bit rate (under 64kbps) files, operations can be late or song can be mute.

Local Repeat Function



1 File playing, press MENU(M) button briefly once.

"A" appears in the LCD.



2 To select the local repeat ending point you want during file playing, press the button again.

"A-B" appears in the LCD.



3 To cancel local repeat function, press MENU(M) button.

"A-B" disappears in the LCD.

Note

- The Local Repeat Function is not available in FM TUNER mode.
- After marking a start point, press MENU(M) button again within 3 seconds, then an ending point is not marked.
- The A-B section repeat is available in a same song.



MENU Operation (Continued)

Record Mode : MicroPhone



1 Select "Record" in the menu.

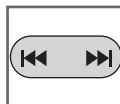

2 Press **◀▶** button to select "MicroPhone."

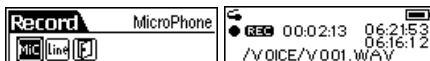

3 Start the voice recording to the Microphone (MIC) on the main unit.

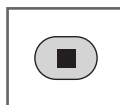

4 If you want to stop recording, press the **■** button.

Note

- The recorded files are stored in the current folder.
MP3 : MP3_ENC / M001.MP3 or M002.MP3...
WAV : VOICE / V001.WAV or V002.WAV...
- If the "MEMORY FULL" appears in the LCD, delete file to make space.
- Configure the audio file Bit rate before recording.
(Record Settings > Mic > Rate)
- If you want to pause recording, press the **▶||** button.

MENU Operation (Continued)

Record Mode : LineIN

- 1 Connect an external audio output to the product line-in port.

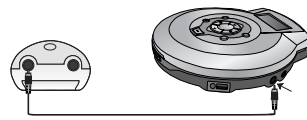

- 2 Select "Record" in the menu.



- 3 Press <Left><Left> <Right><Right> button to select "LineIN".

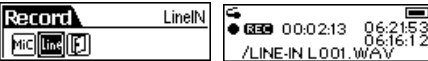

- 4 Start the external audio output.

- 5 Start recording to a new file in the current folder.

- 6 If you want to stop recording, press the  button.
The voice recording is completed.

Voice Mode

- A mode to listen to the voice files stored in the VOICE memory.

- Select "Voice" in the menu.



- The recorded files are stored in the VOICE folder in the following format: V001.WAV or V002.WAV...
- This operation is similar to the playback of music.

Note

- The recorded files are stored in the current folder.
MP3 : MP3_ENC / M001.MP3 or M002.MP3...
WAV : LINE-IN / L001.WAV or L002.WAV...
- Configure the audio file Bit rate before recording.
(Record Settings > LineIN > Rate)

MENU Operation (Continued)

FM Mode

The MP3 Player allows you to listen to FM radio with the built-in digital FM tuner.



Select "FM" in the menu.

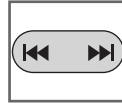

• Manual Tuning

Press the ◀▶ button repeatedly.

• Auto Tuning

Press and hold the ◀▶ button. Automatically scans and turns to the next available station.

Note

- When using the MP3 Player, Tuner at the first time, the MP3 Payer will automatically start to seek all available FM radio stations and save them into preset list. Please wait until the "Search" disappears from the display.
- FM Tuner reception may vary in different areas.
- If you are in the area of low sensitivity, radio receiving may not be good.

Add to Preset

The MP3 Player tuner allows user to save a FM radio station to preset. After you have tuned to FM radio station.



1 Select "Add to Preset" in the FM menu.

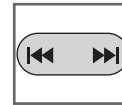

2 Press ◀▶ button to select one FM radio station in the preset list.

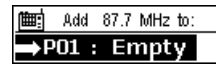

3 Press the MENU(M) / ▶|| button to save.



MENU Operation (Continued)

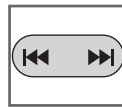

4 Select “YES” or “NO” by pressing I◀◀ ▶▶I button.



Yes : To save the preset

No : To give up the save



5 Press the MENU(M) button.

Load Preset

To select a FM radio station from the list to listen.



1 Select “Load Preset” in the FM menu.

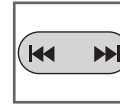

2 Press I◀◀ ▶▶I button to select one FM radio station in the preset list.

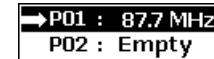

3 Press the MENU(M) button to load.

Note

Searching Preset

If you press the ▶||, ■ button short while listening to FM radio, the saved preset is searched.

▶|| : Move the the next preset.

■ : Move the previous preset.



MENU Operation (Continued)

Auto Scan

To re-scan all FM radio stations save them to the preset list automatically.



1 Select "Auto Scan" in the FM menu.

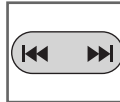

2 The MP3 Player tuner starts to seek and save the FM stations automatically.

Note

- If you listen to FM radio, insert the earphone into earphone jack.
The earphones play the part of the antenna.







Exit to MUSIC mode from FM mode

Press the MENU(M) button for a while and release it. The MP3 player will exit FM mode and go back to MUSIC mode.



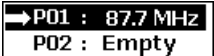

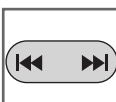
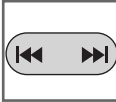
MENU Operation (Continued)

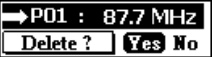
Delete One FM Radio Stations







-  **1** Select "Delete One" in the FM menu.

-  **2** Select FM radio station from the preset list.

-  **3** Press MENU(M) /  button.
-  **4** Select "YES" or "NO" by pressing  button.

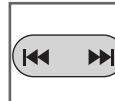
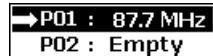
Yes : To delete the FM radio.

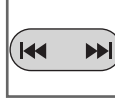
No : To give up the delete.

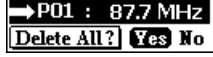

-  **5** Press the MENU(M) /  button.

Delete All FM Radio Stations

-  **1** Select "Delete All" in the FM menu.

-  **2** Select FM radio station from the preset list.

-  **3** Press MENU(M) /  button.
-  **4** Select "YES" or "NO" by pressing  button.

Yes : To delete the FM radio.

No : To give up the delete.

-  **5** Press the MENU(M) /  button.



MENU Operation (Continued)

FM Radio Recording

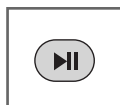

1 When listening to a FM radio, press and hold the ►|| button for a while and release it.

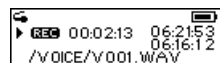

2 The MP3 Player starts to record the FM radio.

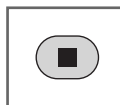

3 Press the ■ or MENU(M) button to stop the recording and continue to listen the FM radio.

Note

- In area with weak signals, some channels may not saved.
- A maximum of 20 channels can be saved.
- The recorded files are stored in the current folder.
MP3 : MP3_ENC / M001.MP3 or M002.MP3...
WAV : FM / F001.WAV or F002.WAV...
- If the "MEMORY FULL" appears in the LCD, delete file to make space.
- Configure the audio file Bit rate before recording.
(Record Settings > FM> Rate)
- If you want to pause recording, press the ►|| button.

Playback FM Radio record

A mode to listen to the FM record files stored in the FM memory.



1 Select "Navigation" in the menu.

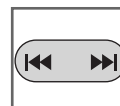

2 Use ◀▶ button to select the desire folder or file.



3 Press the ►|| button to play.

- The recorded files are stored in the current folder.
MP3 : MP3_ENC / M001.MP3 or M002.MP3...
WAV : FM / F001.WAV or F002.WAV...
- This operation is similar to the playback of music.



MENU Operation (Continued)

Navigation Mode

You can search music file while listening to music.

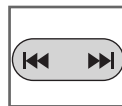

1 Select "Navigation" in the menu.



2 Press MENU(M) button.

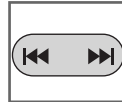

3 Use |◀▶| button to select the desire folder or file.

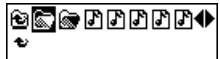

4 Press the ▶|| button to play.

Note

- When a folder is selected in the navigation mode, press the MENU button, a sub-menu window will pop-up.

Play : To play music located in the folder.

Enter : To enter the folder.

Cancel : To cancel.

- When a file is selected in the navigation mode, press the MENU button, a sub-menu window will pop-up.

Play : To play this file.

Delete : To erase.

Cancel : To cancel.



MENU Operation (Continued)

Settings Mode

You can change the configuration to the device.



1 Select "Settings" in the menu.

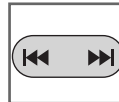

2 Use **◀▶** button to select the desired setting mode.



3 Press the MENU(M) button to select that setting.
After setting is finished, press and hold MENU button for a while and release it to exit the menu.

Equalizer Function

You can choose between 6 fixed repeat mode.



Normal : For Standard mode.

XBass : For Ultra bass mode.

Rock : For Rock mode.

Jazz : For Jazz mode.

Classical : For Classical mode.

Pop : For Pop mode.

Note

- If you don't press any buttons within about 7 seconds in the menu, it will return to the previous screen.
- The Equalizer Function is not available to the FM TUNER mode.



MENU Operation (Continued)

Repeat Function

You can choose between 5 fixed repeat mode.



Normal	: Repeat mode is cancelled.
Repeat One	: Plays repeatedly the current selected file.
Repeat All	: Plays repeatedly all file.
Random	: Plays randomly once.
Random All	: Plays randomly continuously.

Note

- The REPEAT Function is not available to the FM TUNER mode.

Contrast Function

This function can adjust lightening or darkening the LCD.



Adjust the LCD's contrast level.
(between -5 and 5)

Backlight Function

Whenever any button is pressed, the LCD bright.
This function can set the time of brightness displayed in the LCD.



Adjust the LCD's Backlight level.
(Off, 3sec, 5sec, 10sec, 15sec, Always on)



MENU Operation (Continued)

Power Savings Function

Use the Power Saving function to automatically turn the MP3 Player off after a predetermined length of inactivity.



Adjust the Power off time.
(Off, 1min, 2mins, 5mins 10mins, 15mins)

Note

- Select "Off" would never turn off the MP3 Player automatically.

Record Settings Function

A function to adjust the bit rate of recording.

1 Select "Record Settings" in the menu.



2 Press I◀▶I button to select "Mic", "FM" or "LineIN".



3 Press MENU(M) button to enter submenu.



4 Press I◀▶I button to select "WAV", "MP3".

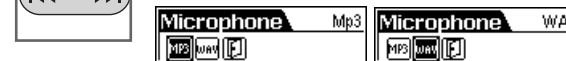

5 Press MENU(M) button to enter submenu.

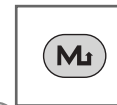



MENU Operation (Continued)

- Mic : Record mode for microphone.
- FM : Record mode for FM recording.
- LineIN : Record mode for Line-In recording.
- Format : you can select format to record.

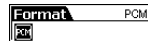

- Rate : you can select one of the following bit rates.

■ Mic

	Bit Rate
MP3	96,112,128,160,192,224 KBPS

	Bit Rate
WAV	8,11,16,22,32 KHZ

■ FM

	Bit Rate
MP3/Mono	96,112,128,160,192,224 KBPS

MP3/Stereo	96,112,128,160,192,224,256,320 KBPS
------------	-------------------------------------

	Bit Rate
WAV	8,11,16,22,32 KHZ

■ LineIN

	Bit Rate
MP3/Mono	96,112,128,160,192,224 KBPS

MP3/Stereo	96,112,128,160,192,224,256,320 KBPS
------------	-------------------------------------

	Bit Rate
WAV	8,11,16,22,32 KHZ

Note

- A higher Bit Rate increases the quality but reduces recording time.
- The recording format options in "Format" are only a bit different. User need to change this setting.
- Recording hours for bit rate
 Mic, FM, Line-in(MP3) : (based on 128 KBPS)
 128MB / 256MB / 512MB : About 2 / 4.5 / 8.5 hours
 Mic, FM, Line-in(WAV) : (based on 32 KHZ)
 128MB / 256MB / 512MB : About 1 / 2 / 4 hours



MENU Operation (Continued)

Load default Function

To reset all setting to factory default setting.



Exit Function

To move to previous menu.

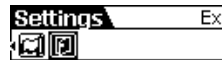

Language Function

To set the a display language.
(EN/PO/SP/SC/TC/GE/FR)

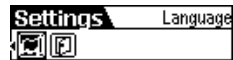



MENU Operation (Continued)

Erasing Files



- 1 Stop playback or recording before attempting to erase files. Select "Delete" in the menu.



- 2 Press **◀▶** button to select "Delete All" or "Delete One".



- 3 Press MENU(M) button to enter submenu.

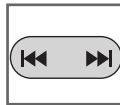

- 4 Press **◀▶** button to select "Music" or "Voice".



- 5 Press MENU(M) button to enter submenu.



About

Information is available regarding the firmware version, built-in memory size and free memory size.

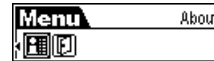

Note

- When "Delete All" is selected in the menu.

Yes : To delete all files.

No : To give up the delete.

- When "Delete One" is selected in the menu.

Yes : To delete the current select file.

No : To give up the delete.



Specifications

MP3 PLAYER SECTION

Memory Capacity	MF-FM11S1K/FM11S1W : 128MB MF-FM11S2K/FM11S2W : 256MB MF-FM11S5K/FM11S5W : 512MB
Battery	AAA Battery
Dimensions	34x80x22 mm
Weight	31g
Operating Voltage	1.5V DC
Dynamic Range	55/59 dB (No Filter / JIS-A Filter)
Earphone Output Power	5mW+5mW (1kHz, 0dB / 16Ω)
S/N Ratio	60/90 dB (No Filter / JIS-A Filter)
Channel Separation	30/33 dB (1kHz / 10kHz)
Equalizer	Normal, XBass, Rock, Jazz, Classical, Pop

Frequency Range	87.5~108 MHz
S/N Ratio	48 dB
Channel Separation	25 dB
Antenna	Earphone Antenna
File Support	MPEG1/2/2,5 Layer3, WMA
Accessories	Earphone, USB cable, USB mini Manual, CD, Necklace

This product is manufactured to comply with the radio interference requirements of EEC DIRECTIVE 89/336/EEC, 93/68/EEC and 73/23/EEC.



P/NO:3834RL0014G