

Model	VH900*DS		
Language	English+Chinese		
Page	26	Color(cover/body)	4/2
Material	Weight 100g	Size(W*H)	150 x 220(mm)
Date	2012.12.27	Designer	Zhu Li
Part No.	MFL67600103	Description	Owner's manual

### Chage Record

No.	Change content	ECO No.	Date	Designer	Confirm
①					
②					
③					
④					
⑤					
⑥					
⑦					
⑧					
⑨					



## 使用说明书

床褥专用吸尘器

强力拍打

VH900\*DS

中文 → 1-13页  
English → Page 14-25

售后服务电话



使用前请仔细阅读说明书，阅读完后请妥善保管以备需要时查阅。



MFL67600103

## 目 录

产品规格 .....	2
使用前注意事项 .....	3-4
吸尘器的部件名称 .....	5
吸尘器的使用说明 .....	6
吸尘器的使用方法 .....	7
吸尘器进气口的清理 .....	8
拆卸方法	
清洁方法	
安装方法	
集尘盒的倾倒/清洁方法 .....	9
过滤器的拆分/清洁 .....	10
拆卸方法	
清洁方法	
安装方法	
故障通告前确认的事项 .....	11-12
装箱单 .....	13

## 产品规格

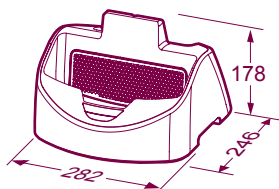
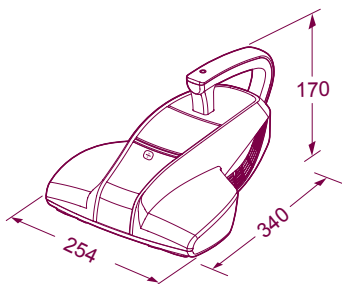



型号: VH900\*DS  
额定电压: 220V~ 50Hz  
额定功率: 380W  
净重: 2.1Kg(吸尘器), 1.1Kg(吸尘器存放底座)  
电源线长度: 5m(吸尘器), 1.5m(吸尘器存放底座)  
外形尺寸: 254mm×340mm×170mm(吸尘器)  
282mm×246mm×178mm(吸尘器存放底座)  
本产品执行标准: GB4706.1-2005  
GB4706.7-2004  
GB17625.1-2003  
GB4343.1-2009

※ 为了提高产品质量而进行的外观及设计规格上的变更将不再另行通知。

## 使用前注意事项

### 使用前注意事项

忽视说明而导致的错误操作将会对您造成不同程度的损害，请认真阅读以下提示说明。

-  **危险** 此标识表明违反标记事项时，会立刻导致严重伤害甚至发生死亡事故。
-  **警告** 此标识表明违反标记事项时，有可能导致严重伤害甚至发生死亡事故。
-  **注意** 此标识表明违反此标记事项时，有可能导致财产损失或轻微伤害。

### 危险

请不要在易燃液体附近使用吸尘器，以免发生火灾。

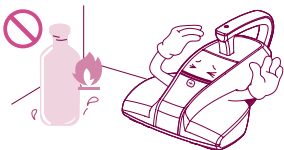

插拔电源插头时，请先关闭电源开关，以免发生火灾或触电的危险。请不要用潮湿的手触摸电源插头，以防触电。（不要在220V以外的电源上使用产品）

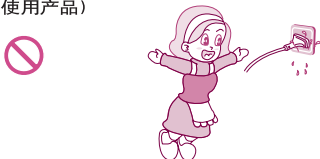

### 警告

请不要吸入头发团、大纸团等物品，如有堵塞现象，请及时清理。

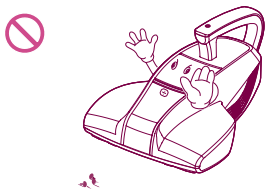

为避免发生火灾或触电的危险，在清扫时，注意不要让机体吸入液体、刀片、火种以及水泥、石膏粉等小微粒。

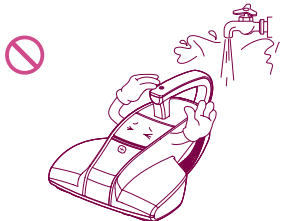

15A以上的电流请单独使用插线板，在一个插线板上同时使用多种电器可能会引发火灾。建议不要使用电源线延长线，以免引起不必要的危险。

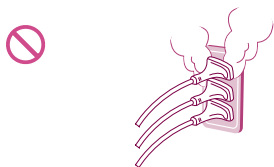

长时间不使用电器时，请记住拔掉电源插头；正处于通电时，请您不要离开。

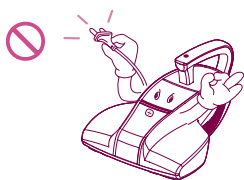

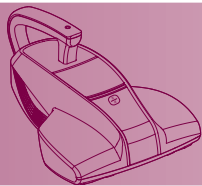

## 使用前注意事项

### 警告

请不要让电源线与吸尘器接近电暖器等热源，以免机体变形或发生火灾。请您不要使用破损的电源和插头，如有破损，必须由指定维修站更换。



请不要让儿童把吸尘器及附件当做玩具，以防意外。



请不要在地板或桌子等坚硬物体的表面使用吸尘器

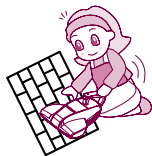

请不要在进气口或排气口堵塞时，继续长时间运行，否则可能造成机体变形或损坏。



使用过程中，机体会产生静电的可能，请您使用时注意。

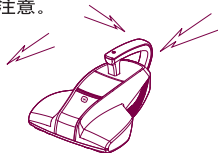

### 注意

非专业维修人员请勿开机修理。

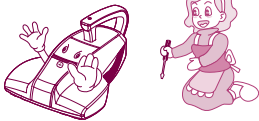

集尘盒集满时，请您正确开启集尘盒清理。请您注意不要在没安装集尘盒或过滤器时使用吸尘器。

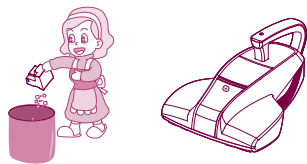

注意不要使电源线夹在门缝里或用电源线提拉吸尘器，防止电源线受损。

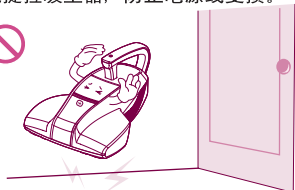

请您注意保护自身安全，使身体各部位远离吸尘器吸口或活动部位。

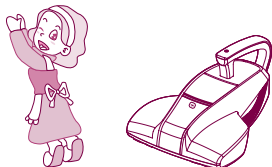

## 吸尘器的部件名称

### 部件名称

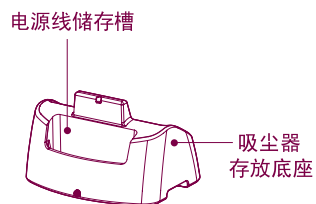
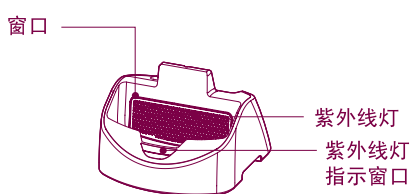
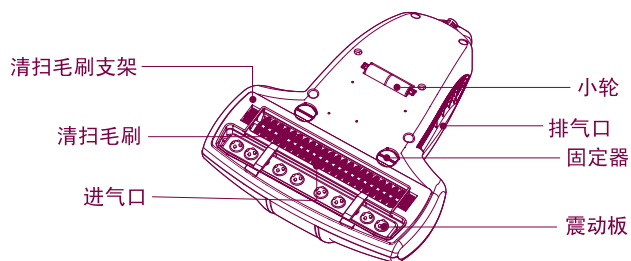
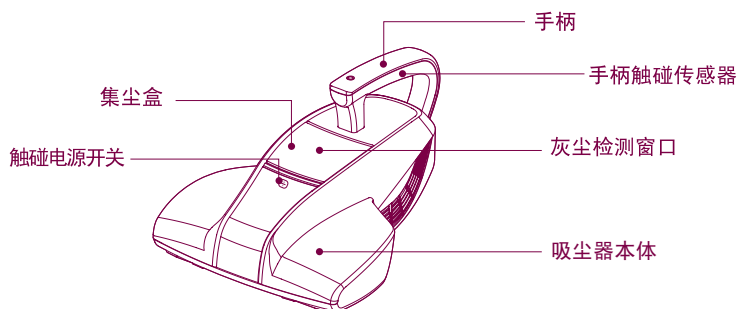

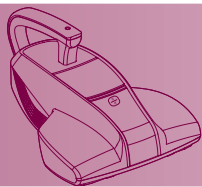

## 吸尘器的使用说明

### 使用说明

#### 请按图示使用

- 1 将电源线插头插入电源插座。当插头插入插座时，将发出“嘀”的声音。

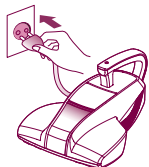

- 2 用手接触下图所示位置的触碰电源开关，指示灯亮后即转换为待机模式，同时发出“嘀”的声音，此时握住手柄，机体开始工作。指示灯亮后如再次接触触碰电源开关，同时也发出“嘀”的声音，机体即处于关机状态，此时即使握住手柄，机体也不工作。



- 3 用手握住手柄时，吸尘器开始工作。手柄触摸传感器是为避免吸尘器在使用过程中由于误操作而产生危险的保护装置，只有当手接触到触摸传感器时，吸尘器才会运转。

- \* 当触碰电源开关开启时，用手握住手柄，吸尘器立即开始运转。

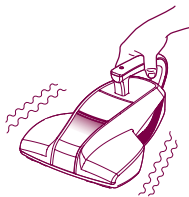

- 4 将手松开手柄片刻

- 将手松开手柄三秒钟后，吸尘器将停止工作并转换为待机状态。（此时指示灯蓝光闪烁）
- 将手松开手柄一分钟后，吸尘器将停止工作并转换为关机状态。（此时指示灯蓝光熄灭，同时发出“滴滴”的声音）

- 如果在一分钟内，手重新握住手柄，吸尘器将重新启动。

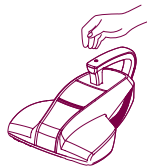

- 5 关闭吸尘器

- 当吸尘器处于工作状态时，接触触碰电源开关，发出“嘀”的声音同时指示灯蓝光熄灭，此时吸尘器处于关机状态。
- 如果希望重新启动吸尘器，请按照正常程序进行操作。

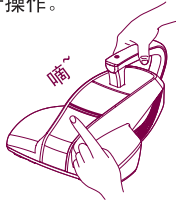

- 6 使用吸尘器存放底座

- 将吸尘器存放底座的插头插入电源插座内
- 将吸尘器主体放入吸尘器存放底座前，请确认已将吸尘器主体电源切断。
- 当您 will 吸尘器主体放入吸尘器存放底座后，吸尘器存放底座前端蓝色指示灯会点亮，与此同时紫外线灯开始进行紫外线照射的工作。
- 当吸尘器主体放入吸尘器存放底座五分钟左右时，吸尘器存放底座前端蓝色指示灯和紫外线灯会同时自动关闭，紫外线照射的工作完成。若想重复照射，需将吸尘器提起后再次放入底座中。

- \* 如果在清扫过程中反复将吸尘器主体放置于吸尘器存放底座中，且均未超过五分钟，请在清扫完毕后，将吸尘器主体放置于吸尘器存放底座中进行五分钟紫外线照射。

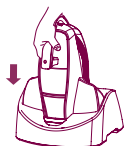

# 吸尘器的使用方法

## 使用方法

请按图示使用

- 床垫, 床罩

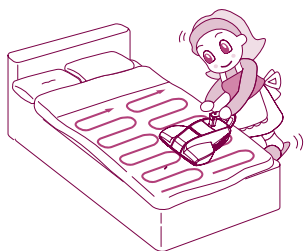

床上用品: 床垫、床罩

将所要清扫的区域分成两半。  
在每一半空间内来回推拉从头到尾的进行清理。

- 枕头, 坐垫等等



用做枕头的物品: 大靠垫, 一般的坐垫, 枕头  
由于被清扫的物品宽度较窄, 故将吸尘器放置于被清扫物品上然后采用来回推拉的方式进行清理。

- 薄被

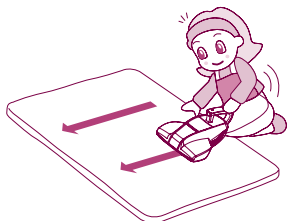

毛毯: 厚毛毯、薄毛毯  
在全部清扫区域内来回推拉从头到尾的进行清理。

- 厚被

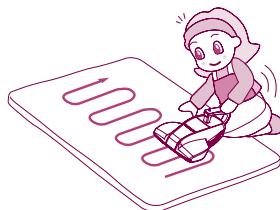

其他: 沙发  
正常清扫方式。

**警告:** 不同于一般的手持吸尘器产品, 该产品不能长时间持续运转使用, 按照吸入灰尘重量分类, 它属于小容量且只能吸入较小的灰尘, 因此切勿使用本机吸入较大的物体。



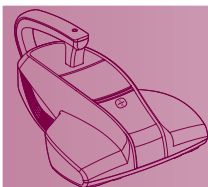

## 吸尘器进气口的清理

### 拆卸方法

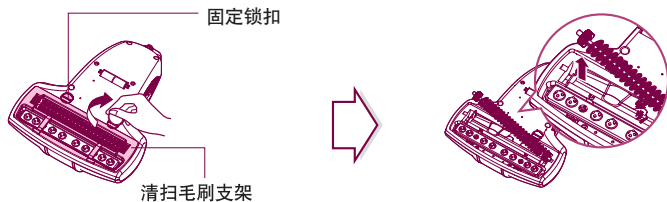

在地板上放置一块软布，将吸尘器主体翻转后放在上面。检查是否有异物，然后用一字起子或类似工具沿顺时针方向将两个固定锁扣旋转 $90^{\circ}$ 后，取下清扫毛刷支架。握住毛刷，将其取出。

### 清洁方法

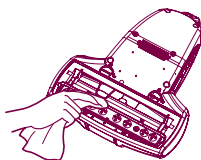

1 用抹布擦拭主机进气口表面较脏的部位

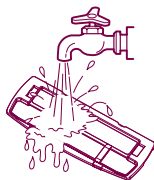

2 用清水清洗清扫毛刷支架，并在阴凉处晾干

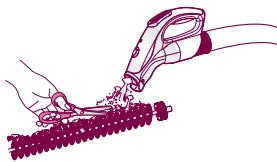

3 用其他吸尘器或剪刀对毛刷进行清理

### 安装方法

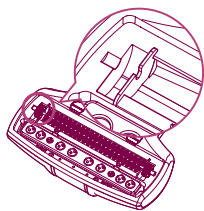

1 将毛刷插入与其外轮廓匹配的主机固定槽中。

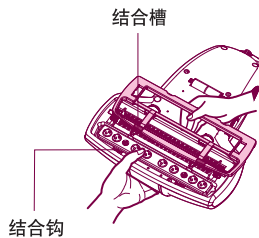

2 将清扫毛刷支架的结合槽与主机结合钩组装在一起。用一字起子或类似工具将两个固定锁扣逆时针旋转 $90^{\circ}$ 后，组装完毕。

## 集尘盒的倾倒/清洁方法

### 集尘盒的倾倒方法

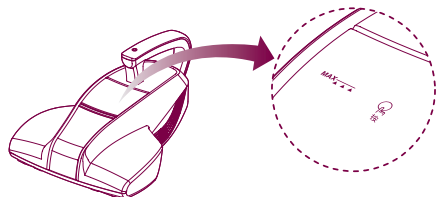

**MAX** ———— 当细小的灰尘到达MAX线时，此时应该清空集尘盒内的灰尘，同时在下次使用前清理过滤器和海绵  
▲ ▲ ▲

### 集尘盒的清洁方法

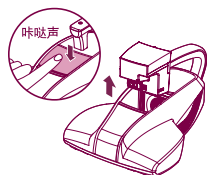

**1** 轻按集尘盒顶部表面的中间部位直到听到“咔哒声”后松开手，集尘盒会升起，然后取出集尘盒

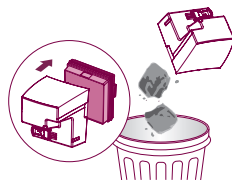

**2** 握住集尘盒两端，取出过滤器（海绵过滤器和HEPA过滤器），清空集尘盒内的灰尘。倾倒灰尘时请小心打开过滤器，防止灰尘飞溅

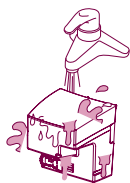

**3** 集尘盒和过滤器分离后，用清水将集尘盒清洗干净。

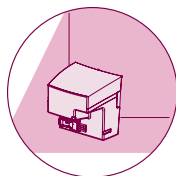

**4** 将集尘盒放置于通风良好，避光处充分晾干后，再使用。

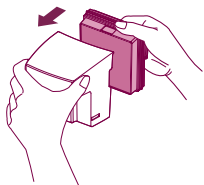

**5** 将过滤器（海绵过滤器和HEPA过滤器）。插入集尘盒

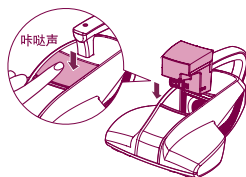

**6** 将集尘盒插入吸尘器主体内，向下按直到听到“咔哒”的声音

\*如果集尘盒没有完全插入机体内，会降低使用时的吸力

**警告：**使用时请将集尘盒和过滤器结合紧密后，再装入吸尘器

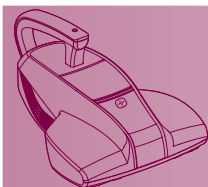

## 过滤器的拆分/清洁

### 拆卸方法

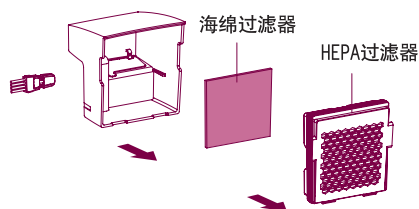

如上图所示，将过滤器从集尘盒中分离出来后，再将海绵过滤器从 HEPA 过滤器中分离出来。

### 清洁方法

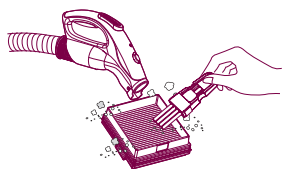

1 使用其他吸尘器或集尘盒上的毛刷对 HEPA 过滤器以及内部间隙进行清理

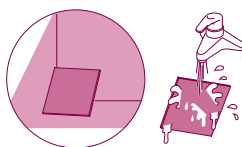

2 用清水将海绵过滤器进行清洗，放置于通风良好的避光处充分晾干后，再使用。

### 安装方法

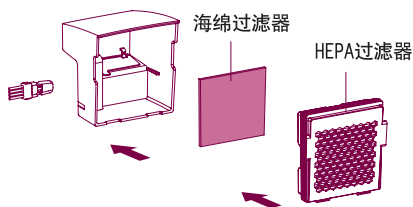

按照拆分相反的顺序进行组装。

## 故障申告前确认的事项

### 故障申告前请先确认

- ▶ 如果您怀疑产品发生故障，请先确认故障发生原因，再与售后服务中心或代理商联系，以确保检修的效率。

故障现象	可能的原因	解决方法
吸尘器吸力下降并发出震动的声响。	<ul style="list-style-type: none"><li>① 进气口或集尘盒被较大的异物堵塞</li><li>② 集尘盒过滤器被细小的灰尘严重堵塞。</li></ul>	<ul style="list-style-type: none"><li>① 用木棍等将堵塞物清理干净</li><li>② 清洗海绵过滤器。</li></ul>
吸尘器不能启动	<ul style="list-style-type: none"><li>① 电源插头没有插好</li><li>② 未按照吸尘器开机操作流程进行操作</li><li>③ 电源插座无电</li></ul>	<ul style="list-style-type: none"><li>① 插好电源插头</li><li>② 按照操作流程操作</li><li>③ 确认电源插座的故障或室内电源是否跳闸。</li></ul>
吸尘器突然停止工作。	<ul style="list-style-type: none"><li>① 本产品具有电机过热保护装置，可能已经启动。此装置启动的原因如下：<ul style="list-style-type: none"><li>- 集尘盒内灰尘过满</li><li>- 过滤器或者进气口被严重堵塞</li><li>- 产品使用时间过长</li></ul></li><li>② 使用此产品时不小心碰到了电源开关或插头</li><li>③ 此产品有以下特点：<ul style="list-style-type: none"><li>当手离开吸尘器手柄三秒钟后，吸尘器会自动停止工作并处于待机状态</li><li>当手离开吸尘器手柄一分钟后，吸尘器将自动进入关机状态</li></ul></li></ul>	<ul style="list-style-type: none"><li>① 将集尘盒、过滤器和进气口堵塞物清理干净，然后等待大概40分钟左右，此产品的电机过热保护装置会自动解除，之后可以继续正常使用。</li><li>② 再次按动开关或者插好插头并按动开关后即可。</li><li>③ 非故障，产品自身特点。</li></ul>
吸尘器只震动但无吸力。	<ul style="list-style-type: none"><li>① 同故障3，由于吸尘器突然停止工作造成无吸力</li><li>② 过滤器或集尘盒堵塞严重</li><li>③ 进气口堵塞严重</li></ul>	<ul style="list-style-type: none"><li>① 同故障3</li><li>② 使用前清理过滤器和集尘盒</li><li>③ 使用前清除进气口堵塞物</li></ul>
吸尘器存放底座不能正常工作。	<ul style="list-style-type: none"><li>① 电源插头没有插好</li><li>② 吸尘器主机没有按正确方法放入底座中</li><li>③ 紫外线灯未能正常工作</li></ul>	<ul style="list-style-type: none"><li>① 插好电源插头</li><li>② 按照说明书的操作提示将吸尘器主机放入底座中</li><li>③ 紫外线灯的工作温度是5℃到60℃之间，请在这个温度下使用吸尘器存放底座</li></ul>

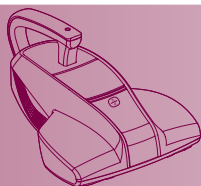

## 故障申告前确认的事项

故障现象	可能的原因	解决方法
机体内有异味	<ul style="list-style-type: none"><li>① 由于机器含有橡胶部件，新购买的机器（3个月内）可能会有轻微的橡胶味道。</li><li>② 当电机正常运转时，用于固定电机的橡胶圈会因为受热而产生少量气味。</li><li>③ 长时间使用吸尘器，异味可能会由集尘盒中的灰尘产生。</li></ul>	<ul style="list-style-type: none"><li>① 不会影响健康，可放心使用。</li><li>② 不会影响吸尘器正常运行或者造成损坏，可放心使用。</li><li>③ 及时清理集尘盒并且用清水洗净晾干后再次使用。</li></ul>
机体排出的气体过热	<ul style="list-style-type: none"><li>① 机体排出的热气是由气流在冷却电机时受热导致的。</li></ul>	<ul style="list-style-type: none"><li>① 正常现象，可放心使用。</li></ul>
机体内有噪音	<ul style="list-style-type: none"><li>① 部分噪音可能来自吸尘器的进气口，这是由于高功率电机叶轮的高速旋转引起的。另外可能来自于吸尘器前端的震动板，这是由于拍打功能而引起的。</li><li>② 集尘盒没有完全组装到机体上。</li></ul>	<ul style="list-style-type: none"><li>① 正常现象，可放心使用。</li><li>② 将集尘盒按照说明书提示安装到位。</li></ul>

# 装箱单

## 装箱单

吸尘器 .....	一个
吸尘器存放底座 .....	一个
说明书 .....	一本
保修卡 .....	一份

## Table of contents

Product specifications .....	14
Attention before using the appliance .....	15-16
The cleaner parts description .....	17
Product using instructions .....	18
Using the product .....	19
How to Wash Inlet .....	20
Disassembling	
Cleaning	
Assembling	
How to empty, clean and assemble the dust tank .....	21
How to Separate/Clean Dust Filter .....	22
Disassembling	
Cleaning	
Assembling	
Check before reporting the trouble .....	23-24
Packing List .....	25

## Product specifications

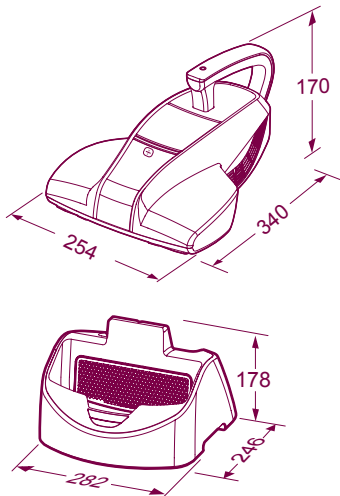

Model: VH900\*DS

Voltage rating: 220V~ 50Hz

IEC: 380W

Net weight: 2.1Kg(Vacuum cleaner), 1.1Kg(Station)

Power cord length: 5m(Vacuum cleaner),  
1.5m(Station)

Dimension: 254mm×340mm×170mm(Vacuum cleaner)  
282mm×246mm×178mm(Station)

This appliance complies with the following

GB directives: GB4706.1-2005

GB4706.7-2004

GB17625.1-2003

GB4343.1-2009

※ You will not be informed if any changes  
appearance and standard deriving  
improvement of product quality.

# Attention before using the appliance

## Attention before using the appliance

Please read all the following information, which contains important instructions for the safety, the use of the appliance.



### DANGER

May immediately cause serious injury or death.



### WARNING

May possibly cause serious injury or death.



### ATTENTION

May possibly cause losses of property or light injury.



### DANGER

Do not pick up anything that is burning or smoking, such as cigarettes, matches or hot ashes.



Please turn off the power before pulling out the plug to prevent fire or electric shock. Never handle plug or appliance with wet hands. (Do not use the appliance on the power above 220V.)

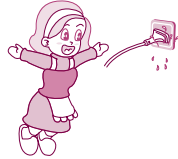

### WARNING

Do not vacuum the objects like hair ball or big paper ball, please clean it in time when it block.

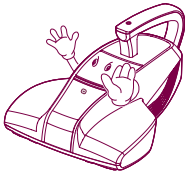

To avoid the danger of fire or electric shock, do not vacuum liquid, blade, flammable substances, or small particles like cement and gesso in cleaning.



Independently use a socket when the current is  $\geq 15A$ . It may cause fire when many electric appliances share one socket. In order to avoid the needless danger, you had better not use the prolonged thread of power cord.

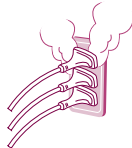

Unplug cleaner when not in use. Turn off all controls before unplugging.

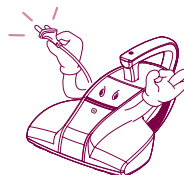



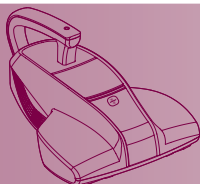

## Attention before using the appliance



### WARNING

Do not let the power cord near the electric heater or other heat source, lest that the cleaner should be deformed or it should cause fire. Do not use the appliance when the power cord or plug is damaged. The damaged power cord or plug must be replaced in the approved service station.



Close supervision is necessary when any appliance is used by or near children. Do not allow vacuum cleaner to be used as a toy or to run unattended at any time.



Do not use the appliance on hard surface such as floor or desk and so on.

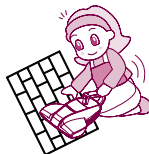

Do not operate the appliance for long when the inlet is blocked, which may have it deformed or damaged.



In using the appliance, pay attention to the electrostatic effect generated on the and cleaner body.

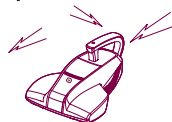

### ATTENTION

Do not allow the non-professional maintenance people to repair.

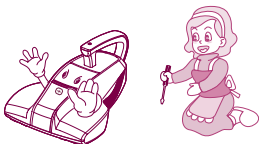

Do not pull or carry by cord, use cord as a handle, close door on cord or pull cord around sharp edges or corners. Do not run appliance over cord. Keep cord away from heated surfaces.

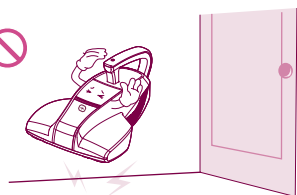

Do not use without dust tank or filters in place. Change tank frequently when picking up very fine materials such as powder.

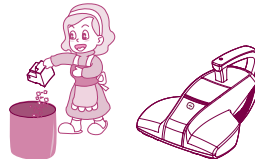

Keep hair, loose clothing, fingers, feet and all parts of body away from the nozzle or movable portion.

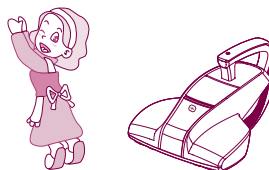

# The cleaner parts description

## Parts Description

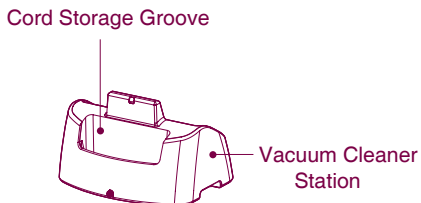
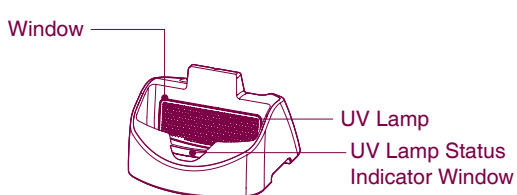
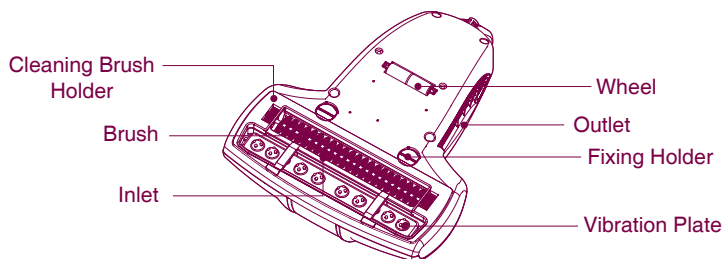
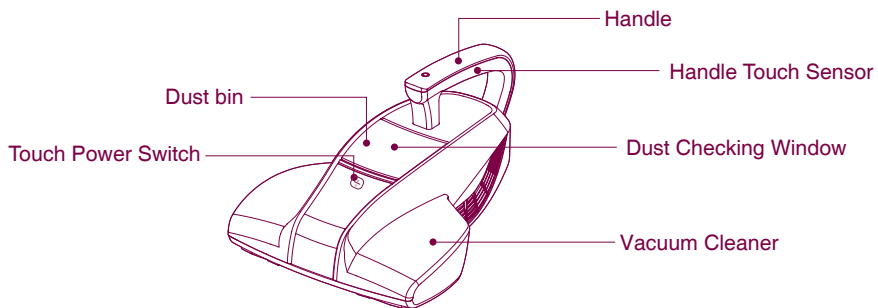

# Product using instructions

## Product using instructions

### Use it as shown in the diagram

- 1 Insert the power cord into the power socket.

When the power cord is inserted into the power socket, it makes a sound with 'ddee~' sound.



- 2 Touch switch at the power indicator part must be pressed for operation. If touch switch is pressed while power indicator lamp is in standby state(off), the lamp is converted to operation(blue) state with a buzzer sound'ddee~' (No operation is done, and it is the standby state. If you hold the handle in this state, it actually starts the operation.)



- 3 If you hold the handle, it inhales from the bedding.
- The handle sensor is a safety device to prevent the operation by the power touch switch being pressed by mistake, and the operation finally starts when the handle is held and it is sensed.
- \* When touch switch is pressed while the handle is held, it immediately starts.



- 4 Releasing the handle for a moment
- After 3 seconds after releasing the handle, it stops the inhaling from the bedding. (The power indicator part is blue lamp state.)
  - If the state of releasing the handle, operation stopped, and not holding the handle continues, after 1 minute, the power indicator part is turned off with buzzer sound 'ddeeriri~', and it becomes turn off state.

- If you hold the handle within 1 minute, it restarts the inhaling from the bedding.



- 5 When you want to stop the operation.
- Even if you hold the handle, when you press the touch switch of the power indicator part, the operation stops with the buzzer sound "ddee~", and the lamp is turned off.
  - If you want the operation again, it can be done with the normal operation procedure.

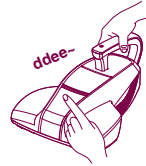

- 6 When you use vacuum cleaner station
- Insert the power plug of the station into the power socket.
  - Make sure to check if the power is turned off before placing the main body on the station.
  - When you place main body on the station according to the grooves, blue lamp on the front panel window is turned on, and UV lamp starts operation for the ultraviolet irradiation at the same time.
  - If it passes about 5 minutes after placing the main body, the front panel window lamp and UV lamp are automatically turned off at the same time, and the ultraviolet irradiation is completed. If you want to repeat ultraviolet irradiation, please lift the main body and place it on the station again.
- \* If placing and removing is repeated while it does not pass 5 minutes, it is turned off when it passes 5 minutes from the last placement.



# Using the product

## Product specifications

Use it as shown in the diagram

- Bed Mattress, Bed Cover

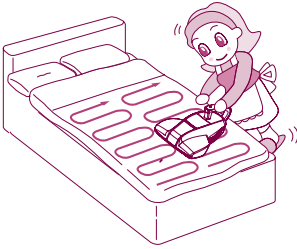

Beddings: Mattress, Bed Cover

Divide the target space to half, and use it pushing and pulling back and forth from the end.

- Pillows, Cushions, etc



Pillows: Large cushion, normal cushion, pillow

The targets are narrow, so place the cleaner on it and use it by pushing and pulling back and forth.

- Thin cover

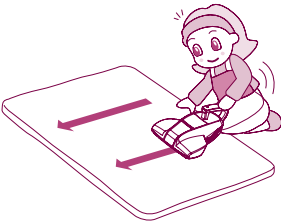

Blankets: Thick cover, thin cover

Use it by pulling back and forth the entire space.

- Thick covers with fillings

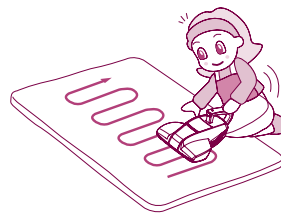

Others: Sofa

General Cleaning Type.

### CAUTION

Unlike general handy type products, this product is not to be held and used, but is to place on the cleaning target and to clean the fine dust by pressing the target with the weight of the product, so do not use it to inhale big foreign objects.

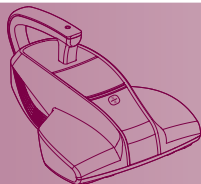

## How to Wash Inlet

### Disassembling

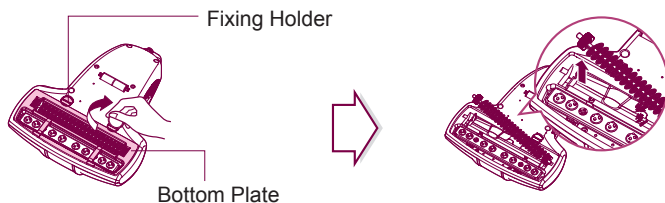

Place a soft cloth on the floor, and flip over the main body on it. Check for foreign objects, turn the 2 fixing holders 90° clockwise with linear shape screwdriver or similar tools and separate the bottom plate by pulling it up. Hold the roller brush and separate it by lifting it up.

### Cleaning

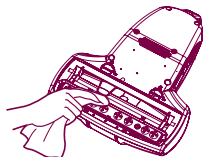

- 1 Wipe the dirty surfaces of inlet main body with a rag.

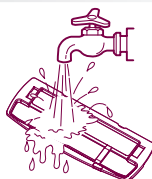

- 2 Wash the separated bottom plate with water and dry it in a shade.

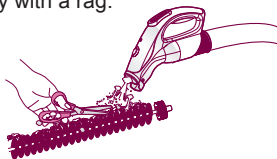

- 3 Clean the roller brush with other vacuum cleaner or scissors.

### Assembling

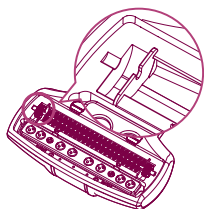

- 1 Insert the fixing hooks on both sides of the roller brush matching the roller brush fixing grooves.

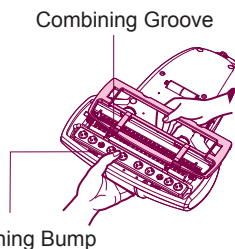

- 2 Insert the fixing guide at the front of the bottom plate according to the fixing groove of the main body, turn 2 fixing holders 90° counterclockwise with linear shape screwdriver or similar tools, and fix it.

# How to empty, clean and assemble the dust tank

## How to used the product

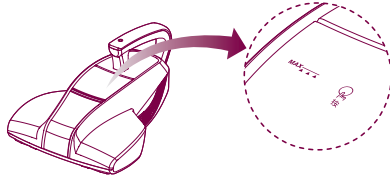

**MAX**



If the nap and fine dust are filled up to the empty line, it is the time to clean the filter, so empty the dust inside the dust bin, separate and clean the filter, before using it again.

## How to clean the dust tank

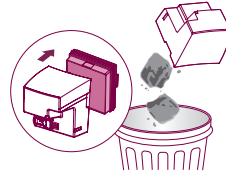
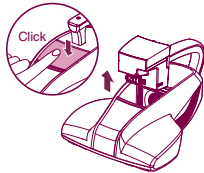

- 1 Press the top part of the dust bin until it sounds "click", and at the same time releasing the hand, take out the risen dust bin from the main body.



- 2 Hold both ends, open the filter (sponge filter + HEPA filter), and empty the dust. In order to avoid dust clouds, please open the filter (sponge filter + HEPA filter) carefully when you empty the dust.

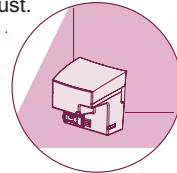

- 3 After separating dust bin and filter, wash dust bin cleanly with running water.

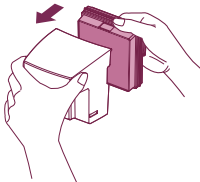

- 4 Dry in a shade with good ventilation for about a day, and use it again.

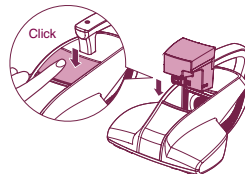

- 5 Insert Filter (Sponge filter + HEPA filter) into dust bin.

- 6 Insert dust bin into main body, and push down until it sounds "click".  
\* If dust bin is not completely assembled, the inhaling may be weakened.

 **Caution:** Use it after dust bin and filter are combined exactly.



# How to Separate/Clean Dust Filter

## Disassembling

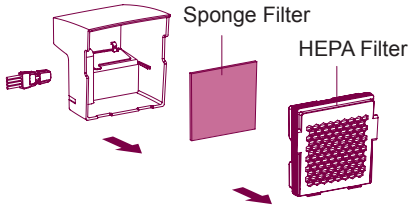

After separating the filter from dust bin, separate sponge filter from HEPA Filter as in the figure.

## Cleaning

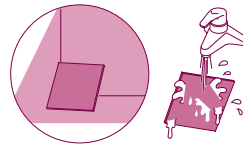
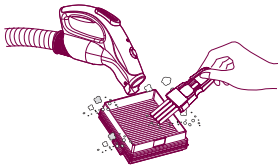

- 1 Clean the filter by cleaning the HEPA filter and the gaps around the filter using the brush on the dust tank or other vacuum cleaner.
- 2 Wash Sponge Filter in a running water, and completely dry it in a shade with good ventilation for about a day before using it again.

## Assembling

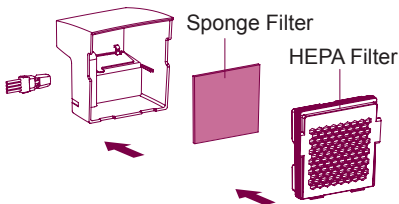

Assemble in the reverse order of disassembly.

# Check before reporting the trouble

## Please check before notifying malfunction

- If you doubt the product meets with malfunction, please check the cause of such malfunction before contacting with the after-sales service center or agent, so as to ensure efficiency of repair.

Malfunction	Possible Cause	Possible Solution
Inhaling gets weakened and vibrating sound is heard	<ol style="list-style-type: none"><li>①The inlet or dust bin is blocked by a big foreign object</li><li>②The filters are dirty.</li></ol>	<ol style="list-style-type: none"><li>①Remove the object with sticks, etc.</li><li>②Clean the filter</li></ol>
Cleaner does not work at all	<ol style="list-style-type: none"><li>①The power cord plug is not plugged in the socket properly.</li><li>②Wrong operation procedure of each function</li><li>③Socket no power</li></ol>	<ol style="list-style-type: none"><li>①Plug into the socket properly.</li><li>②Operation under the guide of Manual</li><li>③Make sure the power on of socket</li></ol>
Cleaner stops suddenly	<ol style="list-style-type: none"><li>①This product has inlet motor overheat prevention device, and it may stop temporarily when the following cases occur.<ul style="list-style-type: none"><li>– If it is used when dust and wastes are full in dust bin and filters.</li><li>– If it is used with the inlet blocked</li><li>– If the product is used excessively for a long time</li></ul></li><li>② When touch switch was operated by other touches</li><li>③ If handle of the main body is released during the operation, if 3 seconds pass, the operation automatically stops, and after about 1 minute, it converts to standby state.</li></ol>	<ol style="list-style-type: none"><li>①Clean the filter, dust bin and remove the items that cause clogging firstly, then it can be used normally when the protection device is released after about 40 minutes.</li><li>②Press the switch again or plug and press the switch again to let the power on</li><li>③It is the character of this product, just use it normally.</li></ol>



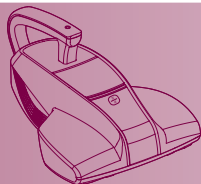

## Check before reporting the trouble

Malfunction	Possible Cause	Possible Solution
It only vibrates, but no inhaling	<ul style="list-style-type: none"><li>① Same to Malfunction 3, the suddenly power stop cause no inhaling</li><li>② Filter or dust bin is badly clogged</li><li>③ Inlet is badly clogged</li></ul>	<ul style="list-style-type: none"><li>① Same to Malfunction 3</li><li>② Clean the filter or dust bin before using</li><li>③ Remove the items that cause the clogging</li></ul>
Vacuum cleaner station does not work	<ul style="list-style-type: none"><li>① The power cord plug is not plugged in the socket properly.</li><li>② The main body is not placed on the station properly.</li><li>③ UV lamp does not work properly.</li></ul>	<ul style="list-style-type: none"><li>① Plug into the socket properly.</li><li>② Place the main body on the station under the guide of manual.</li><li>③ UV lamp's normal working temperature is 5°C to 60°C, please make sure using vacuum cleaner station under working temperature.</li></ul>
Odor comes out of the cleaner	<ul style="list-style-type: none"><li>① It is a new product for 3 months from the purchase, so it may smell rubbers.</li><li>② When the cleaner is running, the inner rubber mounting would give off less smell</li><li>③ It is used for a long time, odor is caused by the dust in the dust bin.</li></ul>	<ul style="list-style-type: none"><li>① No harm to healthy, Do not worry</li><li>② It would not make damage or have bad effect on running cleaner. Do not worry</li><li>③ Empty the dust bin and use it after washing.</li></ul>
Hot air comes out, and main body is hot?	<ul style="list-style-type: none"><li>① The air coming out of the outlet is the wind after cooling the motor heat.</li></ul>	<ul style="list-style-type: none"><li>① Normal status. Do not worry.</li></ul>
Big noise coming from the cleaner?	<ul style="list-style-type: none"><li>① It is the sound of the motor's high speed rotation by high power of cleaner's inlet, or the sound from the front of the nozzle is caused by punching function,</li><li>② Dust bin is not assembled properly.</li></ul>	<ul style="list-style-type: none"><li>① Normal status. Do not worry</li><li>② Assemble the dust bin properly under the guide of manual.</li></ul>

# Packing list

## Packing list

- Vacuum Cleaner ..... 1
- Vacuum Cleaner Station ..... 1
- Owner's Manual ..... 1
- Card service ..... 1

如有问题

瞬间感动 Moment Of Truth  
LG 售后

请打电话



400-819-9999

售后热线

一号通

乐金电子电器有限公司

制造商地址：韩国首尔市永登浦区汝矣岛洞20号

生产厂地址：中国·天津·北辰区·津围公路9号

传真：022-26903476

邮编：300402

全国技术服务中心服务咨询电话：400-819-9999



<http://www.lg.com/cn>