



ENGLISH

OWNER'S MANUAL

Sound bar

Please read this manual carefully before operating your set and retain it for future reference.

NB5630A (NB5630A, S73A1-D)



MFL68023404

Safety Information



CAUTION: TO REDUCE THE RISK OF ELECTRIC SHOCK DO NOT REMOVE COVER (OR BACK) NO USER-SERVICEABLE PARTS INSIDE REFER SERVICING TO QUALIFIED SERVICE PERSONNEL.



This lightning flash with arrowhead symbol within an equilateral triangle is intended to alert the user to the presence of uninsulated dangerous voltage within the product's enclosure that may be of sufficient magnitude to constitute a risk of electric shock to persons.



The exclamation point within an equilateral triangle is intended to alert the user to the presence of important operating and maintenance (servicing) instructions in the literature accompanying the product.

WARNING: TO PREVENT FIRE OR ELECTRIC SHOCK HAZARD, DO NOT EXPOSE THIS PRODUCT TO RAIN OR MOISTURE.

CAUTION: The apparatus shall not be exposed to water (dripping or splashing) and no objects filled with liquids, such as vases, shall be placed on the apparatus.

WARNING: Do not install this equipment in a confined space such as a book case or similar unit.

CAUTION: Do not block any ventilation openings. Install in accordance with the manufacturer's instructions.

Slots and openings in the cabinet are provided for ventilation and to ensure reliable operation of the product and to protect it from over heating. The openings shall be never be blocked by placing the product on a bed, sofa, rug or other similar surface. This product shall not be placed in a built-in installation such as a bookcase or rack unless proper ventilation is provided or the manufacturer's instruction has been adhered to.

CAUTION concerning the Power Cord

Most appliances recommend they be placed upon a dedicated circuit;

That is, a single outlet circuit which powers only that appliance and has no additional outlets or branch circuits. Check the specification page of this owner's manual to be certain. Do not overload wall outlets. Overloaded wall outlets, loose or damaged wall outlets, extension cords, frayed power cords, or damaged or cracked wire insulation are dangerous. Any of these conditions could result in electric shock or fire. Periodically examine the cord of your appliance, and if its appearance indicates damage or deterioration, unplug it, discontinue use of the appliance, and have the cord replaced with an exact replacement part by an authorized service centre. Protect the power cord from physical or mechanical abuse, such as being twisted, kinked, pinched, closed in a door, or walked upon. Pay particular attention to plugs, wall outlets, and the point where the cord exits the appliance. To disconnect power from the mains, pull out the mains cord plug. When installing the product, ensure that the plug is easily accessible.

This device is equipped with a portable battery or accumulator.

Safety way to remove the battery or the battery from the equipment: Remove the old battery or battery pack, follow the steps in reverse order than the assembly. To prevent contamination of the environment and bring on possible threat to human and animal health, the old battery or the battery put it in the appropriate container at designated collection points. Do not dispose of batteries or battery together with other waste. It is recommended that you use local, free reimbursement systems batteries and accumulators. The battery shall not be exposed to excessive heat such as sunshine, fire or the like.

Table of Contents

1 Getting Started

- 2 Safety Information
- 4 Unique features
- 4 Introduction
 - 4 – Symbols used in this manual
- 4 Accessories
- 5 Remote control
- 7 Front panel
- 8 Rear panel
- 9 Mounting the main unit on a wall

2 Connecting

- 11 Connection and setting up
 - 11 – Connecting the AC adapter
 - 11 – OPTICAL In connection
- 12 – Pairing wireless subwoofer

3 Operating

- 13 Basic operations
- 13 LG Sound Sync
 - 14 – AUTO POWER On/Off
- 14 Using Bluetooth technology
 - 15 – Listening to music stored on the Bluetooth devices
- 16 Other operations
 - 16 – Turn off the sound temporarily
 - 16 – Adjust the woofer level settings
 - 16 – 3D Sound effect
 - 16 – DRC (Dynamic range control)
 - 16 – Auto power down

4 Troubleshooting

- 17 Troubleshooting

5 Appendix

- 18 Specifications
- 19 Trademarks and licenses
- 19 Maintenance
 - 19 – Handling the unit

1

2

3

4

5

1

Getting Started

Unique features

LG Sound Sync

Controls volume level of this unit by the remote control of your LG TV that is compatible with LG Sound Sync.

Bluetooth

Enjoys music from bluetooth device with simple connection.

Introduction

Symbols used in this manual

 **Note**

Indicates special notes and operating features.

 **Caution**

Indicates cautions for preventing possible damages from abuse.

Accessories

Please check and identify the supplied accessories.

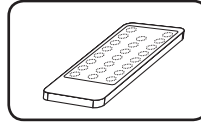

Remote control (1)

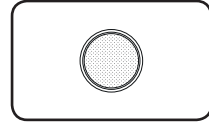

Battery (1)

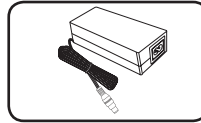

AC adapter (1)

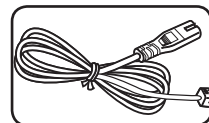

Power cord (1)

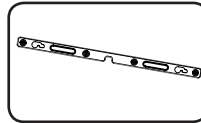

Wall bracket (1)

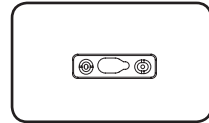

Wall bracket (2)

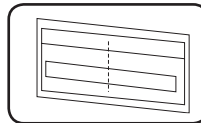

WALL BRACKET
INSTALL GUIDE (3)

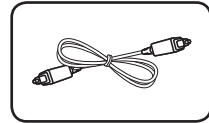

Optical cable (1)

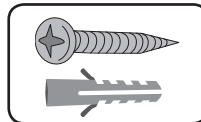

Screw (8) & Wall Plug (8)

Remote control

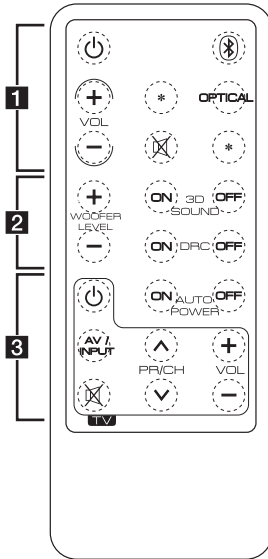

! Note

- Once the sound bar is shut down to standby, please wait several seconds before trying to use remote again.
- When you press any button on the remote control, the red LED on the main unit blinks twice. (Except (Power) button)
- The color LED that indicates the current function is lit up for about 3 seconds when you press the function buttons: , **OPTICAL**.
- If the volume level reached a minimum or a maximum, the red LED on the unit is lit up when you adjust the volume level of the sound bar.
- If the woofer level reached a minimum or a maximum, the red LED on the unit is lit up when you adjust the woofer level of the wireless subwoofer.

..... **1**

(Power) : Switches the unit ON or OFF.

VOL +/- : Adjusts speaker volume.

***** : The button is not available for any function.

(Mute) : Mutes the sound.

: Select Bluetooth function.

OPTICAL : Select Optical function.

***** : The button is not available for any function.

..... **2**

WOOFER LEVEL +/- : Sets the sound level of woofer speaker.

3D SOUND : Turns on and off the 3D Sound mode.

DRC : Sets DRC(Dynamic range control) function.

..... **3**

AUTO POWER : This function is automatically turned on the unit.

TV Control buttons: Controls the TV. (LG TV only)

You can control the functions on LG TV : Power, input source, sound level, channels.

Battery Installation

1. Turn the battery cover counterclockwise by using a coin. Then take the battery cover.

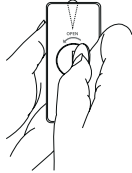

Coin

2. Insert and fix the battery with the minus (-) facing in the same direction as the minus (-) on the battery compartment.

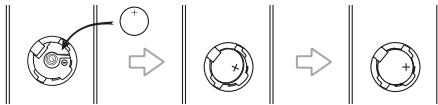

3. Put the battery cover on the remote control and turn it clockwise to close.

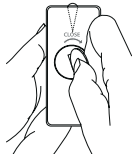

Coin

Caution

If you have long nails, do not open the battery cover by using your finger. Or else, your nail would be broken.

Warning

DO NOT INGEST BATTERY. CHEMICAL BURN HAZARD

Caution

- The battery used in this device may present a fire or chemical burn hazard if mistreated. Do not recharge, disassemble, incinerate, or heat above 100 °C (212 °F). Replace the battery part no. CR2025 only. Use of another battery may present a risk of fire or explosion. Dispose of used battery. Keep battery away from children. Do not disassemble or dispose of in fire.
- [The remote control supplied with] This product contains a coin/button cell battery. If the coin/button cell battery is swallowed, it can cause severe internal burns in just 2 hours and can lead to death. Keep new and used batteries away from children. If the battery compartment does not close securely, stop using the product and keep it away from children. If you think batteries might have been swallowed or placed inside any part of the body, seek immediate medical attention.

Front panel

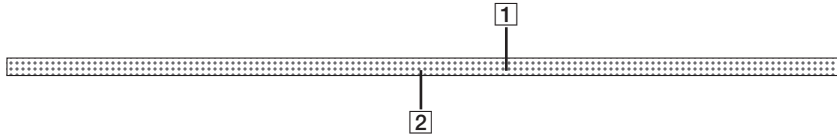

- 1** Remote sensor
- 2** LED indicator

You can check the current state of the sound bar by the color LED on it. Refer to the table below.

LED State \ LED Color	Red	Orange	Green
Off	Power on or disconnected power cord		
On	Stand by	-	-
Blink (Twice per second)	Booting	Bluetooth ready	-
Blink (Once per second)	Mute	-	-
On -> Off (After 3 seconds)	-	Bluetooth paired	Optical function selected

Rear panel

1
Getting Started

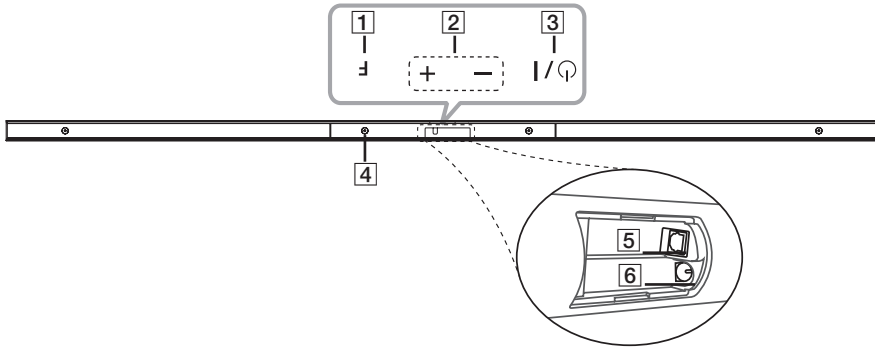

- 1** **F** (Function)
Press it repeatedly to select other function.
- 2** **+ / -** (Volume)
Adjusts speaker volume.
- 3** **⏻ / |** (Standby/On).
- 4** Shaft
- 5** Optical input
- 6** DC input

! Caution

Precautions in using the touch buttons

- Use the touch buttons with clean and dry hands.
 - In a humid environment, wipe out any moisture on the touch buttons before using.
- Do not press the touch buttons hard to make it work.
 - If you apply too much strength, it can damage the sensor of the touch buttons.
- Touch the button that you want to work in order to operate the function correctly.
- Be careful not to have any conductive material such as metallic object on the touch buttons. It can cause malfunctions.

Mounting the main unit on a wall

Mounting the main unit on a wall, you should connect all the cables for operating the unit. For details, refer to the page 11.

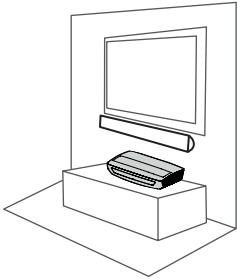

You can mount the main unit on a wall. Prepare screws and brackets.

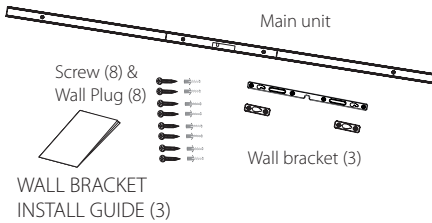

Caution

- The set may be damaged if the set falls down on its side.
- Please do not lift the set by holding only center part alone.
- Please two people should lift the set by sides when moving it.

1. Fitted with Bracket Center Guide according to Screen Center and Bottom Line.

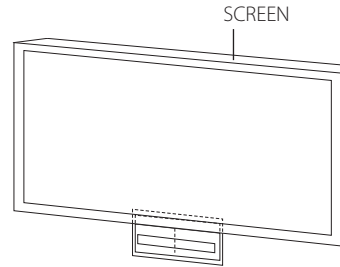

2. When you mount it on a wall (concrete), use the wall plugs. You should drill some holes. A guide sheet (WALL BRACKET INSTALL GUIDE) is supplied to drill. Use the sheet to check the point to drill.

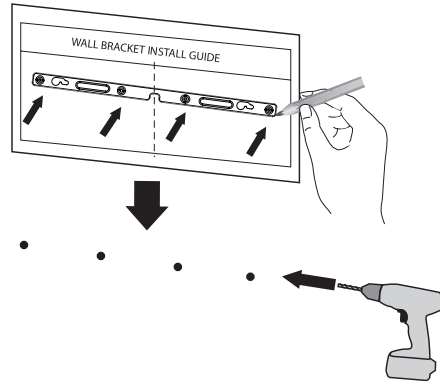

Note

Make sure that the triangle mark on the wall bracket should be facing upwards.

3. Remove the Wall bracket install guide.
4. Fix it with screws as shown in the illustration below.

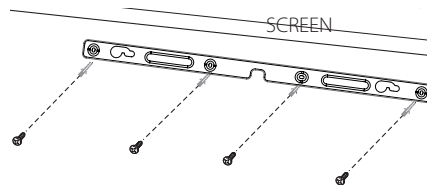

1

Getting Started

! Note

The order of installation wall mount bracket center screw

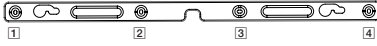

1. After inserting the [3] screw adjust the left and right center.
2. After ensuring the flatness insert [2] screw.
3. [1], [4] screw fixation after inserting [2], [3] screw.

5. Prefixed with bracket left / right guide according to screen side and bottom line.
6. Remove the wall bracket install guide.
7. Fix it with screws as shown in the illustration below.

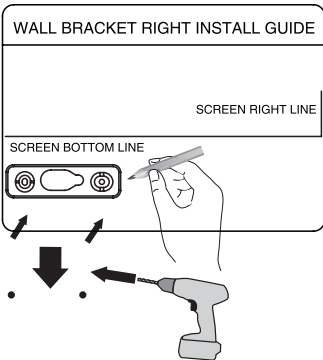
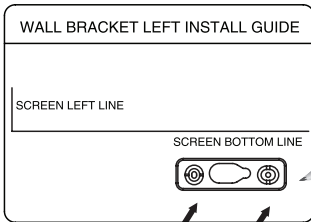

! Note

The order of installation wall mount bracket side screw



1. Tightening the [2] screw.
2. Then, aligning the flatness tighten the [1] screw.
3. Confirmed the position of the screws after [1], [2] screw loose while checking flatness.

Screen and wall-bracket position



8. Hang the main unit onto the bracket as shown below.

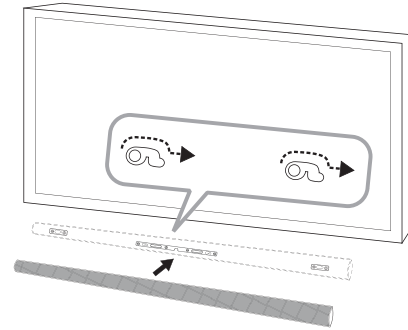

Caution

- Do not install this unit upside down. It can damage the parts of this unit or be the cause of personal injury.
- Do not hang onto the installed unit and avoid any impact to the unit.
- Secure the unit firmly to the wall so that it does not fall off. If the unit falls off, it may result in an injury or damage to the product.
- When the unit is installed on a wall, please make sure that a child does not pull any of connecting cables, as it may cause it to fall.

Note

Detach the unit from the bracket as shown below.



Connection and setting up

Connecting the AC adapter

Prior to installing the wall mount, first connect the cable.

1. Connect the supplied AC power cord to the AC adapter.
2. Connect the AC adapter cable to DC. IN adapter input.
3. Plug the AC power cord into an AC outlet.

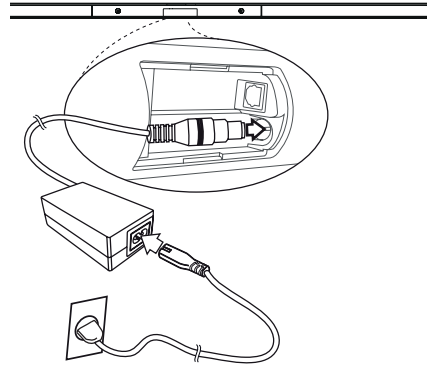
**Caution**

Only use the AC adapter supplied with this device. Do not use a power supply from another device or manufacturer. Using any other power cable or power supply may cause damage to the device and void your warranty.

OPTICAL In connection

Connect the OPT. IN jack on the back of the unit to OPTICAL OUT jack on the Cinema beam TV using an OPTICAL cable.

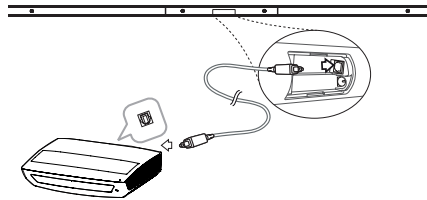

Pairing wireless subwoofer

Setting up the wireless subwoofer for the first time

1. Connect the power cord of the wireless subwoofer to the outlet. The Yellow-green LED on the subwoofer starts to blink.
2. Turn on the main unit. The red LED on it starts to blink and then the main unit and the subwoofer will be automatically connected.

When connection is completed, the Yellow-green LED on the subwoofer is turned on and the green LED on the main unit is lit up for about 3 seconds.

Manually pairing wireless subwoofer

When the connection has been failed between the main unit and the wireless subwoofer, the red LED on the subwoofer is turned on. To pair them, follow the steps below.

1. Press **PAIRING** on the back of the subwoofer. The Yellow-green LED on the wireless subwoofer starts to blink.
2. Press and hold **—** (Volume) on the unit and **⊗** (Mute) on the remote control at the same time. The green LED on the main unit starts to blink.
3. After the Yellow-green LED on the subwoofer is turned on, press the buttons on step 2 again. The connection will be completed.

Information of the color LED indicators

State	Sound bar LED	Wireless subwoofer LED
Standby	Red	Red
Initial pairing	Red (Blink)	Yellow-green (Blink)
Pairing	Green (Blink)	Yellow-green (Blink)
Connected	Green → Off	Yellow-green
Disconnected	Off	Yellow-green (Blink) → Red

! Note

- If you operate main unit then wireless subwoofer sound within a few seconds in standby mode.
- Set the distance between this unit and wireless subwoofer within 10 m.
- Optimum performance can be implemented only when the unit and the Wireless subwoofer within distance of 2 m to 10 m is used since communication failure may occur if longer distance is used.
- It takes a few seconds (and may take longer) for the unit and subwoofer to communicate with each other.

Basic operations

LG Sound Sync

Sound Sync[®] Optical

You can control some functions of this unit by your TV's remote control with LG Sound Sync. It is compatible with the LG TV that is supported LG Sound Sync. Make sure of the LG Sound Sync logo on your TV.

Controllable function by LG TV's remote control :
Volume up/down, mute.

Refer to the TV's instruction manual for the details of LG Sound Sync.

Make one of the following connections, depending on the capabilities of your equipment.

! Note

- You can also use the remote control of this unit while using LG Sound Sync. If you use TV's remote control again, the unit synchronizes with the TV.
- When the connections failed, make sure of the condition of the TV and power of it.
- Make sure of the condition of this unit and the connection in the cases below when using LG Sound Sync.
 - Turned off the unit.
 - Changing the function to the others.
 - Disconnecting the optical digital audio cable.

With wired connection

1. Connect your LG TV to the unit by using an optical digital cable. (Refer to the page 11.)

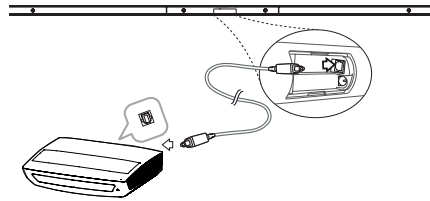

2. Set up LG Sound Sync (Optical) on the TV. Refer to the TV's instruction manual.
3. Turn on the unit by pressing  (Power) on the remote control.
4. Select OPTICAL function by using **OPTICAL** on the remote control.

Green LED on the unit is lit up for about 3 seconds and you can listen to the TV's sound.

! Note

The amount of time to turn off this unit is different depending on your TV when you set AUTO POWER function to ON.

AUTO POWER On/Off

This function automatically turns on/off the unit when you turn on/off the TV or the external device (DVD Player, Blu-ray Disc Player, etc.) connected to this unit.

It is supported only on OPTICAL functions.

Turn on or off AUTO POWER function by using **AUTO POWER ON/OFF** on the remote control.

! Note

- This function is intentionally designed to turn off the unit after 1 minute of inactivity. If you did not connect external devices with optical cable or there is no digital audio signal going to the unit, the unit will turn off after 1 minute of inactivity if AUTO POWER function is turned on.
- Depending on the connected device, this function may not operate.
- It is not available to turn on the unit by AUTO POWER function if you turn off the unit directly.
- On bluetooth function, this unit may be turned on by AUTO POWER function depending on the connected bluetooth device. But in this case, this unit will be turned off automatically.

Using Bluetooth technology

About Bluetooth

Bluetooth is wireless communication technology for short range connection.

The available range is within 10 meters. (The sound may be interrupted when there is interference by the other electronic waves which run on same frequency or if you connect bluetooth devices in the other rooms nearby.)

Connecting individual devices under **Bluetooth®** wireless technology does not incur any charges. A mobile phone with **Bluetooth®** wireless technology can be operated via the Cascade if the connection was made via **Bluetooth®** wireless technology.

Available Devices : Mobile phone, MP3, Laptop, PDA etc.

Bluetooth profiles

In order to use **Bluetooth®** wireless technology, devices must be able to interpret certain profiles. This unit is compatible with following profile.

A2DP (Advanced Audio Distribution Profile)

Listening to music stored on the Bluetooth devices

Pairing this unit and Bluetooth device

Before you start the pairing procedure, make sure the Bluetooth feature is turned on in your Bluetooth device. Refer to your Bluetooth device's user guide. Once a pairing operation is performed, it does not need to be performed again.

1. Select the Bluetooth function by using  on the remote control. Then the orange LED on the unit starts to blink.
2. Operate the Bluetooth device and perform the pairing operation. When searching for this unit with the Bluetooth device, a list of the devices found may appear in the Bluetooth device display depending on the type of Bluetooth device. Your unit appears as "LG SOUND BAR (XX:XX)".

Note

XX:XX means the last four digits of BT address. For example, if your unit has a BT address such as 9C:02:98:4A:F7:08, you will see "LG SOUND BAR (F7:08)" on your Bluetooth device.

3. Enter the PIN code.
PIN code : 0000

Note

Depending on the Bluetooth device type, some device have a different pairing way.

4. The orange LED is lit up for about 3 seconds when this unit successfully paired with your Bluetooth device.
5. Listen to music.
To play a music stored on your Bluetooth device, refer to your Bluetooth device's user guide.

Note

- You should connect your Bluetooth device to this unit again when you restart it.
- The unit connects automatically to the Bluetooth device which is connected latest, when you select Bluetooth function again after changing to the other functions.
- The sound may be interrupted when the connection interfered by the other electronic wave.
- You cannot control the Bluetooth device with this unit.
- Pairing is limited one Bluetooth device per one unit and multi-pairing is not supported.
- Although the distance between your Bluetooth and the set is less than 10 m, there are obstacles between both, your Bluetooth device cannot be connected.
- Depending on the type of the device, you may not be able to use the Bluetooth function.
- You can enjoy wireless system using phone, MP3, Notebook, etc..
- When not connected the Bluetooth, orange LED is blinking.
- The Electrical malfunction due to devices using same frequency such as Medical equipment, Microwaves or wireless LAN devices, the connection will be disconnected.
- When someone stands and interrupts communication between Bluetooth device and the player, the connection will be disconnected.
- If the gotten away of the distance between Bluetooth and the unit, the sound quality is lower and lower the connection will disconnect when the space between the Bluetooth and the unit gets out of the operating range of Bluetooth.
- The device with **Bluetooth**[®] wireless technology is disconnected, if you turn off the main unit or put the device away from the main unit more than 10 m.

Other operations

Turn off the sound temporarily

You can mute your unit, for example, to answer the telephone.

Press  on the remote control. Red LED blinks and there is no sound on the unit.

To cancel it, press  again on the remote control or change the volume level.

Adjust the woofer level settings

You can adjust the sound level of the wireless subwoofer. Press **WOOFER LEVEL +/-** on the remote control.

Note

If the woofer level reached a minimum or a maximum, the red LED on the sound bar is lit up when you adjust the woofer level of the wireless subwoofer.

3D Sound effect

3D Sound features deliver sound creating a wider spot so you can enjoy more immersive and cinematic surround sound.

Turn on or off 3D Sound effect by using **3D SOUND ON/OFF** on the remote control.

DRC (Dynamic range control)

Make the sound clear when you feel the volume is too low.

Turn on or off DRC by using **DRC ON/OFF** on the remote control.

Auto power down

This unit will turn itself off to save electric consumption in the case were main unit is not connected to external device and is not used for 25 minutes.

But the unit can turns on automatically based on the [AUTO POWER] function you've set.

Troubleshooting

PROBLEM	CAUSE & CORRECTION
No Power	<ul style="list-style-type: none"> The power cord is unplugged. Plug in the power cord. Check the condition by operating other electronic devices.
No sound	<ul style="list-style-type: none"> Incorrect input source is selected. Check the input source and select the correct input source. The mute function is activated. Press  or adjust the volume level to cancel the mute function.
No woofer sound	<ul style="list-style-type: none"> The power cord of woofer is not connected. Plug the power cord into the wall outlet securely. Pairing between the unit and woofer gets disconnected. Connect the unit and woofer. (Refer to the page 12.)
The remote control does not work properly.	<ul style="list-style-type: none"> The remote control is too far from the unit. Operate the remote control within about (7 m). There is an obstacle in the path of the remote control and the unit. Remove the obstacle. The battery in the remote control is exhausted. Replace the battery with new one.
The Auto power on/off function does not work.	<ul style="list-style-type: none"> Depending on the connected device, this function may not operate.
When you sense that outputted sound of the unit is low.	<p>Check the details below and adjust the unit according to them.</p> <ul style="list-style-type: none"> Switch [ON] state of DRC function to [OFF] by using remote controller. With the sound bar connected with TV, change the AUDIO DIGITAL OUT setting on TV Setup Menu from [PCM] to [AUTO] or [BITSTREAM]. With the sound bar connected with Player, change the AUDIO DIGITAL OUT setting on Player Setup Menu from [PCM] to [PRIMARY PASS-THROUGH] or [BITSTREAM]. Change Audio DRC setting on Player setup menu to [OFF] state.

Specifications

General	
Power requirements	Refer to the main label on the main unit.
Power consumption	Refer to the main label on the main unit.
Dimensions (W x H x D)	(2240 x 52 x 27.7) mm
Net Weight (Approx.)	2.62 kg
Operating temperature	41 °F to 95 °F (5 °C to 35 °C)
Operating humidity	5 % to 90 %

Inputs	
DIGITAL IN (OPTICAL IN)	3.0 Vrms (p-p), Optical jack

Amplifier	
Total output	310 W
Stereo mode	80 W + 80 W (4 Ω at 1 kHz)
Wireless subwoofer	150 W (3 Ω at 80 Hz)
THD	10 %

Wireless subwoofer	
Power requirements	Refer to the main label on the wireless subwoofer.
Power consumption	Refer to the main label on the wireless subwoofer.
Type	1 Way 1 Speaker
Impedance	3 Ω
Rated Input Power	150 W
Max. Input Power	300 W
Net Dimensions (W x H x D)	(296 X 332 X 296) mm
Net Weight	7.64 kg

- Designs and specifications are subject to change without prior notice.

Trademarks and licenses



Manufactured under license from Dolby Laboratories. Dolby and the double-D symbol are trademarks of Dolby Laboratories.



Manufactured under license under U.S. Patent Nos: 5,956,674; 5,974,380; 6,487,535 & other U.S. and worldwide patents issued & pending. DTS, the Symbol, & DTS and the Symbol together are registered trademarks & DTS 2.0 Channel is a trademark of DTS, Inc. Product includes software. © DTS, Inc. All Rights Reserved.



Bluetooth® wireless technology is a system which allows radio contact between electronic devices within a max. range of 10 meters.

Connecting individual devices under **Bluetooth**® wireless technology does not incur any charges. A mobile phone with **Bluetooth**® wireless technology can be operated via the Cascade if the connection was made via **Bluetooth**® wireless technology.

The **Bluetooth**® word mark and logos are owned by the **Bluetooth**® SIG, Inc. and any use of such marks by LG Electronics is under license.

Other trademarks and trade names are those of their respective owners.

Maintenance

Handling the unit

When shipping the unit

Please save the original shipping carton and packing materials. If you need to ship the unit, for maximum protection, re-pack the unit as it was originally packed at the factory.

Keeping the exterior surfaces clean

- Do not use volatile liquids such as insecticide spray near the unit.
- Wiping with strong pressure may damage the surface.
- Do not leave rubber or plastic products in contact with the unit for a long period of time.

Cleaning the unit

To clean the player, use a soft, dry cloth. If the surfaces are extremely dirty, use a soft cloth lightly moistened with a mild detergent solution. Do not use strong solvents such as alcohol, benzene, or thinner, as these might damage the surface of the unit.

