

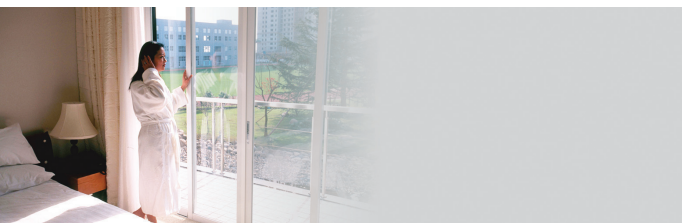

使用说明书



吸尘器

强劲吸力

VC3316GND

中文 ——> 1-12 页

English ——> Page 13-23

售后服务电话



使用前请仔细阅读说明书，阅读完后请妥善保管以备需要时查阅。

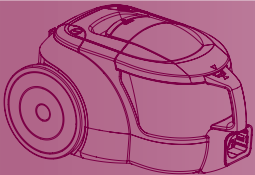

产品规格	2
使用前注意事项	3-4
吸尘器的组装与吸力调节	5
部品名称和连接方法	
附件	
各种附件刷头的使用及清洁方法	6-7
毛刷、尖吸嘴、鸭嘴的使用	
角落刷头使用及清洁方法	
地板地毯刷头的使用方法	
集尘桶/电机保护过滤海绵的拆卸、清洗及安装方法	8
排气过滤器的拆卸/清洁/安装方法	9
拆卸方法	
清洗方法	
安装方法	
故障通告前需确认事项	10-11
故障通告前请先确认	
装箱单	12

产品规格

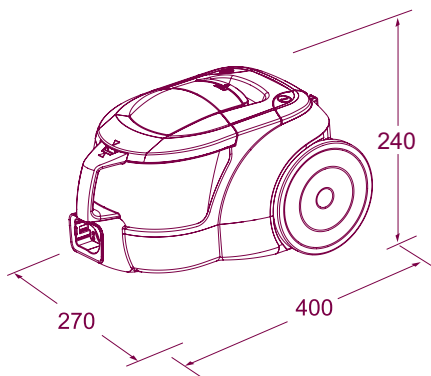



型号: VC3316GND
额定电压: 220V~ 50Hz
额定功率: 1400W
最大功率: 1600W
净重: 4.7Kg
集尘容量: 1.2L
外形尺寸: 270mmX400mmX240mm
本产品执行标准: GB4706.1-2005
GB4706.7-2004
GB17625.1-2003
GB4343.1-2009

※ 为了提高产品质量而进行的外观及设计规格上的变更将不再另行通知。

使用前注意事项

使用前注意事项

忽视说明而导致的错误操作将会对您造成不同程度的损害，请认真阅读以下提示说明。

-  **危险** 此标识表明违反反标记事项时，会立刻发生严重伤害或死亡现象。
-  **警告** 此标识表明违反反标记事项时，有可能发生严重伤害或死亡现象。
-  **注意** 此标识表明违反此标记事项时，有可能发生财产损失或轻微伤害。

危险

请不要在易燃液体附近使用吸尘器，以免发生火灾。

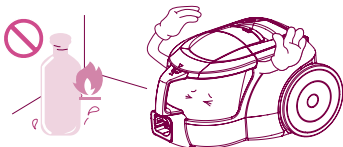

插拔电源插头时，请先关闭电源开关，以免发生火灾或触电的危险。请不要用湿手触摸电源插头，以防触电。（不要在220V以外的电源上使用产品）



警告

请不要让大头钉等金属物存留在软管、机体延长管内，否则会造成短路故障。

请不要吸入头发团、大纸团等物品，否则容易堵塞软管，如有软管堵塞现象，请及时清理。

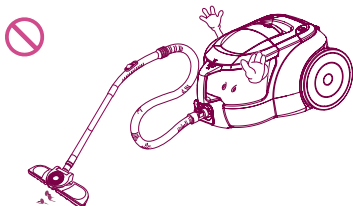

为避免发生火灾或触电的危险，在清扫时，注意不要让机体吸入液体、刀片、火种以及水泥、石膏粉等小微粒。

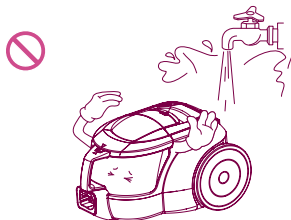

15A以上的电流请单独使用插线板，在一个插线板上同时使用多种电器可能会引发火灾。建议不要使用电源线延长线，以免引起不必要的危险。



长时间不使用电器时，请记住拔掉电源插头；正处于通电时，请您不要离开。



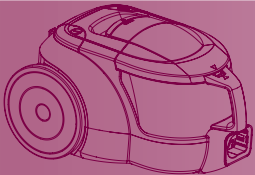

使用前注意事项

警告

请不要让电源线与吸尘器接近电暖器等热源，以免使机体变形或发生火灾。请您不要使用破损的电源和插头，如有破损，必须由指定维修站更换。

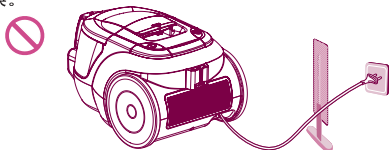

请不要在吸入口和排气口堵塞时，继续长时间运作，否则可能造成机体变形或损坏。

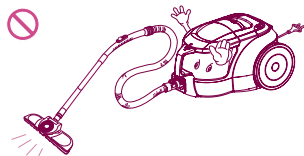

请不要让儿童把吸尘器及组件，如延长管等当做玩具，以防止意外。



使用过程中，延长管和机体会产生静电的可能，请您使用时注意。



注意

非专业维修人员请勿开机修理。

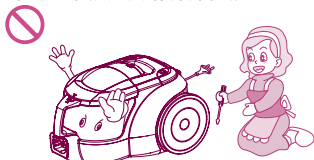

请不要弯曲、践踏、拉拽软管，如软管受损，请不要继续使用。
请不要用重物或尖刃物压线。

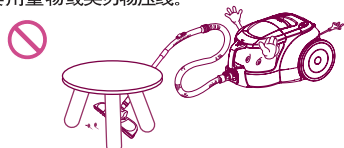

注意不要使电源线夹在门缝里或用电源线提拉吸尘器，防止电源线受损。

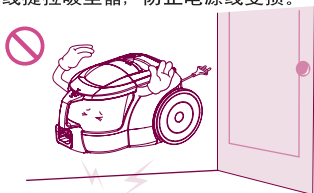

集尘筒集满时，请您正确开启集尘筒清理。请您注意不要在没安装集尘筒或过滤网时使用吸尘器。

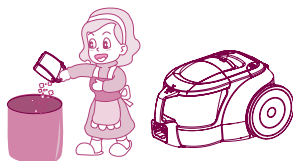

收卷电线时，请拿住电源插头后再按动卷线器按钮。

请不要将电源线拉至红色警告线以外，否则可能损坏电源线或不能回卷。
收线时请注意插头，以免损坏周围物品。



请您注意保护自身安全，使身体各部位远离吸尘器吸口或活动部位。

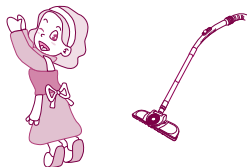

吸尘器的组装及吸力调节

部品名称和连接方法

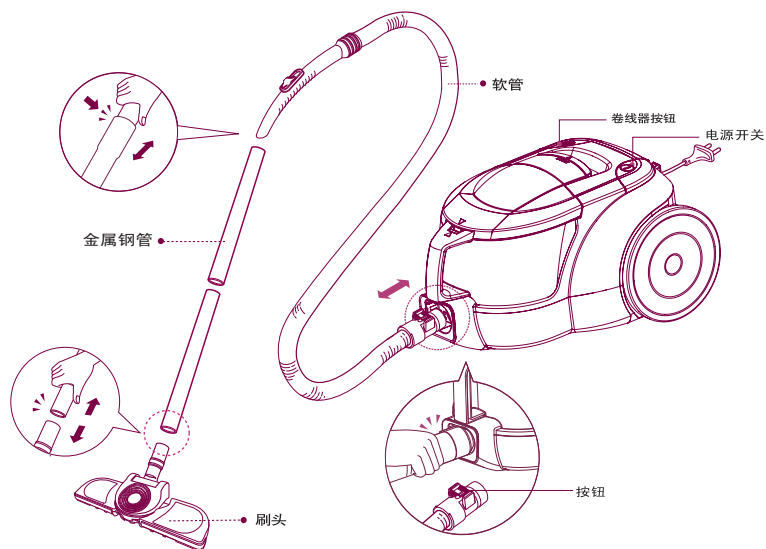

附件



● 鸭嘴



● 毛刷



● 尖吸嘴



● 角落刷头



● 地板地毯刷头

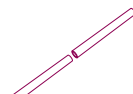

● 金属钢管



● 软管

吸力调节

请按图示使用

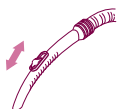

软管手柄处有一个手动的气流控制扭，使您可以简单方便的调节吸力大小。

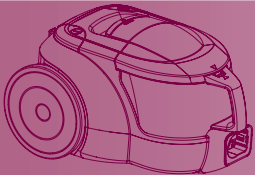

各种附件刷头的使用及清洁方法

毛刷、尖吸嘴、鸭嘴的使用

- ▶ 打开附件袋，取出附件。

请按图示使用

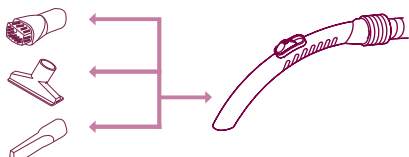

- ▶ 毛刷用于吸扫画框、家具边沿、书籍和其它不规则的表面。
- ▶ 鸭嘴是用来对饰物、床垫等物品进行吸除的。
- ▶ 尖吸嘴可以用来清理房间角落等不易清理到的地方。

使用方法

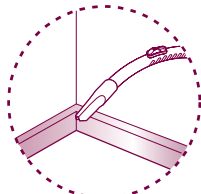
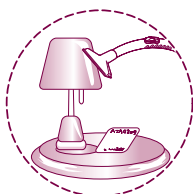
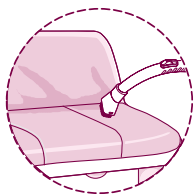

角落刷头的使用

组合

- ▶ 角落刷头可以清洁普通地面，也可以折叠成直角来清洁墙角。

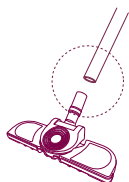

使用

- ▶ 不用再为清扫角落和窄小空间发愁，**角落刷头**会给您带来更多便利。

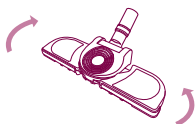

清洁

- ① 用尖吸嘴清洁
- ② 用棉质抹布擦拭

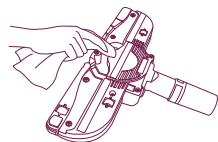
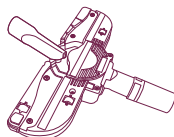

地板地毯刷头使用方法

► 一般情况下使用

适用性

- 适用于瓷砖，木地板等硬地环境和地毯，毯子等软物质环境。

使用方法

- 根据清洁地板类型，改变刷头踏板位置，满足您的不同需要，给您带来更多方便。

⚠ 注意：当在硬地板（瓷砖，水泥地，木地板等）上使用时，请务必按住踏板，放出刷子，当地毯上使用，收回刷子即可。

组合

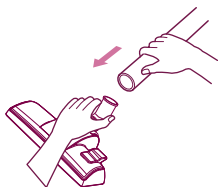

使用

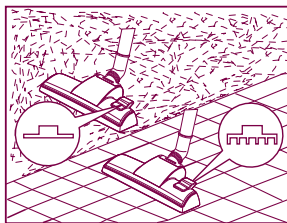

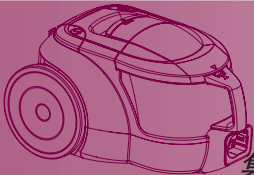

集尘桶/电机保护过滤海绵的拆卸、清洗及安装方法

当吸尘器设在最大功率时，如吸嘴不能正常工作，则需要清理集尘桶，并清洗电机保护过滤海绵。

集尘桶的拆装及清洗方法

- ▶ 关闭电源，拔下插头，按下机体“PUSH”按键，
- ▶ 按照下图，打开集尘桶盖。同时手提集尘桶手柄，从机体内取出集尘桶。

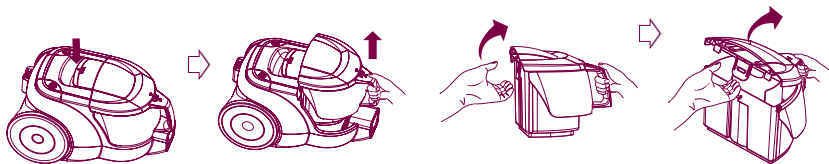

- ▶ 倾倒入集尘桶里面的灰尘后，用冷水清洗集尘桶，打开桶盖放置在阴凉处风干。扣好集尘桶盖后，如箭头所示方向装入机体。

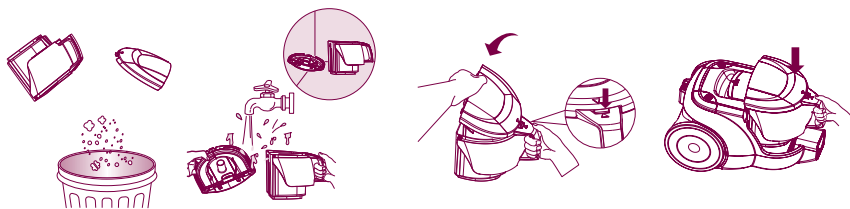

电机保护过滤海绵的拆装及清洗方法

- ▶ 按照箭头所示方向从机体内取出电机保护过滤海绵。请至少每月清洗一次，或根据使用频率酌情处理。每次清洁集尘桶的同时，建议同时清洗过滤海绵，并放置在阴凉处风干后装入机体。



注意：再次使用吸尘器前，请确认海绵盒已经安装好

排气过滤器的拆卸/清洁/安装方法

拆卸方法

- ▶ 排气过滤器至少半年清洗一次或根据使用频率酌情清理。

排气过滤器按钮

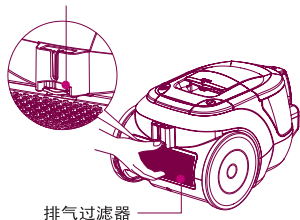

清洁方法



- 1 抖动排气过滤器进行清洁。

安装方法

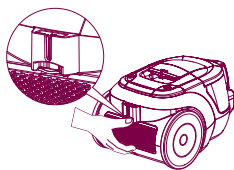

- 2 放入排气过滤器，按钮处有“咯哒”声时，表示排气过滤器安装准确。

使用吸尘器后的保管方法



卷线器按钮

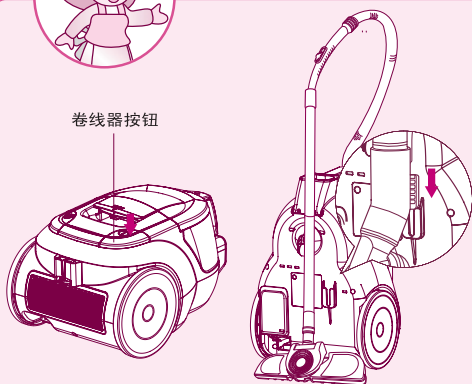

集尘盒手柄



机体手柄

- 按下卷线器按钮时吸尘器电线自动被卷入。
- 吸入口的突起部插入主机背面的凹槽后进行保管。

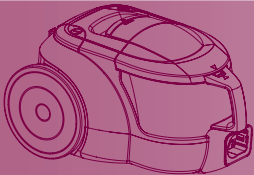

故障通告前需确认事项

故障通告前请先确认

- ▶ 如果您怀疑产品发生故障，请先确认故障发生原因，再与售后服务中心或代理商联系，以确保检修的效率。

现象：

噪音加大
软管收缩

吸力忽然
下降



吸尘器求助：

请检查集尘筒
和吸入口



处理要领

- 1 查看集尘筒灰尘是否集满（到达MAX处），如果是，请及时清理集尘筒。



已经满了吗？请及时清理集尘筒哦！

- 2 请确认集尘筒滤芯是否堵塞
过滤器堵塞时会发出异常声，请及时清洗。



滤芯有问题吗？那么检查一下吸入口。

- 3 检查吸入口时，需将吸力调节到最大。

第一步

将金属钢管与刷头分离后，检查有无阻塞，如发现问题请立即清理。



如果还有问题，请进行第二步。

第二步

分离手柄与金属钢管，检查有无阻塞，如有阻塞，请将金属钢管分开，清除异物。



如果还有问题，请进行第三步。

第三步

检查软管是否阻塞，将吸力调至最强，用手堵住放管口，反复几次。

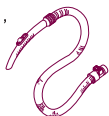

如果还有问题，请清理一下滤芯。

故障通告前请先确认

▶ 如果您怀疑产品发生故障，请先确认故障发生原因，再与售后服务中心或代理商联系，以确保检修的效率。

故障

吸尘器为何不能工作？



机体内有噪音。



机体出现异味。



电源线不能全部卷入机体，电源线不能全部拉出。

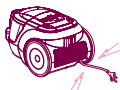

机体或排出的气体过热。



软管内壁过脏。

检查

- 电源插头是否插上？
- 电源插座有电吗？
- 软管是否插上？
- 电机热保护处于开启期间。

- 吸尘器吸力过大或电机高速运转时所发出的声音，不属于异常情况，请正常使用。
- 如果不是正常的电机响声，而是异常的噪音，请打电话与维修中心联系。
- 集尘筒已满。
- 集尘筒滤芯堵塞。
- 吸入口阻塞。
- 金属钢管阻塞。
- 软管阻塞。

- 电机运作时，用于固定电机的橡胶圈会受热而产生少量气味，不会影响运作或使机器发生损坏。
- 机器不小心吸入一些水或集尘筒长期不清理时，会有一些异味排出，此时应及时清理集尘筒。

- 将电源线拉出一部分后重新卷入。
- 请用力将电源线拉出，不会损坏电源线。
- 由于线在内部互相缠绕或夏季周围温度过高所致。
- 由于线在内部折曲或未缠在卷线器上，启动卷线器后，能正常运作。

- 吸力是否正常？

- 从机体内排出的热气，是由电机导热产生的热量所致，属正常温度，请继续使用。

- 请勿将水吸入，水与灰尘混合吸入后，有可能弄脏管壁。

措施

- 请将电源插牢（本产品适用于220V电压）。
- 确认插座是否有电。
- 将软管插牢。
- 2小时后重新启动。

- 清理集尘筒。
- 用软毛刷轻刷滤芯，用水冲洗后放置于阴凉处风干一天。
- 将吸入的异物取出后再使用。
- 将金属钢管内异物取出后再使用。
- 将软管内异物取出后再使用。

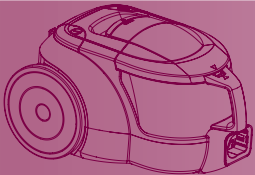

装箱单

装箱单

吸尘器	一台
说明书	一本
鸭嘴	一个
毛刷	一个
尖吸嘴	一个
软管	一根
金属钢管	两根
角落刷头	一个
地板地毯刷头	一个
保修卡	一份

<i>Product specifications</i>	13
<i>Attention before using the appliance</i>	14 - 15
<i>Assembling and adjusting the Cleaner</i>	16
<i>Parts description and assembly</i>	
<i>Accessories</i>	
<i>Using and cleaning method of all the accessory nozzles</i>	17 - 18
<i>How to use crevice tool, upholstery nozzle and dust brush</i>	
<i>How to use and clean corner nozzle</i>	
<i>How to use floor and carpet nozzle</i>	
<i>How to separate, clean and assembly the dust tank and the motor protection filter</i>	19
<i>How to separate, clean and assemble exhaust filter</i>	20
<i>Disassembling</i>	
<i>Cleansing</i>	
<i>Assembling</i>	
<i>If you have a problem</i>	21 - 22
<i>Packing List</i>	23

Product specifications

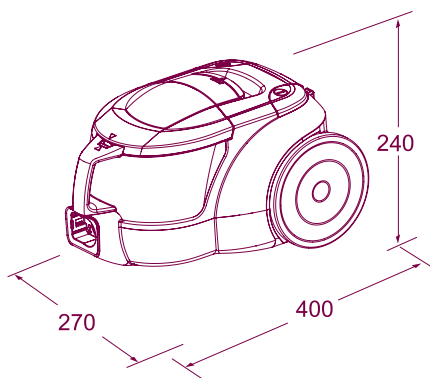

Model: VC3316GND

220V~ 50Hz

IEC: 1400W

MAX: 1600W

Net Weight: 4.7Kg

Dust Capacity: 1.2L

Dimension: 270mm x 400mm x 240mm

This appliance complies with the following GB Directives:

GB4706.1-2005

GB4706.7-2004

GB17625.1-2003

GB4343.1-2009

※ You will not be informed otherwise of any changes in appearance and standard deriving for improvement of product quality.

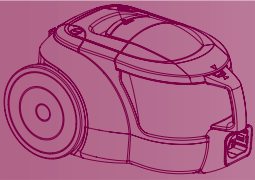

Attention before using the appliance

Attention before using the appliance

Please read all the following information, which contains important instructions for the safety, the use of the appliance.



DANGER

May immediately cause serious injury or death.



WARNING

May possibly cause serious injury or death.



ATTENTION

May possibly cause losses of property or light injury.



DANGER

Do not pick up anything that is burning or smoking, such as cigarettes, matches or hot ashes.

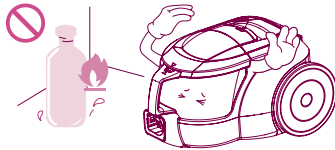

Please turn off the power before pulling out the plug to prevent fire or electric shock. Never handle plug or appliance with wet hands. (Do not use the appliance on the power above 220V.)



WARNING

Avoid picking up hard, sharp objects with the cleaner. They may damage the cleaner and the tank.

Do not vacuum the objects like hair ball or big paper ball, otherwise the hose is possibly blocked up. Please clear the hose in time when it is blocked.

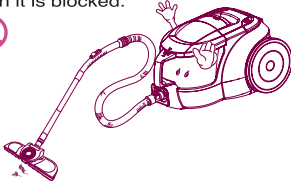

To avoid the danger of fire or electric shock, do not vacuum liquid, blade, flammable substances, or small particles like cement and gesso in cleaning.



Independently use a socket when the current is $\geq 15A$. It may cause fire when many electric appliances share one socket. In order to avoid the needless danger, you had better not use the prolonged thread of power cord.

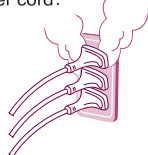

Unplug cleaner when not in use. Turn off all controls before unplugging.



Attention before using the appliance

WARNING

Do not let the power cord near the electric heater or other heat source, lest that the cleaner should be deformed or it should cause fire. Do not use the appliance when the power cord or plug is damaged. The damaged power cord or plug must be replaced in the approved service station.

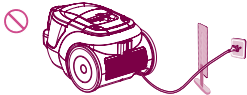

Close supervision is necessary when any appliance is used by or near children. Do not allow vacuum cleaner to be used as a toy or to run unattended at any time.



Do not operate the appliance for long when the nozzle inlet or nozzle outlet is blocked, which may have it deformed or damaged.

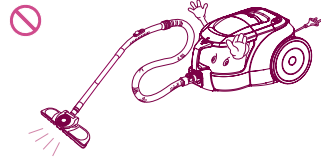

In using the appliance, pay attention to the electrostatic effect generated on the telescopic tube and cleaner body.

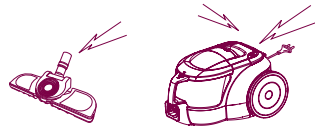

ATTENTION

Do not allow the non-professional maintenance people to repair.

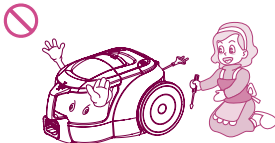

Do not pull or carry by cord, use cord as a handle, close door on cord or pull cord around sharp edges or corners. Do not run appliance over cord. Keep cord away from heated surfaces.

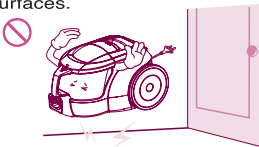

In winding the power cord, hold the plug before pressing the button of the cord reel. Do not pull the power cord beyond the red warning line, otherwise the power cord may be damaged or unable to be wound up. Pay attention to the plug in winding the cord to avoid damaging the surrounding objects.



Do not bend, stamp on, or drag the hose. Do not continue to use the hose if it is damaged.

Do not use any heavy or sharp object to press the power cord.



Do not use without dust tank or filters in place. Change tank frequently when picking up very fine materials such as powder.

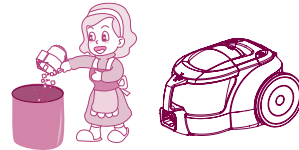

Keep hair, loose clothing, fingers, feet and all parts of body away from the nozzle or movable portion.



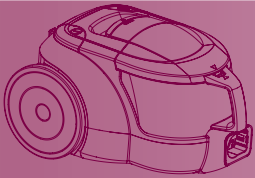

Assembling and adjusting the Cleaner

Parts description and assembly

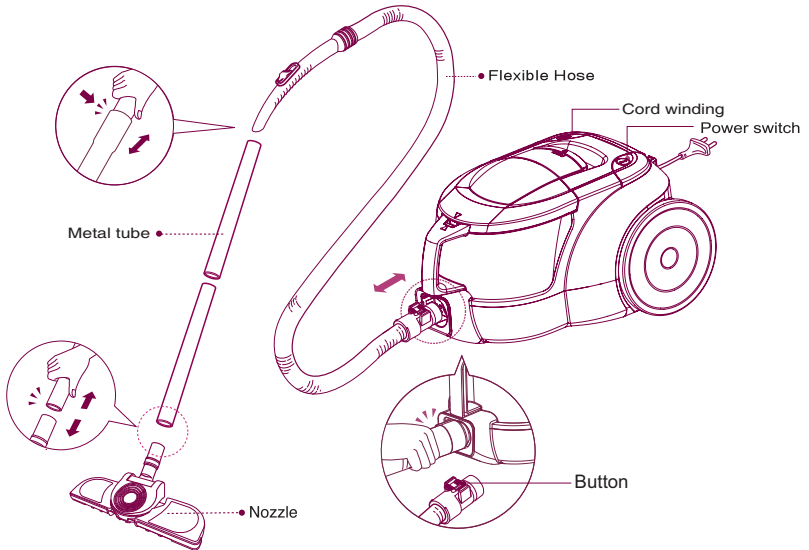

Accessories							
	• Upholstery Nozzle	• Dusting Brush	• Crevice tool	• Corner Nozzle	• Floor and carpet nozzle	• Metal tube	• Hose

Adjusting the Cleaner

Use it as shown in the diagram

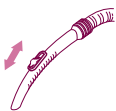

The flexible hose handle has a manual air flow regulator which allows you to briefly reduce the suction level.

Using and cleaning method of all the accessory nozzles

Using Upholstery Nozzle & Dust Brush & Crevice Tool

- ▶ Tear the vinyl bag and pull out accessories.

Use it as shown in the diagram

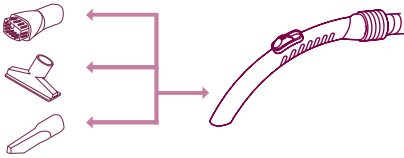

- ▶ Dust brush can be used to clean the picture frame, furniture brim, book and other irregular surface.
- ▶ Upholstery nozzle can be used to clean upholstery, mattresses, etc.
- ▶ Crevice tool can be used to clean the gap of sofa cushion or the place with cobweb and other place hard to reach.

Using method

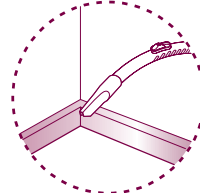
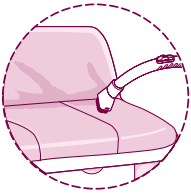

Using and cleaning the corner nozzle

Assembling

- ▶ Corner nozzle can be used to clean common floor, also can be used to clean corner when be puckered.

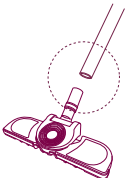

Using

- ▶ Corner nozzle makes you more convenient to clean corner and small space.

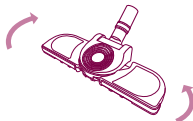

Cleaning

- 1 Use crevice tool to clean
- 2 Use calico dishcloth to clean

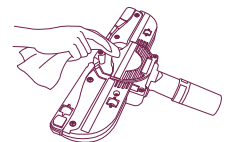
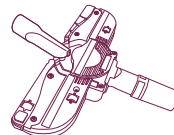

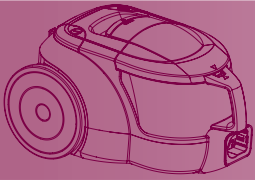

Using method floor-carpet nozzle

► Using generally

Applicability

- Floor-carpet nozzle can be used to tile, wood floor ,and other hard floor , carpet and other soft floor.

Using

- According to cleaning the type of floor, change the place of the nozzle pedal to satisfied your different requirements, and give you many convenience .

⚠ Attention: Using on the hard floor(tile, concrete floor, wood floor), please must be push the nozzle pedal, put out the nozzle. Using on the carpet, please take back the nozzle.

Assembling

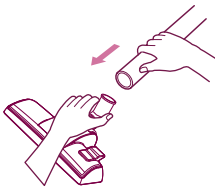

Using

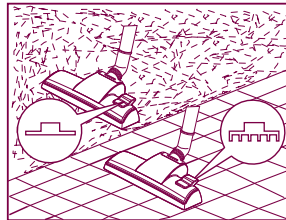

How to separate, clean and assembly the dust tank and the motor protection filter

How to separate, clean and assembly the dust tank

- ▶ After turning off the appliance and unplug it, Press down the "PUSH" button and hold the tank handle, then raise the tank.

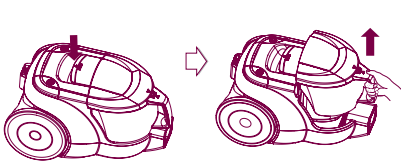

- ▶ Please pull the hook behind the tank, then open the tank cover.

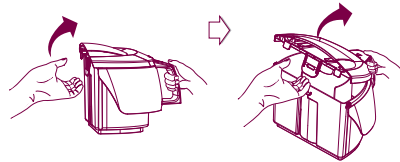

- ▶ Washing dust tank with cold water after emptying the dust. dry it fully in shade so that moisture is removed entirely.

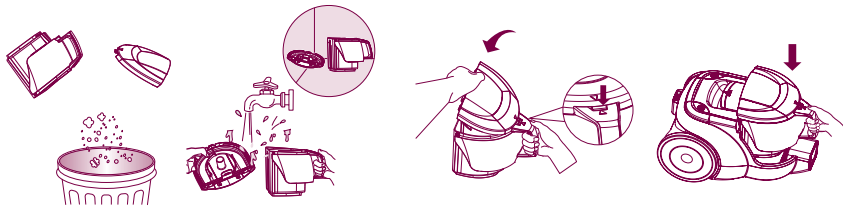

How to separate, clean and assembly the motor protection filter

- ▶ Take out the motor protection filter from the appliance along the arrow direction. Please clean it at least once month or based on the using frequency. Suggest cleaning the motor protection filter and dry it fully in shade so that moisture is removed entirely.



Warning: Please check the assembling of the protection filter before using the cleaner again

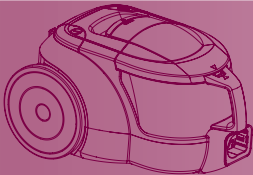

How to separate, clean and assemble exhaust filter

Disassembling

- ▶ The exhaust filter should be cleaned at least once half a year. Allow exhaust filter to dry in a shaded location for a dry.

button of the exhaust filter

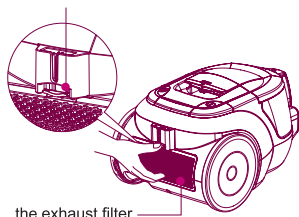

Cleaning



- 1 Shake off the exhaust filter.

Assembling

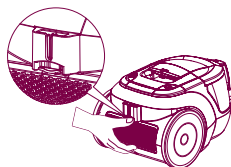

- 2 Insert the exhaust filter and join it properly until you hear the click of the button.



How to keep the cleaner after using

Cord winding button

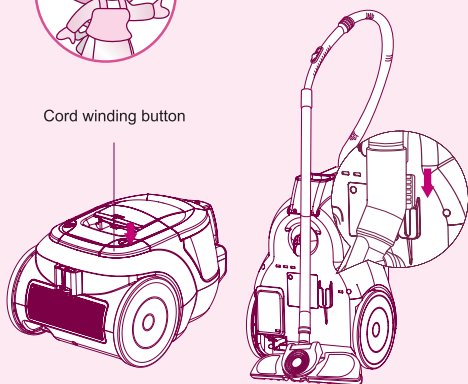

- The cord winds up when you press the button
- Insert the spiral of the inhaler into the groove in the back of the body



Tank handle



Carrier handle

If you have a problem

If you have a problem

- If a minor problem occurs, it usually can be solved quite easily when the cause is found by using the check list below.

Problem:

The noise increases and the hose shrink.



Suction power is abruptly weakened.

Help:

Check the dust tank and suction inlet.



Solution

- 1 Dust tank full. (Arrive at MAX line)
Empty dust tank.



Is it full? Empty the dust tank in time!

- 2 Motor filter dirty.
Clean the motor filter with brush and water, allow to dry and replace in cleaner.



Is the filter OK? Then check the suction inlet.

- 3 When checking the suction inlet, adjust the suction level to the maximum.

First step

Turn cleaner off and disconnect from electrical outlet, then disconnect nozzle from metal tube. Check if it is blocked, and remove any blockages.

If there is still a problem, proceed the second step.



Second step

Disconnect the metal tube from hose. Check if it is blocked, and remove any blockages.

If there is still a problem, proceed the third step.

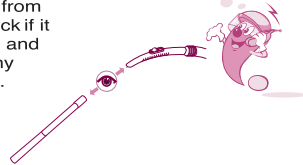

Third step

Plug cleaner in, turn on, and check hose end for suction. Remove any obstructions.

If there is also a problem, clean the filter.



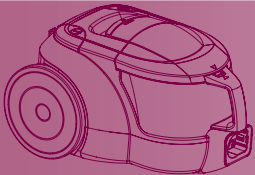

If you have a problem

Please check before notifying malfunction

- If you doubt the product meets with malfunction, please check the cause of such malfunction before contacting with the after-sales service center or agent, so as to ensure efficiency of repair.

Malfunction

The vacuum does not work?



The vacuum does not work?



Peculiar smell exists inside the vacuum cleaner



The power cord can not be scrolled thoroughly into the vacuum cleaner or the power cord can not be fully pulled.



The vacuum cleaner or the discharged air is too heat.



Inner wall of the hose is too dirt.

Check

- Is the plug inserted?
- Is the socket powered on?
- If the hose inserted?
- If the motor heat protection opened?

- When the vacuum cleaner's suction is too large or the motor is under high speed running, they do not belong to the abnormal conditions. So, please use the vacuum cleaner properly.
- If it is the noise rather than the normal motor sound, please phone the repair center.
- The duster collector is filled up.
- The filter is clogged.
- Suction inlet is jammed.
- Metal tube is clogged.
- Hose is clogged.

- When the motor is running, the rubber band used for fixing the motor will produce a little smell due to the heat, but it will not affect the operation or damage the machine.
- When the machine sucks some water accidentally or the dust collector is not cleaned for a long period of time, the peculiar smell will be produced. So, clean up the dust collector timely.

- Pull out part of the power cord and then re-scroll it.
- Please put forth your strength to pull out the power cord, which will not be damaged.
- The power cord entwined inside the machine or it is caused by high temperature in the summer.
- The cord is bended inside the machine or not coiled around the winder. After the winder is started, the normal operation could be realized.

- Is the suction normal?

Troubleshooting

- Insert the plug tight (This product is applicable for 220V)
- Verify the power of socket is on
- Insert the hose tight
- Restart in 2 hours

- Clean out the dust collector.
- Purge the sponge filter with water and air-dry in the shady and cool place for one day.
- Take out the sucked objects before use.
- Take out the objects inside the Metal tube before use.
- Take out the objects inside the hose before use.

- The heat air discharged from the machine is arising from the heat produced by motor. So, the temperature is normal, please use the machine continuously.

- Never suck the water because after mixing of the water and dust, the tube wall will be polluted and the motor will be damaged.

Packing List

Packing List

Vacuum Cleaner	1
Owner's Manual	1
Upholstery Nozzle	1
Dust Brush	1
Crevice tool	1
Hose	1
Metal tube	2
Corner Nozzle	1
Floor and carpet nozzle	1
Card, Service	1

如有问题

瞬间感动 Moment Of Truth
LG 售后

请打电话



400-819-9999

售后热线



LG 电子 (天津) 电器有限公司

地址: 中国·天津市北辰区津围公路9号

传真: 022-26903476

邮编: 300402

全国技术服务中心服务咨询电话: 400-819-9999



<http://www.lg.com/cn>



MFL67892725