

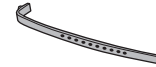

▶ www.lg.com/id-manual

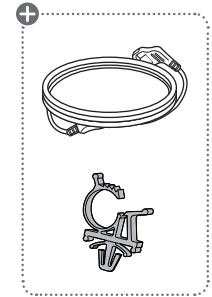

⊕ : Depending on model / Modele bağlı olarak değişiklik gösterebilir / Selon le modèle / حسب الطراز / В зависимости от модели /
Залежно від моделі / Rusumga qarab

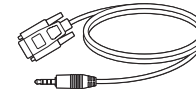
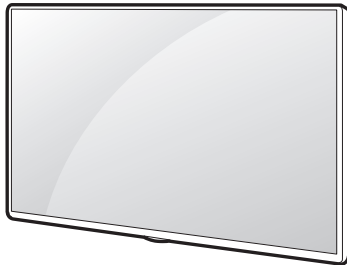

English

- Read **Safety and Reference**.
- You can download more detailed information on our website by entering the full model number.
- For the power supply and power consumption, refer to the label attached to the product.

Français

- Lire le document **Sécurité et référence**.
- Vous pouvez télécharger des informations plus détaillées sur notre site Web en saisissant la référence complète du modèle.
- Reportez-vous à l'étiquette apposée sur le téléviseur pour connaître l'alimentation et la consommation électriques.

Русский

- Прочтите **Руководство по технике безопасности**.
- Более подробные сведения можно загрузить на нашем веб-сайте, указав полный номер модели.
- Требования параметров электропитания и значения потребляемой мощности указаны на информационном лейбле на задней крышке изделия.

O'zbekcha

- **Xavfsizlik bo'yicha ko'rsatmalar va havolalar** o'qib chiqing.
- To'liq model raqamini kiritish orqali veb-saytimizda batafsil axborotni yuklab olishingiz mumkin.
- Quvvat ta'minoti va quvvat iste'moli uchun mahsulotga yopishtirilgan yorliqqa qarang.

Türkçe

- **Güvenlik ve Referans** bölümünü okuyun.
- Model numarasının tamamını girerek, web sitemizden daha detaylı bilgileri indirebilirsiniz.
- Güç kaynağı ve güç tüketimi için ürüne yapıştırılmış olan etikete bakın.

العربية

- قراءة السلامة والمرجع.
- يمكنك تنزيل معلومات أكثر تفصيلاً من على موقعنا عن طريق إدخال رقم الطراز الكامل.
- لمعرفة المزيد حول مصدر الإمداد بالطاقة المطلوب ومعايير استهلاك الطاقة، راجع الملصق الموجود على المنتج.

Українська

- Прочитайте **Правила безпеки та довідкова інформація**.
- Докладнішу інформацію можна знайти на нашому вебсайті, увівши повний номер моделі.
- Відомості щодо подачі живлення і споживання електроенергії дивіться на наліпці на виробі.

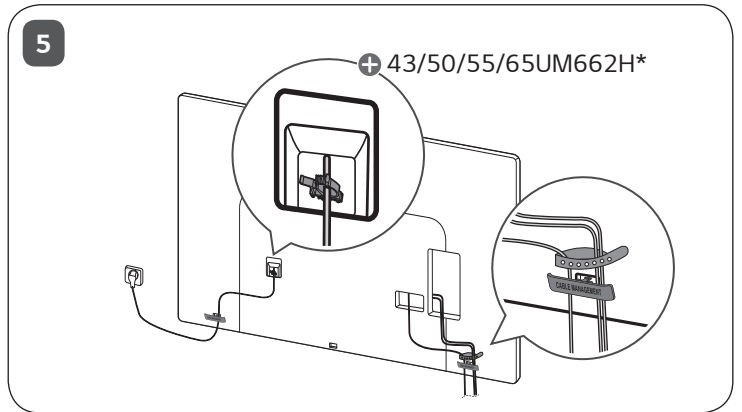
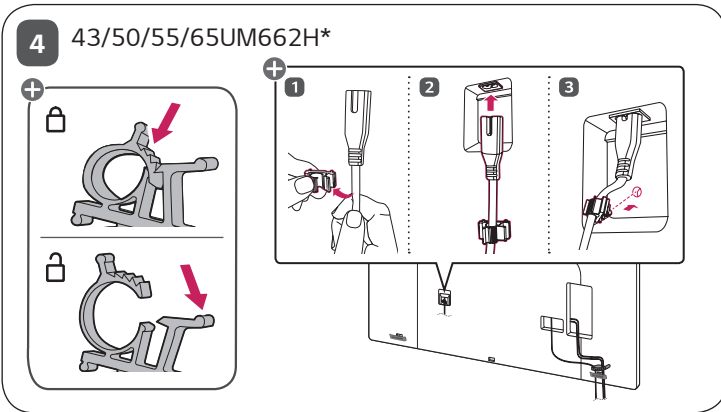
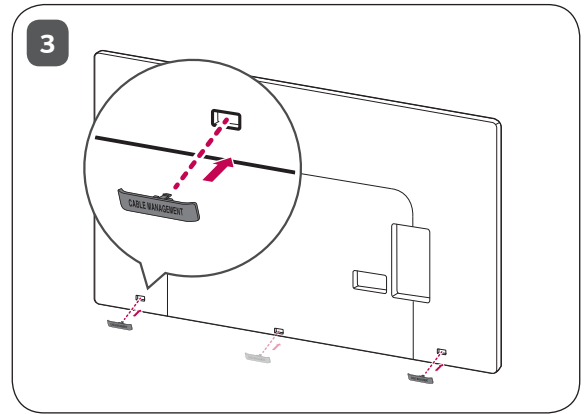
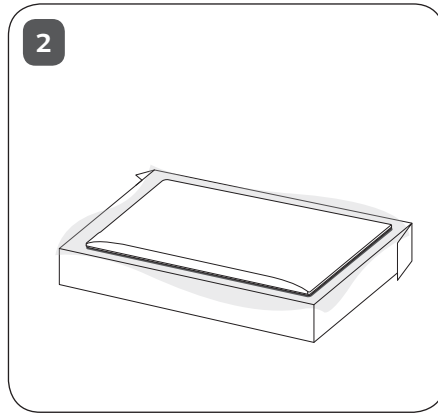
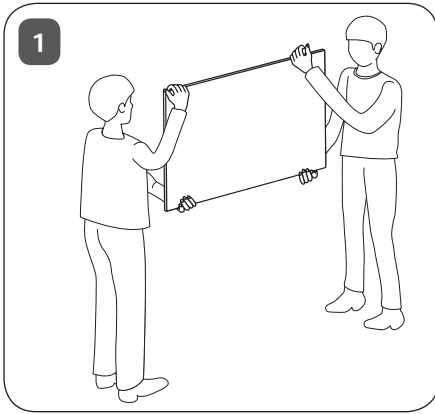

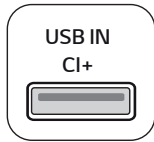
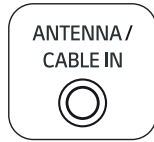
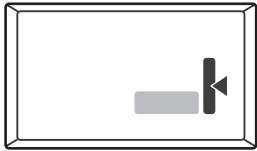

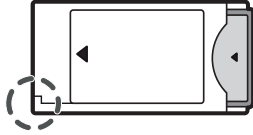
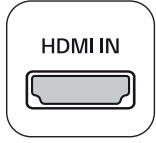
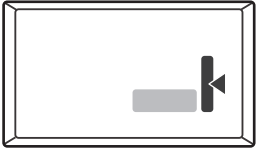

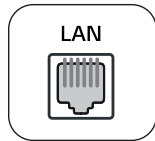
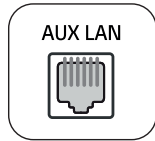
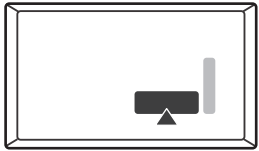

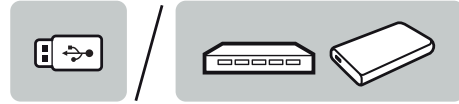
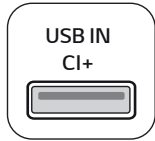
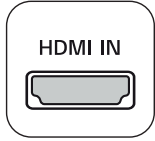
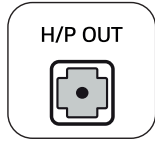
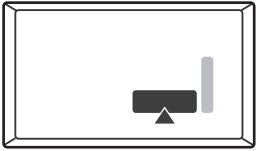

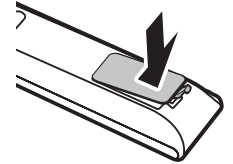
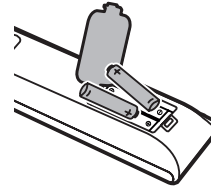
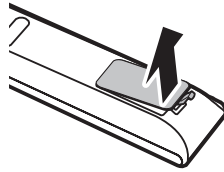
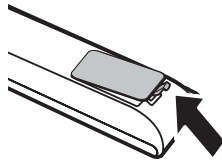
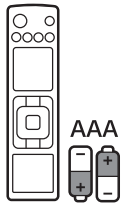

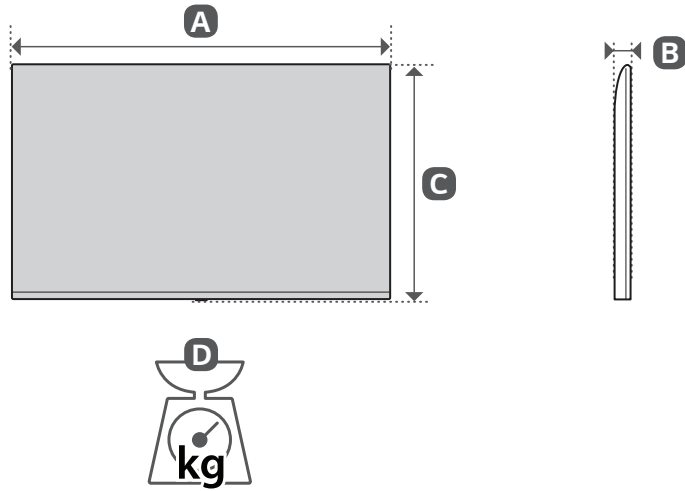

	A	B	C	D
	(mm)			(kg)
43UM662H0LC	967	57.1	564	8.8
50UM662H0LC	1121	57.1	651	12.1
55UM662H0LC	1235	57.5	715	14.0
65UM662H0LC	1454	57.7	838	21.5
75UM662H0LC	1678	59.9	964	31.4
Power requirement			AC 100-240 V~ 50/60 Hz	