



OWNER'S MANUAL

Portable Bluetooth Speaker

Please read this manual carefully before operating your set and retain it for future reference.

MODELS

PH2

PH2B

PH2R



www.lg.com

Copyright © 2017 LG Electronics. All Rights Reserved

Safety Information



CAUTION: TO REDUCE THE RISK OF ELECTRIC SHOCK DO NOT REMOVE COVER (OR BACK) NO USER-SERVICEABLE PARTS INSIDE REFER SERVICING TO QUALIFIED SERVICE PERSONNEL



This lightning flash with arrowhead symbol within an equilateral triangle is intended to alert the user to the presence of uninsulated dangerous voltage within the product's enclosure that may be of sufficient magnitude to constitute a risk of electric shock to persons.



The exclamation point within an equilateral triangle is intended to alert the user to the presence of important operating and maintenance (servicing) instructions in the literature accompanying the product.

WARNING: TO PREVENT FIRE OR ELECTRIC SHOCK HAZARD, DO NOT EXPOSE THIS PRODUCT TO RAIN OR MOISTURE.

CAUTION: The apparatus should not be exposed to water (dripping or splashing) and no objects filled with liquids, such as vases, should be placed on the apparatus.

WARNING: Do not install this equipment in a confined space such as a book case or similar unit.

CAUTION: Do not use high voltage products around this product. (ex. Electrical swatter) This product may malfunction due to electrical shock.

CAUTION: No naked flame sources, such as lighted candles, should be placed on the apparatus.

CAUTION: Do not block any ventilation openings. Install in accordance with the manufacturer's instructions.

Slots and openings in the cabinet are provided for ventilation and to ensure reliable operation of the product and to protect it from over heating. The openings shall never be blocked by placing the product on a bed, sofa, rug or other similar surface. This product shall not be placed in a built-in installation such as a bookcase or rack unless proper ventilation is provided or the manufacturer's instruction has been adhered to.

CAUTION concerning the Power Cord

Most appliances recommend they be placed upon a dedicated circuit;

That is, a single outlet circuit which powers only that appliance and has no additional outlets or branch circuits. Check the specification page of this owner's manual to be certain. Do not overload wall outlets. Overloaded wall outlets, loose or damaged wall outlets, extension cords, frayed power cords, or damaged or cracked wire insulation are dangerous. Any of these conditions could result in electric shock or fire. Periodically examine the cord of your appliance, and if its appearance indicates damage or deterioration, unplug it, discontinue use of the appliance, and have the cord replaced with an exact replacement part by an authorized service centre. Protect the power cord from physical or mechanical abuse, such as being twisted, kinked, pinched, closed in a door, or walked upon. Pay particular attention to plugs, wall outlets, and the point where the cord exits the appliance. The Power Plug is the disconnecting device. In case of an emergency, the Power Plug must remain readily accessible.

NOTICE: For safety marking information including product identification and supply ratings, please refer to the main label on the bottom or the other surface of the product.

CAUTION when using this product in environments of low humidity

- It may cause static electricity in environments of low humidity.
- It is recommended to use this product after touching any metal object which conducts electricity.

This device is equipped with a portable battery or accumulator.

Safety way to remove the battery or the battery from the equipment: Remove the old battery or battery pack, follow the steps in reverse order than the assembly. To prevent contamination of the environment and bring on possible threat to human and animal health, the old battery or the battery put it in the appropriate container at designated collection points. Do not dispose of batteries or battery together with other waste. It is recommended that you use local, free reimbursement systems batteries and accumulators. The battery shall not be exposed to excessive heat such as sunshine, fire or the like.

Symbols



~	Refers to alternating current (AC).
≡	Refers to direct current (DC).
	Refers to class II equipment.
	Refers to stand-by.
I	Refers to "ON" (power).
	Refers to dangerous voltage.

Table of Contents

1 Getting Started

- 3 Safety Information
- 6 Introduction
- 6 Accessories
- 7 Main Unit
- 8 Charging the Unit
- 8 – Connecting the AC adapter
- 8 – Checking the charging status
- 8 – Checking Battery status

2 Operating

- 9 Basic Operations
- 9 – Using power button
- 9 – Bluetooth Connection
- 9 – Simple Operation Guide
- 10 – Bluetooth LED (White) status
- 10 Handsfree Function
- 11 Mood LED light
- 11 Equalizer Mode Change
- 12 Listening to Music from Your External Device
- 12 Using BLUETOOTH® technology
- 13 – Listening to music stored on the
BLUETOOTH devices
- 15 Multipoint Connection
- 16 Other Operation
- 16 – Resetting
- 16 – Notice for Auto Power Off

3 Troubleshooting

- 17 Troubleshooting

4 Appendix

- 18 Trademarks and Licenses
- 18 Handling the Unit
- 19 Specifications

1

2

3

4

Introduction

Symbol used in this manual

Note

Indicates special notes and operating features.

Caution

Indicates cautions for preventing possible damages from abuse.

Caution

Splash-proof (IPX4)

This unit is splash-proof according to IPX4.

IPX4 is a splash-proof for rain or splashing water.

This unit is splash-proof wireless speaker but it can be damaged when you used under water.

- Do not use unit under water or other liquid.
- Do not spray water on the unit purposely.
- When you use unit, close the port cover securely.
- When battery is charging, do not expose the unit to water.
- When exposed to water, wipe off it with a soft dry cloth.

Accessories

Please check and identify the supplied accessories.

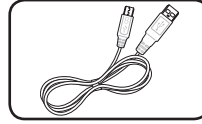

USB cable (1)

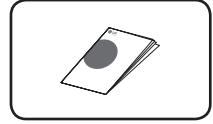

Simple Manual (1)

Main Unit

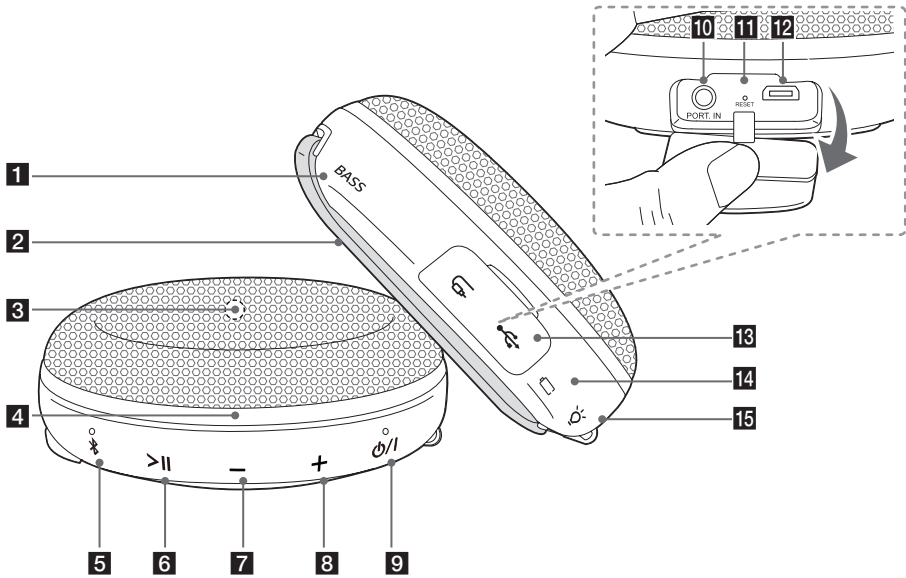

1 BASS



Changes equalizer mode.
(Refer to the page 11.)

2 Hanging strap

3 Microphone

4 Mood LED light

5

- Adds a **Bluetooth** device for multi pairing.
(Press and hold )
- Changes to **Bluetooth** mode in portable mode.
(Press )

* When you connect the portable cable, the function is changed to portable in mode automatically.

6 >||

- Starts or pauses playback on the **Bluetooth** mode.
- Receives on the **Bluetooth** device.
(Refer to the page 10.)
- Mutes the sound on the portable.

7 -

Turn down the volume.

8 +

Turn up the volume.

9

Turns On / Off : Press and hold it.

10 PORT.IN (Portable In connector)

Listens to music from your portable device.

11 RESET hole

12 USB port for charging

13 Port cover

14 Battery LED

15

Changes mood LED light mode.
(Refer to the page 11.)

Charging the Unit

Connecting the AC adapter

This device uses built-in battery. Before using it, charge the battery by connecting the AC Adapter.

1. Connect the supplied USB cable to the AC adapter.
2. Connect the USB cable to USB port of the unit.
3. Plug the AC adapter into an AC outlet.

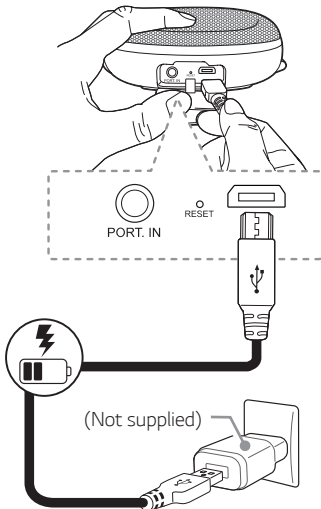

If the battery is fully charged in charging mode, LED is changed from red to white.

Caution

AC adapter is not supplied. It is recommended that you use the 5 V AC adapter approved by LG Electronics Inc. (more than 1.8 A) with this unit because of danger of explosion. If you do not use the recommended adapter, charging is unavailable or charging time may differ.

Checking the charging status

When AC Adapter is connected, battery charging is started. You can check the charging status by LED.

LED	Description
White	Battery is fully charged.
Red	Battery is charging.

Note

- Operating time is approx. 6 hours. (Based on fully charged the battery and continuous playback using 50 % volume level.) It may vary depending on the battery status and operational conditions.
- If you listen to the music while charging, it will take longer to charge.

Checking Battery status

If the power turned on, you can check the charging status by pressing button. Then LED light will change depending on battery charging status.

LED	Condition	Status
White	Battery LED turns on white.	$\geq 60\%$
Amber	Battery LED turns on amber.	$\geq 15\%$
Amber	Battery LED blinks amber with the sound.	$< 15\%$

Basic Operations

Bluetooth Connection

Using power button

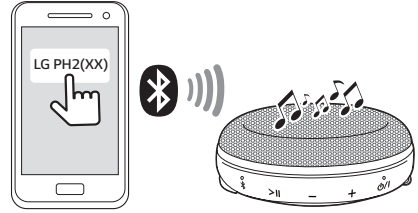
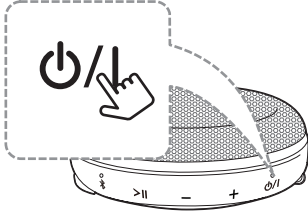

Play the desired music on the **Bluetooth** device. After pairing, you can control playback using the buttons on the unit.

Power On / Off





Press and hold the **⏻/⏻** button for more than 1 second.

Simple Operation Guide

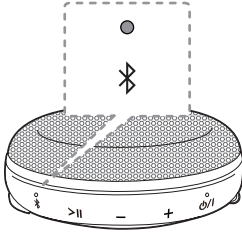
Function	How to	Status
Power On	Press and hold the ⏻/⏻ button.	Mood LED light blinks slowly with the sound.
Power Off	Press and hold the ⏻/⏻ button.	Mood LED light turns off with the sound.
Bluetooth pairing	When Bluetooth LED blinks, select LG PH2 (XX) from device list on your smart device.	Bluetooth LED turns on with the sound.
Play / Pause	Press > .	-
Forward skip	Press > twice.	-
Backward skip	Press > three times.	-
Volume control	Press — or + .	When this unit reaches minimum volume or maximum volume, you can hear beep sound.
Multi pairing	Press and hold ⌘ for 2 seconds to add another Bluetooth device.	During the search for another device, the Bluetooth LED blinks. After pairing, Bluetooth LED stays in white with the sound.
Bluetooth Initialization	Press and hold ⌘ for 10 seconds.	Bluetooth and battery LED blinks with the sound.

Bluetooth LED (White) status



LED	Status	Description
 	Bluetooth LED blinks with the sound.	Searching for Bluetooth device.
 	Bluetooth LED turns on with the sound.	Bluetooth device is connected.

! Note

Once pairing is performed, it does not need to be done again even if you turn off this unit.

Handsfree Function

You can receive incoming call on your **Bluetooth** device to this unit. Connect the speaker to a **Bluetooth** device.

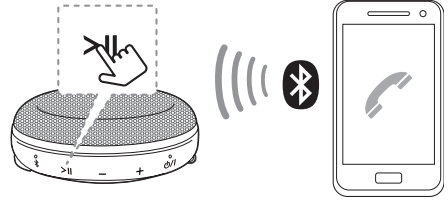

Function	How to
Receive a call.	Press > .
Reject a call.	Press and hold the > button.
End the call.	Press > .

! Note

- Only smartphone is available to use this function.
- This function is supported on **Bluetooth** mode.
- To adjust the call volume, press **-**, **+** buttons on the unit.

Mood LED light

You can turn on mood LED light on this speaker. When you press  button, the mood LED light settings will be appeared in the order as below.

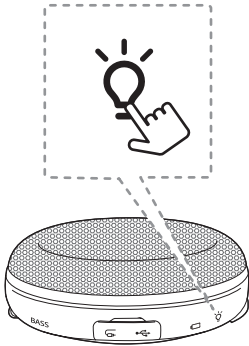

Function	How to
Turns on	Press  .
Blinks	
Turns off	

! Note

Speaker must be connected to **Bluetooth** device for using mood LED light. (Refer to the page 14.)

Equalizer Mode Change

You can change Equalizer mode using BASS button. When press BASS button, it will be changed standard mode. To cancel it, press BASS again on the unit.

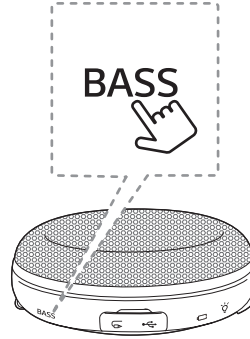

Function	How to
Standard (Low-Band Boost, Default)	Press BASS .
Bass Boost Mode (Full-Band Boost)	

! Note

When you change EQ mode, sound is muted for a second.

Listening to Music from Your External Device

The unit can be used to listen to the music from many types of external device.

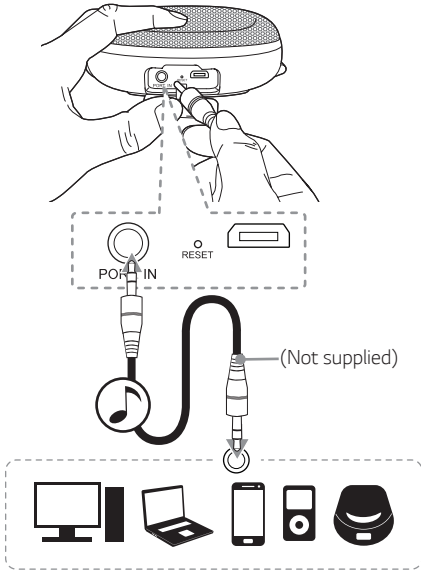

1. Connect the external device to the Portable In connector of the unit.
2. Turn the power on by pressing and holding  button.
3. Turn the external device on and start playing.

Note

When you connect the portable cable, the function is changed to portable in mode automatically.

Using BLUETOOTH® technology

About BLUETOOTH

Bluetooth is wireless communication technology for short range connection.

The sound may be interrupted when the connection interfered by the other electronic wave or you connect the **Bluetooth** in the other rooms.

Connecting individual devices under **Bluetooth** wireless technology does not incur any charges. A mobile phone with **Bluetooth** wireless technology can be operated via the Cascade if the connection was made via **Bluetooth** wireless technology.

- Available Devices : Smart phone, MP3 player, etc.
- Version : 4.0
- Codec : SBC

BLUETOOTH Profiles

In order to use **Bluetooth** wireless technology, devices must be able to interpret certain profiles. This unit is compatible with following profile.

A2DP (Advanced Audio Distribution Profile)

Listening to music stored on the BLUETOOTH devices

Pairing your unit and BLUETOOTH device

Before you start the pairing procedure, make sure the **Bluetooth** feature is turned on in to your **Bluetooth** device. Refer to your **Bluetooth** device's user guide.

Once a pairing operation is performed, it does not need to be performed again.

1. Turn on the unit then **Bluetooth** LED blinks with the sound.
2. Operate the **Bluetooth** device and perform the pairing operation. When searching for this unit with the **Bluetooth** device, a list of the devices found may appear in the **Bluetooth** device display depending on the type of **Bluetooth** device. Your unit appears as "LG PH2 (xx)".
3. Select "LG PH2 (xx)".

! Note

- XX means the last two digits of **Bluetooth** address. For example, if your unit has a **Bluetooth** address such as 9C:02:98:4A:F7:08, you will see "LG PH2 (08)" on your **Bluetooth** device.
 - Depending on the **Bluetooth** device type, some device have a different pairing way. Enter the PIN code (0000) as needed.
4. When this unit is successfully connected with your **Bluetooth** device, **Bluetooth** LED will turn on with the sound.
 5. Listen to music.
To play a music stored on your **Bluetooth** device, refer to your **Bluetooth** device's user guide.

! Note

- When using **Bluetooth** technology, you have to make a connection between the unit and the **Bluetooth** device as close as possible and keep the distance.
However you may experience issues in the cases below :
 - There is an obstacle between the unit and the **Bluetooth** device.
 - There is a device using same frequency with **Bluetooth** technology such as a medical equipment, a microwave or a wireless LAN device.
- You should connect your **Bluetooth** device to this unit again when you restart it.
- The sound may be interrupted when the connection interfered by the other electronic wave.
- You may not control the **Bluetooth** device with this unit.
- Depending on the type of the device, you may not be able to use the **Bluetooth** function.
- You can enjoy **Bluetooth** function using Smart phone, MP3 player, etc..
- The more distance between the unit and the **Bluetooth** device, the lower the sound quality becomes.
- **Bluetooth** connection will be disconnected when the unit is turned off or the **Bluetooth** device gets too far from the unit.
- When **Bluetooth** connection is disconnected, connect the **Bluetooth** device to the unit again.
- When you connect **Bluetooth** device (iOS device etc.) to this unit or operate the device, the volume level can be synchronized with each other.
- When the unit is not connected, **Bluetooth** LED will blink.
- **Bluetooth** connection using the TV, PC or dongle is not supported.

Controls connected Bluetooth device

You can control connected **Bluetooth** device from the unit; play, pause, skip.



Note

- Only Android OS and iOS is available to use this function.
- This function may not be supported depending on the **Bluetooth** device, or operated differently.

Multipoint Connection

The unit can be connected to two **Bluetooth** devices at the same time.

Pairing with Two Devices

1. Connect the unit to a **Bluetooth** device.
2. When the **Bluetooth** device and unit are connected, press and hold **⌘** button for 2 seconds. Then **Bluetooth** LED blinks with the sound. Unit is changed to multi pairing mode.
3. Connect the unit to two **Bluetooth** devices. Select "LG PH2 (XX)" from device list on two **Bluetooth** device.
4. When connection of two **Bluetooth** devices are successful, **Bluetooth** LED will turn on.

! Note

- You can connect this unit with up to 2 **Bluetooth** devices simultaneously same method as above description.
- When you change to multi pairing mode, connect the unit to two **Bluetooth** devices within a few minutes. Otherwise multi pairing mode will be canceled.
- The multi pairing connection is only supported on Android or iOS devices. (Multi pairing connection may not be supported depending on the connected device specifications.)
- Removable/detachable **Bluetooth** device (Ex: Dongle etc..) doesn't support multi pairing.
- Even if this unit connected up to 2 **Bluetooth** devices, you can play and control music by using only one of the connected devices.
- After multi-pairing connection, it takes a little time for the music to be played depending on the **Bluetooth** devices.
- In case of multi-pairing reconnection, only one **Bluetooth** device will be reconnected to the unit automatically. The other device should be connected manually.
- If you get out of **Bluetooth** effective distance without disconnecting **Bluetooth**, it takes a few minutes to connect other **Bluetooth** devices. But after power off and on, you can connect other **Bluetooth** devices without waiting.

Other Operation

Resetting

In case that the unit freezes due to malfunction, press the RESET hole using an object like a thin pin.

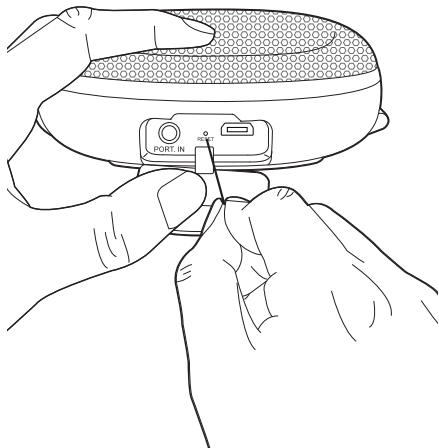

Notice for Auto Power Off

When the unit is in **Bluetooth** mode without music playback for 20 minutes or in portable input mode without button operation for 6 hours, this unit is turned off automatically.

Troubleshooting

Problem	Cause & Correction
No Power.	<ul style="list-style-type: none"> • The battery is discharged. Recharge the battery. • Connect the unit to the power supply with the AC adapter.
No sound or sound distortion.	<ul style="list-style-type: none"> • The unit or your smart device's volume is set to minimum. Check and adjust the volume of the unit or Bluetooth device's volume. • When you use an external device at high volume, the sound quality may be deteriorated. Lower the volume of the devices. • If you use the unit for purposes other than listening to music, the sound quality may be lowered or the unit may not work properly.
Bluetooth pairing does not work well.	<ul style="list-style-type: none"> • Switch Bluetooth off and on again on your Bluetooth device, then try pairing again. • Be sure your Bluetooth device is on. • Remove the obstacle in the path of the Bluetooth device and the unit. • Depending on the type of the Bluetooth device or surrounding environment, your device may not be paired with the unit.
The unit does not operate normally.	<ul style="list-style-type: none"> • If the battery was fully discharged, the stored Bluetooth information can be deleted. Previous setting may not be saved when the unit's power is shut off. • In case of malfunction, please use the unit in proper place where the temperature or humidity is not so high or low.
Above solutions do not work.	<ul style="list-style-type: none"> • Press RESET hole with a pointed thing like mechanical pencil.

Trademarks and Licenses



The **Bluetooth** word mark and logos are owned by the Bluetooth SIG, Inc. and any use of such marks by LG Electronics is under license.

Other trademarks and trade names are those of their respective owners.

Handling the Unit

When shipping the unit

Please save the original shipping carton and packing materials. If you need to ship the unit, for maximum protection, re-pack the unit as it was originally packed at the factory.

Keeping the exterior surfaces clean

- Do not use volatile liquids such as insecticide spray near the unit.
- Wiping with strong pressure may damage the surface.
- Do not leave rubber or plastic products in contact with the unit for a long period of time.

Cleaning the unit

To clean the player, use a soft, dry cloth. If the surfaces are extremely dirty, use a soft cloth lightly moistened with a mild detergent solution. Do not use strong solvents such as alcohol, benzine, or thinner, as these might damage the surface of the unit.

Specifications

General	
Power requirements	5 V  1.8 A (AC adapter) Built-in rechargeable battery
Power consumption	4 W
Dimensions (W x H x D)	Approx. 98 mm X 40 mm X 103 mm
Net Weight	Approx. 0.17 kg
Operating temperature	5 °C to 35 °C
Operating humidity	5 % to 60 %
Splash-proof	IPX4

Inputs	
PORT. IN	0.25 Vrms (3.5 mm stereo jack)
USB	Micro USB port for charging battery

Speaker	
Type	Built-in
Impedance Rated	4 Ω
Rated Input Power	2.5 W
Max Input Power	5 W

Battery	
Battery capacity	700 mAh
Operating time	Approx. 6 hours. It may vary depending on the battery status and operational conditions.
Charging time	Less than 2.5 hours (with AC Adapter). It can be varied depending on the conditions of the battery or operation.

- Design and specifications are subject to change without notice.

