

INSTALLATION MANUAL

AIR CONDITIONER

Please read this installation manual completely before installing the product. Installation work must be performed in accordance with the national wiring standards by authorized personnel only.

Please retain this installation manual for future reference after reading it thoroughly.

MULTI V™
WATER IV



P/NO : MFL68100307

www.lg.com

TIPS FOR SAVING ENERGY

Here are some tips that will help you minimize the power consumption when you use the air conditioner. You can use your air conditioner more efficiently by referring to the instructions below:

- Do not cool excessively indoors. This may be harmful for your health and may consume more electricity.
- Block sunlight with blinds or curtains while you are operating the air conditioner.
- Keep doors or windows closed tightly while you are operating the air conditioner.
- Adjust the direction of the air flow vertically or horizontally to circulate indoor air.
- Open windows regularly for ventilation as the indoor air quality may deteriorate if the air conditioner is used for many hours.
- Clean the air filter once every 2 weeks. Dust and impurities collected in the air filter may block the air flow or weaken the cooling / dehumidifying functions.

For your records

Staple your receipt to this page in case you need it to prove the date of purchase or for warranty purposes. Write the model number and the serial number here:

Model number : _____

Serial number : _____

You can find them on a label on the side of each unit.

Dealer's name : _____

Date of purchase : _____

IMPORTANT SAFETY INSTRUCTIONS

READ ALL INSTRUCTIONS BEFORE USING THE APPLIANCE.

Always comply with the following precautions to avoid dangerous situations and ensure peak performance of your product

WARNING

It can result in serious injury or death when the directions are ignored

CAUTION

It can result in minor injury or product damage when the directions are ignored

WARNING

- Installation or repairs made by unqualified persons can result in hazards to you and others.
- The information contained in the manual is intended for use by a qualified service technician familiar with safety procedures and equipped with the proper tools and test instruments.
- Failure to carefully read and follow all instructions in this manual can result in equipment malfunction, property damage, personal injury and/or death.

Installation

- Have all electric work done by a licensed electrician according to "Electric Facility Engineering Standard" and "Interior Wire Regulations" and the instructions given in this manual and always use a special circuit.
 - If the power source capacity is inadequate or electric work is performed improperly, electric shock or fire may result.
- Ask the dealer or an authorized technician to install the air conditioner.
 - Improper installation by the user may result in water leakage, electric shock, or fire.
- Always ground the product.
 - There is risk of fire or electric shock.
- Always install a dedicated circuit and breaker.
 - Improper wiring or installation may cause fire or electric shock.
- For re-installation of the installed product, always contact a dealer or an Authorized Service Center.
 - There is risk of fire, electric shock, explosion, or injury.
- Do not install, remove, or re-install the unit by yourself (customer).
 - There is risk of fire, electric shock, explosion, or injury.
- Do not store or use flammable gas or combustibles near the air conditioner.
 - There is risk of fire or failure of product.
- Use the correctly rated breaker or fuse.
 - There is risk of fire or electric shock.
- Do not install the unit at the outdoors.
 - Otherwise it may cause fire, electric shock and trouble.
- Do not install the product on a defective installation stand.
 - It may cause injury, accident, or damage to the product.
- Use a vacuum pump or Inert(nitrogen) gas when doing leakage test or air purge. Do not compress air or Oxygen and do not use Flammable gases. Otherwise, it may cause fire or explosion.
 - There is the risk of death, injury, fire or explosion.
- When installing and moving the air conditioner to another site, do not charge it with a different refrigerant from the refrigerant specified on the unit.
 - If a different refrigerant or air is mixed with the original refrigerant, the refrigerant cycle may malfunction and the unit may be damaged.
- Do not reconstruct to change the settings of the protection devices.
 - If the pressure switch, thermal switch, or other protection device is shorted and operated forcibly, or parts other than those specified by LGE are used, fire or explosion may result.
- Ventilate before operating air conditioner when gas leaked out.
 - It may cause explosion, fire, and burn.
- Securely install the cover of control box and the panel.
 - If the cover and panel are not installed securely, dust or water may enter the outside unit and fire or electric shock may result.
- If the air conditioner is installed in a small room, measures must be taken to prevent the refrigerant concentration from exceeding the safety limit when the refrigerant leaks.
 - Consult the dealer regarding the appropriate measures to prevent the safety limit from being exceeded. Should the refrigerant leak and cause the safety limit to be exceeded, hazards due to lack of oxygen in the room could result.

Operation

- Do not damage or use an unspecified power cord.
 - There is risk of fire, electric shock, explosion, or injury.
- Use a dedicated outlet for this appliance.
 - There is risk of fire or electrical shock.
- Be cautious that water could not enter the product.
 - There is risk of fire, electric shock, or product damage.
- Do not touch the power switch with wet hands.
 - There is risk of fire, electric shock, explosion, or injury.
- When the product is soaked (flooded or submerged), contact an Authorized Service Center.
 - There is risk of fire or electric shock.
- Be cautious not to touch the sharp edges when installing.
 - It may cause injury.
- Take care to ensure that nobody could step on or fall onto the outside unit.
 - This could result in personal injury and product damage.
- Do not open the inlet grille of the product during operation. (Do not touch the electrostatic filter, if the unit is so equipped.)
 - There is risk of physical injury, electric shock, or product failure.

CAUTION

Installation

- Always check for gas (refrigerant) leakage after installation or repair of product.
 - Low refrigerant levels may cause failure of product.
- Do not install the product where the noise or hot air from the outside unit could damage the neighborhoods.
 - It may cause a problem for your neighbors.
- Keep level even when installing the product.
 - To avoid vibration or water leakage.
- Do not install the unit where combustible gas may leak.
 - If the gas leaks and accumulates around the unit, an explosion may result.
- Use power cables of sufficient current carrying capacity and rating.
 - Cables that are too small may leak, generate heat, and cause a fire.
- Do not use the product for special purposes, such as preserving foods, works of art, etc. It is a consumer air conditioner, not a precision refrigeration system.
 - There is risk of damage or loss of property.
- When installing the unit in a hospital, communication station, or similar place, provide sufficient protection against noise.
 - The inverter equipment, private power generator, high-frequency medical equipment, or radio communication equipment may cause the air conditioner to operate erroneously, or fail to operate. On the other hand, the air conditioner may affect such equipment by creating noise that disturbs medical treatment or image broadcasting.

Operation

- Do not use the air conditioner in special environments.
 - Oil, steam, sulfuric smoke, etc. can significantly reduce the performance of the air conditioner or damage its parts.
- Do not block the inlet or outlet.
 - It may cause failure of appliance or accident.
- Make the connections securely so that the outside force of the cable may not be applied to the terminals.
 - Inadequate connection and fastening may generate heat and cause a fire.
- Be sure the installation area does not deteriorate with age.
 - If the base collapses, the air conditioner could fall with it, causing property damage, product failure, or personal injury.
- Install and insulate the drain hose to ensure that water is drained away properly based on the installation manual.
 - A bad connection may cause water leakage.
- Be very careful about product transportation.
 - Only one person should not carry the product if it weighs more than 20 kg.
 - Some products use PP bands for packaging. Do not use any PP bands for a means of transportation. It is dangerous.
 - Do not touch the heat exchanger fins. Doing so may cut your fingers.
 - When transporting the outside unit, suspending it at the specified positions on the unit base. Also support the outside unit at four points so that it cannot slip sideways.
- Safely dispose of the packing materials.
 - Packing materials, such as nails and other metal or wooden parts, may cause stabs or other injuries.
 - Tear apart and throw away plastic packaging bags so that children may not play with them. If children play with a plastic bag which was not torn apart, they face the risk of suffocation.
- Turn on the power at least 6 hours before starting operation.
 - Starting operation immediately after turning on the main power switch can result in severe damage to internal parts. Keep the power switch turned on during the operational season.
- Do not touch any of the refrigerant piping during and after operation.
 - It can cause a burn or frostbite.
- Do not operate the air conditioner with the panels or guards removed.
 - Rotating, hot, or high-voltage parts can cause injuries.
- Do not directly turn off the main power switch after stopping operation.
 - Wait at least 5 minutes before turning off the main power switch. Otherwise it may result in water leakage or other problems.
- Auto-addressing should be done in condition of connecting the power of all indoor and outdoor units. Auto-addressing should also be done in case of changing the indoor unit PCB.
- Use a firm stool or ladder when cleaning or maintaining the air conditioner.
 - Be careful and avoid personal injury.

TABLE OF CONTENTS

2	TIPS FOR SAVING ENERGY
2	IMPORTANT SAFETY INSTRUCTIONS
4	INSTALLATION PROCESS
4	OUTSIDE UNITS INFORMATION
6	ALTERNATIVE REFRIGERANT R410A
6	SELECT THE BEST LOCATION
7	INSTALLATION SPACE
7	WATER CONTROL
8	LIFTING METHOD
8	INSTALLATION
11	REFRIGERANT PIPING INSTALLATION
12	INSTALLATION OF WATER PIPE
13	DEVICE PROTECTION UNIT
14	PIPE CONNECTIONS BETWEEN INDOOR AND OUTSIDE UNIT
22	ELECTRICAL WIRING
30	TEST RUN
34	CAUTION FOR REFRIGERANT LEAK
35	COOLING TOWER APPLIED METHOD
35	WATER SOLENOID VALVE CONTROL
36	INSTALLATION GUIDE FOR HARMONICS AND FLICKER

INSTALLATION PROCESS

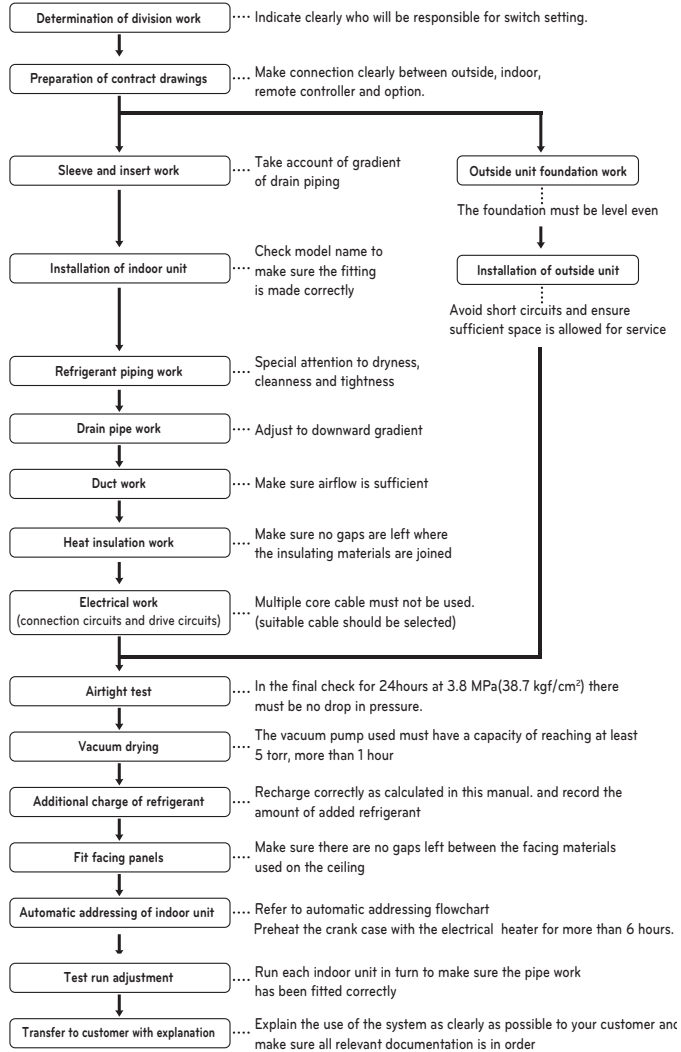

CAUTION

- The above list indicates the order in which the individual work operations are normally carried out but this order may be varied where local conditions warrants such change.
- The thickness of the piping should comply with the relevant local and national regulations for the designed pressure 3.8MPa.
- Since R410A is a mixed refrigerant, the required additional refrigerant must be charged in its liquid state. (If the refrigerant is charged in its gaseous state, its composition changes and the system will not work properly.)

OUTSIDE UNITS INFORMATION

CAUTION

- Ratio of the running Indoor Units to the Outside: Within 10 ~ 100%
- A combination operation over 100% cause to reduce each indoor unit capacity.

Combination Ratio(50~200%)

Outside Unit Number	Connection Ratio
Single outside units	200%
Double outside units	160%
More than Triple outside units	130%

Notes: * We can guarantee the operation only within 130% Combination. If you want to connect more than 130% combination, please contact us and discuss the requirement like below.

- If the operation of indoor unit is more than 130%, low airflow operation is recommended in all the indoor units.
- If the operation of indoor unit is more than 130%, additional refrigerant is needed according to the Aheadquarter guidance.
- Over 130%, capacity is same as capacity of 130%, Same remark is valid for power input.

Power Supply : 3Ø, 380V, 60Hz or 3Ø, 380 - 415V, 50Hz
Model Name : ARWN***LAS4

Unit	1 Unit				
System Capacity (HP)	8	10	12		
Model	Combination Unit	ARWN080LAS4	ARWN100LAS4	ARWN120LAS4	
	Independent Unit	ARWN080LAS4	ARWN100LAS4	ARWN120LAS4	
Refrigerant Precharged Amount	kg	5.8	5.8	5.8	
Maximum Connectable Number of Indoor Units		13	16	20	
Net Weight	kg	127 x 1	127 x 1	127 x 1	
	lbs	280 x 1	280 x 1	280 x 1	
Dimensions(WxHxD)	mm	755 x 997 x 500	755 x 997 x 500	755 x 997 x 500	
	inch	(29-23/32 x 39-1/4 x 19-11/16) x 1	(29-23/32 x 39-1/4 x 19-11/16) x 1	(29-23/32 x 39-1/4 x 19-11/16) x 1	
Refrigerant Connecting Pipes	Liquid	mm(inch)	9.52(3/8)	9.52(3/8)	12.7(1/2)
	Gas	mm(inch)	22.2(7/8)	22.2(7/8)	25.4(1)
Water Connecting Pipes	Inlet	mm	PT40(Internal thread)	PT40(Internal thread)	PT40(Internal thread)
	Outlet	mm	PT40(Internal thread)	PT40(Internal thread)	PT40(Internal thread)
	Drain Outlet	mm	PT20(External thread)	PT20(External thread)	PT20(External thread)
Temp. range of Circulation water	Cooling		10°C ~ 45°C(50°F ~ 113°F)	10°C ~ 45°C(50°F ~ 113°F)	10°C ~ 45°C(50°F ~ 113°F)
	Heating		-5°C ~ 45°C(23°F ~ 113°F)	-5°C ~ 45°C(23°F ~ 113°F)	-5°C ~ 45°C(23°F ~ 113°F)

Unit	1 Unit			
System Capacity (HP)	14	16		
Model	Combination Unit	ARWN140LAS4	ARWN160LAS4	
	Independent Unit	ARWN140LAS4	ARWN160LAS4	
Refrigerant Precharged Amount	kg	5.8	3	
Maximum Connectable Number of Indoor Units		23	26	
Net Weight	kg	127 x 1	140 x 1	
	lbs	280 x 1	309 x 1	
Dimensions(WxHxD)	mm	755 x 997 x 500	755 x 997 x 500	
	inch	(29-23/32 x 39-1/4 x 19-11/16) x 1	(29-23/32 x 39-1/4 x 19-11/16) x 1	
Refrigerant Connecting Pipes	Liquid	mm(inch)	12.7(1/2)	12.7(1/2)
	Gas	mm(inch)	25.4(1)	28.58(1-1/8)
Water Connecting Pipes	Inlet	mm	PT40(Internal thread)	PT40(Internal thread)
	Outlet	mm	PT40(Internal thread)	PT40(Internal thread)
	Drain Outlet	mm	PT20(External thread)	PT20(External thread)
Temp. range of Circulation water	Cooling		10°C ~ 45°C(50°F ~ 113°F)	10°C ~ 45°C(50°F ~ 113°F)
	Heating		-5°C ~ 45°C(23°F ~ 113°F)	-5°C ~ 45°C(23°F ~ 113°F)

Unit	1 Unit			
System Capacity (HP)	18	20		
Model	Combination Unit	ARWN180LAS4	ARWN200LAS4	
	Independent Unit	ARWN180LAS4	ARWN200LAS4	
Refrigerant Precharged Amount	kg	3	3	
Maximum Connectable Number of Indoor Units		29	32	
Net Weight	kg	140 x 1	140 x 1	
	lbs	309 x 1	309 x 1	
Dimensions(WxHxD)	mm	755 x 997 x 500	755 x 997 x 500	
	inch	(29-23/32 x 39-1/4 x 19-11/16) x 1	(29-23/32 x 39-1/4 x 19-11/16) x 1	
Refrigerant Connecting Pipes	Liquid	mm(inch)	12.7(1/2)	12.7(1/2)
	Gas	mm(inch)	28.58(1-1/8)	28.58(1-1/8)
Water Connecting Pipes	Inlet	mm	PT40(Internal thread)	PT40(Internal thread)
	Outlet	mm	PT40(Internal thread)	PT40(Internal thread)
	Drain Outlet	mm	PT20(External thread)	PT20(External thread)
Temp. range of Circulation water	Cooling		10°C ~ 45°C(50°F ~ 113°F)	10°C ~ 45°C(50°F ~ 113°F)
	Heating		-5°C ~ 45°C(23°F ~ 113°F)	-5°C ~ 45°C(23°F ~ 113°F)

Unit	2 Unit				
System Capacity (HP)	22	24	26		
Model	Combination Unit	ARWN220LAS4	ARWN240LAS4	ARWN260LAS4	
	Independent Unit	ARWN120LAS4	ARWN120LAS4	ARWN140LAS4	
Refrigerant Precharged Amount	kg	5.8 + 5.8	5.8 + 5.8	5.8 + 5.8	
Maximum Connectable Number of Indoor Units		35	39	42	
Net Weight	kg	127 x 2	127 x 2	127 x 2	
	lbs	280 x 2	280 x 2	280 x 2	
Dimensions(WxHxD)	mm	(755 x 997 x 500) x 2	(755 x 997 x 500) x 2	(755 x 997 x 500) x 2	
	inch	(29-23/32 x 39-1/4 x 19-11/16) x 2	(29-23/32 x 39-1/4 x 19-11/16) x 2	(29-23/32 x 39-1/4 x 19-11/16) x 2	
Refrigerant Connecting Pipes	Liquid	mm(inch)	19.05(3/4)	19.05(3/4)	
	Gas	mm(inch)	34.9(1-3/8)	34.9(1-3/8)	
Water Connecting Pipes	Inlet	mm	PT40(Internal thread)	PT40(Internal thread)	PT40(Internal thread)
	Outlet	mm	PT40(Internal thread)	PT40(Internal thread)	PT40(Internal thread)
	Drain Outlet	mm	PT20(External thread)	PT20(External thread)	PT20(External thread)
Temp. range of Circulation water	Cooling		10°C ~ 45°C(50°F ~ 113°F)	10°C ~ 45°C(50°F ~ 113°F)	10°C ~ 45°C(50°F ~ 113°F)
	Heating		-5°C ~ 45°C(23°F ~ 113°F)	-5°C ~ 45°C(23°F ~ 113°F)	-5°C ~ 45°C(23°F ~ 113°F)

Unit		2 Unit		
System Capacity (HP)		28	30	32
Model	Combination Unit	ARWN280LAS4	ARWN300LAS4	ARWN320LAS4
	Independent Unit	ARWN140LAS4	ARWN160LAS4	ARWN180LAS4
		ARWN140LAS4	ARWN140LAS4	ARWN140LAS4
Refrigerant Precharged Amount	kg	5.8 + 5.8	3.0 + 5.8	3.0 + 5.8
Maximum Connectable Number of Indoor Units		45	49	52
Net Weight	kg	127 x 2	(140 x 1) + (127 x 1)	(140 x 1) + (127 x 1)
	lbs	280 x 2	(309 x 1) + (280 x 1)	(309 x 1) + (280 x 1)
Dimensions(WxHxD)	mm	(755 x 997 x 500) x 2	(755 x 997 x 500) x 2	(755 x 997 x 500) x 2
	inch	(29-23/32 x 39-1/4 x 19-11/16) x 2	(29-23/32 x 39-1/4 x 19-11/16) x 2	(29-23/32 x 39-1/4 x 19-11/16) x 2
Refrigerant Connecting Pipes	Liquid mm(inch)	19.05(3/4)	19.05(3/4)	19.05(3/4)
	Gas mm(inch)	34.9(1-3/8)	34.9(1-3/8)	34.9(1-3/8)
Water Connecting Pipes	Inlet mm	PT40(Internal thread)	PT40(Internal thread)	PT40(Internal thread)
	Outlet mm	PT40(Internal thread)	PT40(Internal thread)	PT40(Internal thread)
	Drain Outlet mm	PT20(External thread)	PT20(External thread)	PT20(External thread)
Temp. range of Circulation water	Cooling	10°C ~ 45°C(50°F ~ 113°F)	10°C ~ 45°C(50°F ~ 113°F)	10°C ~ 45°C(50°F ~ 113°F)
	Heating	-5°C ~ 45°C(23°F ~ 113°F)	-5°C ~ 45°C(23°F ~ 113°F)	-5°C ~ 45°C(23°F ~ 113°F)

Unit		2 Unit	
System Capacity (HP)		34	36
Model	Combination Unit	ARWN340LAS4	ARWN360LAS4
	Independent Unit	ARWN200LAS4	ARWN180LAS4
		ARWN140LAS4	ARWN180LAS4
Refrigerant Precharged Amount	kg	3.0 + 5.8	3.0 + 3.0
Maximum Connectable Number of Indoor Units		55	58
Net Weight	kg	(140 x 1) + (127 x 1)	140 x 2
	lbs	(309 x 1) + (280 x 1)	309 x 2
Dimensions(WxHxD)	mm	(755 x 997 x 500) x 2	(755 x 997 x 500) x 2
	inch	(29-23/32 x 39-1/4 x 19-11/16) x 2	(29-23/32 x 39-1/4 x 19-11/16) x 2
Refrigerant Connecting Pipes	Liquid mm(inch)	19.05(3/4)	19.05(3/4)
	Gas mm(inch)	34.9(1-3/8)	41.3(1-5/8)
Water Connecting Pipes	Inlet mm	PT40(Internal thread)	PT40(Internal thread)
	Outlet mm	PT40(Internal thread)	PT40(Internal thread)
	Drain Outlet mm	PT20(External thread)	PT20(External thread)
Temp. range of Circulation water	Cooling	10°C ~ 45°C(50°F ~ 113°F)	10°C ~ 45°C(50°F ~ 113°F)
	Heating	-5°C ~ 45°C(23°F ~ 113°F)	-5°C ~ 45°C(23°F ~ 113°F)

Unit		2 Unit	
System Capacity (HP)		38	40
Model	Combination Unit	ARWN380LAS4	ARWN400LAS4
	Independent Unit	ARWN200LAS4	ARWN200LAS4
		ARWN180LAS4	ARWN200LAS4
Refrigerant Precharged Amount	kg	3.0 + 3.0	3.0 + 3.0
Maximum Connectable Number of Indoor Units		61	64
Net Weight	kg	140 x 2	140 x 2
	lbs	309 x 2	309 x 2
Dimensions(WxHxD)	mm	(755 x 997 x 500) x 2	(755 x 997 x 500) x 2
	inch	(29-23/32 x 39-1/4 x 19-11/16) x 2	(29-23/32 x 39-1/4 x 19-11/16) x 2
Refrigerant Connecting Pipes	Liquid mm(inch)	19.05(3/4)	19.05(3/4)
	Gas mm(inch)	41.3(1-5/8)	41.3(1-5/8)
Water Connecting Pipes	Inlet mm	PT40(Internal thread)	PT40(Internal thread)
	Outlet mm	PT40(Internal thread)	PT40(Internal thread)
	Drain Outlet mm	PT20(External thread)	PT20(External thread)
Temp. range of Circulation water	Cooling	10°C ~ 45°C(50°F ~ 113°F)	10°C ~ 45°C(50°F ~ 113°F)
	Heating	-5°C ~ 45°C(23°F ~ 113°F)	-5°C ~ 45°C(23°F ~ 113°F)

Unit		3 Unit		
System Capacity (HP)		42	44	46
Model	Combination Unit	ARWN420LAS4	ARWN440LAS4	ARWN460LAS4
	Independent Unit	ARWN200LAS4	ARWN200LAS4	ARWN200LAS4
		ARWN120LAS4	ARWN120LAS4	ARWN140LAS4
		ARWN100LAS4	ARWN120LAS4	ARWN120LAS4
Refrigerant Precharged Amount	kg	3.0 + 5.8 + 5.8	3.0 + 5.8 + 5.8	3.0 + 5.8 + 5.8
Maximum Connectable Number of Indoor Units		64	64	64
Net Weight	kg	(140 x 1) + (127 x 2)	(140 x 1) + (127 x 2)	(140 x 1) + (127 x 2)
	lbs	(309 x 1) + (280 x 2)	(309 x 1) + (280 x 2)	(309 x 1) + (280 x 2)
Dimensions(WxHxD)	mm	(755 x 997 x 500) x 3	(755 x 997 x 500) x 3	(755 x 997 x 500) x 3
	inch	(29-23/32 x 39-1/4 x 19-11/16) x 3	(29-23/32 x 39-1/4 x 19-11/16) x 3	(29-23/32 x 39-1/4 x 19-11/16) x 3
Refrigerant Connecting Pipes	Liquid mm(inch)	19.05(3/4)	19.05(3/4)	19.05(3/4)
	Gas mm(inch)	41.3(1-5/8)	41.3(1-5/8)	41.3(1-5/8)
Water Connecting Pipes	Inlet mm	PT40(Internal thread)	PT40(Internal thread)	PT40(Internal thread)
	Outlet mm	PT40(Internal thread)	PT40(Internal thread)	PT40(Internal thread)
	Drain Outlet mm	PT20(External thread)	PT20(External thread)	PT20(External thread)
Temp. range of Circulation water	Cooling	10°C ~ 45°C(50°F ~ 113°F)	10°C ~ 45°C(50°F ~ 113°F)	10°C ~ 45°C(50°F ~ 113°F)
	Heating	-5°C ~ 45°C(23°F ~ 113°F)	-5°C ~ 45°C(23°F ~ 113°F)	-5°C ~ 45°C(23°F ~ 113°F)

Unit		3 Unit		
System Capacity (HP)		48	50	52
Model	Combination Unit	ARWN480LAS4	ARWN500LAS4	ARWN520LAS4
	Independent Unit	ARWN200LAS4	ARWN200LAS4	ARWN200LAS4
		ARWN140LAS4	ARWN160LAS4	ARWN180LAS4
		ARWN140LAS4	ARWN140LAS4	ARWN140LAS4
Refrigerant Precharged Amount	kg	3.0 + 5.8 + 5.8	3.0 + 3.0 + 5.8	3.0 + 3.0 + 5.8
Maximum Connectable Number of Indoor Units		64	64	64
Net Weight	kg	(140 x 1) + (127 x 2)	(140 x 2) + (127 x 1)	(140 x 2) + (127 x 1)
	lbs	(309 x 1) + (280 x 2)	(309 x 2) + (280 x 1)	(309 x 2) + (280 x 1)
Dimensions(WxHxD)	mm	(755 x 997 x 500) x 3	(755 x 997 x 500) x 3	(755 x 997 x 500) x 3
	inch	(29-23/32 x 39-1/4 x 19-11/16) x 3	(29-23/32 x 39-1/4 x 19-11/16) x 3	(29-23/32 x 39-1/4 x 19-11/16) x 3
Refrigerant Connecting Pipes	Liquid mm(inch)	19.05(3/4)	19.05(3/4)	19.05(3/4)
	Gas mm(inch)	41.3(1-5/8)	41.3(1-5/8)	41.3(1-5/8)
Water Connecting Pipes	Inlet mm	PT40(Internal thread)	PT40(Internal thread)	PT40(Internal thread)
	Outlet mm	PT40(Internal thread)	PT40(Internal thread)	PT40(Internal thread)
	Drain Outlet mm	PT20(External thread)	PT20(External thread)	PT20(External thread)
Temp. range of Circulation water	Cooling	10°C ~ 45°C(50°F ~ 113°F)	10°C ~ 45°C(50°F ~ 113°F)	10°C ~ 45°C(50°F ~ 113°F)
	Heating	-5°C ~ 45°C(23°F ~ 113°F)	-5°C ~ 45°C(23°F ~ 113°F)	-5°C ~ 45°C(23°F ~ 113°F)

Unit		3 Unit	
System Capacity (HP)		54	56
Model	Combination Unit	ARWN540LAS4	ARWN560LAS4
	Independent Unit	ARWN200LAS4	ARWN200LAS4
		ARWN200LAS4	ARWN180LAS4
		ARWN140LAS4	ARWN180LAS4
Refrigerant Precharged Amount	kg	3.0 + 3.0 + 5.8	3.0 + 3.0 + 3.0
Maximum Connectable Number of Indoor Units		64	64
Net Weight	kg	(140 x 2) + (127 x 1)	140 x 3
	lbs	(309 x 2) + (280 x 1)	309 x 3
Dimensions(WxHxD)	mm	(755 x 997 x 500) x 3	(755 x 997 x 500) x 3
	inch	(29-23/32 x 39-1/4 x 19-11/16) x 3	(29-23/32 x 39-1/4 x 19-11/16) x 3
Refrigerant Connecting Pipes	Liquid mm(inch)	19.05(3/4)	19.05(3/4)
	Gas mm(inch)	41.3(1-5/8)	41.3(1-5/8)
Water Connecting Pipes	Inlet mm	PT40(Internal thread)	PT40(Internal thread)
	Outlet mm	PT40(Internal thread)	PT40(Internal thread)
	Drain Outlet mm	PT20(External thread)	PT20(External thread)
Temp. range of Circulation water	Cooling	10°C ~ 45°C(50°F ~ 113°F)	10°C ~ 45°C(50°F ~ 113°F)
	Heating	-5°C ~ 45°C(23°F ~ 113°F)	-5°C ~ 45°C(23°F ~ 113°F)

Unit		3 Unit	
System Capacity (HP)		58	60
Model	Combination Unit	ARWN580LAS4	ARWN600LAS4
	Independent Unit	ARWN200LAS4	ARWN200LAS4
		ARWN200LAS4	ARWN200LAS4
		ARWN180LAS4	ARWN200LAS4
Refrigerant Precharged Amount	kg	3.0 + 3.0 + 3.0	3.0 + 3.0 + 3.0
Maximum Connectable Number of Indoor Units		64	64
Net Weight	kg	140 x 3	140 x 3
	lbs	309 x 3	309 x 3
Dimensions(WxHxD)	mm	(755 x 997 x 500) x 3	(755 x 997 x 500) x 3
	inch	(29-23/32 x 39-1/4 x 19-11/16) x 3	(29-23/32 x 39-1/4 x 19-11/16) x 3
Refrigerant Connecting Pipes	Liquid mm(inch)	19.05(3/4)	19.05(3/4)
	Gas mm(inch)	41.3(1-5/8)	41.3(1-5/8)
Water Connecting Pipes	Inlet mm	PT40(Internal thread)	PT40(Internal thread)
	Outlet mm	PT40(Internal thread)	PT40(Internal thread)
	Drain Outlet mm	PT20(External thread)	PT20(External thread)
Temp. range of Circulation water	Cooling	10°C ~ 45°C(50°F ~ 113°F)	10°C ~ 45°C(50°F ~ 113°F)
	Heating	-5°C ~ 45°C(23°F ~ 113°F)	-5°C ~ 45°C(23°F ~ 113°F)

Unit		4 Unit		
System Capacity (HP)		62	64	66
Model	Combination Unit	ARWN620LAS4	ARWN640LAS4	ARWN660LAS4
	Independent Unit	ARWN200LAS4	ARWN200LAS4	ARWN200LAS4
		ARWN200LAS4	ARWN200LAS4	ARWN200LAS4
		ARWN120LAS4	ARWN120LAS4	ARWN140LAS4
		ARWN100LAS4	ARWN120LAS4	ARWN120LAS4
Refrigerant Precharged Amount	kg	3.0 + 3.0 + 5.8 + 5.8	3.0 + 3.0 + 5.8 + 5.8	3.0 + 3.0 + 5.8 + 5.8
Maximum Connectable Number of Indoor Units		64	64	64
Net Weight	kg	(140 x 2) + (127 x 2)	(140 x 2) + (127 x 2)	(140 x 2) + (127 x 2)
	lbs	(309 x 2) + (280 x 2)	(309 x 2) + (280 x 2)	(309 x 2) + (280 x 2)
Dimensions(WxHxD)	mm	(755 x 997 x 500) x 4	(755 x 997 x 500) x 4	(755 x 997 x 500) x 4
	inch	(29-23/32 x 39-1/4 x 19-11/16) x 4	(29-23/32 x 39-1/4 x 19-11/16) x 4	(29-23/32 x 39-1/4 x 19-11/16) x 4
Refrigerant Connecting Pipes	Liquid mm(inch)	22.2(7/8)	22.2(7/8)	22.2(7/8)
	Gas mm(inch)	44.5(1-3/4)	44.5(1-3/4)	53.98(2-1/8)
Water Connecting Pipes	Inlet mm	PT40(Internal thread)	PT40(Internal thread)	PT40(Internal thread)
	Outlet mm	PT40(Internal thread)	PT40(Internal thread)	PT40(Internal thread)
	Drain Outlet mm	PT20(External thread)	PT20(External thread)	PT20(External thread)
Temp. range of Circulation water	Cooling	10°C ~ 45°C(50°F ~ 113°F)	10°C ~ 45°C(50°F ~ 114°F)	10°C ~ 45°C(50°F ~ 115°F)
	Heating	-5°C ~ 45°C(23°F ~ 113°F)	-5°C ~ 45°C(23°F ~ 114°F)	-5°C ~ 45°C(23°F ~ 115°F)

Unit		4 Unit			
System Capacity (HP)		68	70	72	
Model	Combination Unit	ARWN680LAS4	ARWN700LAS4	ARWN720LAS4	
		ARWN200LAS4	ARWN200LAS4	ARWN200LAS4	
	Independent Unit	ARWN200LAS4	ARWN200LAS4	ARWN200LAS4	
		ARWN140LAS4	ARWN160LAS4	ARWN180LAS4	
		ARWN140LAS4	ARWN140LAS4	ARWN140LAS4	
Refrigerant Precharged Amount	kg	3.0 + 3.0 + 5.8 + 5.8	3.0 + 3.0 + 3.0 + 5.8	3.0 + 3.0 + 3.0 + 5.8	
Maximum Connectable Number of Indoor Units		64	64	64	
Net Weight	kg	(140 x 2) + (127 x 2)	(140 x 3) + (127 x 1)	(140 x 3) + (127 x 1)	
	lbs	(309 x 2) + (280 x 2)	(309 x 3) + (280 x 1)	(309 x 3) + (280 x 1)	
Dimensions(WxHxD)	mm	(755 x 997 x 500) x 4	(755 x 997 x 500) x 4	(755 x 997 x 500) x 4	
	inch	(29-23/32 x 39-1/4 x 19-11/16) x 4	(29-23/32 x 39-1/4 x 19-11/16) x 4	(29-23/32 x 39-1/4 x 19-11/16) x 4	
Refrigerant Connecting Pipes	Liquid	mm(inch)	22.2(7/8)	22.2(7/8)	22.2(7/8)
	Gas	mm(inch)	53.98(2-1/8)	53.98(2-1/8)	53.98(2-1/8)
Water Connecting Pipes	Inlet	mm	PT40(Internal thread)	PT40(Internal thread)	PT40(Internal thread)
	Outlet	mm	PT40(Internal thread)	PT40(Internal thread)	PT40(Internal thread)
	Drain Outlet	mm	PT20(External thread)	PT20(External thread)	PT20(External thread)
Temp. range of Circulation water	Cooling		10°C ~ 45°C(50°F ~ 116°F)	10°C ~ 45°C(50°F ~ 117°F)	10°C ~ 45°C(50°F ~ 118°F)
	Heating		-5°C ~ 45°C(23°F ~ 116°F)	-5°C ~ 45°C(23°F ~ 117°F)	-5°C ~ 45°C(23°F ~ 118°F)

Unit		4 Unit		
System Capacity (HP)		74	76	
Model	Combination Unit	ARWN740LAS4	ARWN760LAS4	
		ARWN200LAS4	ARWN200LAS4	
	Independent Unit	ARWN200LAS4	ARWN200LAS4	
		ARWN200LAS4	ARWN180LAS4	
		ARWN140LAS4	ARWN180LAS4	
Refrigerant Precharged Amount	kg	3.0 + 3.0 + 3.0 + 5.8	3.0 + 3.0 + 3.0 + 3.0	
Maximum Connectable Number of Indoor Units		64	64	
Net Weight	kg	(140 x 3) + (127 x 1)	140 x 4	
	lbs	(309 x 3) + (280 x 1)	309 x 4	
Dimensions(WxHxD)	mm	(755 x 997 x 500) x 4	(755 x 997 x 500) x 4	
	inch	(29-23/32 x 39-1/4 x 19-11/16) x 4	(29-23/32 x 39-1/4 x 19-11/16) x 4	
Refrigerant Connecting Pipes	Liquid	mm(inch)	22.2(7/8)	22.2(7/8)
	Gas	mm(inch)	53.98(2-1/8)	53.98(2-1/8)
Water Connecting Pipes	Inlet	mm	PT40(Internal thread)	PT40(Internal thread)
	Outlet	mm	PT40(Internal thread)	PT40(Internal thread)
	Drain Outlet	mm	PT20(External thread)	PT20(External thread)
Temp. range of Circulation water	Cooling		10°C ~ 45°C(50°F ~ 119°F)	10°C ~ 45°C(50°F ~ 120°F)
	Heating		-5°C ~ 45°C(23°F ~ 119°F)	-5°C ~ 45°C(23°F ~ 120°F)

Unit		4 Unit		
System Capacity (HP)		78	80	
Model	Combination Unit	ARWN780LAS4	ARWN800LAS4	
		ARWN200LAS4	ARWN200LAS4	
	Independent Unit	ARWN200LAS4	ARWN200LAS4	
		ARWN200LAS4	ARWN200LAS4	
		ARWN180LAS4	ARWN200LAS4	
Refrigerant Precharged Amount	kg	3.0 + 3.0 + 3.0 + 3.0	3.0 + 3.0 + 3.0 + 3.0	
Maximum Connectable Number of Indoor Units		64	64	
Net Weight	kg	140 x 4	140 x 4	
	lbs	309 x 4	309 x 4	
Dimensions(WxHxD)	mm	(755 x 997 x 500) x 4	(755 x 997 x 500) x 4	
	inch	(29-23/32 x 39-1/4 x 19-11/16) x 4	(29-23/32 x 39-1/4 x 19-11/16) x 4	
Refrigerant Connecting Pipes	Liquid	mm(inch)	22.2(7/8)	22.2(7/8)
	Gas	mm(inch)	53.98(2-1/8)	53.98(2-1/8)
Water Connecting Pipes	Inlet	mm	PT40(Internal thread)	PT40(Internal thread)
	Outlet	mm	PT40(Internal thread)	PT40(Internal thread)
	Drain Outlet	mm	PT20(External thread)	PT20(External thread)
Temp. range of Circulation water	Cooling		10°C ~ 45°C(50°F ~ 121°F)	10°C ~ 45°C(50°F ~ 122°F)
	Heating		-5°C ~ 45°C(23°F ~ 121°F)	-5°C ~ 45°C(23°F ~ 122°F)

ALTERNATIVE REFRIGERANT R410A

The refrigerant R410A has the property of higher operating pressure in comparison with R22.

Therefore, all materials have the characteristics of higher resisting pressure than R22 ones and this characteristic should be also considered during the installation.

R410A is an azeotrope of R32 and R125 mixed at 50:50, so the ozone depletion potential (ODP) of R410A is 0.

CAUTION

- The wall thickness of the piping should comply with the relevant local and national regulations for the designed pressure 3.8MPa
- Since R410A is a mixed refrigerant, the required additional refrigerant must be charged in its liquid state. If the refrigerant is charged in its gaseous state, its composition changes and the system will not work properly.
- Do not place the refrigerant container under the direct rays of the sun to prevent it from exploding.
- For high-pressure refrigerant, any unapproved pipe must not be used.
- Do not heat pipes more than necessary to prevent them from softening.
- Be careful not to install wrongly to minimize economic loss because it is expensive in comparison with R22.

SELECT THE BEST LOCATION

Select space for installing outside unit, which will meet the following conditions:

- With strength which bears weight of unit
- With space for air passage and service work
Don't install the unit at the space where generation, inflow, stagnation, and leak of combustible gas is expected.
- Avoid unit installation in a place where acidic solution and spray (sulfur) are often used.
- Location with no leakage of combustible gas
- Recommend the outside unit to be installed within 0~40°C.
- Location with installation or service work space (Refer to required space)
- Do not use the outside unit under any special environment where oil, steam and sulfuric gas exist.
- Install in a separate machine room not exposed to external air
Establish an anti-freeze plan for the water supply when the product is stopped during the winter.
Install the product so that the noise from the machine room is not transferred outdoors
- The floor of the machine room must be water proof.
- Drainage must be installed in the machine room to process the water drainage.
- Install a floor slope to make the drainage smooth.
- Avoid installing the outside unit in the location with following conditions.
- Location where corrosive gas such as acidic gas is generated. (It may cause the refrigerant leakage by corrosion of the pipe.)
- Location where electromagnetic waves happen. (It may cause the abnormal operation by control parts disorder.)
- Location to be able to leak the combustible gas
- Location with carbon fiber or combustible dust.
- Location with the combustible material like thinner or gasoline. (It may cause a fire by leaking the gas near the product.)

CAUTION

- Do not install Multi V water outdoors. Always install indoor like machine room.
- Inverter product may generate electric noise. Keep the body from computer, stereo etc. at enough distance. Specially leave space from indoor remote controller to shoes electric devices at the above 3m in weak electric wave area. Insert the power cable and other wire into separate conduit.

INSTALLATION SPACE

Individual Installation

During the installation of the unit, consider service, inlet, and outlet acquire the minimum space as shown in the figures below.

: Service area

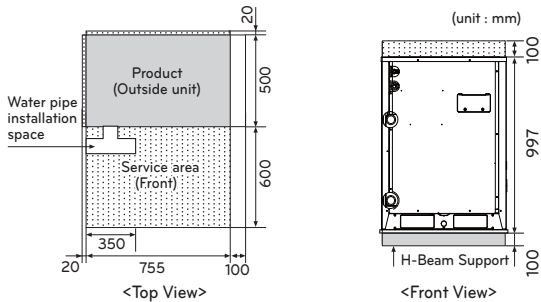

Collective / Continuous Installation

Space required for collective installation and continuous installation as shown below considering passage for air and people.

: Service area

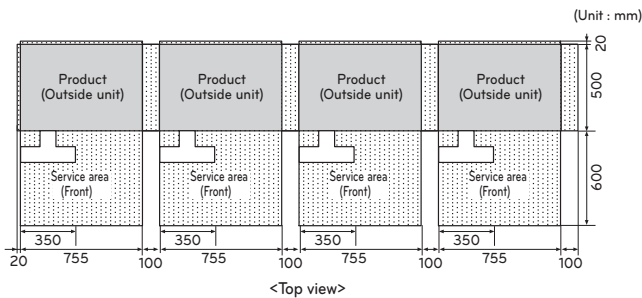

* In case of the water pipe passing side product, please make sufficient service place to avoid occurring between water pipe and product side.

Two Layer Installation

Space required for two layer installation as shown below considering passage for air and people.

: Service area

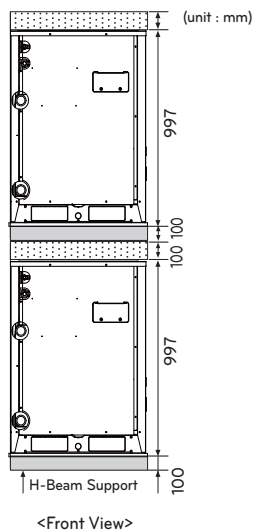

WATER CONTROL

Water control

- Keep the water temperature between 10~45°C. Other it may cause the breakdown.
Standard water supply temperature is 30°C for Cooling and 20°C for heating.
- Properly control the water velocity. Otherwise it may cause the noise, pipe vibration or pipe contraction, expansion according to the temperature. Use the same water pipe size connected with the product or more.
- Refer to the water source pipe diameter and water velocity table below. As the water velocity is fast, air bubble will increase.

Diameter (mm)	Velocity range (m/s)
< 50	0.6 ~ 1.2
50 ~ 100	1.2 ~ 2.1
100 <	2.1 ~ 2.7

- Be careful of the water purity control. Otherwise it may cause the breakdown due to water pipe corrosion.
(Refer to 'Standard Table for Water Purity Control')
- In case the water temperature is above 40°C, it is good to prevent the corrosion by adding the anticorrosive agent.
- Install the pipe, valve and gauge sensor in the space where it is easy to maintain. Install the water valve in the low position for drain, if required.
- Be careful not to let air in. If so, the water velocity will be unstable in the circulation, pump efficiency will also decrease and may cause the piping vibration. Therefore, install the air purge where it may generate the air.
- Choose the following anti freezing methods. Otherwise, it will be dangerous for the pipe to break in the winter.
Circulate the water with the pump before dropping the temperature.
Keep the normal temperature by boiler.
When the cooling tower is not operated for a long time, drain the water in the cooling tower.
Use an anti-freeze. (For using an anti freeze, change the DIP switch on main PCB in outside unit.)
Refer to the additive amount about freezing temperature as in the table given below.

Anti freeze type	Minimum temperature for anti freezing (°C)					
	0	-5	-10	-15	-20	-25
Ethylene glycol (%)	0	12	20	30	-	-
Propylene glycol (%)	0	17	25	33	-	-
Methanol (%)	0	6	12	16	24	30

- In addition to anti freeze, it may cause the change of the pressure in the water system and the low performance of the product.
- Make sure to use the closed cooling type tower.
When applying the open type cooling tower, use a 2nd heat exchanger to make the water supply system a closed type system.

Standard table for water purity control

The water may contain many foreign substances and hence may influence the performance and lifetime of the product due to the corrosion of the condenser and water pipe. (Use water source that complies with the below standard table for water purity control.)

If you use water supply other than the tap water to supply the water for the cooling tower, you must do a water quality inspection.

- If you use the closed cooling tower, the water quality must be controlled in accordance with the following standard table.
If you do not control the water quality in accordance with the following standard water quality table, it can cause performance deterioration to the air conditioner and severe problem to the product

Items	Closed type		Effect	
	Circulating water	Supplemented water	Corrosion	Scale
Basic Item				
pH(25°C)	7.0-8.0	7.0-8.0	○	○
Conductivity[25°C](mS/m)	Below 30	Below 30	○	○
Chlorine ion(mg Cl ⁻ /l)	Below 50	Below 50	○	-
Sulfuric acid ion(mg SO ₄ ²⁻ /l)	Below 50	Below 50	○	○
Acid demand[pH 4.8] (mg SiO ₂ /l)	Below 50	Below 50	-	○
Total hardness(mg SiO ₂ /l)	Below 70	Below 70	-	○
Ca hardness(mg CaCO ₃ /l)	Below 50	Below 50	-	○
Ion silica(mg SiO ₂ /l)	Below 30	Below 30	-	○
Reference Item				
Fe(mg Fe/l)	Below 1.0	Below 0.3	○	○
Copper(mg Cu/l)	Below 1.0	Below 0.1	○	-
Sulfuric acid ion(mg S ²⁻ /l)	Must not be detected	Must not be detected	○	-
Ammonium ion(mg NH ₄ ⁺ /l)	Below 0.3	Below 0.1	○	-
Residual chlorine(mg Cl ₂ /l)	Below 0.25	Below 0.3	○	-
Free carbon dioxide(mg CO ₂ /l)	Below 0.4	Below 4.0	○	-
Stability index	-	-	○	○

Reference

- The "O" mark for corrosion and scale means that there is possibility of occurrence.
- When the water temperature is 40°C or above or when uncoated iron is exposed to the water, it can result in corrosion. Therefore adding anti-corrosion agent or removing the air can be very effective.
- In case of using the closed type cooling tower, the cooling water and supplementing water must satisfy the water quality criteria of closed type system in the table.
- Supplementing water and supplied water must be supplied with tap water, industrial water and underground water excluding filtered water, neutral water, soft water etc.
- 15 items in the table are general causes of corrosion and scale.

LIFTING METHOD

- When carrying the unit suspended, pass the ropes under the unit and use the two suspension points each at the front and rear.
- Always lift the unit with ropes attached at four points so that impact is not applied to the unit.
- Attach the ropes to the unit at an angle of 40° or less

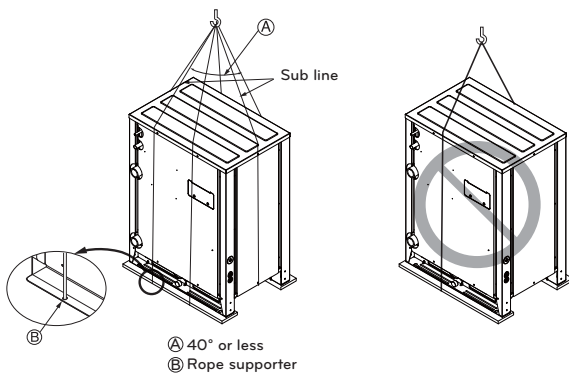

CAUTION

Be very careful while carrying the product.

- Do not have only one person carry product if it is more than 20kg.
- PP bands are used to pack some products. Do not use them as a means for transportation because they are dangerous.
- Tear the plastic packaging bag and scrap it so that children cannot play with it. Otherwise plastic packaging bag may suffocate children.
- When carrying in outside unit, be sure to support it at four points. Carrying in and lifting with 3-point support may make outside unit unstable, resulting in a fall of it.
- Use 2 belts of at least 8 m long.
- Place extra cloth or boards in the locations where the casing comes in contact with the sling to prevent damage.
- Hoist the unit making sure it is being lifted at its center of gravity.

INSTALLATION

- Install at places where it can endure the weight and vibration/noise of the outside unit .
- The outside unit supports at the bottom shall have width of at least 100mm under the Unit's legs before being fixed.
- The outside unit supports should have minimum height of 200mm.
- Anchor bolts must be inserted at least 75mm.

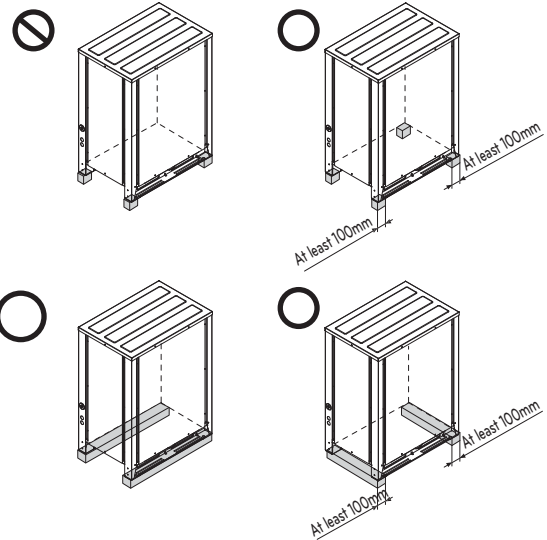

The location of the Anchor bolts

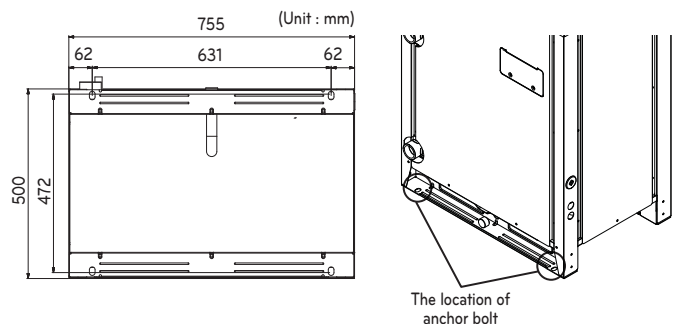

Foundation for Installation

- Fix the unit tightly with bolts as shown below so that unit will not fall down due to earthquake or gust.
- Use the H-beam support as a base support
- Noise and vibration may occur from the floor or wall since vibration is transferred through the installation part depending on installation status. Thus, use anti-vibration materials (cushion pad) fully (The base pad shall be more than 200mm).

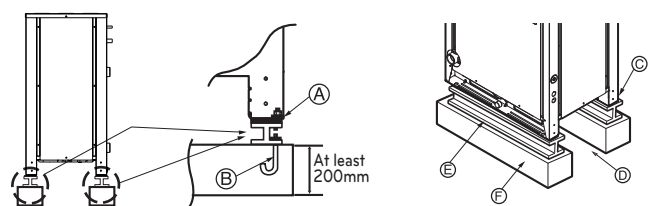

- Ⓐ The corner part must be fixed firmly. Otherwise, the support for the installation may be bent.
- Ⓑ Get and use M10 Anchor bolt.
- Ⓒ Put Cushion Pad between the outside unit and ground support for the vibration protection in wide area.
- Ⓓ Space for pipes and wiring (Pipes and wirings for bottom side)
- Ⓔ H-beam support
- Ⓕ Concrete support

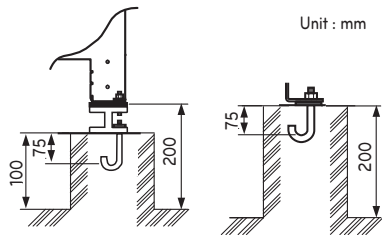

Burrs removal

- Completely remove all burrs from the cut cross section of pipe/tube.
- Put the end of the copper tube/pipe to downward direction as you remove burrs in order to avoid to let burrs drop in the tubing.

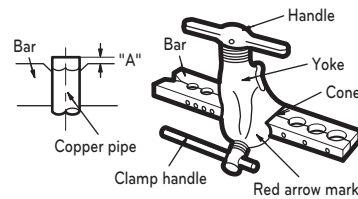

Flaring work

- Carry out flaring work using flaring tool as shown below.

Indoor unit [kW(Btu/h)]	Pipe		" A "	
	Gas	Liquid	Gas	Liquid
<5.6(19,100)	1/2"	1/4"	0.5~0.8	0~0.5
<16.0(54,600)	5/8"	3/8"	0.8~1.0	0.5~0.8
<22.4(76,400)	3/4"	3/8"	1.0~1.3	0.5~0.8

Firmly hold copper tube in a bar(or die) as indicated dimension in the table above.

Check

- Compare the flared work with figure below.
- If flare is noted to be defective, cut off the flared section and do flaring work again.

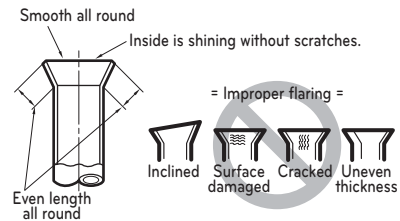

! WARNING

- Install where it can sufficiently support the weight of the outside unit .
If the support strength is not enough, the outside unit may drop and hurt people.
- Install where the outside unit may not fall in strong wind or earthquake.
If there is a fault in the supporting conditions, the outside unit may fall and hurt people.
- Please take extra cautions on the supporting strength of the ground, water outlet treatment(treatment of the water flowing out of the outside unit in operation), and the passages of the pipe and wiring, when making the ground support.
- Do not use tube or pipe for water outlet in the Base pan. Use drainage instead for water outlet. The tube or pipe may freeze and the water may not be drained.

! CAUTION

- Be sure to remove the Pallet(Wood Support) of the bottom side of the outside unit Base Pan before fixing the bolt. It may cause the unstable state of the outdoor settlement, and may cause freezing of the heat exchanger resulting in abnormal operations.
- Be sure to remove the Pallet(Wood Support) of the bottom side of the outside unit before welding. Not removing Pallet(Wood Support) causes hazard of fire during welding.

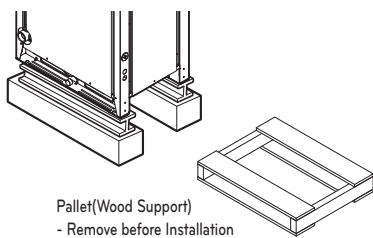

Preparation of Piping

Main cause of gas leakage is defect in flaring work. Carry out correct flaring work in the following procedure.

Cut the pipes and the cable

- Use the accessory piping kit or the pipes purchased locally.
- Measure the distance between the indoor and the outside unit .
- Cut the pipes a little longer than measured distance.
- Cut the cable 1.5m longer than the pipe length.

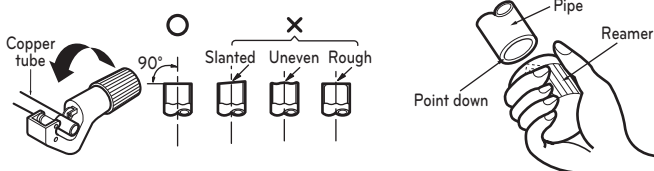

Flare shape and flare nut tightening torque

Precautions when connecting pipes

- See the following table for flare part machining dimensions.
- When connecting the flare nuts, apply refrigerant oil to the inside and outside of the flares and turn them three or four times at first. (Use ester oil or ether oil.)
- See the following table for tightening torque.(Applying too much torque may cause the flares to crack.)
- After all the piping has been connected, use nitrogen to perform a gas leak check.

Pipe size	Tightening torque(N m)	A(mm)	Flare shape
Ø9.52	38±4	12.8-13.2	
Ø12.7	55±6	16.2-16.6	
Ø15.88	75±7	19.3-19.7	

! CAUTION

- Always use a charge hose for service port connection.
- After tightening the cap, check that no refrigerant leaks are present.
- When loosening a flare nut, always use two wrenches in combination, When connecting the piping, always use a spanner and torque wrench in combination to tighten the flare nut.
- When connecting a flare nut, coat the flare(inner and outer faces) with oil for R410A(PVE) and hand tighten the nut 3 to 4 turns as the initial tightening.

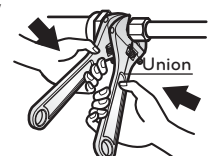

Opening shutoff valve

- 1 Remove the cap and turn the valve counter clockwise with the wrench.
- 2 Turn it until the shaft stops.
Do not apply excessive force to the shutoff valve. Doing so may break the valve body, as the valve is not a backseat type. Always use the special tool.
- 3 Make sure to tighten the cap securely.

Closing shutoff valve

- 1 Remove the cap and turn the valve clockwise with the wrench.
- 2 Securely tighten the valve until the shaft contacts the main body seal.
- 3 Make sure to tighten the cap securely.
* For the tightening torque, refer to the table on the below.

Tightening torque

Shutoff valve size	Tightening torque N·m (Turn clockwise to close)								
	Shaft (valve body)		Hexagonal wrench	Cap (Valve lid)	Service port	Flare nut	Gas line piping attached to unit		
	Closed	Opened							
Ø6.35	6.0±0.6	5.0±0.0	4mm	17.6±2.0	12.7±2	16±2	-		
Ø9.52								10.0±1.0	55±6
Ø12.7									
Ø15.88	12.0±1.2	110±10							
Ø19.05			14.0±1.4	-					
Ø22.2	30.0±3.0	8mm			25±3				
Ø25.4									

Heat insulation

- 1 Use the heat insulation material for the refrigerant piping which has an excellent heat-resistance (over 120°C).
- 2 Precautions in high humidity circumstance:
This air conditioner has been tested according to the "ISO Conditions with Mist" and confirmed that there is not any default. However, if it is operated for a long time in high humid atmosphere (dew point temperature: more than 23°C), water drops are liable to fall. In this case, add heat insulation material according to the following procedure:
 - Heat insulation material to be prepared... EPDM (Ethylene Propylene Diene Methylene)-over 120°C the heat-resistance temperature.
 - Add the insulation over 10mm thickness at high humidity environment.

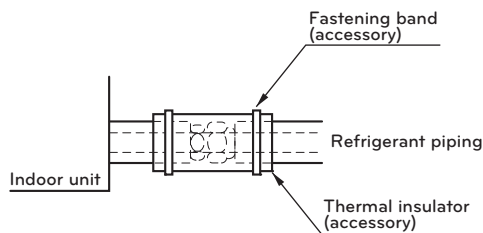

3 Standard refrigerant pipe EPDM heat insulation material thickness.

Classification	Air conditioned location		Non-air conditioned location	
	Note1) General location	Note2) Special location	Note3) General location	Note4) Negative condition
Liquid pipe	Ø6.35	Above t9	Above t9	Above t9
	Ø9.52			
	Above Ø12.7	Above t13	Above t13	Above t13
Gas pipe	Ø9.52	Above t13	Above t19	Above t19
	Ø12.7			
	Ø15.88			
	Ø19.05			
	Ø22.22			
	Ø25.4	Above t19	Above t25	Above t25
	Ø28.58			
	Ø31.75			
	Ø34.9			
	Ø38.1			
Ø44.45				

Note 1) General location: When the pipe passes through indoors in which the indoor unit is operated
- Apartment, classroom, office, mall, hospital, office-tel etc.

Note 2) Special location

- 1 When the location is air conditioned but has severe temperature/humidity difference due to high ceiling
- Church, auditorium, theater, lobby etc.
- 2 When the location is air conditioned but the internal temperature/humidity of the ceiling finishing is high
- Bathroom/swimming pool locker room etc.
(Building with roof ceiling of sandwich assembly type)

Note 3) General location: When the pipe passes indoors where the indoor unit is not operated
- Hall way etc. (Dormitory, school, office-tel)

Note 4) Negative condition: When below conditions 1 and 2 are met.



- 1 When the pipe passes indoors where the indoor unit is not operated
- 2 When the humidity is high, regionally, and there is no air flow in the pipe passing area
- When installing the outside unit within the outside pipe tray or at a location where it is ok to have freezes, apply 13t.
- If you are not sure with the selection of heat insulation material, coordinate with the supervision or HQ.
- The thickness of the above heat insulation material is based on the heat conductivity of 0.088W/m°C.

Plumbing materials and storage methods

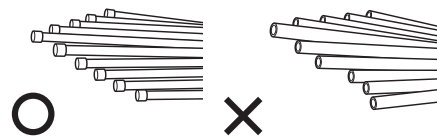
Pipe must be able to obtain the specified thickness and should be used with low impurities.
Also when handling storage, pipe must be careful to prevent a fracture, deformity and wound.
Should not be mixed with contaminations such as dust, moisture.

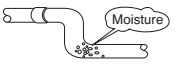

Refrigerant piping on three principles

	Drying	Cleanliness	Airtight
	Should be no moisture inside	No dust inside.	There is no refrigerant leakage
Items			
Cause failure	<ul style="list-style-type: none"> - Significant hydrolysis of refrigerant oil - Degradation of refrigerant oil - Poor insulation of the compressor - Do not cold and warm - Clogging of EEV, Capillary 	<ul style="list-style-type: none"> - Degradation of refrigerant oil - Poor insulation of the compressor - Do not cold and warm - Clogging of EEV, Capillary 	<ul style="list-style-type: none"> - Gas shortages - Degradation of refrigerant oil - Poor insulation of the compressor - Do not cold and warm
Countermeasure	<ul style="list-style-type: none"> - No moisture in the pipe - Until the connection is completed, the plumbing pipe entrance should be strictly controlled. - Stop plumbing at rainy day. - Pipe entrance should be taken side or bottom. - When removal burr after cutting pipe, pipe entrance should be taken down. - Pipe entrance should be fitted cap when pass through the walls. 	<ul style="list-style-type: none"> - No dust in the pipe. - Until the connection is completed, the plumbing pipe entrance should be strictly controlled. - Pipe entrance should be taken side or bottom. - When removal burr after cutting pipe, pipe entrance should be taken down. - Pipe entrance should be fitted cap when pass through the walls. 	<ul style="list-style-type: none"> - Airtightness test should be. - Brazing operations to comply with standards. - Flare to comply with standards. - Flange connections to comply with standards.

Nitrogen substitution method

Welding, as when heating without nitrogen substitution a large amount of the oxide film is formed on the internal piping.

The oxide film is caused by clogging EEV, Capillary, oil hole of accumulator and suction hole of oil pump in compressor.

It prevents normal operation of the compressor.

In order to avoid this problem, Welding should be done after replacing air by nitrogen gas.

When welding plumbing pipe, the work is required.

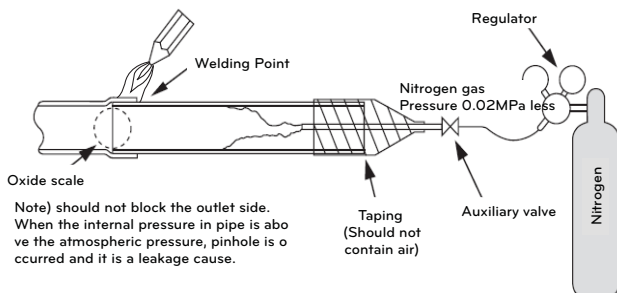

CAUTION

- Always use the nitrogen. (not use oxygen, carbon dioxide, and a Chevron gas): Please use the following nitrogen pressure 0.02MPa Oxygen – Promotes oxidative degradation of refrigerant oil. Because it is flammable, it is strictly prohibited to use Carbon dioxide – Degrade the drying characteristics of gas Chevron Gas – Toxic gas occurs when exposed to direct flame.
- Always use a pressure reducing valve.
- Please do not use commercially available antioxidant. The residual material seems to be the oxide scale is observed. In fact, due to the organic acids generated by oxidation of the alcohol contained in the anti-oxidants, ants nest corrosion occurs. (causes of organic acid → alcohol + copper + water + temperature)

REFRIGERANT PIPING INSTALLATION

WARNING

Always use extreme care to prevent the refrigerant gas (R410A) from leakage while using fire or flame. If the refrigerant gas comes in contact with the flame from any source, such as a gas stove, it breaks down and generates a poisonous gas which can cause gas poisoning. Never perform brazing in an unventilated room. Always conduct an inspection for gas leakage after installation of the refrigerant piping has been completed.

Cautions in pipe connection/valve operation



Open status when both the pipe and the valve are in a straight line.

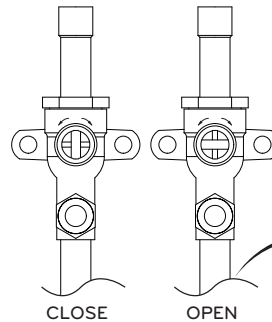

Cut both the pipe and the valve with a cutter to suit the length (Don't cut the length of less than 70mm)

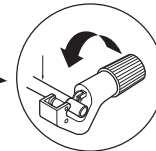

WARNING

After completing work, securely tighten both service ports and caps so that gas does not leak.

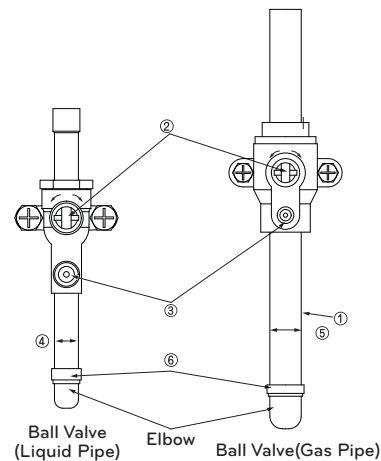

- ① Pipe joint (auxiliary parts): Securely perform brazing with a nitrogen blow into the service valve port. (Releasing pressure : 0.02 MPa or less)
- ② Cap: Remove caps and operate valve, etc. After operation, always reattach caps (tightening torque of valve cap: 25Nm (250kg-cm) or more). (Don't remove the internal part of the port)
- ③ Service port: Make the refrigerant pipe vacuum and charge it using the service port. Always reattach caps after completing work (tightening torque of service cap: 14Nm (140kg-cm) or more).
- ④ Liquid pipe
- ⑤ Gas pipe
- ⑥ Elbow joint (field supply)

- * Remove the front panel before pipe connection
- * Must check the pipe (liquid pipe, gas pipe) before pipe connection

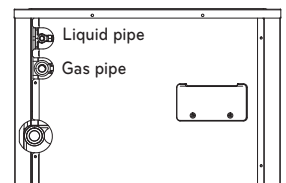

Connection of Outside units

Outside units	Model	Gas Pipe	Liquid Pipe
2 Unit 	ARCNN21		
3 Unit 	ARCNN31		
4 Unit 	ARCNN41		

* Install the branch pipe between outside units so that the outlet pipe is parallel to the surface.

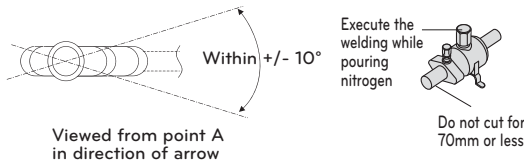

CAUTION

When installing the branch pipe vertically between the outside units, the refrigerant can be uneven between the outside units, leading to compressor burn and reduced capacity.

CAUTION

- Use the following materials for refrigerant piping.
 - Material: Seamless phosphorous deoxidized copper pipe
 - Wall thickness: Comply with the relevant local and national regulations for the designed pressure 3.8MPa. We recommend the following table as the minimum wall thickness.

Outer diameter [mm]	6.35	9.52	12.7	15.88	19.05	22.2	25.4	28.58	31.8	34.9	38.1	41.3	44.45	53.98
Minimum thickness [mm]	0.8	0.8	0.8	0.99	0.99	0.99	0.99	0.99	1.1	1.21	1.35	1.43	1.55	2.1

- Commercially available piping often contains dust and other materials. Always blow it clean with a dry inert gas.
- Use care to prevent dust, water or other contaminants from entering the piping during installation.
- Reduce the number of bending portions as much as possible, and make bending radius as big as possible.
- Always use the branch piping set shown below, which are sold separately.

Y branch	Header		
	4 branch	7 branch	10 branch
ARBLB01621, ARBLB03321, ARBLB07121, ARBLB14521, ARBLB23220	ARBL054	ARBL057	ARBL1010
	ARBL104	ARBL107	ARBL2010

- If the diameters of the branch piping of the designated refrigerant piping differs, use a pipe cutter to cut the connecting section and then use an adapter for connecting different diameters to connect the piping.
- Always observe the restrictions on the refrigerant piping (such as rated length, difference in height, and piping diameter). Failure to do so can result in equipment failure or a decline in heating/cooling performance.

8 A second branch cannot be made after a header. (These are shown by ⊗.)

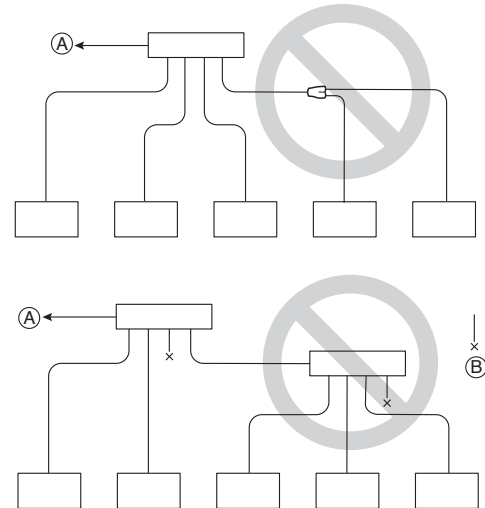

- A To Outside Unit
- B Sealed Piping

- The Multi V will stop due to an abnormality like excessive or insufficient refrigerant. At such a time, always properly charge the unit. When servicing, always check the notes concerning both the piping length and the amount of additional refrigerant.
- Never perform a pump down. This will not only damage the compressor but also deteriorate the performance.
- Never use refrigerant to perform an air purge. Always evacuate using a vacuum pump.
- Always insulate the piping properly. Insufficient insulation will result in a decline in heating/cooling performance, drip of condensate and other such problems.
- When connecting the refrigerant piping, make sure the service valves of the Outside Unit is completely closed (the factory setting) and do not operate it until the refrigerant piping for the Outside and Indoor Units has been connected, a refrigerant leakage test has been performed and the evacuation process has been completed.
- Always use a non-oxidizing brazing material for brazing the parts and do not use flux. If not, oxidized film can cause clogging or damage to the compressor unit and flux can harm the copper piping or refrigerant oil.

WARNING

When installing and moving the air conditioner to another site, be sure to make recharge refrigerant after perfect evacuation.

- If a different refrigerant or air is mixed with the original refrigerant, the refrigerant cycle may malfunction and the unit may be damaged.
- After selecting diameter of the refrigerant pipe to suit total capacity of the indoor unit connected after branching, use an appropriate branch pipe set according to the pipe diameter of the indoor unit and the installation pipe drawing.

INSTALLATION OF WATER PIPE

Water pipe system diagram

- The water pressure resistance of the water pipe system of this product is 1.98MPa
- When the water pipe passes indoors, make sure to execute heat insulation on the pipe so that water drops do not form on the outer side of the water pipe.
- The size of the drain pipe must be equal to or larger than the diameter of the connecting product. Always install a trap so that the drained water does not back flush.

- Always install a strainer (50Mesh or above) at the entrance of the water pipe. (When sand, trash, rusted pieces get mixed into the water supply, it can cause problems to the product due to blocking)

If On/Off valve is applied, by interlocking with outside unit, it can save the energy consumption of pump by blocking the water supply to the outside unit not operating. Select appropriate valve and install on site if necessary.

- Install a pressure gauge and temperature gauge at the inlet and outlet of the water pipe.
- Flexible joints must be installed not to cause any leakage from the vibration of pipes.
- Install a service port to clean the heat exchanger at the each end of the water inlet and outlet.
- For the components of the water pipe system, always use components above the designed water pressure.

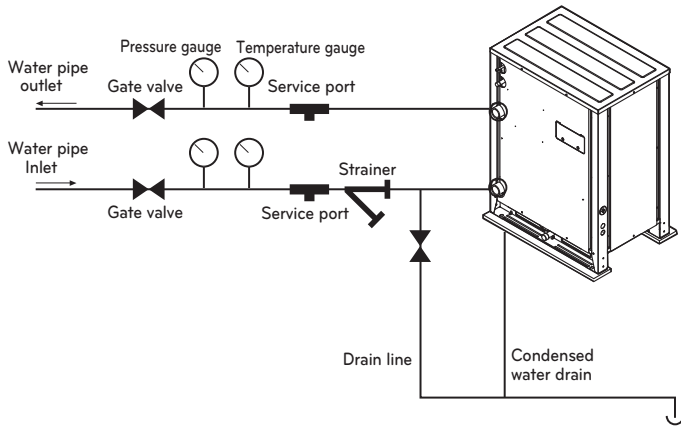

DEVICE PROTECTION UNIT

Strainer on water pipe

To protect the water cooling type product, you must install a strainer with 50 mesh or more on the heat water supply pipe.

If not installed, it can result in damage of heat exchanger by the following situation.

- 1 Heat water supply within the plate type heat exchanger is composed of multiple small paths.
- 2 If you do not use a strainer with 50 mesh or more, alien particles can partially block the water paths.
- 3 When running the heater, the plate type heat exchanger plays the role of the evaporator, and at this time, the temperature of the coolant side drops to drop the temperature of the heat water supply, which can result in icing point in the water paths.
- 4 And as the heating process progresses, the water paths can be partially frozen to lead to damage in plate type heat exchanger.
- 5 As a result of the damage of the heat exchanger from the freezing, the coolant side and the heat water source side will be mixed to make the product unusable.

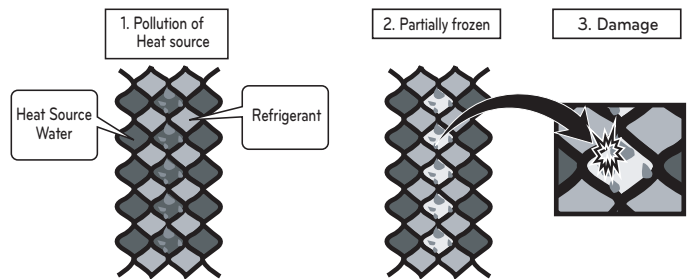

CAUTION

Do not directly connect the drain outlet to the water pipe outlet. (It can cause problems to the product.)

Water pipe connection

- The water pipe should be the same size of the connection on the product or more.
- If necessary install the insulation material in the water pipe inlet/outlet to prevent water drop, freeze and to save energy. (Use the above 20mm thickness PE insulation material.)
- Tightly connect the socket to the water pipe refer to below table for recommended specification. (Too much torque may cause the damage of the facility.)

Pipe thickness		Shear stress		Tensile stress		Bending moment		Torque	
mm	inch	(kN)	(kgf)	(kN)	(kgf)	(N-m)	(kgf-m)	(N-m)	(kgf-m)
12.7	1/2	3.5	350	2.5	250	20	23	5	3.5
19.05	3/4	12	1200	2.5	250	20	2	115	11.5
25.4	1	11.2	1120	4	400	45	4.5	155	15.5
31.8	1 1/4	14.5	1450	6.5	650	87.5	8.75	265	26.5
38.1	1 1/2	16.5	1.7	9.5	0.95	155	16	350	35.5
50.8	2	21.5	2.2	13.5	1.4	255	26	600	61

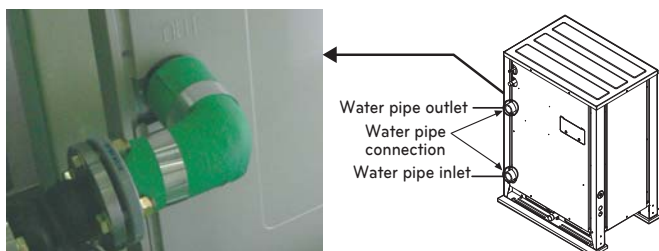

Head loss of strainer on water pipe

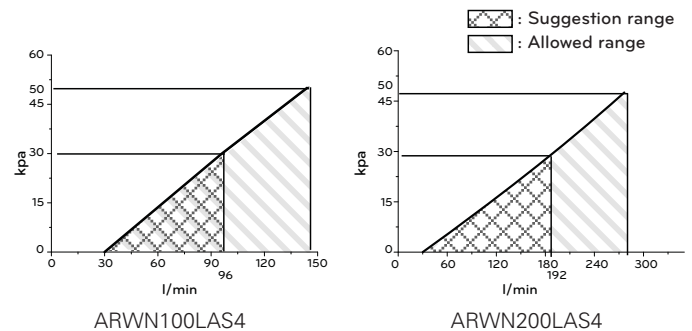

Upper graph is a theoretical value for selection and it may be different according to specification of strainer.

Flow switch work

- It is recommended to install the flow switch to the water collection pipe system connecting to the outside unit. (Flow switch acts as the 1st protection device when the heat water is not supplied. If a certain level of water does not flow after installing the flow switch, an error sign of CH24 error will be displayed on the product and the product will stop operating.)
- When setting the flow switch, it is recommended to use the product with default set value to satisfy the minimum flow rate of this product. (The minimum flow rate range of this product is 50%. Reference flow rate : 10HP – 96LPM, 20HP – 192LPM)
- Select the flow switch with the permitted pressure specification considering the pressure specification of the heat water supply system. (Control signal from outside unit is AC 220V.)

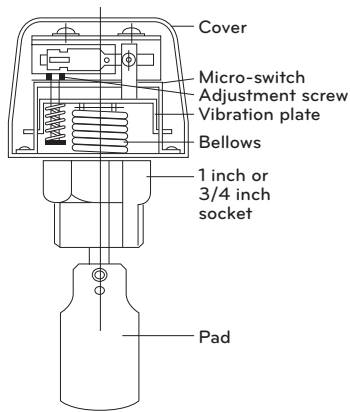

Installation of flow switch

- The flow switch must be installed at the horizontal pipe of the heat water supply outlet of the product and check the direction of the heat water flow before the installation. (Picture 1)
- When connecting the flow switch to the product, remove the jump wire to connect to the communication terminal (5(A) and 5(B)) of the outside unit control box. (Picture 2, 3) (Open the cover of the flow switch and check the wiring diagram before connecting the wires. The wiring method can differ by the manufacturer of the flow switch.)
- If necessary, adjust the flow rate detection screw after consulting with an expert and adjust to the minimum flow rate range. (Picture 4) (Minimum flow rate range of this product is 50%. Adjust the flow switch to touch the contact point when the flow rate reaches 50% of the flow rate.)
- Reference flow rate : 10HP – 96LPM, 20HP – 192LPM



CAUTION

- If the set value does not satisfy the minimum flow rate or if the set value is changed by the user arbitrarily, it can result in product performance deterioration or serious product problem.
- If the product is operated with the heat water supply not flowing smoothly, it can damage the heat exchanger or cause serious product problems.
- In case of CH24 or CH180 error, there is a possibility that the plate type heat exchanger is partially frozen inside. In this case resolve the issue of partial freezing and then operate the product again. (Cause of partial freezing : Insufficient heat water flux, water not supplied, insufficient coolant, alien particle penetrated inside plate type heat exchanger)
- When the product operates while the flow switch touches the contact point at the flow rate range out of the permitted range, it can cause product performance deterioration or serious product problem.
- Must use the normal closed type flow switch
 - Circuit of outside unit is normal closed type.

PIPE CONNECTIONS BETWEEN INDOOR AND OUTSIDE UNIT

Refrigerant piping system

1 Outside Unit

Y branch method

- Ⓐ : Outside Unit
- Ⓑ : 1st branch (Y branch)
- Ⓒ : Indoor Units
- Ⓓ : Downward Indoor Unit

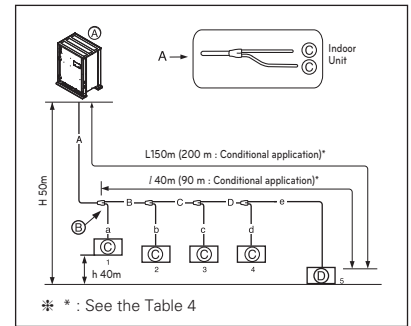

Combination of Y branch/header method

- Ⓐ : Outside Unit
- Ⓑ : 1st branch (Y branch)
- Ⓒ : Y branch
- Ⓓ : Indoor Unit
- Ⓔ : Header
- Ⓕ : Sealed piping

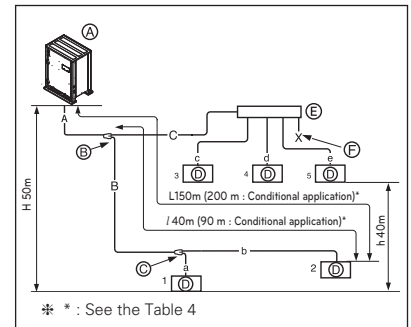

Header method

- Ⓐ : Outside Unit
- Ⓑ : 1st branch
- Ⓒ : Indoor Units
- Ⓓ : Sealed piping
- Ⓔ : Header

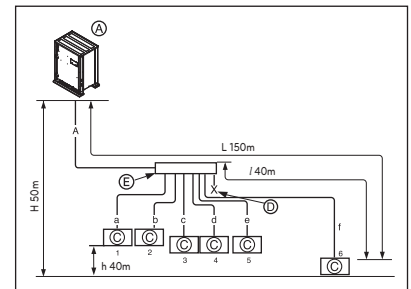

Series Outside Units (2 Units ~ 4 Units)

Y branch method

- Ⓐ : Outside Unit
- Ⓑ : 1st branch (Y branch)
- Ⓒ : Indoor Units
- Ⓓ : Downward Indoor Unit
- Ⓔ : Connection branch pipe between Outside units : ARCNN41
- Ⓕ : Connection branch pipe between Outside units : ARCNN31
- Ⓖ : Connection branch pipe between Outside units : ARCNN21

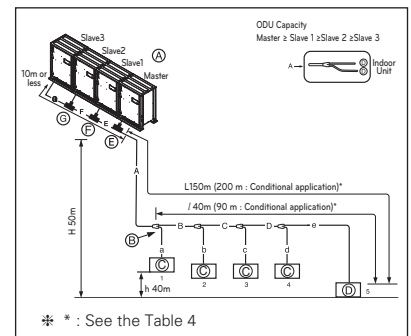

Combination of Y branch/header method

- Ⓐ : Outside Unit
- Ⓑ : 1st branch (Y branch)
- Ⓒ : Y branch
- Ⓓ : Indoor Unit
- Ⓔ : Connection branch pipe between Outside units : ARCNN41
- Ⓕ : Connection branch pipe between Outside units : ARCNN31
- Ⓖ : Connection branch pipe between Outside units : ARCNN21
- Ⓕ : Header
- Ⓖ : Sealed piping

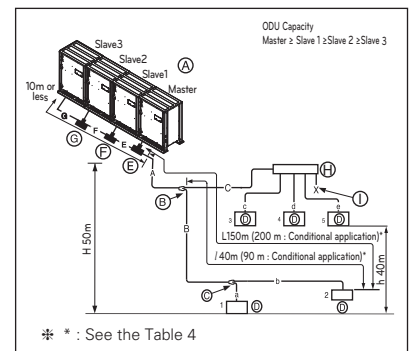

Header method

- Ⓐ : Outside Unit
- Ⓑ : Header
- Ⓒ : Indoor Units
- Ⓓ : Sealed piping
- Ⓔ : Connection branch pipe between Outside units : ARCNN41
- Ⓕ : Connection branch pipe between Outside units : ARCNN31
- Ⓖ : Connection branch pipe between Outside units : ARCNN21

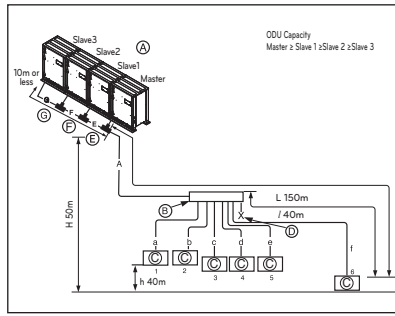

WARNING

Increased Pipe Diameter(table 2)
- When pipe length is Over 40m from 1st branch to longest IDU.

Pipe Connection Method between outside unit /indoor unit

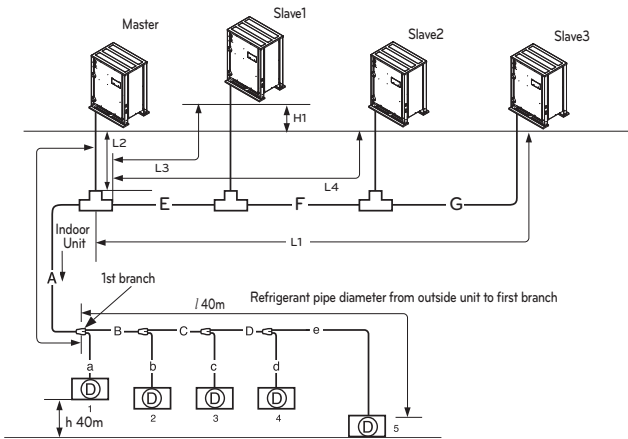

* See Table 2

- A : Refrigerant pipe diameter from outside unit to first branch
- E : Refrigerant pipe diameter for outside unit capacity (Slave 1+ Slave 2+ Slave 3)
- F : Refrigerant pipe diameter for outside unit capacity (Slave 2+ Slave 3)
- G : Refrigerant pipe diameter for outside unit capacity(Slave 3)

Level Difference (H1) (Outside unit ↔ Outside unit)	2m
Max length from first branch to each outside unit (L1,L2,L3,L4)	Less than 10m (equivalent length of piping 13m)

(Table 1) Limit Pipe length

Classification	Section	Type	Y branch	Y/header branch	Header branch
Max pipe length	Outside Unit ↔ Indoor Unit	Maximum pipe length(L)	$A+B+C+D+e \leq 150$ m (Conditionally 200 m)*	$A+B+b \leq 150$ m $A+C+e \leq 150$ m (Conditionally 200m)*	$A+f \leq 150$ m
		Equivalent pipe length	175 m (Conditionally 225 m)*	175 m (Conditionally 225 m)*	175 m
		Total pipe length	300 m (Conditionally 500 m)*	300 m (Conditionally 500 m)*	300 m (Conditionally 500 m)*
Max difference in height	Outside Unit ↔ Indoor Unit	Difference in height(H)	50 m	50 m	50 m
	Indoor Unit ↔ Indoor Unit	Difference in height(h)	40 m	40 m	40 m
Longest pipe length after 1st branch		Pipe length(l)	40 m (Conditionally 90m)*	40 m (Conditionally 90m)*	40 m

* : See Table 4

(Table 2) Refrigerant pipe diameter from outside unit to first branch. (A)

Upward Outside unit total capacity	Standard Pipe Diameter		Increased Pipe Diameter	
	When equivalent pipe length is 90m or more from ODU to farthest IDU			
HP	Liquid pipe [mm(inch)]	Gas pipe [mm(inch)]	Liquid pipe [mm(inch)]	Gas pipe [mm(inch)]
8	Ø 9.52(3/8)	Ø 22.2(7/8)	Ø 12.70(1/2)	Ø 22.2(7/8)
10	Ø 9.52(3/8)	Ø 22.2(7/8)	Ø 12.70(1/2)	Ø 25.4(1)
12 ~ 14	Ø 12.7(1/2)	Ø 25.4(1)	Ø 15.88(5/8)	Ø 28.58(1-1/8)
16	Ø 12.7(1/2)	Ø 28.58(1-1/8)	Ø 15.88(5/8)	Ø 31.8(1-1/4)
18 ~ 20	Ø 12.7(1/2)	Ø 28.58(1-1/8)	Ø 15.88(5/8)	Ø 31.8(1-1/4)
22 ~ 34	Ø 19.05(3/4)	Ø 34.9(1-3/8)	Ø 22.2(7/8)	Ø 38.1(1-1/2)
36 ~ 60	Ø 19.05(3/4)	Ø 41.3(1-5/8)	Ø 22.2(7/8)	Ø 41.3(1-5/8)
62 ~ 64	Ø 22.2(7/8)	Ø 44.5(1-3/4)	Ø 25.4(1)	Ø 53.98(2-1/8)
66 ~ 80	Ø 22.2(7/8)	Ø 53.98(2-1/8)	Ø 25.4(1)	Ø 53.98(2-1/8)

(Table 3) Refrigerant pipe diameter from first branch to last branch (B,C,D)

Downward indoor unit total capacity [kW(Btu/h)]	Liquid pipe [mm(inch)]	Gas pipe [mm(inch)]
≤ 5.6(19,100)	Ø6.35(1/4)	Ø12.7(1/2)
< 16.0 (54,600)	Ø9.52(3/8)	Ø15.88(5/8)
≤ 22.4 (76,400)	Ø9.52(3/8)	Ø19.05(3/4)
< 33.6 (114,700)	Ø9.52(3/8)	Ø22.2(7/8)
< 50.4 (172,000)	Ø12.7(1/2)	Ø28.58(1-1/8)
< 67.2 (229,400)	Ø15.88(5/8)	Ø28.58(1-1/8)
< 72.8(248,500)	Ø15.88(5/8)	Ø34.9(1-3/8)
< 100.8(344,000)	Ø19.05(3/4)	Ø34.9(1-3/8)
< 173.6(592,500)	Ø19.05(3/4)	Ø41.3(1-5/8)
< 184.8(630,700)	Ø22.2(7/8)	Ø44.5(1-3/4)
≤ 224.0(764,400)	Ø22.2(7/8)	Ø53.98(2-1/8)

(Table 4) Conditional Application

To satisfy below condition to make 40 m ~ 90 m of pipe length after first branch.

	Required	Example
1	Diameter of pipes between first branch and the last branch should be increased by one step, except pipe diameter B,C,D is same as Diameter A	$40\text{ m} < B+C+D+e \leq 90\text{ m}$ → B, C, D Change a diameter Ø6.35 → Ø9.52, Ø9.52 → Ø12.7, Ø12.7 → Ø15.88, Ø15.88 → Ø19.05, Ø19.05 → Ø22.2, Ø22.2 → Ø25.4, Ø25.4 → Ø28.58, Ø28.58 → Ø31.8, Ø31.8 → Ø34.9, Ø34.9 → Ø38.1
2	While calculating whole refrigerant pipe length, pipe B,C,D length should be calculated twice.	$A+Bx2+Cx2+Dx2+a+b+c+d+e \leq 500\text{ m}$
3	Length of pipe from each indoor unit to the closest branch ≤ 40 m	$a,b,c,d,e \leq 40\text{ m}$
4	Length of pipe from outdoor unit to the farthest indoor unit 5 (A+B+C+D+e) - [Length of pipe outdoor unit to the closest indoor unit 1 (A+a)] ≤ 40 m	$(A+B+C+D+e) - (A+a) \leq 40\text{ m}$

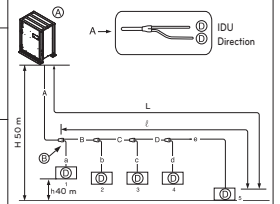

! WARNING

Pipe length after header branching (a~f)

It is recommended that difference in length of the pipes connected to the Indoor Units is minimized. Performance difference between Indoor Units may occur.

Outside unit Connection

! WARNING

- In case of pipe diameter B connected after first branch is bigger than the main pipe diameter A, B should be of the same size with A.

Ex) In case indoor unit combination ratio 120% is connected to 20HP(58kW) outside unit .

- 1) Outside unit main pipe diameter A : Ø28.58(Gas pipe), Ø12.7(liquid pipe)
- 2) Pipe diameter B after first branch according to 120% indoor unit ombination(69.6kW) : Ø28.58(gas pipe), Ø15.88(liquid pipe)

Therefore, pipe diameter B connected after first branch would be Ø28.58(gas pipe) / Ø12.7(liquid pipe) which is same with main pipe diameter.

Indoor Unit Connection

Indoor unit connecting pipe from branch (a~f)

Indoor Unit capacity [kW(Btu/h)]	Liquid pipe [mm(inch)]	Gas pipe [mm(inch)]
≤ 5.6(19,100)	Ø6.35(1/4)	Ø12.7(1/2)
< 16.0(54,600)	Ø9.52(3/8)	Ø15.88(5/8)
< 22.4(76,400)	Ø9.52(3/8)	Ø19.05(3/4)
< 28.0(95,900)	Ø9.52(3/8)	Ø22.2(7/8)

! CAUTION

- Bending radius should be at least twice the diameter of the pipe.
- Bend pipe after 500 mm or more from branch (or header). Do not bend U type. It may cause Performance unsatisfactory or noise.

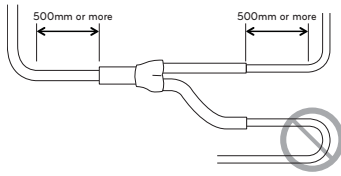

Pipe Connection Method/Precautions for Series connections between Outside units

- Separate Y branch joints are needed for series connections between outside units.
- Please refer to the below connection examples to install pipe connections between outside units.

Pipe connection between outside units (General Case)

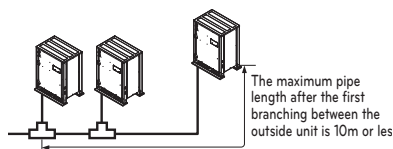

Pipes between outside units are 2m or less

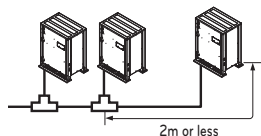

Pipes between outside units are 2m or longer

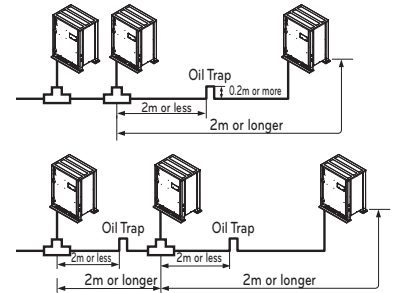

- If the distance between the outside units becomes more than 2m, apply Oil Traps between the gas pipes.
- If the outside unit is located lower than the main pipe, apply Oil Trap.

Oil trap application method between outside units

- Because of the possibility of oil being accumulated in the outside unit that has stopped, when there is a height difference between outside unit pipes or if the pipe distance between the outside units is over 2m, you must always apply an oil trap. (But, the oil trap between outside units is limited to 1 time and is only applied to the gas pipe.)
- If the pipe distance between the outside units is 2m or below, and if the location of the main pipe is lower than that of the outside unit and if the location of the main pipe is lower than that of the outside unit, the oil trap does not have to be applied.
- If the location of the main pipe is higher than the location of the outside unit, be careful since the oil can be accumulated in the stopped outside unit.
- If there is high/low difference between the outside unit pipes, oil can be accumulated to the outside unit on the lower location until the unit stops.

Examples of Wrong Pipe Connections

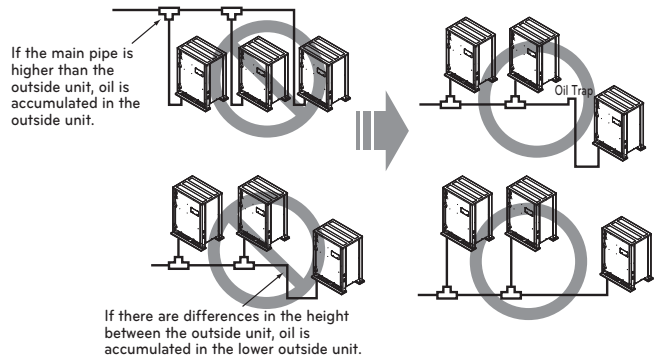

- The pipes between the outside units must maintain horizontal levelness or give an inclination to prevent a back flow toward the slave outside unit. Otherwise, the unit may not operate properly.

(Example 1)

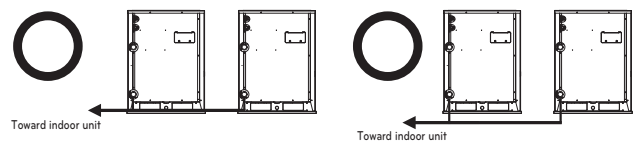

(Example 2)

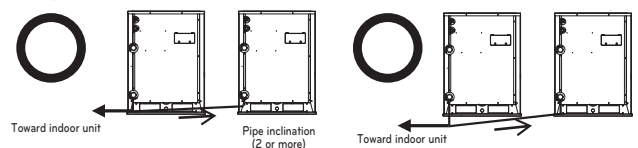

(Example 3)

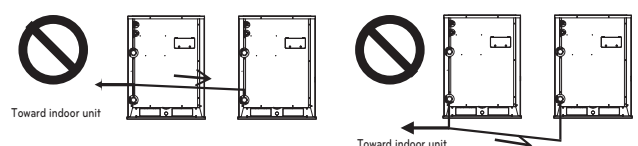

- Apply Oil Trap as shown below when the length of the pipe between the outside units is more than 2m. Otherwise, the unit may not operate properly.

(Example 1)

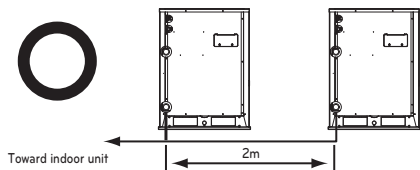

(Example 2)

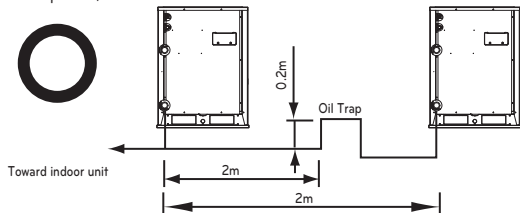

- When connecting the pipes between the outside units, the accumulation of oil in the slave outside unit should be avoided. Otherwise, the unit may not operate properly.

(Example 1)

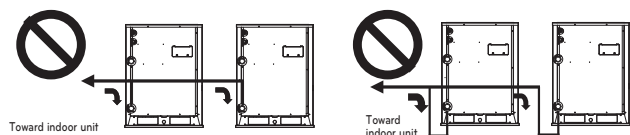

(Example 2)

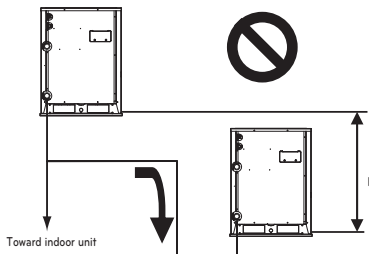

(Example 3)

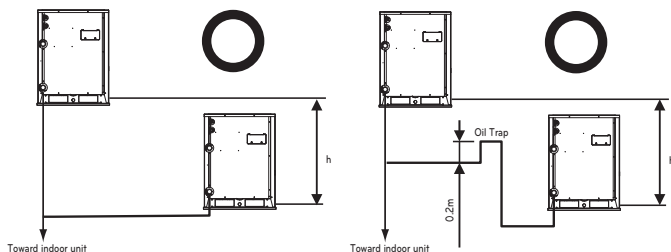

The amount of Refrigerant

The calculation of the additional charge should take into account the length of pipe and CF(correction Factor) value of indoor unit.

Additional charge(kg)	=	Total liquid pipe : Ø25.4 mm	x 0.480(kg/m)
	+	Total liquid pipe : Ø22.2 mm	x 0.354(kg/m)
	+	Total liquid pipe : Ø19.05 mm	x 0.266(kg/m)
	+	Total liquid pipe : Ø15.88 mm	x 0.173(kg/m)
	+	Total liquid pipe : Ø12.7 mm	x 0.118(kg/m)
	+	Total liquid pipe : Ø9.52 mm	x 0.061(kg/m)
	+	Total liquid pipe : Ø6.35 mm	x 0.022(kg/m)
		CF value of indoor unit	

Amount refrigerant of Indoor units
 Example) 4Way Ceiling Cassette 14.5kW -1ea, Ceiling concealed Duct 7.3kW-2ea, Wall Mounted 2.3kW-4ea
 $CF = 0.64 \times 1 + 0.26 \times 2 + 0.24 \times 4 = 2.12 \text{ kg}$

Attach the additional refrigerant table of IDU.

! WARNING

- Regulation for refrigerant leakage
: the amount of refrigerant leakage should satisfy the following equation for human safety.

$$\frac{\text{Total amount of refrigerant in the system}}{\text{Volume of the room at which Indoor Unit of the least capacity is installed}} \leq 0.44 \text{ (kg/m}^3\text{)}$$

If the above equation can not be satisfied, then follow the following steps.

- Selection of air conditioning system: select one of the next
 - Installation of effective opening part
 - Reconfirmation of Outside Unit capacity and piping length
 - Reduction of the amount of refrigerant
 - Installation of 2 or more security device (alarm for gas leakage)
- Change Indoor Unit type
: installation position should be over 2m from the floor (Wall mounted type → Cassette type)
- Adoption of ventilation system
: choose ordinary ventilation system or building ventilation system
- Limitation in piping work
: Prepare for earthquake and thermal stress

Refrigerant charging

- Ⓐ Manifold Gauge
- Ⓑ Low pressure side Handle
- Ⓒ High pressure side Handle

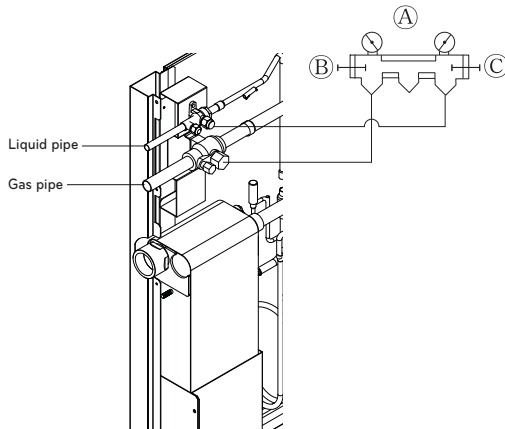
**! WARNING**

- Pipe to be vacuumed : gas pipe, liquid pipe
- If the refrigerant amount is not exact, it may not operate properly.
- If additionally bottled refrigerant amount is over 10%, condenser burst or insufficient indoor unit performance may be caused.

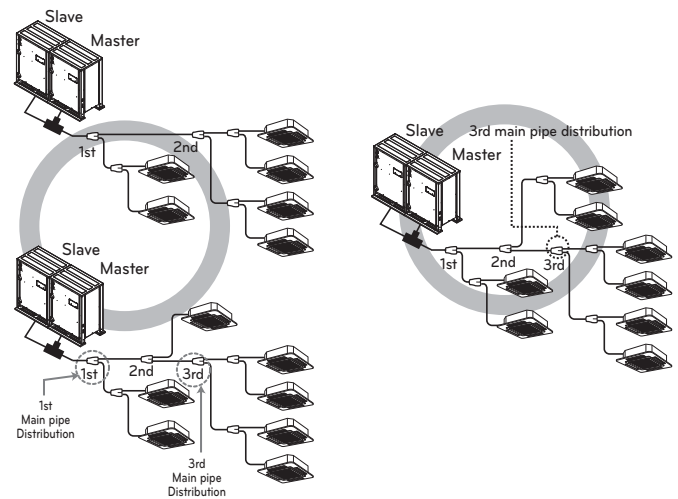
Distribution Method**Horizontal Distribution****Vertical Distribution**

- Ensure that the branch pipes are attached vertically.

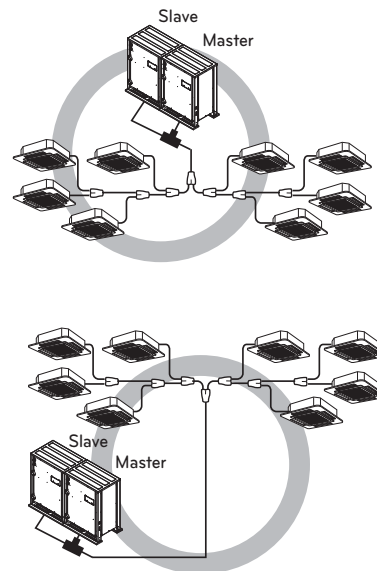
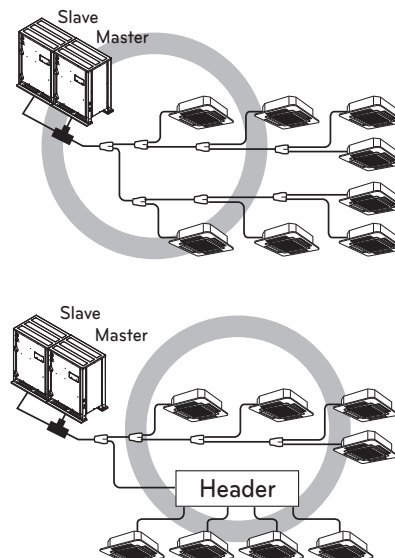
**The others**

Branch pipe Fitting

Y branch

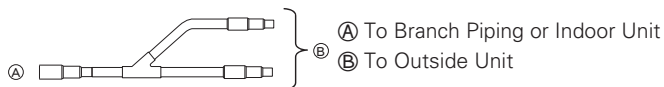

- Ensure that the branch pipes are attached horizontally or vertically (see the diagram below.)

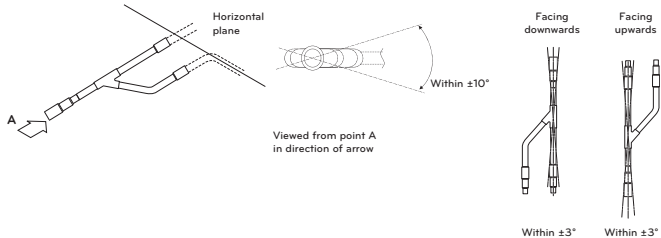

- There is no limitation on the joint mounting configuration.
- If the diameter of the refrigerant piping selected by the procedures described is different from the size of the joint, the connecting section should be cut with a pipe cutter.
- Branch pipe should be insulated with the insulator in each kit.

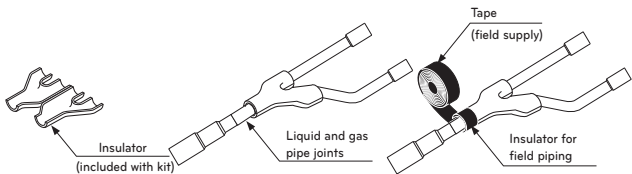

Header

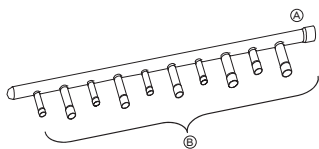

- The indoor unit having larger capacity must be installed closer to ① than smaller one.
- If the diameter of the refrigerant piping selected by the procedures described is different from the size of the joint, the connecting section should be cut with a pipe cutter.

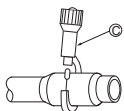

- ③ Pipe cutter
- When the number of pipes to be connected is smaller than the number of header branches, install a cap to the unconnected branches.

- When the number of indoor units to be connected to the branch pipes is less than the number of branch pipes available for connection then cap pipes should be fitted to the surplus branches.

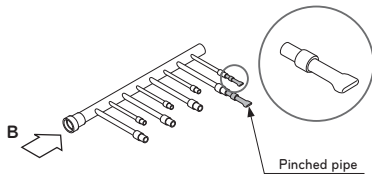

- Fit branch pipe lie in a horizontal plane.

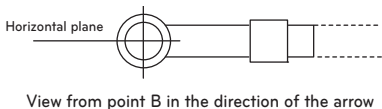

- Header should be insulated with the insulator in each kit.

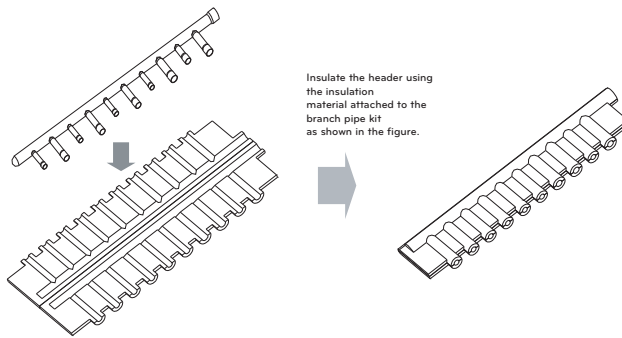

- Joints between branch and pipe should be sealed with the tape included in each kit.

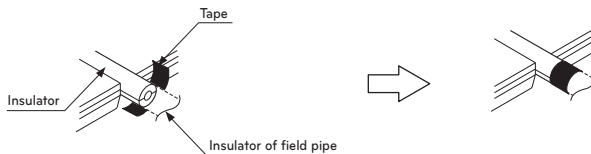

- Any cap pipe should be insulated using the insulator provided with each kit and then taped as described above.

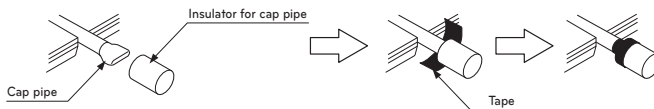

Y branch pipe

[unit:mm]

Models	Gas pipe	Liquid pipe
ARBLN 01621		
ARBLN 03321		
ARBLN 07121		
ARBLN 14521		
ARBLN 23220		

Header

[unit:mm]

Models	Gas pipe	Liquid pipe
4 branch ARBL054		
7 branch ARBL057		
4 branch ARBL104		
7 branch ARBL107		
10 branch ARBL1010		
10 branch ARBL2010		

Leak Test and Vacuum drying

Leak test

Leak test should be made by pressurizing nitrogen gas to 3.8 MPa(38.7kgf/cm²). If the pressure does not drop for 24 hours, the system passes the test. If the pressure drops, check where the nitrogen leaks. For the test method, refer to the following figure. (Make a test with the service valves closed. Be also sure to pressurize liquid pipe, gas pipe and high/low pressure common pipe)

The test result can be judged good if the pressure has not be reduced after leaving for about one day after completion of nitrogen gas pressurization.

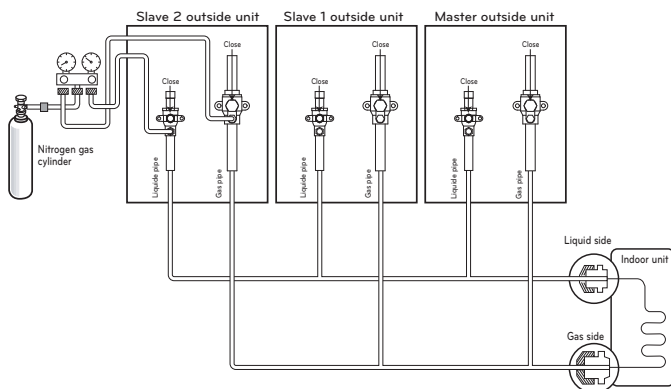

WARNING

Use a vacuum pump or Inert(nitrogen) gas when doing leakage test or air purge. Do not compress air or Oxygen and do not use Flammable gases. Otherwise, it may cause fire or explosion.
- There is the risk of death, injury, fire or explosion.

NOTE

If the ambient temperature differs between the time when pressure is applied and when the pressure drop is checked, apply the following correction factor

There is a pressure change of approximately 0.1 kg/cm² (0.01 MPa) for each 1°C of temperature difference.

Correction= (Temp. at the time of pressurization – Temp. at the time of check) X 0.1

For example: Temperature at the time of pressurization (3.8 MPa) is 27 °C

24 hour later: 3.73 MPa, 20°C

In this case the pressure drop of 0.07 is because of temperature drop And hence there is no leakage in pipe occurred.

CAUTION

To prevent the nitrogen from entering the refrigeration system in the liquid state, the top of the cylinder must be at higher position than the bottom when you pressurize the system.

Usually the cylinder is used in a vertical standing position.

Vacuum

Vacuum drying should be made from the service port provided on the outside unit 's service valve to the vacuum pump commonly used for liquid pipe, gas pipe and high/low pressure common pipe. (Make Vacuum from liquid pipe, gas pipe and high/low pressure common pipe with the service valve closed.)

* Never perform air purging using refrigerant.

- Vacuum drying: Use a vacuum pump that can evacuate to -100.7kPa (5 Torr, -755mmHg).

- Evacuate the system from the liquid and gas pipes with a vacuum pump for over 2 hrs and bring the system to -100.7kPa. After maintaining system under that condition for over 1 hr, confirm the vacuum gauge rises. The system may contain moisture or leak.

- Following should be executed if there is a possibility of moisture remaining inside the pipe. (Rainwater may enter the pipe during work in the rainy season or over a long period of time)

After evacuating the system for 2 hrs, give pressure to the system to 0.05MPa(vacuum break) with nitrogen gas and then evacuate it again with the vacuum pump for 1hr to -100.7kPa(vacuum drying). If the system cannot be evacuated to -100.7kPa within 2 hrs, repeat the steps of vacuum break and its drying. Finally, check if the vacuum gauge does not rise or not, after maintaining the system in vacuum for 1 hr.

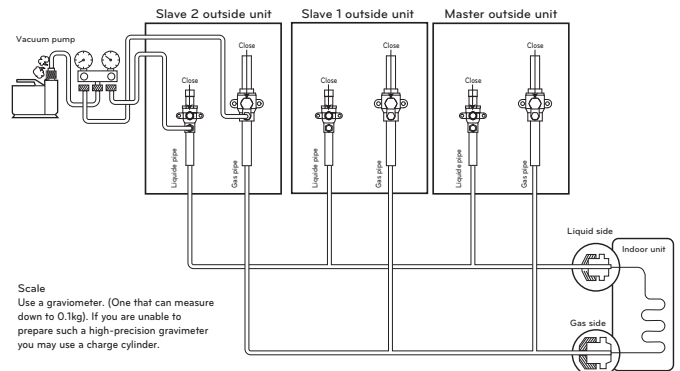

! WARNING

Use a vacuum pump or Inert(nitrogen) gas when doing leakage test or air purge. Do not compress air or Oxygen and do not use Flammable gases. Otherwise, it may cause fire or explosion.

- There is the risk of death, injury, fire or explosion.

! NOTE

Always add an appropriate amount of refrigerant. (For the refrigerant additional charge)

Too much or too little refrigerant will cause trouble.

To use the Vacuum Mode

(If the Vacuum mode is set, all valves of Indoor units and Outside units will be opened.)

! WARNING

When installing and moving the air conditioner to another site, recharge after perfect evacuation.

- If a different refrigerant or air is mixed with the original refrigerant, the refrigerant cycle may malfunction and the unit may be damaged.

Vacuum Mode

This function is used for creating vacuum in the system after compressor replacement, ODU parts replacement or IDU addition/replacement.

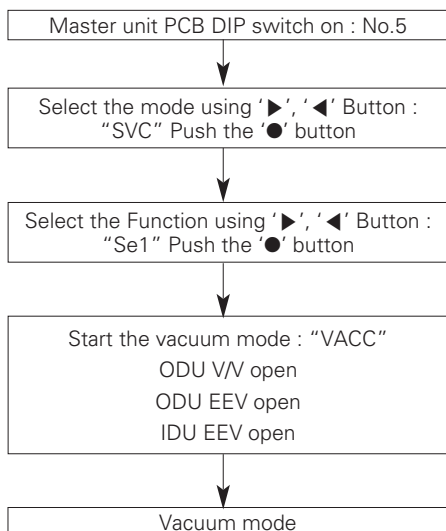
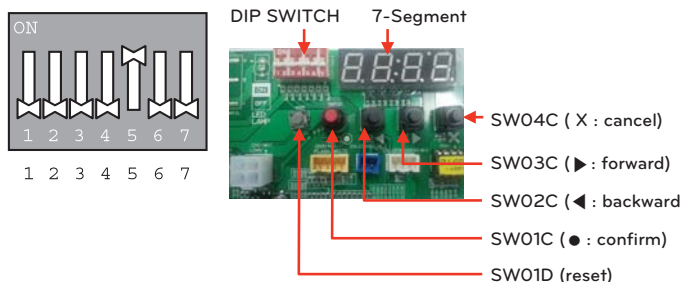
Vacuum mode setting method**Vacuum mode off method**

Dip switch off and push the reset button on Master unit PCB

! CAUTION

ODU operation stops during vacuum mode. Compressor can't operate.

Thermal insulation of refrigerant piping

Be sure to give insulation work to refrigerant piping by covering liquid pipe and gas pipe separately with enough thickness heat-resistant polyethylene, so that no gap is observed in the joint between indoor unit and insulating material, and insulating materials themselves. When insulation work is insufficient, there is a possibility of condensation drip, etc. Pay special attention to insulation work to ceiling plenum.

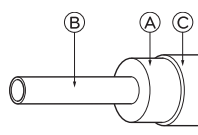

Heat insulation material	Adhesive + Heat - resistant polyethylene foam + Adhesive tape	
Outer covering	Indoor	Vinyl tape
	Floor exposed	Water-proof hemp cloth + Bronze asphalt
	Outdoor	Water-proof hemp cloth + Zinc plate + Oily paint

Ⓐ Heat insulation material

Ⓑ Pipe

Ⓒ Outer covering(Wind the connection part and cutting part of heat insulation material with a finishing tape.)

! NOTE

When using polyethylene cover as covering material, asphalt roofing shall not be required.

Bad example

- Do not insulate gas or low pressure pipe and liquid or high-pressure pipe together.

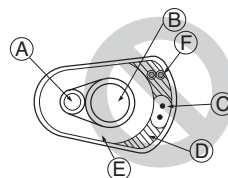

Ⓐ Liquid pipe

Ⓑ Gas pipe

Ⓒ Power lines

Ⓓ Finishing tape

Ⓔ Insulating material

Ⓕ Communication lines

- Be sure to fully insulate connecting portion.

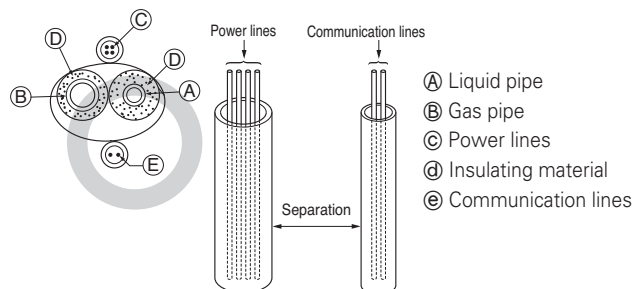

Ⓐ These parts are not insulated.

Good example

Ⓐ Liquid pipe

Ⓑ Gas pipe

Ⓒ Power lines

Ⓓ Insulating material

Ⓔ Communication lines

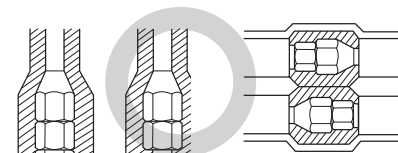

Penetrations

Inner wall (concealed)

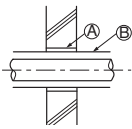

Outer wall

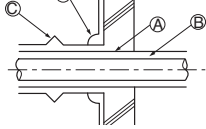

Outer wall (exposed)

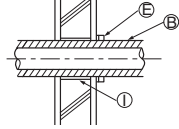

Floor (fireproofing)

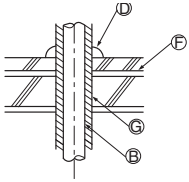

Penetrating portion on fire limit and boundary wall

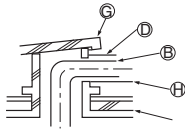

Roof pipe shaft

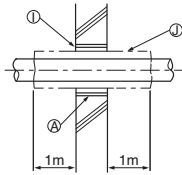

- (A) Sleeve
- (B) Heat insulating material
- (C) Lagging
- (D) Caulking material
- (E) Band
- (F) Waterproofing layer
- (G) Sleeve with edge
- (H) Lagging material
- (I) Mortar or other incombustible caulking
- (J) Incombustible heat insulation material

When filling a gap with mortar, cover the penetration part with steel plate so that the insulation material will not be caved in. For this part, use incombustible materials for both insulation and covering. (Vinyl covering should not be used.)

ELECTRICAL WIRING

CAUTION

- Follow ordinance of your governmental organization for technical standard related to electrical equipment, wiring regulations and guidance of each electric power company.

WARNING

Be sure to have authorized electrical engineers do the electric work using special circuits in accordance with regulations and this installation manual.
If power supply circuit has a lack of capacity or electric work deficiency, it may cause an electric shock or fire.

- Install the Outside Unit communication cable away from the power source wiring so that it is not affected by electric noise from the power source. (Do not run it through the same conduit.)
- Be sure to provide designated grounding work to Outside Unit.

CAUTION

Be sure to correct the outside unit to earth. Do not connect ground wire to any gas pipe, liquid pipe, lightning rod or telephone earth line. If earth is incomplete, it may cause an electric shock.

- Give some allowance to wiring for electrical part box of Indoor and Outside Units, because the box is sometimes removed at the time of service work.
- Never connect the main power source to terminal block of communication cable. If connected, electrical parts will be burnt out.
- Use 2-core shield cable for communication cable. (○ mark in the figure below) If communication cable of different systems are wired with the same multiplecore cable, the resultant poor transmitting and receiving will cause erroneous operations. (⊗ mark in the figure below)
- Only the communication cable specified should be connected to the terminal block for Outside Unit communication.

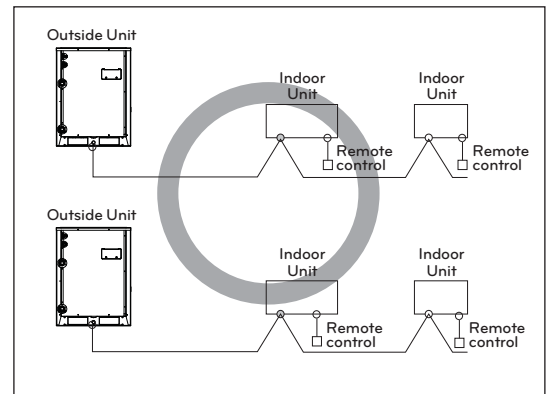

2-Core Shield Cable

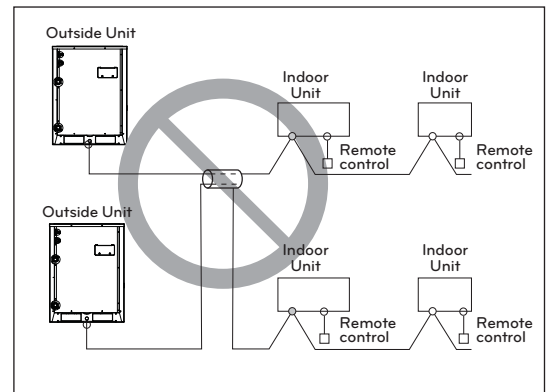

Multi-Core Cable

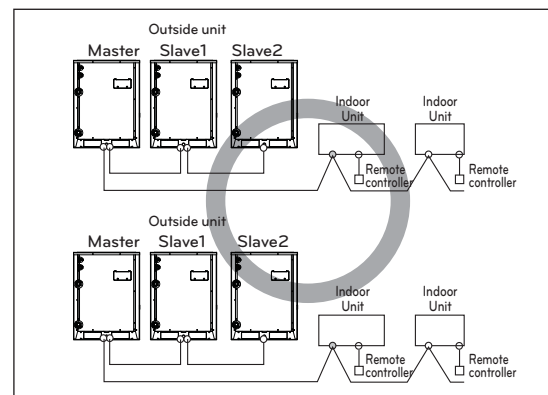

2-Core Shield Cable

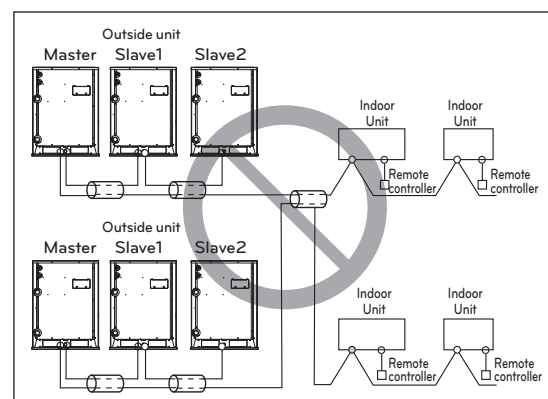

Multi-Core Cable

CAUTION

- Use the 2-core shield cables for communication cables. Never use them together with power cables.
- The conductive shielding layer of cable should be grounded to the metal part of both units.
- Never use multi-core cable
- As this unit is equipped with an inverter, to install a phase leading capacitor not only will deteriorate power factor improvement effect, but also may cause capacitor abnormal heating. Therefore, never install a phase leading capacitor.
- Make sure that the power unbalance ratio is not greater than 2%. If it is greater the units lifespan will be reduced.

Precautions when laying power wiring

Use round pressure terminals for connections to the power terminal block.

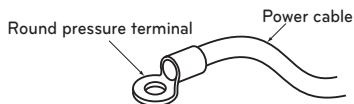

When none are available, follow the instructions below.

- Do not connect wiring of different thicknesses to the power terminal block. (Slack in the power wiring may cause abnormal heat.)
- When connecting cable which is the same thickness, do as shown in the figure below.

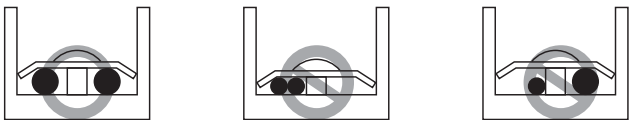

- For wiring, use the designated power cable and connect firmly, then secure to prevent outside pressure being exerted on the terminal block.
- Use an appropriate screwdriver for tightening the terminal screws. A screwdriver with a small head will strip the head and make proper tightening impossible.
- Over-tightening the terminal screws may break them.

CAUTION

When the 400 volt power supply is applied to "N" phase by mistake, check damaged parts in control box and replace them.

Control Box and Wiring Location

- Remove all of the screws at front panel and remove the panel by pulling it forward.
- Connect communication cable between main and sub outside unit through the terminal block.
- Connect communication cables between outside unit and indoor units through the terminal block.
- When the central control system is connected to the outside unit, a dedicated PCB must be connected between them.
- When connecting communication cable between outside unit and indoor units with shielded cable, connect the shield ground to the earth screw.

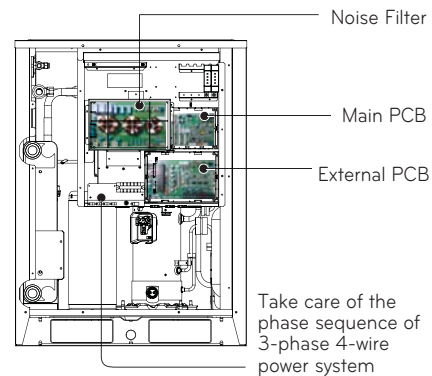
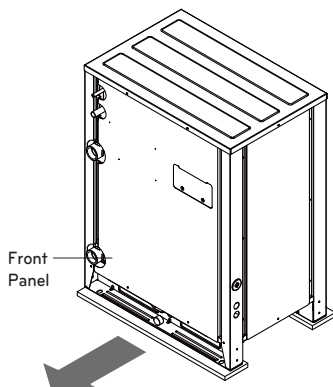
**Communication and Power Cables****Communication cable**

- Types : shielding wire CVVS or CPEVS
- Cross section : 1.0 ~ 1.5 mm²
- Insulation material : PVC
- Maximum allowable temperature: 60°C
- Maximum allowable line length: under 300m

Remote control cable

- Types : 3-core cable

Central control cable

Product type	Cable type	Diameter
ACP&AC Manager	2-core cable (Shielding cable)	1.0~1.5mm ²
AC Smart	2-core cable (Shielding cable)	1.0~1.5mm ²
Simple central controller	4-core cable (Shielding cable)	1.0~1.5mm ²

Separation of communication and power cables

- If communication and power cables are run alongside each other then there is a strong likelihood of operational faults developing due to interference in the signal wiring caused by electrostatic and electromagnetic coupling.

The tables below indicates our recommendation as to appropriate spacing of communication and power cables where these are to be run side by side

Current capacity of power cable		Spacing
100V or more	10A	300mm
	50A	500mm
	100A	1000mm
	Exceed 100A	1500mm

NOTE

- The figures are based on assumed length of parallel cabling up to 100m. For length in excess of 100m the figures will have to be recalculated in direct proportion to the additional length of cable involved.
- If the power supply waveform continues to exhibit some distortion the recommended spacing in the table should be increased.
 - If the cable are laid inside conduits then the following point must also be taken into account when grouping various cable together for introduction into the conduits
 - Power cable (including power supply to air conditioner) and communication cables must not be laid inside the same
 - In the same way, when grouping the power wires and communication cables should not be bunched together.

CAUTION

- If apparatus is not properly earthed then there is always a risk of electric shocks, the earthing of the apparatus must be carried out by a qualified person.

Wiring of main power supply and equipment capacity

- Use a separate power supply for the Outside Unit and Indoor Unit.
- Bear in mind ambient conditions (ambient temperature, direct sunlight, rain water, etc.) when proceeding with the wiring and connections.
- The cable size is the minimum value for metal conduit wiring. The power cord size should be 1 rank thicker taking into account the line voltage drops. Make sure the power-supply voltage does not drop more than 10%.
- Specific wiring requirements should adhere to the wiring regulations of the region.
- Don't install an individual switch or electrical outlet to disconnect each of indoor unit separately from the power supply.

	The thickness of Minimum wire (mm ²)			Leakage circuit breaker (4P ELCB)
	Main power wire	Branch wire	Ground wire	
1 Unit	2.5~6	-	2.5	Below 30~50A 100mA 0.1sec
2 Unit	10~16	-	2.5	Below 75~100A 100mA 0.1sec
3 Unit	25~35	-	4	Below 125~150A 100mA 0.1sec
4 Unit	70	-	6	Below 175~200A 100mA 0.1sec

Ground wire

- 1 The power wire Between the master outside unit and slave1 outside unit - minimum : 6 mm²
 - 2 The power wire Between the slave1 outside unit and slave2 outside unit - minimum : 4 mm²
 - 3 The power wire Between the slave2 outside unit and slave3 outside unit - minimum : 2.5 mm²
- * Power supply cords of appliances for outside unit use shall not be lighter than polychloroprene sheathed flexible cord (code designation 60245 IEC 57).
 - * Please use the 3-phase 4-wire quadrupole Leakage circuit breaker of circuit breaker.

WARNING

- Follow ordinance of your governmental organization for technical standard related to electrical equipment, wiring regulations and guidance of each electric power company.
- Make sure to use specified cables for connections so that no external force is imparted to terminal connections. If connections are not fixed firmly, it may cause heating or fire.
- Make sure to use the appropriate type of overcurrent protection switch. Note that generated overcurrent may include some amount of direct current.

CAUTION

- Some installation site may require attachment of an earth leakage breaker. If no earth leakage breaker is installed, it may cause an electric shock.
- Do not use anything other than breaker and fuse with correct capacity. Using fuse and wire or copper wire with too large capacity may cause a malfunction of unit or fire.

Field Wiring

Single outside unit

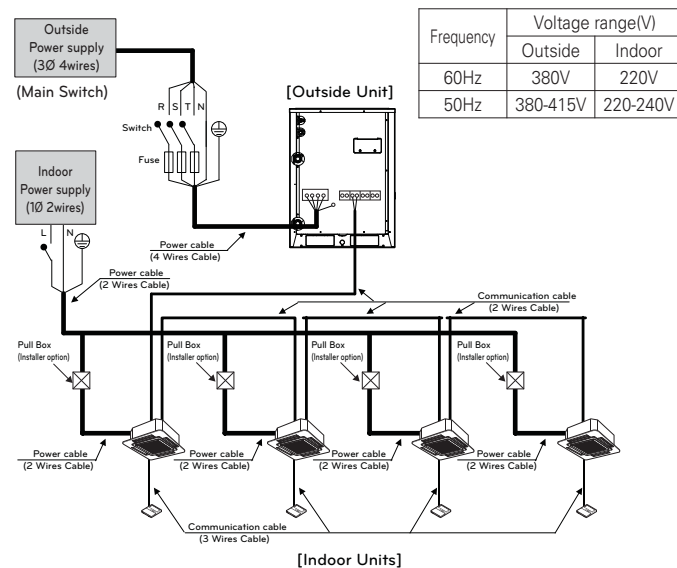

WARNING

- Indoor Unit ground wires are required for preventing electrical shock accident during current leakage, Communication disorder by noise effect and motor current leakage (without connection to pipe).
- Don't install an individual switch or electrical outlet to disconnect each of indoor unit separately from the power supply.
- Install the main switch that can interrupt all the power sources in an integrated manner because this system consists of the equipment utilizing the multiple power sources.
- If there exists the possibility of reversed phase, lose phase, momentary blackout or the power goes on and off while the product is operating, attach a reversed phase protection circuit locally. Running the product in reversed phase may break the compressor and other parts.

[Heat Pump] Between Indoor and Master Outside unit

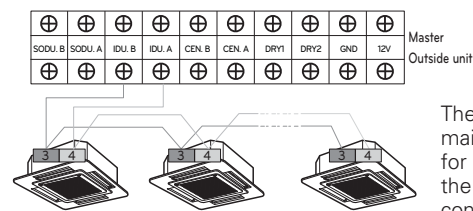

The GND terminal at the main PCB is a '-' terminal for day contact, it is not the point to make ground connection.

Series outside units

When the power source is supplied to Each outside unit individually.

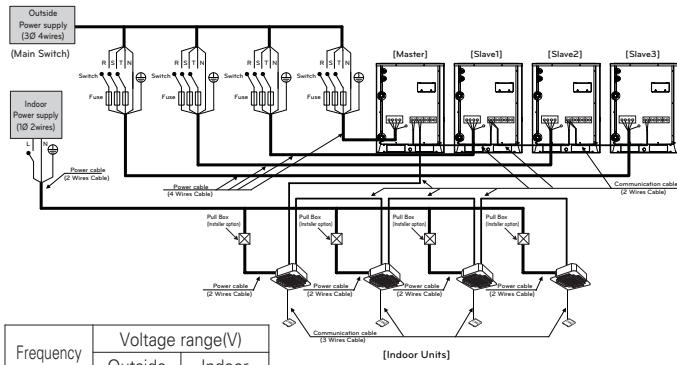

Frequency	Voltage range(V)	
	Outside	Indoor
60Hz	380V	220V
50Hz	380-415V	220-240V

◆ Example Connection of Communication Cable

[BUS type]

- Connection of communication cable must be installed like below figure between indoor unit to outside unit .

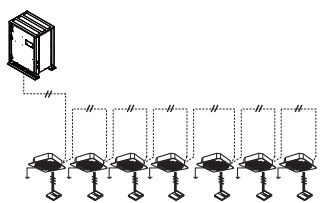

[STAR type]

- Abnormal operation can be caused by communication defect, when connection of communication cable is installed like below figure(STAR type).



Example) Connection of power and communication cable (UWC)

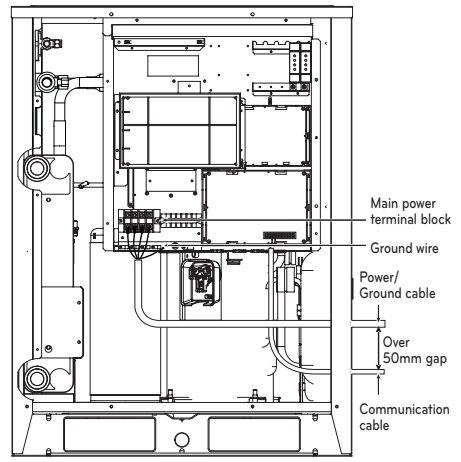

⚠ WARNING

- Indoor Unit ground wires are required for preventing electrical shock accident during current leakage, Communication disorder by noise effect and motor current leakage (without connection to pipe).
- Don't install an individual switch or electrical outlet to disconnect each of indoor unit separately from the power supply.
- Install the main switch that can interrupt all the power sources in an integrated manner because this system consists of the equipment utilizing the multiple power sources.
- If there exists the possibility of reversed phase, lose phase, momentary blackout or the power goes on and off while the product is operating, attach a reversed phase protection circuit locally. Running the product in reversed phase may break the compressor and other parts.

[Heat Pump]

Between Indoor and Master Outside unit

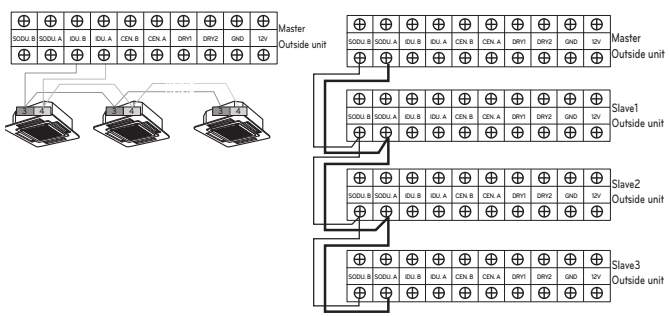

Main Power Connection

Communication Connection

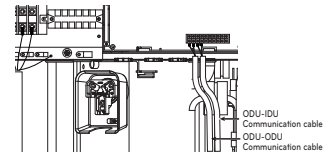
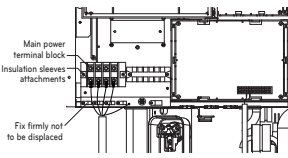

⚠ CAUTION

It should be wiring power cables or communication cables to avoid interference with the oil level sensor. Otherwise, That oil level sensor would be operated abnormally.

The GND terminal at the main PCB is a ' ' terminal for dry contact. It is not the point to make ground connection.

- Make sure that terminal number of master and slave outside unit s are matched.(A-A,B-B)

Checking the setting of outside units

Checking according to dip switch setting

- You can check the setting values of the Master outside unit from the 7 segment LED.

The dip switch setting should be changed when the power is OFF.

Checking the initial display

The number is sequentially appeared at the 7 segment in 5 seconds after applying the power. This number represents the setting condition.

• Initial display order

Order	No	Mean
①	8~20	Master model capacity
②	10~20	Slave 1 model capacity
③	10~20	Slave 2 model capacity
④	10~20	Slave 3 model capacity
⑤	8~80	Total capacity
⑥	1	Cooling Only
	2	Heat Pump
	3	Heat Recovery
⑦	38	380V model
	46	460V model
	22	220V model
⑧	1	LAS4

• Example) ARWN620LAS4

①	②	③	④	⑤	⑥	⑦	⑧
20	20	12	10	62	2	38	1

• Master Unit

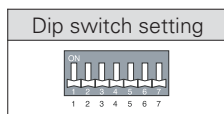

• Slave Unit

Dip switch setting	ODU Setting
	Slave 1
	Slave 2
	Slave 3

Automatic Addressing

The address of indoor units would be set by Automatic Addressing

- Wait for 3 minutes after supplying power. (Master and Slave outside units, indoor units)
- Press RED button of the outside units for 5 seconds. (SW01C)
- A "88" is indicated on 7-segment LED of the outside unit PCB.
- For completing addressing, 2~7 minutes are required depending on numbers of connected indoor units
- Numbers of connected indoor units whose addressing is completed are indicated for 30 seconds on 7-segment LED of the outside unit PCB
- After completing addressing, address of each indoor unit is indicated on the wired remote control display window. (CH01, CH02, CH03,, CH06 : Indicated as numbers of connected indoor units)

[MAIN PCB]

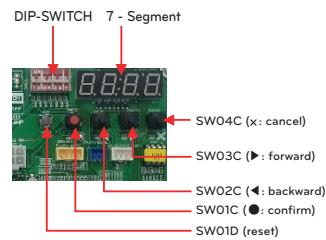

CAUTION

- In replacement of the indoor unit PCB, always perform Automatic addressing setting again (At that time, please check about using Independent power module to any indoor unit.)
- If power supply is not applied to the indoor unit, operation error occur.
- Automatic Addressing is only possible on the master Unit.
- Automatic Addressing has to be performed after 3 minutes to improve communication.

The Procedure of Automatic Addressing

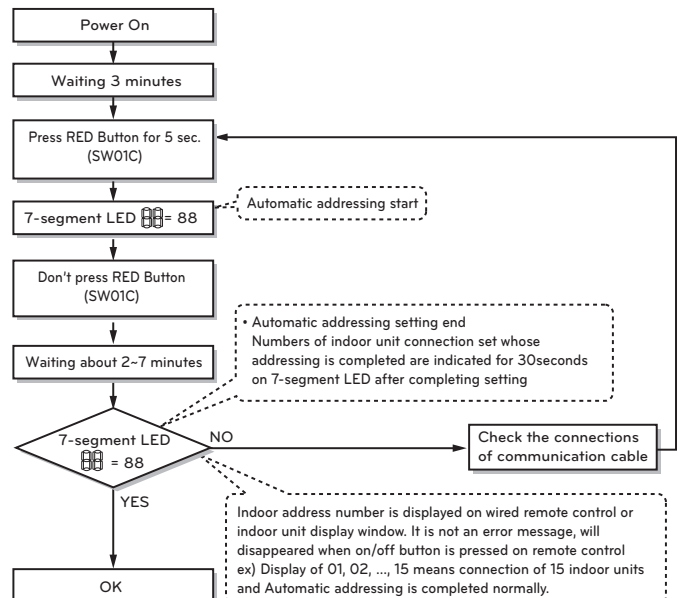

Dip switch setting

Setting the function

Select the mode/function/option/value using '▶', '◀' Button and confirm that using the '●' button after dip switch No.5 is turned on.

CAUTION

It is only executed when all indoor units are off.

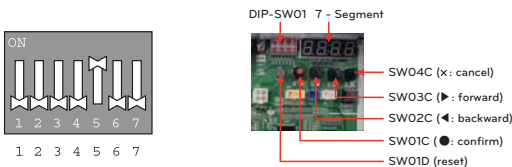

Mode	Function	Option		Value	Action	Remarks					
Content	Display1	Content	Display2	Content	Display3	Content	Display4	Implement	Display5		
In- stallation	Func	Cool & Heat Selector	Fn1	oFF	op1~op2	Selected the option	-	-	Change the set value	Blank	Save in EEPROM
		Geothermal mode setting	Fn2	on	oFF	Selected the option	-	-	Change the set value	Blank	Save in EEPROM
		Sol. Valve 200 V output	Fn3	on	oFF	Selected the option	-	-	Change the set value	Blank	Save in EEPROM
		Variable water flow control	Fn4	on	oFF	Selected the option	-	-	Change the set value	Blank	Save in EEPROM
		Outside unit address	Fn5	-	-	-	0-254	set the value	Change the set value	Blank	Save in EEPROM
		Target pressure adjusting	Fn7	oFF	op1~op4	Selected the option	-	-	Change the set value	Blank	Save in EEPROM
		Use Sump Heater	Fn8	on	oFF	Selected the option	-	-	Change the set value	Blank	Save in EEPROM
		IDU capacity adjusting	Fn9	on	oFF	Selected the option	-	-	Change the set value	Blank	Save in EEPROM

* Functions save in EEPROM will be kept continuously, though the system power was reset.
To cancel the function you need to set OFF.

Group Number setting

Group Number setting for Indoor Units

- Confirm the power of whole system(Indoor Unit, Outside Unit) is OFF, otherwise turn off.
- The communication cables connected to CEN.A and CEN.B terminal should be connected to central control of Outside Unit with care for their polarity (A-A, B-B).
- Turn the whole system on.
- Set the group and Indoor Unit number with a wired remote control.
- To control several sets of Indoor Units into a group, set the group ID from 0 to F for this purpose.

Outside Units (External PCB)

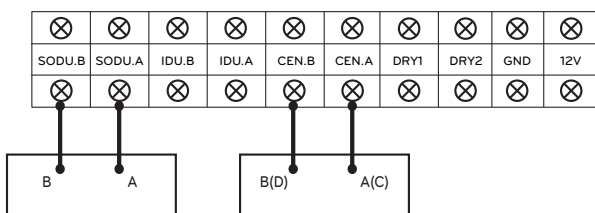

Example) Group number setting

1 E
Group Indoor unit

1st number indicate the group number
2nd number point out indoor unit number

Group recognizing the central controller
No.0 group (00~0F)
No.1 group (10~1F)
No.2 group (20~2F)
No.3 group (30~3F)
No.4 group (40~4F)
No.5 group (50~5F)
No.6 group (60~6F)
No.7 group (70~7F)
No.8 group (80~8F)
No.9 group (90~9F)
No. A group (A0~AF)
No. B group (B0~BF)
No. C group (C0~CF)
No. D group (D0~DF)
No. E group (E0~EF)
No. F group (F0~FF)

Cool & Heat selector

How to set the mode

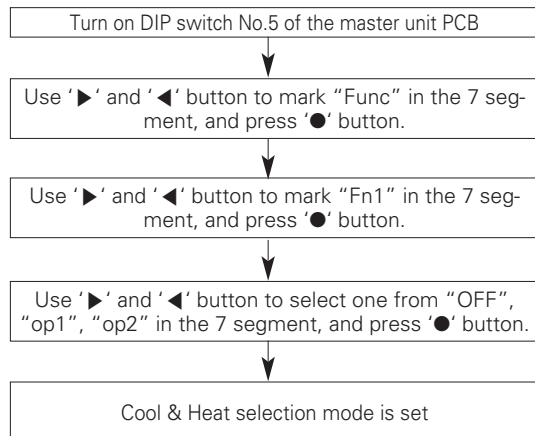

Function setting

Switch control		Function		
Switch(Phase)	Switch(Bottom)	OFF	op1 (mode)	op2(mode)
Right	Left	Not operate	Cooling	Cooling
Right	Right	Not operate	Heating	Heating
Left	-	Not operate	Fan mode	Off

Left side | Right side

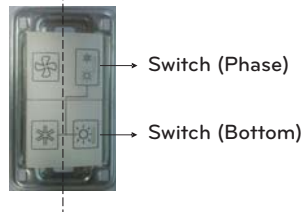

CAUTION

- Request the function settings to the installation specialist during the outside unit installation.
- When the function is not used, set it to OFF.
- If use a function, first install a Cool & Heat selector.

Geothermal mode setting

If you want to use the product with heat source water of the low temperature such as ground heat, it is the function that enables the use of ground heat mode.

How to set the mode

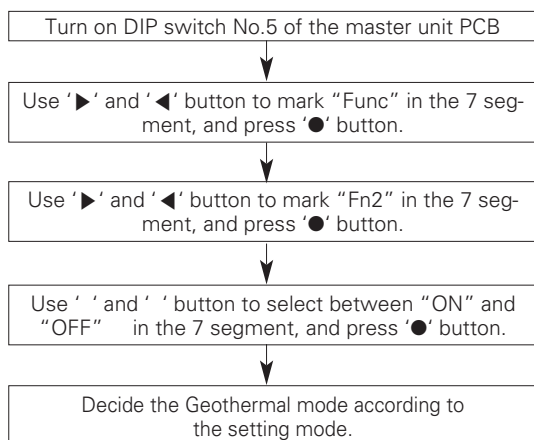

Mode setting

- ON: Set to operate in geothermal mode
- OFF: Set to operate in general mode

Anti freeze type	Minimum temperature for anti freezing (°C)					
	0	-5	-10	-15	-20	-25
Ethylene glycol (%)	0	12	20	30	-	-
Propylene glycol (%)	0	17	25	33	-	-
Methanol (%)	0	6	12	16	24	30

CAUTION

- Request the function settings to the installation specialist during the outside unit installation.
- When the function is not used, set it to OFF.
- Before changing the mode, make sure to check if the antifreeze is added to the heat source water with appropriate ratio. (If it is set to geothermal mode with inappropriate addition of antifreeze or without antifreeze, there is a risk of product damage, and we will not be responsible for such damage of the product.)
- When you add antifreeze, there may be increase of pressure difference in the heat source water system and product performance degradation.
- If it is in geothermal mode, add antifreeze according to the temperature condition of at least -10°C. (If the added amount is of -10°C or more, it may cause freeze and burst of the heat source water.)

Sol. Valve 220V output

It is the function to select 220V output when you want solenoid valve control.

How to set the mode

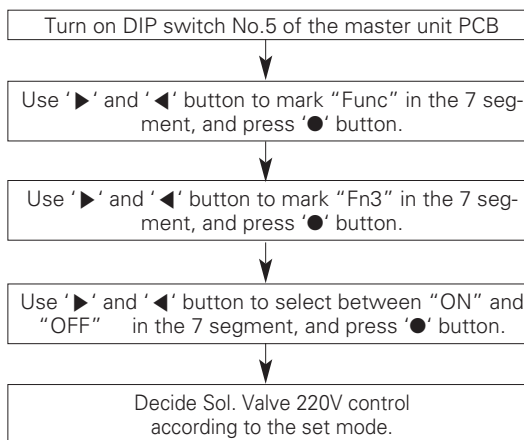

Mode setting

- ON: Set to control the heat source water pipe Solenoid Valve from the product.
- OFF: Set not to control the heat source water pipe Solenoid Valve from the product.

CAUTION

- Request the function settings to the installation specialist during the outside unit installation.
- When the function is not used, set it to OFF.

Variable water flow control

It is the function to select when you want to install Variable water flow control kit and control it from the product.

How to set the mode

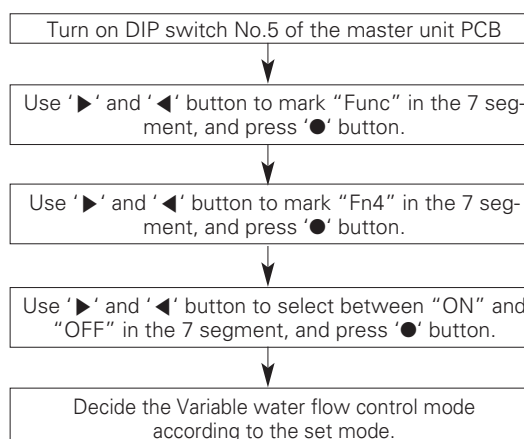

Mode setting

- ON: Set to control the variable water flow control valve from the product
- OFF: Set not to control the variable water flow control valve from the product

CAUTION

- Request the function settings to the installation specialist during the outside unit installation.
- When the function is not used, set it to OFF.

Setting the outside unit address

How to set the mode

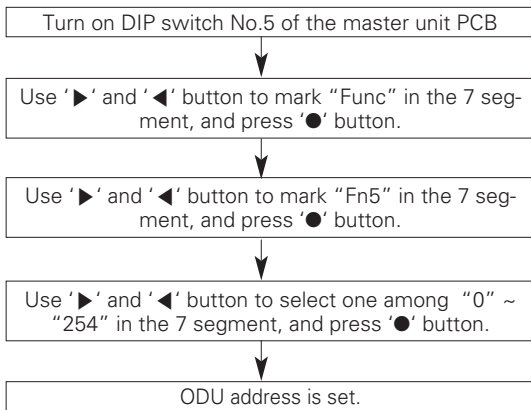

CAUTION

- Request the function settings to the installation specialist during the outside unit installation.
- If use a function, first install a Central controller.

Target pressure adjusting

How to set the mode

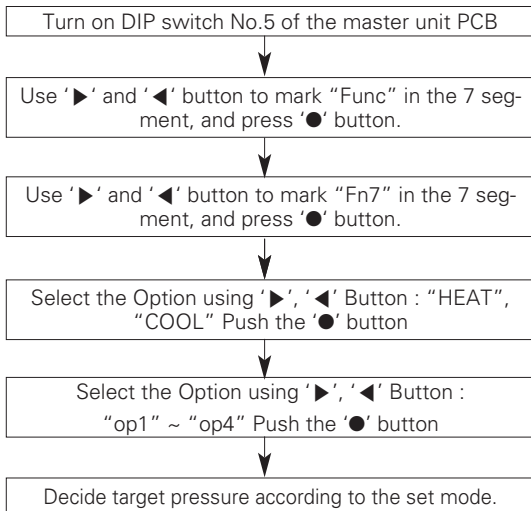

Setting

Mode	Purpose		Condensing temperature variation	Evaporating temperature variation
	Heat	Cool		
op1	Increase capacity	Increase capacity	-3 °C	+2 °C
op2	Decrease power consumption	Increase capacity	-1.5 °C	-2 °C
op3	Decrease power consumption	Decrease power consumption	+2.5 °C	-4 °C
op4	Decrease power consumption	Decrease power consumption	+4.5 °C	-6 °C

CAUTION

- Ask an authorized technician to setting a function.
- If do not use a function, set an off-mode.
- Change a power consumption or capacity.

Use Sump Heater

It is the function to select when you want to connect and use Sump Heater.

How to set the mode

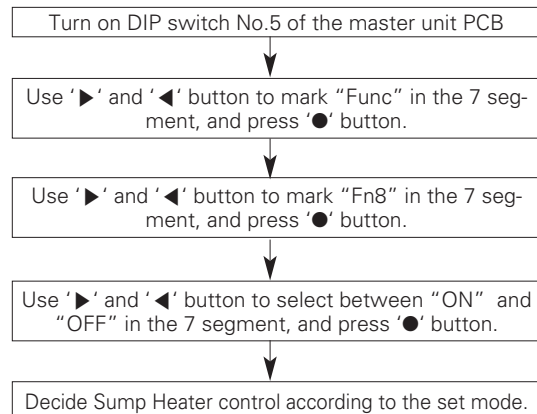

Mode setting

- ON: Set to control the Sump Heater from the product
- OFF: Set not to control the Sump Heater from the product

CAUTION

- Request the function settings to the installation specialist during the outside unit installation.
- When the function is not used, set it to OFF.
- If the temperature of the outside unit installation place is 0°C or less, we recommend the connection and usage of Sump Heater.

IDU capacity adjusting

If the operation of indoor unit is more than 130%, the air flow is operated as low in the all indoor units.

How to set the mode

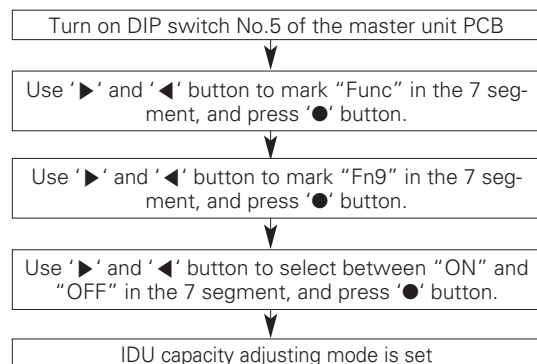

Mode setting

- ON: Set to control the Low capacity mode
- OFF: Set not to control

CAUTION

- Ask an authorized technician to setting a function.

TEST RUN

Precaution before test run

1	Check whether the air is completely removed and the water supply is flowing smoothly.
2	Check whether there is any refrigerant leakage of any disconnected or loose communication or power wire, or use the electric wiring diagram to check the wiring connection condition. Check whether the power and communication wire are connected.
3	<p>Check whether the power cable R, S, T and N are correctly connected. Check the insulation resistance with the DB mega tester device (DC 500V) between the power terminal block and grounding, and check whether it is 2.0MΩ or above when measured. If the resistance is 2.0MΩ or less, do not operate the product. (Precaution)</p> <ul style="list-style-type: none"> - Never check the insulation resistance for the terminal control board. (The control board can be damaged.) - If you leave the system turned off right after the installation or for a long period of time, the refrigerant gets accumulated within the compressor and the insulation resistance reduces to less than 2 MΩ. When the insulation resistance is 2 MΩ or less, turn on the power and let the electricity be supplied to the crank case heater of the compressor and let the refrigerant including the oil inside the compressor to evaporate. Then the insulation resistance value will increase to more than 2.0 MΩ.
4	Check whether the liquid and gas pipes are open.
5	<p>Precaution when blocking the water cooling type Multi V main power</p> <ul style="list-style-type: none"> - While using the product (Air conditioning season/Heating season), always connect the main power of the outside unit. - During the test run operation after installing the product or during the operation after blocking the outside unit main power (Power outage etc.), you must always connect the power 6 hours prior to heating the crank case heater. If the crank case is not preheated for more than 6 hours with the electric heater, it can cause a burn on the compressor. (Heating the bottom part of the compressor with the crank case heater is to evaporate the refrigerant included in the oil inside the compressor.)

Water supply system test run

Before executing the test run for the product, you must first test the heat source water system. The test run for the product must be executed after checking the flow rate and temperature of the heat source water supplied.

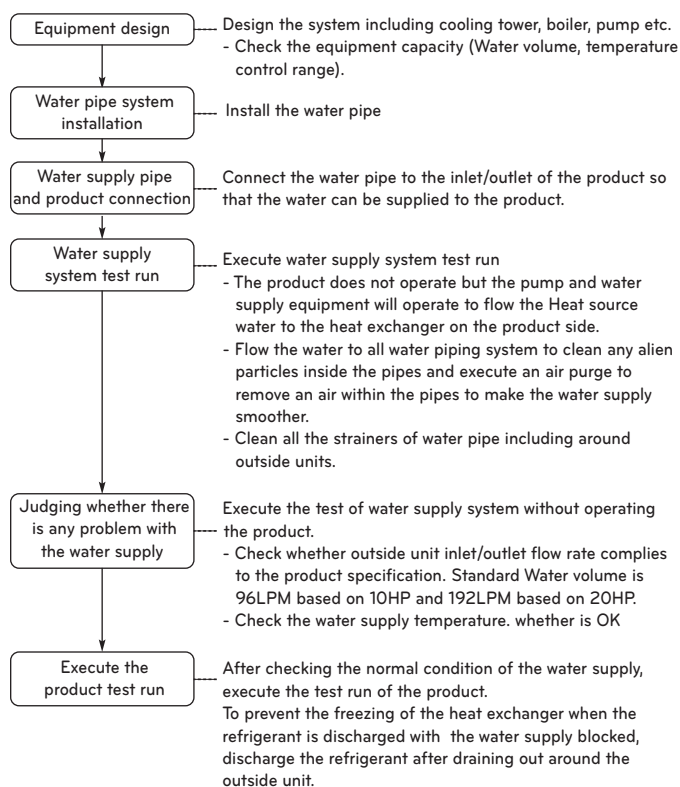

WARNING

- Always check whether the water supply is flowing smoothly before the test run. (If sufficient amount of water is not flowing, it can burn the product.)
- During the initial test run after installing the product, leaving the product for more than 3 days or after replacing the compressor, power must be connected 6 hours prior to the operation to heat the compressor heater. (If the product is not heated sufficiently, it can burn the product.)

How to Cope with Abnormal Test Run

Item	Phenomenon	Cause	Checkpoint and resolution
Whether heat water is supplied	CH24	When connecting the flow switch, heat-sourced water doesn't flow or the amount of its flow lacks due to the checked error related to heat-sourced water.	Check whether the heat source water supply pump is operating.
			Check whether the heat source water supply pipe is clogged. (Clean strainer, valve locked, valve issue, air trapped etc.)
			Check whether the flow switch is normal condition. (Flow switch problem, arbitrary control, disconnection etc.)
	CH32	Heat water not supplied or flow rate is insufficient	Check whether heat source water supply pump is operating. Check whether the heat source water supply pipe is clogged. (Clean strainer, valve locked, valve issue, air trapped etc.)
CH34	Heat water not supplied or flow rate is insufficient (During Cooling)	Check whether heat source water supply pump is operating.	
		Check whether the heat source water supply pipe is clogged. (Clean strainer, valve locked, valve issue, air trapped etc.)	
CH180	Heat water not supplied or flow rate is insufficient (During heating)	Check whether heat source water supply pump is operating. Check whether the heat source water supply pipe is clogged. (Clean strainer, valve locked, valve issue, air trapped etc.)	

* When CH24 or CH180 error occurs during the test operation of the heater, the inside of the panel heat exchanger may be partially frozen and therefore, be sure to get rid of its cause and then, re-operate the device. (The root cause of partial freezing: The lack of flow of heat-sourced water, suspension of water, lack of cooling medium, infiltration of foreign substance inside of panel heat exchanger)

Maintenance of plate type heat exchanger

As the scales are created in the panel heat exchanger, its efficiency may decrease or damage may occur due to winter-sowing due to the decrease in its flow.

Due to this reason, regular maintenance is necessary so that the scales shouldn't be created.

- 1 Before the season of use, check below points. (Once a year)
 - 1) Inspection on water quality to check if this is within the standard condition.
 - 2) Clean the strainer.
 - 3) Check if the flow is appropriate.
 - 4) Check if the operation environment is appropriate. (Pressure, flow, output temperature)
- 2 Below procedure should be abided by in order to clean the panel heat exchanger. (Once every 5 years)
 - 1) Check if the service port is equipped with the water pipe in order to clean the chemical solution. 5% diluted formic acid, citric acid, oxalic acid, acetate acid, phosphoric acid and etc. are appropriate for the chemical solution for wiping out the scales. (Hydrochloric acid, sulphuric acid, nitric acid and etc. shouldn't be used due to its corrosion.)

- 2) Be sure to check if the gate valve of inflow/outflow pipe and the valve for outflow pipe are properly closed when cleaning.
 - 3) Connect the water pipe for cleaning with the chemical solvent through the service plug of the pipe and fill up the panel heat exchanger with 50°C~60°C of cleaning solvent and circulate it with the pump for 2~5 hours. The circulation time may depend on the temperature of the cleaning solvent or the creation of the scales. Therefore, observe change in the color of the chemical solvent to set the circulation time for removing the scales.
 - 4) After the circulation of the solvent, extract the solvent inside of the panel heat exchanger and fill up 1~2% of NaOH or NaHCO₃ and then, circulate it for 15~20 minutes to neutralize the heat exchanger.
 - 5) Once the neutralization is completed, clean the inside of the panel heat exchanger with clean water. Measure the water Ph to check if the chemical solvent is properly removed or not.
 - 6) When using a different kind of chemical solvent in the market, be sure to check if there is any corrosive action to stainless or copper in advance or not.
 - 7) For details on the cleaning chemical solvent, be sure to consult the specialists of the related corporation.
- 3 After cleaning, operate the device to see if it works properly once again.

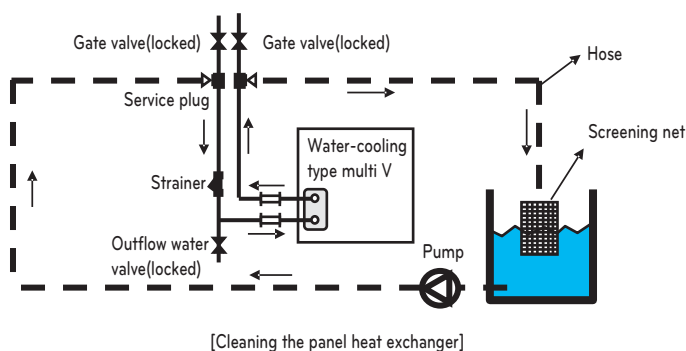

Maintenance/Repair checklist

Period (Year) \ Checkpoint	1	2	3	4	5	6	7	8	9	10	11	12	13	14	15
Product operating condition	●	●	●	●	●	●	●	●	●	●	●	●	●	●	●
Heat exchanger cleaning (Wash)					●					●					●
Strainer cleaning	●	●	●	●	●	●	●	●	●	●	●	●	●	●	●
Water quality check	●	●	●	●	●	●	●	●	●	●	●	●	●	●	●
Refrigerant leakage check	●														●
Indoor unit filter cleaning	●	●	●	●	●	●	●	●	●	●	●	●	●	●	●

CAUTION

- The above checklist is set based on the minimum period and more frequent checking can be required depending on the operating condition/water quality condition.
- When cleaning the heat exchanger, make sure to take parts out or lock the valve so that chemical detergent does not penetrate into the pressure gauge etc.
- When cleaning the heat exchanger, check the connecting part of the water pipes prior to cleaning so that the chemical detergent does not leak.
- After sufficiently mixing the chemical detergent with water, start cleaning.
- Cleaning the heat exchanger is easier at the initial stage and becomes difficult after the scaling has accumulated.
- In areas where the water quality is poor, cleaning is required periodically. Because chemical detergent has strong acidity, it must be washed off thoroughly with water.
- To check whether it is cleaned well inside, remove the hose and check the inside.
- Purge the air to remove any air inside the water pipe.
- After checking, always check whether the heat water supply is flowing normally before operating the product.

Daily check/management

1 Water quality control

The plate type heat exchanger is not structured to be disassembled, cleaned or replaced with parts. To prevent corrosion or scaling on the plate type heat exchanger, special care must be taken to control the water quality. Water quality must satisfy the minimum criteria of the reference water quality items. When anti-corrosion agent or corrosion inhibitor is added, the substance must not have any corrosive effect on stainless steel and copper. Even if the circulating water is not contaminated by the external air, it is recommended to empty the water flowing in the pipe and to resupply the water.

2 Flow rate control

If the flow rate is insufficient, it can cause freezing on the plate type heat exchanger. Check whether the strainer is clogged or whether the pipe is filled with air and then check the temperature and pressure difference of the inlet and outlet pipe to check whether the flow rate is insufficient. If the temperature and pressure difference is above the appropriate level, it means that the flow rate is reduced. In this case, the operation must immediately be stopped and re-operated when the root cause is resolved. (*If air is trapped in the pipe, the air must be purged. Air inside the water pipe interferes with the circulation of the heat water supply and can cause insufficient flow rate or freezing.)

3 Brine density management

When using the brine (Anti-freeze) in the heat water supply, designated type and density must be used. Calcium chloride brine can cause corrosion on the plate type heat exchanger and must not be used. If the anti-freeze liquid is left as is, it absorbs the moisture from the air to cause a drop in the density, leading to freezing of plate type heat exchanger. Therefore minimize the contact surface with the atmosphere and periodically measure the density of the brine to supplement the brine as needed to maintain the density.

Self-Diagnosis Function

Error Indicator

- This function indicates types of failure in self-diagnosis and occurrence of failure for air condition.
- Error mark is displayed on display window of indoor units and wired remote controller, and 7-segment LED of outside unit control board as shown in the table.
- If more than two troubles occur simultaneously, lower number of error code is first displayed.
- After error occurrence, if error is released, error LED is also released simultaneously.

Error Display

1st,2nd,3rd LED of 7-segment indicates error number, 4th LED indicates unit number. (* = 1: Master, 2: Slave 1, 3: Slave 2, 4: Slave 3)

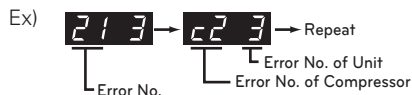

* Refer to the DX-Ventilation manual for DX-Ventilation error code.

Display			Title	Cause of Error	
Indoor unit related error	0	1	-	Air temperature sensor of indoor unit	Air temperature sensor of indoor unit is open or short
	0	2	-	Inlet pipe temperature sensor of indoor unit	Inlet pipe temperature sensor of indoor unit is open or short
	0	3	-	Communication error : wired remote controller ↔ indoor unit	Failing to receive wired remote controller signal in indoor unit PCB
	0	4	-	Drain pump	Malfunction of drain pump
	0	5	-	Communication error : outside unit ↔ indoor unit	Failing to receive outside unit signal in indoor unit PCB
	0	6	-	Outlet pipe temperature sensor of indoor unit	Outlet pipe temperature sensor of indoor unit is open or short
	0	9	-	Indoor EEPROM Error	In case when the serial number marked on EEPROM of Indoor unit is 0 or FFFFFFFF
	1	0	-	Poor fan motor operation	Disconnecting the fan motor connector/Failure of indoor fan motor lock
	1	7	-	Inlet Air temperature sensor of FAU	Air temperature sensor of indoor unit is open or short
	Outside unit related error	2	1	*	Master outside unit inverter compressor IGBT Fault
2		2	*	Inverter Board Input Over Current(RMS) of Master outside Unit	Master Outside Unit Inverter Board Input Current excess (RMS)
2		3	*	Master outside unit inverter compressor DC link under-voltage	DC voltage is not charged after master outside unit operating relay is turned on
2		4	*	Master outside unit high pressure switch	Compressor maintenance by master outside unit high pressure switch Flow rate insufficiency or flow switch trouble of master outside unit
2		5	*	Master outside unit input voltage over-voltage/under-voltage	Master outside unit input voltage over-voltage or under-voltage
2		6	*	Master outside unit inverter compressor operation failure error	Initial operation failure due to master outside unit inverter compressor error
2		8	*	Master outside unit inverter DC link over-voltage error	Compressor turned Off due to master outside unit inverter DC voltage over-charge
2		9	*	Master outside unit inverter compressor overcurrent	Master outside unit inverter compressor error or operating component (IGBT) error operation
3		2	*	Master outside unit inverter compressor discharge temperature over-rise	Compressor turned off due to master outside unit inverter compressor discharge temperature over-rise Flow rate insufficiency or flow switch trouble of master outside unit
3		4	*	Master outside unit high pressure over-rise	Compressor turned off due to master outside unit high pressure over-rise Flow rate insufficiency or flow switch trouble of master outside unit

Display			Title	Cause of Error	
Outside unit related error	3	5	*	Master outside unit low pressure over-drop.	Compressor turned off due to master outside unit low pressure overdrop.
	3	6	*	Master Outside Unit Low Compression Ratio Limited	Master Outside Unit stayed under low Compression limit for 3 minutes
	3	9	*	Master Outside unit Communication error between Master outside unit PFC and inverter board	Master Outside unit inverter compressor current detection (CT) sensor disconnection or short circuit
	4	0	*	Master outside unit inverter compressor CT sensor error	Master outside unit inverter compressor current detection (CT) sensor disconnection or short circuit
	4	1	*	Master outside unit inverter compressor discharge temperature sensor error	Master outside unit inverter compressor discharge temperature sensor disconnection or short circuit
	4	2	*	Master Outside Unit Low Pressure Sensor Fault	Master Outside Unit Low Pressure Sensor open or short
	4	3	*	Master Outside Unit High Pressure Sensor Fault	Master Outside Unit High Pressure Sensor open or short
	4	4	*	Master Outside unit air temperature sensor error	Master Outside unit air temperature sensor disconnection or short circuit
	4	6	*	Master outside unit suction temperature sensor error	Master outside unit suction temperature sensor disconnection or short circuit
	4	9	*	Master outside unit IGBT temperature sensor error	Master outside unit IGBT temperature sensor disconnection or short circuit
	5	0	*	Master outside unit 3 phase power missing	Master outside unit power line phase missing
	5	1	*	Over-capacity (Indoor unit capacity sum is excessive) connection	Excessive connection of indoor unit connection display value (Different from outside unit)
	5	2	*	Communication error: inverter PCB → Main PCB	When the inverter controller signal is not received from the master outside unit inverter controller
	5	3	*	Communication error: indoor unit → Main PCB of Outside Unit	When the indoor unit control signal is not received from the master Outside unit controller
	5	7	*	Communication error: Main PCB → inverter PCB	Failing to receive inverter controller signal at Master Outside Unit controller
	5	9	*	Wrong setting between master and slave outside unit	When geothermal mode setting is different(Fn 2 setting)
	6	0	*	Master outside unit inverter PCB EEPROM error	Master outside unit inverter PCB EEPROM ACCESS error
	6	2	*	Master outside unit inverter IGBT over-rise error	Master outside unit inverter IGBT when the temperature rises above 110 °C
	6	5	*	Master outside unit inverter IGBT temperature sensor error	Master outside unit inverter IGBT temperature sensor disconnection or short circuit
	7	1	*	PFC CT Sensor Error of Master Outside Unit	Master Outside Unit PFC CT Sensor open or short
8	6	*	Master outside unit master PCB EEPROM error	Communication error between master outside unit master MICOM and EEPROM or EEPROM missing	
8	8	*	PFC PCB EEPROM error	Communication error between master outside unit master PFC and EEPROM or EEPROM missing	

Display					Title	Cause of Error
Outside unit related error	1	0	4	*	Communication Error Between Master Outside Unit and Other Outside Unit	Failing to receive Slave Unit signal at main PCB of Master Outside Unit
	1	1	3	*	Master Outside Unit Liquid pipe Temperature Sensor Error	Liquid pipe temperature sensor of Master Outside Unit is open or short
	1	1	5	*	Master Outside Unit Subcooling Outlet Temperature Sensor Error	Master Outside Unit Subcooling Outlet Temperature Sensor open or short
	1	1	6	*	Master Outside Unit Oil Level Sensor Error	Oil Level Sensor of Master Outside Unit is open or short
	1	4	5	*	Master outside unit Main Board - External Board communication Error	Master outside unit Main Board - External Board communication Error
	1	5	1	*	Failure of operation mode conversion at Master Outside Unit	Failure of operation mode conversion at Master Outside Unit
	1	8	0	*	Plate type heat exchanger freeze prevention	Plate type heat exchanger freeze prevention error
	1	8	1	*	Water temperature sensor error	Water temperature sensor open/short
	1	8	2	*	Communication error between MICOMs of external pcb	Communication error between main MICOM and sub MICOM of external pcb

CAUTION FOR REFRIGERANT LEAK

The installer and system specialist shall secure safety against leakage according to local regulations or standards. The following standards may be applicable if local regulations are not available.

Introduction

Though the R410A refrigerant is harmless and incombustible itself, the room to equip the air conditioner should be large to such an extent that the refrigerant gas will not exceed the limiting concentration even if the refrigerant gas leaks in the room.

Limiting concentration

Limiting concentration is the limit of Freon gas concentration where immediate measures can be taken without hurting human body when refrigerant leaks in the air. The limiting concentration shall be described in the unit of kg/m³ (Freon gas weight per unit air volume) for facilitating calculation.

Limiting concentration: 0.44kg/m³(R410A)

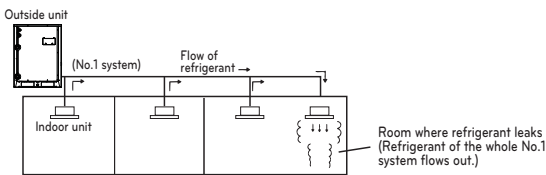

Checking procedure of limiting concentration

Check limiting concentration along following steps and take appropriate measure depending on the situation.

Calculate amount of all the replenished refrigerant (kg) per each refrigerant system.

$$\begin{array}{l}
 \text{Amount of replenished} \\
 \text{refrigerant per one outside} \\
 \text{unit system} \\
 \downarrow \\
 \text{Amount of replenished} \\
 \text{refrigerant at factory shipment}
 \end{array}
 +
 \begin{array}{l}
 \text{Amount of additional} \\
 \text{replenished refrigerant} \\
 \text{Amount of additionally} \\
 \text{replenished refrigerant} \\
 \text{depending on piping} \\
 \text{length or piping} \\
 \text{diameter at customer}
 \end{array}
 =
 \begin{array}{l}
 \text{Total amount of replenished} \\
 \text{refrigerant in refrigerant} \\
 \text{facility (kg)}
 \end{array}$$

Note : In case one refrigerant facility is divided into 2 or more refrigerant systems and each system is independent, amount of replenished refrigerant of each system shall be adopted.

Calculate minimum room capacity

Calculate room capacity by regarding a portion as one room or the smaller room.

- Without partition

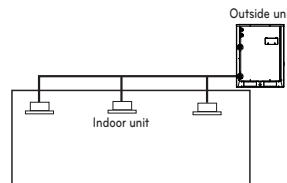

- With partition and with opening which serve as passage of air to adjoining room

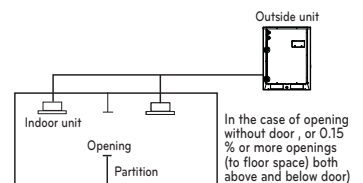

- With partition and without opening which serve as passage of air to adjoining room

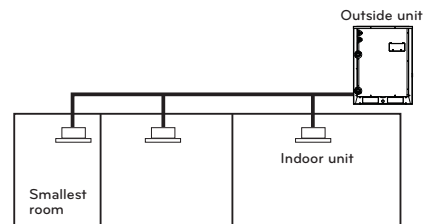

Calculate refrigerant concentration

$$\frac{\text{Total amount of replenished refrigerant in refrigerant facility (kg)}}{\text{Capacity of smallest room where indoor unit is installed (m}^3\text{)}} = \text{Refrigerant concentration (kg/m}^3\text{)} \quad \text{(R410A)}$$

- In case the result of calculation exceeds the limiting concentration, perform the same calculations by shifting to the second smallest, and the third smallest rooms until at last the result is below the limiting concentration.

In case the concentration exceeds the limit

When the concentration exceeds the limit, change original plan or take one of the countermeasures shown below:

- Countermeasure 1
Provide opening for ventilation.
Provide 0.15% or more opening to floor space both above and below door, or provide opening without door.
- Countermeasure 2
Provide gas leak alarm linked with mechanical ventilator.
Reducing the outside unit refrigerant qty.

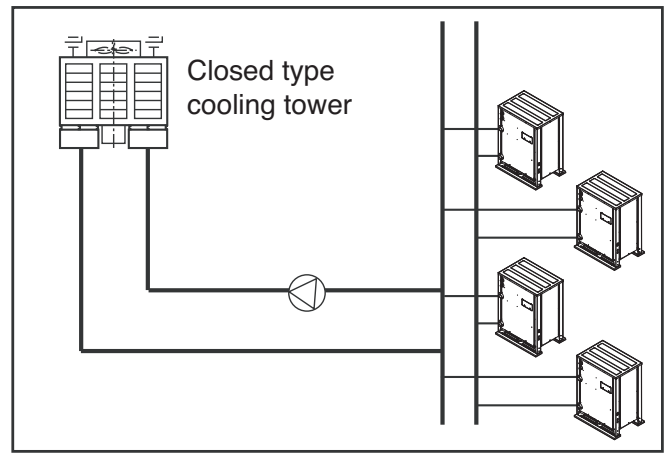
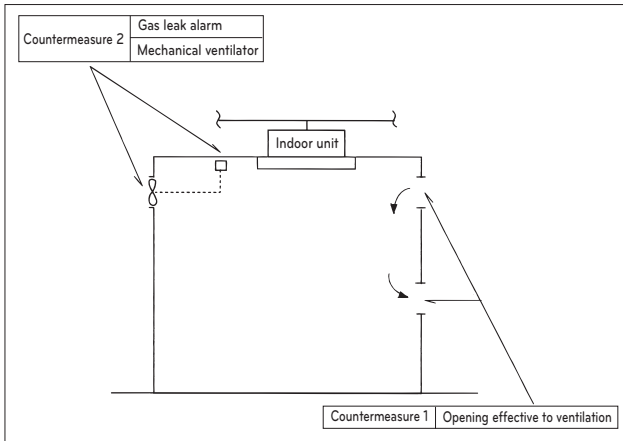

CAUTION

When the open type cooling tower is used and the water supply is directly connected to the 2nd heat exchanger, product damage by alien particle cannot be repaired for free.
- Always use the 2nd heat exchanger.

Pay a special attention to the place, such as a basement, etc. where refrigerant can stay, since refrigerant is heavier than air.

COOLING TOWER APPLIED METHOD

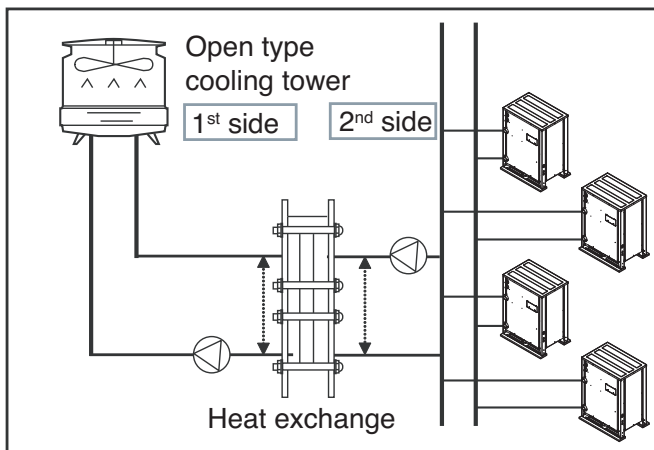

[Open type cooling tower + Middle heat exchanger]

Heat exchanger is installed between the cooling tower and outside unit system piping, and the temperature difference between 1st side and 2nd side is maintained constantly.

WATER SOLENOID VALVE CONTROL

Central Control(Use DDC Port)

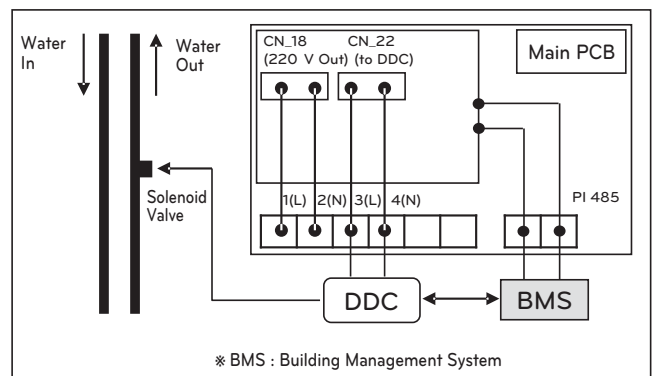

Individual Control(Use 220V Output Port)

