

## INSTALLATION MANUAL

# AIR CONDITIONER

Please read this installation manual completely before installing the product. Installation work must be performed in accordance with the national wiring standards by authorized personnel only. Please retain this installation manual for future reference after reading it thoroughly.

Ceiling Concealed Duct



MFL69190206  
Rev.02\_051719



[www.lg.com](http://www.lg.com)

Copyright © 2015 - 2019 LG Electronics Inc. All Rights Reserved.

ENGLISH

РУССКИЙ ЯЗЫК

УКРАЇНСЬКА

ҚАЗАҚ ТІЛІ

Генерация номера

ЎЗБЕК ТИЛИ

# TABLE OF CONTENTS

## 3 SAFETY PRECAUTIONS

---

## 6 INSTALLATION PARTS

---

## 7 INSTALLATION

---

- 7 Selection of the best location
- 8 Ceiling dimension and hanging bolt location
- 9 Wiring Connection
- 11 Part name and functions
- 12 Checking the Drainage
- 13 Drain Piping

## 15 REMOTE CONTROLLER INSTALLATION

---

- 16 Wired remote controller installation

## 17 OPTIONAL OPERATION

---

- 17 Installer Setting -Test Run Mode
- 18 Installer Setting - Setting Address of Central Control
- 19 Installer Setting -Thermistor
- 20 Installer Setting-Group Setting
- 21 Installer Setting-Dry Contact Mode Setting
- 22 Installer Setting -Optional Function Setting

## 23 HOW TO SET E.S.P?

---

- 23 Installer Setting -E.S.P.

## 25 SELF-DIAGNOSIS FUNCTION

---

## 25 DIP SWITCH SETTING

---

# Safety Precautions



To prevent the injury of the user or other people and property damage, the following instructions must be followed.

- Be sure to read before installing the air conditioner.
- Be sure to observe the cautions specified here as they include important items related to safety.
- Incorrect operation due to ignoring instruction will cause harm or damage. The seriousness is classified by the following indications.

**⚠ WARNING** This symbol indicates the possibility of death or serious injury.

**⚠ CAUTION** This symbol indicates the possibility of injury or damage to properties only.

- The meanings of the symbols used in this manual are as shown below.

	<b>Be sure not to do.</b>
	<b>Be sure to follow the instruction.</b>

## ⚠ WARNING

### Installation

- Always perform grounding.
  - Otherwise, it may cause electrical shock.
- Don't use a power cord, a plug or a loose socket which is damaged.
  - Otherwise, it may cause a fire or electrical shock.
- For installation of the product, always contact the service center or a professional installation agency.
  - Otherwise, it may cause a fire, electrical shock, explosion or injury.
- Securely attach the electrical part cover to the indoor unit and the service panel to the outdoor unit.
  - If the electrical part cover of the indoor unit and the service panel of the outdoor unit are not attached securely, it could result in a fire or electric shock due to dust, water, etc.
- Always install an air leakage breaker and a dedicated switching board.
  - No installation may cause a fire and electrical shock.
- Do not keep or use flammable gases or combustibles near the air conditioner.
  - Otherwise, it may cause a fire or the failure of product.
- Ensure that an installation frame of the outdoor unit is not damaged due to use for a long time.
  - It may cause injury or an accident.
- Do not disassemble or repair the product randomly.
  - It will cause a fire or electrical shock.
- Do not install the product at a place that there is concern of falling down.
  - Otherwise, it may result in personal injury.
- Use caution when unpacking and installing.
  - Sharp edges may cause injury.

## **Operation**

- Do not share the outlet with other appliances.
  - It will cause an electric shock or a fire due to heat generation.
- Do not use the damaged power cord.
  - Otherwise, it may cause a fire or electrical shock.
- Do not modify or extend the power cord randomly.
  - Otherwise, it may cause a fire or electrical shock.
- Take care so that the power cord may not be pulled during operation.
  - Otherwise, it may cause a fire or electrical shock.
- Unplug the unit if strange sounds, smell, or smoke comes from it.
  - Otherwise, it may cause electrical shock or a fire.
- Keep the flames away.
  - Otherwise, it may cause a fire.
- Take the power plug out if necessary, holding the head of the plug and do not touch it with wet hands.
  - Otherwise, it may cause a fire or electrical shock.
- Do not use the power cord near the heating tools.
  - Otherwise, it may cause a fire and electrical shock.
- Do not open the suction inlet of the indoor/outdoor unit during operation.
  - Otherwise, it may electrical shock and failure.
- Do not allow water to run into electrical parts.
  - Otherwise, it may cause the failure of machine or electrical shock.
- Hold the plug by the head when taking it out.
  - It may cause electric shock and damage.
- Never touch the metal parts of the unit when removing the filter.
  - They are sharp and may cause injury.
- Do not step on the indoor/outdoor unit and do not put anything on it.
  - It may cause an injury through dropping of the unit or falling down.
- Do not place a heavy object on the power cord.
  - Otherwise, it may cause a fire or electrical shock.
- When the product is submerged into water, always contact the service center.
  - Otherwise, it may cause a fire or electrical shock.
- Take care so that children may not step on the outdoor unit.
  - Otherwise, children may be seriously injured due to falling down.

**⚠ CAUTION****Installation**





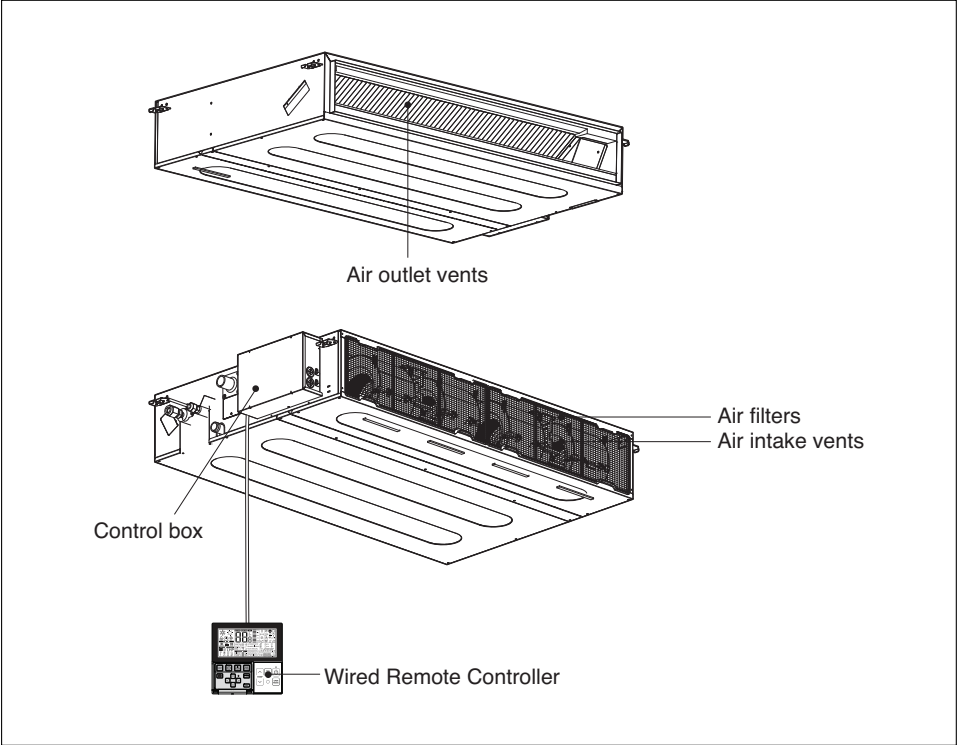

- Install the drain hose to ensure that drain can be securely done.
  - Otherwise, it may cause water leakage.
- Install the product so that the noise or hot wind from the outdoor unit may not cause any damage to the neighbors.
  - Otherwise, it may cause dispute with the neighbors.
- Always inspect gas leakage after the installation and repair of product.
  - Otherwise, it may cause the failure of product.
- Keep level parallel in installing the product.
  - Otherwise, it may cause vibration or water leakage.
- Means for disconnection must be incorporated in the fixed wiring in accordance with the wiring rules.

**Operation**

- Avoid excessive cooling and perform ventilation sometimes.
  - Otherwise, it may do harm to your health.
- Use a soft cloth to clean. Do not use wax, thinner, or a strong detergent.
  - The appearance of the air conditioner may deteriorate, change color, or develop surface flaws.
- Do not use an appliance for special purposes such as preserving animals vegetables, precision machine, or art articles.
  - Otherwise, it may damage your properties.
- Do not place obstacles around the flow inlet or outlet.
  - Otherwise, it may cause the failure of appliance or an accident.

# Installation Parts



Name	Drain hose	Clamp metal	Washer for hanging bracket	Clamp (Tie Wrap)	Insulation for fitting	Other
Quantity	1 EA	2 EA	8 EA	4 EA	1 set	
Shape					 for gas pipe  for liquid pipe	• Owner's manual • Installation manual

# Installation

## Selection of the best location

### Indoor unit

- The place shall easily bear a load exceeding four times the indoor unit's weight.
- The place shall be able to inspect the unit as the figure.
- The place where the unit shall be leveled.
- The place shall allow easy water drainage. (Suitable dimension "H" is necessary to get a slope to drain as figure.)
- The place shall easily connect with the outdoor unit.
- The place where the unit is not affected by an electrical noise.
- The place where air circulation in the room will be good.
- There should not be any heat source or steam near the unit.

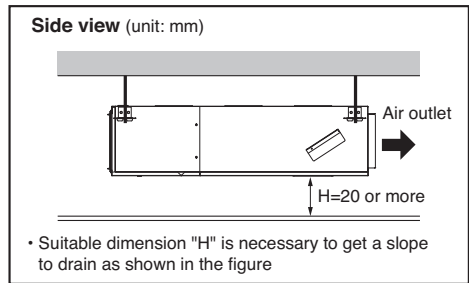
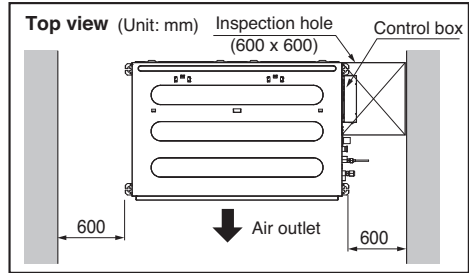

(Unit: mm)

Capacity (kBtu/h)	A	B
9	800	800
12/18	800	1 000
24	800	1 200

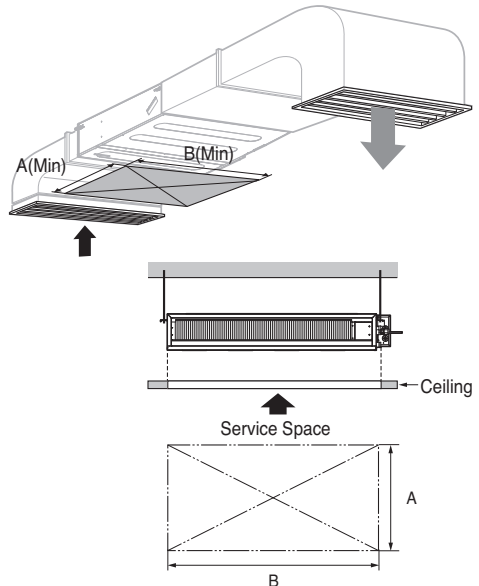

## Ceiling dimension and hanging bolt location

### Installation of Unit

Install the unit above the ceiling correctly.

#### POSITION OF SUSPENSION BOLT

- Apply a joint-canvas between the unit and duct to absorb unnecessary vibration.
- Apply a filter Accessory at air return hole.

(Unit: mm)

Dimension Capacity (kBTu/h)	A	B	C	D	E	F	G	H	I	J
9	733	772	628	700	36	190	20	660	155	700
12/18	933	972	628	700	36	190	20	860	155	900
24	1 133	1 172	628	700	36	190	20	1 060	155	1 100

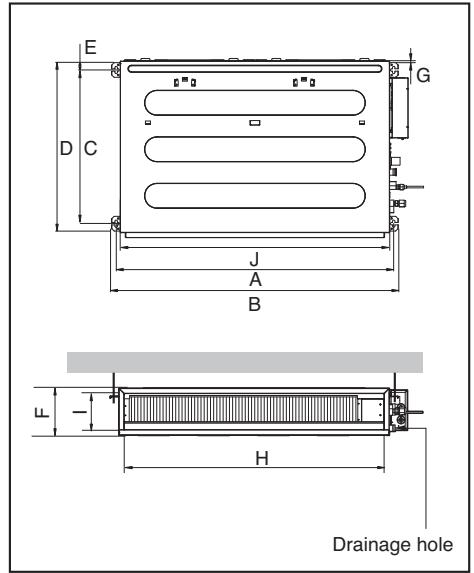

- \* Install the unit leaning to a drainage hole side as a figure for easy water drainage.

#### POSITION OF CONSOLE BOLT

- A place where the unit will be leveled and that can support the weight of the unit.
- A place where the unit can withstand its vibration.
- A place where service can be easily performed.

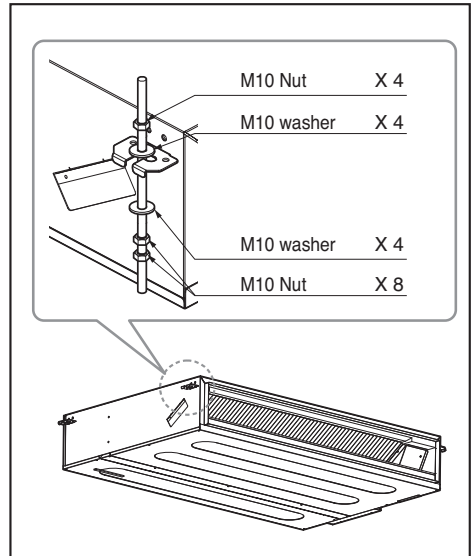

- Select and mark the position for fixing bolts.
- Drill the hole for set anchor on the face of ceiling.

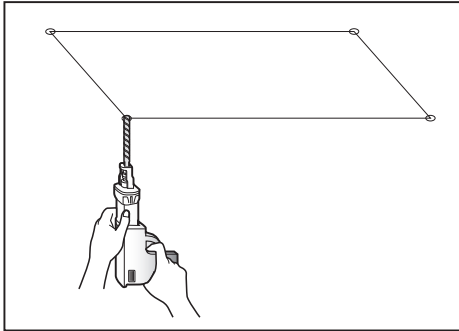

- Insert the set anchor and washer onto the suspension bolts for locking the suspension bolts on the ceiling.
- Mount the suspension bolts to the set anchor firmly.
- Secure the installation plates onto the suspension bolts (adjust level roughly) using nuts, washers and spring washers.

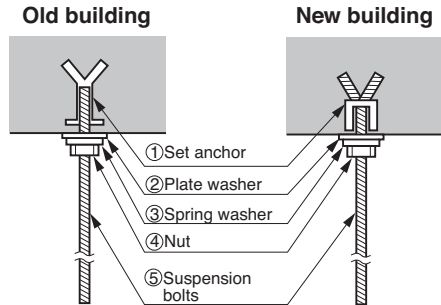

## ⚠ CAUTION

Tighten the nut and bolt to prevent unit falling.

## Wiring Connection

Connect the wires to the terminals on the control board individually according to the outdoor unit connection.

- Ensure that the color of the wires of outdoor unit and the terminal No. are the same as those of indoor unit respectively.

### L1/L2/L3 Series

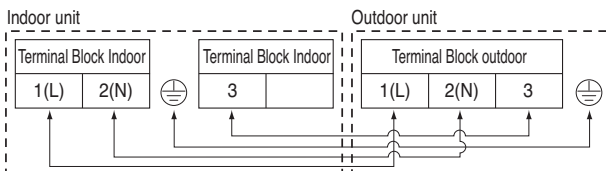

## ⚠ WARNING

Make sure that the screws of the terminal are free from looseness.

## ⚠ CAUTION

The Power cord connected to the unit should be selected according to the following specifications. (Cable type CV approved by IEC 60502-1)

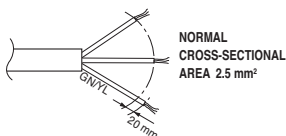

## **⚠ CAUTION**

After the confirmation of the above conditions, prepare the wiring as follows:

- 1) Never fail to have an individual power specialized for the air conditioner.  
As for the method of wiring, be guided by the circuit diagram posted on the inside of control box cover.**
- 2) Provide a circuit breaker switch between power source and the unit.**
- 3) The screws which fasten the wiring in the casing of electrical fittings are liable to come loose from vibrations to which the unit is subjected during the course of transportation. Check them and make sure that they are all tightly fastened. (If they are loose, it could give rise to burn-out of the wires.)**
- 4) Specification of power source**
- 5) Confirm that electrical capacity is sufficient.**
- 6) Be sure that the starting voltage is maintained at more than 90 percent of the rated voltage marked on the name plate.**
- 7) Confirm that the cable thickness is as specified in the power sources specification. (Particularly note the relation between cable length and thickness.)**
- 8) Never fail to equip a leakage breaker where it is wet or moist.**
- 9) The following troubles would be caused by voltage drop-down.**
  - Vibration of a magnetic switch, damage on the contact point, fuse breaking, disturbance by the normal function of an overload protection device.
  - Proper starting power is not given to the compressor.

## Part name and functions

- Low static duct type in case of suction from back side.

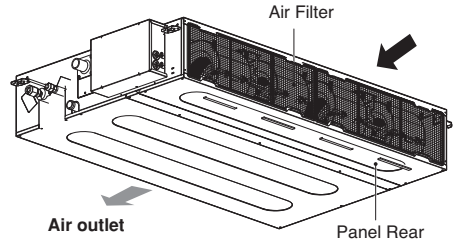

- Low static duct type in case of suction from bottom side.

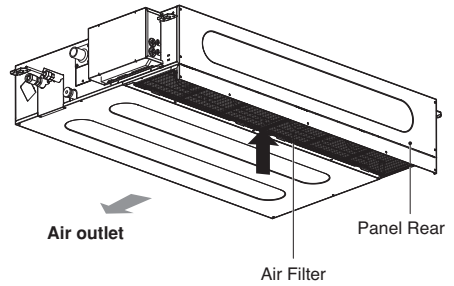

- In case of suction from bottom size, bend the Panel rear and screw with cabinet case

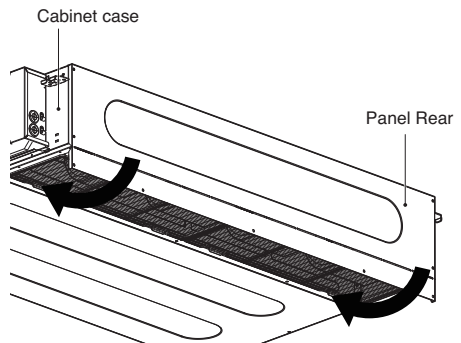

## INSULATION, OTHERS

Insulate the joint and tubes completely.

### THERMAL INSULATION

All thermal insulation must comply with local requirement.

### INDOOR UNIT

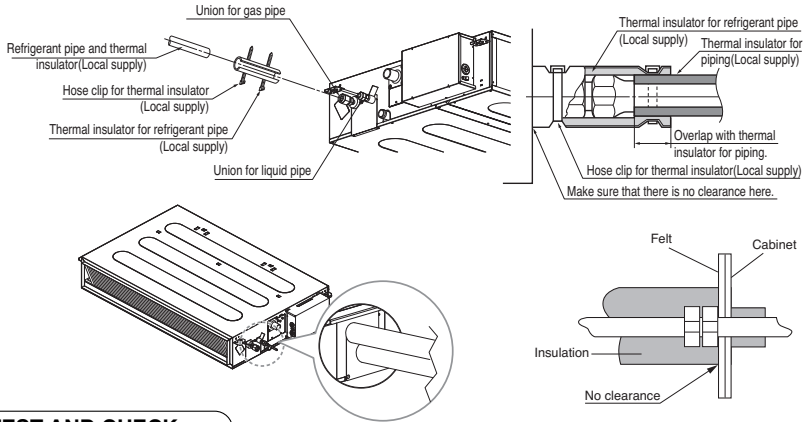

### TEST AND CHECK

■ **After all workings are finished, check the working and operation.**

- Air distribution ..... Is the air circulation good?
- Drain ..... Is the drainage smoothly and no sweating?
- Gas leakage ..... Is the piping connection correctly?
- Wiring ..... Is the wiring connection correctly?
- Lock-bolt ..... Is the lock-bolt of compressor loosened?
- Insulation ..... Is the unit fully insulated?
- Ground ..... Is the unit safely grounded?

## Checking the Drainage

### 1. Remove the Air Filter.

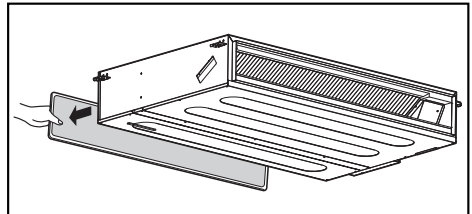

### 2. Check the drainage.

- Spray one or two glasses of water upon the evaporator.
- Ensure that water flows drain hose of indoor unit without any leakage.

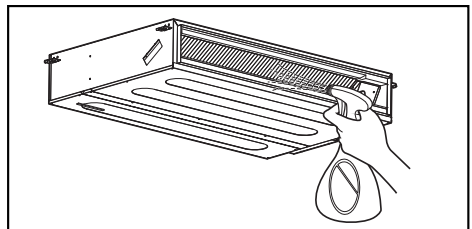

## ⚠ CAUTION

1. **Install declination** of the indoor unit is very **important for the drain** of the duct type air conditioner.
2. Minimum thickness of the insulation for the connecting pipe shall be 19 mm.

### Front of view

- The unit must be horizontal or declined to the drain hose connected when finished installation.

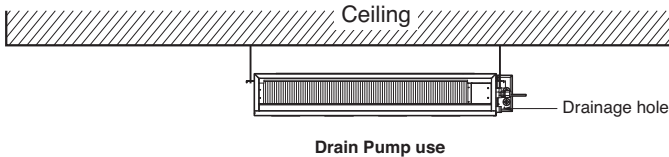

## Drain Piping

- Drain piping must have down-slope (1/50 to 1/100): be sure not to provide up-and-down slope to prevent reversal flow.
- During drain piping connection, be careful not to exert extra force on the drain port on the indoor unit.
- The outside diameter of the drain connection on the indoor unit is 32 mm.

Piping material: Polyvinyl chloride pipe VP-25 and pipe fittings

- Be sure to install heat insulation on the drain piping.

Heat insulation material: Polyethylene foam with thickness more than 8 mm.

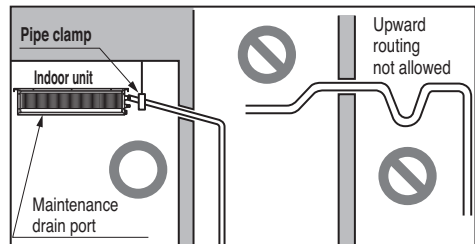

## Drain test

The air conditioner uses a drain pump to drain water. Use the following procedure to test the drain pump operation:

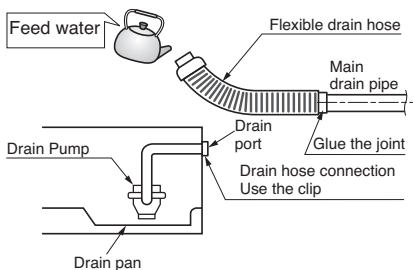

- Connect the main drain pipe to the exterior and leave it provisionally until the test comes to an end.
- Feed water to the flexible drain hose and check the piping for leakage.
- Be sure to check the drain pump for normal operating and noise when electrical wiring is complete.
- When the test is complete, connect the flexible drain hose to the drain port on the indoor unit.

## **⚠ CAUTION**

The supplied flexible drain hose should not be curved, neither screwed. The curved or screwed hose may cause a leakage of water.

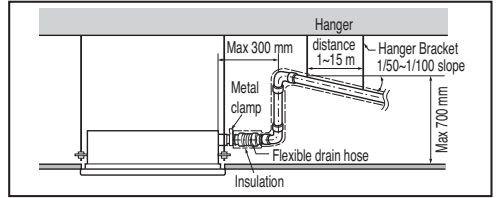

## **HAND OVER**

Teach the customer the operation and maintenance procedures, using the operation manual. (air filter cleaning, temperature control, etc.)

# Remote Controller Installation

## 1. Please fix tightly using provided screw after placing remote controller setup board on the place where you like to setup.

- Please set it up not to bend because poor setup could take place if setup board bends.  
Please set up remote controller board fit to the reclamation box if there is a reclamation box.
- Install the product so as not to make a gap with the wall side and to prevent shaking after the installation.

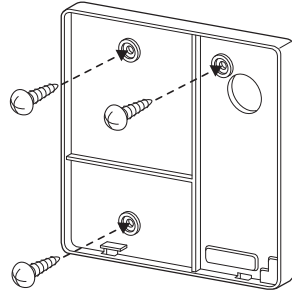

## 2. Can set up Wired remote controller cable into three directions.

- Setup direction: the surface of wall reclamation, upper, right
- If setting up remote controller cable into upper and right side, please set up after removing remote controller cable guide groove.

\* Remove guide groove with long nose.

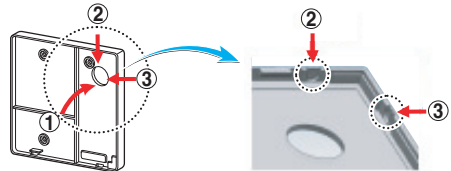

<Wire guide grooves>

- ① Reclamation to the surface of the wall
- ② Upper part guide groove
- ③ Right part guide groove

## 3. Please fix remote controller upper part into the setup board attached to the surface of the wall, as the picture below, and then, connect with setup board by pressing lower part.

- Please connect not to make a gap at the remote controller and setup board's upper and lower, right and left part.
- Before assembly with the installation board, arrange the Cable not to interfere with circuit parts.

<Connecting order>

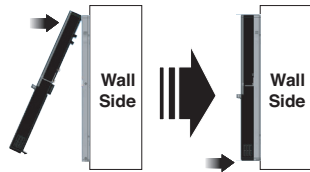

## When separating remote controller from setup board, as the picture below, after inserting into the lower separating hole using screw driver and then, spinning clockwise, remote controller is separated.

- There are two separating holes. Please individually separate one at a time.
- Please be careful not to damage the inside components when separating.

<Separating order>

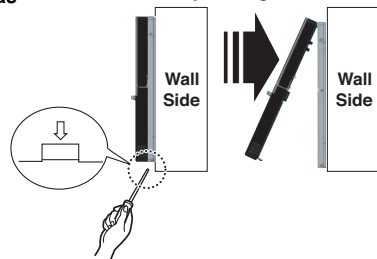

**4. Please connect indoor unit and remote controller using connection cable.**

12 V	Red
Signal	Yellow
GND	Black

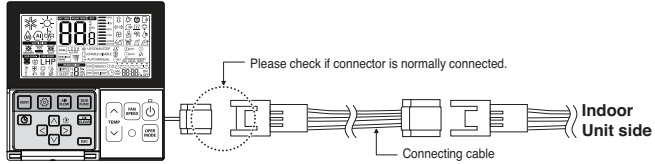

**5. Please use extension cable if the distance between wired remote controller and indoor unit is more than 10 m.**

**⚠ CAUTION**

**When installing the wired remote controller, do not bury it in the wall. (It can cause damage in the temperature sensor.)**

**Do not install the cable to be 50 m or above. (It can cause communication error.)**

- When installing the extension cable, check the connecting direction of the connector of the remote controller side and the product side for correct installation.
- If you install the extension cable in the opposite direction, the connector will not be connected.
- Specification of extension cable: 2547 1007 22# 2 core 3 shield 5 or above.

**Wired remote controller installation**

• Since the room temperature sensor is in the remote controller, the remote controller box should be installed in a place away from direct sunlight, high humidity and direct supply of cold air to maintain proper space temperature. Install the remote controller about 5 ft(1.5 m) above the floor in an area with good air circulation at an average temperature.

**Do not install the remote controller where it can be affected by:**

- Drafts, or dead spots behind doors and in corners.
- Hot or cold air from ducts.
- Radiant heat from sun or appliances.
- Concealed pipes and chimneys.
- Uncontrolled areas such as an outside wall behind the remote controller.
- This remote controller is equipped with a seven segment LED. display. For proper display of the remote controller LED's, the remote controller should be installed properly as shown in Fig.1. (The standard height is 1.2~1.5 m from floor level.)

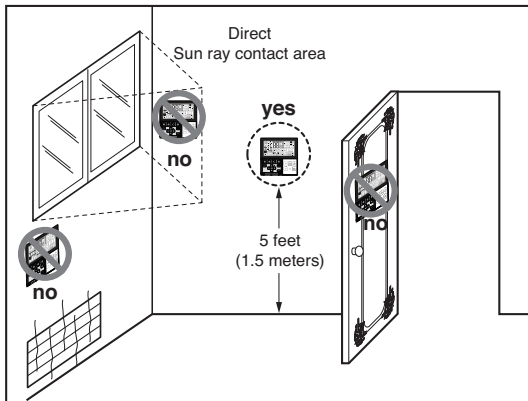

**Fig.1 Typical locations for remote controller**

# Optional Operation

## Installer Setting - Test Run Mode

After installing the product, you must run a Test Run mode.

For details related to this operation, refer to the product manual.

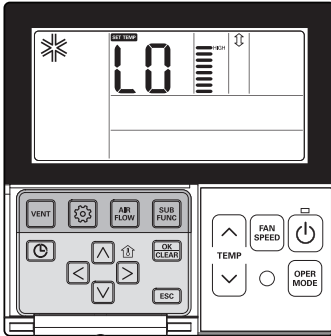

**1** If pressing  button long for 3 seconds, it enters into remote controller setter setup mode.

- If pressing once shortly, it enters into user setup mode. Please press more than 3 seconds for sure.
- Please cancel the right and left of wind direction for RAC product.

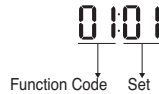

**2** Setup figure '01' blinks at the lower part of indication window.

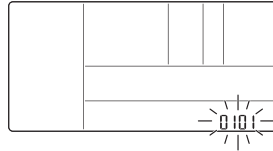

**3** Press  button to start.

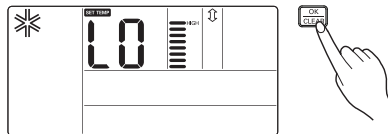



**4** During the test run, pressing the below button will exit the test run.

- Select operation, temperature up/down, wind flow control, wind direction, start/stop button.

## Installer Setting - Setting Address of Central Control

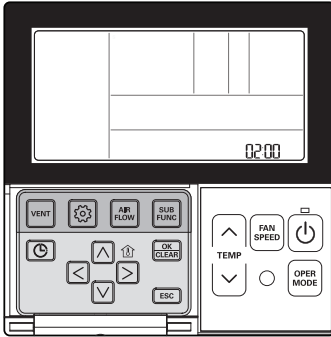
It's the function to use for connecting central control.  
Please refer to central controller manual for the details





**1** If pressing  button long for 3 seconds, it enters into remote controller setter setup mode.  
- If pressing once shortly, it enters into user setup mode. Please press more than 3 seconds for sure.



**2** If entering into address setup mode by using  button, it indicates as picture below.



**3** Set Group No. by pressing   button. (0~F)

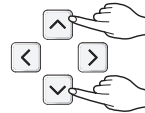

02:F0

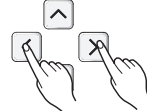

**4** Move to Indoor No. setting option by pressing   button.

02:F0



**5** Set Indoor No. by pressing   button.

02:F5

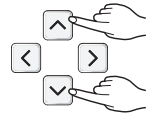

**6** Press  button to save.

02:F5



**7** Pressing  button will exit settings mode.

※ After setup, it automatically gets out of setup mode if there is no button input for 25 seconds.



※ When exiting without pressing set button, the manipulated value is not reflected.

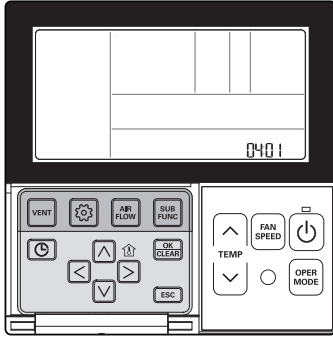

## Installer Setting - Thermistor

This is the function to select the temperature sensor to judge the room temperature.



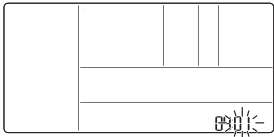

- 1** If pressing  button long for 3 seconds, it enters into remote controller setter setup mode.  
- If pressing once shortly, it enters into user setup mode. Please press more than 3 seconds for sure.



- 2** If moving to room temperature perception sensor selection menu by pressing  button, it indicates as picture below.

- 3** Set Thermistor value by pressing   button. (01: Remote Controller, 02: Indoor, 03: 2TH)

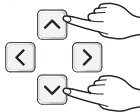

Function Code      Thermistor setting

- 4** Press  button to save.

- 5** Pressing  button will exit settings mode.  
\* After setup, it automatically gets out of setup mode if there is no button input for 25 seconds.  
\* When exiting without pressing set button, the manipulated value is not reflected.

### <Thermistor Table>

Temperature sensor selection		Function
01	Remote controller	Operation in remote controller temperature sensor
02	Indoor unit	Operation in indoor unit temperature sensor
03	2TH	Cooling Operation of higher temperature by comparing indoor unit's and wired remote controller's temperature. (There are products that operate at a lower temperature.)
		Heating Operation of lower temperature by comparing indoor unit's and wired remote controller's temperature.

\* The function of 2TH has different operation characteristics according to the product.

## Installer Setting-Group Setting

It is a function for settings in group control, or 2-remote controller control.

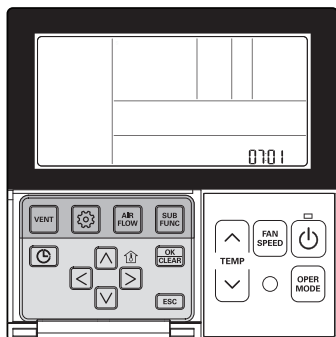

- 1** If pressing button long for 3 seconds, it enters into remote controller setter setup mode.  
- If pressing once shortly, it enters into user setup mode. Please press more than 3 seconds for sure.

- 2** If pressing button repeatedly, it moves to master/slave selection menu as picture below.

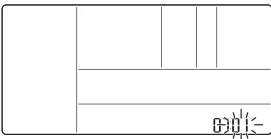
- 3** Select Master/ Slave by pressing button.  
(00: Slave, 01: Master)

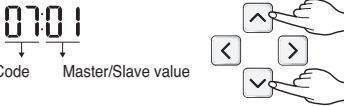
- 4** Press button to save.

- 5** Pressing button will exit settings mode.  
\* After setup, it automatically gets out of setup mode if there is no button input for 25 seconds.  
\* When exiting without pressing set button, the manipulated value is not reflected.

Remote controller	Function
Master	Indoor unit operates based on master remote controller at group control. (Master is set when delivering from the warehouse.)
Slave	Setup all remote controllers except one master remote controller to slave at group control

\* Refer to the 'group control' part for details

• When controlling in groups, basic operation settings, airflow strength weak/medium/strong, lock setting of the remote controller, time settings, and other functions may be restricted.

## Installer Setting-Dry Contact Mode Setting

Dry contact function is the function that is possible to use only when dry contact equipment is separately purchased/setup.

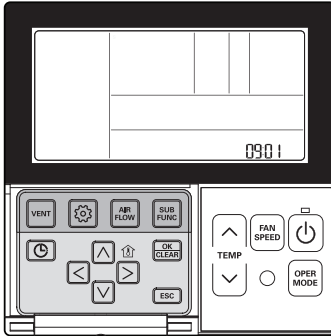

**1** If pressing  button long for 3 seconds, it enters into remote controller setter setup mode.  
- If pressing once shortly, it enters into user setup mode. Please press more than 3 seconds for sure.



**2** If pressing  button repeatedly, it moves to remote controller dry contact mode setup menu as picture below.



**3** Select Dry contact setting by pressing button.  
(00 : Automatic, 01 : manual)

0901  
↓      ↓  
Function Code    Dry Contact setting value

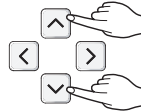

**4** Press  button to save.

0901



**5** Pressing  button will exit settings mode.  
\* After setup, it automatically gets out of setup mode if there is no button input for 25 seconds.  
\* When exiting without pressing set button, the manipulated value is not reflected.

### ► What is Dry Contact?

Like hotel card key and body perception sensor, it is the signal of the point of contact when using air-conditioner by interlocking.

• Please refer to dry contact manual for more details.

## Installer Setting -Optional Function Setting

Setting feature for indoor unit when air cleaning / heater / humidifier / Up/down grill / Ventilation KIT /Auxiliary Heater is newly installed, or installed unit is removed.

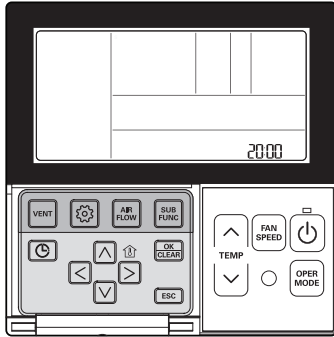



- 1** If pressing  button long for 3 seconds, it enters into remote controller setter setup mode.  
- If pressing once shortly, it enters into user setup mode. Please press more than 3 seconds for sure.

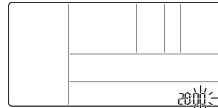

- 2** If pressing  button repeatedly, it moves to the selected option function code as picture below.



Function	Code
Plasma purification	20
Electric heater	21
Dehumidifier	22
Elevation grill	23
Ventilation kit	24
Auxiliary heater	25

- 3** Select existing condition of each mode by pressing   button.  
(00: not installed,  
01 : installed)

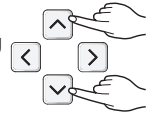

2001

Function Code      Existing condition

- 4** Press  button to save.



- 5** Pressing  button will exit settings mode.  
\* After setup, it automatically gets out of setup mode if there is no button input for 25 seconds.  
\* When exiting without pressing set button, the manipulated value is not reflected.

# How to Set E.S.P.?

## Installer Setting -E.S.P.

This is the function that decides the strength of the wind for each wind level and because this function is to make the installation easier.

- If you set ESP incorrectly, the air conditioner may malfunction.
- This setting must be carried out by a certificated-technician.

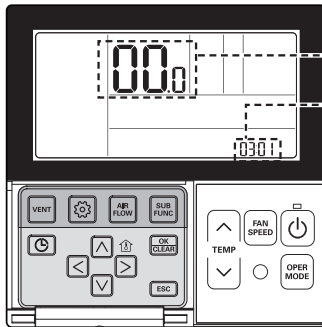

- If pressing button long for 3 seconds, it enters into remote controller setter setup mode.  
- If pressing once shortly, it enters into user setup mode. Please press more than 3 seconds for sure.
- If entering into ESP setup mode by using button, it indicates as the picture below.
- Select ESP fan step by pressing button.  
(01: very low, 02: low, 03: medium, 04: high, 05: very high)
- Move to ESP value setting by pressing button.  
(It is 000 when delivering from the warehouse.)
- Press button to setup ESP value.  
(It is possible to setup ESP value from 1 to 255, and 1 is the smallest and 255 is the biggest.)
- Select ESP fan step again by using button and setup ESP value, as No. 4 and 5, that corresponds each wind flow
- Press button to save.
- Press button to exit.  
\* After setup, it automatically gets out of setup mode if there is no button input for 25 seconds.  
\* When exiting without pressing set button, the manipulated value is not reflected.

- When setting ESP value on the product without very weak wind or power wind function, it may not work.
- Please be careful not to change the ESP value for each fan step.
- It does not work to setup ESP value for very low/power step for some products.
- ESP value is available for specific range belongs to the product.

**ABNH09GL1A2**

(Unit : CMM)

Setting Value	Static Pressure(mmAq(Pa))					
	0 (0)	1 (10)	2 (20)	3 (30)	4 (40)	5 (50)
60	-	-	-	-	-	-
65	5.03	-	-	-	-	-
70	5.60	4.85	-	-	-	-
75	6.19	5.44	4.57	-	-	-
80	6.79	6.05	5.17	-	-	-
85	7.41	6.67	5.80	4.80	-	-
90	8.05	7.31	6.43	5.44	-	-
95	8.71	7.96	7.09	6.09	4.97	-
100	9.38	8.63	7.76	6.76	5.64	-
105	10.07	9.32	8.45	7.45	6.33	5.08
110	-	10.03	9.16	8.16	7.04	5.79
115	-	-	9.88	8.88	7.76	6.51
120	-	-	-	9.62	8.50	7.25
125	-	-	-	10.38	9.26	8.01
130	-	-	-	-	10.03	8.78

**ABNH12GL2A2, ABNH18GL2A2**

(Unit : CMM)

Setting Value	Static Pressure(mmAq(Pa))					
	0 (0)	1 (10)	2 (20)	3 (30)	4 (40)	5 (50)
75	6.50	-	-	-	-	-
80	7.34	6.70	-	-	-	-
85	8.20	7.55	6.69	-	-	-
90	9.07	8.43	7.56	6.47	-	-
95	9.96	9.32	8.45	7.36	-	-
100	10.87	10.22	9.36	8.27	6.96	-
105	11.79	11.15	10.28	9.19	7.89	6.35
110	12.73	12.09	11.22	10.14	8.83	7.30
115	13.69	13.05	12.18	11.09	9.78	8.25
120	14.67	14.02	13.16	12.07	10.76	9.23
125	15.66	15.01	14.15	13.06	11.75	10.22
130	16.67	16.02	15.16	14.07	12.76	11.23
135	-	-	16.18	15.10	13.79	12.26
140	-	-	-	16.14	14.83	13.30
145	-	-	-	-	15.89	14.36

**ABNH24GL3A2**

(Unit : CMM)

Setting Value	Static Pressure(mmAq(Pa))					
	0 (0)	1 (10)	2 (20)	3 (30)	4 (40)	5 (50)
85	10.19	-	-	-	-	-
90	12.18	10.71	11.09	-	-	-
95	13.81	12.34	12.19	-	-	-
100	15.16	13.69	13.38	10.71	-	-
105	16.30	14.83	14.36	11.85	-	-
110	17.31	15.85	15.23	12.86	10.97	-
115	18.27	16.80	16.07	13.82	11.93	-
120	19.26	17.79	16.93	14.80	12.91	10.49
125	20.34	18.87	17.89	15.88	13.99	11.57
130	21.60	20.13	19.01	17.14	15.25	12.83
135	-	21.64	20.36	18.66	16.76	14.35
140	-	-	22.01	20.50	18.61	16.19
145	-	-	-	22.75	20.86	18.44

**Note :**

1. The above table shows the correlation between the air rates and E.S.P.

# Self-diagnosis Function

## Indoor Unit Error

Ex) Error 03 (Remote controller error)

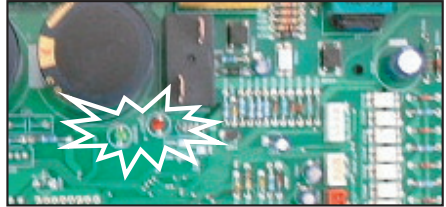
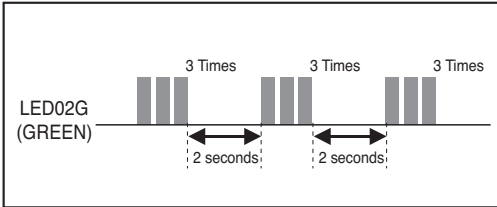

Error Code	Description	LED 1 (Red)	LED 2 (Green)	Indoor status
01	Indoor Room sensor error	0	1 time ●	OFF
02	Indoor in-pipe sensor error	0	2 times ●●	OFF
03	Remote controller error	0	3 times ●●●	OFF
04	Drain pump error	0	4 times ●●●●	OFF
05	Communication error indoor and outdoor	0	5 times ●●●●●	OFF
06	Indoor out-pipe sensor error	0	6 times ●●●●●●	OFF
09	EEPROM error (indoor)	0	9 times ●●●●●●●●●	OFF
10	BLDC motor fan lock (indoor)	1 time ●	0	OFF

※ Because remote controller turn off when occur ERROR in simultaneous operation system, it should check LED blinks of outdoor in order to confirm error code.

※ Repeatedly after LED1 is turned on and off as the Error code number of tens digit, LED2 is turned on and off as the Error code number of single-digit.

## DIP Switch Setting

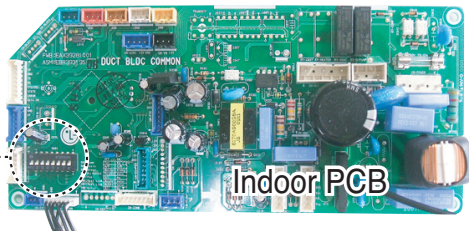
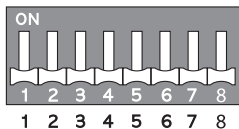

Function	Description	Setting Off	Setting On	Default	
SW3	Group Control	Selection of Master or Slave	Master	Slave	Off
SW4	Dry Contact Mode	Selection of Dry Contact Mode	Wired/Wireless remote controller Selection of Manual or Auto operation Mode	Auto	Off
SW5	Installation	Fan continuous operation	Continuous operation Removal	Working	Off



