



website <http://www.lgservice.com>
e-mail <http://www.lgservice.com/techsup.html>

LG

ENGLISH

ITALIANO

ESPAÑOL

FRANÇAIS

DEUTSCH

MULTI V™ System Heat Pump Indoor Unit

INSTALLATION MANUAL

MODELS: SE/S5 Series
Type: Wall Mounted

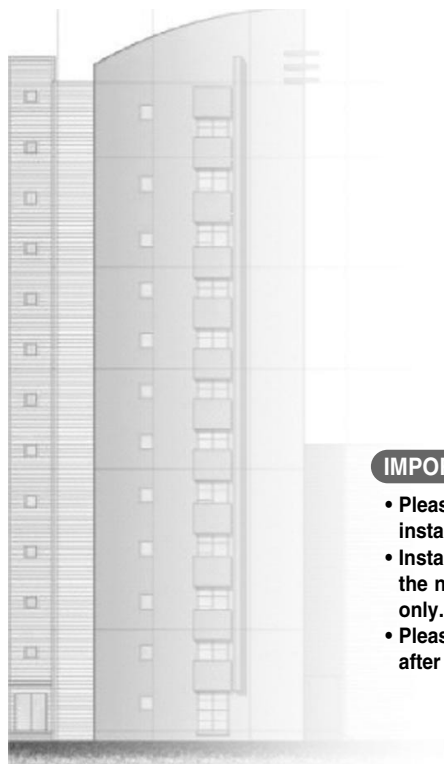

IMPORTANT



- Please read this installation manual completely before installing the product.
- Installation work must be performed in accordance with the national wiring standards by authorized personnel only.
- Please retain this installation manual for future reference after reading it thoroughly.

TABLE OF CONTENTS

Installation Requirements	Required Parts	Required Tools
Installation Parts3		
Safety Precautions4		
Installation	<input type="checkbox"/> Installation guide map	<input type="checkbox"/> Level gauge
Selection the best location7	<input type="checkbox"/> Four type "A" screws & plastic anchors	<input type="checkbox"/> Screw driver
Piping Method.....8	<input type="checkbox"/> Connecting cable	<input type="checkbox"/> Electric drill
	<input type="checkbox"/> Pipes: Gas side	<input type="checkbox"/> Hole core drill
	Liquid side	<input type="checkbox"/> Horizontal meter
	(Refer to Product Data)	<input type="checkbox"/> Flaring tool set
	<input type="checkbox"/> Insulation materials	<input type="checkbox"/> Specified torque wrenches (different depending on model No.)
	<input type="checkbox"/> Additional drain pipe	<input type="checkbox"/> SpannerHalf union
Drain Piping13		<input type="checkbox"/> A glass of water
Wiring Connection13		<input type="checkbox"/> Screw driver
Installation of Remote Controller.....15		<input type="checkbox"/> Hexagonal wrench
		<input type="checkbox"/> Gas-leak detector
		<input type="checkbox"/> Vacuum pump
		<input type="checkbox"/> Gauge manifold
	<input type="checkbox"/> Two type "B" screws	<input type="checkbox"/> Owner's manual
		<input type="checkbox"/> Thermometer
		<input type="checkbox"/> Holder Remote Controller

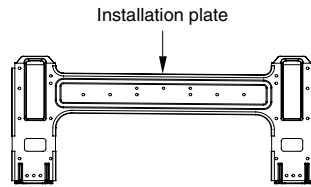
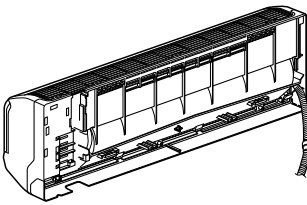
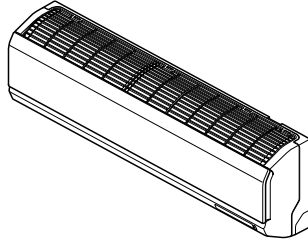
Installation Parts

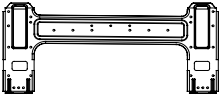

Installation plate	Type "A" screw and plastic anchor	Type "B" screw
		

Safety Precautions

To prevent injury to the user or other people and property damage, the following instructions must be followed.

- Be sure to read before installing the air conditioner.
- Be sure to observe the cautions specified here as they include important items related to safety.
- Incorrect operation due to ignoring instruction will cause harm or damage. The seriousness is classified by the following indications.

⚠ WARNING This symbol indicates the possibility of death or serious injury.

⚠ CAUTION This symbol indicates the possibility of injury or damage to properties only.

- Meanings of symbols used in this manual are as shown below.

	Be sure not to do.
	Be sure to follow the instruction.

⚠ WARNING

■ Installation

Do not use a defective or under-rated circuit breaker. Use this appliance on a dedicated circuit.

- There is risk of fire or electric shock.

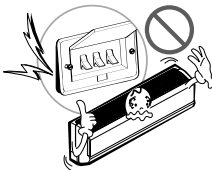

Install the panel and the cover of control box securely.

- There is risk of fire or electric shock.



For electrical work, contact the dealer, seller, a qualified electrician, or an Authorized Service Center.

- Do not disassemble or repair the product. There is risk of fire or electric shock.



Always install a dedicated circuit and breaker.

- Improper wiring or installation may cause fire or electric shock



Always ground the product.

- There is risk of fire or electric shock.

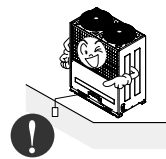

Use the correctly rated breaker or fuse.

- There is risk of fire or electric shock.

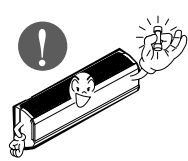

Do not modify or extend the power cable.

- There is risk of fire or electric shock.

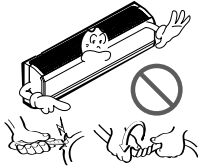

Do not let the air conditioner run for a long time when the humidity is very high and a door or a window is left open.

- Moisture may condense and wet or damage furniture.



Be cautious when unpacking and installing the product.

- Sharp edges could cause injury. Be especially careful of the case edges and the fins on the condenser and evaporator.



For installation, always contact the dealer or an Authorized Service Center.

- There is risk of fire, electric shock, explosion, or injury.

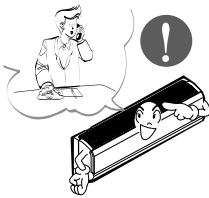

Do not install the product on a defective installation stand.

- It may cause injury, accident, or damage to the product.



Be sure the installation area does not deteriorate with age.

- If the base collapses, the air conditioner could fall with it, causing property damage, product failure, and personal injury.

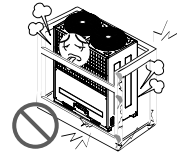

■ Operation

Do not store or use flammable gas or combustibles near the product.

- There is risk of fire or failure of product.



CAUTION

Installation

Always check for gas (refrigerant) leakage after installation or repair of product.

- Low refrigerant levels may cause failure of product.



Install the drain hose to ensure that water is drained away properly.

- A bad connection may cause water leakage.

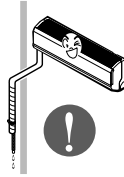

Keep level even when installing the product.

- To avoid vibration or water leakage.

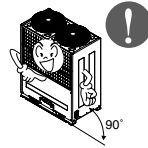

Do not install the product where the noise or hot air from the outdoor unit could damage the neighborhoods.

- It may cause a problem for your neighbors.



Use two or more people to lift and transport the product.

- Avoid personal injury.



Do not install the product where it will be exposed to sea wind (salt spray) directly.

- It may cause corrosion on the product. Corrosion, particularly on the condenser and evaporator fins, could cause product malfunction or inefficient operation.

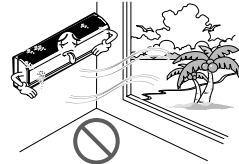

Installation

Read completely, then follow step by step.

Selection of the best location

- There should not be any heat source or steam near the unit.
- There should not be any obstacles to prevent the air circulation.
- A place where air circulation in the room will be good.
- A place where drainage can be easily obtained.
- A place where noise prevention is taken into consideration.
- Do not install the unit near the door way.
- Ensure the spaces indicated by arrows from the wall, ceiling, fence, or other obstacles.

The mounting wall should be strong and solid enough to protect it from the vibration.

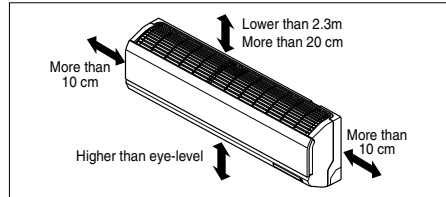
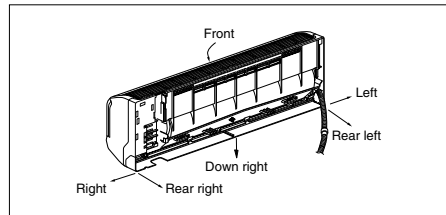

Fixing Installation Plate

The wall you select should be strong and solid enough to prevent vibration

1. Mount the installation plate on the wall with type "A" screws. If mounting the unit on a concrete wall, use anchor bolts.
- Mount the installation plate horizontally by aligning the centerline using a level.

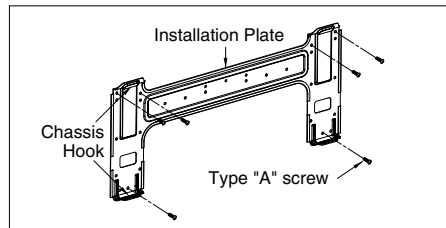

2. Measure the wall and mark the centerline. It is also important to use caution concerning the location of the installation plate-routing of the wiring to power outlets is through the walls typically. Drilling the hole through the wall for piping connections must be done safely.

Type 1.

CHASSIS (Grade)	Distance (mm)			
	A	B	C	D
S4	73	55	82	55
S5	121	62	258	62

Type 2.

CHASSIS (Grade)	Distance (mm)			
	A	B	C	D
S4	50	105	59	105
SE	65	110	85	110
S5	95	122	235	122

Type 1.

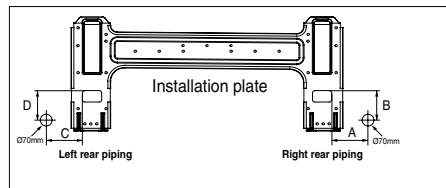

Type 2.

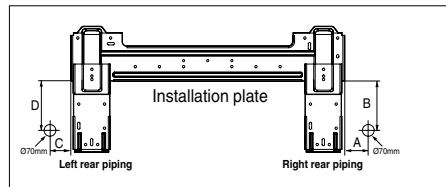

Piping Method

- Preparing the indoor unit's piping and drain hose for installation through the wall.
- Remove the plastic tubing retainer(see illustration below) and pull the tubing and drain hose away from chassis.
- Replace the plastic tubing holder in the original position.

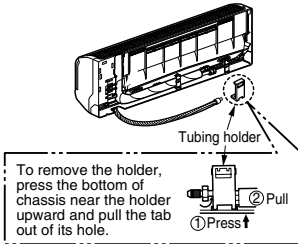

CAUTION : When install, make sure that the remaining parts must be removed clearly so as not to damage the piping and drain hose, especially power cord and connecting cable.

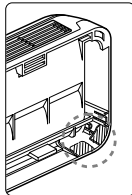

For left rear piping

1. Route the indoor tubing and the drain hose in the direction of rear left.

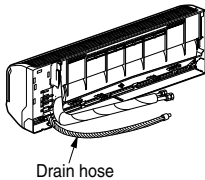

2. Insert the connecting cable into the indoor unit from the outdoor unit through the piping hole.

- Do not connect the cable to the indoor unit.
- Make a small loop with the cable for easy connection later.
- Drill a hole in the wall
 - Drill the piping hole with a $\phi 70\text{mm}$ hole core drill. Drill the piping hole at either the right or the left with the hole slightly slanted to the outdoor side.

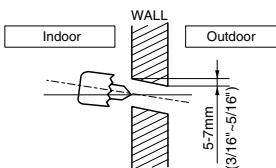

3. Tape the tubing, drain hose and the connecting cable. Be sure that the drain hose is located at the lowest side of the bundle. Locating at the upper side can cause drain pan to overflow inside the unit.

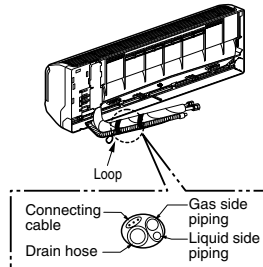

NOTICE : If the drain hose is routed inside the room, insulate the hose with an insulation material* so that dripping from "sweating"(condensation) will not damage furniture or floors.

*Foamed polyethylene or equivalent is recommended.

4. Indoor unit installation

- Hook the indoor unit onto the upper portion of the installation plate.(Engage the two hooks of the rear top of the indoor unit with the upper edge of the installation plate.) Ensure that the hooks are properly seated on the installation plate by moving it left and right.

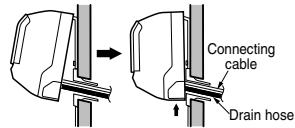

Press the lower left and right sides of the unit against the installation plate until the hooks engage into their slots(clicking sound).

5. Connecting the pipings to the indoor unit and drain hose to drain pipe.

- Align the center of the pipings and sufficiently tighten the flare nut by hand.

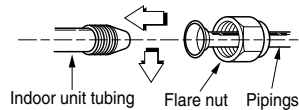

- Tighten the flare nut with a wrench.

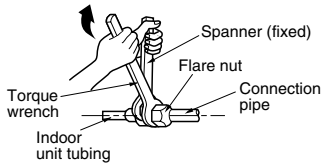

Pipe Size[Torque]	
GAS	LIQUID
Ø12.7[5.5kg·m]	Ø6.35[1.8kg·m]
Ø15.88[6.6kg·m]	Ø9.52[4.2kg·m]

- When extending the drain hose at the indoor unit, install the drain pipe.

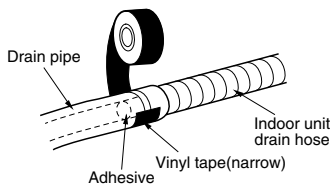

6. Wrap the insulation material around the connecting portion.

- Overlap the connection pipe insulation material and the indoor unit pipe insulation material. Bind them together with vinyl tape so that there is no gap.

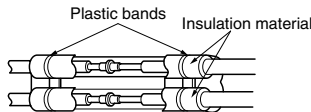

- Wrap the area which accommodates the rear piping housing section with vinyl tape.

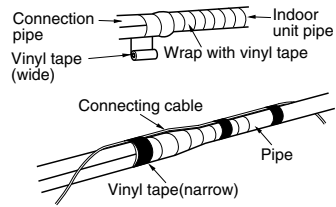

- Bundle the piping and drain hose together by wrapping them with vinyl tape over the range within which they fit into the rear piping housing section.

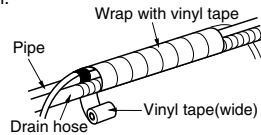

For right rear piping

1. Route the indoor tubing and the drain hose to the required piping hole position.

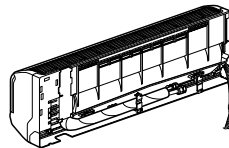

2. Insert the piping, drain hose and the connecting cable into the piping hole.

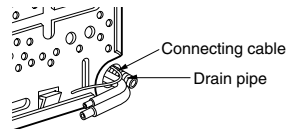

Installation

3. Insert the connecting cable into the indoor unit.

- Don't connect the cable to the indoor unit.
- Make a small loop with the cable for easy connection later.

4. Tape the drain hose and the connecting cable.

- Connecting cable

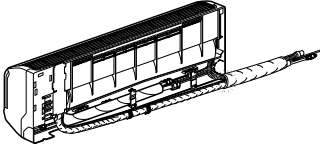

5. Indoor unit installation

- Hang the indoor unit from the hooks at the top of the installation plate.
- Insert the spacer etc. between the indoor unit and the installation plate and separate the bottom of the indoor unit from the wall.

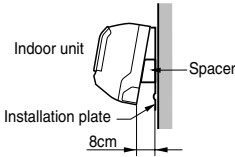

6. Connecting the pipings to the indoor unit and the drain hose to drain pipe.

- Align the center of the pipings and sufficiently tighten the flare nut by hand.

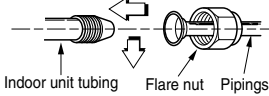

- Tighten the flare nut with a wrench.

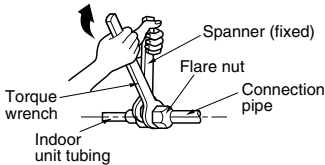

Pipe Size[Torque]	
GAS	LIQUID
Ø12.7[5.5kg·m]	Ø6.35[1.8kg·m]
Ø15.88[6.6kg·m]	Ø9.52[4.2kg·m]

- When extending the drain hose at the indoor unit, install the drain pipe.

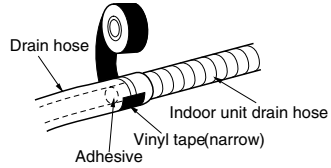

7. Wrap the insulation material around the connecting portion.

- Overlap the connection pipe heat insulation and the indoor unit pipe heat insulation material. Bind them together with vinyl tape so that there is no gap.

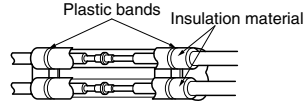

- Wrap the area which accommodates the rear piping housing section with vinyl tape.

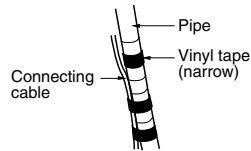
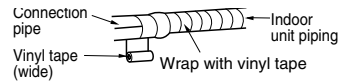

- Bundle the piping and drain hose together by wrapping them with cloth tape over the range within which they fit into the rear piping housing section.

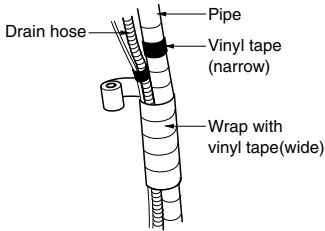

8. Reroute the pipings and the drain hose across the back of the chassis.

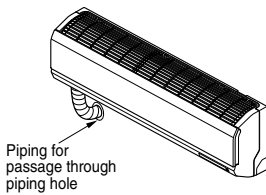

9. Set the pipings and the drain hose to the back of the chassis with the tubing holder.

- Hook the edge of tubing holder to tap on chassis and push the bottom of tubing holder to be engaged at the bottom of chassis.

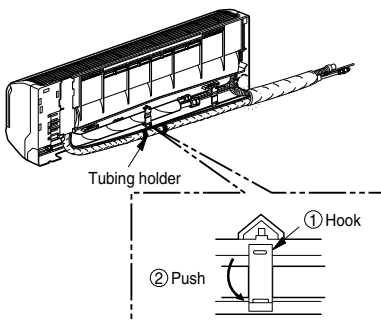

10. Indoor unit installation

- Remove the spacer.
- Ensure that the hooks are properly seated on the installation plate by moving it left and right.

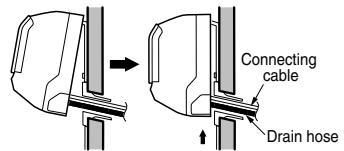

Press the lower left and right sides of the unit against the installation plate until the hooks engage into their slots (clicking sound).

▲ CAUTION

Installation Information. For left piping. Follow the instruction below.

Good case

- Press on the upper side of clamp and unfold the tubing to downward slowly.

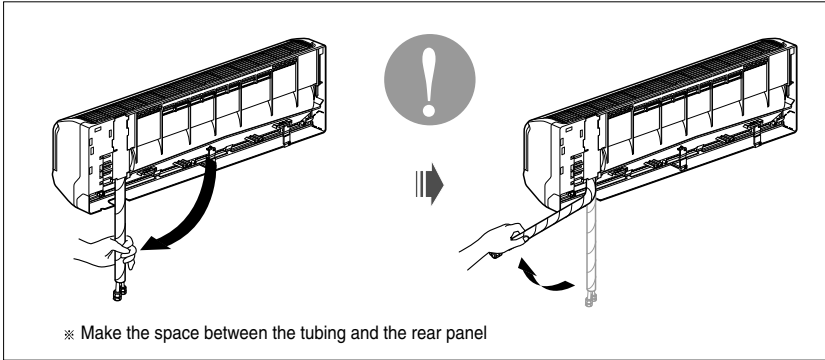

Bad case

- Following bending type from right to left may cause damage to the tubing.

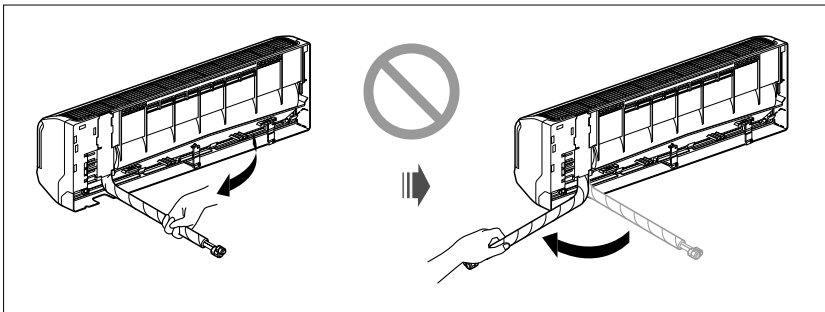

Drain Piping

1. To remove the front panel from the indoor unit, remove the front panel from the indoor unit cabinet.

- Set the air direction louvers up-and-down to the position(horizontally) by hand.
- Remove the securing screws that retain the front panel. Pull the lower left and right sides of the grille toward you and lift it off.
(2.1/7, 2.6/9, 3.5/12 kW/Btu models: 2EA,
3.5/18 kW/Btu models: 3EA)

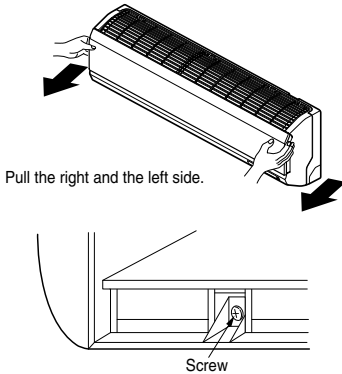

2. To check the drainage.

- Pour a glass of water on the evaporator.
- Ensure the water flows through the drain hose of the indoor unit without any leakage and goes out the drain exit.

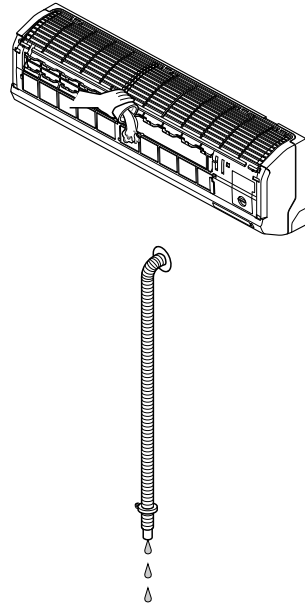

Wiring Connection

1) Connect the wires to the terminals on the control board individually according to the outdoor unit connection.

- Ensure that the color of the wires of outdoor unit and the terminal No. are the same as those of indoor unit respectively.

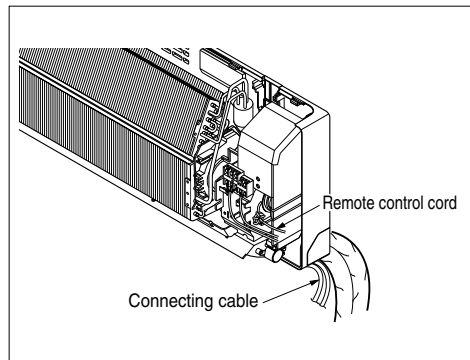

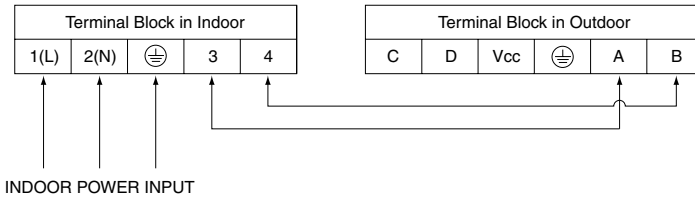

2) Attach the Grille onto the cabinet.

- Grasp lower the left and right side of the Grille and engage four tabs on the top inside edge of the chassis.
- Press the Grille toward the chassis until it will be back into place.

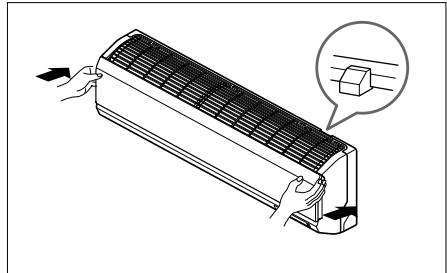

CAUTION:

After the confirmation of the above conditions, prepare the wiring as follows:

- 1) **Never fail to have an individual power circuit specifically for the air conditioner. As for the method of wiring, be guided by the circuit diagram posted on the inside of control cover.**
- 2) **The screw which fasten the wiring in the casing of electrical fittings are liable to come loose from vibrations to which the unit is subjected during the course of transportation. Check them and make sure that they are all tightly fastened. (If they are loose, it could cause burn-out of the wires.)**
- 3) **Specification of power source.**
- 4) **Confirm that electrical capacity is sufficient.**
- 5) **See to that the starting voltage is maintained at more than 90 percent of the rated voltage marked on the name plate.**
- 6) **Confirm that the cable thickness is as specified in the power source specification. (Particularly note the relation between cable length and thickness.)**
- 7) **In a wet or moist area, always install an earth leakage circuit breaker.**
- 8) **The following would be caused by voltage drop.**
 - Vibration of a magnetic switch, which will damage the contact point, fuse breaking, disturbance of the normal function of the overload.
- 9) **The means for disconnection from a power supply shall be incorporated in the fixed wiring and have an air gap contact separation of at least 3mm in each active(phase) conductors.**

Installation of Remote Controller

HOW TO MOUNT ONTO A WALL

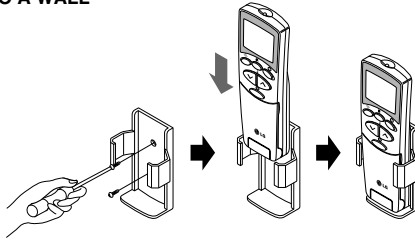

HOW TO INSERT BATTERIES

1. Remove the battery cover from the remote controller.
 - Slide the cover according to the arrow direction.
2. Insert the two batteries.
 - Be sure that the (+) and (-) directions are correct.
 - Be sure that both batteries are new.
3. Re-attach the cover.
 - Slide it back into position.

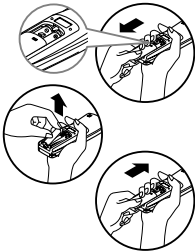

- Do not use rechargeable batteries, such batteries differ from standard dry cells in shape, dimensions, and performance.
- Remove the batteries from the remote controller if the air conditioner is not going to be used for some long time.

Installation of Remote Control

- Although the room temperature sensor is in the indoor unit, the remote controller should be installed in such places away from direct sunlight and high humidity.

Installation of the remote controller

- Select places that are not splashed with water.
- Select controller position after receiving customer approval.
- The room temperature sensor is built in the indoor unit.
- This remote controller equipped with liquid crystal display. If this position is higher or lower, display is difficult to see. (The standard height is 1.2 ~ 1.5m high)

Routing of the remote controller cord

- Keep the remote controller cord away from the refrigerant piping and the drain piping.
- To protect the remote controller cord from electrical noise, place the cord at least 5cm away from other power cables. (audio equipment, television set, etc.)
- If the remote controller cord is secured to the wall, provide a trap at the top of the cord to prevent water droplets from running.

WIRED REMOTE CONTROLLER INSTALLATION

DISASSEMBLING

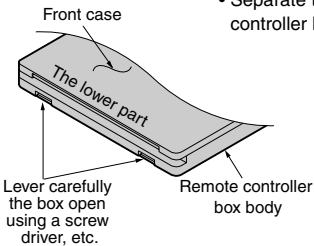

- Separate the under plate from Remote controller box.
- Attach insulator to under plate.

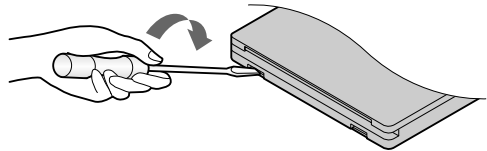

- Fix the under plate on the wall

- Fix the cord clamps on the wall by $\phi 3$ tapping screws (accessory).
- Fix the remote controller cord.

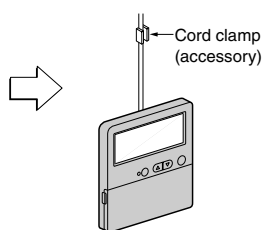
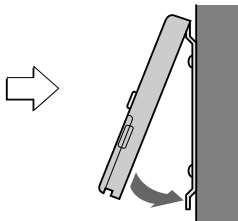
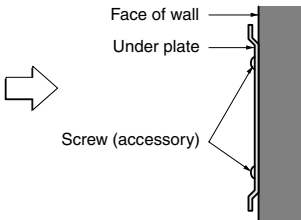

ELECTRICAL WIRING

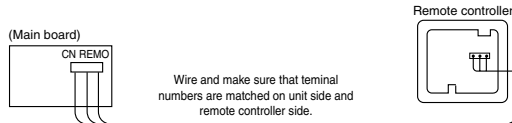

Wire and make sure that terminal numbers are matched on unit side and remote controller side.

The maximum length of the cord is 100m.
If the length of the cord exceeds 50m,
use a wire size greater than 0.5mm².

Optional operation

1) Two Thermistor System

- (1) Open the rear cover of the wired remote-controller to set the mode.
- (2) Select one of three selectable modes as follows.
 - Position 1:
The room temperature is controlled by the thermistor of the main body.
 - Position 2:
The room temperature is controlled by the thermistor of the wired remote-controller, control the temperature according to the position of wired remote-controller.
 - Position 3:
The room temperature is controlled by lower temperature between the temperature of main body and of remote-controller sensor.
- (3) Move the slide switch to set position.
- (4) Close the rear cover and check if it works normally.

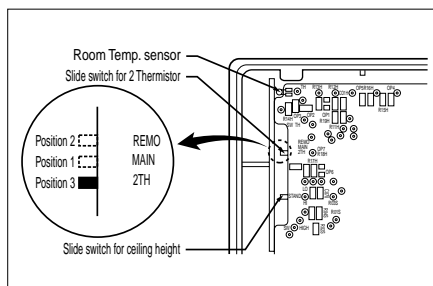

CAUTION :

- Select the position after counselling with a customer.
- In case of cooling mode, room temperature is controlled by the main body sensor.
- To control the room temperature by a wired remote controller, install the remote controller (room temp. sensor) to sense the temperature more accurately.
- Manufactured in the position 3.

