



website <http://www.lgservice.com>  
e-mail <http://www.lgservice.com/techsup.html>

LG

ENGLISH

ITALIANO

ESPAÑOL

FRANÇAIS

DEUTSCH

# **MULTI V™** System Heat Pump Indoor Unit **INSTALLATION MANUAL**

**MODELS: BR/BG/BH Series**

**Type: Ceiling Concealed Duct - High Static**

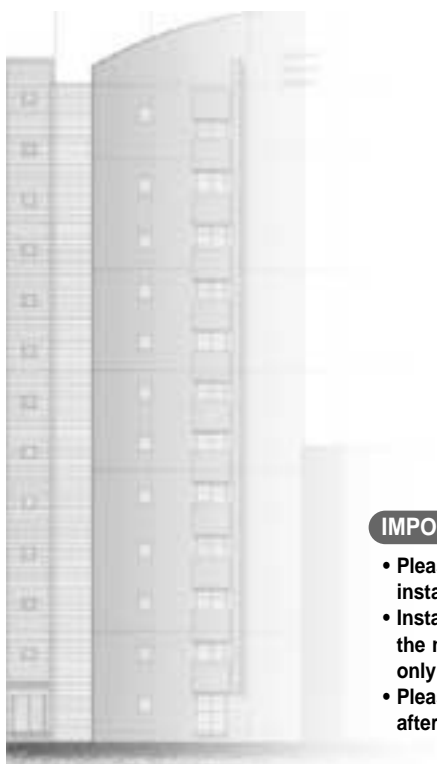

## IMPORTANT

- Please read this installation manual completely before installing the product.
- Installation work must be performed in accordance with the national wiring standards by authorized personnel only.
- Please retain this installation manual for future reference after reading it thoroughly.

# TABLE OF CONTENTS

<b>Installation Requirements</b>	<b>Required Parts</b>	<b>Required Tools</b>
<b>Features</b> .....3		
<b>Safety Precautions</b> .....4		
<b>Installation</b>		
Selection the best location ....7	<input type="checkbox"/> Four type "A" screws <input type="checkbox"/> Connecting cable	<input type="checkbox"/> Level gauge <input type="checkbox"/> Screw driver <input type="checkbox"/> Electric drill <input type="checkbox"/> Hole core drill
Ceiling opening dimension and hanging bolt location .....8	<input type="checkbox"/> Pipes: Gas side Liquid side (Refer to Product Data)	<input type="checkbox"/> Flaring tool set <input type="checkbox"/> Specified torque wrenches (different depending on model No.)
Indoor Unit Installation .....9	<input type="checkbox"/> Insulation materials <input type="checkbox"/> Additional drain pipe	<input type="checkbox"/> Spanner .....Half union
Wiring Connection .....9		<input type="checkbox"/> A glass of water <input type="checkbox"/> Screw driver
Checking the Drainage.....10		<input type="checkbox"/> Hexagonal wrench <input type="checkbox"/> Gas-leak detector <input type="checkbox"/> Vacuum pump <input type="checkbox"/> Gauge manifold
Installation of Remote controller.....13		<input type="checkbox"/> Owner's manual <input type="checkbox"/> Thermometer
<b>Two Thermistor system</b> .....14		
<b>How to Set E.S.P?</b> .....15		

# Features

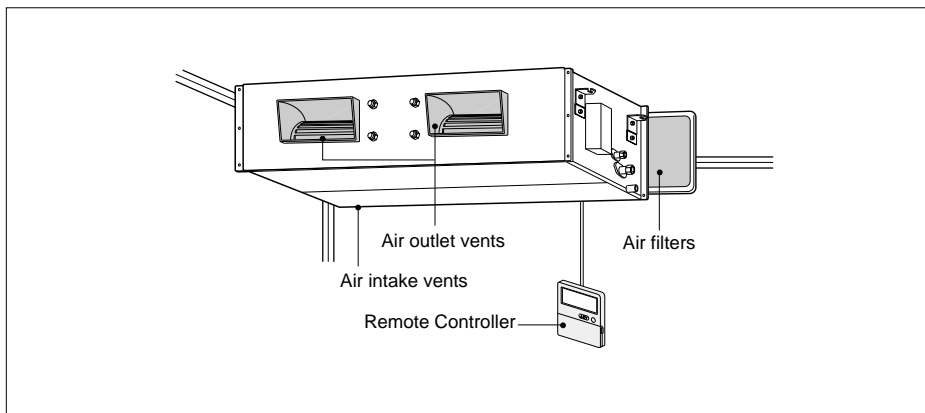

# Safety Precautions



To prevent injury to the user or other people and property damage, the following instructions must be followed.

- Be sure to read before installing the air conditioner.
- Be sure to observe the cautions specified here as they include important items related to safety.
- Incorrect operation due to ignoring instruction will cause harm or damage. The seriousness is classified by the following indications.

**⚠ WARNING** This symbol indicates the possibility of death or serious injury.

**⚠ CAUTION** This symbol indicates the possibility of injury or damage to properties only.

- Meanings of symbols used in this manual are as shown below.

	<b>Be sure not to do.</b>
	<b>Be sure to follow the instruction.</b>

## ⚠ WARNING

### ■ Installation

**Do not use a defective or underrated circuit breaker. Use this appliance on a dedicated circuit.**

- There is risk of fire or electric shock.



**For electrical work, contact the dealer, seller, a qualified electrician, or an Authorized Service Center.**

- Do not disassemble or repair the product. There is risk of fire or electric shock.



**Always ground the product.**

- There is risk of fire or electric shock.

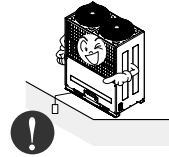

**Install the panel and the cover of control box securely.**

- There is risk of fire or electric shock.



**Always install a dedicated circuit and breaker.**

- Improper wiring or installation may cause fire or electric shock.



**Use the correctly rated breaker or fuse.**

- There is risk of fire or electric shock.



**Do not modify or extend the power cable.**

- There is risk of fire or electric shock.

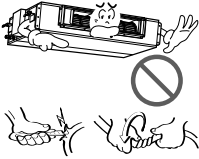

**Do not let the air conditioner run for a long time when the humidity is very high and a door or a window is left open.**

- Moisture may condense and wet or damage furniture.



**Be cautious when unpacking and installing the product.**

- Sharp edges could cause injury. Be especially careful of the case edges and the fins on the condenser and evaporator.



**For installation, always contact the dealer or an Authorized Service Center.**

- There is risk of fire, electric shock, explosion, or injury.



**Do not install the product on a defective installation stand.**

- It may cause injury, accident, or damage to the product.



**Be sure the installation area does not deteriorate with age.**

- If the base collapses, the air conditioner could fall with it, causing property damage, product failure, and personal injury.

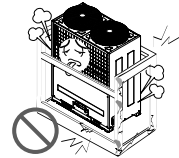

## ■ Operation

**Do not store or use flammable gas or combustibles near the product.**

- There is risk of fire or failure of product.

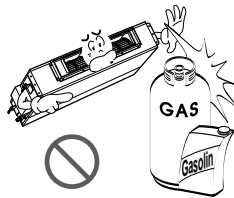

**CAUTION**

**Installation**

**Always check for gas (refrigerant) leakage after installation or repair of product.**

- Low refrigerant levels may cause failure of product.

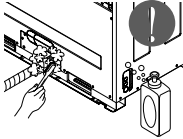

**Install the drain hose to ensure that water is drained away properly.**

- A bad connection may cause water leakage.

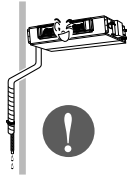

**Keep level even when installing the product.**

- To avoid vibration or water leakage.

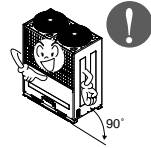

**Do not install the product where the noise or hot air from the outdoor unit could damage the neighborhoods.**

- It may cause a problem for your neighbors.



**Use two or more people to lift and transport the product.**

- Avoid personal injury.



**Do not install the product where it will be exposed to sea wind (salt spray) directly.**

- It may cause corrosion on the product. Corrosion, particularly on the condenser and evaporator fins, could cause product malfunction or inefficient operation.

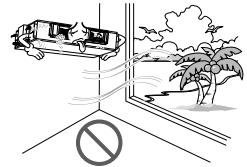

# Installation

Read completely, then follow step by step.

## Selection of the best location

Install the air conditioner in the location that satisfies the following conditions.

- The place shall easily bear a load exceeding four times the indoor unit's weight.
- The place shall be able to inspect the unit as the figure.
- The place where the unit shall be leveled.
- The place shall allow easy water drainage.(Suitable dimension "H" is necessary to get a slope to drain as figure.)
- The place shall easily connect with the outdoor unit.
- The place where the unit is not affected by an electrical noise.
- The place where air circulation in the room will be good .
- There should not be any heat source or steam near the unit.

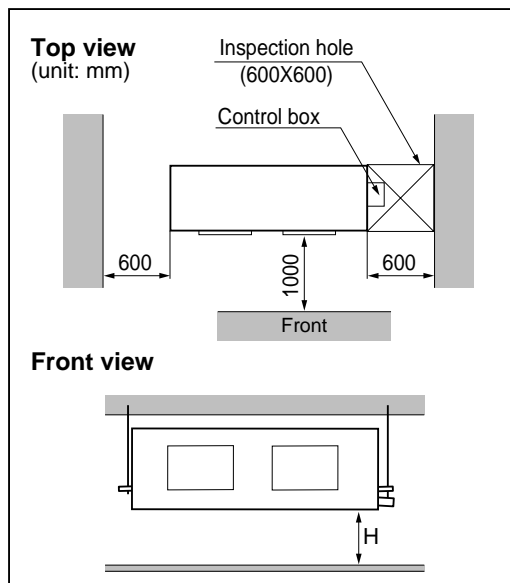

**CAUTION** : In case that the unit is installed near the sea, the installation parts may be corroded by salt, The installation parts (and the unit) should be taken appropriate anti-corrosion measures.

## Ceiling dimension and hanging bolt location

### ■ Installation of Unit

Install the unit above the ceiling correctly.

#### CASE 1

##### POSITION OF SUSPENSION BOLT

- Apply a joint-canvas between the unit and duct to absorb unnecessary vibration.

(Unit:mm)

Dimension Capacity (k(Btu/h))	Dimension							
	A	B	C	D	E	F	(G)	H
18/24k	932	882	355	45.5	450	30	87	750
28/36/42k	1232	1182	355	45.5	450	30	87	830
48k	1287	1230	477	57	590	30	120	1004

#### CASE 2

- Install the unit leaning to a drainage hole side as a figure for easy water drainage.

##### POSITION OF CONSOLE BOLT

- A place where the unit will be leveled and that can support the weight of the unit.
- A place where the unit can withstand its vibration.
- A place where service can be easily performed.

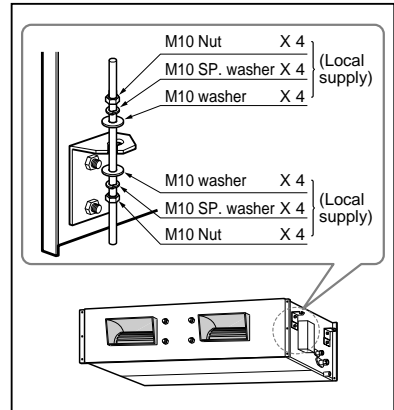
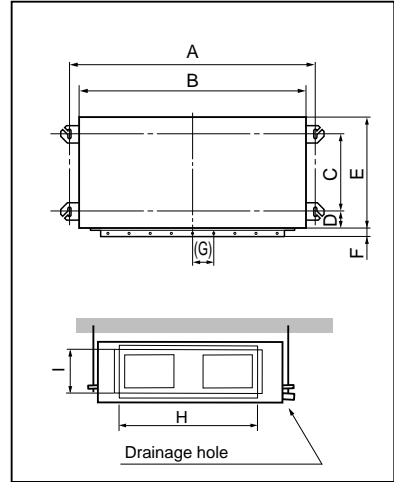

#### NOTICE

- Thoroughly study the following installation locations:

1. In such places as restaurants and kitchens, considerable amount of oil steam and flour adhere to the fan, the fin of the heat exchanger, resulting in heat exchange reduction, spraying, dispersing of water drops, etc. In these cases, take the following actions:
  - Make sure that the ventilation fan for smoke-collecting hood on a cooking table has sufficient capacity so that it draws oily steam which should not flow into the suction of the air conditioner.
  - Make enough distance from a cooking room to install the air conditioner in such a place where it may not suck in oil steam.
2. Avoid installing air conditioner in such circumstances where cutting oil mist or iron powder is in suspension in factories, etc.
3. Avoid places where inflammable gas is generated, flows in, is stored or vented.
4. Avoid places where sulfurous acid gas or corrosive gas is generated.
5. Avoid places near high frequency generators.



## Indoor Unit Installation

- Select and mark the position for fixing bolts.
- Drill the hole for set anchor on the face of ceiling.

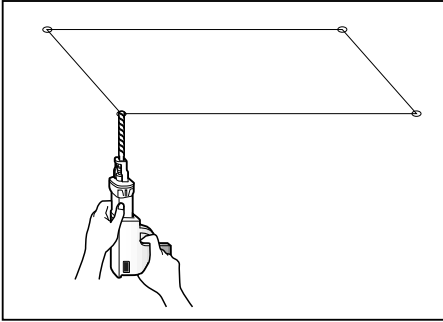

**CAUTION** : Tighten the nut and bolt to prevent unit falling.

- Insert the set anchor and washer onto the suspension bolts for locking the suspension bolts on the ceiling.
- Mount the suspension bolts to the set anchor firmly.
- Secure the installation plates onto the suspension bolts (adjust level roughly) using nuts, washers and spring washers.

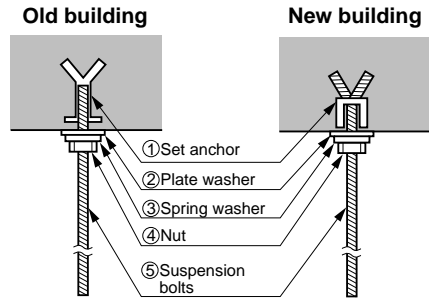

## Wiring Connection

Connect the wires to the terminals on the control board individually according to the outdoor unit connection.

- Ensure that the color of the wires of outdoor unit and the terminal No. are the same as those of indoor unit respectively.

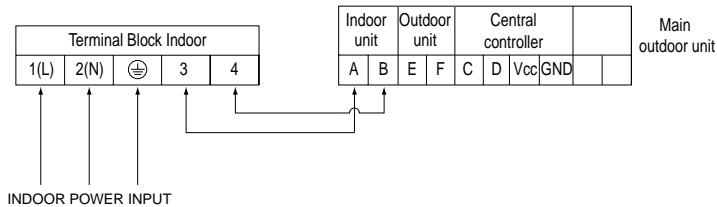

**WARNING** : Make sure that the screws of the terminal are free from looseness.

## Clamping of cables

- 1) Arrange 2 power cables on the control panel.
- 2) First, fasten the steel clamp with a screw to the inner boss of control panel.
- 3) For the cooling model, fix the other side of the clamp with a screw strongly. For the heat pump model, put the 0.75mm<sup>2</sup> cable(thinner cable) on the clamp and tighten it with a plastic clamp to the other boss of the control panel.

**INSULATION, OTHERS**

Insulate the joint and tubes completely.

**THERMAL INSULATION**

All thermal insulation must comply with local requirement.

**INDOOR UNIT**

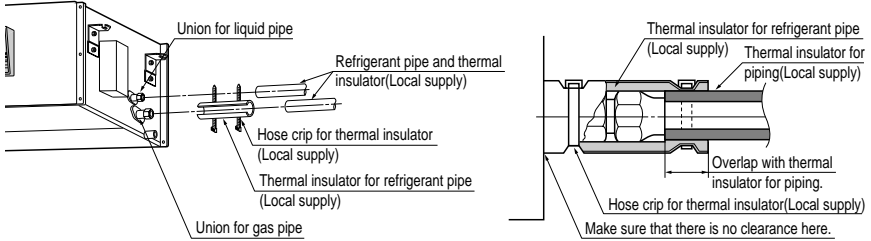

**Checking the Drainage**

**1. Remove the Air Filter.**

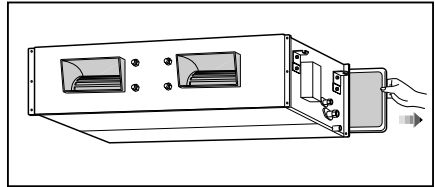

**2. Check the drainage.**

- Spray one or two glasses of water upon the evaporator.
- Ensure that water flows drain hose of indoor unit without any leakage.

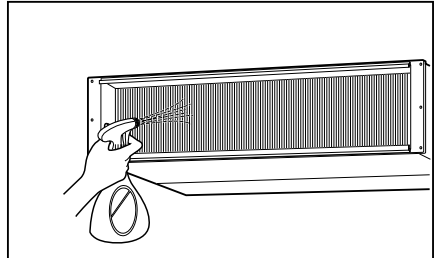

**CAUTION**

1. **Install declination** of the indoor unit is very **important for the drain** of the duct type air conditioner.
2. Minimum thickness of the insulation for the connecting pipe shall be 5mm.

**Front of view**

- The unit must be horizontal or declined to the drain hose connected when finished installation.

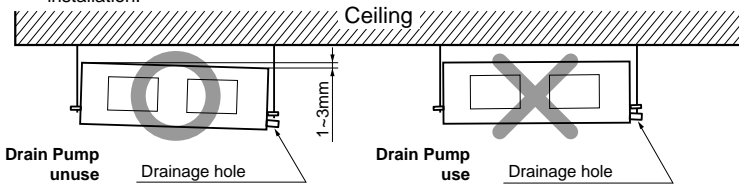

**CAUTION FOR GRADIENT OF UNIT AND DRAIN PIPING**

Lay the drain hose with a downware inclination so water will drain out.

- Always lay the drain with downward inclination (1/50 to 1/100). Prevent any upward flow or reverse flow in any part.
- 5mm or thicker formed thermal insulator shall always be provided for the drain pipe.

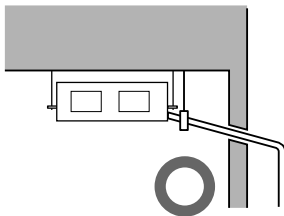
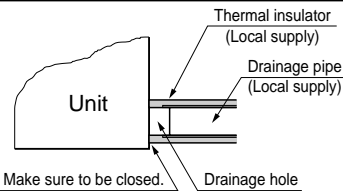

**CORRECT**

- Install the P-Trap (or U-Trap) to prevent a water leakage caused by the blocking of intake air filter.

- Upward routing not allowed

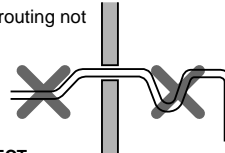

**INCORRECT**

**Applied U-Trap Dimension**

- A ≥ 70mm
- B ≥ 2C
- C ≥ 2 x SP
- SP = External Pressure (mmAq)
- Ex) External Pressure = 10mmAq
- A ≥ 70mm
- B ≥ 40mm
- C ≥ 20mm

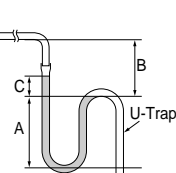



**CAUTION:**

After the confirmation of the above conditions, prepare the wiring as follows:

- 1) **Never fail to have an individual power specialized for the air conditioner. As for the method of wiring, be guided by the circuit diagram posted on the inside of control box cover.**
- 2) **Provide a circuit breaker switch between power source and the unit.**
- 3) **The screws which fasten the wiring in the casing of electrical fittings are liable to come loose from vibrations to which the unit is subjected during the course of transportation. Check them and make sure that they are all tightly fastened. (If they are loose, it could give rise to burn-out of the wires.)**
- 4) **Specification of power source**
- 5) **Confirm that electrical capacity is sufficient.**
- 6) **Be sure that the starting voltage is maintained at more than 90 percent of the rated voltage marked on the name plate.**
- 7) **Confirm that the cable thickness is as specified in the power sources specification. (Particularly note the relation between cable length and thickness.)**
- 8) **Never fail to equip a leakage breaker where it is wet or moist.**
- 9) **The following troubles would be caused by voltage drop-down.**
  - Vibration of a magnetic switch, damage on the contact point, fuse breaking, disturbance by the normal function of an overload protection device.
  - Proper starting power is not given to the compressor.

## **HAND OVER**

Teach the customer the operation and maintenance procedures, using the operation manual. (air filter cleaning, temperature control, etc.)

## Installation of Remote Controller

- Although the room temperature sensor is in the indoor unit, the remote controller should be installed in such places away from direct sunlight and high humidity.

### Installation of the remote controller

- Select places that are not splashed with water.
- Select controller position after receiving customer approval.
- The room temperature sensor is built in the indoor unit.
- This remote controller equipped with liquid crystal display. If this position is higher or lower, display is difficult to see. (The standard height is 1.2 ~ 1.5m high)

### Routing of the remote controller cord

- Keep the remote controller cord away from the refrigerant piping and the drain piping.
- To protect the remote controller cord from electrical noise, place the cord at least 5cm away from other power cables. (audio equipment, television set, etc.)
- If the remote controller cord is secured to the wall, provide a trap at the top of the cord to prevent water droplets from running.

## WIRED REMOTE CONTROL INSTALLATION

### DISASSEMBLING

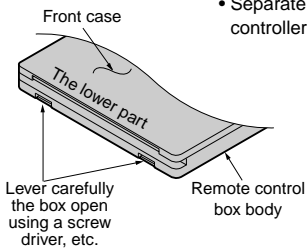

- Separate the under plate from Remote controller box.
- Attach insulator to under plate.

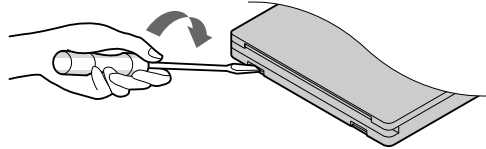

- Fix the under plate on the wall

- Fix the cord clamps on the wall by  $\phi 3$  tapping screws (accessory).
- Fix the remote controller cord.

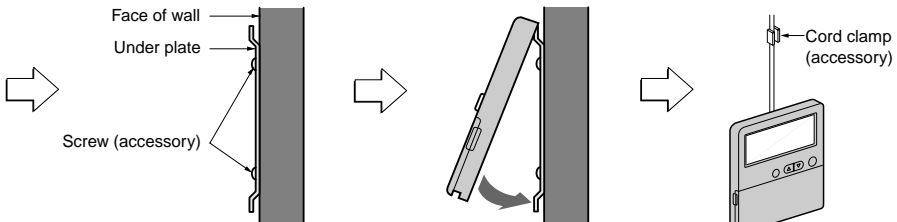

### ELECTRICAL WIRING

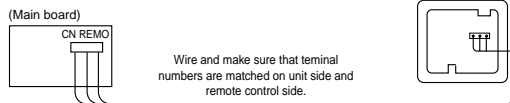

Wire and make sure that terminal numbers are matched on unit side and remote control side.

The maximum length of the cord is 100m.  
If the length of the cord exceeds 50m,  
use a wire size greater than 0.5mm<sup>2</sup>.

## Two Thermistor system

- Open the rear cover of Remote Controller to set up the mode.
- Selectable options are three as follows.
  - Remo: Sensing the room Temperature.
  - Indoor Unit: Sensing the intake air into indoor Unit.
  - 2 TH: Sensing the lower temperature of the two thermistors.
- To set up the mode, adjust the slide switch to desired mode position on installing.

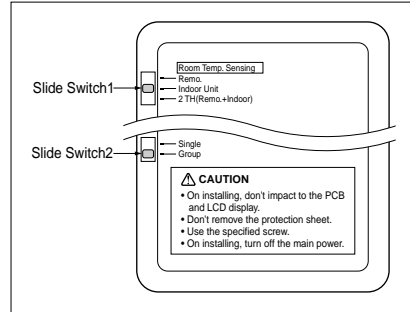

# How to Set E.S.P?

## Procedure of RPM change:

Ex) External Static pressure is 4mmAq for Model Name "ABNH12G1FAB/ABNH24G1FAB"

- To protect the unit, compressor is designed to be off during E.S.P. setting.

- 1 Push the "On/Off" button.  
The unit will start.

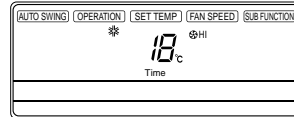

- 2 Push the "Timer" and "Wind" button simultaneously for more than 3 seconds.

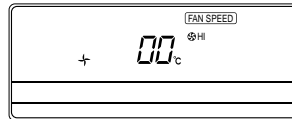

- 3 Push the "Up" or "Down" button for E.S.P adjustment.  
And, adjust the number which you want. (In this example, the number is "190". Refer to the table 1 on the next page.)

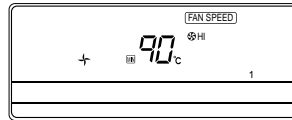
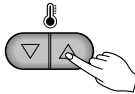

**NOTICE** The range of selection is from 1~254. Since, the display is two Digit only.  
If the range selection is above 100 then the third digit will appear in the screen as shown.

- 4 Shift the fan speed mode by pressing the fan speed button.  
And then, Adjust numbers of next steps by repeating the stage 3.  
(In this example, the numbers are "220" and "235" respectively)



- 5 Push the "Timer" and "Wind" button simultaneously for more than 3 seconds.  
Then, Wind Data is memorized by the EEPROM of the main PCB.

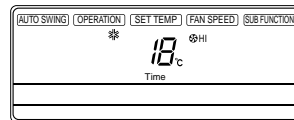

How to Set E.S.P?

[Table.1]

Static Pressure(mmAq)		2	3	6	8	10	14
Model Name	Step(Hi/Med/Lo)	Setting Value					
18k	15.3CMM	106	-	130	-	-	-
	13.6CMM	100	-	125	-	-	-
	10.3CMM	90	-	110	-	-	-
21k	17.7CMM	115	-	140	-	-	-
	14.5CMM	103	-	128	-	-	-
	12.2CMM	95	-	120	-	-	-
24k	19.0CMM	120	-	145	-	-	-
	16.4CMM	110	-	135	-	-	-
	14.5CMM	103	-	128	-	-	-
28k	25.3CMM	-	113	-	127	-	-
	21.8CMM	-	105	-	120	-	-
	17.6CMM	-	97	-	113	-	-
36k	29.6CMM	-	120	-	140	-	-
	25.3CMM	-	113	-	127	-	-
	21.8CMM	-	105	-	120	-	-
38k	29.6CMM	-	123	-	143	-	-
	26.3CMM	-	115	-	131	-	-
	23.6CMM	-	109	-	124	-	-
42k	32.0CMM	-	130	-	148	-	-
	28.4CMM	-	120	-	140	-	-
	23.6CMM	-	115	-	132	-	-
48k	45CMM	-	-	-	-	112	122
	40CMM	-	-	-	-	108	118
	33CMM	-	-	-	-	104	114

- NOTICE**
1. Be sure to set the value referring table 1. Unexpected set value will cause mal-function.
  2. Table 1 is based at 220-240V. According to the fluctuation of voltage, air flow rate varies.



