



**LG**

Life's Good

# INSTALLATION MANUAL

# AIR CONDITIONER

- Please read this installation manual completely before installing the product.
- Installation work must be performed in accordance with the national wiring standards by authorized personnel only.
- Please retain this installation manual for future reference after reading it thoroughly.

TYPE : Multi



P/NO : 3828A20403Q

[www.lg.com](http://www.lg.com)

# TABLE OF CONTENTS

## *Installation Requirements*

<b>Installation Parts Provided .....</b>	<b>3</b>
<b>Safety Precautions .....</b>	<b>4</b>
<b>Installation of Indoor, Outdoor Unit .....</b>	<b>7</b>
Wall mounted Type.....	11
Duct Type .....	15
CST Type .....	21
<b>Flaring work and connection of piping.....</b>	<b>29</b>
<b>Connecting the Cable between Indoor Unit and Outdoor Unit .....</b>	<b>42</b>
<b>Checking the Drainage, Forming the Pipings and Long pipe Setting .....</b>	<b>44</b>
<b>Air Purging and Evacuation .....</b>	<b>46</b>
<b>Test running .....</b>	<b>48</b>
<b>Optional Operation - Duct Type .....</b>	<b>49</b>
<b>Optional Operation - CST Type.....</b>	<b>54</b>
<b>Combination indoor units .....</b>	<b>57</b>
<b>Installation guide at the seaside.....</b>	<b>58</b>

## *Required Tools*

- Level gauge
- Screw driver
- Electric drill
- Hole core drill (ø50mm)
- Horizontal meter
  
- Flaring tool set
- Specified torque wrenches  
    1.8kg.m, 4.2kg.m, 5.5kg.m, 6.6kg.m  
    (different depending on model No.)
- Spanner .....Half union
  
- A glass of water
- Screw driver
  
- Hexagonal wrench(4mm)
- Gas-leak detector
- Vacuum pump
- Gauge manifold
- Owner's manual
- Thermometer
- Holder Remote Control

# Installation Parts Provided

## Indoor Unit

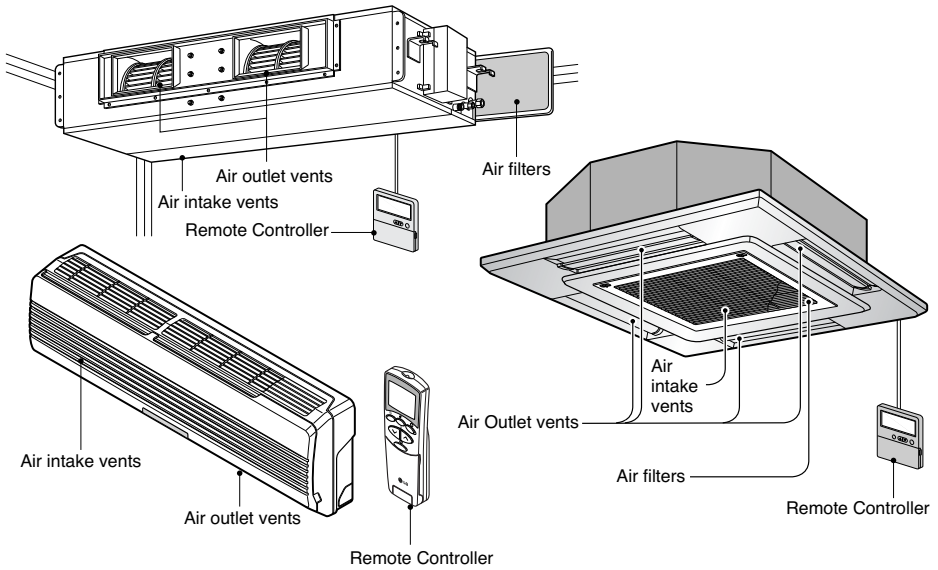

## Outdoor Unit

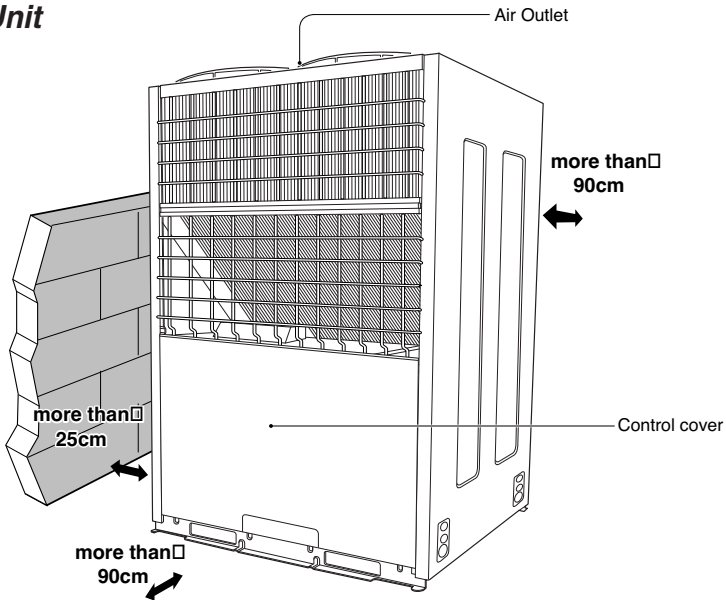

# Safety Precautions



To prevent injury to the user or other people and property damage, the following instructions must be followed.

■ Incorrect operation due to ignoring instruction will cause harm or damage. The seriousness is classified by the following indications.

**⚠ WARNING** This symbol indicates the possibility of death or serious injury.

**⚠ CAUTION** This symbol indicates the possibility of injury or damage.

■ Meanings of symbols used in this manual are as shown below.

	<b>Be sure not to do.</b>
	<b>Be sure to follow the instruction.</b>

## ⚠ WARNING

### ■ Installation

**Do not use a defective or underrated circuit breaker. Use this appliance on a dedicated circuit.**

- There is risk of fire or electric shock.

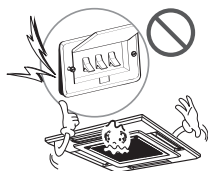

**For electrical work, contact the dealer, seller, a qualified electrician, or an Authorized Service Center.**

- Do not disassemble or repair the product. There is risk of fire or electric shock.

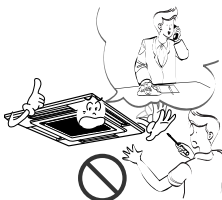

**Always ground the product.**

- There is risk of fire or electric shock.

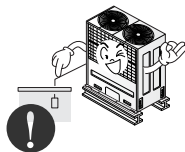

**Install the panel and the cover of control box securely.**

- There is risk of fire or electric shock.

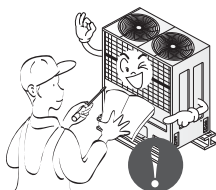

**Always install a dedicated circuit and breaker.**

- Improper wiring or installation may cause fire or electric shock



**Use the correctly rated breaker or fuse.**

- There is risk of fire or electric shock.

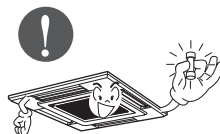

**Do not modify or extend the power cable.**

- There is risk of fire or electric shock.

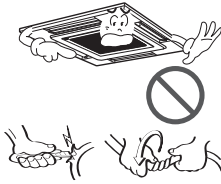

**Be cautious when unpacking and installing the product.**

- Sharp edges could cause injury. Be especially careful of the case edges and the fins on the condenser and evaporator.

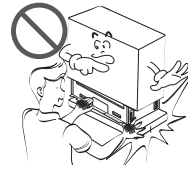

**For installation, always contact the dealer or an Authorized Service Center.**

- There is risk of fire, electric shock, explosion, or injury.



**Do not install the product on a defective installation stand.**

- It may cause injury, accident, or damage to the product.

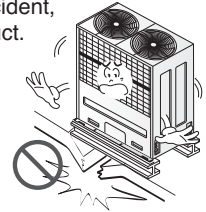

**Be sure the installation area does not deteriorate with age.**

- If the base collapses, the air conditioner could fall with it, causing property damage, product failure, and personal injury.

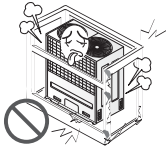

**Do not let the air conditioner run for a long time when the humidity is very high and a door or a window is left open.**

- Moisture may condense and wet or damage furniture.



**Use a vacuum pump or Inert (nitrogen) gas when doing leakage test or air purge. Do not compress air or Oxygen and do not use Flammable gases. Otherwise, it may cause fire or explosion.**

- There is the risk of death, injury, fire or explosion.

**■ Operation**

**Do not store or use flammable gas or combustibles near the product.**

- There is risk of fire or failure of product.



# CAUTION

## Installation

Always check for gas (refrigerant) leakage after installation or repair of product.

- Low refrigerant levels may cause failure of product.

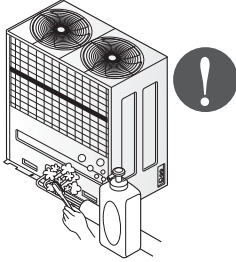

Install the drain hose to ensure that water is drained away properly.

- A bad connection may cause water leakage.

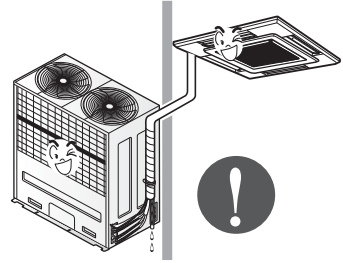

Keep level even when installing the product.

- To avoid vibration or water leakage.

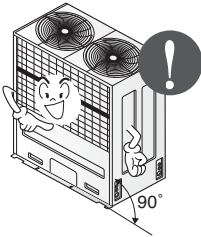

Do not install the product where the noise or hot air from the outdoor unit could damage the neighborhoods.

- It may cause a problem for your neighbors.

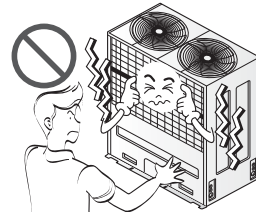

Don't let people to lift and transport the product. (Use fork lift)

- Avoid personal injury.

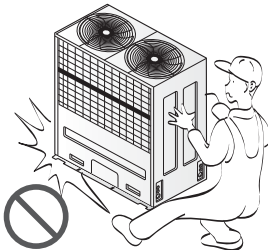

Do not install the product where it will be exposed to sea wind (salt spray) directly.

- It may cause corrosion on the product. Corrosion, particularly on the condenser and evaporator fins, could cause product malfunction or inefficient operation.

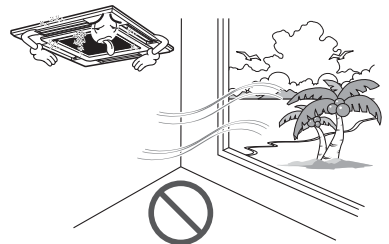

# Installation of Indoor, Outdoor Unit

Read completely, then follow step by step.

## Select the best location

### 1. Indoor unit

#### Wall mounted Type

- Do not have any heat or steam near the unit.
- Select a place where there are no obstacles in front of the unit.
- Make sure that condensation drainage can be conveniently routed away.
- Do not install near a doorway.
- Ensure the spaces indicated by arrows from the wall, ceiling, fence or other obstacles.
- Use a stud finder to locate studs to prevent unnecessary damage to the wall.



**CAUTION: Install the indoor unit on the wall where the height from the floors more than 2.3 meters.**

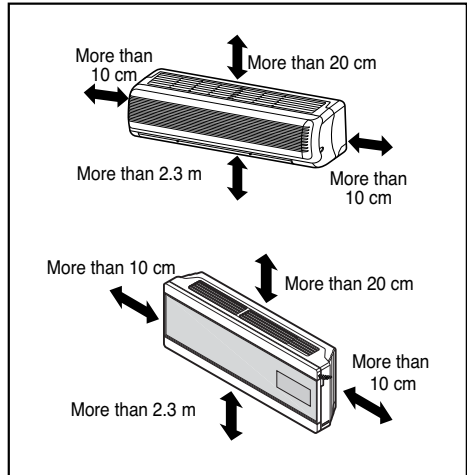

#### Duct Type

Install the air conditioner in the location that satisfies the following conditions.

- The place shall easily bear a load exceeding four times the indoor unit's weight.
- The place shall be able to inspect the unit as the figure.
- The place where the unit shall be leveled.
- The place shall allow easy water drainage. (Suitable dimension "H" is necessary to get a slope to drain as figure.)
- The place shall easily connect with the outdoor unit.
- The place where the unit is not affected by an electrical noise.
- The place where air circulation in the room will be good .
- There should not be any heat source or steam near the unit

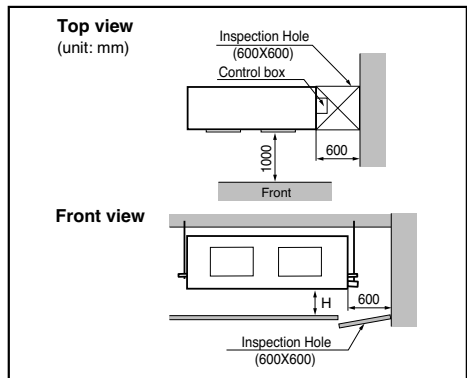

## CST Type

- There should not be any heat source or steam near the unit.
- There should not be any obstacles to prevent the air circulation.
- A place where air circulation in the room will be good.
- A place where drainage can be easily obtained.
- A place where noise prevention is taken into consideration.
- Do not install the unit near the door way.
- Ensure the spaces indicated by arrows from the wall, ceiling, or other obstacles.
- The indoor unit must keep the maintenance space.

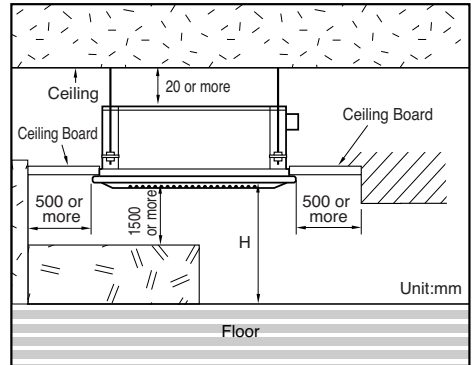

## 2. Outdoor unit

1. If an awning is built over the unit to prevent direct sunlight or rain exposure, make sure that heat radiation from the condenser is not restricted.
2. Ensure that the spaces indicated by arrows around front, back and side of the unit.
3. Do not place animals and plants in the path of the warm air.
4. Take the air conditioner weight into account and select a place where noise and vibration are minimum.
5. Select a place so that the warm air and noise from the air conditioner do not disturb neighbors.

### Rooftop Installations:

If the outdoor unit is installed on a roof structure, be sure to level the unit. Ensure the roof structure and anchoring method are adequate for the unit location. Consult local codes regarding rooftop mounting.

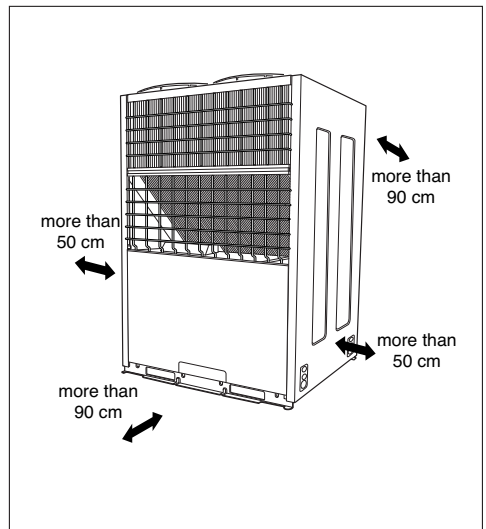



## Piping length and elevation

### Distributor Type

(m)

Model		Total Length	Max Main Pipe Length (A/B)	Total Branch Pipe Length	Max Branch Pipe Length	Max Elevation (h1/h2)	Indoor - Indoor Elevation (h3)
L5UC7 28FA0	With Distributor	60	A = 30	30	15	h1=30	10
	None Distributor A-Circuit	50	B = 50	-	-	h2=30	10
	None Distributor B-Circuit	30	B = 30	-	-	h2=30	10
L5UC7 28FA1	With Distributor	75	A = 45	30	15	h1=45	10
	None Distributor	45	B = 45	-	-	h2=45	10
L8UC1 008FA0	With Distributor	60	A = 30	30	15	h1=30	10
L8UH1 008FA0	None Distributor	50	B = 50	-	-	h2=30	10
L8UC1 008FA1	With Distributor	110	A = 50	60	15	h1=45	10
	None Distributor	50	B = 50	-	-	h2=45	10
L8UC1 508FA1	With Distributor	110	A = 50	60	15	h1=45	10
L6UH7 28FA0	With Distributor A-Circuit	60	A=30	30	15	h1=30	10
	With Distributor B-Circuit	45	A=30	15	15	h1=30	10
	None Distributor A-Circuit	50	B=50	-	-	h2=30	10



**CAUTION: Capacity is based on standard length and maximum allowance length is on the basis of reliability.**

**When outdoor unit is at higher elevation than the indoor units, after 24m of vertical height, 1 oil trap is**

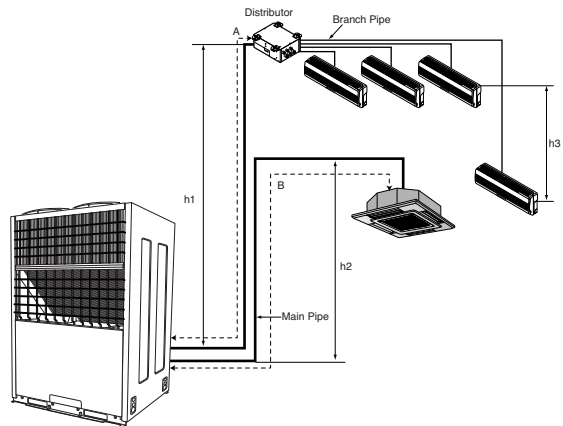

## Refrigerant piping

Perform the work according to the Service Manual or Installation Guide.

- Use two spanners when connecting the refrigerant pipe to the unit.
- Make a bend with a radius as large as possible.
- Perform air purge with R22 or vacuum drying.
- When piping work is finished, check all joints.

- Add refrigerant if piping over 7.5m as shown below, non distributor type.
- Add refrigerant if piping over 5m (main pipe), 7.5m (branch pipe) as shown below, distributor type.

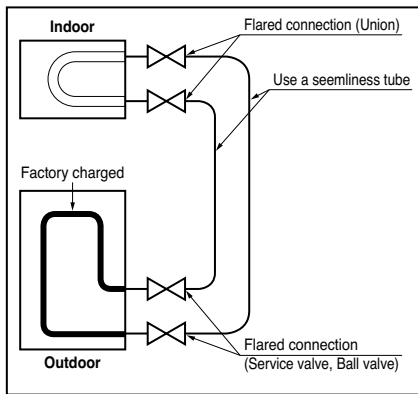

**Table. Distributor type**

		Pipe		Additional Refrigerant
		Gas	Liquid	
Main Pipe	24 kBtu/h	15.88	6.35	30g/m
	48/60 kBtu/h	19.05	9.52	50g/m
	90 kBtu/h	25.4	12.7	120g/m
Branch Pipe	12/18 kBtu/h	12.7	6.35	20g/m
	24/30/36 kBtu/h	15.88	6.35	30g/m
	48 kBtu/h	19.05	9.52	50g/m

**Table. Non Distributor type**

		Pipe		Additional Refrigerant
		Gas	Liquid	
Branch Pipe	12/18 kBtu/h	12.7	6.35	20g/m
	24/30/36 kBtu/h	15.88	6.35	30g/m
	48 kBtu/h	19.05	9.52	50g/m

## Indoor unit installation

### Wall Mounted Type

1. Route the indoor tubing and the drain hose in the direction of rear left or right

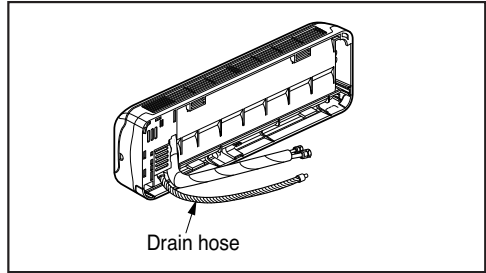

2. Tape the tubing, drain hose and the connecting cable. Be sure that the drain hose is located at the lowest side of the bundle. Locating at the upper side can cause drain pan to overflow inside the unit.

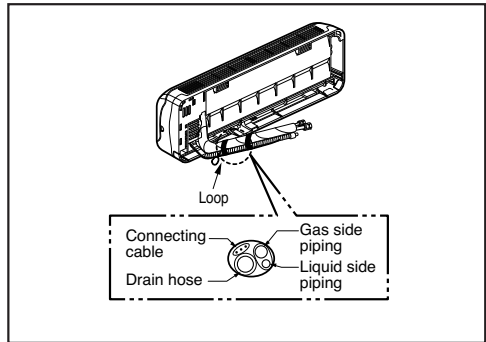

**CAUTION:** If the drain hose is routed inside the room, insulate the hose with an insulation material\* so that dripping from "sweating" (condensation) will not damage furniture or floors.

\*Foamed polyethylene or equivalent is recommended.

### Indoor unit installation

- Hook the indoor unit onto the upper portion of the installation plate. (Engage the two hooks of the rear top of the indoor unit with the upper edge of the installation plate.) Ensure that the hooks are properly seated on the installation plate by moving it left and right. Press the lower left and right sides of the unit against the installation plate until the hooks engage into their slots (clicking sound).

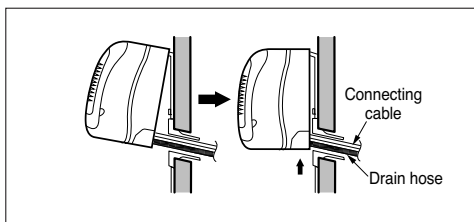

### Connecting the pipings to the indoor unit and drain hose to drain pipe

- Align the center of the pipings and sufficiently tighten the flare nut by hand.
- Tighten the flare nut with a wrench.

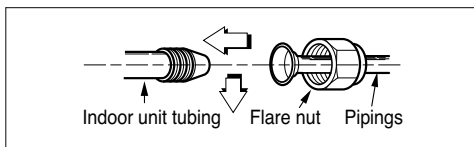

Outside diameter		Torque
mm	inch	kgf·cm
Ø6.35	1/4	180~250
Ø9.52	3/8	340~420
Ø12.7	1/2	550~560
Ø15.88	5/8	630~820
Ø19.05	3/4	990~1 210

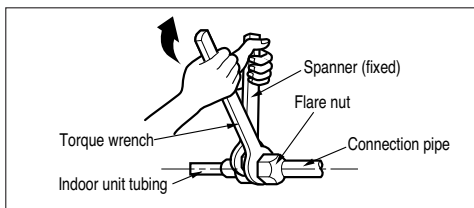

- When extending the drain hose at the indoor unit, install the drain pipe.

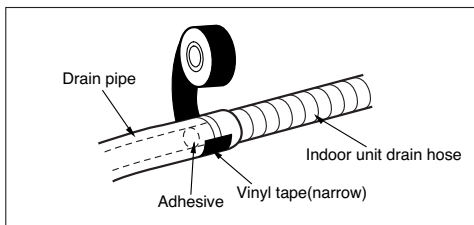

### Wrap the insulation material around the connecting portion.

- Overlap the connection pipe insulation material and the indoor unit pipe insulation material. Bind them together with vinyl tape so that there is no gap.
- Wrap the area which accommodates the rear piping housing section with vinyl tape.

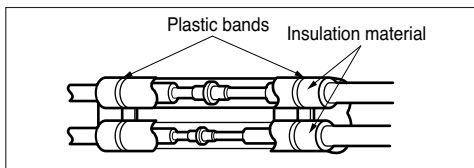

**NOTICE** : Recommended Insulation material

Material: FOAM PE

Thickness: 10mm

Density: less than 0.032 ±0.005(g/cm<sup>3</sup>)

Thermal conductivity: less than 0.03  
(kcal/m·h·°C)

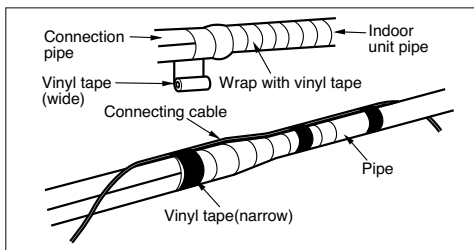

3. Bundle the piping and drain hose together by wrapping them with vinyl tape over the range within which they fit into the rear piping housing section.

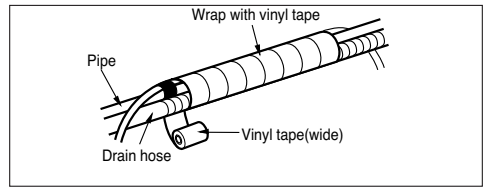

**!** **CAUTION: Installation Information (For right piping)**  
For right piping, follow the instruction below.

### Good case

- Press on the upper side of clamp and unfold the tubing to downward slowly.

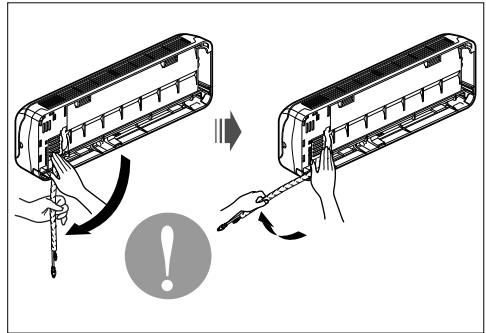

### Bad case

- Following bending type from left to right could cause problem of pipe damage.

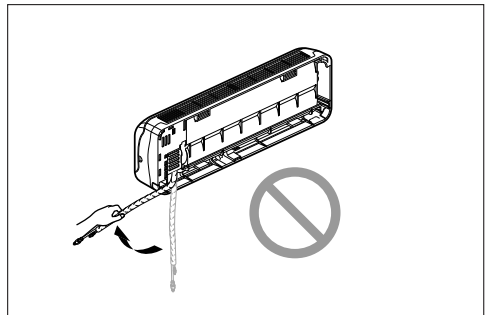

### ■ How to fix installation plate

The wall you select should be strong and solid enough to prevent vibration

1. Mount the installation plate on the wall with type "A" screws. If mounting the unit on a concrete wall, use anchor bolts.
  - Mount the installation plate horizontally by aligning the centerline using a level.

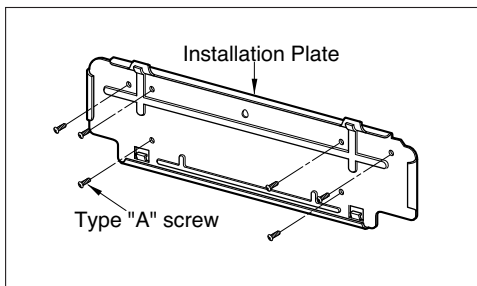

2. Measure the wall and mark the centerline. It is also important to use caution concerning the location of the installation plate—routing of the wiring to power outlets is through the walls typically. Drilling the hole through the wall for piping connections must be done safely.

(SR, ST, SU)

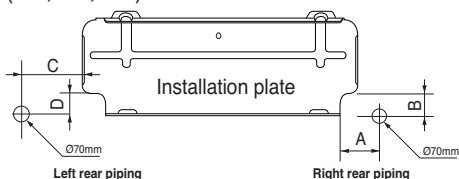

(S3)

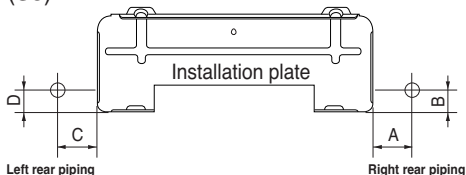

CHASSIS (Capacity)	Distance (mm)			
	A	B	C	D
SR(12 kBtu/h)	0	40	20	40
ST(18 kBtu/h~24 kBtu/h)	105	0	210	0
SU(12 kBtu/h)	92	44	67	44
S3(18 kBtu/h~24 kBtu/h)	58	3	292	3

### ■ Drill a hole in the wall

- Drill the piping hole with a  $\varnothing 70\text{mm}$  hole core drill. Drill the piping hole at either the right or the left with the hole slightly slanted to the outdoor side.

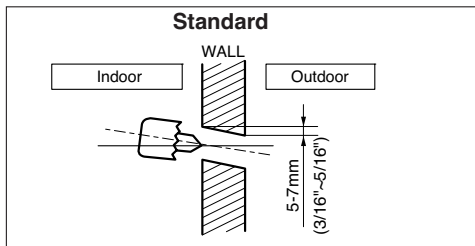

## Duct Type

### ■ Installation of Unit

Install the unit above the ceiling correctly.

#### CASE 1

##### POSITION OF SUSPENSION BOLT

- Apply a joint-canvas between the unit and duct to absorb unnecessary vibration.
- Apply a filter Accessory at air return hole.

(Unit:mm)

Dimension Capacity	A	B	C	D	E	F	(G)	H	I
18 kBtu/h 24 kBtu/h	932	880	355	45.5	450	30	87	750	163
30 kBtu/h 36 kBtu/h	1 232	1 180	355	45.5	450	30	87	830	186
48 kBtu/h	1 292	1 230	477	56	590	30	120	1 006	294

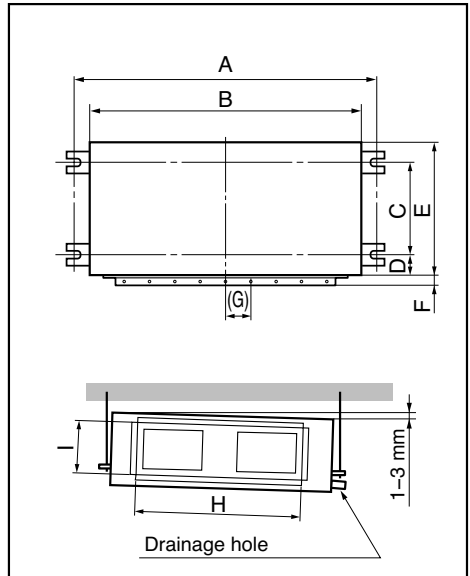

#### CASE 2

- Install the unit leaning to a drainage hole side as a figure for easy water drainage.

##### POSITION OF CONSOLE BOLT

- A place where the unit will be leveled and that can support the weight of the unit.
- A place where the unit can withstand its vibration.
- A place where service can be easily performed.

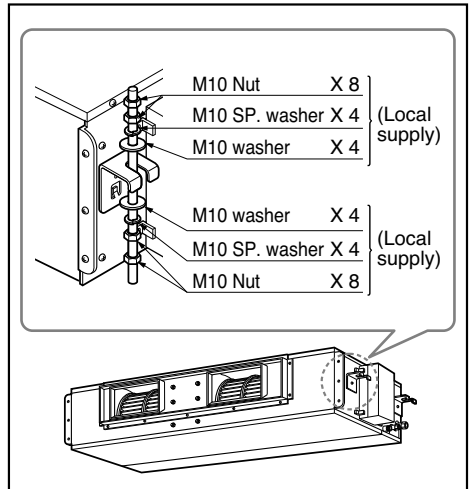

- Select and mark the position for fixing bolts.
- Drill the hole for set anchor on the face of ceiling.

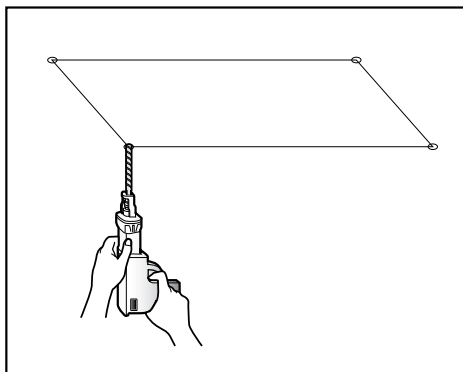

- Insert the set anchor and washer onto the suspension bolts for locking the suspension bolts on the ceiling.
- Mount the suspension bolts to the set anchor firmly.
- Secure the installation plates onto the suspension bolts (adjust level roughly) using nuts, washers and spring washers.

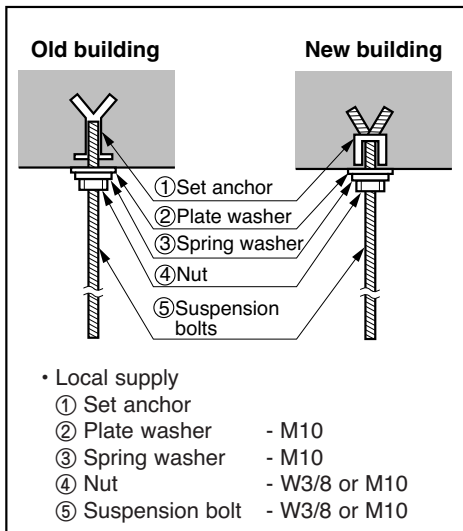

**CAUTION:** Tighten the nut and bolt to prevent unit falling

- CAUTION:**
1. Install declination of the indoor unit is very important for the drain of the duct type air conditioner.
  2. Minimum thickness of the insulation for the connecting pipe shall be 10mm.

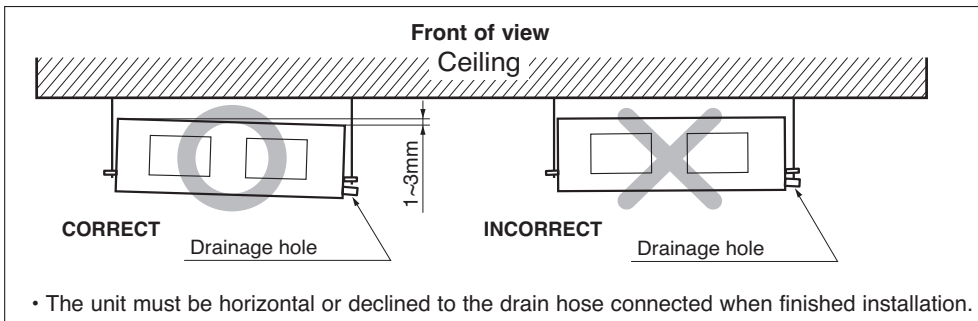



## Caution for gradient of unit and drain piping

Lay the drain hose with a downward inclination so water will drain out.

- Always lay the drain with downward inclination (1/50 to 1/100). Prevent any upward flow or reverse flow in any part.
- 5mm or thicker formed thermal insulator shall always be provided for the drain pipe.

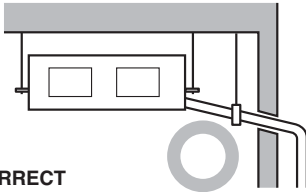
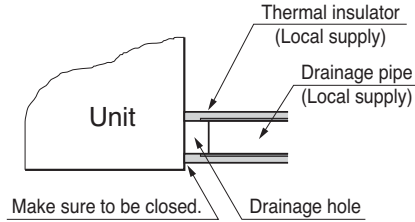

- Upward routing not allowed

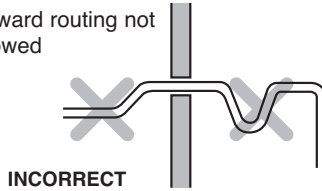

- Install the P-Trap (or U-Trap) to prevent a water leakage caused by the blocking of intake air filter.

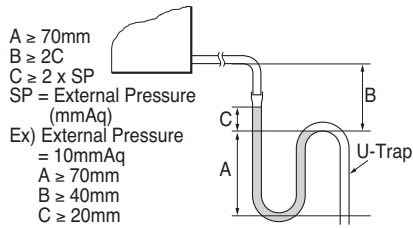

### Applied U-Trap Dimension

- Drill the piping hole with 70mm dia, hole core drill.
- Piping hole should be slightly slant to the outdoor side.

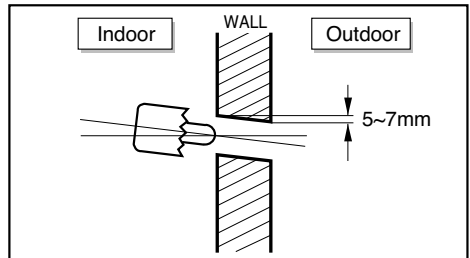

## Insulation, others

Insulate the joint and tubes completely.

### THERMAL INSULATION

All thermal insulation must comply with local requirement.

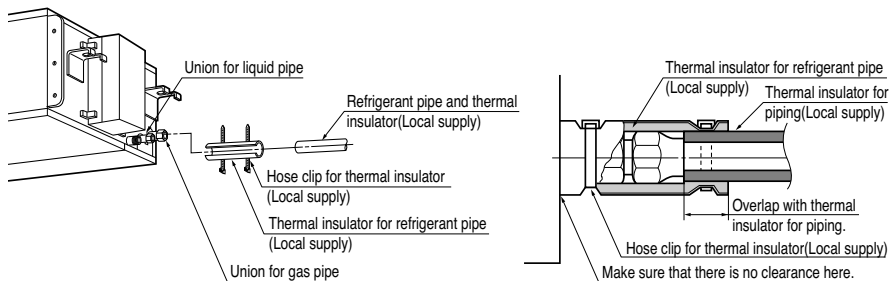

### REFRIGERANT PIPE

- Insulate and tape the gas piping.

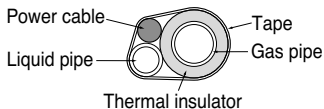

### TEST AND CHECK

■ **After all workings are finished, check the working and operation.**

- Air distribution \_\_\_\_\_ Is the air circulation good?
- Drain \_\_\_\_\_ Is the drainage smooth and no sweating?
- Gas leakage \_\_\_\_\_ Is the piping connection correct?
- Wiring \_\_\_\_\_ Is the wiring connection correct?
- Lock-bolt \_\_\_\_\_ Is the lock-bolt of compressor loosened?

## installation of remote control box

Install the remote control box and cord correctly.

### POINT OF REMOTE CONTROLLER INSTALLATION

- Although the room temperature sensor is in the indoor unit, the remote control box should be installed in such places away from direct sunlight and high humidity.

### INSTALLATION OF THE REMOTE CONTROL BOX

- Select places that is not splashed by water.
- Select control position after receiving customer approval.
- The room temperature sensor of the thermostat for temperature control is built in the indoor unit.
- This remote controller equipped with liquid crystal display. If this position is higher or lower, display is difficult to see.  
(The standard height is 1.2~1.5m high)

### ROUTING OF THE REMOTE CONTROL CORD

- Keep the remote control cord away from the refrigerant piping and the drain piping.
- To protect the remote control cord from electrical noise, place the cord at least 5cm away from other power cables. (Audio equipment, Television set, etc)
- If the remote control cord is secured to a wall, provide a trap at the top of the cord to prevent water droplets from running.

### ELECTRICAL WIRING TO THE INDOOR UNIT

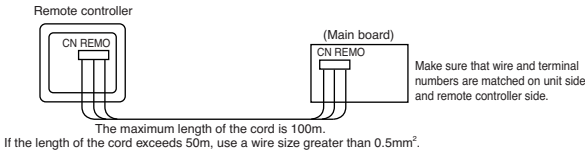

### DISASSEMBLING OF THE REMOTE CONTROLLER

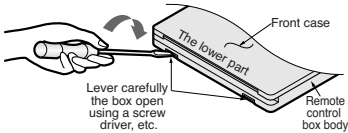

### WHEN THE REMOTE CONTROL BOX IS INSTALLED WITH THE CORD EXPOSED.

#### PROCEDURE OF INSTALLATION

- Fix the under plate on the wall by self tapping screws (accessory).
- Make a slit (Part A) at the top side of the remote control box by nipper.
- Route the cord as shown in the following figure. In this case, push the cord into the around of case (Part B).
- Hook the remote control unit on the under plate.

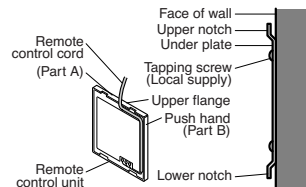

#### FIXING OF REMOTE CONTROL CORD

- Fix the cord clamps on the wall by  $\phi 3$  tapping screws (Local supply).
- Fix the remote control cord.

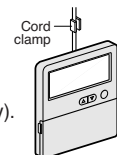

### WHEN THE REMOTE CONTROL BOX IS INSTALLED WITH THE CORD BURIED.

#### PROCEDURE OF INSTALLATION

- Fix the under plate on the switch box by screws (Local supply). In this case, fit the under plate on the wall, and be careful of deformation.
- Receive the remote control cord in the switch box.
- Hook the remote control unit on the under plate.

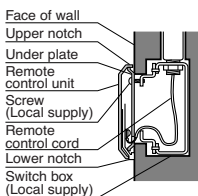

## Wired remote controller installation

- Since the room temperature sensor is in the remote controller, the remote controller box should be installed in a place away from direct sunlight, high humidity and direct supply of cold air to maintain proper space temperature.

Install the remote controller about 5ft(1.5m) above the floor in an area with good air circulation at an average temperature.

### Do not install the remote controller where it can be affected by:

- Drafts, or dead spots behind doors and in corners.
- Hot or cold air from ducts.
- Radiant heat from sun or appliances.
- Concealed pipes and chimneys.
- Uncontrolled areas such as an outside wall behind the remote controller.
- This remote controller is equipped with a seven segment LED. display. For proper display of the remote controller LED's, the remote controller should be installed properly as shown in Fig.1.  
(The standard height is 1.2~1.5 m from floor level.)

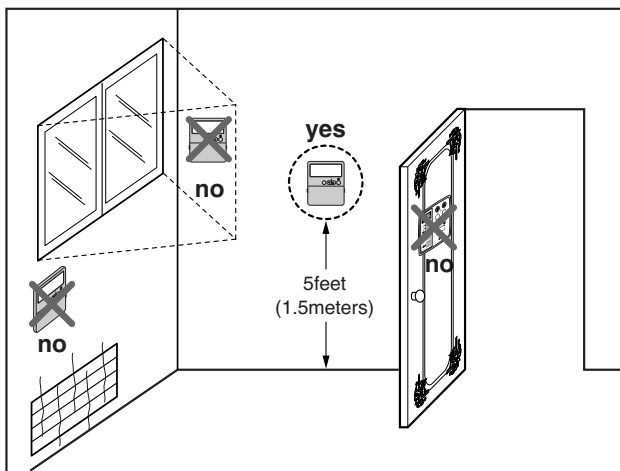
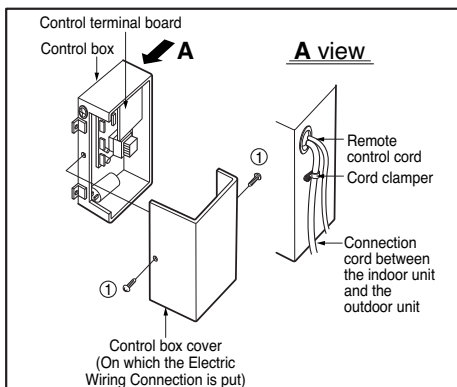

Fig.1 Typical locations for remote controller

### WIRING CONNECTION

- Remove the control box cover for electrical connection between the indoor and outdoor unit.  
(Remove screws ①.)
- Use the cord clammer to fix the cord.



## CST Type

- The dimensions of the paper model for installing are the same as those of the ceiling opening dimensions.
- Select and mark the position for fixing bolts and piping hole.
- Decide the position for fixing bolts slightly tilted to the drain direction after considering the direction of drain hose.
- Drill the hole for anchor bolt on the wall.

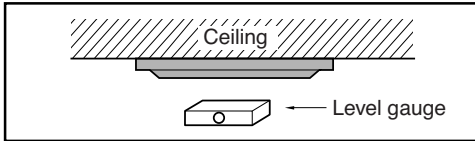

### CAUTION:

- This air-conditioner uses a drain pump.
- Horizontally install the unit using a level gauge.
- During the installation, care should be taken not to damage electric wires.

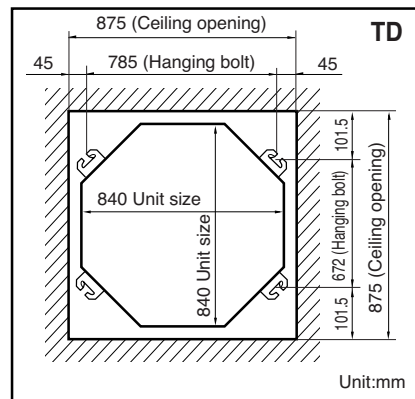
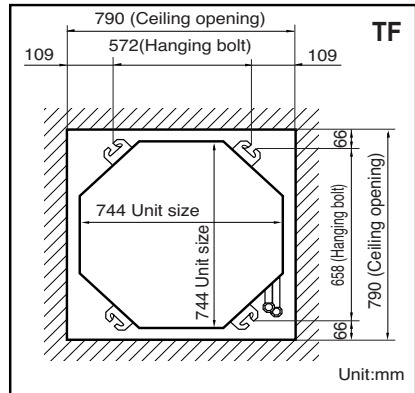
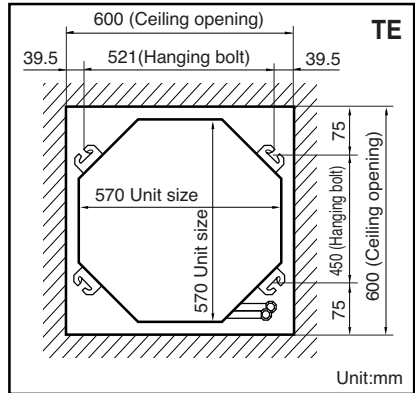
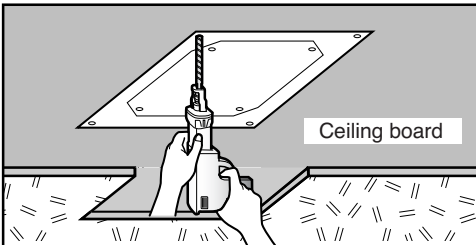

**NOTICE**

- Thoroughly study the following installation locations:
  1. In such places as restaurants and kitchens, considerable amount of oil steam and flour adhere to the turbo fan, the fin of the heat exchanger and the drain pump, resulting in heat exchange reduction, spraying, dispersing of water drops, drain pump malfunction, etc. In these cases, take the following actions:
    - Make sure that the ventilation fan for smoke-collecting hood on a cooking table has sufficient capacity so that it draws oily steam which should not flow into the suction of the air conditioner.
    - Make enough distance from a cooking room to install the air conditioner in such a place where it may not suck in oily steam.

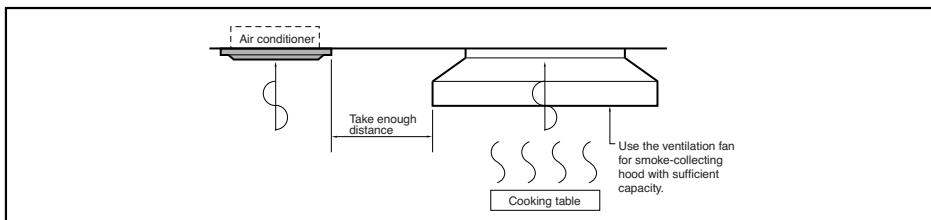

2. Avoid installing air conditioner in such circumstances where cutting oil mist or iron powder is in suspension in factories, etc.
3. Avoid places where inflammable gas is generated, flows in, is stored or vented.
4. Avoid places where sulfurous acid gas or corrosive gas is generated.
5. Avoid places near high frequency generators.

**■ The Indoor Unit Installation**

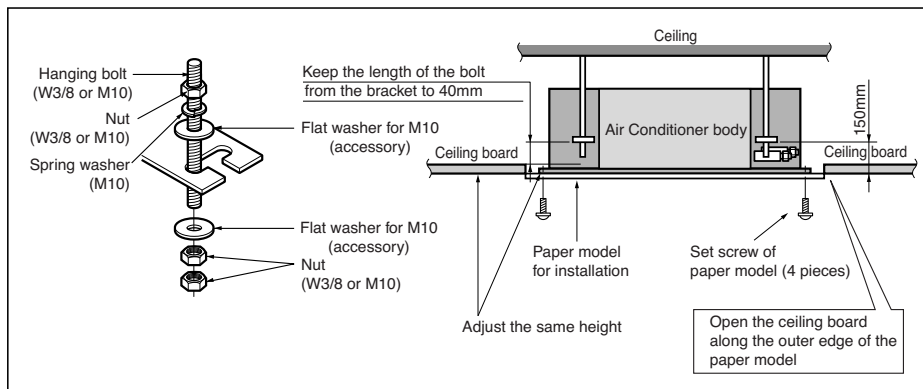

- The following parts is option.
- Hanging Bolt   - W 3/8 or M10
- Nut             - W 3/8 or M10
- Spring Washer   - M10
- Plate Washer    - M10

- Drill the piping hole on the wall slightly tilted to the outdoor side using a  $\varnothing 70$  hole-core drill.



**CAUTION: Tighten the nut and bolt to prevent unit falling.**

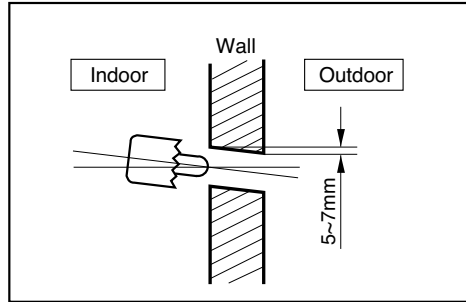

## ■ Remote Controller Installation

- **Although the room temperature sensor is in the indoor unit, the remote controller should be installed in such places away from direct sunlight and high humidity.**

### Installation of the remote controller

- Select places that are not splashed with water.
- Select control position after receiving customer approval.
- The room temperature sensor is built in the indoor unit.
- This remote controller equipped with liquid crystal display. If this position is higher or lower, display is difficult to see. (The standard height is 1.2 ~ 1.5m high)

### Routing of the remote controller cord

- Keep the remote controller cord away from the refrigerant piping and the drain piping.
- To protect the remote controller cord from electrical noise, place the cord at least 5cm away from other power cables (audio equipment, television set, etc.)
- If the remote controller cord is secured to the wall, provide a trap at the top of the cord to prevent water droplets from running.

## ■ WIRED REMOTE CONTROL INSTALLATION

### DISASSEMBLING

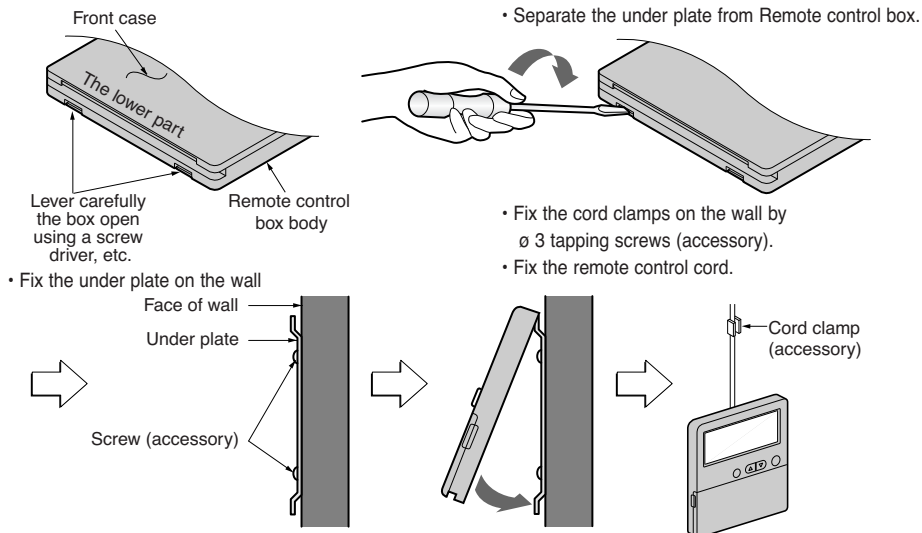

### ELECTRICAL WIRING

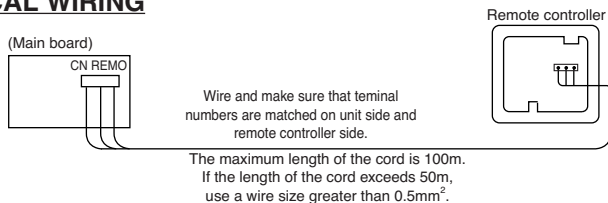

## ■ Remote Control Preparation(OPTIONAL)

### HOW TO MOUNT ONTO A WALL

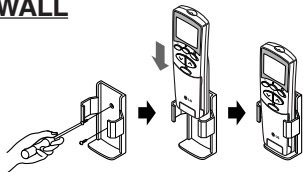

### HOW TO INSERT BATTERIES

- 1 Remove the battery cover from the remote controller.
  - Slide the cover according to the arrow direction.
- 2 Insert the two batteries.
  - Be sure that the (+) and (-) directions are correct.
  - Be sure that both batteries are new.
- 3 Re-attach the cover.
  - Slide it back into position.

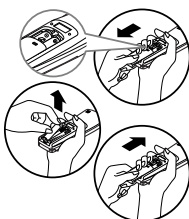

- Do not use rechargeable batteries, such batteries differ from standard dry cells in shape, dimensions, and performance.
- Remove the batteries from the remote controller if the air conditioner is not going to be used for some long time.



## ■ Wiring Connection

- Open the control box cover and connect the Remote controller cord and Indoor power

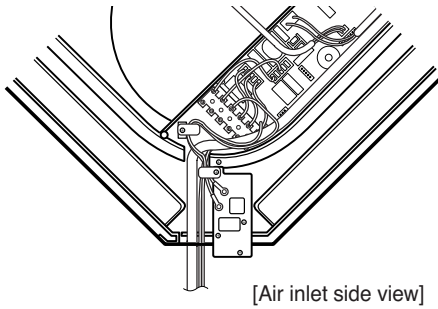
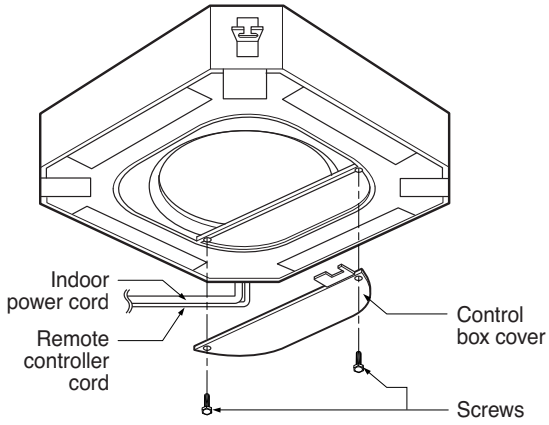

## ■ Installation of Decorative Panel

The decorative panel has its installation direction.

Before installing the decorative panel, always remove the paper template.

1. Temporarily fix two decorative panel fixing screws (hexagon M5 screw) on the unit body. (Tighten by amount 10mm in length.)  
The fixing screws (hexagon M5 screw) are included the decorative panel box.
2. Remove the air inlet grille from the decorative panel. (Remove the hook for the air inlet grille cord.)
3. Hook the decorative panel key hole (  ) on the screws fixed in step above, and slide the panel so that the screws reach the key edge.
4. Retighten completely two temporarily fixed screws and other two screws. (Total 4 screws)
5. Connect the louver motor connector and display connector.
6. After tightening these screws, install the air inlet grille (including the air filter).

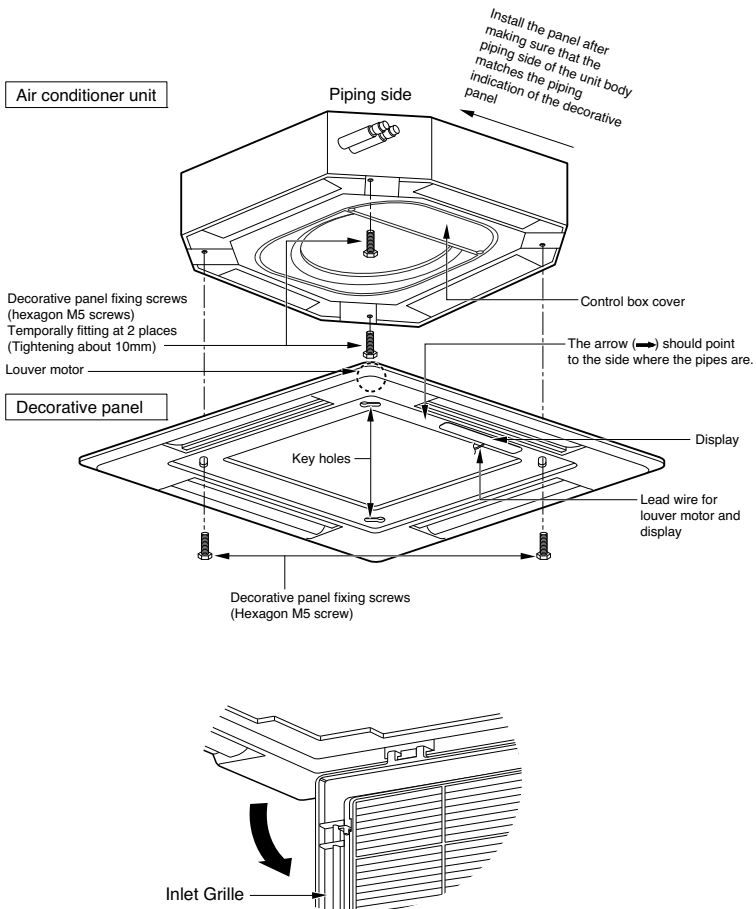

**CAUTION:** Install certainly the decorative panel.  
Cool air leakage causes sweating. □ Water drops fall.

Good example

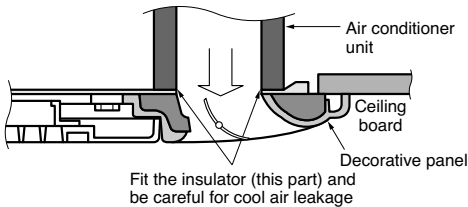

Bad example

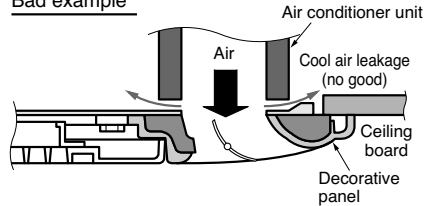

## ■ Indoor Unit Drain Piping

- Drain piping must have down-slope (1/50 to 1/100): be sure not to provide up-and-down slope to prevent reversal flow.
- During drain piping connection, be careful not to exert extra force on the drain port on the indoor unit.
- The outside diameter of the drain connection on the indoor unit is 32mm.

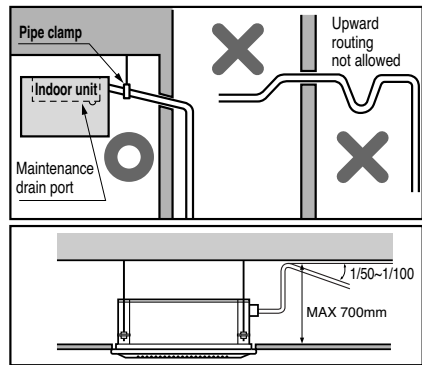

Piping material: Polyvinyl chloride pipe VP-25 and pipe fittings

- Be sure to execute heat insulation on the drain piping.

Heat insulation material: Polyethylene foam with thickness more than 8 mm.

## DRAIN TEST

The air conditioner uses a drain pump to drain water.  
Use the following procedure to test the drain pump operation:

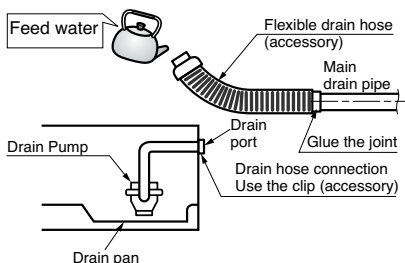

- Connect the main drain pipe to the exterior and leave it provisionally until the test comes to an end.
- Feed water to the flexible drain hose and check the piping for leakage.
- Be sure to check the drain pump for normal operating and noise when electrical wiring is complete.
- When the test is complete, connect the flexible drain hose to the drain port on the indoor unit.

## HEAT INSULATION

1. Use the heat insulation material for the refrigerant piping which has an excellent heat-resistance (over 120°C).

2. Precautions in high humidity circumstance:

This air conditioner has been tested according to the "KS Standard Conditions with Mist" and confirmed that there is not any default. However, if it is operated for a long time in high humid atmosphere (dew point temperature: more than 23°C), water drops are liable to fall. In this case, add heat insulation material according to the following procedure:

- Heat insulation material to be prepared... Adiabatic glass wool with thickness 10 to 20mm.
- Stick glass wool on all air conditioners that are located in ceiling atmosphere.

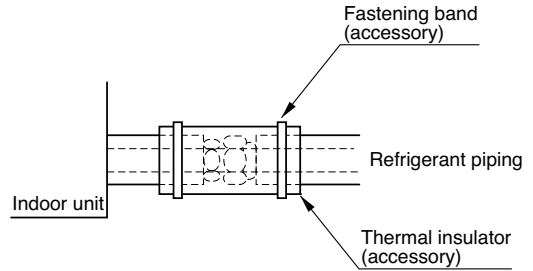

# Flaring Work and Connection of Piping

## Flaring work

### Preparation of Piping

Main cause of gas leakage is defect in flaring work. Carry out correct flaring work in the following procedure.

#### 1. Cut the pipes and the cable.

- Use the accessory piping kit or the pipes purchased locally.
- Measure the distance between the indoor and the outdoor unit.
- Cut the pipes a little longer than measured distance.
- Cut the cable 1.5m longer than the pipe length.

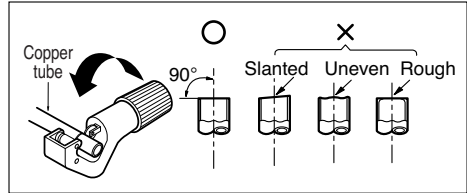

#### 2. Burrs removal

- Completely remove all burrs from the cut cross section of pipe/tube.
- Put the end of the copper tube/pipe to downward direction as you remove burrs in order to avoid to let burrs drop in the tubing.

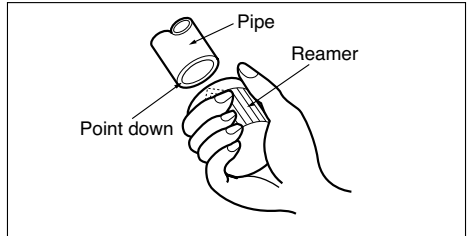

#### 3. Putting nut on

- Remove flare nuts attached to indoor and outdoor units, then put them on pipe/tube having completed burr removal. (Not possible to put them on after flaring work)

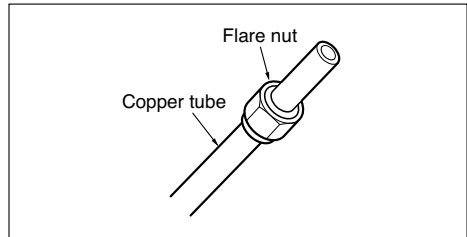

#### 4. Flaring work

- Carry out flaring work using dedicated flaring tool for R-22 as shown below.

Outside diameter		A
mm	inch	mm
Ø6.35	1/4	1.1~1.3
Ø9.52	3/8	1.5~1.7
Ø12.7	1/2	1.6~1.8
Ø15.88	5/8	1.6~1.8
Ø19.05	3/4	1.9~2.1

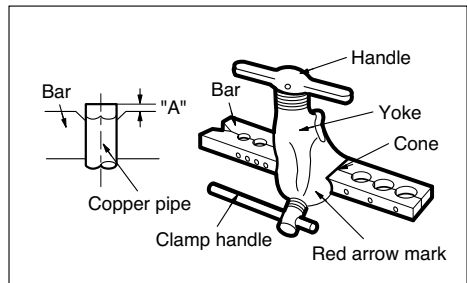

Firmly hold copper tube in a bar(or die) as indicated dimension in the table above.

### 5. Check

- Compare the flared work with figure below.
- If flare is noted to be defective, cut off the flared section and do flaring work again.

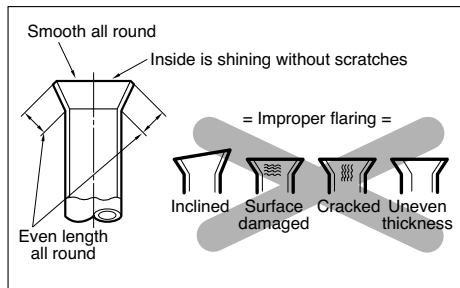

## Piping Connection

1. Form the piping according to its routing. Avoid bending and bending back the same piping point more than three times. (This will result in hardening the pipe.)
2. After deforming the piping, align centers of the union fitting of the indoor unit and the piping, and tighten them firmly with wrenches.
3. Connect pipe to the service valve, ball valve or short tube(only 48k) which is located.
4. After completing the piping connection, be sure to check if there is gas leakage in indoor and outdoor connection.

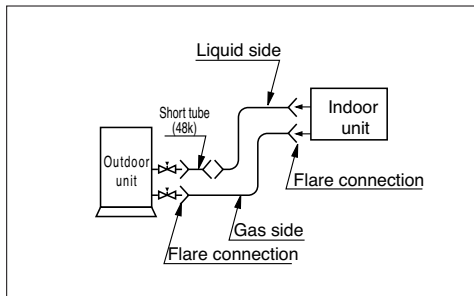

### Vacuum drying

After completing the piping connection, execute vacuum drying for the connecting piping and the indoor unit.

The vacuum drying must be carried out using the service ports of both the liquid and gas side valves.

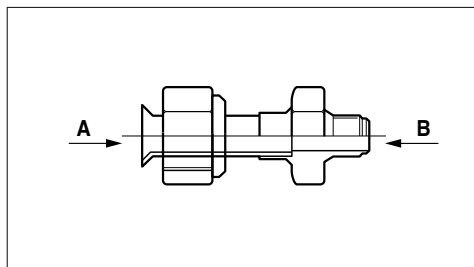

### Connection of the pipes-Outdoor

1. When piping installation work you must be used the connector.

Capacity	Gas	
	A	B
24/30/36 kBtu/h	Ø12.7(1/2")	Ø15.88(5/8")

#### Connecting pipe size

Capacity	Gas side	Liquid side
12/18 kBtu/h	Ø12.7(1/2")	Ø6.35(1/4")
24/30/36 kBtu/h	Ø15.88(5/8")	Ø6.35(1/4")
48 kBtu/h	Ø19.05(3/4")	Ø9.52(3/8")

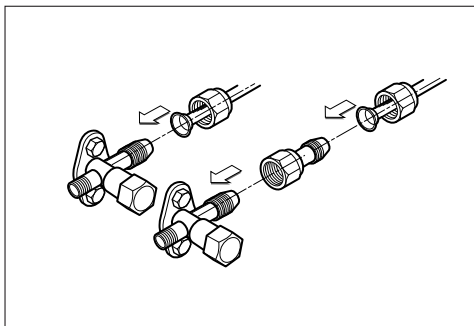

2. Align the center of the pipings and sufficiently tighten the flare nut by hand
3. Finally, tighten the flare nut with torque wrench until the wrench clicks.

- When tightening the flare nut with torque wrench, ensure the direction for tightening follows the arrow on the wrench.





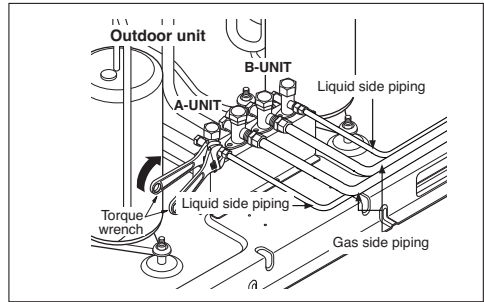

**CAUTION: Use two wrenches and tighten with regular torque.**

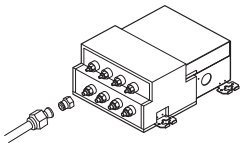
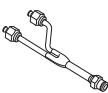

Outside diameter		Torque
mm	inch	kgf·cm
Ø6.35	1/4	180~250
Ø9.52	3/8	340~420
Ø12.7	1/2	550~560
Ø15.88	5/8	630~820
Ø19.05	3/4	990~1 210

## Accessory For Installation

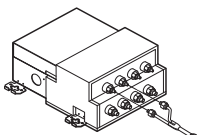
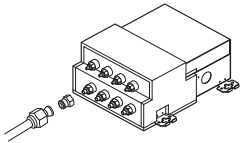
\* Below mentioned "P/NO" is assembly p/no for the respective models.  
and this part no. Exist in the respective "Model"

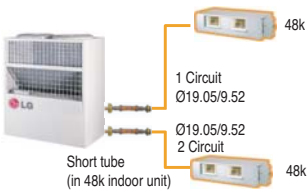
Model	P/No.	Figure	Guide
LMNC(H)246BHA0 LMNC(H)246LTL(A)0 LMNC(H)246TFC(A)0 LMNC(H)246BYG0	5162A20011E		 <p>Use this socket, when ID Unit is joined with BD Unit(gas side)</p>
LMNC(H)306BGA0 LMNC(H)306TFC(A)0 LMNC(H)366BGA0 LMNC(H)366TDC(A)0 LMNC486BRA0	5001A21007A 5001A21007B	<p>① </p> <p>② </p> <p>③ </p>	<p>①   Use this Y branch, when ID Unit is joined with BD Unit (liquid side)</p> <p>②   Use this connector, when ID Unit is joined with BD Unit(gas side)</p> <p>③ Use this connector at vacancy gas side BD Unit to seal up</p>
LMNC(H)486BEA0 LMNC(H)486TDC(A)0 LMNH486BRA0	5211A21343B		 <p>Use shorttube, when install 48kBtu/h ID Unit(100K OD UNIT OR L6UH728FA0)</p>



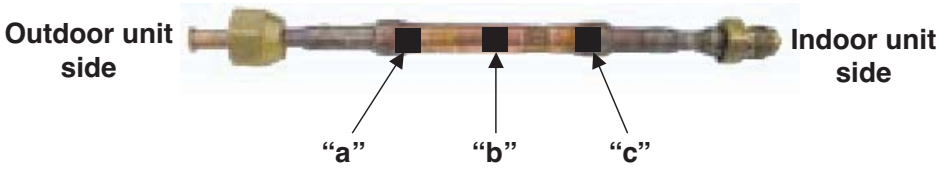

Outdoor unit	36K Indoor			48K Indoor			48K Indoor		
	a	b	c	a	b	c	a	b	c
L4UC608FA0		073							
L5UC728FA0				079		079			
L6UH728FA0, L8UC(H)1008FA0							085		096

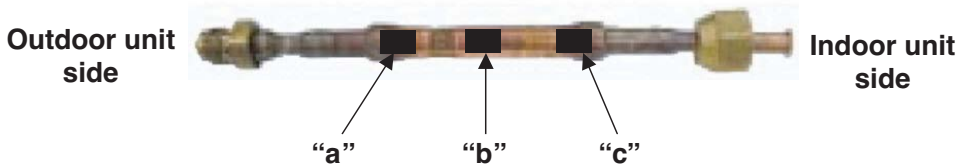

Outdoor unit	48K Indoor		
	a	b	c
L5UC728FA1 / L8UC1008FA1	079		079

# Installation Example

- Connection of Piping and Wiring for 30k, 36k Indoor Unit

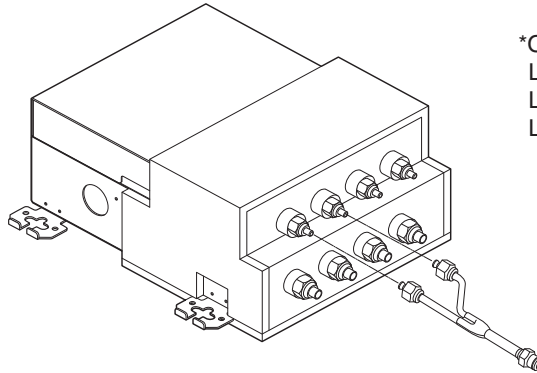

\*Outdoor Unit  
 L8UH1008FA0  
 L8UC1008FA0  
 L8UC1008FA1

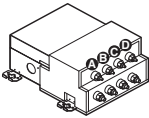
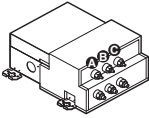
 <b>PMBD5440L</b>	<p><b>Case 1</b></p> <table border="1" style="width: 100%; border-collapse: collapse;"> <thead> <tr> <th>Room</th> <th>Indoor Unit</th> <th>Gas side</th> <th>Liquid side</th> <th>Wiring</th> </tr> </thead> <tbody> <tr> <td>A</td> <td>30K</td> <td>use socket</td> <td rowspan="2">Y connector</td> <td>A</td> </tr> <tr> <td>B</td> <td>-</td> <td>-</td> <td>No use</td> </tr> <tr> <td>C</td> <td>12K</td> <td>normal</td> <td>normal</td> <td>C</td> </tr> <tr> <td>D</td> <td>12K</td> <td>normal</td> <td>normal</td> <td>D</td> </tr> </tbody> </table> <p><b>Case 2</b></p> <table border="1" style="width: 100%; border-collapse: collapse;"> <thead> <tr> <th>Room</th> <th>Indoor Unit</th> <th>Gas side</th> <th>Liquid side</th> <th>Wiring</th> </tr> </thead> <tbody> <tr> <td>A</td> <td>12K</td> <td>normal</td> <td>normal</td> <td>A</td> </tr> <tr> <td>B</td> <td>12K</td> <td>normal</td> <td>normal</td> <td>B</td> </tr> <tr> <td>C</td> <td>30K</td> <td>Use socket</td> <td rowspan="2">Y connector</td> <td>C</td> </tr> <tr> <td>D</td> <td>-</td> <td>-</td> <td>No use</td> </tr> </tbody> </table> <p><b>* 30K Indoor Unit wire must connect 'A' or 'C' room.</b></p>	Room	Indoor Unit	Gas side	Liquid side	Wiring	A	30K	use socket	Y connector	A	B	-	-	No use	C	12K	normal	normal	C	D	12K	normal	normal	D	Room	Indoor Unit	Gas side	Liquid side	Wiring	A	12K	normal	normal	A	B	12K	normal	normal	B	C	30K	Use socket	Y connector	C	D	-	-	No use																																															
Room	Indoor Unit	Gas side	Liquid side	Wiring																																																																																												
A	30K	use socket	Y connector	A																																																																																												
B	-	-		No use																																																																																												
C	12K	normal	normal	C																																																																																												
D	12K	normal	normal	D																																																																																												
Room	Indoor Unit	Gas side	Liquid side	Wiring																																																																																												
A	12K	normal	normal	A																																																																																												
B	12K	normal	normal	B																																																																																												
C	30K	Use socket	Y connector	C																																																																																												
D	-	-		No use																																																																																												
 <b>PMBD5430L</b>	<p><b>Case 1</b></p> <table border="1" style="width: 100%; border-collapse: collapse;"> <thead> <tr> <th>Room</th> <th>Indoor Unit</th> <th>Gas side</th> <th>Liquid side</th> <th>Wiring</th> </tr> </thead> <tbody> <tr> <td>A</td> <td>30K</td> <td>Use socket</td> <td rowspan="2">Y connector</td> <td>A</td> </tr> <tr> <td>B</td> <td>-</td> <td>-</td> <td>No use</td> </tr> <tr> <td>C</td> <td>12K</td> <td>normal</td> <td>normal</td> <td>C</td> </tr> </tbody> </table> <p><b>Case 2</b></p> <table border="1" style="width: 100%; border-collapse: collapse;"> <thead> <tr> <th>Room</th> <th>Indoor Unit</th> <th>Gas side</th> <th>Liquid side</th> <th>Wiring</th> </tr> </thead> <tbody> <tr> <td>A</td> <td>30K</td> <td>Use socket</td> <td rowspan="2">Y connector</td> <td>A</td> </tr> <tr> <td>B</td> <td>-</td> <td>-</td> <td>No use</td> </tr> <tr> <td>C</td> <td>18K</td> <td>normal</td> <td>normal</td> <td>C</td> </tr> </tbody> </table> <p><b>Case 3</b></p> <table border="1" style="width: 100%; border-collapse: collapse;"> <thead> <tr> <th>Room</th> <th>Indoor Unit</th> <th>Gas side</th> <th>Liquid side</th> <th>Wiring</th> </tr> </thead> <tbody> <tr> <td>A</td> <td>30K</td> <td>Use socket</td> <td rowspan="2">Y connector</td> <td>A</td> </tr> <tr> <td>B</td> <td>-</td> <td>-</td> <td>No use</td> </tr> <tr> <td>C</td> <td>24K</td> <td>Use socket</td> <td>normal</td> <td>C</td> </tr> </tbody> </table> <p><b>Case 4</b></p> <table border="1" style="width: 100%; border-collapse: collapse;"> <thead> <tr> <th>Room</th> <th>Indoor Unit</th> <th>Gas side</th> <th>Liquid side</th> <th>Wiring</th> </tr> </thead> <tbody> <tr> <td>A</td> <td>36K</td> <td>Use socket</td> <td rowspan="2">Y connector</td> <td>A</td> </tr> <tr> <td>B</td> <td>-</td> <td>-</td> <td>No use</td> </tr> <tr> <td>C</td> <td>12K</td> <td>normal</td> <td>normal</td> <td>C</td> </tr> </tbody> </table> <p><b>Case 5</b></p> <table border="1" style="width: 100%; border-collapse: collapse;"> <thead> <tr> <th>Room</th> <th>Indoor Unit</th> <th>Gas side</th> <th>Liquid side</th> <th>Wiring</th> </tr> </thead> <tbody> <tr> <td>A</td> <td>36K</td> <td>Use socket</td> <td rowspan="2">Y connector</td> <td>A</td> </tr> <tr> <td>B</td> <td>-</td> <td>-</td> <td>No use</td> </tr> <tr> <td>C</td> <td>18K</td> <td>normal</td> <td>normal</td> <td>C</td> </tr> </tbody> </table> <p><b>* 30K, 36K Indoor Unit wire must connect 'A' room</b></p>	Room	Indoor Unit	Gas side	Liquid side	Wiring	A	30K	Use socket	Y connector	A	B	-	-	No use	C	12K	normal	normal	C	Room	Indoor Unit	Gas side	Liquid side	Wiring	A	30K	Use socket	Y connector	A	B	-	-	No use	C	18K	normal	normal	C	Room	Indoor Unit	Gas side	Liquid side	Wiring	A	30K	Use socket	Y connector	A	B	-	-	No use	C	24K	Use socket	normal	C	Room	Indoor Unit	Gas side	Liquid side	Wiring	A	36K	Use socket	Y connector	A	B	-	-	No use	C	12K	normal	normal	C	Room	Indoor Unit	Gas side	Liquid side	Wiring	A	36K	Use socket	Y connector	A	B	-	-	No use	C	18K	normal	normal	C
Room	Indoor Unit	Gas side	Liquid side	Wiring																																																																																												
A	30K	Use socket	Y connector	A																																																																																												
B	-	-		No use																																																																																												
C	12K	normal	normal	C																																																																																												
Room	Indoor Unit	Gas side	Liquid side	Wiring																																																																																												
A	30K	Use socket	Y connector	A																																																																																												
B	-	-		No use																																																																																												
C	18K	normal	normal	C																																																																																												
Room	Indoor Unit	Gas side	Liquid side	Wiring																																																																																												
A	30K	Use socket	Y connector	A																																																																																												
B	-	-		No use																																																																																												
C	24K	Use socket	normal	C																																																																																												
Room	Indoor Unit	Gas side	Liquid side	Wiring																																																																																												
A	36K	Use socket	Y connector	A																																																																																												
B	-	-		No use																																																																																												
C	12K	normal	normal	C																																																																																												
Room	Indoor Unit	Gas side	Liquid side	Wiring																																																																																												
A	36K	Use socket	Y connector	A																																																																																												
B	-	-		No use																																																																																												
C	18K	normal	normal	C																																																																																												

\* The Socket converts Pipe size Ø12.7 to Ø15.88.

• Connection of Piping and Wiring for 48k Indoor Unit

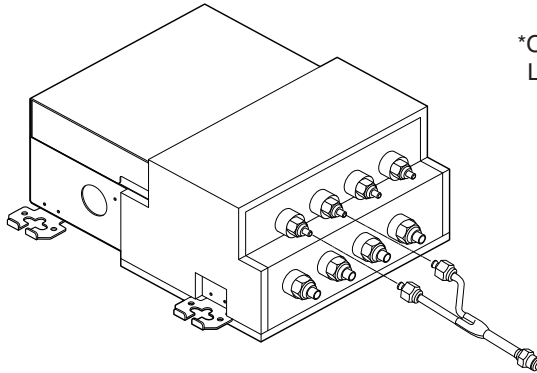

\*Outdoor Unit  
L8UC1508FA1

FEATURE & SIZE	<p>Y CONNECTOR (LIQUID PIPING)</p>	<p>SOCKET (GAS PIPING)</p>	
	<p>APPLIED MODEL</p> <p>INDOOR UNIT : LMNC486BRA0, LMNC486TDA(C)0 OUTDOOR UNIT : L8UC1508FA1</p>		
<p>PIPING &amp; WIRING CONNECTION</p>	<p>1. Use this accessory for distributor piping. (see figure below)</p> <p>2. Use this accessory only for LMNC486BRA0 and LMNC486TDA(C)0 model.</p> <p>3. Socket can be used for gas piping connection. For example; If Y connector is fitted in A &amp; B liquid piping, then use socket for A, keeping B closed or vice-versa.</p> <p>4. Use only A or C terminal for wiring, when Y connector is used. (see figure below)</p>		
	<p>WIRING</p> <p>PIPING (LIQUID)</p>	<p>2 ROOM</p>	<p>3 ROOM</p>

**Models: L5UC728FA0(1), L6UH728FA0, L8UC(H)1008FA0(1)**

• CASE 1(4ROOM/CYCLE)

\*Outdoor Unit  
L8UH1008FA0  
L8UC1008FA0  
L8UC1008FA1

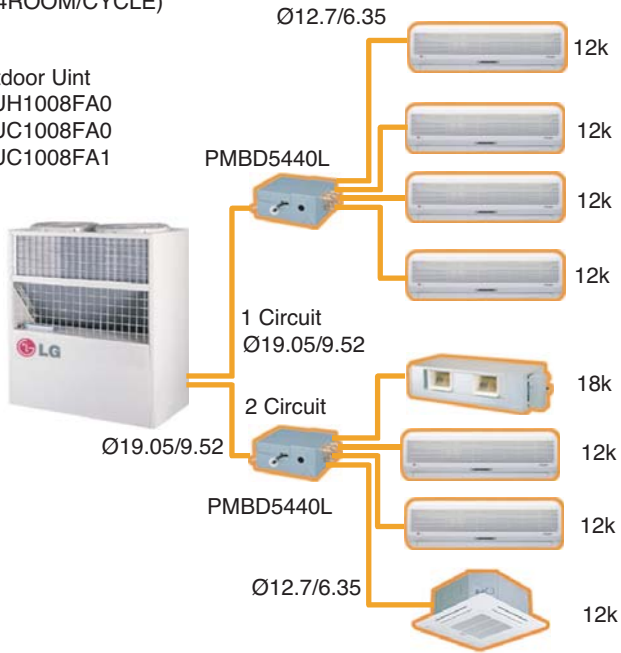

• CASE 2(3ROOM/CYCLE)

\*Outdoor Unit  
L8UH1008FA0  
L8UC1008FA0  
L8UC1008FA1

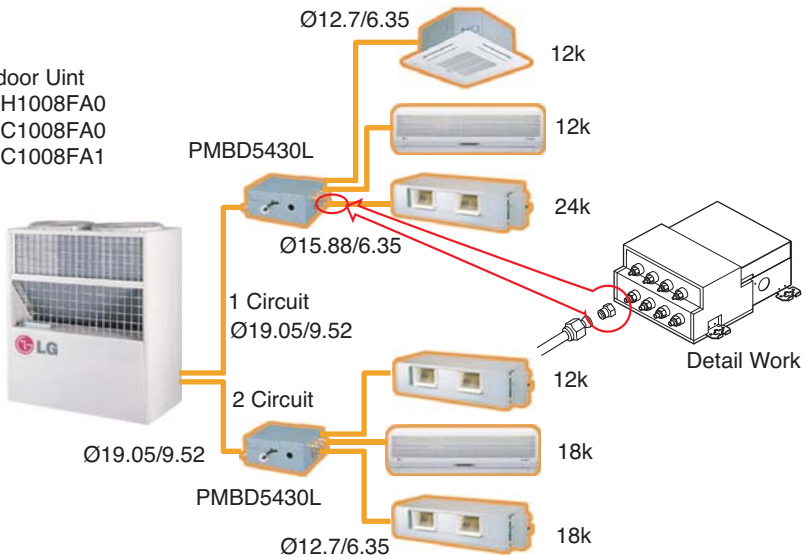

• CASE 1(2ROOM/CYCLE)

\* Outdoor  
L8UH1008FA0  
L8UC1008FA0  
L8UC1008FA1

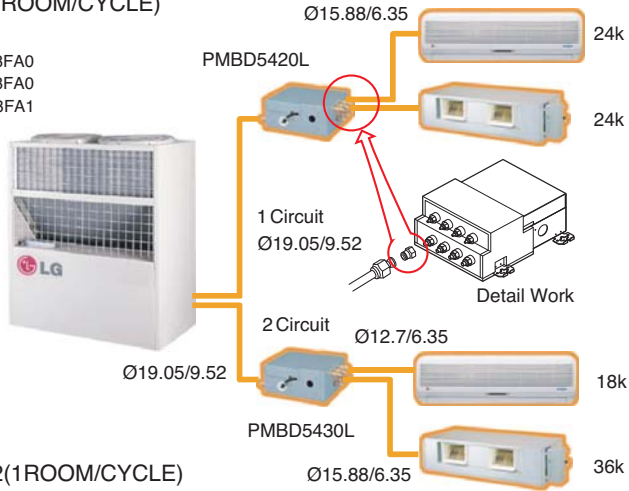

• CASE 2(1ROOM/CYCLE)

\* Outdoor  
L8UH1008FA0  
L8UC1008FA0

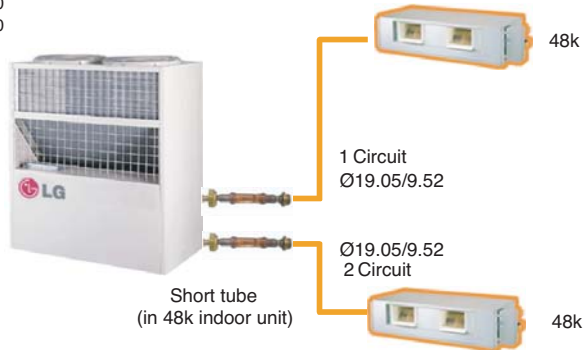

• CASE 3(1ROOM/CYCLE) – Only L8UC1008FA1

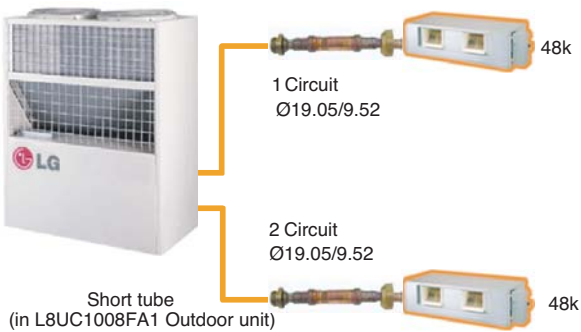

• CASE 4(1ROOM/CYCLE) – L5UC728FA0

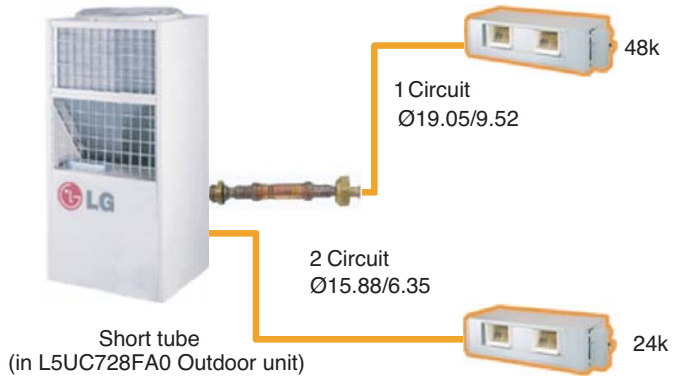

• CASE 5(1ROOM/CYCLE) – Only L5UC728FA1

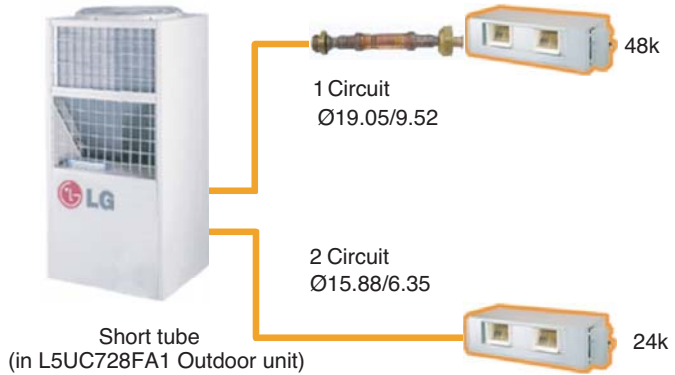

• CASE 6(1ROOM/CYCLE) – L6UH728FA0

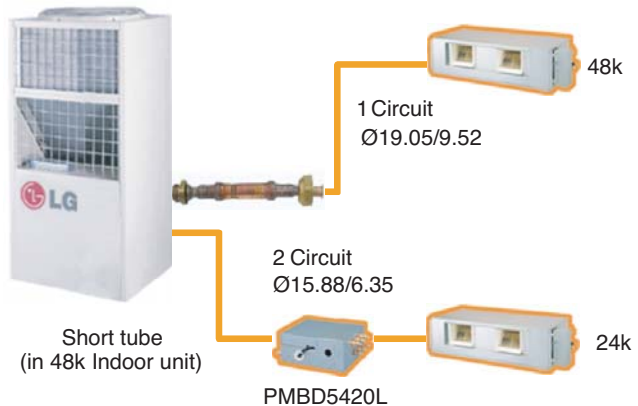

**Models: L8UC1508FA1**

• CASE 1

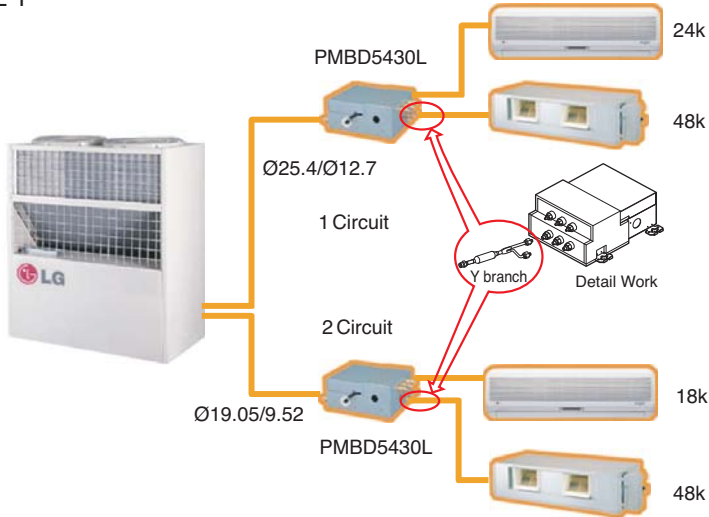

• CASE 2

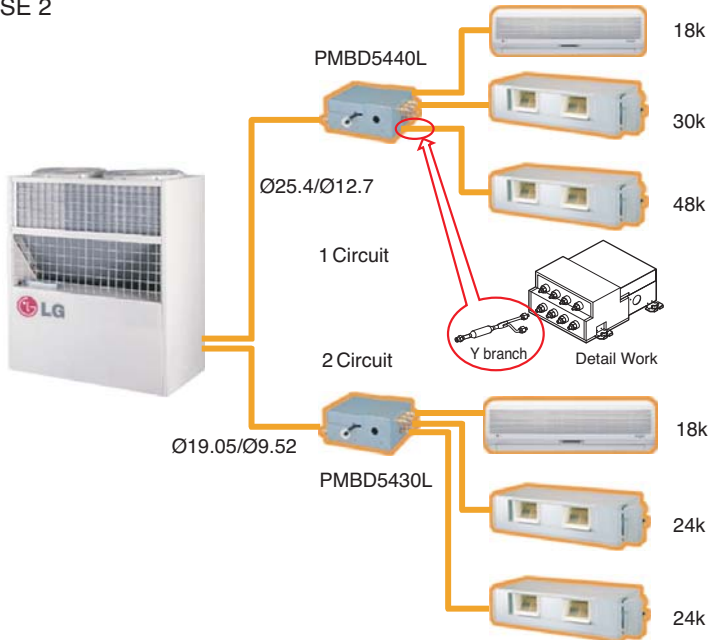

• CASE 3

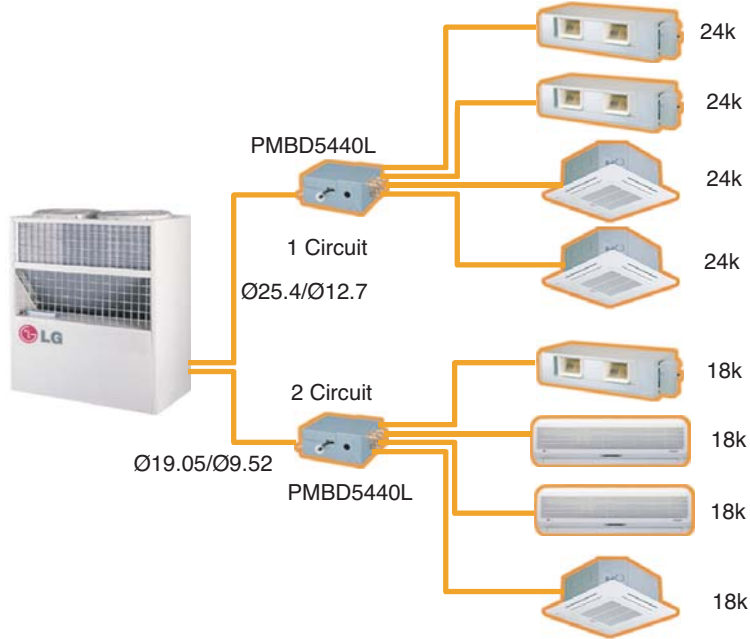

■ Connection between BD and OD unit in case of L8UC1508FA1

In order to connect BD units to L8UC1508FA1 OD unit, the following installation guide should be observed.

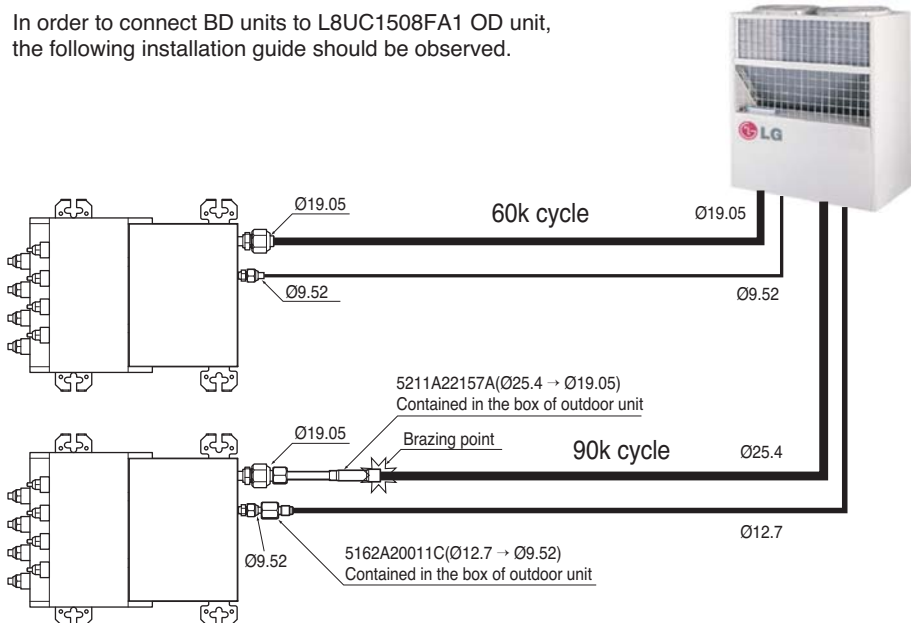



## Installing the short tube(L5UC728FA1 and L8UC1008FA1 only)

### 1) PARTS ACCESSORIES

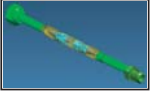

- NAME : SHORT TUBE
- P/NO : 5211A21343E

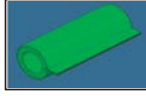

- NAME : INSULATION TUBE
- P/NO : 5410A30055A

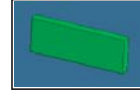

- NAME : INSULATION BUTYL
- P/NO : 5410A20111R

### 2) INSTALLATION METHOD

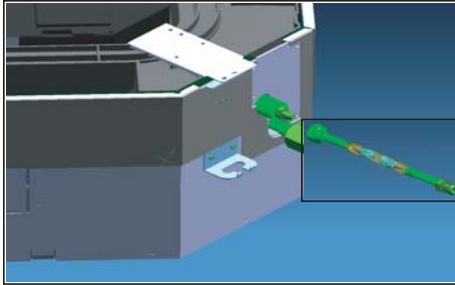

- ☞ IN CASE OF LMNC486BEA0 / LMNC486TDA0 INDOOR UNITS, SHORT TUBE MUST BE USED.
- ☞ SHORT TUBE EXISTING IN THE OUTDOOR UNIT, SHOULD BE USED
  - OUTDOOR : L8UC1008FA1
  - INDOOR : LMNC486BEA0 / LMNC486TDA0
 (SHORT TUBE EXISTING IN THE INDOOR UNIT SHOULD NOT BE USED)  
 (INDOOR UNITS LMNC486BEA0 / LMNC486TDA0 DONOT REQUIRE BRANCH DISTRIBUTOR.)

- 3) AFTER ENVELOPING THE SHORT TUBE BY USING INSULATION TUBE(5410A30055A), SHORT TUBE SHOULD BE SURROUNDED BY INSULATION BUTYL(5410A20111R)

# Connecting the Cable between Indoor Unit and Outdoor Unit

## Connect the cable to the Indoor unit.

Connect the cable to the indoor unit by connecting the wires to the terminals on the control board individually according to the outdoor unit connection. (Ensure that the color of the wires of the outdoor unit and the terminal No. are the same as those of the indoor unit.)

Use round crimp-style terminals for connecting wires to the terminal block.

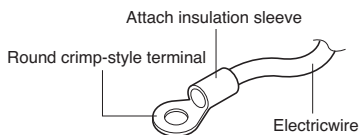

### CAUTION:

- The circuit diagram is not subject to change without notice.
- Be sure to connect wires according to the wiring diagram.
- Connect the wires firmly, so that not to be pulled out easily.
- Connect the wires according to color codes by referring the wiring diagram.



**CAUTION:** Provide a circuit breaker between power source and the unit as shown below.

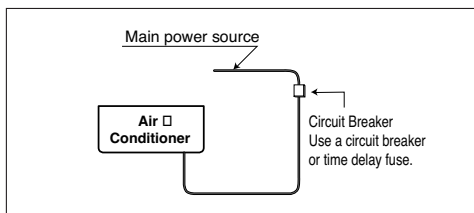

**CAUTION:** The power cord connected to the outdoor unit(Main Power Cable) should be complied with the following specifications (Cable type approved by HAR or SAA).

NORMAL CROSS SECTIONAL AREA	Capacity (mm <sup>2</sup> )			
	48 kBtu/h (C/O)	48 kBtu/h (H/P)	60/72/100 kBtu/h	150 kBtu/h
	3.5	5.0	5.0	14
Cable Type	H05RN-F			

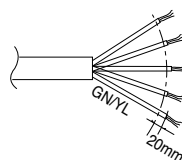

The power connecting cable connected to the indoor and outdoor unit should be complied with the following specifications (Type "B" approved by HAR or SAA).

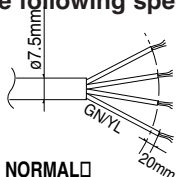

NORMAL □  
CROSS-SECTIONAL □  
AREA 0.75mm<sup>2D</sup>  
H05VV-F

## Connect the cable to the Outdoor unit.

- Remove the cover control from the unit by loosening the screw.  
Connect the wires to the terminals on the control board individually as the following.
- Secure the cable onto the control board with the holder (clamper).
- Refix the cover control to the original position with the screw.
- Use a recognized circuit breaker between the power source and the unit. A disconnection device to adequately disconnect all supply lines must be fitted.

Circuit Breaker (A)	Capacity (kBtu/h)			
	48/60	72	100	150
	20	25	32	75

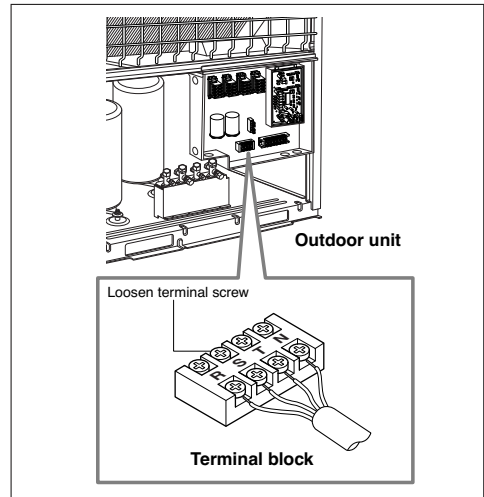

### **!** WARNING

- Indoor Unit ground Lines are required for preventing electrical shock accident during current leakage, Transmission disorder by noise effect and motor current leakage (without connection to pipe).
- Don't install an individual switch or electrical outlet to disconnect each of indoor unit separately from the power supply.

### **!** CAUTION: After the confirmation of the above conditions, prepare the wiring as follows.

- Never fail to have an individual power circuit specifically for the air conditioner. As for the method of wiring, be guided by the circuit diagram posted on the inside of control cover.
- Firmly tighten the terminal screws to prevent them loosening. After tightening, pull the wires lightly to confirm that they do not move. (If they are loose the unit, the unit will not operate normally or it can cause burn-out of the wires.)
- Specification of power source.
- Confirm that electrical capacity is sufficient.
- See to that the starting voltage is maintained at more than 90 percent of the rated voltage marked on the name plate.
- Confirm that the cable thickness is as specified in the power source specification. (Particularly note the relation between cable length and thickness.)
- Do not install an earth leakage circuit breaker in a wet or moist area.
- The following would be caused by voltage drop.
  - Vibration of a magnetic switch, which will damage the contact point, fuse breaking, disturbance of the normal function of the overload.
- The means for disconnection from a power supply shall be incorporated in the fixed wiring and have an air gap contact separation of at least 3mm in each active(phase) conductors.

# Checking the Drainage, Forming the Pipings and Long Pipe Setting

## Checking the drainage

### To check the drainage.

1. Pour a glass of water on the evaporator.
2. Ensure the water flows through the drain hose of the indoor unit without any leakage and goes out the drain exit.

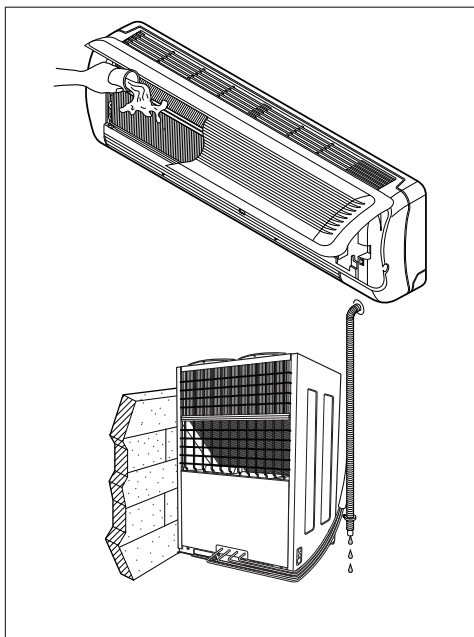

### Drain piping

1. The drain hose should point downward for easy drain flow.

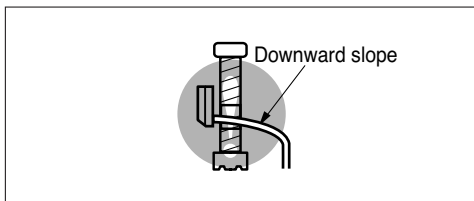

2. Do not make drain piping.

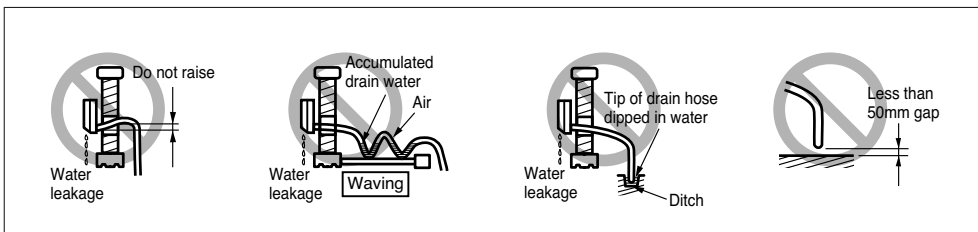

## Forming the piping

**Form the piping by wrapping the connecting portion of the indoor unit with insulation material and secure it with two kinds of vinyl tape.**

- If you want to connect an additional drain hose, the end of the drain outlet should be routed above the ground. Secure the drain hose appropriately.

**In cases where the outdoor unit is installed below the indoor unit perform the following.**

1. Tape the piping, drain hose and connecting cable from down to up.
2. Secure the taped piping along the exterior wall using saddle or equivalent.

**In cases where the Outdoor unit is installed above the Indoor unit perform the following.**

1. Tape the piping and connecting cable from down to up.
2. Secure the taped piping along the exterior wall. Form a trap to prevent water entering the room.
3. Fix the piping onto the wall by saddle or equivalent.

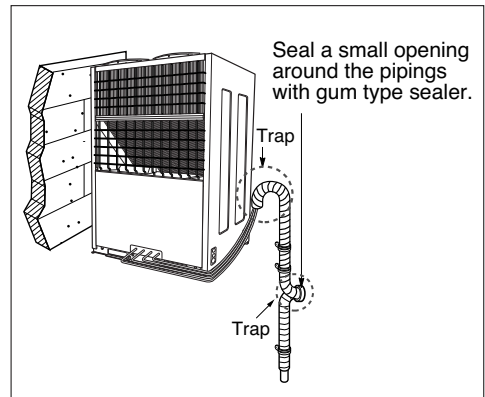
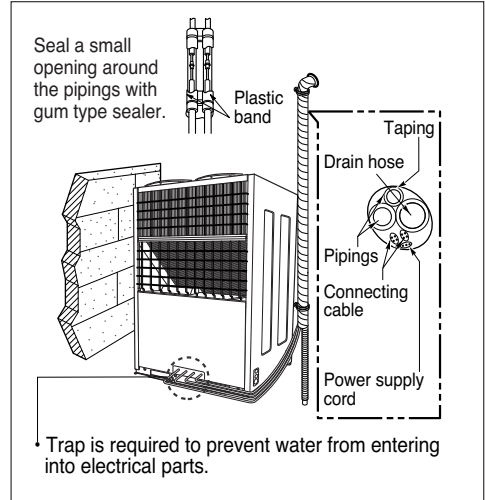

# Air Purging and Evacuation

Air and moisture remaining in the refrigerant system have undesirable effects as indicated below.

1. Pressure in the system rises.
2. Operating current rises.
3. Cooling(or heating) efficiency drops.
4. Moisture in the refrigerant circuit may freeze and block capillary tubing.
5. Water may lead to corrosion of parts in the refrigeration system.

Therefore, the indoor/outdoor unit and connecting tube must be checked for leak tight, and vacuumed to remove incondensable gas and moisture in the system.

In case of 100 kBTu/h and 150 kBTu/h Outdoor Units, Leakage Test and Evacuation should be done for both the cycles(MPS\_A, MPS\_B).

## Checking method

### Preparation

- Check that each tube(both liquid and gas side tubes) between the indoor and outdoor units have been properly connected and all wiring for the test run has been completed. Remove the service valve caps from both the gas and the liquid side on the outdoor unit. Check that both the liquid and the gas side service valves on the outdoor unit are kept closed at this stage.

### Leakage test

- Connect the manifold valve(with pressure gauges) and dry nitrogen gas cylinder to this service port with charge hoses.



**CAUTION: Be sure to use a manifold valve for leakage test.**

**If it is not available, use a stop valve for this purpose. The "Hi" knob of the manifold valve must always be kept close.**

- Pressurize the system to no more than 150 P.S.I.G. with dry nitrogen gas and close the cylinder valve when the gauge reading reached 150 P.S.I.G. Next, test for leaks with liquid soap.



**CAUTION: To avoid nitrogen entering the refrigerant system in a liquid state, the top of the cylinder must be higher than its bottom when you pressurize the system. Usually, the cylinder is used in a vertical standing position.**

1. Do a leakage test of all joints of the tubing(both indoor and outdoor) and both gas and liquid side service valves. Bubbles indicate a leak. Be sure to wipe off the soap with a clean cloth.
2. After the system is found to be free of leaks, relieve the nitrogen pressure by loosening the charge hose connector at the nitrogen cylinder. When the system pressure is reduced to normal, disconnect the hose from the cylinder.

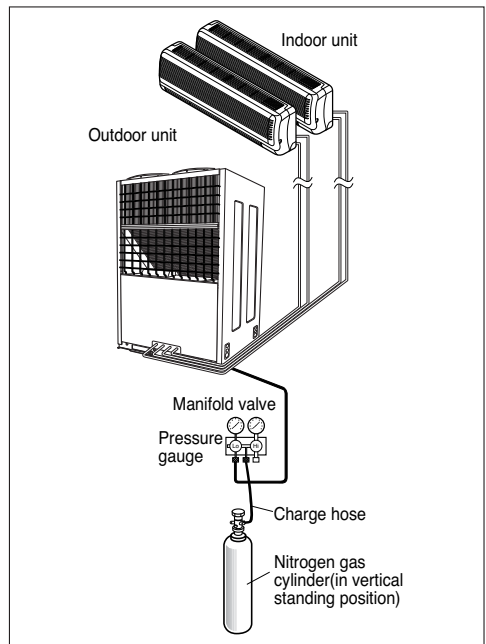

## Soap water method

1. Remove the caps from the 2-way and 3-way valves.
2. Remove the service-port cap from the 3-way valve.
3. To open the 2-way valve turn the valve stem counterclockwise approximately 90°, wait for about 2~3 sec, and close it.
4. Apply a soap water or a liquid neutral detergent on the indoor unit connection or outdoor unit connections by a soft brush to check for leakage of the connecting points of the piping.
5. If bubbles come out, the pipes have leakage

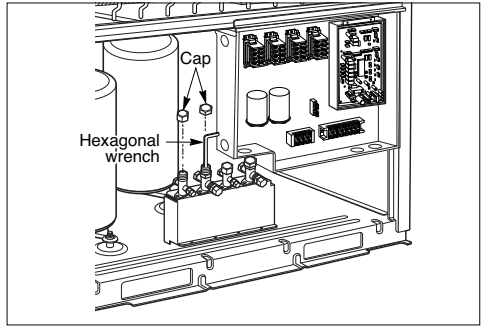

## Evacuation

1. Connect the charge hose end described in the preceding steps to the vacuum pump to evacuate the tubing and indoor unit. Confirm the "Lo" knob of the manifold valve is open. Then, run the vacuum pump. The operation time for evacuation varies with tubing length and capacity of the pump. The vacuum pump must be operated less than 0.5torr of the gage pressure.
2. When the desired vacuum is reached, close the "Lo" knob of the manifold valve and stop the vacuum pump.

## Finishing the job

1. With a service valve wrench, turn the valve stem of liquid side valve counter-clockwise to fully open the valve.
2. Turn the valve stem of gas side valve counter-clockwise to fully open the valve.
3. Loosen the charge hose connected to the gas side service port slightly to release the pressure, then remove the hose.
4. Replace the flare nut and its bonnet on the gas side service port and fasten the flare nut securely with an adjustable wrench. This process is very important to prevent leakage from the system.
5. Replace the valve caps at both gas and liquid side service valves and fasten them tight.

This completes air purging with a vacuum pump. The air conditioner is now ready to test run.

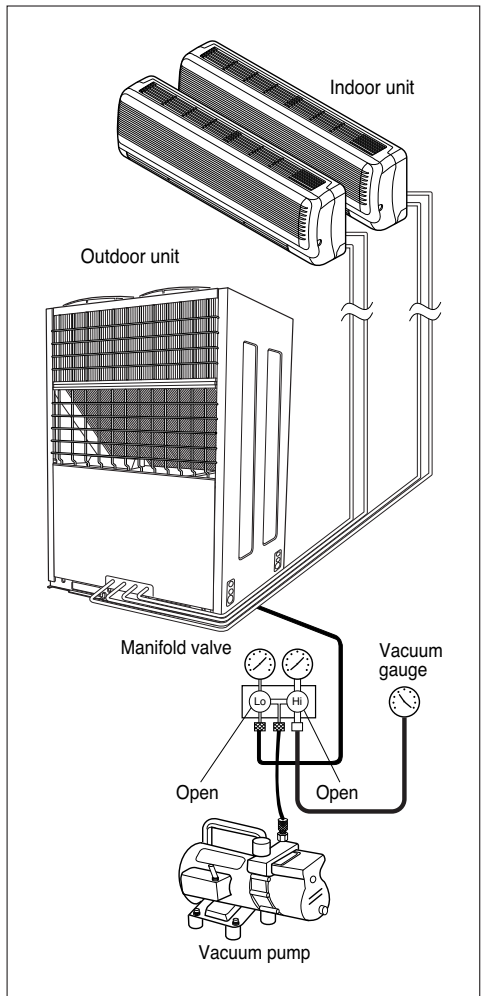

# Test Running

1. Check that all tubing and wiring have been properly connected.
2. Check that the gas and liquid side service valves are fully open.

## Prepare remote control

Remove the battery cover by pulling it according to the arrow direction.

Insert new batteries making sure that the (+) and (-) of battery are installed correctly.

Reattach the cover by pushing it back into position.

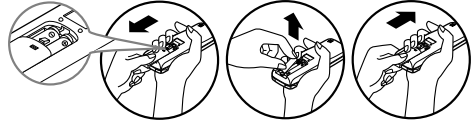

**NOTICE :**

- Use 2 AAA(1.5volt) batteries. Do not use rechargeable batteries.
- Remove the batteries from the remote control if the system is not going to be used for a long time.

## Evaluation of the performance

Operate unit for 15~20 minutes, then check the system refrigerant charge:

1. Measure the pressure of the gas side service valve.
2. Measure the temperature of the intake and discharge of air.
3. The intake temperature - the discharge temperature  $\geq 8^{\circ}\text{C}$
4. For reference, the gas side pressure of optimum condition is as below.(Cooling)

Refrigerant	Outside ambient Temperature	The pressure of the gas side service valve.
R22	35°C (95°F)	4~5kg/cm <sup>2</sup> G(56.8~71.0 psig)

- NOTICE :** If the actual pressure are higher than shown, the system is most likely over-charged, and charge should be removed. If the actual pressure are lower than shown, the system is most likely undercharged, and charge should be added.

The air conditioner is now ready for use.

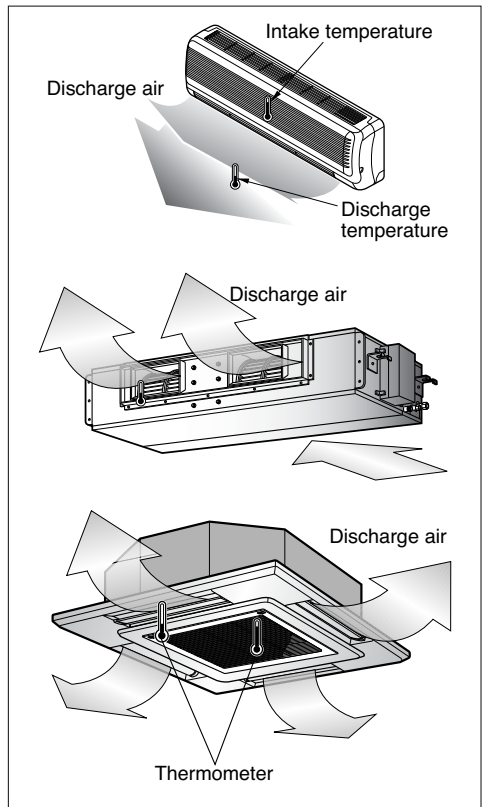



# Optional Operation - Duct Types

## Group Control

It operates maximum 16 Units by only one Wired Remote Controller, and each Unit starts sequentially to prevent overcurrent.

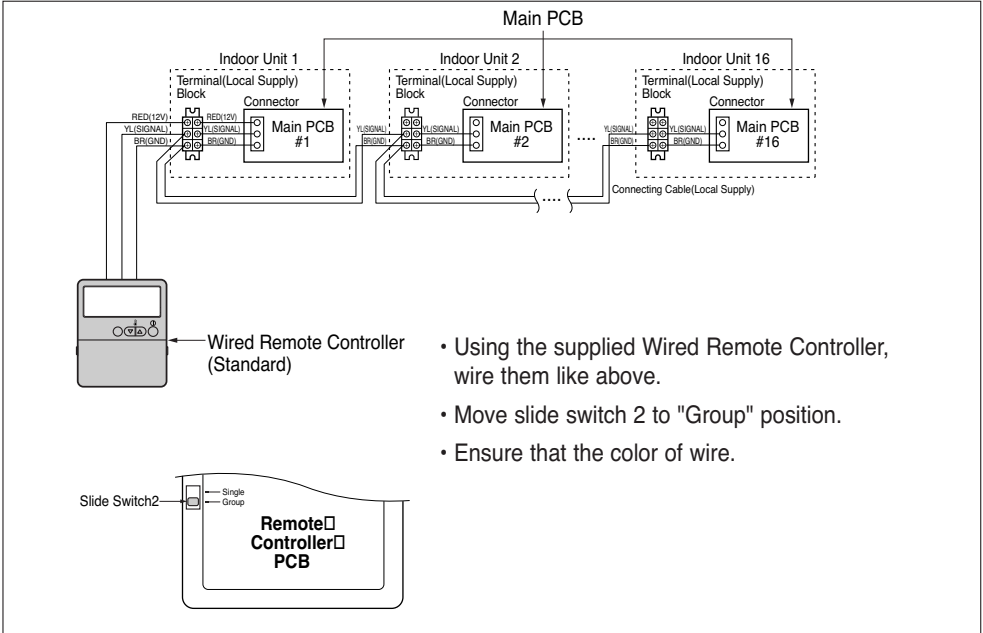

## Two Thermistor system

- Open the rear cover of Remote Controller to set up the mode.
- Selectable options are three as follows.
  - Remo: Sensing the room Temperature.
  - Indoor Unit: Sensing the intake air into indoor Unit.
  - 2 TH: Sensing the lower temperature of the two thermistors.
- To set up the mode, adjust the slide switch to desired mode position on installing.

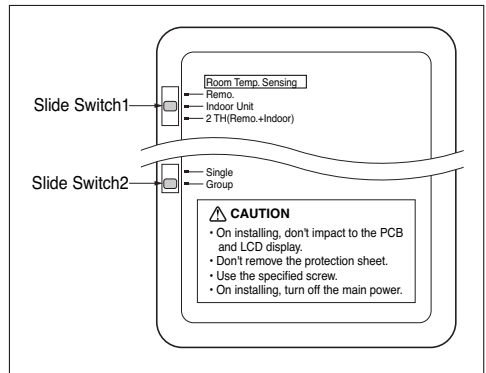

## E.S.P.(External Static Pressure) Setting

Open the rear cover of the wired remote-controller to set the mode.

Select one of three selectable modes as follows.

### ■ Without Zone System

1. Position V-H, F-H:
  - This position sets the maximum E.S.P as a default set.
2. Position V-L:
  - This position sets the minimum E.S.P as a default set.

### ■ With Zone System

1. Position V-H:
  - Maximum E.S.P setting & Fan speed is varied according to the state of dampers by micom.
2. Position F-H:
  - Maximum E.S.P setting & Fan speed doesn't vary according to the opening & Closing of dampers.
3. Position V-L:
  - Minimum E.S.P setting & Fan speed is varied according to the state of dampers by micom.

\*Maximum: 18k/24k-8mmAq  
30k/36k-10mmAq, 48k-15mmAq.

Minimum: All-0mmAq

Move the slide switch to set position.

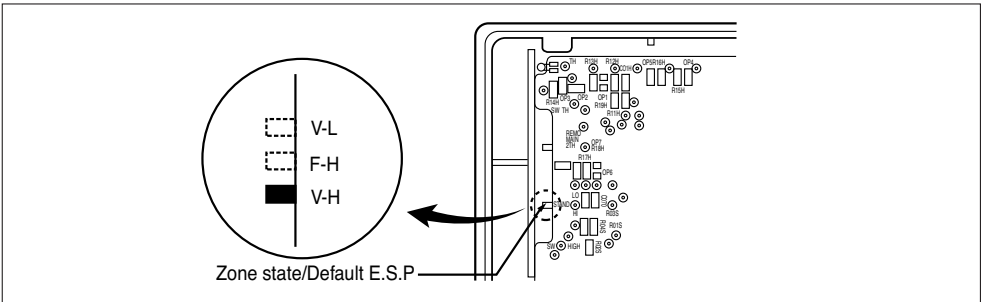

Close the rear cover and check if it works normally.



### CAUTION:

- Select the position after checking duct work and E.S.P of the unit.
- Manufactured in the position F-H.

## How to Set E.S.P?

### Procedure of RPM change:

Ex) External Static pressure is 4mmAq for Model Name "LMNH246BHA0"

- To protect the unit, compressor is designed to be off during E.S.P. setting.

- 1** Push the "On/Off" button.  
The unit will start.

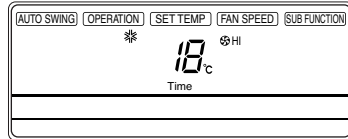
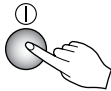

- 2** Push the "Timer" and "Wind" button simultaneously for more than 3 seconds.

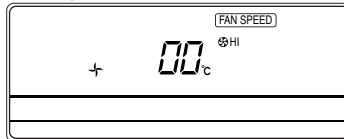
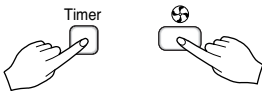

- 3** Push the "Up" of "Down" button for E.S.P adjustment.  
And, adjust the number which you want. (In this example, the number is "190". Refer to the table 1 on the next page.)

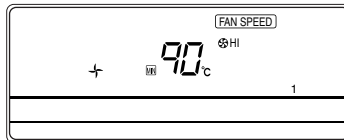
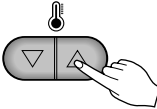

**NOTICE!** The range of selection is from 1~254. Since, the display is two Digit only.

If the range selection is above 100 then the third digit will appear in the screen as shown.

- 4** Shift the fan speed mode by pressing the fan speed button.  
And then, Adjust numbers of next steps by repeating the stage 3.  
(In this example, the numbers are "220" and "235" respectively)

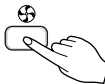

- 5** Push the "Timer" and "Wind" button simultaneously for more than 3 seconds.  
Then, Wind Data is memorized by the EEPROM of the main PCB.

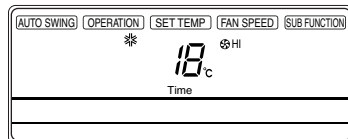
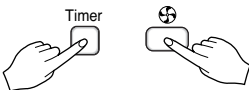

[Table. 1]

Chassis	Static Pressure(mmAq)		0	2	4	6	8	10	12	14	15
	Capacity	Step(Hi/Med/Lo)	Setting Value								
BH	18 kBtu/h	16.5 CMM	235	230	225	215	180				
		14.5 CMM	245	238	235	230	215				
		13 CMM	254	252	248	245	240				
	24 kBtu/h	18 CMM	220	205	190	170	1				
		16.5 CMM	235	230	220	200	100				
BG	30 kBtu/h	14 CMM	250	240	235	230	210				
		26.5 CMM	153	150	150	148	130	1			
		23 CMM	173	173	175	175	170	155			
	36 kBtu/h	20 CMM	195	195	193	193	190	190			
		32 CMM	230	230	225	220	150	1			
		29 CMM	240	238	237	235	230	220			
BR	48 kBtu/h	26.5 CMM	245	245	243	243	240	240			
		40 CMM	230	225	220	215	205	200	190	180	160
		35 CMM	250	245	240	235	230	220	215	210	200
		30 CMM	255	255	255	250	245	240	235	230	225

- NOTICE**
1. Be sure to set the value referring table 1. Unexpected set value will cause mal-function.
  2. Table 1 is based at 230V. According to the fluctuation of voltage, air flow rate varies.

### High-Static Motor Connection (For 48K BE Chassis Model)

- If working condition of indoor unit is higher than that of standard static pressure (10mmAq) change the Indoor Motor wire housing for standard motor housing for higher external static Pressure (15mmAq).

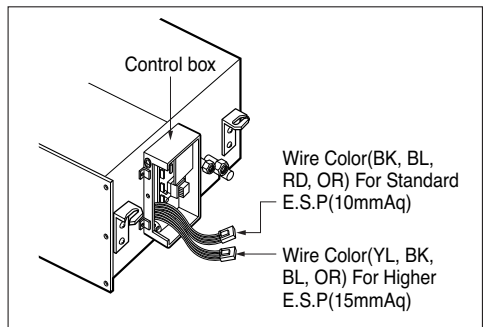

## External Static Pressure & Air Flow (For 48K BE Chassis Model)

Static Pressure(mm Aq)		0	2	4	6	8	10	15
Model Name	Step	CMM	CMM	CMM	CMM	CMM	CMM	CMM
LMNH/C486BEA0	High	48.5	46.5	45	43.5	42	40	40
	Med	43	41.5	39.5	38	36.5	35	35
	Low	39	37.5	36	34.5	33	31	30

- 1) The above table shows the correlation of External Static Pressure & AIR FLOW.
- 2) Duct work must be designed within the range of  on installing the unit.
- 3) Change the connection of the indoor fan motor connector to increase the motor speed to obtain similar CFM at 15mmAq static pressure.
- 4) If duct work is designed under  External Static Pressure, adjust the External Static Pressure applying air damper.

## Checking the Power Cord (For 48K BE Chassis Model)

If the main cable for power supply is connected incorrect or wrong, it shall cause strange noise from the compressor and cooling operation does not work.

### Troubles and Solutions

#### Troubles

- ▷ Occurrence of strange noise from compressor
- ▷ No variation of pressure gages.

#### Solutions

- ▷ Change the R,S wires to the terminal block.

### Outdoor unit circuit

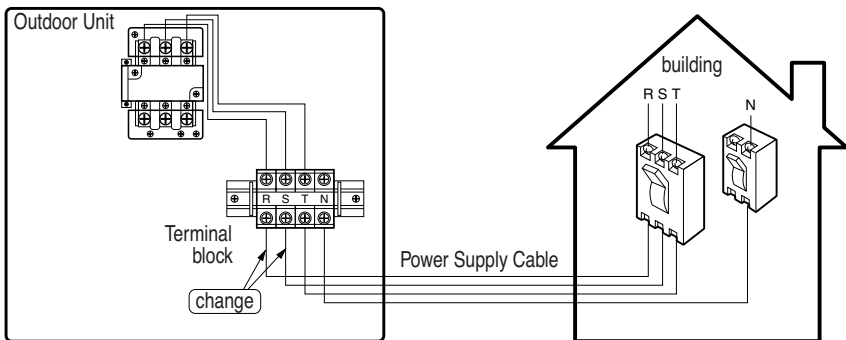

# Optional Operation - CST Type

## 1. Two Thermistor System

- (1) Open the rear cover of the wired remote-controller to set the mode.
- (2) Select one of three selectable modes as follows.
  - Position 1: The room temperature is controlled by the thermistor of the main body.
  - Position 2: The room temperature is controlled by the thermistor of the wired remote-controller, control the temperature according to the position of wired remote-controller.
  - Position 3: The room temperature is controlled by lower temperature between the temperature of main body and of remote-controller sensor.
- (3) Move the slide switch to set position.

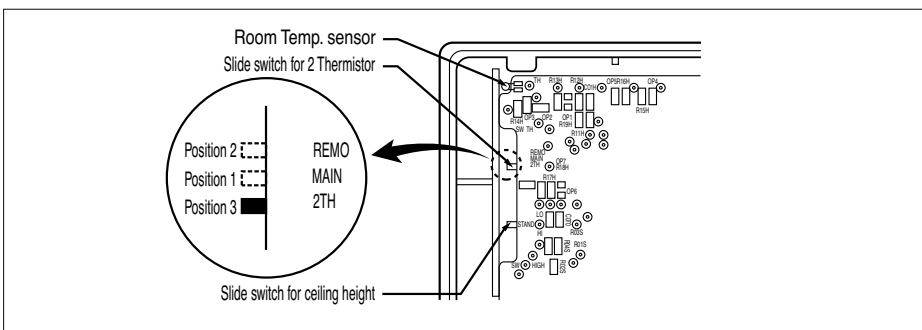

- (4) Close the rear cover and check if it works normally.



### CAUTION:

- Select the position after counselling with a customer.
- In case of cooling mode, room temperature is controlled by the main body sensor.
- To control the room temperature by a wired remote controller, install controller(room temp. sensor) to sense the temperature more accurately.
- Manufactured in the position 3.

## 2. Adjusting air volume to the height of ceiling

You can choose the RPM(or air volume) of indoor motor according to the height of ceiling to supply the comfortable atmosphere to consumers.

### Procedure

1. Choose the selectable position in the table after measuring the height of ceiling.

Ceiling height	Mode of slide switch	Change of air volume	Remark
more than 3.3m	High Ceiling	Increasing	Manufactured in standard mode
2.7~3.3m	Standard	-	
less than 2.7m	Low Ceiling	Decreasing	

2. In the case of changing the height as "high" or "low", open the rear cover of the wired remote-controller.
3. Move the slide switch to the set position.

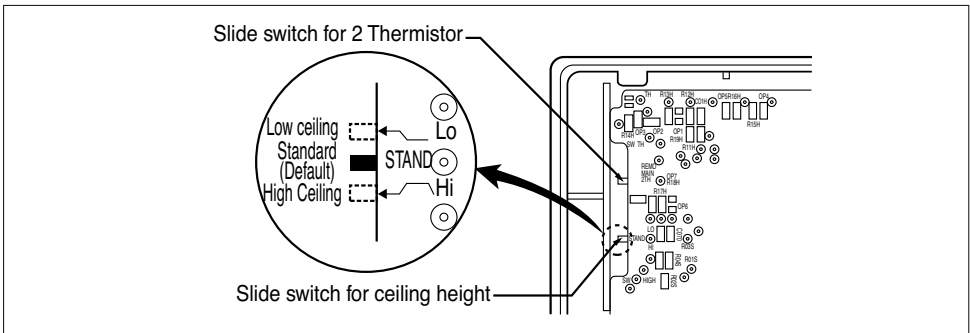

4. Close the rear cover and check if it works normally.

### 3. Group Control(Optional Wiring)

- You can use a group control operation after connecting the brown and yellow wire of each air-conditioner.
- Remove the resistor "OP 7" in remote controller.
- It operates maximum 16 Units by only one Wired Remote Controller, and each Unit starts sequentially to prevent overcurrent.

#### Wiring design

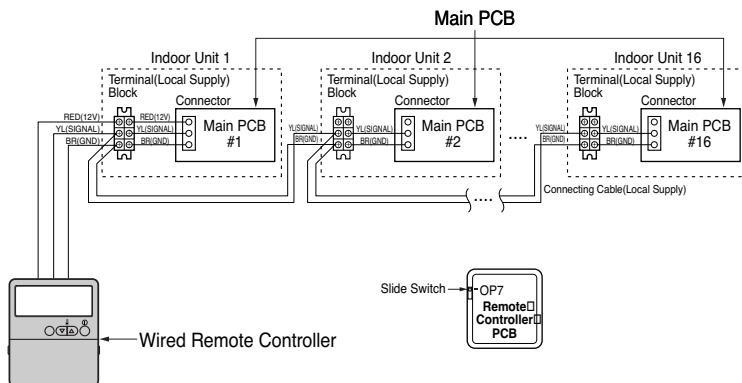

#### Features

- Use Only One Wired Remote Controller with several air conditioners(max. 16 Units)
- Random starting to prevent overcurrent.



#### CAUTION:

- Be careful not to exchange the color of wires.
- The maximum length of connecting wire should be below 200m(25Ω) on connecting each units.
- Use a wire more than 0.5mm<sup>2</sup>



# Combination of indoor and outdoor unit

The total capacity index of indoor units is the sum of capacity index of each units and should be within the capacity index of the outdoor unit.

Indoor Units				Outdoor Units					
				L4UC488FA0 L4UH488FA0	L4UC608FA0	L5UC728FA0(1) L6UH728FA0	L8UC1008FA0(1) L8UH1008FA0	L8UC1508FA1	
Model Type		Capacity			Number of connectible Indoor Units				
		Index	Btu/h	kW	up to 4	up to 4	up to 5 for L5UC728FA0(1) up to 6 for L6UH728FA0	up to 8	up to 8
Wall Mounted	General	9	9,000	2.6	○	-	-	-	-
		12	12,000	3.5	○	○	○	○	-
		18	18,000	5.3	○	○	○	○	○
		24	24,000	7.0	○	○	○	○	○
Artcool	Mirror	9	9,000	2.6	○	-	-	-	-
		12	12,000	3.5	○	-	-	○	-
		18	18,000	5.3	○	-	-	○	○
		24	24,000	7.0	○	-	-	○	○
Floor Standing	General	24	24,000	7.0	○	-	-	-	-
		28	28,000	8.2	○	-	-	-	-
		36	36,000	10.6	○	-	-	-	-
Ceiling Cassette	4Way	12	12,000	3.5	-	-	-	○	-
		18	18,000	5.3	-	-	-	○	○
		24	24,000	7.0	-	-	-	○	○
		30	30,000	8.8	-	-	-	○	○
		36	36,000	10.6	-	-	-	○	○
		48	48,000	14.1	-	-	-	○	○
Ceiling Concealed Duct	High Static	18	18,000	5.3	-	○	○	○	○
		24	24,000	7.0	-	○	○	○	○
		30	30,000	8.8	-	-	○	○	○
		36	36,000	10.6	-	○	○	○	○
		48	48,000	14.1	-	-	○*	○(BE chassis)	○(BR chassis)
	Low Static	12	12,000	3.5	-	-	-	○	-
		18	18,000	5.3	-	-	-	○	-
		24	24,000	7.0	-	-	-	○	-

**NOTICE** : 1. The total capacity index of indoor units is the sum of capacity index of each units and should be within the maximum capacity index of the outdoor unit.

2. BR chassis is applicable to L6UH728FA0 and L8UC1508FA1.

\* 48k High static duct for 72 kBTu/h model

- L5UC728FA0(1): BE chassis

- L6UH728FA0: BR chassis

# Installation guide at the seaside



## CAUTION

1. Air conditioners should not be installed in areas where corrosive gases, such as acid or alkaline gas, are produced.
2. Do not install the product where it could be exposed to sea wind (salty wind) directly. It can result corrosion on the product. Corrosion, particularly on the condenser and evaporator fins, could cause product malfunction or inefficient performance.
3. If outdoor unit is installed close to the seaside, it should avoid direct exposure to the sea wind. Otherwise it needs additional anticorrosion treatment on the heat exchanger.

## Selecting the location(Outdoor Unit)

- 1) If the outdoor unit is to be installed close to the seaside, direct exposure to the sea wind should be avoided. Install the outdoor unit on the opposite side of the sea wind direction.

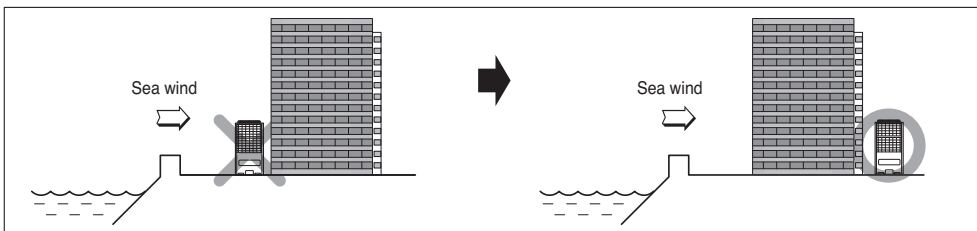

- 2) In case, to install the outdoor unit on the seaside, set up a windbreak not to be exposed to the sea wind.

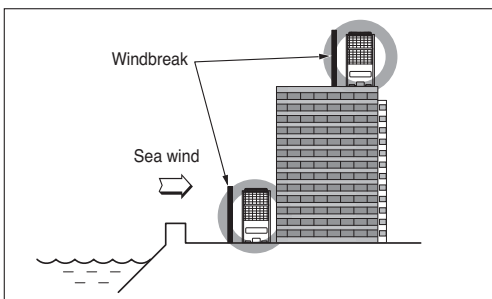

- It should be strong enough like concrete to prevent the sea wind from the sea.
- The height and width should be more than 150% of the outdoor unit.
- It should be keep more than 70 cm of space between outdoor unit and the windbreak for easy air flow.

- 3) Select a well-drained place.

1. If you can't meet above guide line in the seaside installation, please contact LG Electronics for the additional anticorrosion treatment.
2. Periodic ( more than once/year ) cleaning of the dust or salt particles stuck on the heat exchanger by using water

