



OWNER'S MANUAL

V-NET

Please read this manual carefully before operating your set and retain it for future reference.

TYPE : AC Smart II
Advanced Control Smart

TABLE OF CONTENTS

1. AC SMART II Introduction.....1-1

AC Smart characteristics	1-1
AC Smart exterior.....	1-3
AC Smart components	1-5
AC Smart product specifications	1-6

2. AC Smart II Installation2-1

Before installing AC Smart.....	2-2
Setting unit address.....	2-3
• Setting address with wired remote controller	2-4
• Setting address with wireless remote controller	2-5
Setting PI485 and connecting line.....	2-7
• Setting PI485 DIP switch.....	2-7
• Connecting 2PIN connector	2-9
• Connecting RS485 line to PI485	2-11
Installing AC Smart and connecting line	2-14
Logging in of the AC Smart.....	2-17
• Logging in as installation professional.....	2-18
• Logging in as administrator	2-19
• Logging in as general user	2-20
Registering the unit	2-21
• Automatically registering the unit	2-21
• Directly registering the unit.....	2-25
Setting the emergency stop interlocking.....	2-29

3. AC SMART MENU3-1

Control/Monitoring menu	3-1
• Zone information screen.....	3-2
• Group information screen.....	3-6
• Unit information screen	3-10
Schedule menu.....	3-18
• Schedule main screen.....	3-19
• Edit weekly pattern screen	3-24
• Edit schedule detail screen	3-32
History menu	3-40
• Usage view screen	3-43
Auto control menu	3-45
• Temperature limit operation	3-46
• Auto change over operation	3-49
• Time-limited running.....	3-52
Setting menu	3-54
• Setting main screen.....	3-54
• Register unit screen	3-57
Other setting menu	3-59
• Version information	3-60
• Password setting.....	3-61
• Language	3-62
• Time setting.....	3-63
• Screen adjustment	3-64
• Screen saver	3-65
• Network	3-66
• E-mail setting.....	3-69
• S/W upgrade	3-71
• DB management	3-72
Web server function.....	3-73

4. OPERATING AC SMART.....4-1

Logging in of the AC Smart	4-1
• Logging in as installation professional.....	4-2
• Logging in as administrator.....	4-3
• Logging in as general user.....	4-4
Control/Monitoring	4-5
• Controlling the unit.....	4-6
• Controlling the unit in detail.....	4-10
Schedule	4-15
• Managing schedule group.....	4-15
• Applying schedule.....	4-25
• Creating schedule pattern.....	4-29
• Directly editing the schedule.....	4-47
History	4-55
• Browsing history.....	4-55
• Browsing specific history.....	4-56
• Usage view.....	4-59
Auto control	4-63
• Setting temperature limit operation.....	4-66
• Managing temperature limit operation group.....	4-69
• Setting auto change over operation.....	4-79
• Managing auto change over operation group.....	4-82
• Setting the time-limited running.....	4-92
• Managing the time-limited running group.....	4-95
Setting	4-106
• Registering unit.....	4-106
• Managing zone.....	4-112
• Managing group.....	4-121
• Managing the unit.....	4-133

Environment setting	4-145
• Checking the S/W version information	4-146
• Setting the password.....	4-147
• Setting the language by country.....	4-150
• Setting the time	4-153
• Calibrating the screen	4-154
• Setting the screen saver.....	4-157
• Setting the network information.....	4-158
• Setting the E-mail.....	4-163
• S/W upgrade	4-167
• Backing up and restoring the database.....	4-170

(a) For a Class A digital device or peripheral, the instructions furnished the user shall include the following or similar statement, placed in a prominent location in the text of the manual:

NOTE: This equipment has been tested and found to comply with the limits for a Class A digital device, pursuant to Part 15 of the FCC Rules. These limits are designed to provide reasonable protection against harmful interference when the equipment is operated in a commercial environment. This equipment generates, use, and can radiate radio frequency energy and, if not installed and used in accordance with the instruction manual, may cause harmful interference to radio communications.
 Operation of this equipment in a residential area is likely to cause harmful interference in which case the user will be required to correct the interference at his own expense.

Safety Precautions



To prevent injury to the user or other people and property damage, the following instructions must be followed.

■ Incorrect operation due to ignoring instruction will cause harm or damage. The seriousness is classified by the following indications.

⚠ WARNING This symbol indicates the possibility of death or serious injury.

⚠ CAUTION This symbol indicates the possibility of injury or damage.

■ Meanings of symbols used in this manual are as shown below.

	Be sure not to do.
	Be sure to follow the instruction.

⚠ WARNING

■ Operation

Do not operate or stop the unit by inserting or pulling out the power plug.

- It will cause electric shock or fire due to heat generation.

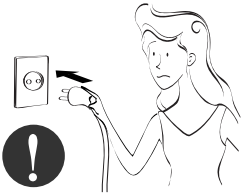

Ask for Product equipment at the service center or establishment certainly at the specialty store.

- It can cause an accident, electric shock, explosion or injury.

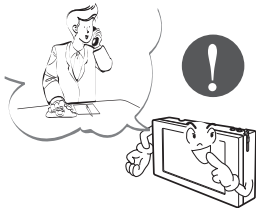

Use standard parts.

- Use of non standard parts can cause electric shock, explosion, injury, breakdown.

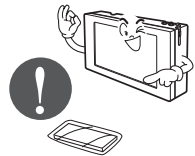

While re-installing the established product, notify the service center or establishment specialty store.

- It can cause an accident, electric shock, explosion, injury.shock.



Do not use the power cord near Flammable gas or combustibles, such as gasoline, benzene, thinner, etc.

- It may cause an explosion or fire.

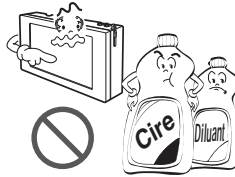

Do not disjoint randomly or repair and remodel the product.

- It may cause fire and electric shock



If water enters the product, turn the power switch of the main body of appliance off.

- After taking the power-plug out from the socket, contact the service center.

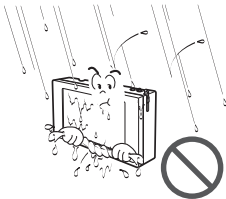

Keep the product away from the places which can have moisture.

- Water may enter the unit and degrade the insulation. It may cause an electric shock.

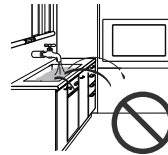

■ During usage

Do not change or extend the conductor at random.

- It can cause fire and electric shock.



Do not use concert with in the octopus-like legs way.

- It can cause fire and electric shock

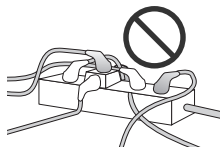

Unplug the unit if strange sounds, smell, or smoke comes from it.

- It may cause fire and electric shock accident.

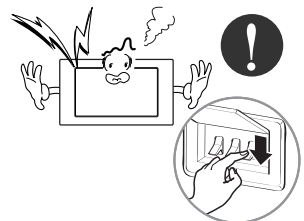

Do not put firearms near product.

- It can cause fire.



Do not put an electric heater or conductor near to the product.

- It can cause fire and electric shock.

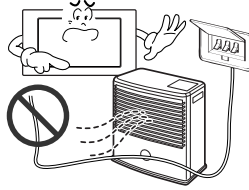

Do not spill water inside product.

- It can cause electric shock and breakdown.

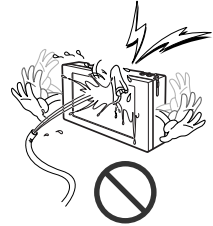

Do not place heavy goods on wire.

- It can cause fire and electric shock.

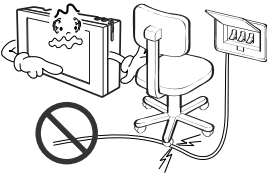

Hold the plug by the head of the power plug when taking it out.

- It may cause electric shock and damage.



Do not place heavy goods on product.

- It can cause product breakdown.



That increase in case of product was been flood certainly in the service center or establishment specialty store commit .

- I am responsible for fire and electric shock.



Protect the product from handling by a children.

- It can cause accident and product breakdown.

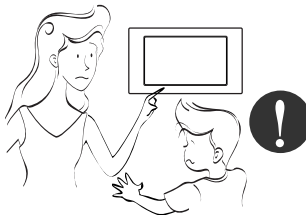

Do not apply shock to product.

- I am responsible for breakdown in case of shock to product.

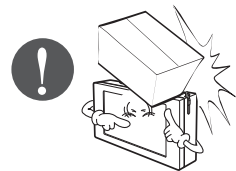

⚠ CAUTION

■ During usage

Clean by soft hands using a cleaning material like a soft cloth.

- It can result in fire and product transformation.



Use touch screen with a pen that product offers.

- Otherwise, there can be breakdown and damage to the product.



Do not place any live part on the surface having water.

- It can cause product breakdown.

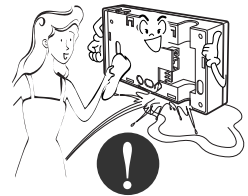

Use recommended Adapter.

- Otherwise it can result in product breakdown

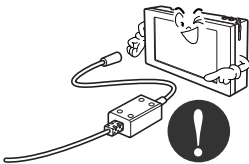

Avoid contact to the metallic goods such as necklace, coin, key, a watch which may touch the battery even for a short-time.

- It may cause product breakdown and injury.

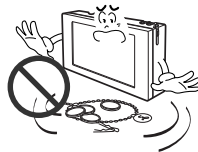

Hold the plug by the head of the power plug when taking it out.

- It may cause electric shock and damage.

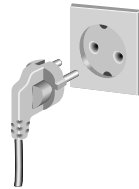

1. AC SMART II Introduction

AC Smart is the central controller that can manage maximum of 64 air conditioner indoor units within one space individually or in integrated manner. AC Smart can monitor or control the operation of the air conditioner and ventilator installed in each room of the building from one location, such as an administrative office of the building.

AC SMART II Characteristics

The characteristics of AC Smart are as follows.

Individual and integrated operation & monitoring

AC Smart can control and monitor the following items by selecting the installed air conditioner by individual unit, by group or all.

- Operating condition of the air conditioner
- Operating mode
- Fan level
- Wind direction
- Lock
- Set temperature

Therefore, the manager can control everything just with AC Smart (Central control) from the administrative office of the building where the air conditioners are installed.

Group management

AC Smart can manage the installed air conditioners by zone and group. When you use the zone or group setting, you can classify the air conditioner by type, location etc. Through these functions, you can conveniently control the air conditioner and by assigning each name to the set group, you can manage the groups intuitively.

Reduced administrative cost

Because you can use AC SMART II to control all units, you can administer all the units with only one administrator. Also by using the schedule function of AC SMART II, the administrator can operate the units automatically without having to be on site.

Convenient GUI

AC SMART II provides intuitive pictogram and simple interface for user to easily use the functions. Through the easy to use interfaces, the user can conveniently control the units without any separate training.

Managing the automatic schedule operation & Saving the energy

The AC Smart can automatically run the air conditioner by setting the schedule.

When you register the schedule for a specific period by this schedule function, the unnecessary operation of the air conditioner can be reduced and the energy can be efficiently saved. These functions can efficiently be performed by operating with a specific schedule such as school.

Various automatic control functions

The AC Smart offers various automatic control functions such as automatically switched running, temperature limited running and time limited running as well as schedule. When the administrator sets and executes these functions, various control functions such as maintaining a specific temperature and limiting the air operation time can be automatically executed and managed by the AC Smart.

Protecting the system by the backup

The AC Smart offers the system information backup function for protecting the system from power failure and other accidents, by which the stability of the system can be improved and the system can be easily recovered from the accident.

Upgrading the software to the recent version

The AC Smart offers the function to upgrade the software to the recent version, by which the AC Smart can be stably operated and a new function can be added.

Web server

The AC Smart offers the web server function to control the air conditioner by remotely accessing the AC Smart via the network. The administrator can use the web server function to control the air conditioner at the place other than the location where the AC Smart is installed.

E-mail notification

The AC Smart offers the function to notify the administrator of the critical error occurred during the operation via the e-mail, by which the administrator can monitor the occurred error.

Extended interconnection

The AC Smart offers the extended interconnection function to control the air conditioner by interconnecting with other devices. Basically, one AC Smart can control 64 air conditioners at maximum. But, it can control 128 air conditioners at maximum when using the extended interconnection function.

AC SMART II exterior

AC Smart is composed in the following shape.

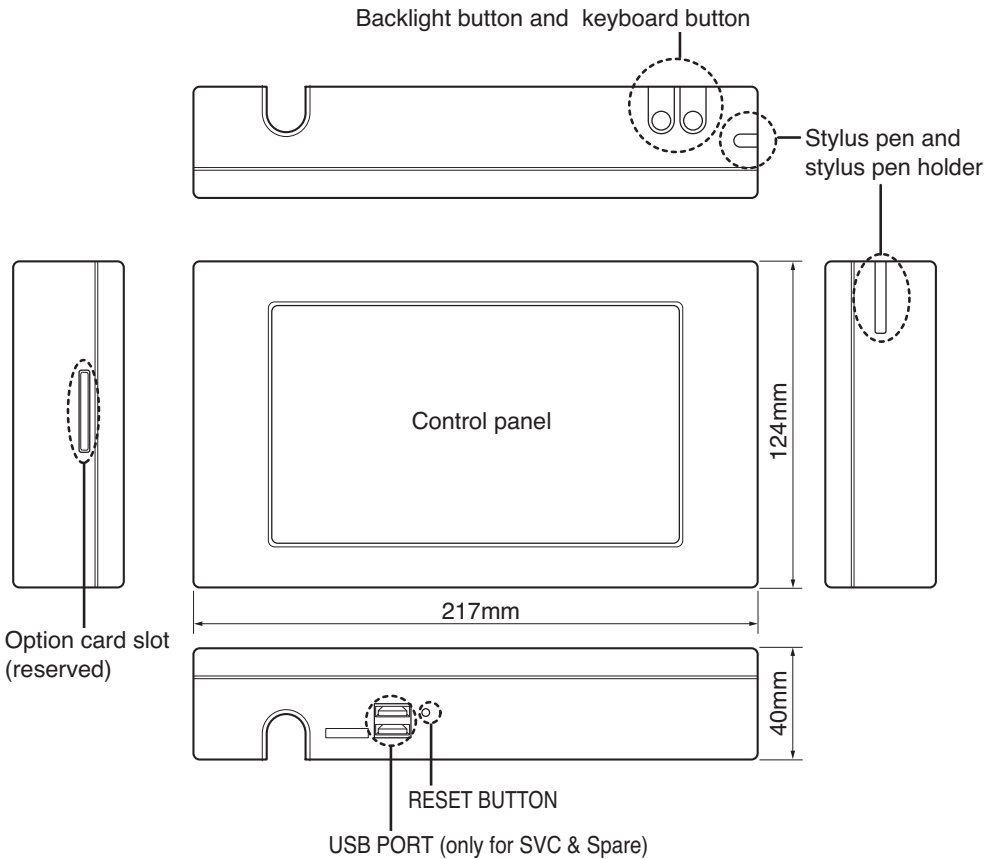

Note: Using the external button to compensate the screen

The screen compensation function can be executed by pressing the keyboard button at the top of the AC Smart and then the backlight button.

When it is hard to execute the screen compensation function by the touch screen, you can use this method.

Caution: USB Port and Option card slot



USB port is only for SVC and development, therefore USB port is not available to general users.

Option card slot is reserved for the future model.

Backlight button

This is the button to turn on and off the LCD backlight of AC Smart. When you do not use AC Smart II for a long period of time, it is good to turn off the backlight to extend the life of the LCD backlight.

Keyboard button

This is the button to display or hide the keyboard on the screen so that the user can enter the characters.

Reset button

This is the button to reset AC Smart II when AC Smart II cannot be controlled from an error.

USB port (For service & Spare)

There are two types of USB ports.

Based on the bottom of the AC SMART II, the USB port (A Type) located on the left side is the USB port to connect the USB memory to update the software or back up the data. This port supports USB version 1.0.

The USB port (B Type) located on the right side is the USB port to connect the PC. This port supports USB version 2.0.

Optional card slot (For adding optional function)

In the optional card slot, you can insert the optional card provided for the optional function of AC SMART II.

Information: Optional function of AC SMART II

AC SMART II provides the following optional functions.

- Power display function: This shows the information of power consumption connected to the power meter.
- Web schedule function: You can use the schedule function of AC SMART II by connecting to AC SMART II remotely through the web.

You can purchase the optional function additionally and it is provided in card format.

AC Smart II components

The components of AC Smart are as follows inside the box. Open the box of AC Smart and check whether all components are included.

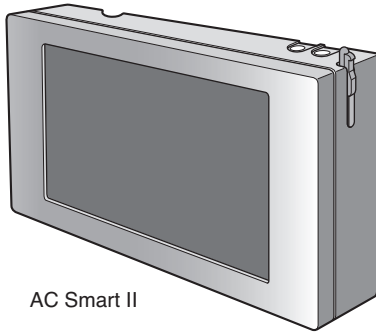

AC Smart II

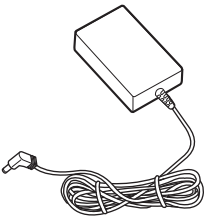

Power adapter

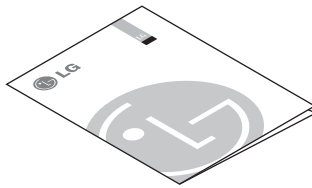

Quick Guide

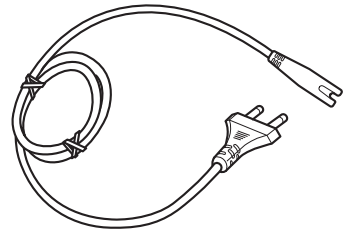

Power cord



Manual CD

AC Smart II product specifications

The product specifications of AC Smart are as follows.

Item	Specifications
CPU	MP2530F(or MP2531F) - Dual CPU[ARM926E/360MHz + ARM946E/300MHz]
Memory	128MB [DDR 64MB(A Bank) + DDR 64MB(B Bank)]
Boot ROM & Storage	512MB (NAND Flash) SD Card (support SDHC 8GB) (For optional card)
LCD	7.0" WVGA (800*480) TFT LCD
Speaker	AST-01508MR-R
Button Key	Display S/W(x1), Software Key S/W(x1)
DI	S/W Input (For Fire-sensor)
Power	DC 12V/1A
Touch Screen	4 Wire, Touch Controller built-In.
UART	RS-485 1Port
USB	USB1.1 Host 2Port(For service) USB2.0 Device 1Port (For development)
OS	Windows CE 5.0 Core License

2. AC Smart II Installation

This chapter describes the installation method to use AC Smart II.

Caution: AC Smart installation



Installation of AC Smart requires special technology. Therefore, **The installation detail mentioned in this chapter must be executed by an installation technician with installation qualifications.**

If you have any questions or requests related to installation, please consult the service center or installers designated by our company.

To use AC Smart, you must construct an environment where AC Smart can communicate with the unit (Indoor unit, ventilator, On/Off, AWHP) and register the indoor units.

To use AC Smart, you must execute the installation in the following order.

STEP 1. Check environment before installing AC Smart
Before installing AC Smart, you must check the network among AC Smart II, outdoor unit and unit.

STEP 2. Set unit address
Assign a unique address to the unit connected to AC Smart.

STEP 3. Set PI485
Install one PI485 for each outdoor unit, and set the DIP switch.

STEP 4. Connect PI485 and AC Smart
Connect the PI485 and AC Smart through the RS485 line.

STEP 5. Login and register unit
Login to AC Smart and register the unit which the address has been assigned to.

Information: Multi V II series

Multi V II series does not require separate installation of PI485, and you can use this by connecting "BUS A" and "BUS B" to "Internet A" and "Internet B" of AC Smart II and Main PCB of outdoor unit.

Before installing AC SMART II

A single AC Smart can connect 64 units (indoor unit, ventilator, On/Off, AWHP) at maximum. It can also connect 128 units via the extension kit (PQCSE440U0).

The following is an example of configuration of the AC SMART II and units. AC SMART II is connected to PI485, and the units communicate the information mutually through RS485 communication. PI485 is connected to the devices for AC SMART II to control.

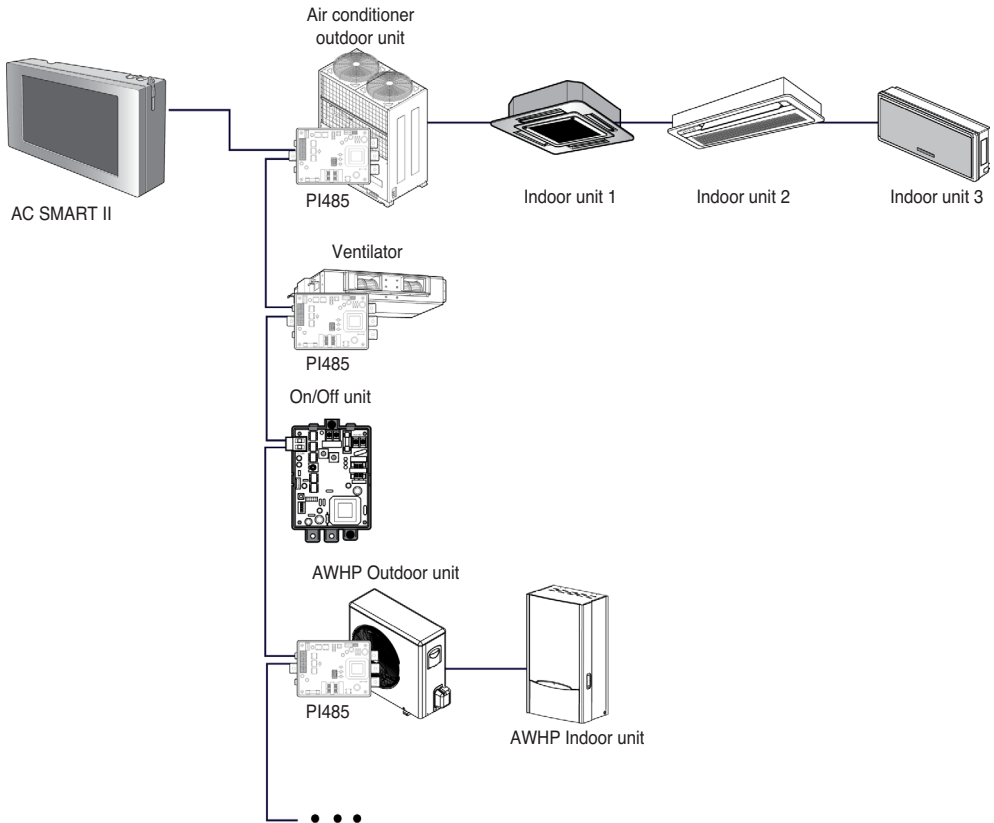

Information: Maximum permitted communication length and specification

The maximum permitted communication length that LG Electronics guarantee is 1,000m. In other words, the unit installed the farthest from AC SMART II must be installed within 1,000m distance. It is recommended to use the communication cable of 0.75mm² (Shield) or above.

Setting unit address

First, you must assign the address to each unit so that the address of each unit (Indoor unit, ventilator, On/Off, AWHP) is not duplicated by considering the overall installation composition connected to AC Smart II.

The address of the unit can be set in hexadecimal from 00 to FF.

Caution: Setting address for indoor unit, ventilator, On/Off unit and AWHP unit



You cannot set the same address for the indoor unit, ventilator On/Off unit and AWHP. Make sure not to have duplicate addresses.

The following is an example of assigning the address to the unit.

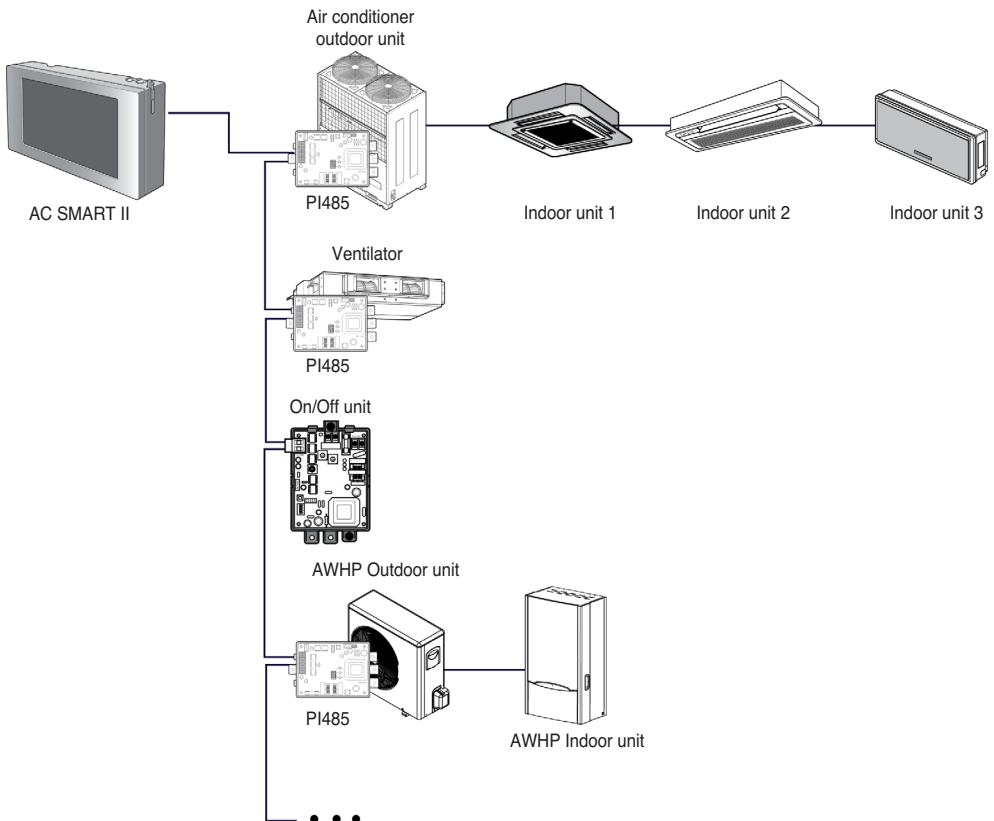

Reference: Setting address for device

When setting the address of a unit (Indoor unit, ventilator, On/Off unit, AWHP unit), it is recommended to set the first digit as the group number, and second as unit number for easy identification.

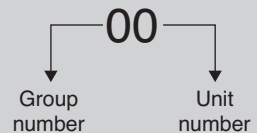

Setting address for indoor unit

When connecting and using the air conditioner with AC SMART II, you must set the address of each indoor unit through the wired or wireless remote controller. You can set the address of the indoor unit in the following order.

Setting address with wired remote controller

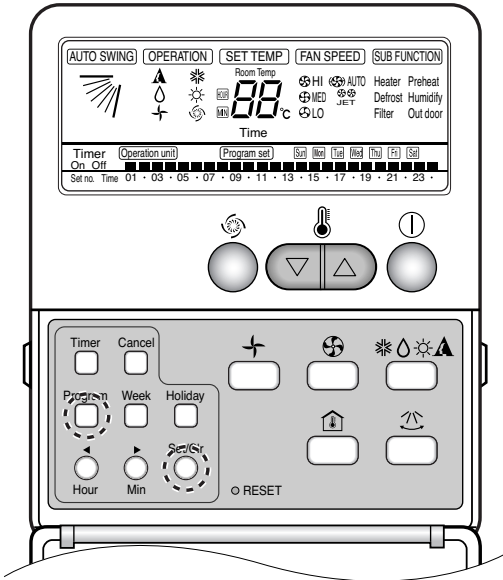

1. Press Week Program & Set/Clr keys at the same time.
2. Set the indoor unit address using the temperature controller.
Allowed Range: 00-FF

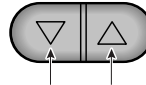

Group No. Indoor Unit No.

3. Complete the address setting to press the week Program & Set/Clr keys at the same time for 3 seconds.

Setting the address with wired remote controller

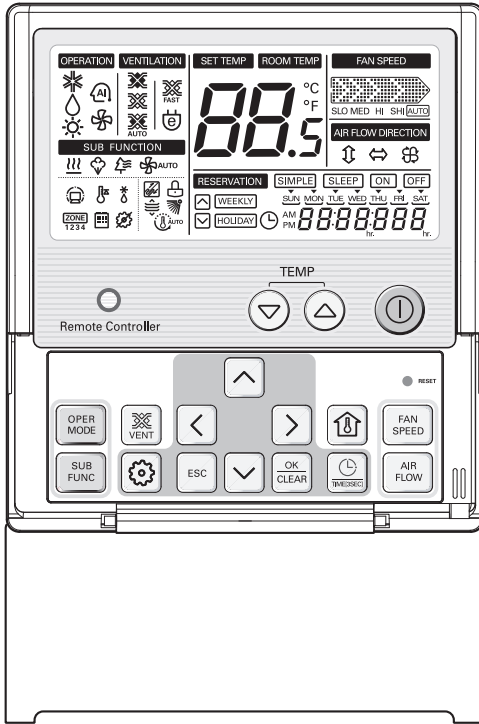



1. Press the  button for 4 seconds to enter the installer setting mode until timer segment display "01:01".

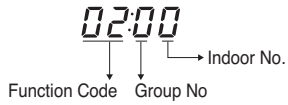

2. Repeat pressing  button to select Function code 02.



Ex) Setting Address as 'F5'

3. Set Group No. by pressing   button.

02:F0

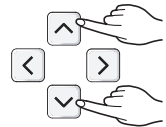

4. Move to Indoor No. setting option by pressing  button.

02:F0

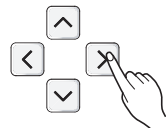

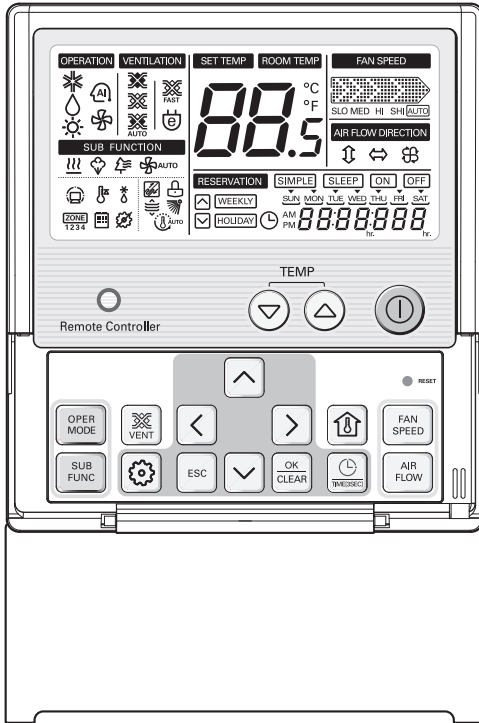

5. Set Indoor No. by pressing button.

02:F5

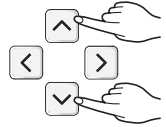

6. Press button to save or release.

02:F5



7. Press button to exit or system will automatically exit after 25 seconds without any input.



Reference: Exiting setting mode

If there is no button entry after the setting for 25 seconds, it will automatically exit the setting mode.

Setting address with wireless remote controller

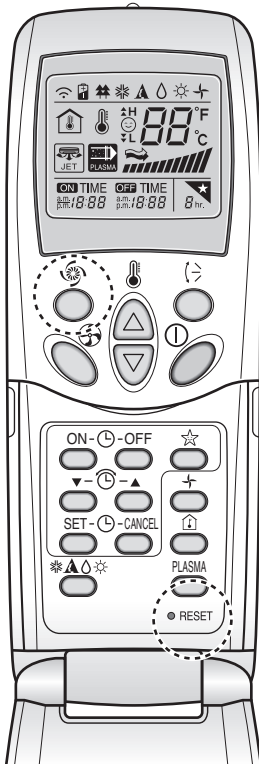

1. With the [Power Cool] button pressed, press the [RESET] button. The [Power Cool] button must be pressed for more than 3 seconds.

2. Use the [Temperature Adjustment] button to set the address of the indoor unit.

Temperature adjustment

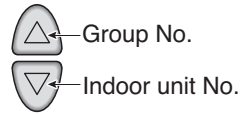

3. After setting the address, press the [Operate/Stop] button once toward the indoor unit.

4. When the set address is displayed on the indoor unit, the address setting is complete.

Reference: Address display time and method

The address display time and method may differ by the type of the indoor unit.

5. When you reset the remote controller, it switches from the address setting mode to general operation mode.

Reference: Type of remote controller

When using a different type of remote controller from the one described above, refer to the user manual of the applicable remote controller.

Information: Checking the set address

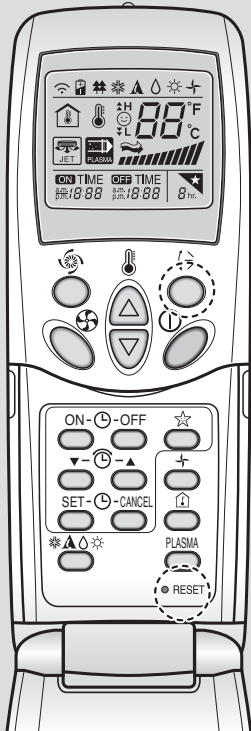



You can check the set address by using the wireless remote controller. To check the set address, proceed as follows.

1. With the [Wind Up/Down] button pressed, press the [RESET] button. The [Wind Up/Down] button must be pressed for more than 3 seconds.
2. Press the [Operate/Stop] button once toward the indoor unit. The set address will be shown on the display part of the indoor unit. The address display time and method can differ by the type of indoor unit.
3. Reset the remote controller again to use it in general operation mode.

Setting ventilator unit address

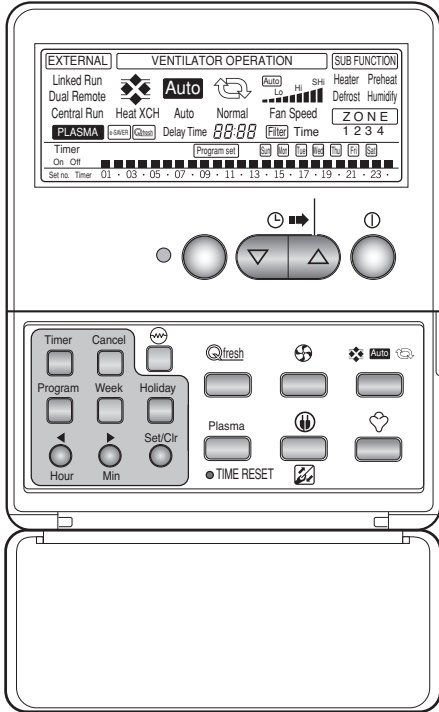
When connecting and using the ventilator with AC SMART II, you must set the address of each ventilator using the wired remote controller. Set the address of the ventilator as follows.



1. To activate the address setting, press the [Program] button and [Set/Clr] button simultaneously for more than 3 seconds.
2. Use the  button to set the address of the ventilator. The range the address can be set is 00~FF.

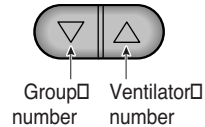

3. Press the [Program] button and [Set/Clr] button for more than 3 seconds to complete the address setting.

Setting AWHP unit address

When connecting and using the AWHP unit with AC SMART II, you must set the address of the AWHP unit using the wired remote controller. Set the address of the AWHP unit as follows.

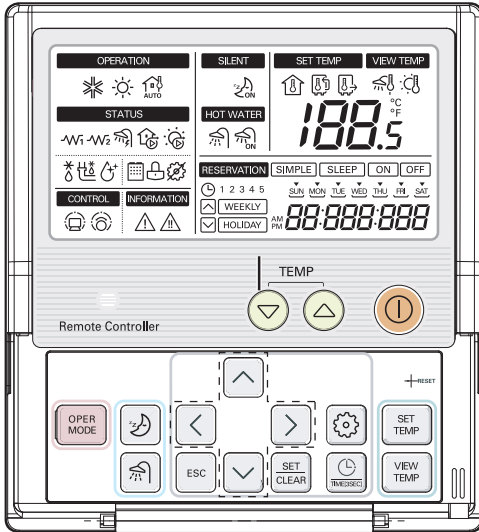

1. Press the Setting button (ⓘ) for more than 3 seconds until the number code is displayed on the timer display block.
2. Continuously press the function setting button (ⓘ) until the function code is set to 07.

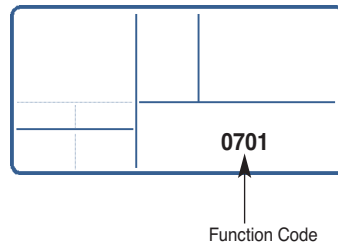

3. Use the [Up], [Down] button to set the first digit. First digit generally designates the group number.

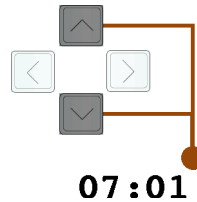

4. Use the [Left], [Right] button to move the cursor to the last digit.

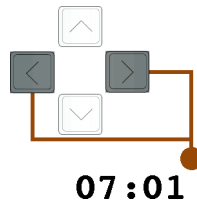

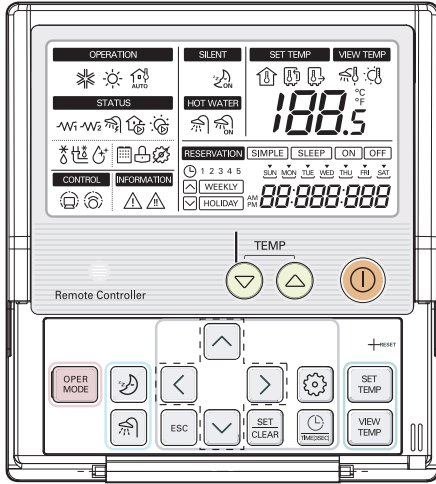

5. Use the [Up], [Down] button to set the last digit. The last digit generally refers to the individual AWHP unit number.

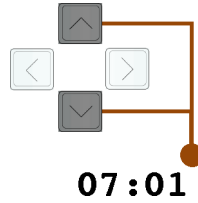

6. After setting the address, press the [SET/CLEAR] button to complete the address setting.
7. Press the [ESC] button to exit the setting mode.

Reference: Exiting setting mode

If there is no button entry after the setting for 25 seconds, it will automatically exit the setting mode.

Setting On/Off unit address

When connecting and using the On/Off unit (PNF-P14A0T) with AC SMART II, you must set the address of the On/Off unit through the rotary switch.

On/Off unit has 2 rotary switches to set the address as shown in the below picture. 'SW-HIGH' rotary switch sets the group number and 'SW-LOW' rotary switch sets number of each On/Off unit.

The following pictures show an example of setting the address of On/Off unit to "3F".

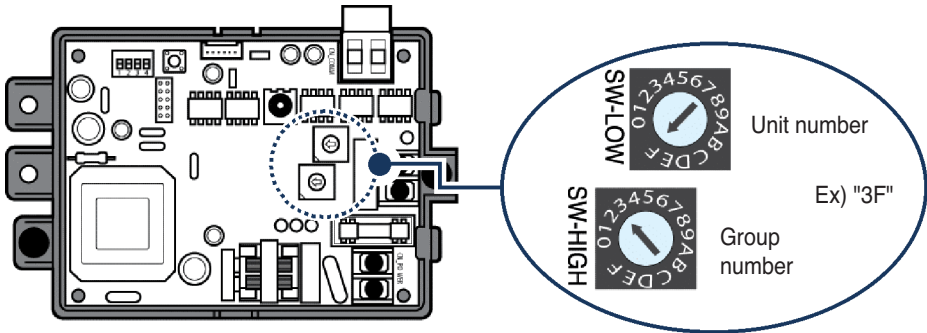

Setting PI485 and connecting line

After setting the address of the unit, you must install PI485 and set the DIP switch. And then you must connect the RS485 line to communication with AC Smart II.

Reference: PI485 installation

The installation of PI485 may differ by the product of the outdoor unit. Therefore, refer to PI485 manual or installation technology information to proceed.

Setting PI485 DIP switch

First set the DIP switch of PI485. You can check the DIP switch of PI485 in the following location. For the model composed of 4 DIP switches, it can be set as follows.

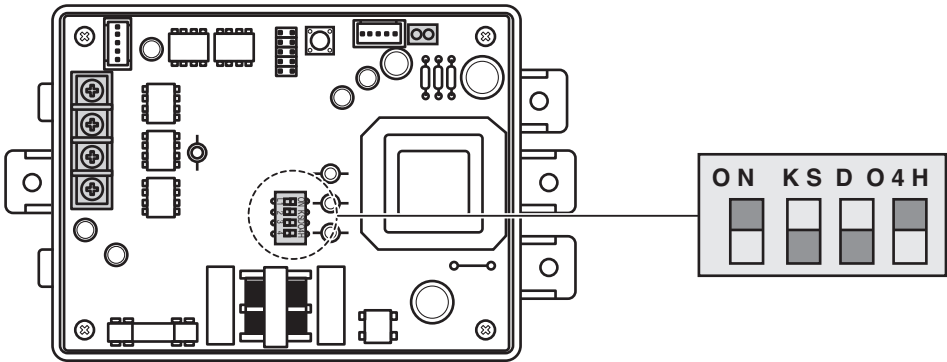

Set the DIP switch as follows depending on the type of outdoor unit PI485 is attached to.

DIP switch	Setting	Product type
	ON: 1, 4	- Multi V product (Excluding CRUN, LRA product)
	OFF: 2, 3	- MPS static speed product with common PCB applied - MPS inverter product
	ON: 2, 4	- MPS static speed product without common PCB applied
	OFF: 1, 3	
	ON: 1, 2, 3, 4	- Multi V CRUN, LRA product
	OFF: -	
	ON: 3, 4	- Single indoor unit (When connected to PI485 for indoor unit, model name PSNFP14A0 / PHNFP14A0)
	OFF: 1, 2	- Ventilator (When connected to PI485 for ventilator, model name PHNFP14A0)

For model composed of 8 DIP switches, it can be set as follows.

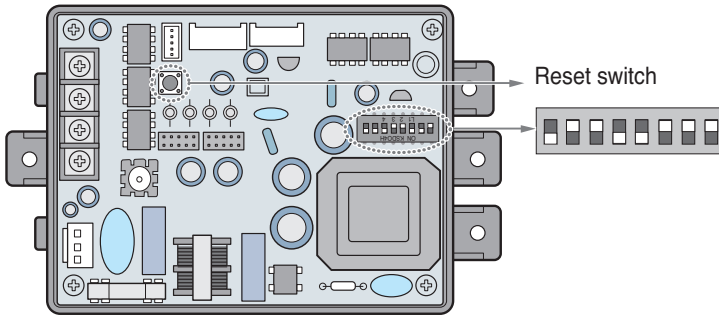

Set the DIP switch as follows depending on the type of outdoor unit PI485 is attached to.

DIP switch	Setting	Product type
	ON: 1, 4	- Multi V product (Excluding CRUN, LRA product) - MPS static speed product with common PCB applied - MPS inverter product
	OFF: 2, 3, 5, 6, 7, 8	
	ON: 2, 4	- MPS static speed product without common PCB applied
	OFF: 1, 3, 5, 6, 7, 8	
	ON: 1, 2, 3, 4	- Multi V CRUN, LRA product
	OFF: 5, 6, 7, 8	

After setting the DIP switch, you must always reset the PI485. Press the reset switch to reset PI485.

Reference: PCB part

MPS static speed applied product with common PCB applied must have the PCB part # as shown as follows.

- PCB P/NO. : 6871A20910A ~ Z
- PCB P/NO. : 6871A20917A ~ Z
- PCB P/NO. : 6871A20918A ~ Z

Caution: PI485 DIP switch setting



When the air conditioner selection switch setting is incorrect, the air conditioner can malfunction.

Refer to PI485 (M) manual for detail installation method of PI485.

Information: Checking PI485 DIP switch setting

You can check whether the indoor unit address setting and the DIP switch setting of PI485 have been set correctly as follows.

- LED01G will flash for as many as the connected number of indoor units.
- LED02G and LED03G will flash in switching back and forth. (When connecting LRA/CRUN product, LED02G can blink more than LED03G).

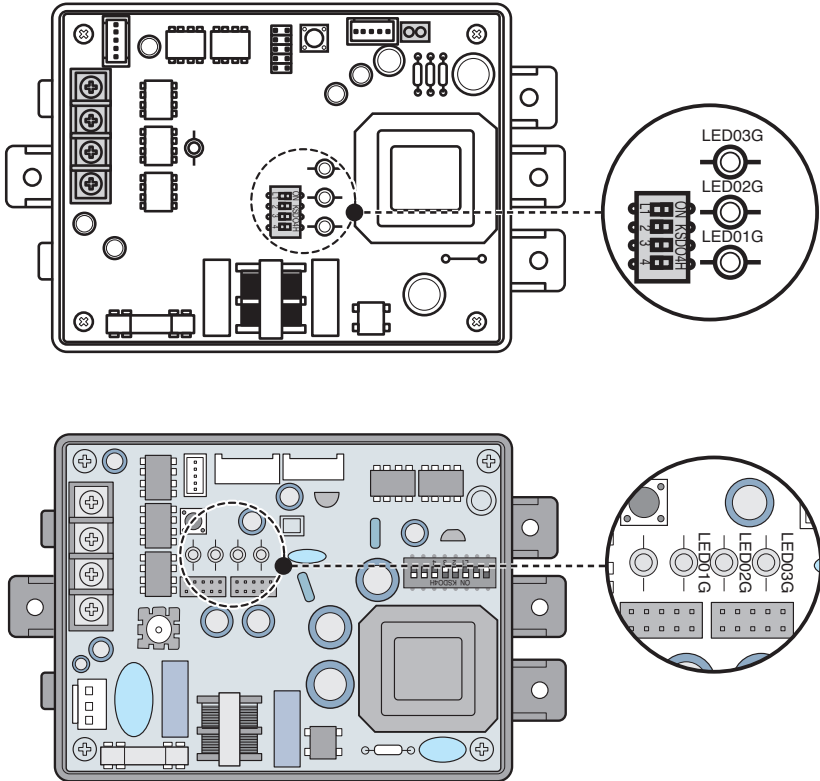

When the LED is abnormal unlike the above description, recheck the address setting of the indoor unit and DIP switch setting.

Setting individual lock function

AC SMART II provides the lock function through the central control to disable individual control of operating mode, fan level and temperature of the indoor unit. To use this lock function, you must connect the 2PIN connector to the CN_DRY of PI485 or set DIP switch #5 to On depending on the outdoor unit product type.

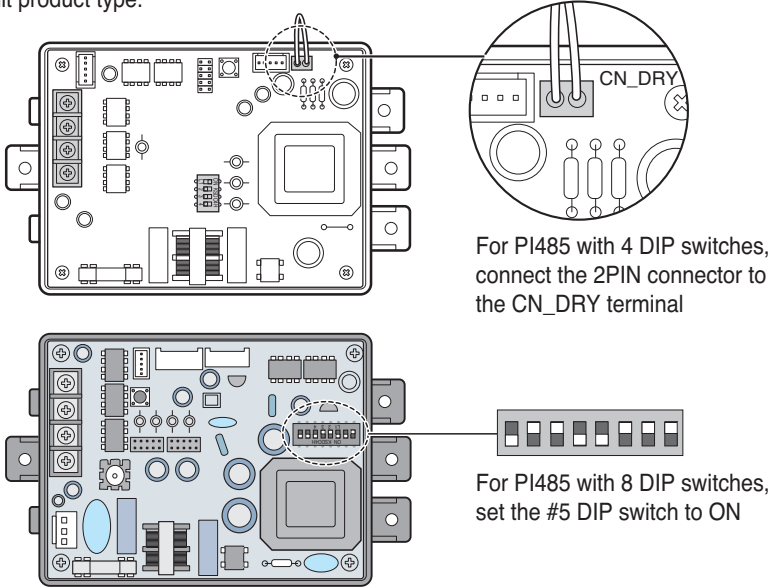

For PI485 with 4 DIP switches, connect the 2PIN connector to the CN_DRY terminal

For PI485 with 8 DIP switches, set the #5 DIP switch to ON

For PI485 with 8 DIP switches, set the DIP switch as follows depending on the type of outdoor unit on which the PI485 is attached.

DIP switch	Setting	Product type
	ON: 1, 4, 5	- Multi V product (Excluding CRUN, LRA product) - MPS static speed product with common PCB applied - MPS inverter product
	OFF: 2, 3, 6, 7, 8	
	ON: 2, 4, 5	- MPS static speed product without common PCB applied
	OFF: 1, 3, 6, 7, 8	
	ON: 1, 2, 3, 4, 5	- Multi V CRUN, LRA product
	OFF: 6, 7, 8	

Reference: Set 2PIN connector and DIP switch #5 ON

The setting method can differ by PI485 number. 2PIN connector connection and DIP switch #5 ON setting is the connector and DIP switch required for PI485 to set the function for the product without the individual lock and temperature setting range within the product.

The following picture shows an example of the central control method when the 2PIN connector is connected to the CN_DRY terminal or when the DIP switch #5 is set to ON.

- 1) Through the central controller, such as AC Smart, you can command the 'Cool operation, 20°C setting, high fan level, temperature lock' function. This command can be provided by the remote controller.
- 2) But if the user changes the temperature to 25°C with the remote controller, the applicable command is sent to the outdoor unit and the 25°C setting is displayed on the remote controller.
- 3) The outdoor unit receives the applicable command and sends it to PI485.
- 4) PI485 cancels this command and resends the prior central control command. And the remote controller redisplay the temperature of 20°C sent through the central control command.

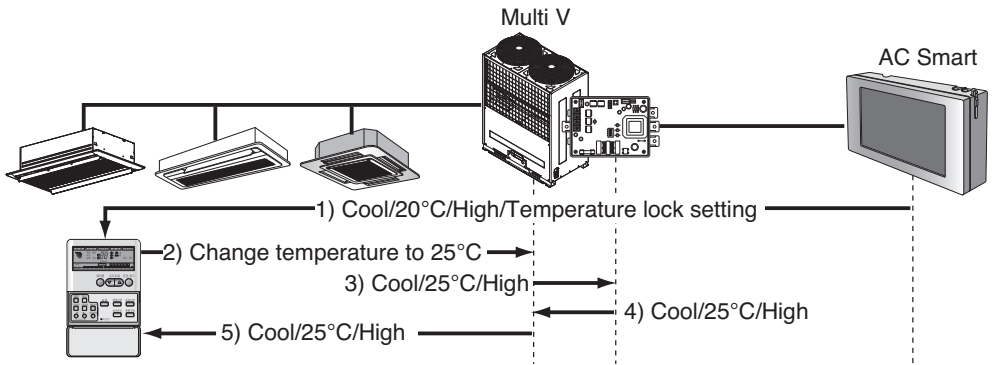

This time, this is an example when the 2PIN connector is not connected to CN_DRY terminal or when the DIP switch #5 is not set to ON.

When you command the “Cool operation, 20°C setting, high fan level, temperature lock” function through central control, the applicable command is transmitted to the remote controller. “HL (Hard Lock)” message displaying the central control status is displayed on the remote controller. If the user sets the temperature to 25°C, the remote controller blocks the user’s command.

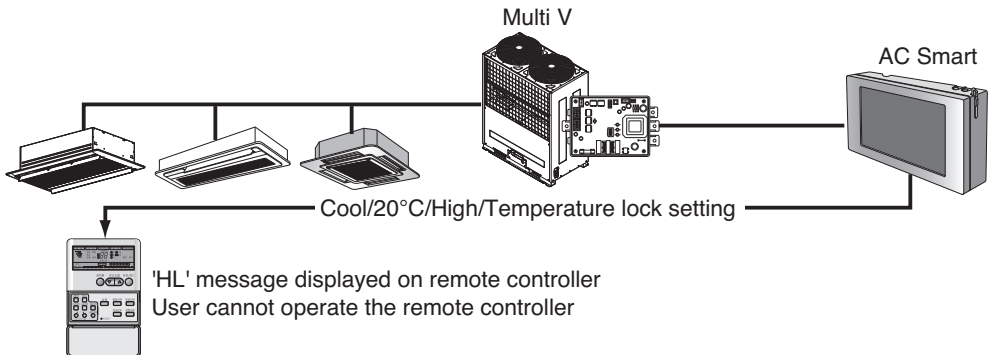

Connecting PI485 to RS485 Line

To connect PI485 and AC Smart, two RS485 lines must be connected to BUS_A and BUS_B of PI485. Refer to the following figure to connect the RS485 line.

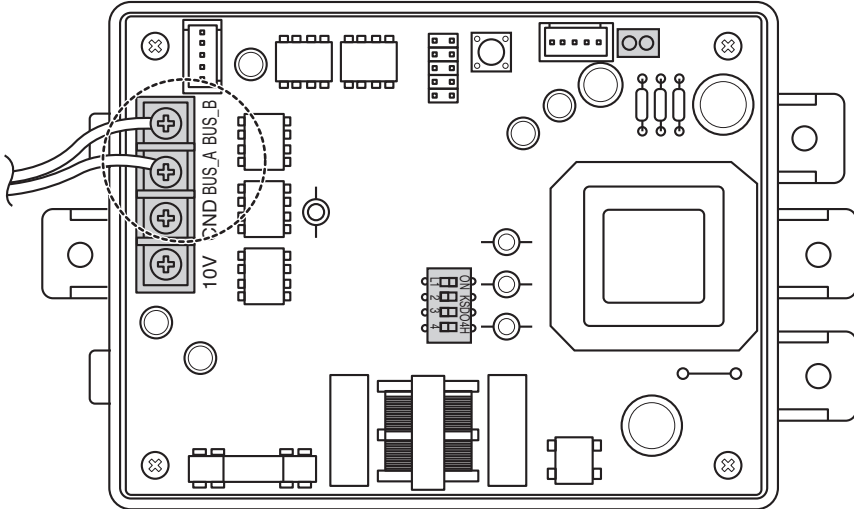

Reference: Connecting RS485 cable to PI485

The shape of PI485 can differ by the number. For details, refer to the installation manual provided with the PI485 product.

The following figure is an example of several units of PI485 connected to AC Smart.

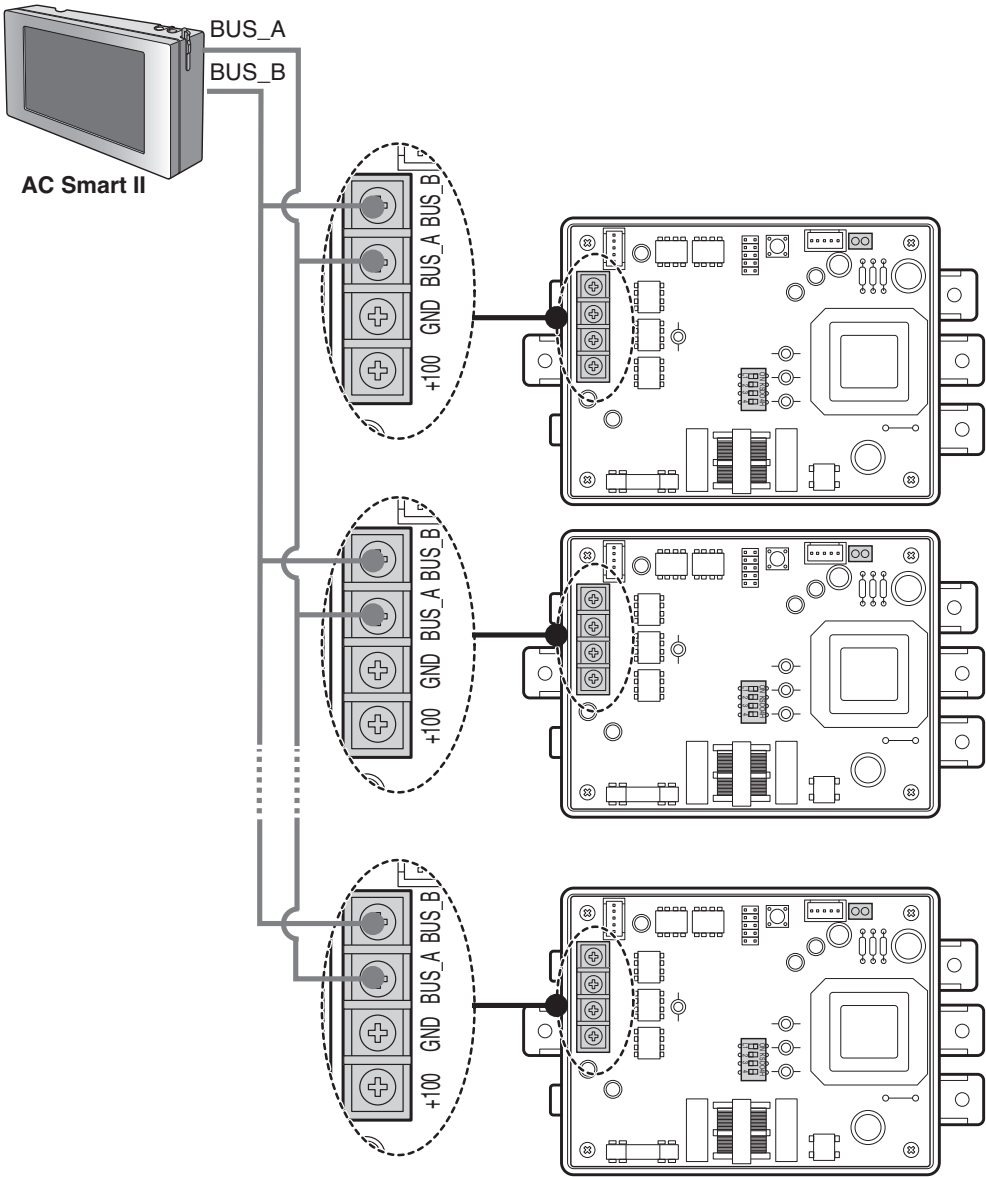

Information: RS485 connection of AC SMART II

Maximum of 64 indoor units can be connected to one AC SMART II, and when the expansion kit is installed, maximum of 128 indoor units can be connected. If there are many number of outdoor units to connect, the outdoor unit must be connected in BUS format. If not, AC SMART II can malfunction.

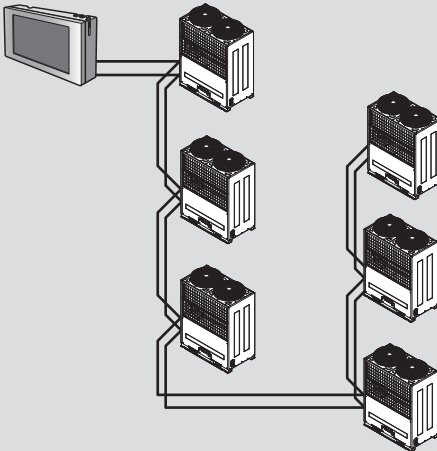

<Correct example: RS485 BUS format connection>

The left picture shows the correct and incorrect example of RS485 communication connection to of AC SMART II.

The upper picture shows the correct example of RS485 connection to outdoor unit with AC SMART II in BUS format.

The bottom picture shows the incorrect example of RS485 connection to outdoor unit with AC SMART II in STAR format.

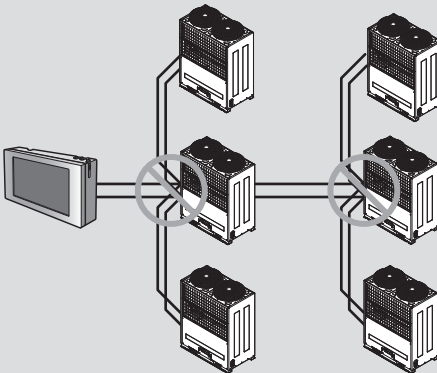

<Incorrect example: RS485 STAR format connection>

Information: Connection setting when using simple central controller with AC Smart

You can use a simple central controller with AC Smart. When you want to use a simple central controller with AC Smart, connect the simple central controller in the order shown as follows.

Reference: Check V-net Label

Check the V-net Label on the right side of the case of the simple central controller. AC Smart II can be simultaneously connected only to the product with the label.

You must connect the VCC and GND terminal of the simple central controller to connection of PI485 or to a separate adapter. For more details, refer to the manual of the simple central

1. Connect the BUS-A and BUS-B port of PI485 to the A and B terminal of the simple central controller using the RS485 communication cable.
2. Set the rotary switch of the simple central controller to align with the group number of the indoor unit to control. For example, when you want to control the indoor units with the address of 00~0F, set the rotary switch to 0.
3. Set the DIP switch No. 1 of the simple central controller to OFF (Slave) and No. 2 to ON (LGAP use mode).

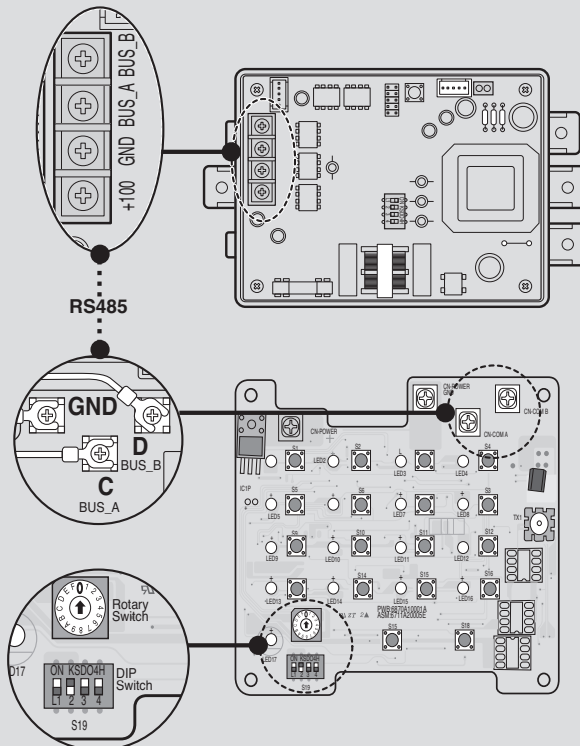

Installing AC SMART II and connecting line

After setting PI485, install AC Smart and connect the RS485 line for communication with PI485.

또한 웹 서버, 이메일 통보 기능을 사용하거나 SVCNet과 통신하고자 할 경우에는 UTP 케이블을 연결해야 합니다.

To install AC Smart and connect the line, proceed as follows.

Reference: AC Smart II installation

AC Smart is designed to be basically installed on the wall. Here, we explain the method of installing AC Smart on the wall as the example.

1. Decide the space to install AC Smart. In order for AC Smart to be installed on the wall, there must be a RS485 line near by.
2. Fixate the rear panel of AC Smart on the wall top of the RS485 line. Fixate the panel using a driver. You can fixate the panel as shown below, depending on the installation location.

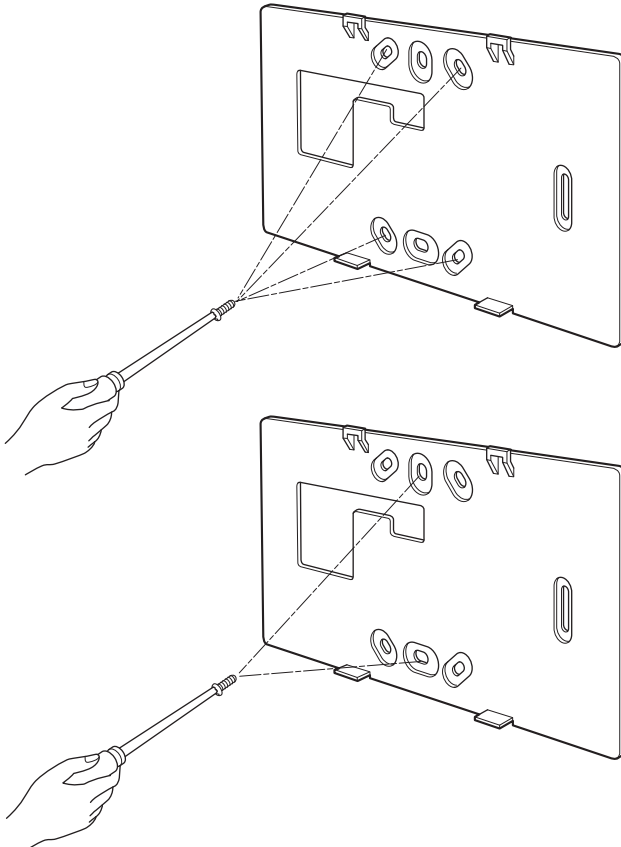

3. Pull out the RS485 cable through the hole of the rear panel and connect it to the socket. Use the '-' driver to connect the two RS485 communication cable as follows.

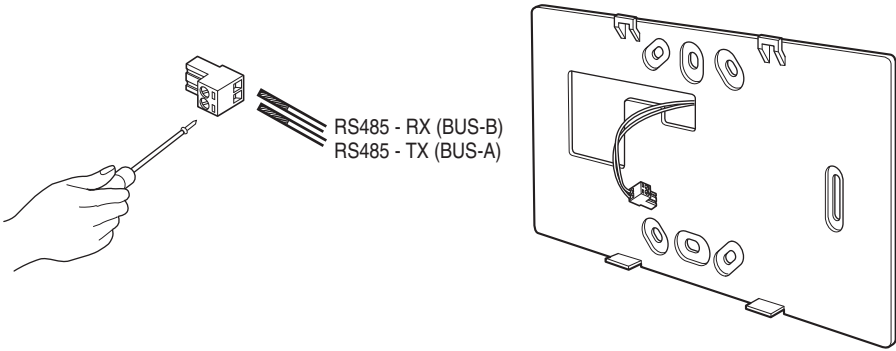

Caution: RS485 communication cable connection



When connecting the RS485 communication cable, be careful not to mix the polarities of the two lines

4. Connect the RS485 socket to the RS485 port located on the rear side of the AC SMART II main unit.

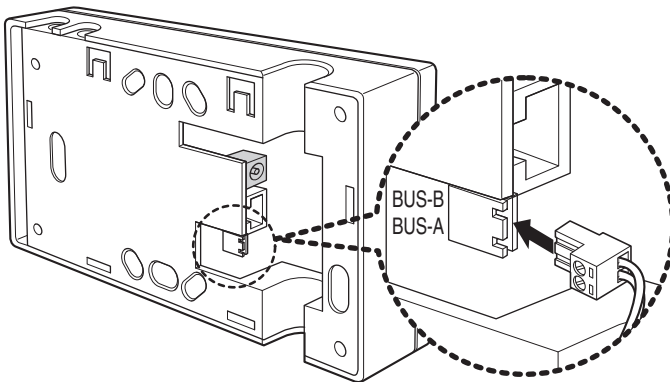

- 5.** To use the network related function provided by AC SMART II (Emaion transmission, SVCNet connection), the UTP cable must be connected.
Connect the UTP cable that can be connected to the Internet on the rear side of the main unit of AC SMART II to the LAN port.

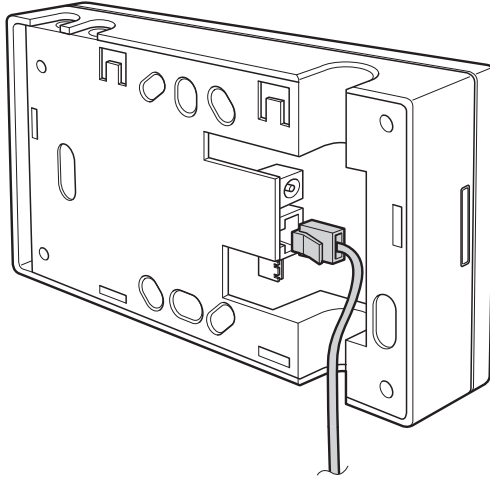

- 6.** Connect the power adapter to the power terminal located at the rear side of the main unit of AC Smart.

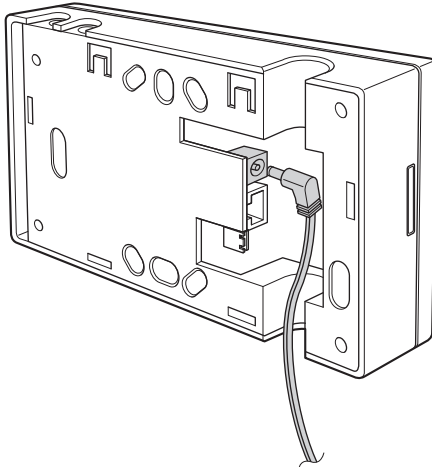

-
7. Assemble the main unit of AC Smart on the rear panel installed on the wall. After hanging the top holes of the main unit to the top of the rear panel, push forward and slide in the bottom of the main unit.

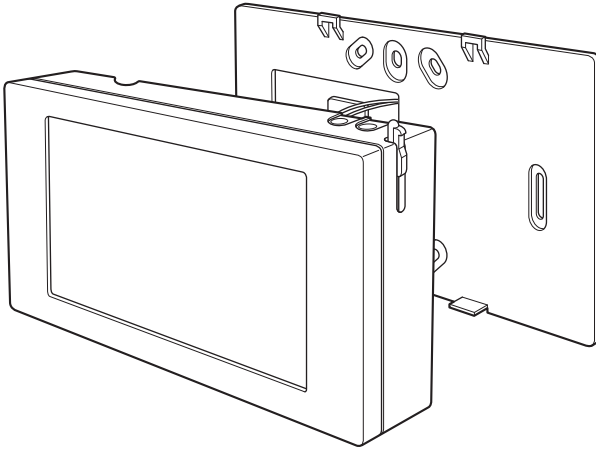

8. Connect the power cord of the power adapter to the power outlet.

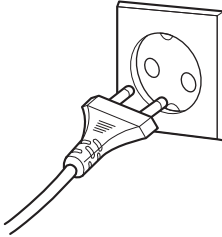

Logging in of AC SMART II

When the power is applied to the AC Smart, the AC Smart automatically operates. When the AC Smart II operates, the LG logo screen is initially displayed and then changed to the login screen. The AC Smart II can be logged in with three method such as professional, administrator and general user as follows:

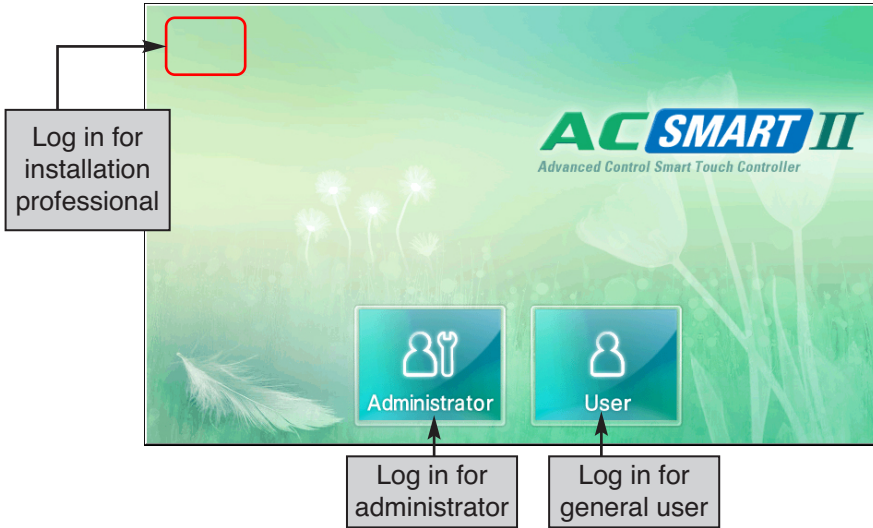

Here, the installation personnel with the authority must log in to AC SMART II for the setting required for the installation process of AC SMART II. To log in with the installation expert authority, proceed as follows.

1. When you press and hold the top left of the log-in screen for 5 seconds, the password screen is displayed to enter the password.

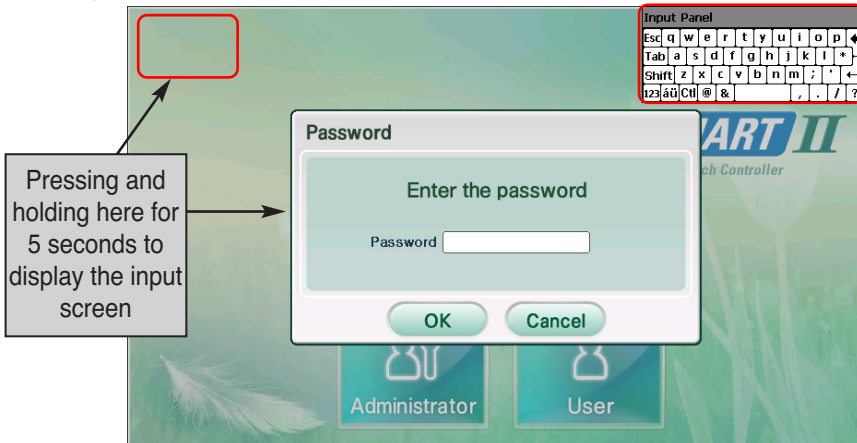

2. The password is 'digital21' which cannot be changed. When you correctly enter the password and press [OK] button, you are logged in and can set all functions of the AC Smart.

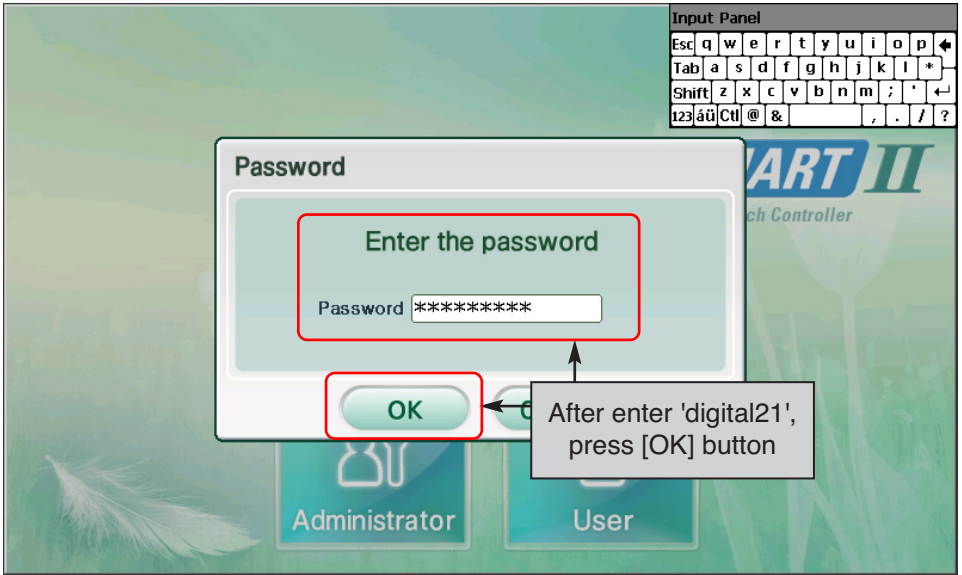

3. When you log in, the following menu screen will be displayed and you can use all functions of AC SMART II.

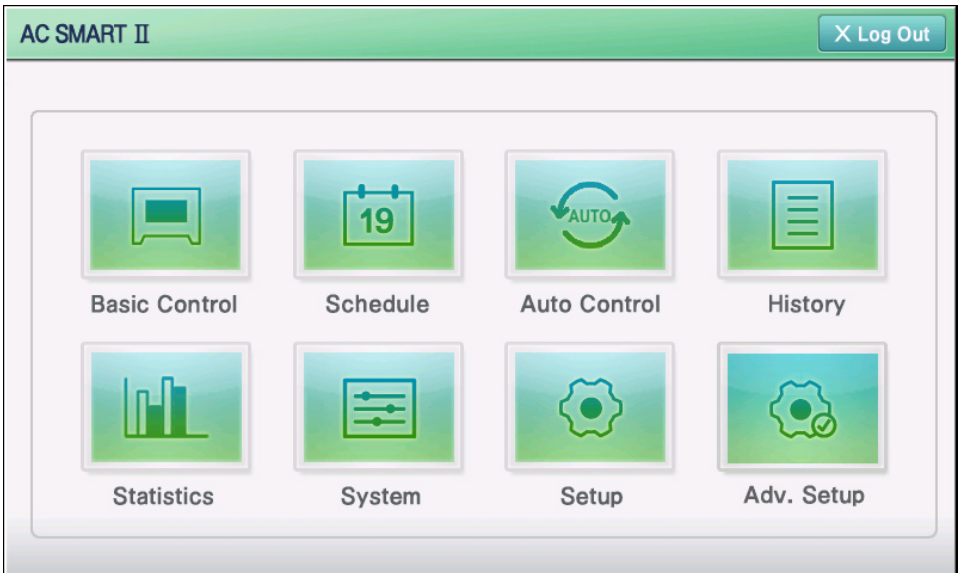

Registering the unit

After connecting PI485 to AC Smart, you must operate AC Smart to register the unit the address has been set to.

You can register the unit in 2 methods to AC Smart.

- Automatically registering the unit
- Directly registering the unit

Note: Login right for registering a unit

In order to register a unit to the AC Smart, you should log in as installation professional. This menu is not displayed on the screen when logging in as administrator or general user.

Automatically registering the unit

You can automatically search and register the unit connected to AC Smart. To automatically register the unit, proceed in the following order.

1. After logging in with installation professional to AC SMART II, select the 'Device management' menu from the menu.

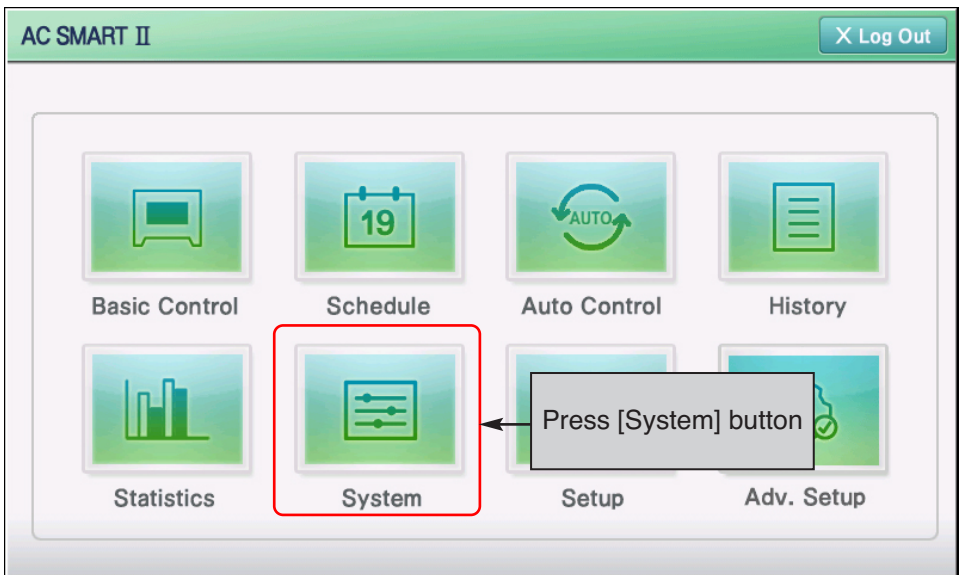

2. When you select the 'Device management menu, the following screen will be displayed. Press the [Device registration] button located on the bottom right side.

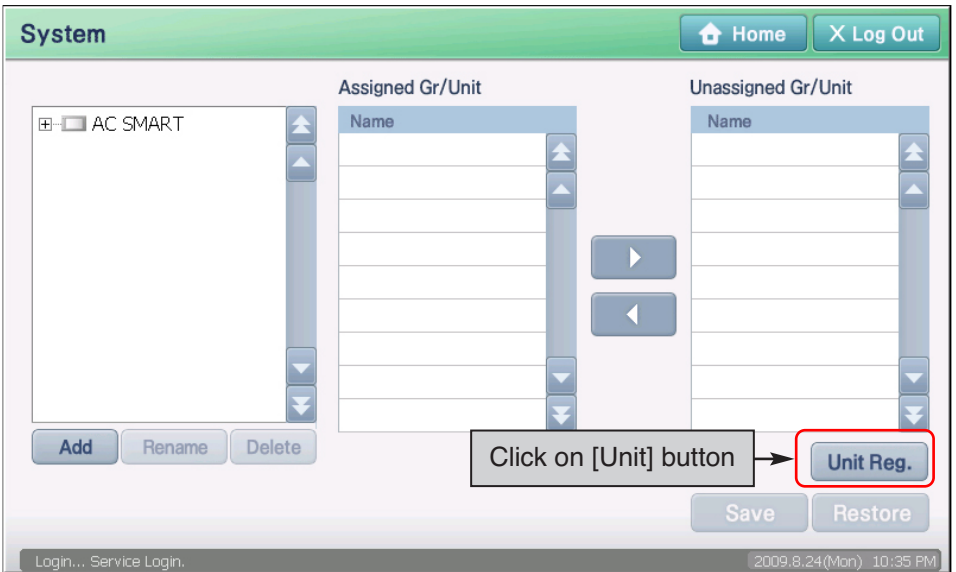

3. 'Device registration' screen will be displayed. When you press the [Auto set] button, the 'Confirmation' screen to check the execution of auto setting will be displayed. Press the [Yes] button.

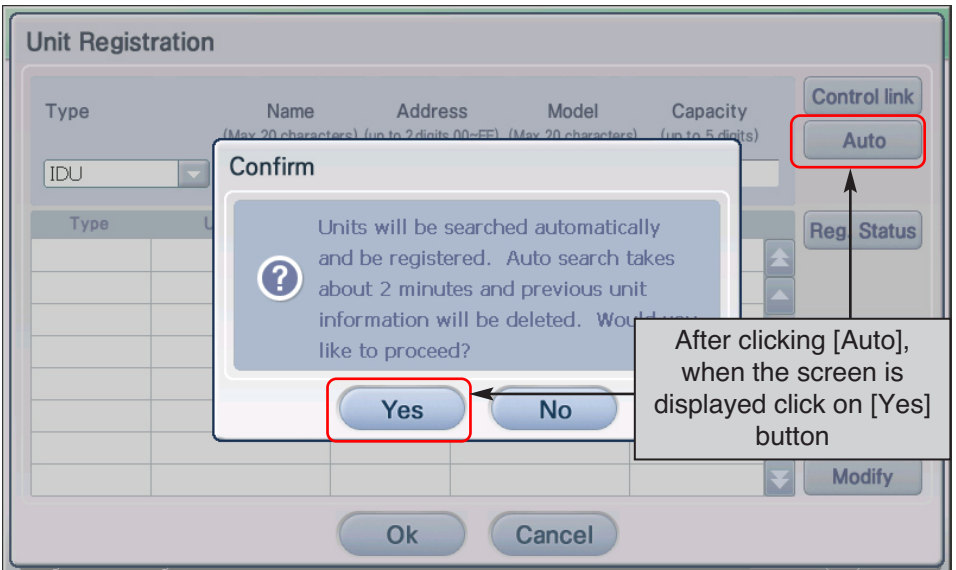

4. The process to search for and register the indoor unit and the ventilator connected to the AC Smart II proceeds. When this process is finished, the registered unit is added and displayed at the table located at the bottom of the screen.

The screenshot shows the 'Unit Registration' interface. At the top, there are input fields for 'Type' (set to IDU), 'Name' (Unit-0), 'Address' (10), 'Model' (Default), and 'Capacity' (N/A). Below these is a table with columns: Type, Unit Name, Address, Model, Capacity, and Reg. Status. A red box highlights a 'Waiting ... 28 %' progress indicator in the table. A callout box with an arrow points to this indicator, containing the text: 'After the device search, the result will be displayed.' At the bottom of the screen are 'Ok' and 'Cancel' buttons.

5. Temporarily store the searched unit. When you press [OK] button, the 'Confirm' screen for confirming saving is displayed. When you press 'Yes' button, saving is done and it returns to the previous screen.

This screenshot shows the 'Unit Registration' screen with a 'Confirm' dialog box overlaid. The dialog box contains a question mark icon and the text: 'Modified data will be temporarily saved. Would you like to save it?'. Below the dialog box, the 'Yes' and 'Ok' buttons are highlighted with red boxes. A callout box with arrows points to these buttons, containing the text: 'To apply to system click on [OK] button, 'When the 'Information' screen is displayed click on [Yes] button'. The background shows the same unit registration form as in the previous screenshot, but with a list of unit types (IDU, Vent, On/Off De..., AWHP) visible in the table.

6. Finally, the temporarily saved unit setting should be registered to the system. When [Save] button is pressed, 'Information' screen to check whether to apply the current setting to the system is displayed. Press [Yes] button.

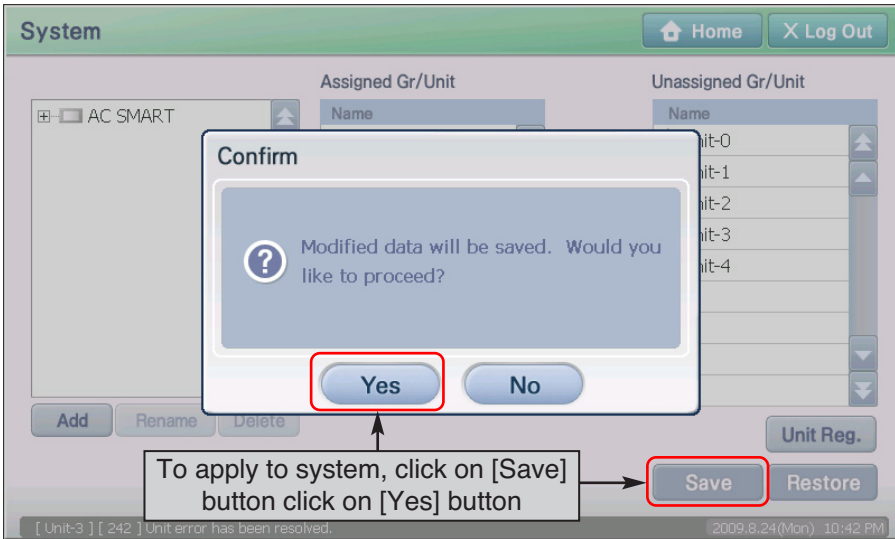

7. Current setting will be applied to the system and the message saying that the setting has been saved will be displayed. Click on the [OK] button to complete the registration.

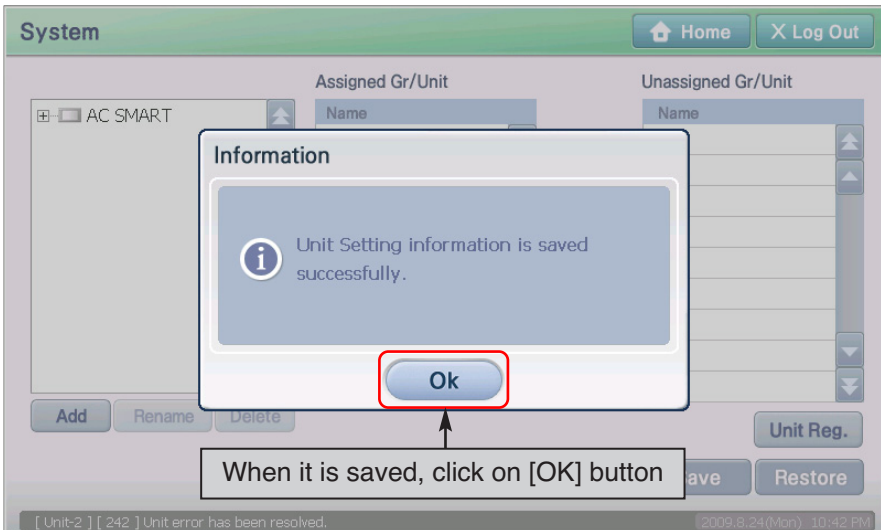

Reference: Change information of registered unit

When you want to change the information of the registered unit such as name, or form a group with the units, refer to the 'Setting' section on page 4-106.

Directly registering the unit

You can directly register the unit connected to AC Smart. To register the unit, proceed in the order as follows.

1. After logging in as installation professional to AC SMART II, select the 'Device management' menu from the menu.

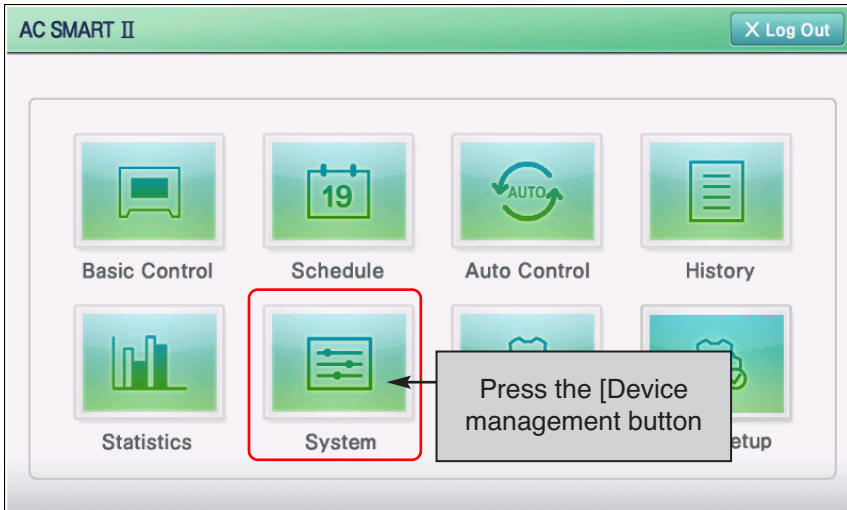

2. When you select the 'Device management' menu, the following screen will be displayed. Press the [Device registration] button at the bottom right side.

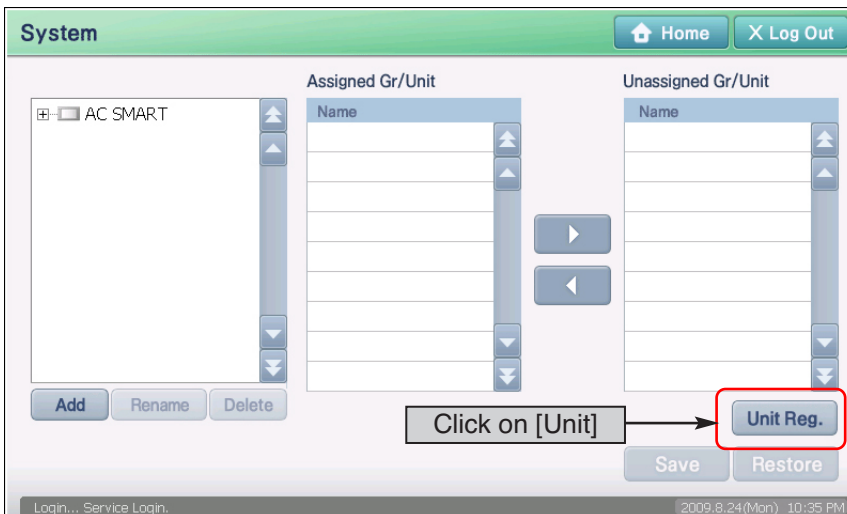

3. 'Unit Registration' screen is displayed to register a unit. Enter the unit information and press [Add] button. See the following table for the information to enter.

Item	Description
Type	Enter the type of unit - Air conditioner, Ventilator, On/Off device, AWHP
Name	Enter the name of unit. The name can be entered to maximum of 20 letters.
Address	Enter the physical address of the unit. The physical address value is a number in the range of 00~FF and cannot be duplicated.
Model	Enter the model of the unit. Maximum of 20 characters can be entered for the model.
Capacity	Enter the maximum power consumption of the unit. The power must not exceed the set value. You can enter up to maximum of 5 digits.

4. The information of the added unit is displayed in the table. Register all the units to add by repeating the same procedure. To save the registered units, click on the [OK] button.

Unit Registration

Type: Name: Address: Model: Capacity:

Control link:

Type	Unit Name	Address	Model	Capacity	Reg. Status
IDU	Unit-0	10	Default	N/A	<input type="button" value="Add"/>
Vent	Unit-1	00	Default	N/A	<input type="button" value="Delete"/>
On/Off De...	Unit-2	02	Default	N/A	<input type="button" value="Modify"/>
AWHP	Unit-3		Default	N/A	
AWHP	Unit-4		Default	N/A	
AWHP	Unit-5		Default	N/A	

Click on [OK] button to apply to system

5. 'Confirm' screen to temporarily save the current setting is displayed. When [Yes] button is pressed, it exits from 'Unit Registration' screen and returns to the previous screen.

Unit Registration

Type: Name: Address: Model: Capacity:

Control link:

Type	Unit Name	Address	Model	Capacity	Reg. Status
IDU	Unit-0	10	Default	N/A	<input type="button" value="Add"/>
Vent	Unit-1	00	Default	N/A	<input type="button" value="Delete"/>
On/Off De...	Unit-2	02	Default	N/A	<input type="button" value="Modify"/>
AWHP	Unit-3		Default	N/A	
AWHP	Unit-4		Default	N/A	
AWHP	Unit-5		Default	N/A	

Confirm

Modified data will be temporarily saved. Would you like to save it?

When 'Confirm' screen is displayed, click [Yes] button.

6. Finally, the temporarily saved unit setting should be registered to the system. When [Save] button is pressed, 'Confirm' screen to check whether to apply the current setting to the system is displayed. Press [Yes] button.

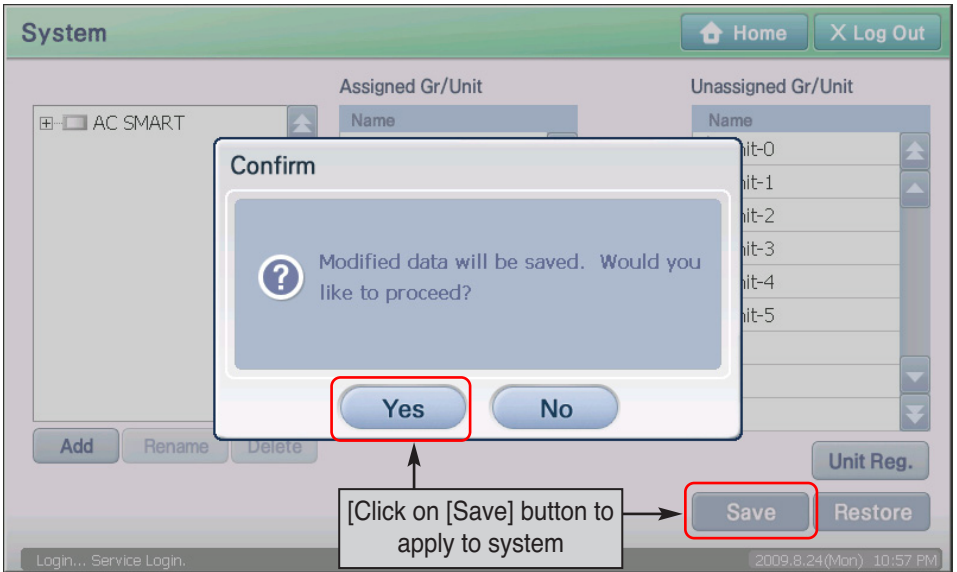

7. Current setting will be applied to the system and the message saying that the setting has been saved will be displayed. Click on the [OK] button to complete the registration

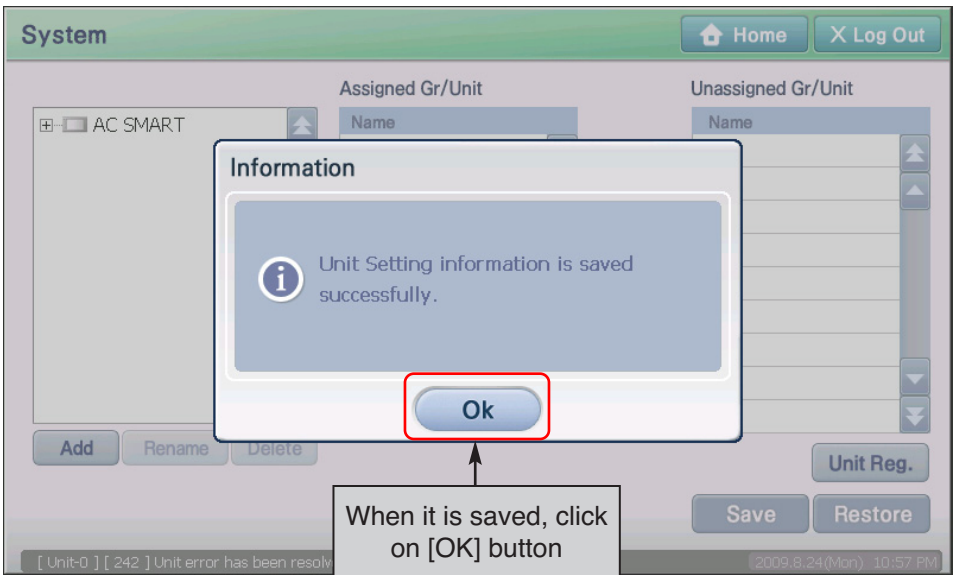

Setting the emergency stop interlocking

AC Smart has an emergency stop interlocking that stops all the indoor units and ventilators set in case of a fire or any other emergency situation. You can use the emergency stop function by connecting the external fire detection sensor to the connection terminal of external non-contact point method on the rear side of AC Smart II as shown below.

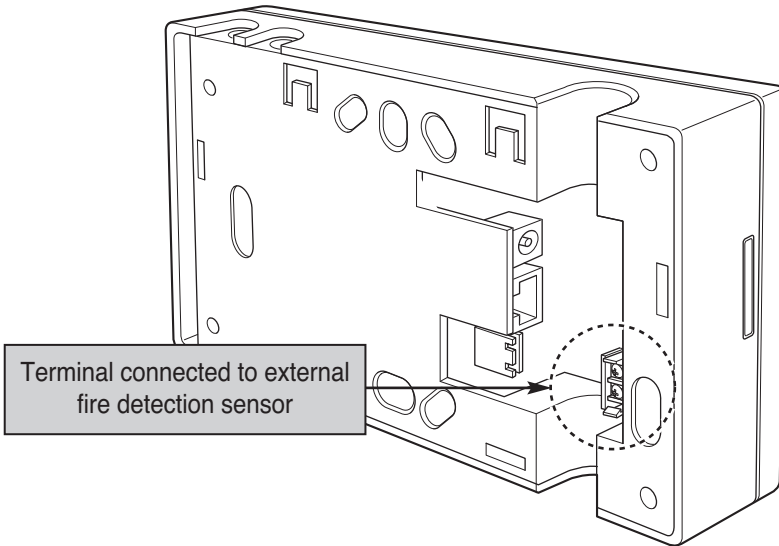

When the fire sensor generates the ON signal, the AC Smart stops the operation of all indoor units.

3. AC Smart II Menu

This chapter describes the AC SMART II menu and screen configuration to operate AC SMART II.

AC SMART II screen configuration

When you log in to AC SMART II, the menu selection screen is displayed.

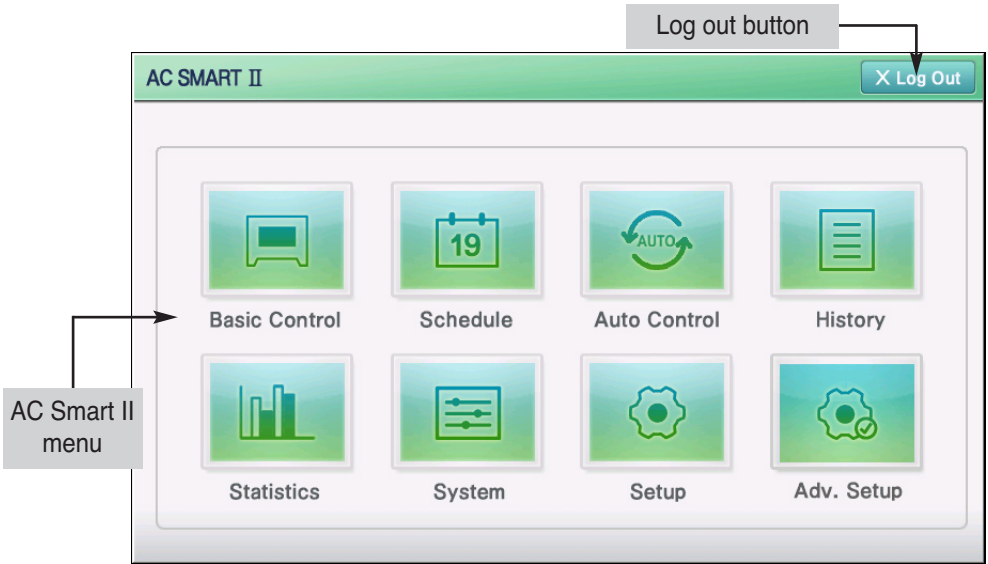

Log out button

When you press the log out button, you will log out from AC Smart and return to the log in screen.

AC SMART II Menu

This displays the function provided by AC SMART II. When you press the function to execute, it will change to the applicable function screen.

Reference: General user authority login

When you log in as general user, this screen will not be displayed, and it will directly switch to the 'Control/Monitoring' menu screen.

When the user selects a specific function, the execution screen of the applicable function is displayed. The example of Control/Monitoring menu is used hereafter.



Home button

When you press the Home button, it will switch to the menu selection screen of AC SMART II.

Log out button

When you press the log out button, you will log out from AC Smart and return to the log in screen.

Function execution screen

You can operate the function for each menu from the Function execution screen.

Message window

Message window notifies the user of various types of information depending on the functional operation and status of AC Smart.

AC SMART II information entry method

AC SMART II uses the touch screen method to have the user enter the information, and provides the software keyboard (Keyboard) to enter the character.

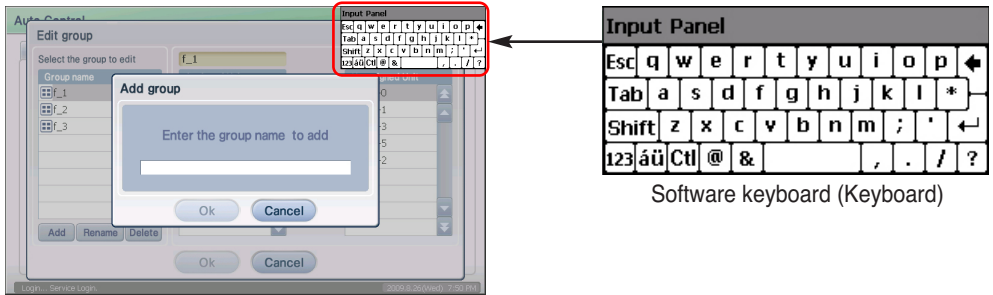

Software keyboard (Keyboard)

Generally in situations to enter the character, the software keyboard is automatically displayed on the screen. But if the software keyboard does not appear on the screen, press the keyboard button located on the top part of AC SMART II to activate the software keyboard on the screen.

Also if you want to close the keyboard on the screen while using AC SMART II, press the keyboard button to close the keyboard on the screen.

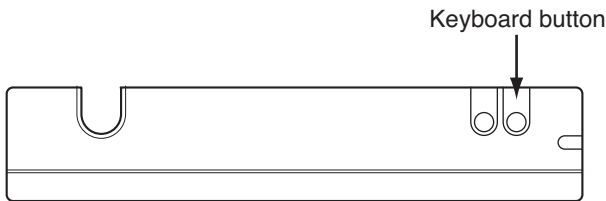

Caution: Use of stylus pen



When entering the information through touch screen, use the stylus pen provided with AC SMART II to prevent any error or damage to AC SMART II.

Logging on AC SMART II

When the power is applied to the AC Smart, the AC Smart automatically operates. When the AC Smart operates, the LG logo screen is initially displayed and then changed to the login screen.

The AC Smart can be logged in with three methods such as professional, administrator and general user as follows:

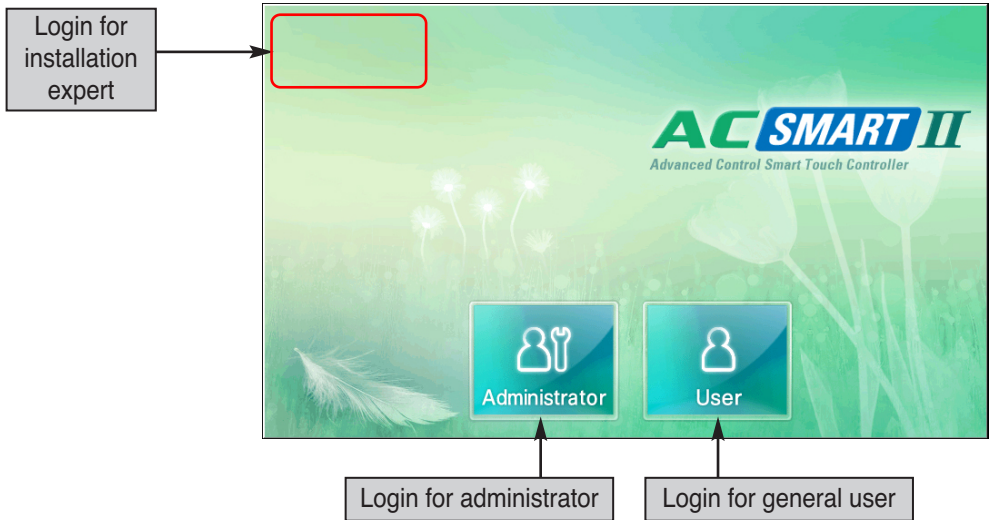

Log in for installation professional

When you log on with the installation professional, you can set all the functions related to installation and related functions of SMART II. But it is recommended to use the installation professional only when changing the key setting related to the installation.

Log in for administrator

When you log on as the installation professional, you can use all the functions excluding the 'Advanced environment setting' menu provided by installation professional.

Log in for general user

When you log in as general user, you can use only the 'Control/Monitoring' menu to monitor and control the operation of the current air conditioner and cannot use other functions.

Logging in as installation professional

To login as installation professional, proceed as follows.

1. Press the top left part of the log in screen for more than 5 seconds, and the software keyboard and password entry screen are displayed.

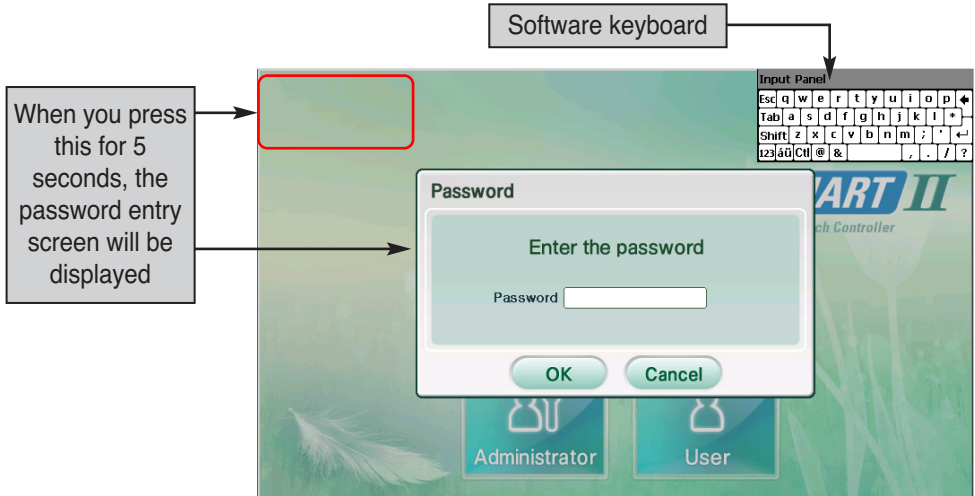

2. The password is 'digital21' which cannot be changed. When you correctly enter the password and press [OK] button, you are logged in and can set all functions of the AC Smart.
3. After the login, the following menu screen will be displayed, and you can use all the functions of AC SMART II.

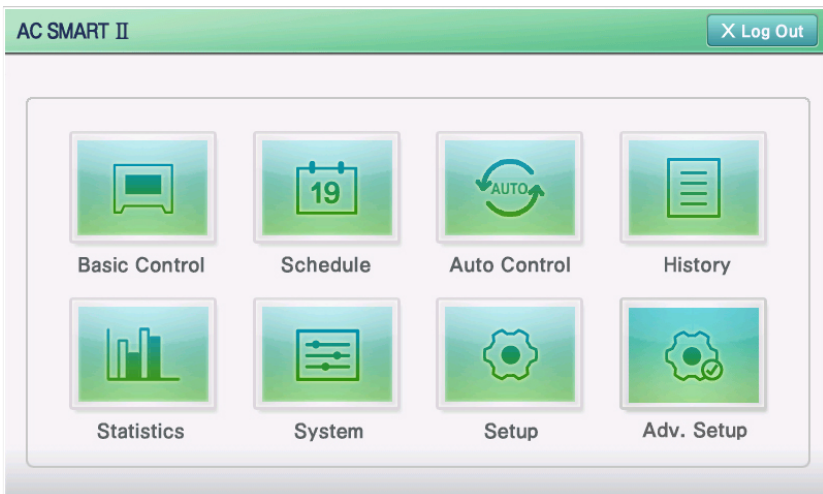

Logging in as administrator

To log in as administrator, proceed as follows.

1. When you press the 'Administrator' button, the software keyboard and password entry screen will be displayed.

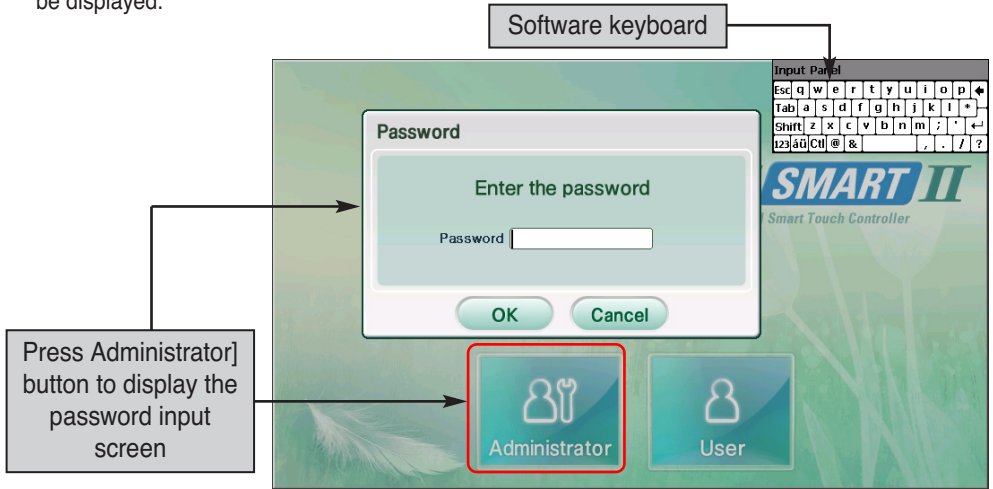

2. Enter the password correctly and press the [OK] button to login to AC SMART II.

Reference: Administrator login password

When logging in as administrator for the first time on AC SMART II, the password is not set. You can set the password from the 'Environment Setting' menu.

3. After the login, the following menu screen will be displayed, and you can use all functions excluding the 'Advanced environment setting' menu.

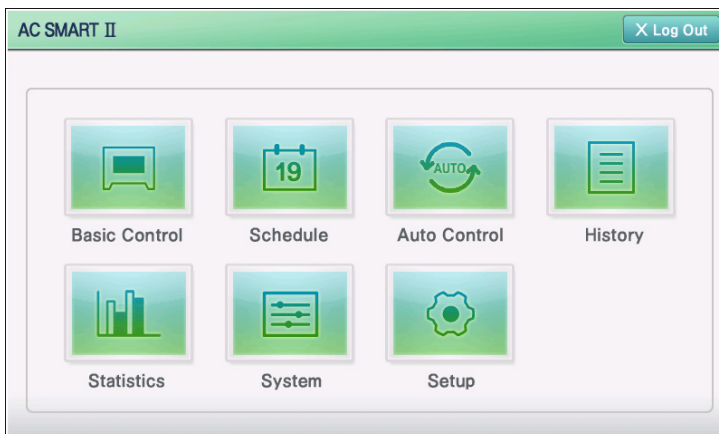

Logging in as general user

To log in as a general user, proceed as follows.

1. When you press 'General user' button, it is directly logged into the AC Smart with no password input procedure.



If pressing general user button,
Log-In without input password

2. When logged into the AC Smart, only the functions of the 'Control/Monitoring' menu can be used and other menu cannot be selected.



4. AC Smart II Menu

Control/Monitoring is the menu for the user to manage multiple units that can be commonly controlled as a group.

There are 4 types of units that can be controlled.

- Indoor unit: Unit that controls the indoor temperature through air conditioning/heating
- Ventilator: Unit that maintains clean air through air circulation
- On/Off unit (DO Kit): Unit that controls the unit that can be turned On/Off (Ex: Fluorescent light)
- AWP unit: Unit that controls the indoor air conditioning/heating temperature and hot water temperature

You can control the units in the following units in control/monitoring menu.

- Zone: Logical set of groups to be configured according to installed location or executing function
- Group: Logical set of units to be configured according to installed location or executing function
- Unit: Smallest controlled unit installed at the indoor such as air conditioner or ventilator

Control/Monitoring menu screen is configured as follows.

Caution:



If many devices are selected simultaneously for control, the common function of the selected devices is controlled simultaneously.

The screenshot shows the 'Basic Control' interface. At the top, there are navigation buttons: 'Up', 'All Zones', 'All Groups', 'All Units', and 'Unit-0'. A dropdown menu is open showing 'Unit-0', 'Unit-1', 'Unit-2', 'Unit-3', and 'Unit-4'. Below this is a row of icons for each unit. The 'Unit-0' icon is highlighted. On the right, there is a 'Log Out' button and a dropdown menu set to 'Icon'. The main display area shows 'Monitoring' and 'Control' tabs. The 'Monitoring' tab is active, displaying 'Room temp.(°C)' as '000' and 'Set temp.(°C)' as '018'. Other settings include 'Mode' (Cool), 'Lock' (On), 'Swing' (Off), and 'Fan speed'. There are 'All Stop', 'Run', and 'Stop' buttons on the right. The bottom status bar shows '[Unit-4] Basic Control, ... Unit was controlled.' and the date/time '2009.8.24(Mon) 11:46 PM'.

Callout boxes provide the following explanations:

- Up:** Can move up the hierarchy or select all zone, group or unit.
- All Zones, All Groups, All Units, Unit-0:** Displays all names included in higher hierarchy where selected object is part of.
- Unit-0, Unit-1, Unit-2, Unit-3, Unit-4:** Can change the information display format between icon and table format.
- Unit-0, Unit-1, Unit-2, Unit-3, Unit-4 (Icons):** Displays zone, group or unit status in icon or table format.
- Monitoring/Control:** Displays or controls the detail information of selected zone, group or unit.
- All Stop:** Stops all registered units.

Examine control/monitoring information

This chapter explains a variety of information provided from Control/Monitoring menu.

Zone, group, and unit status display

Status display of zone, group and unit

Control/Monitoring menu displays the status of Zone, Group or Unit (Indoor unit, ventilator) through the following icons.

When you set the information display format of the screen to 'Icon', the screen will be displayed as follows.

	ICON					
	Zone	Group	Indoor unit	Ventilator	On/Off unit	AWHP unit
Normal operation						
Alarm						
Not in operation						











When you set the information display format of the screen 'Simple', the screen will be displayed as follows.

	ICON					
	Zone	Group	Indoor unit	Ventilator	On/Off unit	AWHP unit
Normal operation						
Alarm						
Not in operation						











Unit operating mode display

AC SMART II displays the operating mode of each unit as the following icon.

When you set the information display format to 'Icon', the screen will be displayed as follows.

Unit type	Icon	Description	Icon	Description	Icon	Description
Indoor unit		Cool mode		Heating mode		Auto mode
		Dehumidifier mode		Fan mode	-	-
Ventilator		Heating mode		General mode		Auto mode
AWHP		Cool mode		Heating mode		Auto mode

When you set the information display format to 'Simple', the screen will be displayed as follows.

Unit type	Icon	Description	Icon	Description	Icon	Description
Indoor unit		Cool mode		Heating mode		Auto mode
		Dehumidifier mode		Fan mode	-	-
Ventilator		Heating mode		General mode		Auto mode
AWHP		Cool mode		Heating mode		Auto mode



Reference: On/Off unit operating mode

Unlike other units, the On/Off unit does not have any operating mode and the operating mode is not displayed on the screen.

Unit alarm display

AC SMART II shows the current alarm through the following icons. Here, the indoor unit among various types of units is used as an example.

When you set the information display format to 'Icon', it will be displayed as follows.

Alarm	Description	Alarm	Description	Alarm	Description
	#242 error (Communication error)		#251 error (128 room expansion kit error)		Other error

But if you set the information display format to 'Simple', it will be displayed as follows.

Alarm	Description	Alarm	Description	Alarm	Description
	Communication error		128 room expansion kit error		Other error

Changing display format of Zone, Group and Unit information

Zone, Group and Unit information is basically displayed in Icon format. But you can change the display format to Table format.

When you change the drop down box at the top right corner of Control/Monitoring menu to "Details", you can change the information of Icon format into Table format.







The screenshot shows the 'Basic Control' interface. At the top, there are navigation buttons for 'Home' and 'Log Out'. Below that, there are tabs for 'All Zones', 'All Groups', and 'All Units', with 'Unit-0' selected. A dropdown menu is set to 'Advanced'. The main area displays a table with the following columns: Unit name, Control Setup, Error, Swing, Fanspeed, Room/SetTemp, Lock, M/T/F Lock, and Set temp. range.

Unit name	Control Setup	Error	Swing	Fanspeed	Room/SetTemp	Lock	M/T/F Lock	Set temp. range
Unit-0		0	Off	Low	-20 / 18	Lock	M:0 T:0 F:0	16~30
Unit-1		0	--	SHigh	--	Lock	--	--
Unit-2		0	--	--	--	--	--	--
Unit-3		0	--	--	--	Lock	--	--
Unit-4		0	--	--	--	Lock	--	--

At the bottom of the interface, there are buttons for 'All Stop', 'Run', 'Stop', and 'Advanced'. The status bar at the very bottom shows the date and time: 2009.8.24(Mon) 11:48 PM.

In the Table format, the following information is displayed according to the selection of Zone, Group and Unit.

Type	Item	Description
When Zone or Group is selected	Name	Name of selected Zone or Group is displayed.
	Number of units	Total number of units is displayed.
	Number of units in operation	Number of units in operation is displayed.
	Number of units in Alarm	Number of units in error condition is displayed.
	Average indoor temperature	Average indoor temperature of installed indoor units is displayed. Indoor unit not in operation and indoor unit with communication error (Code: 242) and expansion kit error (Code: 251) are excluded from the measurement of average indoor temperature.
	Average set temperature	Average temperature of set temperature of indoor units is displayed. Indoor unit not in operation and indoor unit with communication error (Code: 242) and expansion kit error (Code: 251) are excluded from the measurement of average set temperature.
When unit is selected	Unit name	Operating mode and name of the unit is displayed. The operating mode is displayed as Icon and it is the same icon as the one shown when the information display method is set to 'Simple'.
	Control setting	Schedule or auto control function is displayed as Icon. <ul style="list-style-type: none"> •  : When schedule is set •  : When temperature limit operation is set •  : When auto switch operation is set •  : When time limit operation is set
	Error	When there is an error on the unit, the error code is displayed.
	Wind direction	Wind direction setting on the unit is displayed.
	Fan level	Fan level set on unit is displayed.
	Indoor/Set temperature	Indoor and desired temperature where the indoor unit is installed is displayed.
	All lock	All lock function of unit is displayed. All lock function is the function to disable all functions of the unit so that the user cannot individually control the unit where it is installed indoors. <ul style="list-style-type: none"> • Enable lock: When lock function is set • Disable lock: When lock function is canceled

Type	Item	Description
When unit is selected	Individual lock	Individual lock function of unit is displayed. Individual lock function is the function to disable particular functions individually so that the user cannot individually control the unit where it is installed indoors. <ul style="list-style-type: none"> • M: Mode lock function condition • T: Temperature lock function condition • F: Fan level function condition
	Set temperature range	Limited range of the temperature that can be set for the indoor unit is displayed.

Reference: Monitoring and control tab

When you change the information display format to "Details", the monitoring and control tab at the bottom of the screen is not displayed.

Zone, Group and Unit monitoring

There is a 'Monitoring' tab at the bottom of the Control/Monitoring menu. The Monitoring tab shows the detail information of the selected Zone, Group and Unit. The monitoring information of Zone and Group, and the monitoring information of the unit can be shown differently by the characteristics.

Note: Monitoring information

The information about the unit with the communication error (code: 242) displays the result at the monitoring information for the following items.

- Average indoor temperature, average setting temperature information
- Number of units such as cooling, heating, automatic, lock, unlock

Zone, Group monitoring information

The monitoring information of Zone and Group shows the average temperature and number of units depending on the condition of the units included in the applicable Zone or Group.



<Zone and Group monitoring tab>

The information shown as the condition information is as follows.

Display item	Description
Average indoor temperature	Average indoor temperature of installed indoor units is displayed. Indoor unit not in operation and indoor unit with communication error (Code: 242) and expansion kit error (Code: 251) are excluded from the measurement of average indoor temperature.
Average set temperature	Average temperature of set temperature of indoor units is displayed. Indoor unit not in operation and indoor unit with communication error (Code: 242) and expansion kit error (Code: 251) are excluded from the measurement of average set temperature.
All	Total number of units included in the Zone or Group designated by the user is displayed.
Operating	Total number of units in operation within the Zone or Group designated by the user is displayed.
Alarm	Number of units with communication error (Code: 242) or expansion kit error (Code: 251) among the units in the Zone or Group designated by the user is displayed.
Cool	Number of units operating in cool mode is displayed.
Heating	Number of units operating in heating mode is displayed.
Auto	Number of units operating in auto mode is displayed.
Lock	Number of units locked is displayed.
Unlock	Number of units unlocked is displayed.
Others	Number of units not operating in cool, heating or auto mode, but operating in other mode is displayed.

Indoor unit monitoring information

Indoor unit monitoring information shows the current indoor temperature and indoor unit setting. In case of communication error or expansion kit error, other information except for the alarm is not displayed.

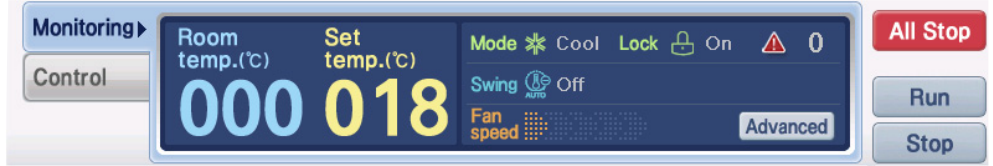

<Indoor unit monitoring tab>

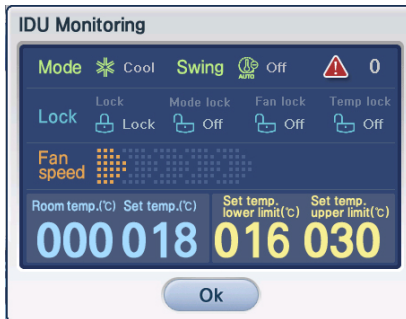

<Indoor unit condition screen>

When you press the [View detail] button, the 'Indoor unit condition' screen showing the detail information of the applicable indoor unit will be displayed, as shown on the left side.

In the 'Indoor unit condition' screen, you can check the detail condition of the indoor unit.

The information shown on the Indoor unit monitoring tab and Indoor unit condition screen is as follows. (3-15,27)

Item	Description
Indoor temperature	Indoor temperature where indoor unit is installed is displayed.
Set temperature	Set temperature of indoor unit is displayed.
Mode	<p>The operating mode of the unit is displayed.</p> <ul style="list-style-type: none"> - Cool: When the unit is in cool operation - Heat: When the unit is in heat operation - Auto: When the unit is in auto operation <div style="border: 1px solid gray; padding: 10px; margin-top: 10px;"> <p>Reference: What is auto operation</p> <p>Auto operation refers to the method of operating the unit automatically to maintain optimal environment by measuring and comparing the indoor and outdoor temperature.</p> </div>

Item	Description
Wind direction	<p>Wind direction setting status is displayed.</p> <ul style="list-style-type: none"> - ON: When it is set for the direction of the wind to move up and down - OFF: When it is set for the direction of the wind to blow in one direction <p>Lock function setting status to disable all functions of each unit so that the user cannot control the units via remote controller is displayed.</p>
Lock	<p>Setting of all lock function is displayed on the Monitoring tab to disable all functions of the indoor unit.</p> <ul style="list-style-type: none"> - Enable: Condition lock function is enabled - Cancel: Condition lock function is disabled <div style="border: 1px solid gray; border-radius: 10px; padding: 10px; background-color: #f0f0f0; margin: 10px 0;"> <p>Reference: Lock display of remote controller</p> <p>When the user tries to operate the remote controller while the all lock function is enabled, the "HL" sign will be displayed on the remote controller. For other lock function, it will return to the previous setting. For details, refer to the user manual of the remote controller.</p> </div> <p>You can set the lock function of air condition so that the user cannot control the air conditioner individually.</p> <ul style="list-style-type: none"> - All lock: Enable lock function. - All unlock: This disables the lock function. - Mode lock - This enables the Mode lock function so that the user cannot individually control the operating mode of the indoor unit. - Mode unlock - This disables the Mode lock function. - Fan level lock - This enables the Fan level lock function so that the user cannot individually control the fan level of the indoor unit. - Fan level unlock - This disables the Fan level lock function. - Set temperature lock - This enables the Set temperature lock function so that the user cannot individually control the indoor temperature setting. - Set temperature unlock - This disables the set temperature lock function.
Alarm	<p>When there is currently no alarm generated in the unit, '0' is displayed.</p> <p>When there is an alarm generated, the alarm code of the applicable alarm is displayed.</p>
Fan level	Current level of fan is displayed.
Minimum set temperature	When the indoor temperature limit function is set, this displays the minimum temperature.
Maximum set temperature	When the indoor temperature limit function is set, this displays the maximum temperature.

Ventilator monitoring information

Ventilator monitoring information shows the current operating mode and setting. In case of communication error or expansion kit error, other information except for the alarm is not displayed.

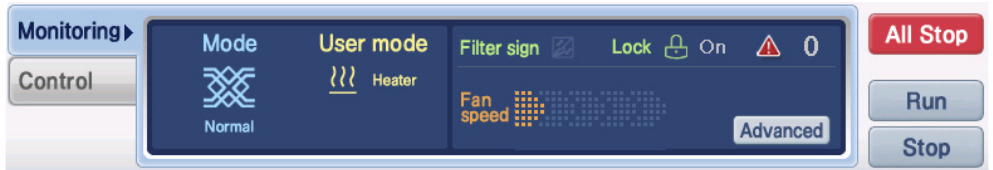

<Ventilator monitoring tab>

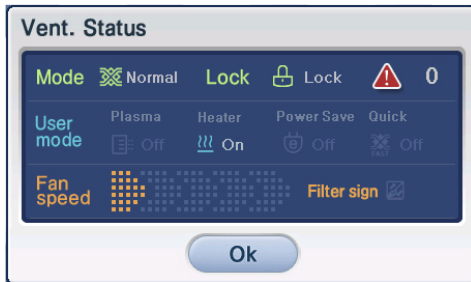

<Ventilator condition screen>

When you press the [View detail] button, the 'Ventilator condition' screen showing the detail information of the applicable ventilator will be displayed, as shown on the left side.

In the 'Ventilator condition' screen, you can check the detail condition of the ventilator.

The information shown on the Ventilator monitoring tab and Ventilator condition screen is as follows.

Item	Description
Mode	Operating mode of the ventilator is displayed. <ul style="list-style-type: none"> Heat: Ventilate both inlet/outlet through heat exchanger Normal: Ventilate air to outlet without passing through heat exchanger Auto: Control the inlet/outlet automatically by measuring the indoor and outdoor temperature
User mode	Additional operating method of ventilator is displayed. <ul style="list-style-type: none"> Plasma: Condition with plasma function set Heater: Condition with heater function set Power save: Condition with power save function set Speed: Condition with speed function set
Filter exchange	When it is time to exchange the filter of the ventilator, filter exchange icon is displayed.
Lock	Lock function setting to disable all functions of the ventilator through the remote controller by the user is displayed. <ul style="list-style-type: none"> Enabled: Condition with lock function enabled Disabled: Condition with lock function disabled
Alarm	When there is no alarm in the current ventilator, this is displayed as '0'. In case of an alarm, the applicable alarm code is displayed.
Fan level	Current fan level is displayed.

On/Off unit monitoring information

On/Off unit monitoring information displays the current operating condition. In case of communication error, other information excluding the alarm is not displayed.



<On/Off unit monitoring tab>

Information displayed on On/Off unit monitoring tab is as follows.

Item	Description
Operation	This is displayed when the On/Off unit is operating.
Stop	This is displayed when the On/Off unit is stopped.
Alarm	When there is no alarm in the current On/Off unit, this is displayed as '0'. In case of an alarm, the applicable alarm code is displayed.

AWHP unit monitoring information

AWHP unit monitoring information displays the current set temperature and setting. In case of communication error or expansion kit error, other information excluding the alarm, is not displayed.

For the AWHP unit, the control temperature can be selected between air temperature and water temperature, and it is displayed as follows.



<AWHP unit monitoring tab - When control temperature is set to air temperature >

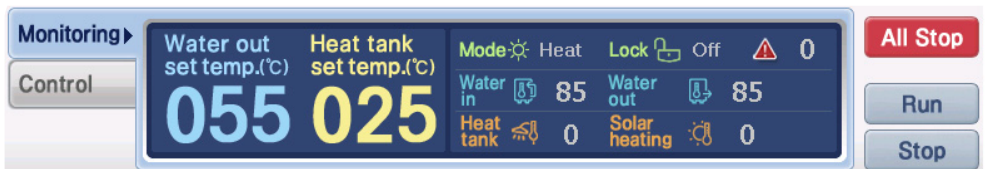

< AWHP unit monitoring tab - When control temperature is set to water temperature >

Information displayed on AWHP unit monitoring tab is as follows. AWHP unit displays the following information only through separate installation and setting.

Item	Description
Air set temperature	Currently set indoor temperature is displayed. When the control temperature is set to air temperature, this item is displayed. When this item is displayed, "Water set temperature" item is not displayed.
Water set temperature	Currently set outlet water temperature is displayed. When the control temperature is set to outlet water temperature, this item is displayed. When this item is displayed, "Air set temperature" item is not displayed.
Hot water set temperature	Currently set hot water temperature within the tank is displayed.
Mode	Operating mode of the currently set AWHP unit is displayed. <ul style="list-style-type: none"> • Cool: When operating in cool mode • Heat: When operating in heat mode • Auto: When operating in auto mode
Lock	Lock function setting to disable all functions of the AWHP unit through the remote controller by the user is displayed. <ul style="list-style-type: none"> • Enabled: Condition with lock function enabled • Disabled: Condition with lock function disabled
Alarm	When there is no alarm in the AWHP unit, this is displayed as '0'. In case of an alarm, the applicable alarm code is displayed.
Inlet water	Water temperature flowing into AWHP based on indoor unit is displayed.
Outlet water	Water temperature outflowing through AWHP unit based on indoor unit is displayed.
Hot water	Water temperature within the hot water tank is displayed.
Solar energy source	Water temperature from using solar energy to reduce energy consumption is displayed.

Zone, Group and Unit control

'Control' tab is located at the bottom of the Control/Monitoring menu. The control tab has the menu to directly control the Zone, Group and units. The control of the Zone and Group, and the control of the units is displayed differently.

Reference: Zone, Group and Unit control method

For details on the control method, refer to "Control/Monitoring operation" section in page 72.

Zone, Group control

When you select the Zone or Group, the control tab is displayed as follows and you can directly control the functions.

* Units with communication error (Code: 242) and expansion kit error (Code: 251) are excluded from the average indoor temperature calculation.

Indoor unit control

When you select the indoor unit from the Control/Monitoring screen, the control tab is displayed as follows, and you can directly control the indoor unit function.

Caution: Temperature lock (4-9)



When you have transmitted the temperature lock command at the temperature exceeding the set range of the desired temperature, the unit may not operate normally to the set temperature. Therefore, please set the temperature lock to the temperature within the set range of the desired temperature.

Caution: Individual lock setting (Temperature, fan level lock) (4-9)



When the 2PIN connector of PI485 is connected and you try to change the operating mode with the wired remote controller, it can change to the prior mode when the temperature, fan level lock is enabled. In this case, when you resolve this issue by operating the temperature lock and mode lock simultaneously. When the 2PIN of PI485 is connected, it is recommended that you use both the temperature lock and mode lock.

Ventilator control

When you select the ventilator from the Control/Monitoring screen, the control tab is displayed as follows, and you can directly control the ventilator function.

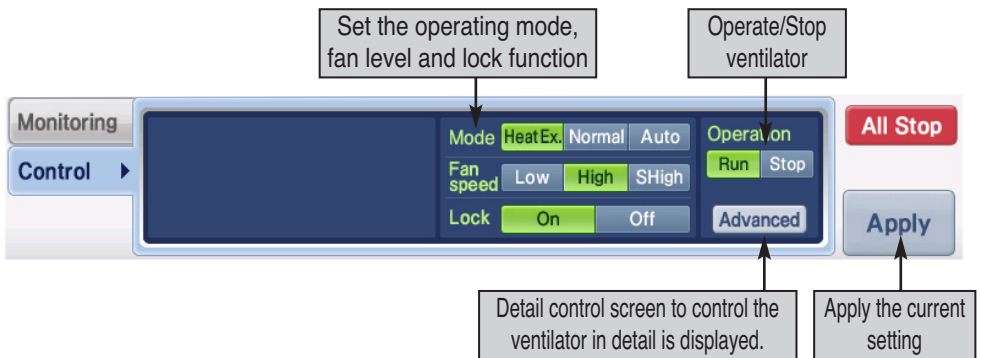

On/Off unit control

When you select the On/Off unit from the Control/Monitoring screen, the control tab is displayed as follows, and you can directly control the On/Off unit function.

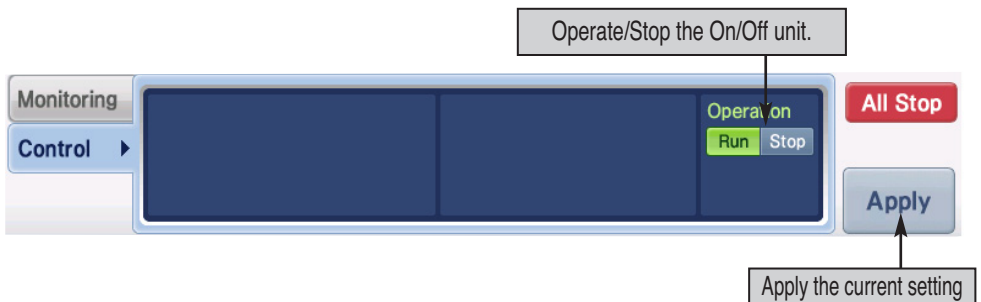

AWHP unit control

When you select the AWHP unit from the Control/Monitoring screen, the control tab is displayed as follows, and you can directly control the AWHP unit function.

For the AWHP unit, you can select the air/water temperature as the control temperature with the remote controller. Even though you can set both the air and water temperature from the unit control item of AC SMART II, the actual operation will be done based on the temperature set by the remote controller.

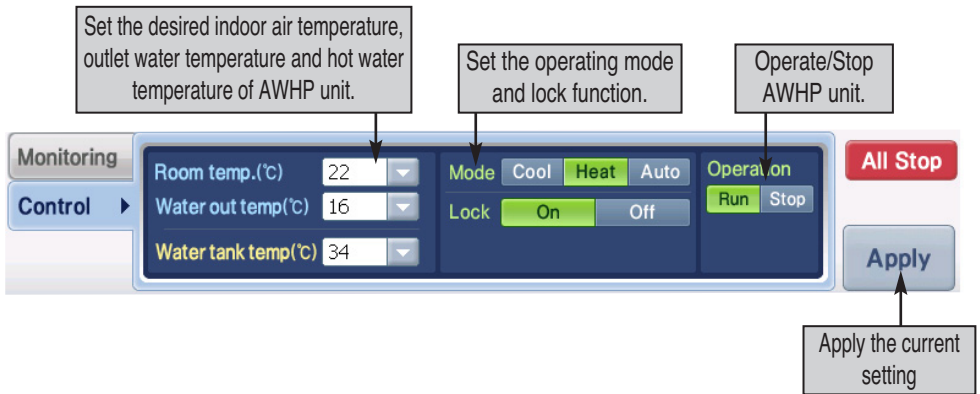

* Air/Water temperature can be set from the control tab, but in actual operation, the unit operates based only on the temperature set in the remote controller of the two.

Control/Monitoring

This section describes how to operate the AC Smart function in order by using the control/monitoring menu.

Controlling the unit

The function of the unit to control is as follows.

- Indoor temperature setting of unit
- Operating and stopping the unit
- Operating mode of the unit
- Fan level of the unit
- Lock function of the unit
- Indoor cooling/heating temperature and hot water temperature of AWHP unit

Reference: Detail unit control

if you need to set the detail function, refer to Controlling the unit in detail in the next section.

To set the function of the unit, proceed according to the following description.(4-7)

1. Select 'Control/Monitoring' menu from the menu of AC Smart. When you select the 'Control/Monitoring' menu, the following Control/Monitoring screen is displayed. Designate the target to execute the various function of the unit from the screen with zone, group or unit displayed. You can press the [Up], [All Zones], [All Groups] or [All Units] button to designate the target to move or control.

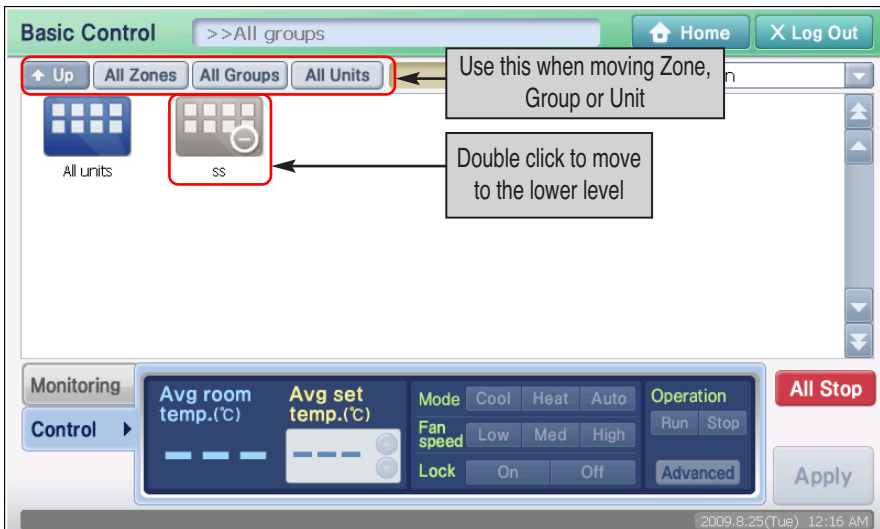

2. Press the button for each function and then press the [Apply] button. Refer to the following chart of the description of each function.

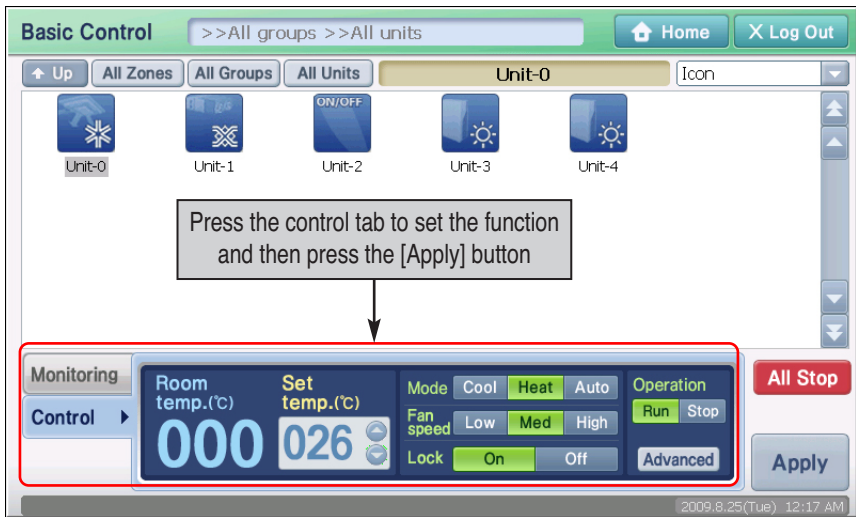

[Indoor unit setting item] (4-8)

Item	Description
Set temperature	The user can set the desired indoor temperature.
Mode	You can set the operating mode of the unit. [Cool] : It operates in cool mode. You can set the desired temperature from SET TEMP in the range of 18°C~30°C. When the desired temperature is lower than the indoor temperature, it operates in fan mode. [Heat] : It operates in heat mode. You can set the desired temperature from SET TEMP in the range of 18°C~30°C. When the desired temperature is higher than the indoor temperature, it operates in fan mode. [Auto] : It evaluates the indoor and outdoor condition and maintains the optimal condition automatically.
Fan level	You can set the fan level of the unit.. [Low] : This sets the fan level to low. [Med] : This sets the fan level to med. [High] : This sets the fan level to high.
Lock	You can enable and disable the lock function so that the user cannot directly set each unit. [On] : This sets the lock function. When the lock function is set, all functions of the unit installed indoor can be controlled using only AC Smart.. [Off] : This cancels the lock function. When the lock function is canceled, the unit installed indoor can be individually controlled.
Power	You can operate or stop the unit.

Item	Description
Power	Run: This operates the unit. Stop: This stops the unit.
Advanced	When you press this button, you can set the control of the indoor unit in detail. Refer to 'Controlling the unit in detail' in the next section.

[Ventilator setting item](3-36)

Item	Description
Mode	You can designate the operating mode of the ventilator. <ul style="list-style-type: none"> - Heat: Both inlet/outlet go through heat exchange device for ventilation. Use this mode during summer and winter when the difference between the indoor and outdoor is significant in terms of temperature and humidity. - Normal: The exhaust air is ventilated without going through the heat exchanger. Use this mode during spring and fall when the difference between the indoor and outdoor is not too significant in terms of temperature and humidity. - Auto: This measures the indoor temperature and outdoor temperature and automatically controls inlet and outlet. With this, the balance of the indoor air is maintained to maintain the optimal condition.
Fan level	This sets the fan speed of the ventilator. You can adjust the level by considering the indoor level of contamination. <ul style="list-style-type: none"> - Low: This sets the fan level to low. - High: This sets the fan level to high. - Super: This sets the fan level to maximum speed.
Lock	You can set the lock function so that the user cannot operate the ventilator individually. <ul style="list-style-type: none"> - All lock: This is set so that the ventilator cannot be operated. - All unlock: This is set so that the ventilator can be operated.
Operation	You can set the operation and stopping of the ventilator. <ul style="list-style-type: none"> - Operation: You can operate the ventilator. - Stop: You can stop the operation of the ventilator.
[Detail control]	When you press this button, you can set the control of the indoor unit in detail. Refer to 'Controlling the unit in detail' in the next section.

[On/Off unit setting item]

Item	Description
Operation	You can turn On/Off the unit connected to AC SMART II. <ul style="list-style-type: none"> • [Operate]: Operate the On/Off unit. • [Stop]: Stop the On/Off unit.

[AWHP unit setting item]

Item	Description
Air temperature	You can set the indoor air temperature.
Water temperature	Set the water temperature that goes through AWHP unit.
Hot water temperature	You can set the water temperature within the hot water tank.
Mode	You can set the operating mode of the AWHP unit. <ul style="list-style-type: none"> • [Cool]: Operate in cool mode. • [Heat]: Operate in heat mode. • [Auto]: Judges the indoor condition and automatically maintains optimal condition.
Lock	Set so that AWHP unit cannot be operated individually. <ul style="list-style-type: none"> • [All lock]: Set the all lock function so that all functions of AWHP unit cannot be changed individually. • [All unlock]: Disable the all lock function.
Operation	You can operate/stop the AWHP unit. <ul style="list-style-type: none"> • Operate: Set to turn on the power of AWHP unit. • Stop: Set to turn off the power of AWHP unit.

Reference: Air temperature and outlet water temperature setting

Even though the air temperature and outlet water temperature item can be set simultaneously from AC SMART II, the AWHP unit is controlled based on air temperature and outlet water temperature. Applied criteria (Air temperature, water temperature) can be set with the remote controller.

3. The setting is completed after the application process of the function setting process proceeds.

Controlling the unit in detail

You can set detail control function of the unit. To set the function of unit in detail, proceed according to the following description. Control method of the Zone is described as the example here.

Reference: Detail control of Zone, Group and Unit

Detail control screens for Zone, Group and Unit are different. But the controlling method is the same. For example, all types of units can be controlled for the Zone or Group. But on the other hand, the detail control screen by unit can only control the applicable unit in detail.

1. When you select the 'Control/Monitoring' menu, the following screen will be displayed. Designate the target to control and press the [Detail control] button.

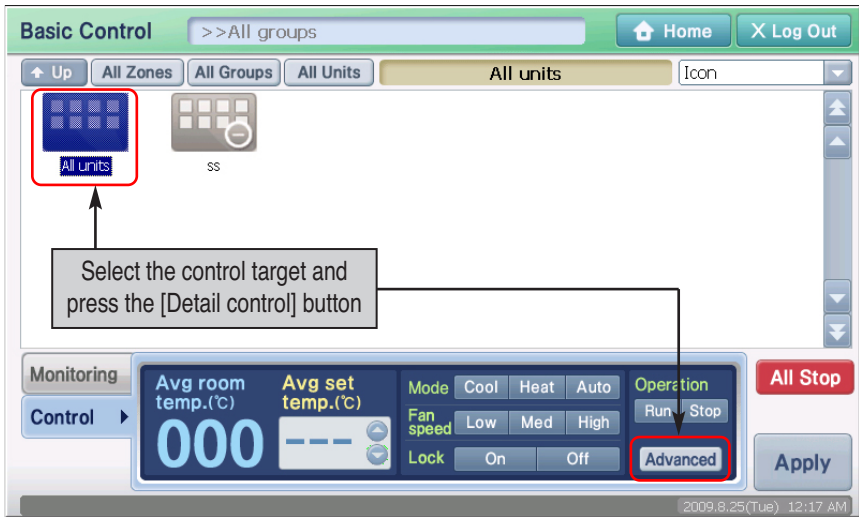

2. 'Detail control' screen is displayed. After clicking on the button of the function to set, click on the [OK] button. Refer to the following chart for the description of each function.(4-11)

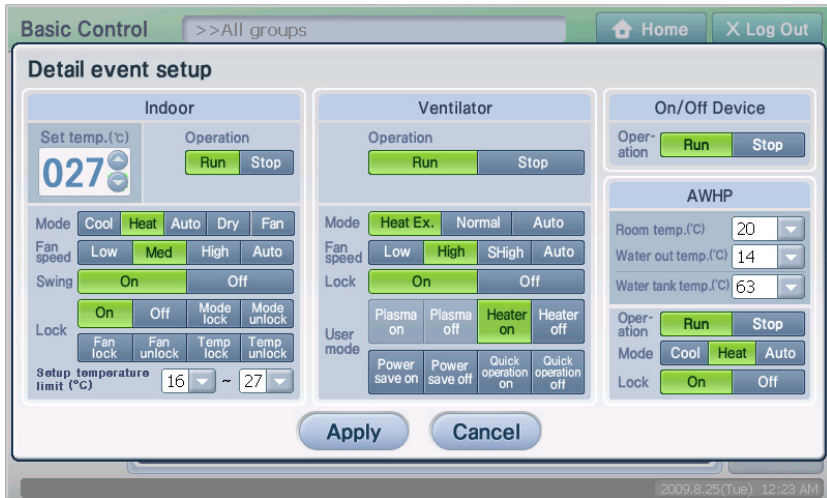

[Indoor Unit]4-33

Item	Description
Set Temperature	The user can set the desired indoor temperature.
Operation	You can set the operation and stopping of the indoor unit. - Operation: It operates the indoor unit. - Stop: It stops the operation of the indoor unit.
Mode	You can set the operating mode of the indoor unit. - Cool: This operates the indoor unit to run cool operation. Execute when the indoor temperature is high. - Heat: This operates the indoor unit to run heat operation. Execute when the indoor temperature is low. - Auto: The unit evaluates the indoor condition and maintains optimal condition automatically. - Dehumidify: This operates the indoor unit to run dehumidifier operation. When you set this during the rainy season or when it is humid, the dehumidifier will remove the humidity effectively. When you set to this mode. When you set up for this mode, you cannot set the desired temperature. - Fan: This operates the indoor unit to run fan operation. When you set this for air cleaning operation, fresh air will be circulated. In spring and fall, it is good to use the air cleaner independently. When you set the unit to this mode, you cannot set the desired temperature.
Fan level	This sets the fan speed of the ventilator. You can adjust the setting considering the level of indoor contamination. - Low: This sets the fan speed to low.

Item	Description
Fan level	<ul style="list-style-type: none"> - Med: This sets the fan speed to med. - High: This sets the fan speed to high. - Auto: This sets to automatically measure the indoor level of contamination and maintain the optimal condition.
Wind direction	Set whether rotate the fan automatically. <ul style="list-style-type: none"> • [Set]: Execute the auto fan rotate function. • [Cannel]: Stop the auto fan rotate function.
LOCK	You can set the lock function of air condition so that the user cannot control the air conditioner individually. <ul style="list-style-type: none"> - All lock: Enable lock function. - All unlock: This disables the lock function. - Mode lock - This enables the Mode lock function so that the user cannot individually control the operating mode of the indoor unit. - Mode unlock - This disables the Mode lock function. - Fan level lock - This enables the Fan level lock function so that the user cannot individually control the fan level of the indoor unit. - Fan level unlock - This disables the Fan level lock function. - Set temperature lock - This enables the Set temperature lock function so that the user cannot individually control the indoor temperature setting. - Set temperature unlock - This disables the set temperature lock function.
Maximum/Minimum temperature setting	You can limit the indoor temperature to be within a certain temperature range. Here, the user cannot individually set the indoor temperature out of the set temperature range.

[Indoor Unit]4-33

Item	Description
Operation	You can set the operation and stopping of the ventilator. <ul style="list-style-type: none"> - Operation: You can operate the ventilator. - Stop: You can stop the operation of the ventilator.
Mode	You can designate the operating mode of the ventilator. <ul style="list-style-type: none"> - Heat: Both inlet/outlet go through heat exchange device for ventilation. Use this mode during summer and winter when the difference between the indoor and outdoor is significant in terms of temperature and humidity. - Normal: The exhaust air is ventilated without going through the heat exchanger. Use this mode during spring and fall when the difference between the indoor and outdoor is not too significant in terms of temperature and humidity. - Auto: This measures the indoor temperature and outdoor temperature and automatically controls inlet and outlet. With this, the balance of the indoor air is maintained to maintain the optimal condition.

Item	Description
Fan level	<p>This sets the fan speed of the ventilator. You can adjust the level by considering the indoor level of contamination.</p> <ul style="list-style-type: none"> - Low: This sets the fan level to low. - High: This sets the fan level to high. - Super: This sets the fan level to maximum speed. - Auto: This is set to maintain the optimal condition by measuring the indoor level of contamination automatically.
Lock	<p>You can set the lock function so that the user cannot operate the ventilator individually.</p> <ul style="list-style-type: none"> - All lock: This is set so that the ventilator cannot be operated. - All unlock: This is set so that the ventilator can be operated.
User mode	<p>You can designate the additional operating method of the ventilator.</p> <ul style="list-style-type: none"> - Enable plasma: This enables the plasma function. Current this cannot be designated. - Disable plasma: This disables the plasma function. Currently this cannot be designated. <div style="background-color: #e0e0e0; padding: 10px; border-radius: 10px; margin: 10px 0;"> <p>Reference: What is plasma?</p> <p>This is the air cleaning function to make the air pleasant with negative ion. This function not only remove the household virus or fungus but also removes the influenza virus, which is the most commonly known cold virus, thinking not just the environment but also the health of the family.</p> </div> <ul style="list-style-type: none"> - Enable power save: Ventilator operates in the most efficient condition to save the power consumption. - Disable power save: This disables the power save function. - Enable quick operation: This enables the unit to operate in maximum performance to prevent the expansion of contaminated indoor air or humidity to other space. It is recommended to use this when the indoor contamination is severe. - Disable quick operation: If the quick operation mode is in operation, this stops the operation..

[On/Off unit setting item]

Item	Description
Operation	<p>You can turn On/Off the unit connected to AC SMART II.</p> <ul style="list-style-type: none"> • [Operate]: Operate the On/Off unit. • [Stop]: Stop the On/Off unit.

[AWHP unit setting item]

Item	Description
Air temperature	You can set the indoor air temperature.
Water temperature	Set the water temperature that goes through AWHP unit.
Hot water temperature	You can set the water temperature within the hot water tank.
Operation	You can operate/stop the AWHP unit. • Operate : Set to turn on the power of AWHP unit. • Stop : Set to turn off the power of AWHP unit.
Mode	You can set the operating mode of the AWHP unit. • [Cool] : Operate in cool mode. • [Heat] : Operate in heat mode. • [Auto] : Judges the indoor condition and automatically maintains optimal condition.
Lock	Set so that AWHP unit cannot be operated individually. • [All lock] : Set the all lock function so that all functions of AWHP unit cannot be changed individually. • [All unlock] : Disable the all lock function.

5. Schedule menu

Schedule is the function to execute the reserved operation at specific time by predesignating the operation of the air conditioner.

AC Smart, you can set the group to commonly apply the schedule. Also by introducing the pattern concept, you can easily apply the repeated schedule in week or day unit.

- Schedule: Unit designating the operation of indoor unit and ventilator for the specific period set by the user by grouping the information of schedule for group, pattern and period
- Schedule pattern: Unit designating the certain operation of air conditioner in week or day unit
- Schedule group: Collection of units (Indoor unit and ventilator) applied with same schedule pattern.

Reference: Schedule group

Schedule group is different from the logical or physical group referred to in this document, and is used for apply the schedule.

The screenshot shows the 'Schedule' menu interface. Callouts point to various features:

- Carry into effect or stop the schedule function:** Points to the 'Run/Stop' button.
- Possible to create/erase/edit schedule group:** Points to the 'Edit group' button.
- Possible to apply reservation pattern to schedule group:** Points to the 'Pattern Wizard' button.
- Possible to create/revise/remove schedule pattern:** Points to the 'Schedule wizard' button.
- Setup schedule detail is indicated:** Points to the 'View' button.

The interface includes a 'Schedule' title bar with 'Home' and 'Log Out' buttons. Below are 'View', 'Run/Stop', 'Edit group', 'Pattern Wizard', and 'Schedule wizard' buttons. The main area shows a calendar for the period 2009.08.23 ~ 2009.08.29, with a 'Select time' column on the left. On the right, there are controls for 'Event count', 'Event' (Set temp. (°C), Operation: Run/Stop), 'Mode' (Cool/Heat/Auto), 'Lock' (On/Off), and 'Fan speed' (Low/Medium/High). An 'Advanced' button is at the bottom right. A status bar at the bottom indicates 'Schedule... Schedule is being saved.' and the time '2009.8.25(Tue) 12:50 AM'.

Generally you must follow the following procedure to set the schedule.

1. Edit schedule group

Create/Edit the schedule group through group edit.

2. Edit schedule pattern

You can create/edit the weekly/daily schedule through schedule pattern wizard.

3. Set schedule through schedule wizard

Apply the schedule pattern and operating period to the schedule group through schedule wizard.

4. Run/Stop schedule

Create/Edit the schedule group through group edit.

This section describes how to operate the AC SMART II function by using the schedule.

Manage schedule group

Schedule group is a gathering of devices to perform same movement. If pressing [Group edit] button, 'Group edit' screen which can create, revise, and remove schedule group is presented.

The screenshot shows the 'Edit group' interface with the following callouts:

- Name of currently selected group and list of units included in the applicable group are displayed.** (Points to the 'Assigned Unit' list)
- You can add/remove the unit from specific group.** (Points to the arrow buttons between 'Assigned Unit' and 'Unassigned Unit' lists)
- Create a schedule group with same configuration as the set group from unit management menu.** (Points to the 'Basic group setting' button)
- List of currently registered schedule groups is displayed.** (Points to the 'Group name' list)
- You can create, rename or delete the schedule group.** (Points to the 'Add', 'Rename', and 'Delete' buttons)
- Save the setting.** (Points to the 'Ok' button)
- Cancel to save the setting and return to the previous screen.** (Points to the 'Cancel' button)
- List of units not included in the group is displayed.** (Points to the 'Unassigned Unit' list)

Creating new schedule group

To create a new schedule group, proceed in the following order.

1. Select the 'Schedule' menu from the menu of AC Smart. When you select the 'Schedule' menu, the following schedule screen is displayed. To create a new schedule group, click on the [Edit group] button.

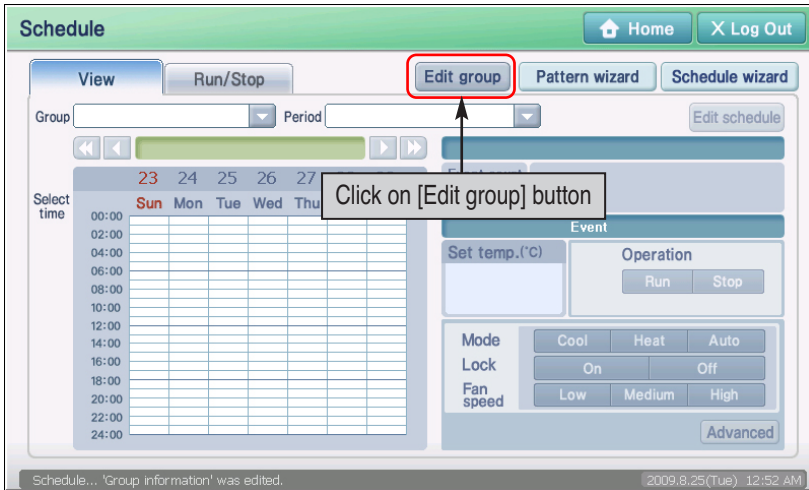

2. 'Edit group' screen is displayed. To create a new schedule group, click on the [Add] button. [Add group] screen to enter the name of the schedule group to create is displayed.



3. After entering the name of the schedule group to create, click on the [OK] button.

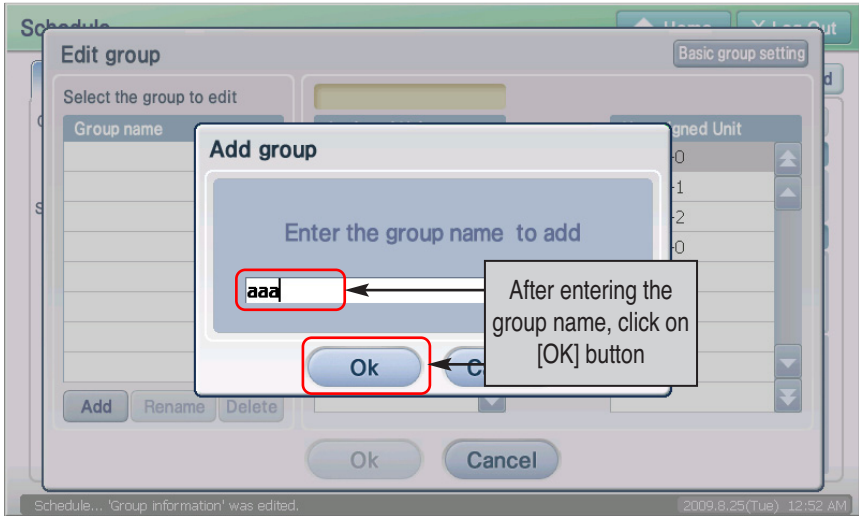

4. Check whether the applicable schedule group has been created in 'Group'. Now, select the unit to be added to the schedule group from the unit list on the right, and press the [] button to add to the schedule group.

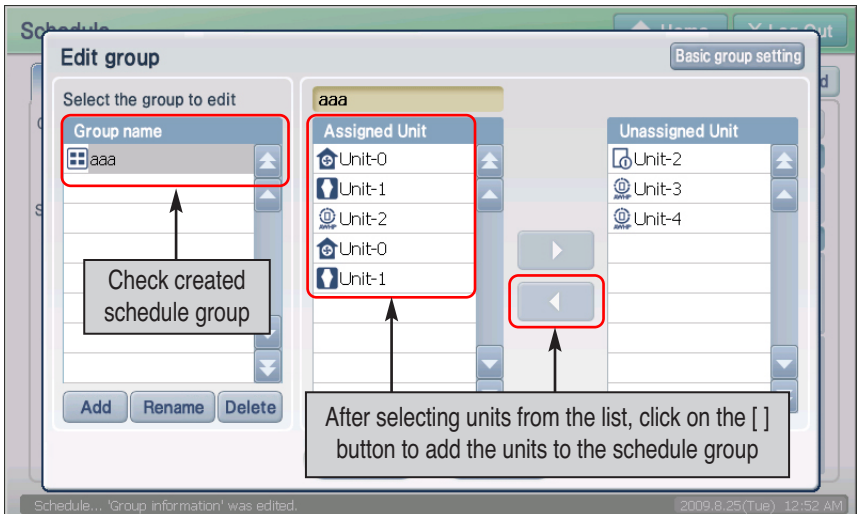

5. Click on the [Save] button to save the current setting. 'Information' screen to confirm the saving process is displayed.

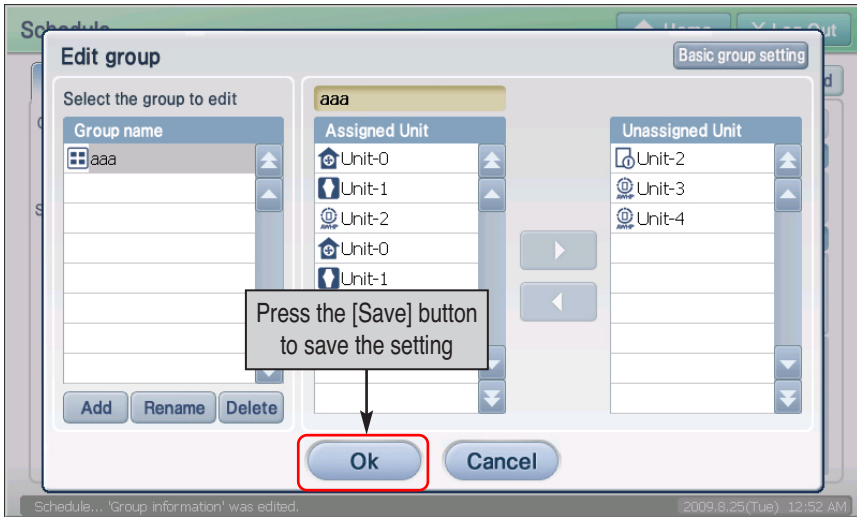

Information: Schedule group setting using the basic group setting button

When you click on the [Basic group setting] button located at the bottom left corner of the 'Edit group' screen, you can create the same group as the basic control group set for control and monitoring from the 'Setting' menu as a schedule group.

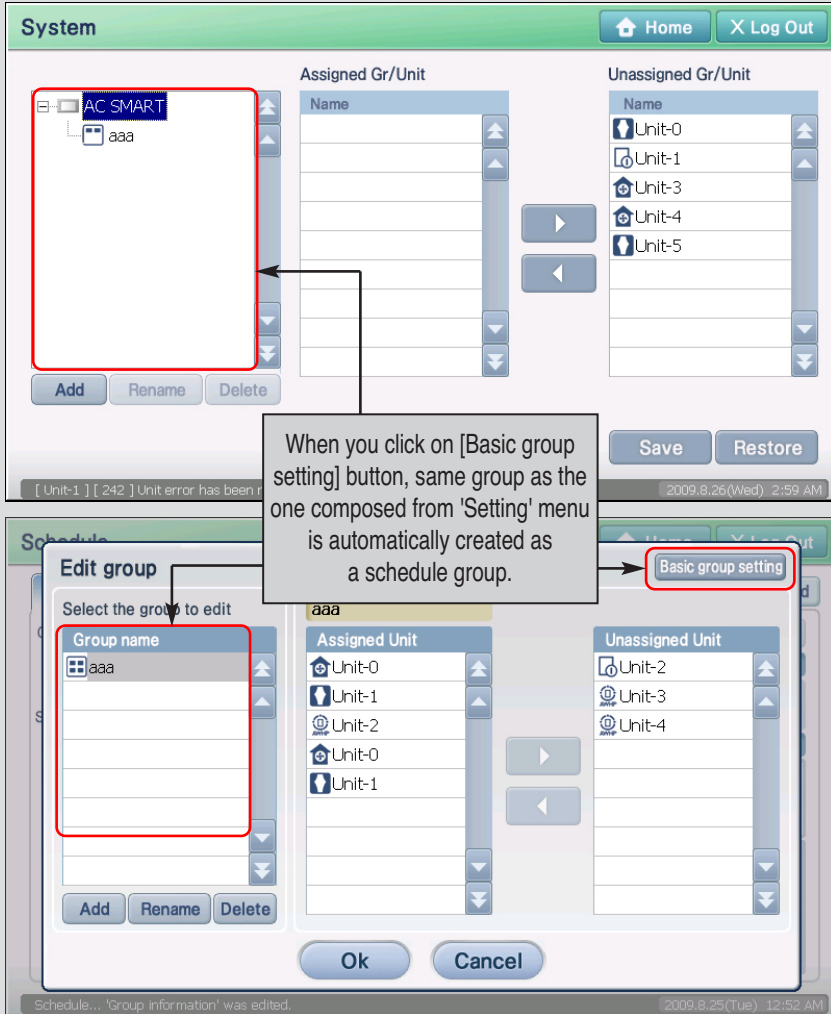

Rename schedule group

To rename the schedule group, proceed in the following order.

1. Select the 'Schedule' menu from the menu of AC Smart. When you select the 'Schedule' menu, the following schedule screen is displayed. To rename the schedule group, click on the [Edit group] button.

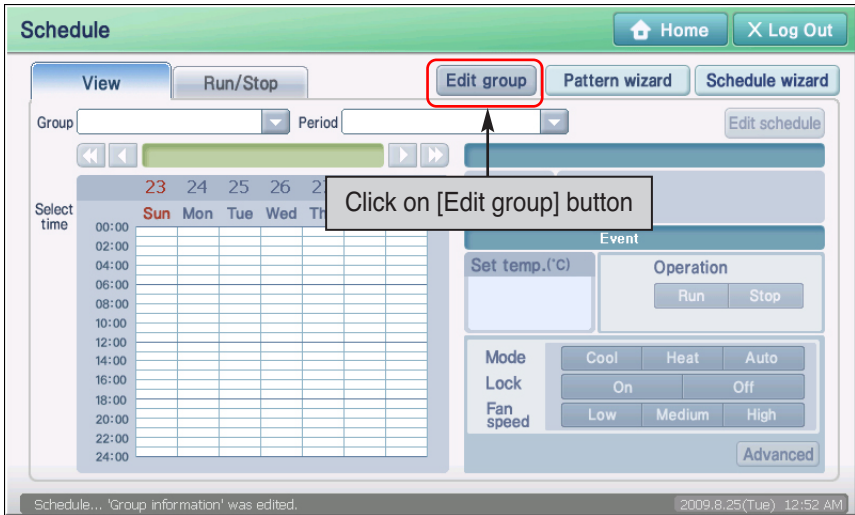

2. 'Edit group' screen is displayed. Select the schedule group to rename and click on the [Rename] button. 'Group name' screen to enter the name of the schedule group to change is displayed.

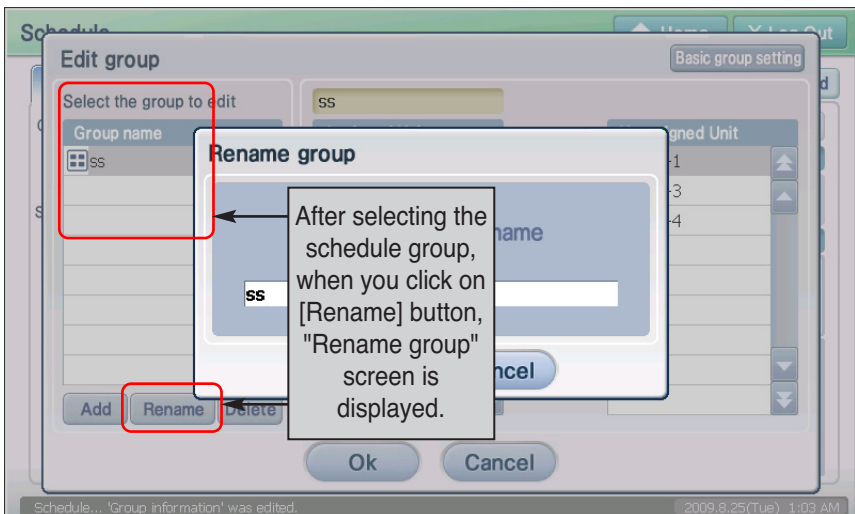

3. After entering the name of the schedule group to change, click on the [OK] button.

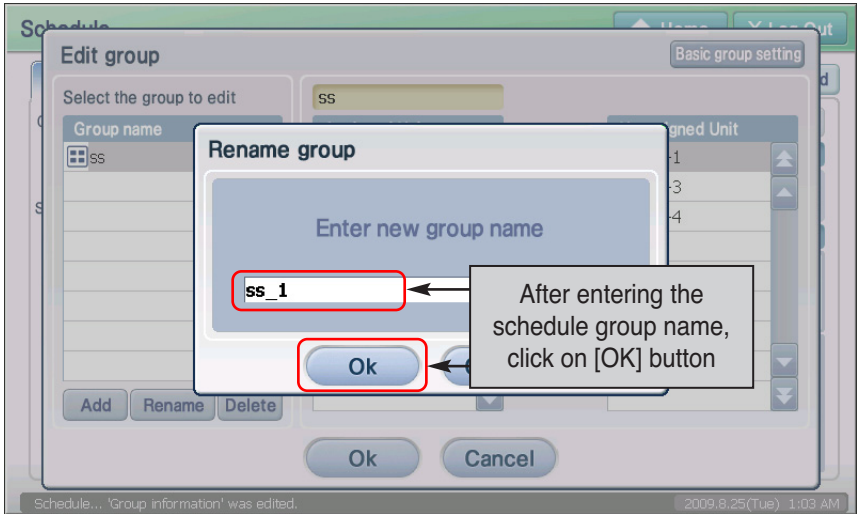

4. Check whether the name of the applicable schedule group has changed in 'Group', and click on the [Save] button to save the current setting.

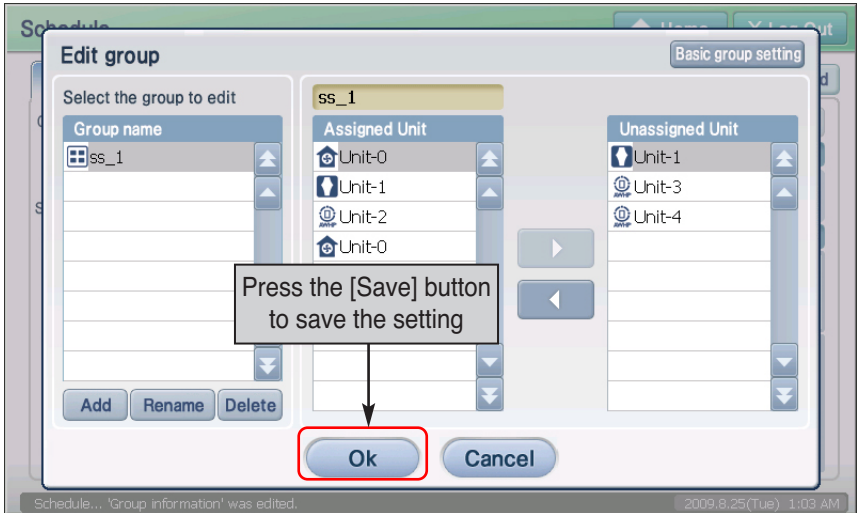

Deleting schedule group

To delete the schedule group, proceed in the following order.

1. Select the 'Schedule' menu from the menu of AC Smart. When you select the 'Schedule' menu, the following schedule screen is displayed. To delete the schedule group, click on the [Edit group] button.

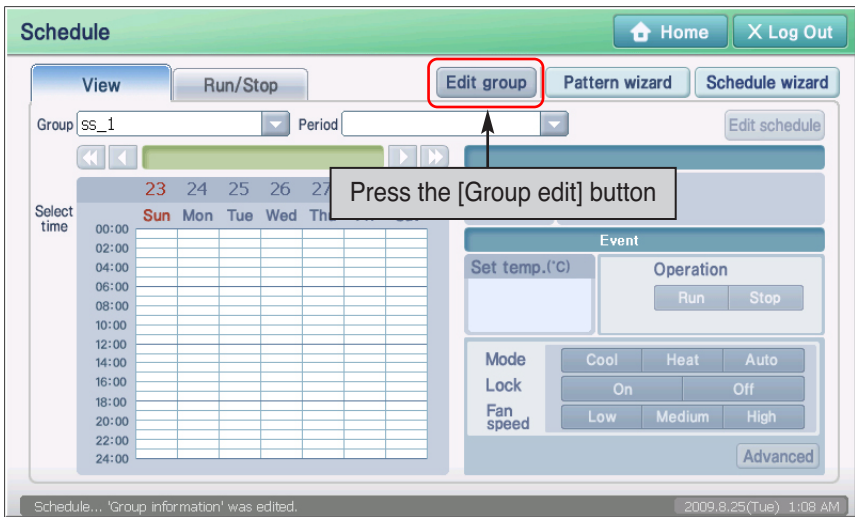

2. 'Edit group' screen is displayed. Select the schedule group to delete and click on the [Delete] button. The applicable schedule group will be deleted.

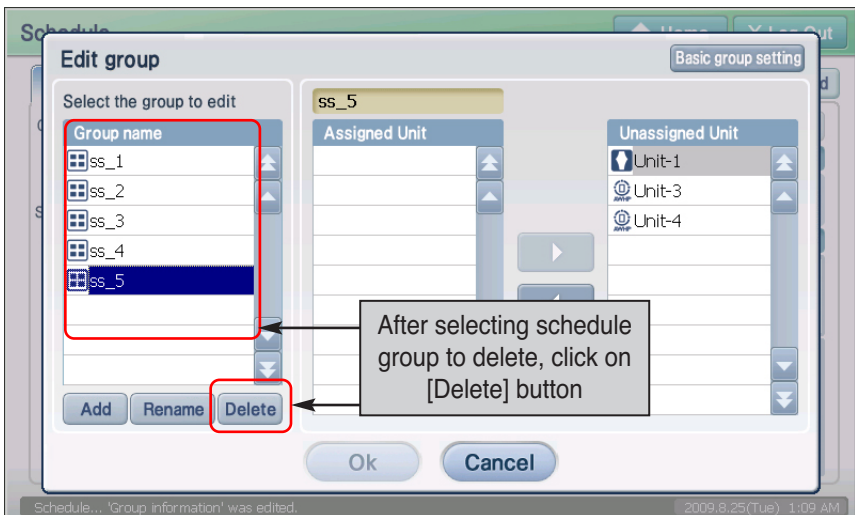

3. Check whether the applicable schedule group has been deleted from 'Group', click on the [Save] button to save the current setting.

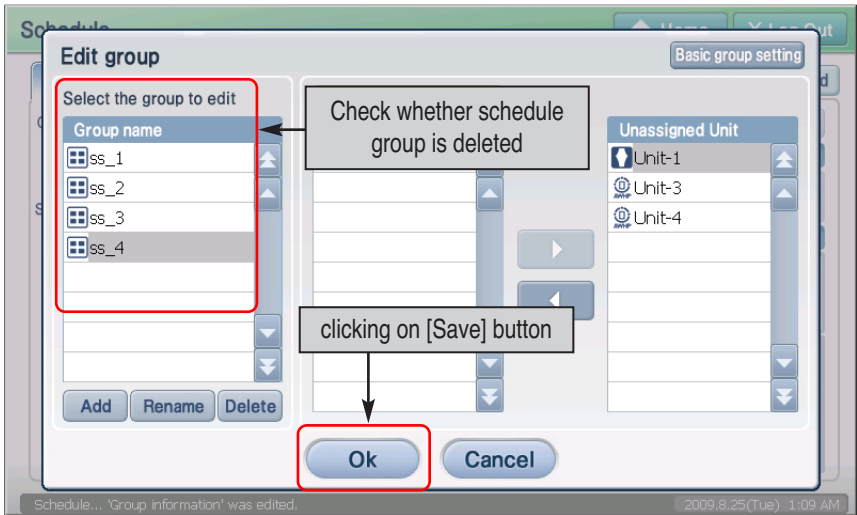

Creating schedule pattern

Schedule pattern refers to a certain operation of unit (Indoor unit, Ventilator, On/Off unit, AWHP unit) repeated for each day or week.

Schedule pattern wizard is the process of configuring the operation of the unit in weekly or daily pattern. The pattern created through the schedule pattern wizard can be applied to the Group as a schedule through schedule wizard to be described in the next section.

Schedule pattern wizard can be configured through total of 4 steps as shown below.

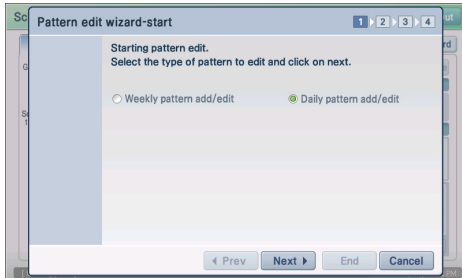

1. Select schedule pattern type

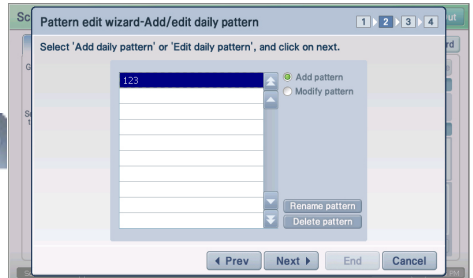

2. Add/Edit schedule pattern

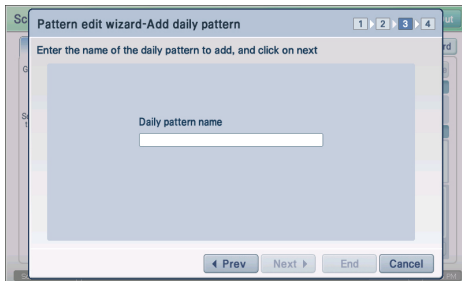

3. Enter schedule pattern name

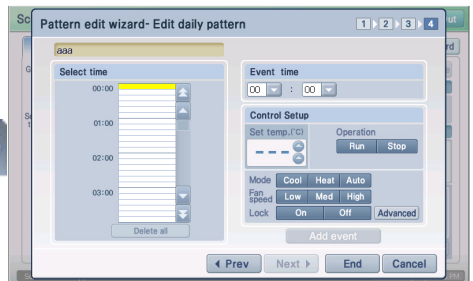

4. Edit schedule pattern

Adding weekly schedule pattern

To add the weekly schedule pattern, proceed as follows.

1. When you select the "Schedule" menu from the initial screen of AC SMART II, the following screen will be displayed. To create a schedule pattern, press the [Schedule pattern wizard] button.

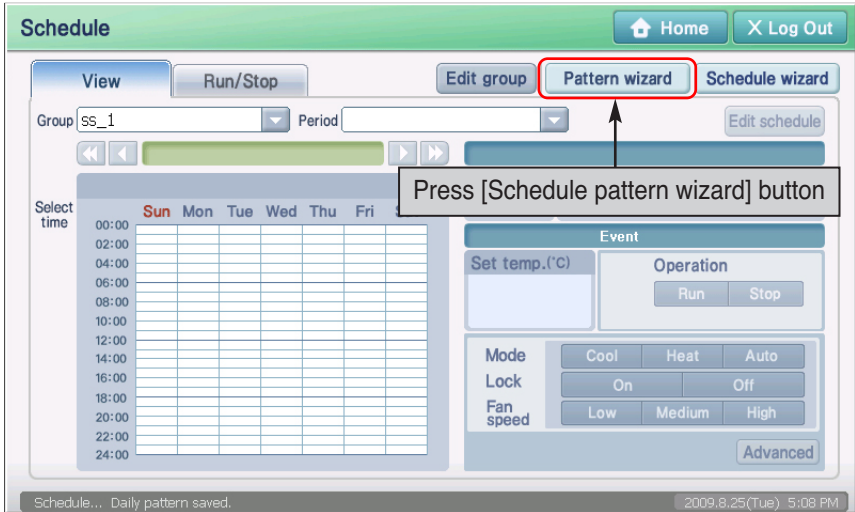

2. "Schedule pattern edit wizard" screen is displayed. To create a new weekly schedule pattern, select "Add/Edit weekly schedule pattern" and press the [Next] button.



3. Select "Add schedule pattern" and press the [Next] button.



Reference: Edit weekly schedule pattern

When editing the weekly schedule pattern, select the weekly schedule pattern to edit and select "Edit weekly pattern". Excluding the fact that you cannot enter the pattern name, as in stage 3 of weekly schedule edit wizard, the process is the same as adding the weekly pattern.

Reference: Edit weekly schedule pattern

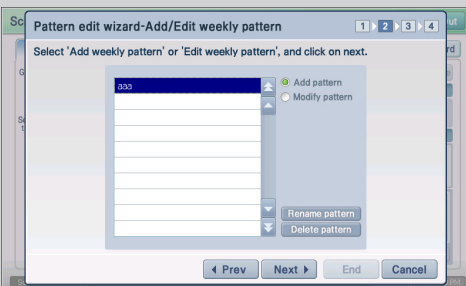

In stage 2 of schedule pattern edit wizard, you can rename/edit/delete the existing schedule pattern.

To rename the schedule pattern, press the [Rename schedule pattern] button and enter the new name.

To delete the schedule pattern, select the schedule pattern to delete and press the [Delete schedule pattern] button.

After renaming/delete the schedule pattern, the wizard does not proceed to the next stage.

4. Enter the name of the weekly schedule pattern, and press the [Next] button.

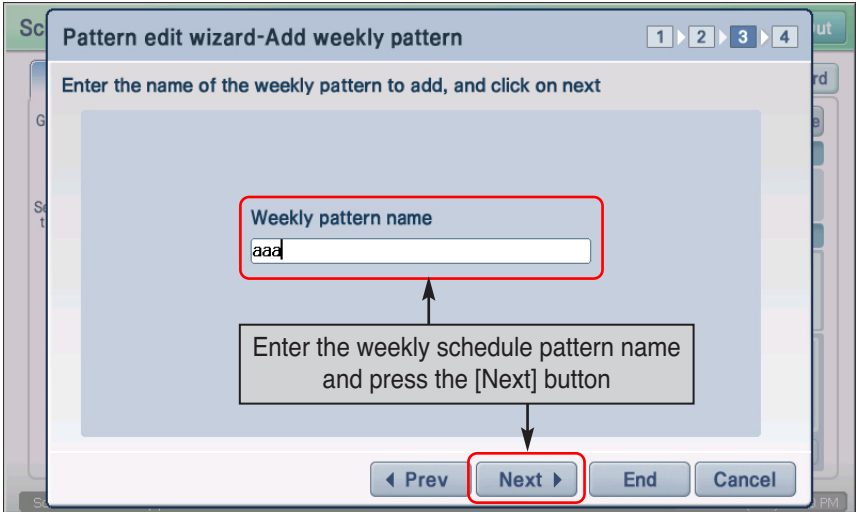

5. Select the time to operate the unit from "Select time" or "Schedule time" item. Set the unit operation from "Control setting" item. Refer to the following table to set the operation.

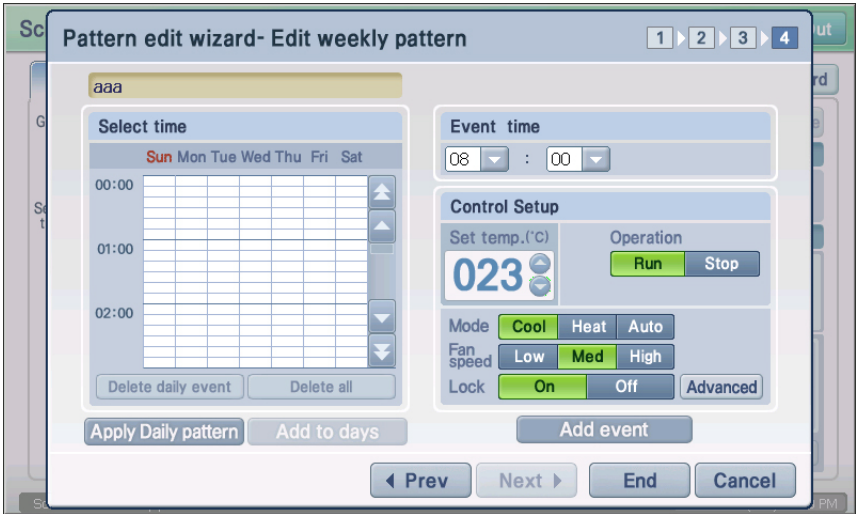

Item	Description
Set temperature	You can set the desired indoor temperature.
Operation	You can set the operation and stopping of the ventilator. - Run: You can operate the ventilator. - Stop: You can stop the operation of the ventilator.
Mode	You can set the operating mode of the indoor unit. - Cool: This operates the cool mode of indoor unit. Execute this mode when the indoor temperature is high. - Heat: This operates the heat mode of indoor unit. Execute this mode when the indoor temperature is low. - Auto: This evaluates the indoor condition and automatically maintains the optimal condition..
Fan level	This sets the fan speed of the ventilator. You can adjust the fan level considering the level of indoor contamination. - Low: This sets the fan speed to low. - Med: This sets the fan speed to med. - High: This sets the fan speed to high.
Lock	You can lock all the functions of the air conditioner so that the user cannot control the air conditioner individually. - All lock: Use the lock function. - All unlock: Do not use the lock function.

Information: Delete all schedule

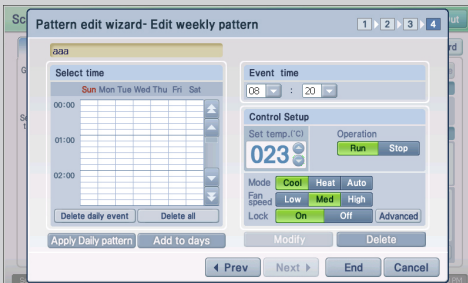

If you want to delete all the existing schedules and create a new one, press the [Delete all schedules] button to easily delete the schedules.

When deleting the schedule of daily unit, select the time zone of the day and press the [Delete daily schedule] button to delete all the schedules set for the applicable day.

6. When you press the [Apply schedule] button, the schedule will be added to the table. If there are additional schedules planned, repeat the above process to additionally set the schedule. When the schedules are all set, press the [End] button.

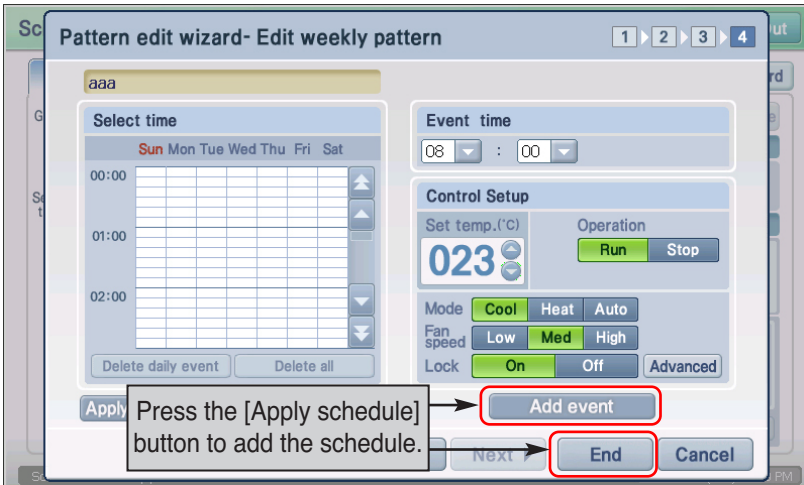

Information: Apply daily schedule pattern and apply daily

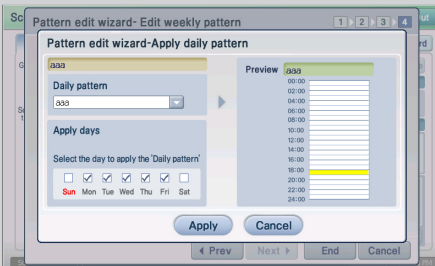

<Screen to apply daily schedule pattern>

You can apply the daily schedule pattern when creating or editing the weekly schedule pattern. When you press the [Apply daily schedule pattern] at stage 4 of the schedule edit pattern wizard, you can open the daily schedule pattern and apply to specific day.

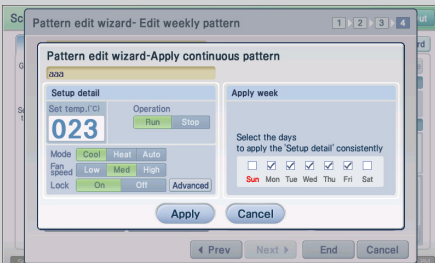

<Screen to apply daily>

Also you can set a specific schedule pattern for several days. Select the schedule pattern at stage 4 of schedule edit pattern wizard and press the [Apply daily] button to apply the same pattern on several days.

7. Message saying that the schedule pattern edit is completed is displayed. Press the [OK] button to complete the editing.

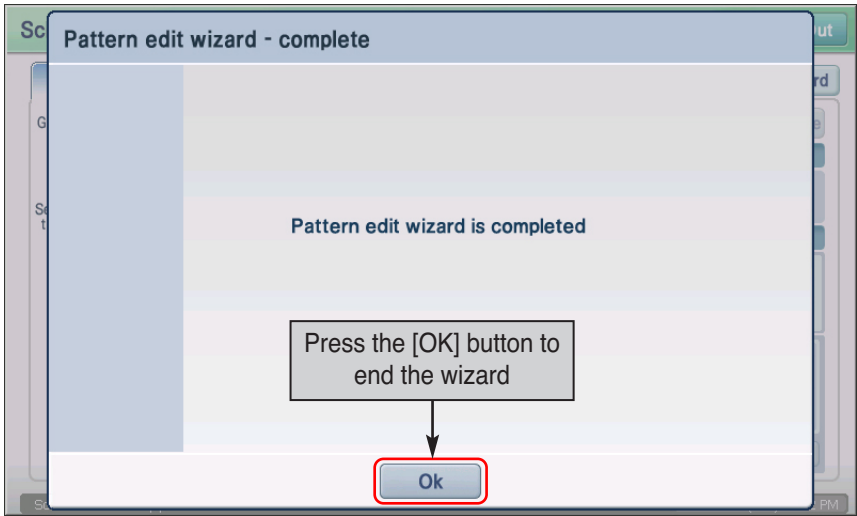

Adding daily schedule pattern

To add the daily schedule pattern, proceed as follows.

1. When you select the "Schedule" menu from the initial screen of AC SMART II, the following screen will be displayed. To create a schedule pattern, press the [Schedule pattern wizard] button.

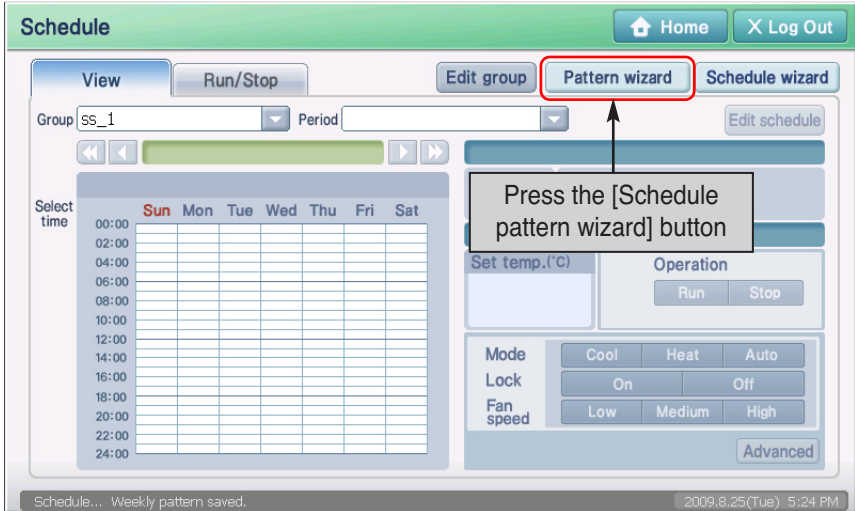

2. "Schedule pattern edit wizard" screen is displayed. To create a new daily schedule pattern, select "Add/Edit weekly schedule pattern" and press the [Next] button.



3. Select the "Add schedule pattern", and press the [Next] button.



Reference: Edit daily schedule pattern

When editing the daily schedule pattern, select the daily schedule pattern to edit and select "Edit daily pattern". Excluding the fact that you cannot enter the pattern name, as in stage 3 of daily schedule edit wizard, the process is the same as adding the daily pattern.

Information: Rename/Delete schedule pattern

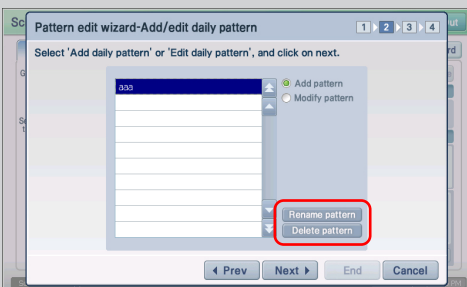

In stage 2 of schedule pattern edit wizard, you can rename/edit/delete the existing schedule pattern.

To rename the schedule pattern, press the [Rename schedule pattern] button and enter the new name.

To delete the schedule pattern, select the schedule pattern to delete and press the [Delete schedule pattern] button.

After renaming/delete the schedule pattern, the wizard does

4. Enter the daily schedule pattern name, and press the [Next] button.

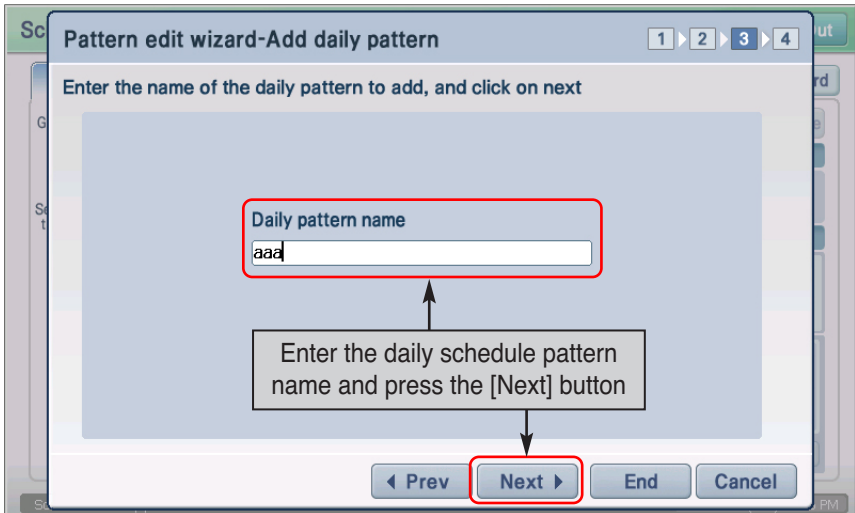

5. Select the time to operate the unit from "Select time" or "Schedule time" item. Set the unit operation from "Control setting" item. Refer to the following table to set the operation.

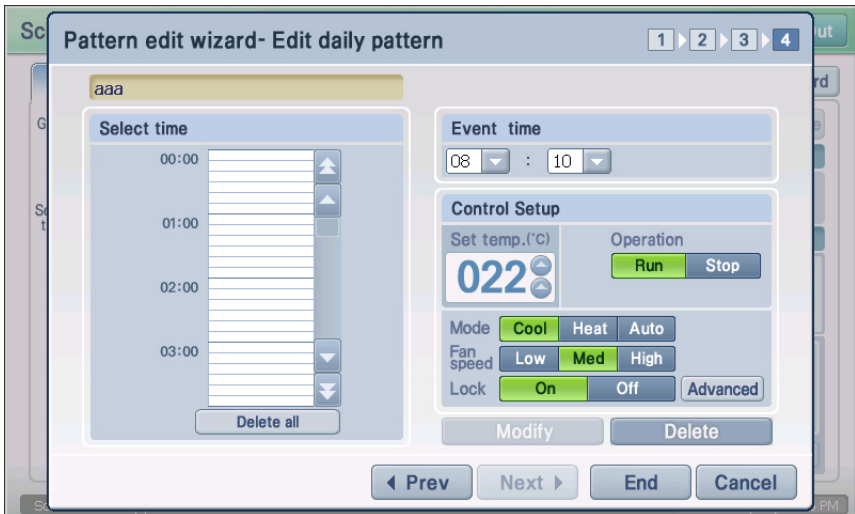

Item	Description
Set temperature	You can set the desired indoor temperature.
Operation	You can set the operation and stopping of the ventilator. - Run: You can operate the ventilator. - Stop: You can stop the operation of the ventilator.
Mode	You can set the operating mode of the indoor unit. - Cool: This operates the cool mode of indoor unit. Execute this mode when the indoor temperature is high. - Heat: This operates the heat mode of indoor unit. Execute this mode when the indoor temperature is low. - Auto: This evaluates the indoor condition and automatically maintains the optimal condition..
Fan level	This sets the fan speed of the ventilator. You can adjust the fan level considering the level of indoor contamination. - Low: This sets the fan speed to low. - Med: This sets the fan speed to med. - High: This sets the fan speed to high.
Lock	You can lock all the functions of the air conditioner so that the user cannot control the air conditioner individually. - All lock: Use the lock function. - All unlock: Do not use the lock function.

Information: Delete all schedule

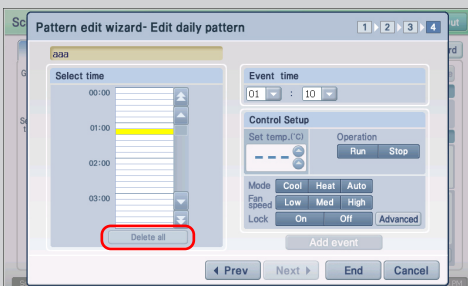

If you want to delete all the existing schedules and create a new one, press the [Delete all schedules] button to easily delete the schedules.

6. When you press the [Apply schedule] button, the schedule will be added to the table. If there are additional schedules planned, repeat the above process to additionally set the schedule. When the schedules are all set, press the [End] button.

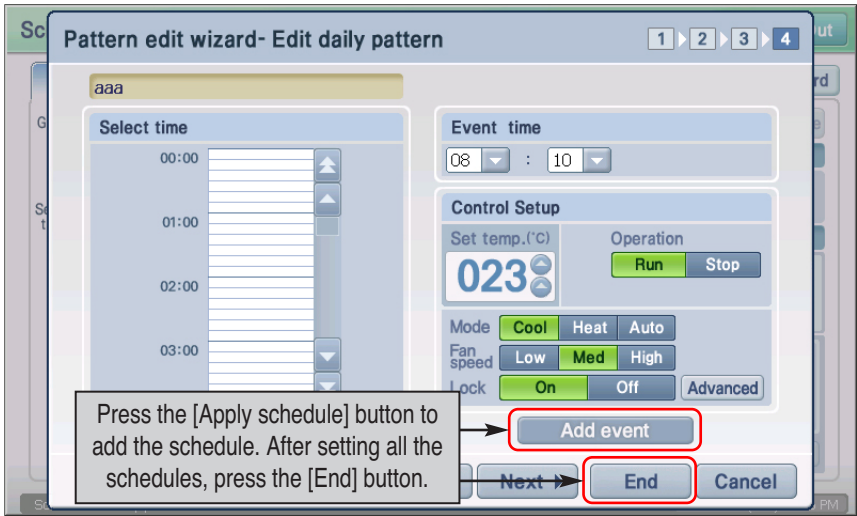

7. Message saying that the schedule pattern edit is completed is displayed. Press the [OK] button to complete the editing.

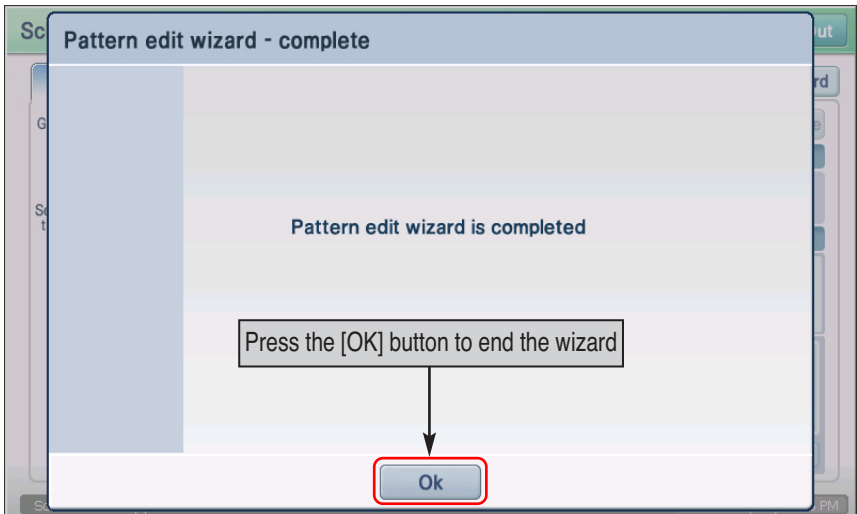

Setting the schedule pattern in detail

When adding/editing the weekly and daily schedule pattern, you can set the detail operation of each unit by setting the detail schedule.

1. In stage 4 of the weekly or daily schedule pattern wizard, press the [Detail control] button.

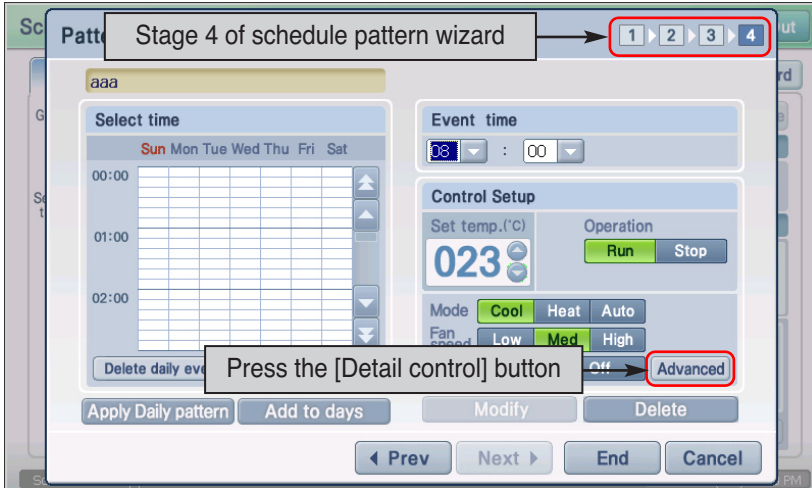

2. "Schedule detail setting" screen to set the detail operation of the unit is displayed. After setting the schedule, press the [Apply] button. Refer to the following table for operations that can be selected from "Detail control".

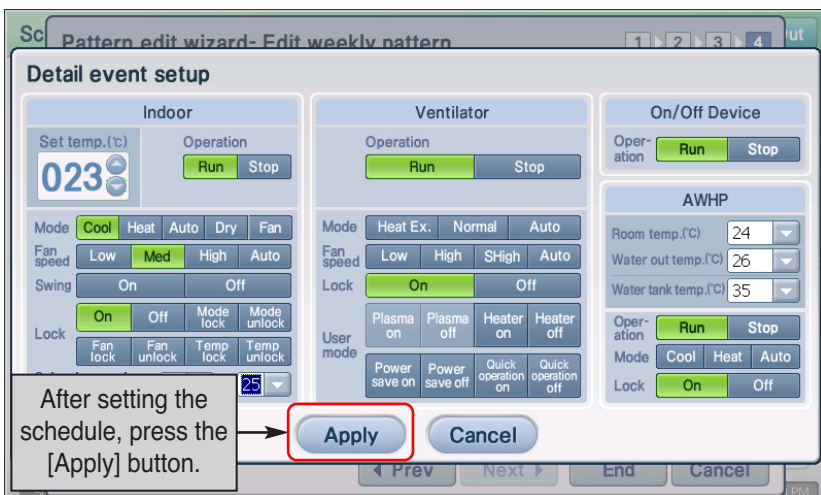

[Indoor unit schedule setting item]

Item	Description
Set temperature	You can set the desired indoor temperature.
Operation	<p>You can set the operation and stopping of the indoor unit.</p> <ul style="list-style-type: none"> - Run : It operates the indoor unit. - Stop: It stops the operation of the indoor unit..
Mode	<p>You can set the operating mode of the indoor unit.</p> <ul style="list-style-type: none"> - Cool: This operates the indoor unit to run cool operation. Execute when the indoor temperature is high. - Heat: This operates the indoor unit to run heat operation. Execute when the indoor temperature is low. - Auto: The unit evaluates the indoor condition and maintains optimal condition automatically. - Dehumidify: This operates the indoor unit to run dehumidifier operation. When you set this during the rainy season or when it is humid, the dehumidifier will remove the humidity effectively. When you set to this mode you cannot set the desired temperature. - Fan: This operates the indoor unit to run fan operation. When you set this for air cleaning operation, fresh air will be circulated. In spring and fall, it is good to use the air cleaner independently When you set the unit to this mode, you cannot set the desired temperature.
Fan level	<p>This sets the fan speed of the ventilator. You can adjust the setting considering the level of indoor contamination.</p> <ul style="list-style-type: none"> - Low: This sets the fan speed to low. - Med: This sets the fan speed to med. - High: This sets the fan speed to high. - Auto: This sets to automatically measure the indoor level of contamination and maintain the optimal condition.
Wind direction	This sets the automatic rotation of the fan.
Lock	<p>You can set the lock function of air condition so that the user cannot control the air conditioner individually.</p> <ul style="list-style-type: none"> - All lock: Enable lock function. - All unlock: This disables the lock function. - Mode lock - This enables the Mode lock function so that the user cannot individually control the operating mode of the indoor unit. - Mode unlock - This disables the mode lock function. - Fan level lock - This enables the Fan level lock function so that the user cannot individually control the fan level of the indoor unit. - Fan level unlock - This disables the Fan level lock function. - Set temperature lock - This enables the Set temperature lock function so that the user cannot individually control the indoor temperature setting. - Set temperature unlock - This disables the set temperature lock function.
Maximum/Minimum temperature setting	<p>Minimum set temperature - You can set the minimum indoor temperature that can be permitted.</p> <p>Maximum set temperature - You can set the maximum indoor temperature.</p>

[Ventilator schedule setting item] (4-35)

Item	Description
Operation	<p>You can set the operation and stopping of the ventilator.</p> <ul style="list-style-type: none"> - Run: You can operate the ventilator. - Stop: You can stop the operation of the ventilator.
Mode	<p>You can designate the operating mode of the ventilator.</p> <ul style="list-style-type: none"> - Heat: Both inlet/outlet go through heat exchange device for ventilation. Use this mode during summer and winter when the difference between the indoor and outdoor is significant in terms of temperature and humidity. - Normal: The exhaust air is ventilated without going through the heat exchanger. Use this mode during spring and fall when the difference between the indoor and outdoor is not too significant in terms of temperature and humidity. - Auto: This measures the indoor temperature and outdoor temperature and automatically controls inlet and outlet. With this, the balance of the indoor air is maintained to maintain the optimal condition.
Fan level	<p>This sets the fan speed of the ventilator. You can adjust the level by considering the indoor level of contamination.</p> <ul style="list-style-type: none"> - Low: This sets the fan level to low. - High: This sets the fan level to high. - Super: This sets the fan level to maximum speed. - Auto: This is set to maintain the optimal condition by measuring the indoor level of contamination automatically.
Lock	<p>You can set the lock function so that the user cannot operate the ventilator individually.</p> <ul style="list-style-type: none"> - All lock: This is set so that the ventilator cannot be operated. - All unlock: This is set so that the ventilator can be operated.
User mode	<p>You can designate the additional operating method of the ventilator.</p> <ul style="list-style-type: none"> - Enable plasma: This enables the plasma function. Current this cannot be designated. - Disable plasma: This disables the plasma function. Currently this cannot be designated. <div style="background-color: #e0e0e0; padding: 10px; border-radius: 10px; margin: 10px 0;"> <p>Reference: What is plasma?</p> <p>This is the air cleaning function to make the air pleasant with negative ion. This function not only remove the household virus or fungus but also removes the influenza virus, which is the most commonly known cold virus, thinking not just the environment but also the health of the family.</p> </div> <ul style="list-style-type: none"> - Enable heater: You can enable the heater function to provide heated air during the winter when the outdoor air is cold. - Disable heater: This disable the heater function. - Enable power save: Ventilator operates in the most efficient condition to save the power consumption.

Item	Description
User mode	<ul style="list-style-type: none"> - Disable power save: This disables the power save function. - Enable quick operation: This enables the unit to operate in maximum performance to prevent the expansion of contaminated indoor air or humidity to other space. It is recommended to use this when the indoor contamination is severe. - Disable quick operation: If the quick operation mode is in operation, this stops the operation.

[On/Off unit schedule setting item]

Item	Description
Operation	<p>You can turn On/Off the unit connected to AC SMART II.</p> <ul style="list-style-type: none"> • [Operate]: Operate the On/Off unit. • [Stop]: Stop the On/Off unit.

[AWHP unit schedule setting item]

Item	Description
Air temperature	You can set the indoor air temperature.
Water temperature	Set the water temperature that goes through AWHP unit.
Hot water temperature	You can set the water temperature within the hot water tank.
Operation	<p>You can operate/stop the AWHP unit.</p> <ul style="list-style-type: none"> • Operate: Set to turn on the power of AWHP unit. • Stop: Set to turn off the power of AWHP unit.
Mode	<p>You can set the operating mode of the AWHP unit.</p> <ul style="list-style-type: none"> • [Cool]: Operate in cool mode. • [Heat]: Operate in heat mode. • [Auto]: Judges the indoor condition and automatically maintains optimal condition.
Lock	<p>Set so that AWHP unit cannot be operated individually.</p> <ul style="list-style-type: none"> • [All lock]: Set the all lock function so that all functions of AWHP unit cannot be changed individually. • [All unlock]: Disable the all lock function.

Reference: Air temperature and outlet water temperature setting

Even though the air temperature and outlet water temperature item can be set simultaneously from AC SMART II, the AWHP unit is controlled based on air temperature and outlet water temperature. Applied criteria (Air temperature, water temperature) can be set with the remote controller.

Applying the schedule

Schedule refers to the designation of operation during the applicable time period by adding the units (Indoor unit, Ventilator, On/Off unit, AWP unit) to the schedule group and schedule pattern.

AC SMART II provides the schedule wizard to make the schedule application easy. Schedule wizard is composed of 6 stages as shown below. But the schedule copy between Groups is done in a separate 2 stage process.

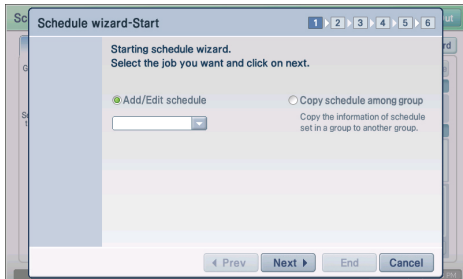

1. Add/Edit schedule

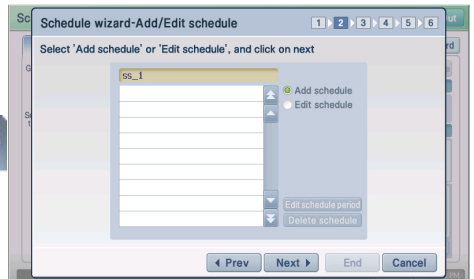

2. Add/Edit schedule

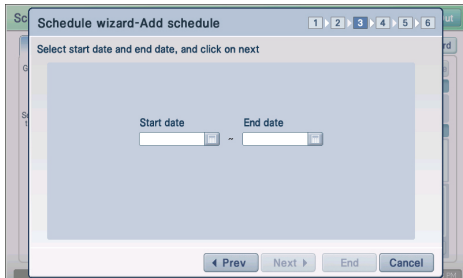

3. Select schedule start and end date

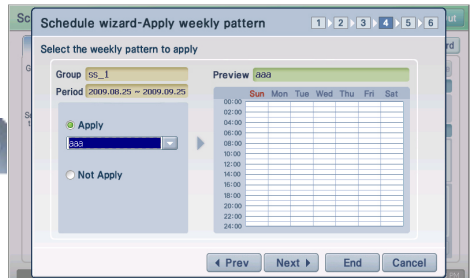

4. Apply set weekly schedule pattern

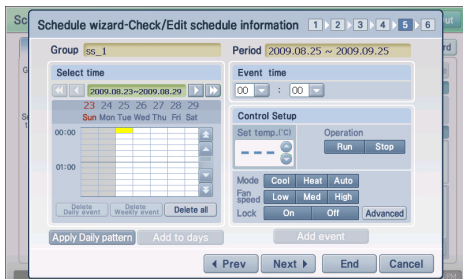

5. Check/Edit schedule

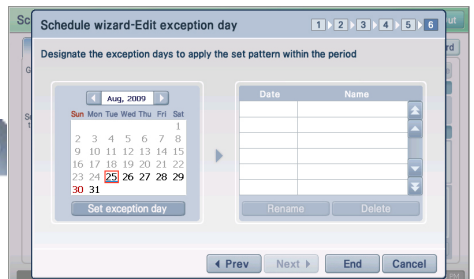

6. Set exception day to exclude from schedule application

To apply the schedule, you must proceed as follows.

1. When you select the "Schedule" menu from the initial screen of AC SMART II, the following screen will be displayed. To apply the schedule, press the [Schedule wizard] button.

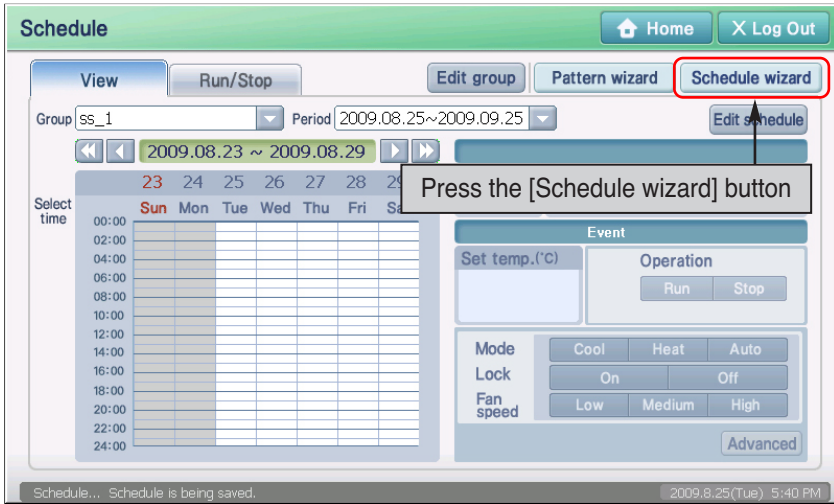

2. Schedule wizard screen is displayed. Select "Add/Edit schedule" and select the Group to apply the schedule to. Press the [Next] button.



Reference : Creating schedule group

To create and apply a new schedule group, refer to the "Managing schedule group" section in page 82 to create a new schedule group.

3. Select "Add schedule" and press the [Next] button.

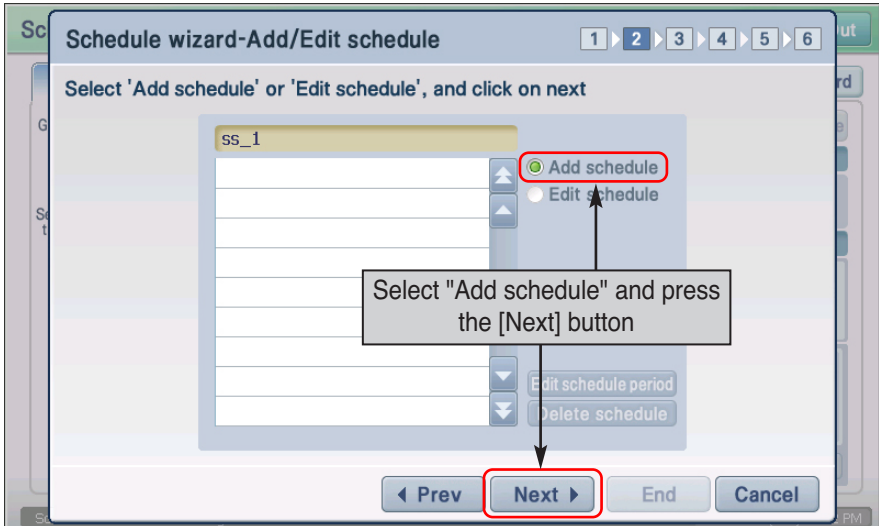

Information: Editing schedule period and deleting schedule

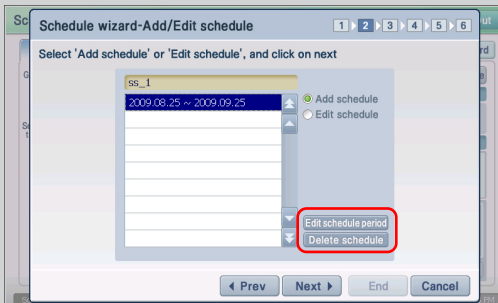

In stage of schedule wizard, you can edit the applied period of the existing schedule and delete the existing schedules.

To edit the schedule period, press the [Edit schedule period] button to set the new period.

To delete the schedule, select the schedule period to delete and press the [Delete schedule] button.

After editing the schedule period and deleting the schedule, the wizard does not proceed to the next stage.

4. When you press the  button, the calendar is displayed. Use the calendar to select the period (Start date, End date). After the entry, press the [Next] button.

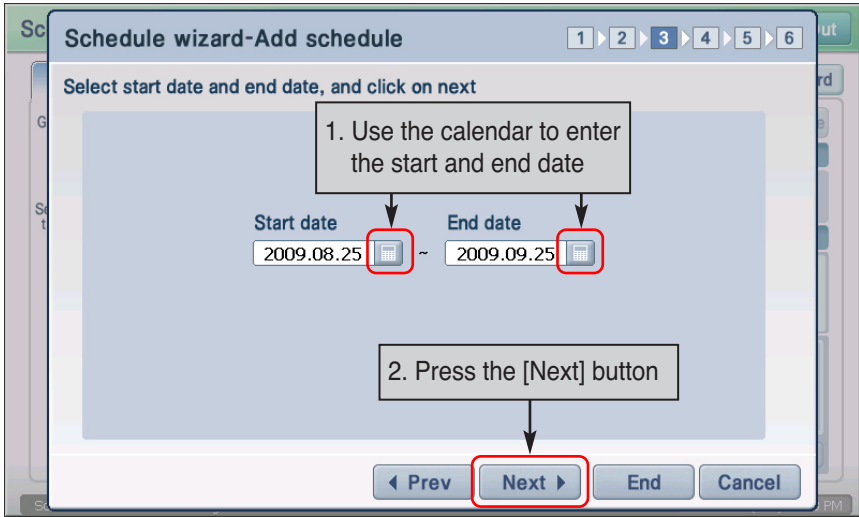

5. Set whether to apply the weekly schedule pattern. To apply the weekly schedule pattern, select the "Apply" item and select the weekly schedule pattern to apply. If you do not want to apply the weekly schedule pattern, select "Do not apply" item and you can directly enter in stage 5.

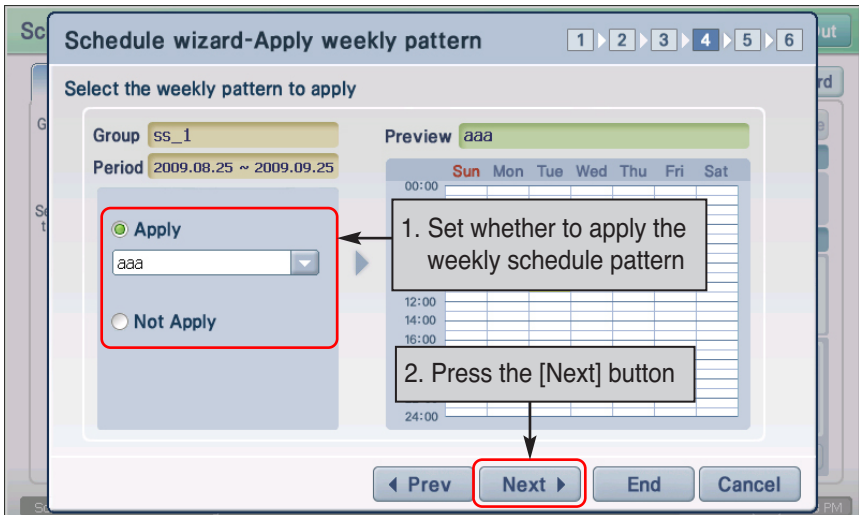

6. Check the current schedule setting information. Also you can add a new schedule or add/delete set schedule. After checking the schedule information, press the [Next] button.

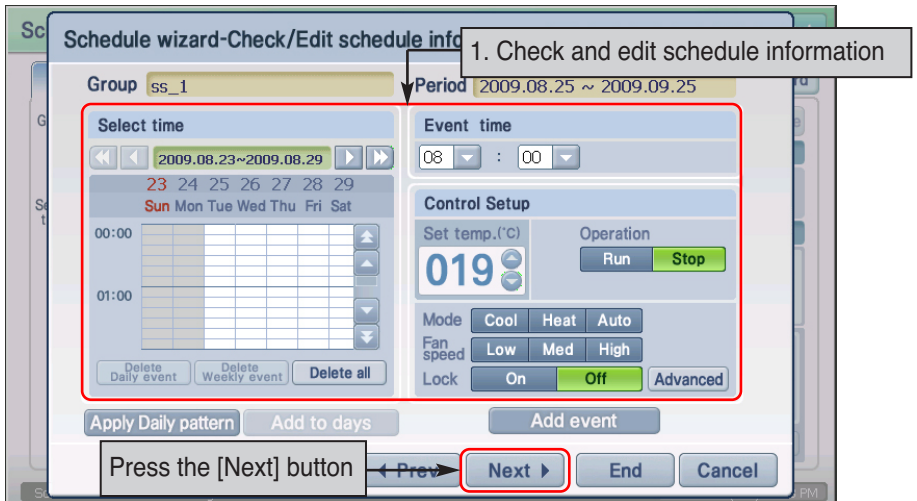

Reference: Schedule edit

When editing the schedule, the setting for the input item is the same as that of schedule pattern. For details on the setting items, refer to the "Creating schedule pattern" section.

7. 7. Lastly designate the exception days. Exception day is to set specific days within the schedule period not to apply the schedule. To register as exception day, select the day from the calendar and press the [Register exception day] button.



Reference: Exception day setting

Exception day setting is not a mandatory entry item. If you do not need the exception day, press the [End] button to end the schedule setting.

- When you see the screen to enter the name of exception day, enter the name of the exception day, and press the [OK] button. And then [Next] button.

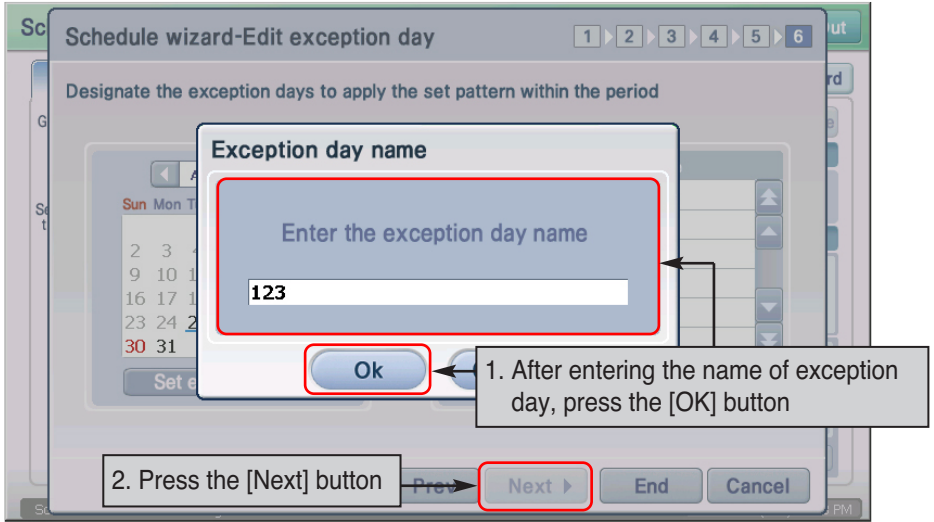

- Check the exception day setting and press the [End] button.

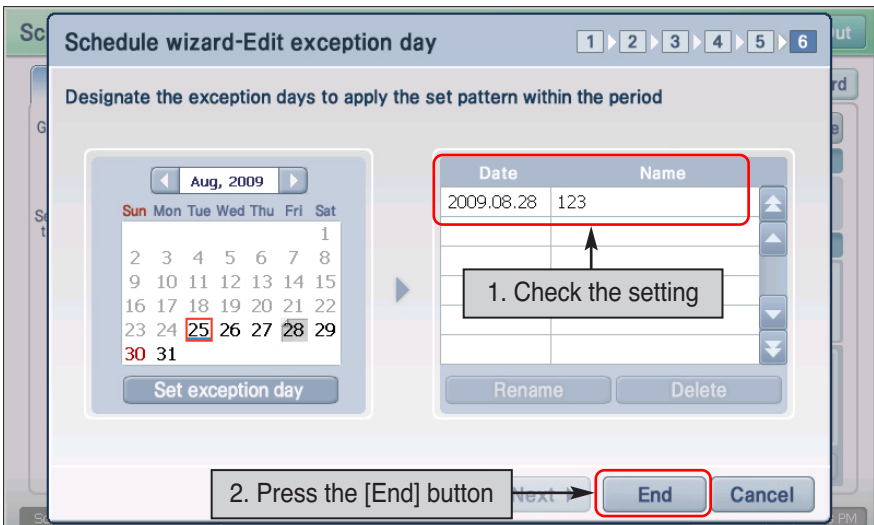

Information: Renaming/Deleting exception day

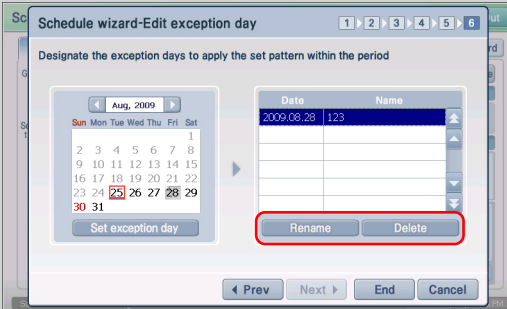

In the exception day edit screen, you can rename or delete the exception day.

To rename the exception day, select the name of the exception day and press the [Rename] button to enter the new name.

To delete the exception day, select the exception day and press the [Delete] button

10. Screen to confirm that the schedule editing has been completed is displayed. Press the [OK] button to end the schedule setting.

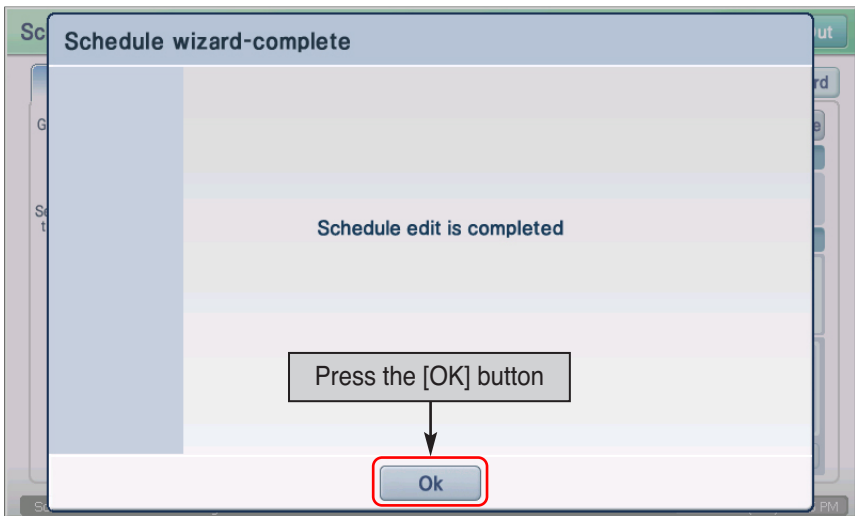

Information: Copying the schedule

You can copy the schedule set for a schedule group to a schedule of another schedule group.

1. Select the "Copy schedule between groups" item from the schedule wizard start screen, and press the [Next] button.

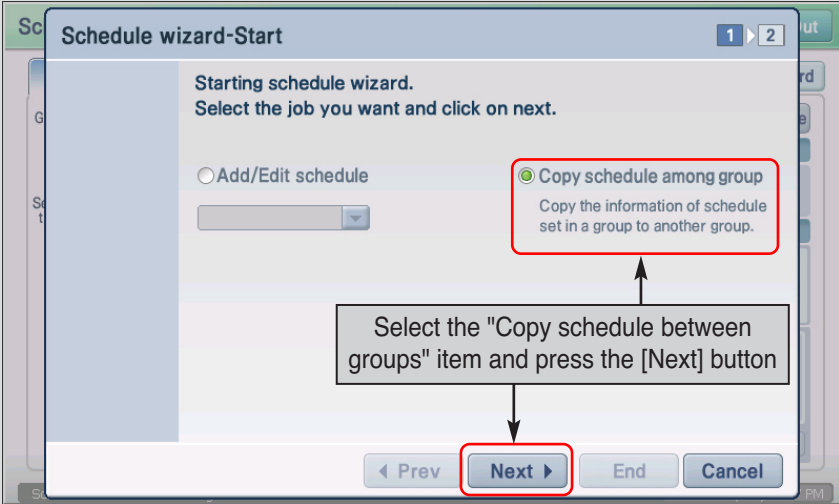

2. Set the original schedule group and applied period to copy the schedule from, and select the target group to copy the schedule to, and then press the [Next] button. When the schedule wizard ending screen is displayed, press the [OK] button.

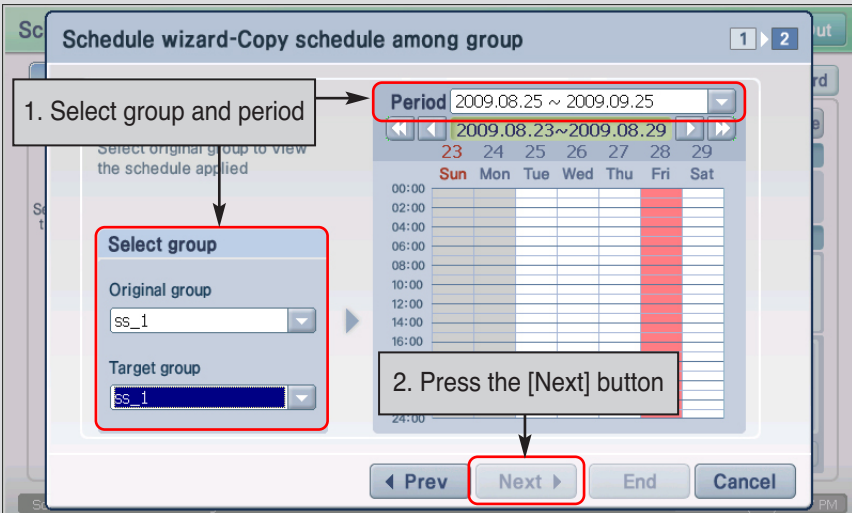

Viewing the schedule

Schedule view tab is the first screen to be displayed when the user selects the schedule menu. From the schedule view screen, you can check the details of the schedule applied to a specific schedule group. Also you can directly edit the schedule.

The screenshot shows the 'Schedule' menu interface. At the top, there are 'Home' and 'Log Out' buttons. Below that, there are 'View', 'Run/Stop', 'Edit group', 'Pattern wizard', and 'Schedule wizard' buttons. The main area is divided into several sections:

- Group and Period:** A dropdown menu for 'Group' (set to 'SS_1') and a date range for 'Period' (2009.08.25~2009.09.25). There is an 'Edit schedule' button next to it.
- Weekly Schedule:** A calendar view showing days from Sunday (23) to Saturday (29). A blue bar is visible on Tuesday (25) from 08:00 to 09:00.
- Event Details:** On the right, it shows 'Event count 1' and '08:00'. Below that, it displays 'Set temp.(C) 023' and 'Operation' with 'Run' and 'Stop' buttons.
- Mode and Fan Speed:** At the bottom right, there are buttons for 'Mode' (Cool, Heat, Auto), 'Lock' (On, Off), and 'Fan speed' (Low, Medium, High). An 'Advanced' button is also present.

Callouts with arrows point to various elements:

- 'You can select the schedule group.' points to the 'Group' dropdown.
- 'You can select the schedule period.' points to the 'Period' date range.
- 'You can edit the schedule.' points to the 'Edit schedule' button.
- 'You can select and view the schedule set in 1 week unit.' points to the weekly calendar view.
- 'You can view the weekly schedule detail by time zone.' points to the time slots on the calendar.
- 'You can view the number and operation of the schedule.' points to the 'Event count' and 'Operation' buttons.
- 'You can view the scheduled operation by unit in detail.' points to the 'Advanced' button.

Reference: Schedule group and schedule setting

In the schedule view, you can only check the schedule group and schedule details that have been set. Therefore, if the schedule group and schedule are not set, set the schedule group and schedule following the directions from the previous section.

To check or edit the schedule detail, proceed as follows.

1. Press the 'View' tab from the schedule menu. When you select the schedule group and period to check, you can check the schedule.

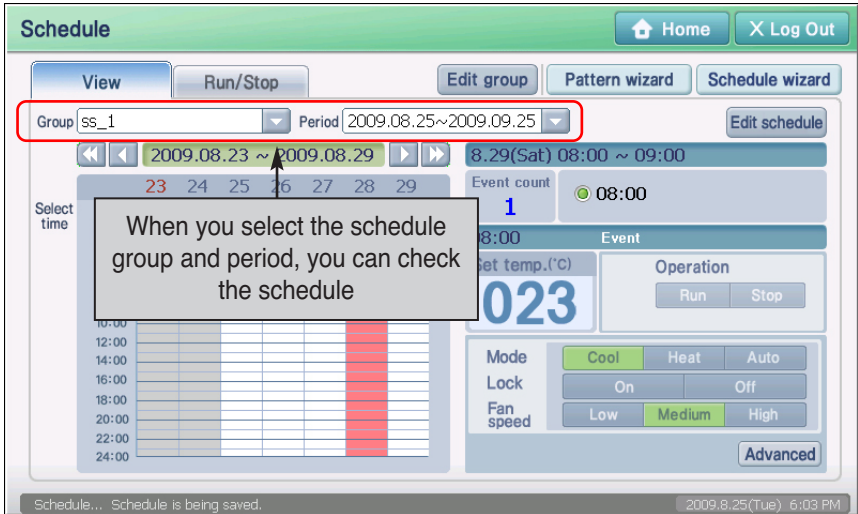

Information: View schedule detail



When you press the [View detail] button, the "View schedule detail" screen will be displayed. In this screen, you can check the schedule operation by unit in detail.

2. To edit the applied schedule, press the [Edit schedule] button located at the top right corner of the screen.

When the schedule wizard screen is displayed, you can edit the existing schedule. After editing the schedule, press the [End] button to end editing the schedule.

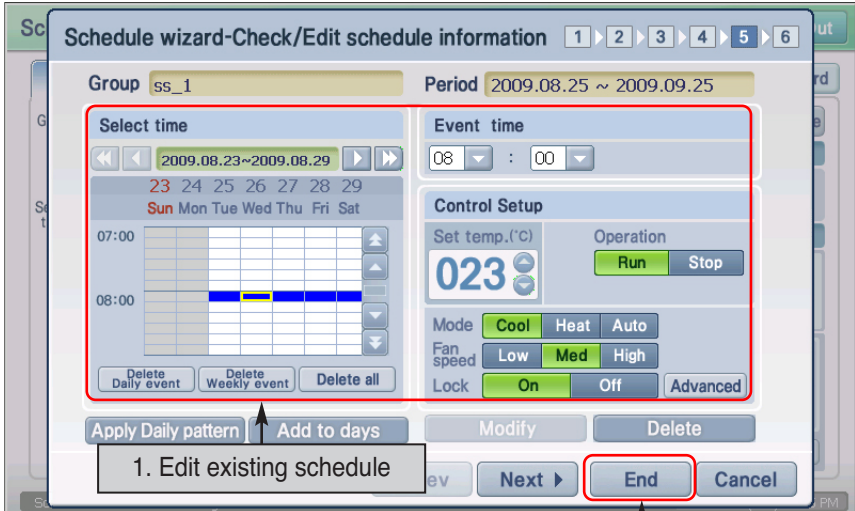

2. Press the [End] button to end the edit

Reference: Edit schedule

When editing the schedule, the setting for the input item is the same as that of schedule pattern setting. For description of detail setting item, refer to the "Creating schedule pattern" section.

Running/Stopping the schedule

You can run/stop the schedule applied to the Group from the schedule run/stop tab.

The screenshot shows the 'Schedule' application window with the 'Run/Stop' tab selected. The window title is 'Schedule' and it has buttons for 'Home' and 'Log Out'. Below the title bar are tabs for 'View', 'Run/Stop', 'Edit group', 'Pattern wizard', and 'Schedule wizard'. The main content area says 'You can run/stop the schedule applied to each group' and has two radio buttons: 'Run schedule by guoup' (selected) and 'Stop all group schedule'. Below these is a list of groups: 'ss_1', 'ss_2', 'ss_3', 'ss_4', and 'ss_5', each with a checkbox. At the bottom are 'Apply' and 'Cancel' buttons. A status bar at the bottom shows 'Schedule... Run/Stop by group is saved.' and the date/time '2009.8.25(Tue) 6:06 PM'.

You can select to stop the schedule of individual or all group.

You can select the group to stop when stopping the schedule by group.

Apply the schedule run/stop setting.

You can cancel the schedule run/stop setting.

To run/stop the schedule, proceed as follows.

1. Press the 'Run/Stop' tab from the schedule menu. Check whether the schedule group and schedule are operating.

This screenshot is similar to the previous one, but with a red rectangular box highlighting the radio buttons and the list of groups. An arrow points from a callout box below to the 'Apply' button.

Check whether the schedule is run

2. When running the schedule by Group, select the 'Run schedule by Group' item and mark '✓' next to the schedule group to run. If you want to stop all schedules, select the 'Stop all Group schedule' button. After selecting, press the [Apply] button.

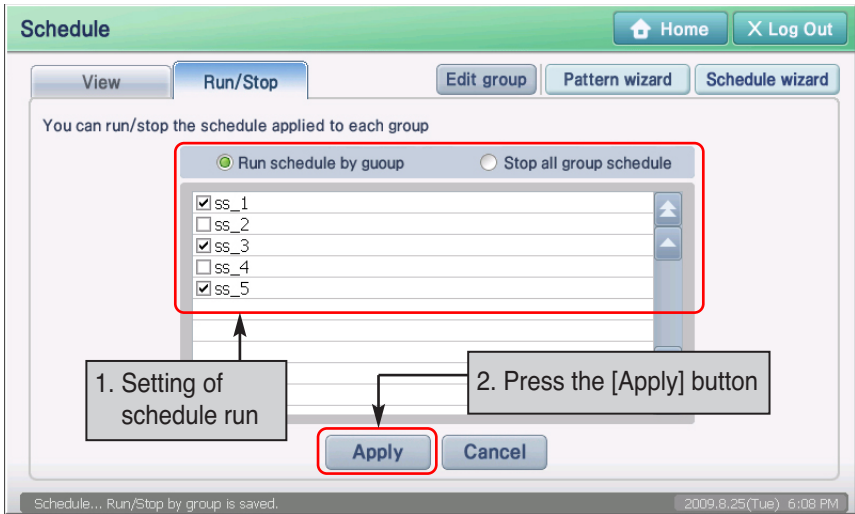

3. Message on schedule run/stop setting is displayed. Press the [OK] button to end the setting.

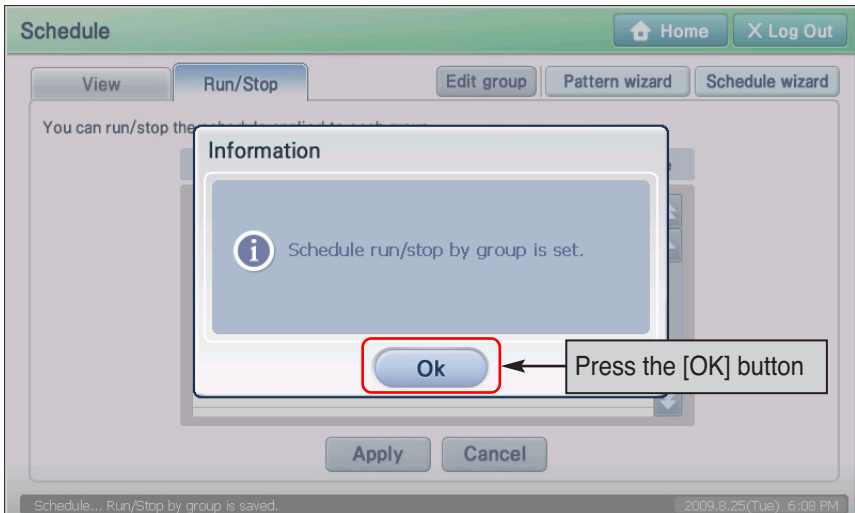

6. Auto control menu

The AC Smart can automatically control the indoor unit, the ventilator and the On/Off device interconnected via the network with various methods.

Auto control menu provides 3 functions, as follows, as the auto control function.

- Temperature limit operation: Function to maintain indoor temperature at maximum/minimum temperature set by controlling the air conditioner indoor unit automatically by setting the maximum and minimum temperature and by monitoring the indoor temperature
- Auto change over operation: Function to maintain optimal indoor temperature through the automatic switching of air conditioner operating mode (Cool, heat)
- Time limited operation: Automatically stop running after the set time by controlling the running time of indoor unit, ventilator and On/Off device, AWHP.

Press the tab to select the detail operation function of the auto control menu.

Group name	Low temp	High temp	Temp. reference	En/Disable	Unit count
f_1	15	35	Average	Enable	0
f_2	5	40	Fixed	Disable	0
f_3	5	40	Fixed	Disable	0

In the auto control menu, you can apply the function by creating a separate Group for each operational function. Also you can create the same operating Group as the Group designated from the 'Unit management' menu.

Managing operating group

In auto control, you must create/apply each group for the temperature limit operation, auto change over operation and time limited operation.

Reference: Temperature limit operation and auto change over operation group setting criteria

Temperature limit operation and auto change over operation are functions targeted only to the indoor units. Therefore the Group can only be created or edited for the indoor units, and cannot include ventilator, On/Off unit and AWHP unit.

Reference: Auto changer over operation group setting

If the outdoor unit is not a changer over type and not a synchronized type, always set one outdoor unit to the connected indoor units to form a group when setting the auto change over operation. If not, it can cause irregular operation. (CH 07 error)

This describes the method of creating/renaming/deleting the Group for the example of time limit operation. You can create/rename/delete the Group in the same way for temperature limit operation and auto change over operation as well.

Creating operating group

To create a new operating Group, proceed as follows.

1. Press the [Edit group] button located at the bottom of the 'Auto control' screen.

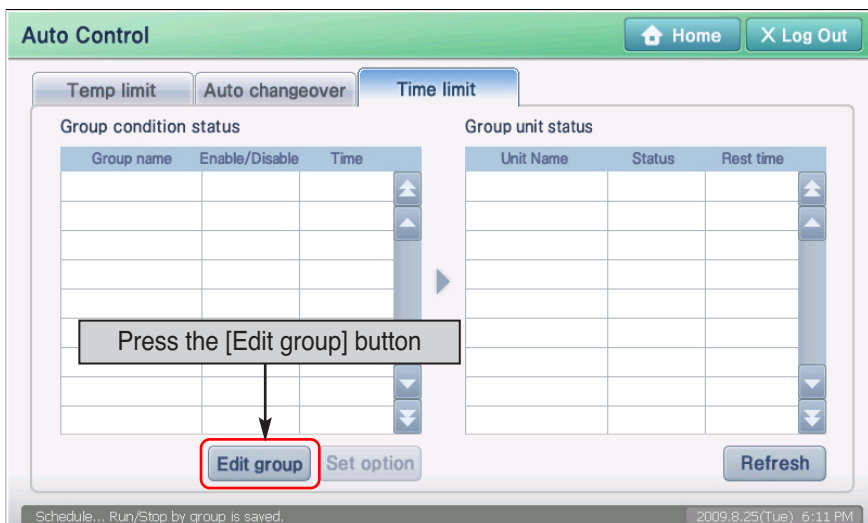

Reference: Location of edit button for temperature limit operation and auto change over operation group

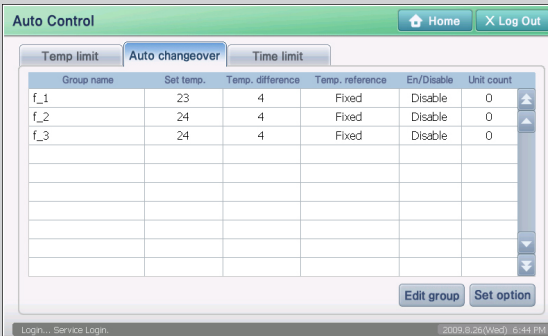

For the temperature limit operation and auto change over group, the [Edit group] button is located at the bottom right side of the screen.

2. 'Edit group' screen is displayed. To create a new operating group, press the [Add] button. 'Add group' screen will be displayed to enter the name of the group.



When you press the [Add] button, "Add group" screen is displayed

3. Enter the name of the group to create and press the [OK] button.

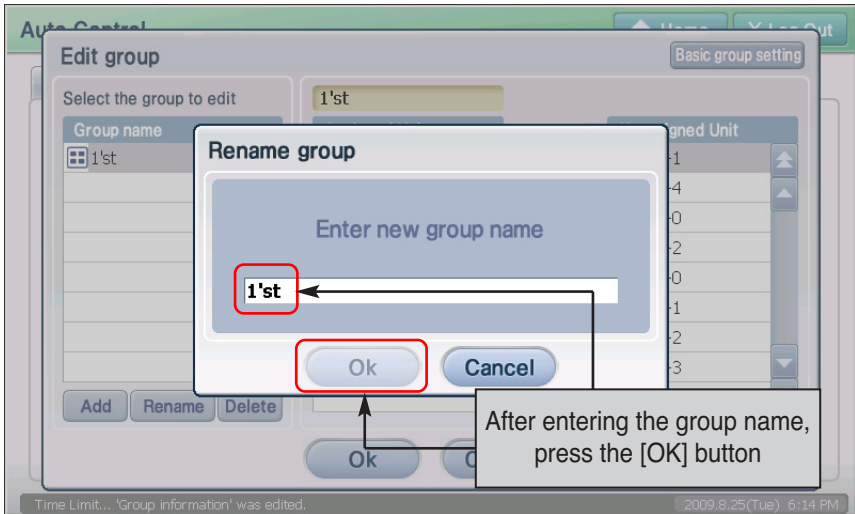

4. Check whether the applicable operating group has been created for the 'Group name'. Now select the unit to include in the newly created group from the unregistered unit list, and press the [◀] button to move to the registered unit list.

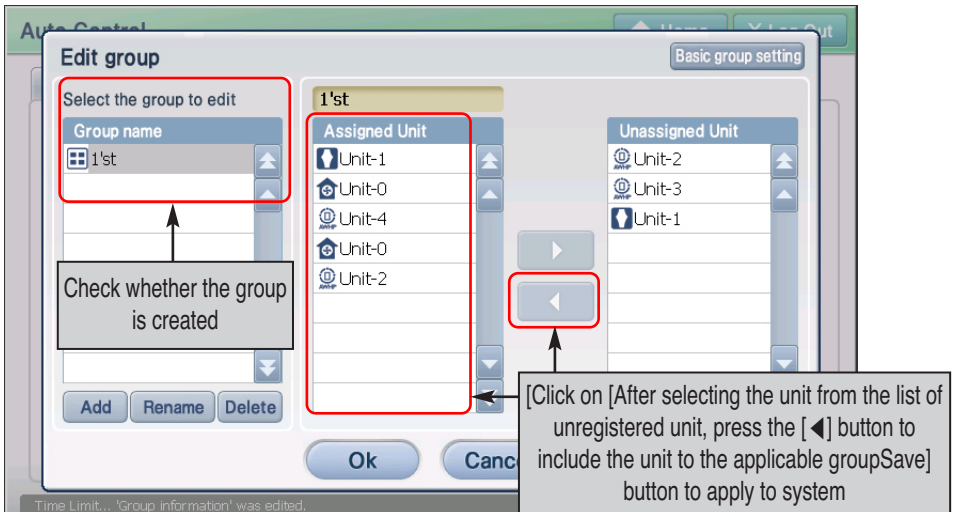

5. Press the [Save] button to save the setting. When creating the group is completed, it will return to the previous screen.

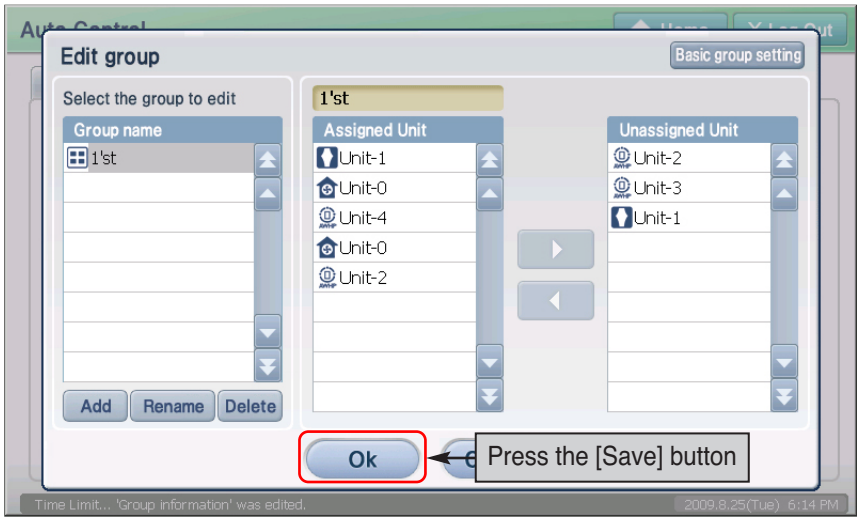

Information: Setting the operating group to basic group

When you press the [Set basic group] button located at the top right side of the screen, you can create the same operating group as the basic control group you set in control and monitoring from the "Unit management" menu.

The screenshot displays the 'System' interface with a tree view on the left showing a hierarchy: 'AC SMART' (parent), 'sss' (child), and 'ss' (child of 'sss'). Below the tree are 'Add', 'Rename', and 'Delete' buttons. To the right are two lists: 'Assigned Gr/Unit' (empty) and 'Unassigned Gr/Unit' (containing Unit-0 through Unit-4). A 'Basic group setting' dialog is overlaid, showing 'ss' selected in the 'Group name' list. A callout box points to the 'Rename' button in the top window and contains the text: 'When you press the [Set basic group] button, the same group as the group configured through the "Setting" menu will automatically be created as the operating group.'

Deleting the operating group

To delete the operating group, proceed as follows.

1. Press the [Edit group] button located at the bottom of 'Auto control' screen.

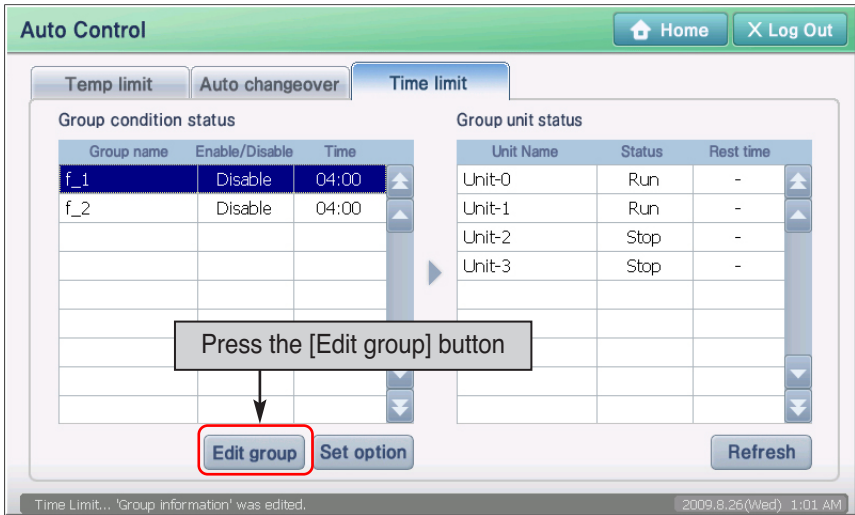

2. 'Edit group' screen is displayed. Select the operating group to delete and press the [Delete] button. The applicable group will be deleted.

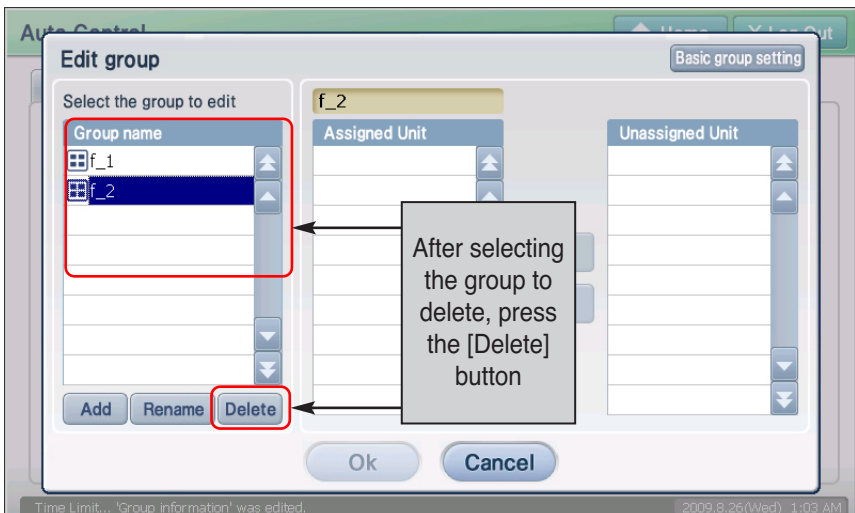

3. Verify if corresponding drive group is created at 'group name'. Then, select the device to be included at created group from un-registered device list and move it to registered device list by pressing [◀] button.

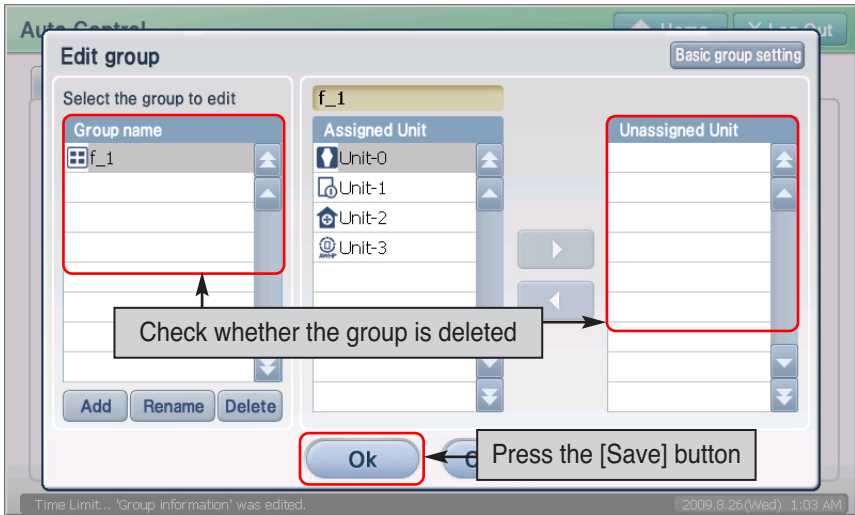

Renaming the operating group

To rename the operating group, proceed as follows.

1. Press the [Edit group] located at the bottom of the 'Auto control' screen.

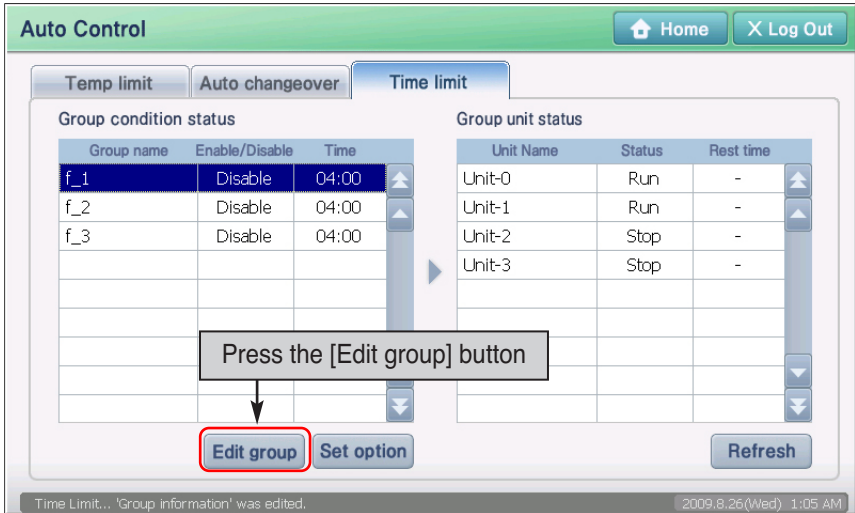

2. 'Edit group' screen is displayed. Select the group to rename and press the [Rename] button. 'Rename group' screen will be displayed to enter the name of the group.

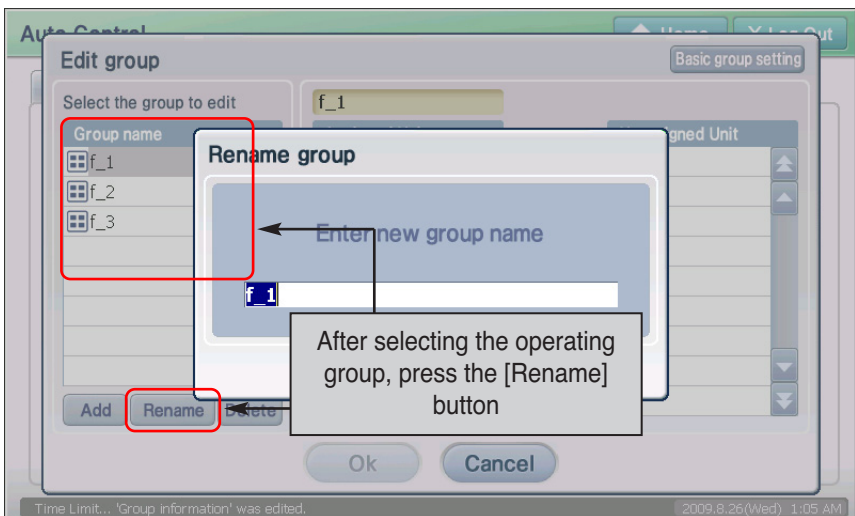

3. After entering the name of the operating group to change, press the [OK] button.

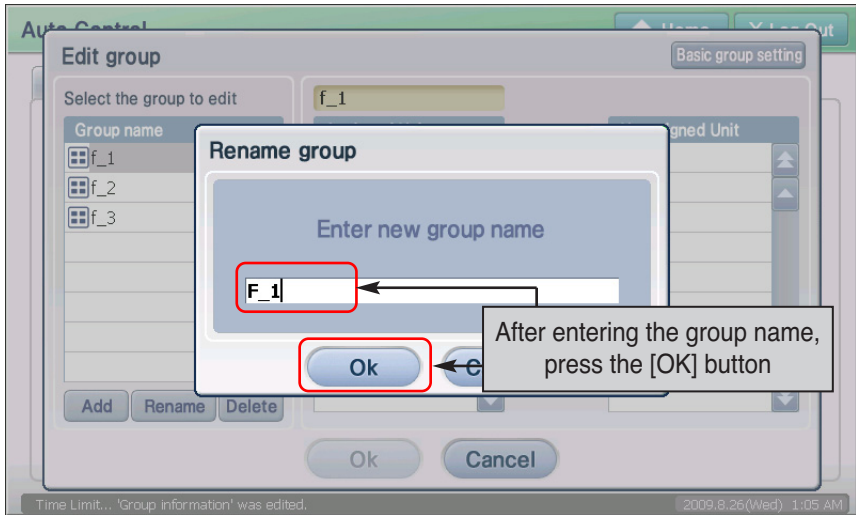

4. Check whether the name of the applicable group has been changed in the 'Group name', and press the [Save] button to save the setting. When the renaming of the group is completed, it will return to the previous screen.

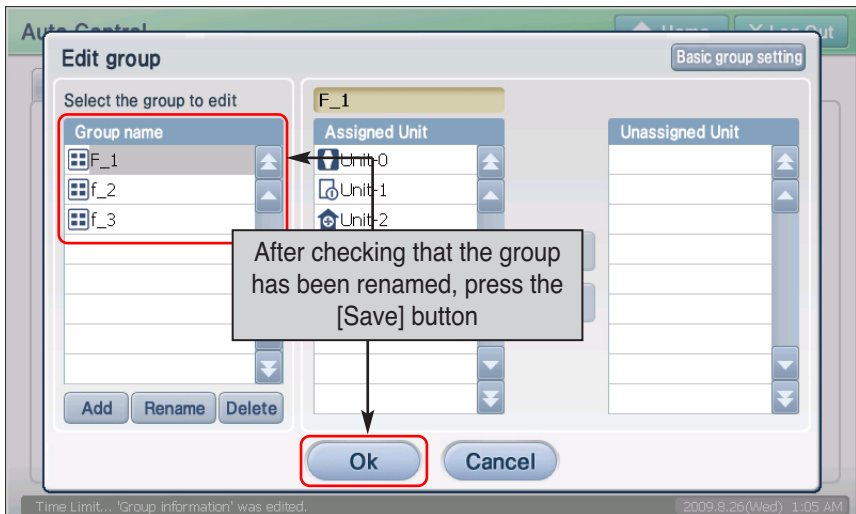

Temperature limit operation(4-63)

Temperature limit operation is the function to maintain the temperature of the space where the air conditioner is installed within a certain temperature range ($+4^{\circ}\text{C} \sim -4^{\circ}\text{C}$).

AC SMART II can automatically control the indoor temperature so that the temperature does not exceed the range based on the upper/low limit temperature set by the user and the current indoor temperature.

When you use the temperature limit operation function, you can efficiently protect the building from problems such as water pipe freezing from outdoor temperature or overheating from indoor temperature etc.

To execute the temperature limit operation function, the user enters the maximum and minimum temperature as follows. AC Smart operates as follows based on the entered value.

- When the indoor temperature higher than the set temperature, the cooling function of the indoor unit will run to lower the indoor temperature below the set temperature.
- When the indoor temperature is lower than the set temperature, the heating function of the indoor unit will run to raise the indoor temperature above the set temperature.

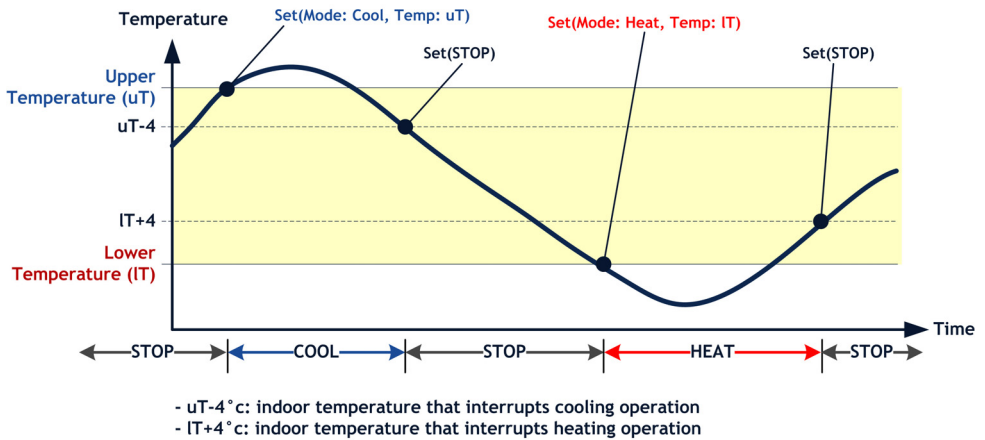

When the set value or temperature reference changes during the temperature limit operation function, the changed setting is reflected when operating mode (Cool, heat) changes.

When you press the temperature limit operation tab from the auto control menu, the following screen to set the temperature limit operation will be displayed.

The group that has been set up for the temperature limit operation and the details of the setting are displayed in table format.

You can create/edit/delete the group to apply the temperature limit operation.

Possible to set up the condition about the temperature control drive

Group name	Low temp	High temp	Temp. reference	En/Disable	Unit count
f_1	5	40	Fixed	Disable	1
f_2	5	40	Fixed	Disable	0
f_3	5	40	Fixed	Disable	0

Refer to the following table for descriptions on the setting of Temperature limit operation.

Item	Description
Group name	Name of temperature limit operation group is displayed.
High Temp.	This is the maximum temperature (uT) set for indoor temperature.
Low Temp.	This is the minimum temperature (IT) set for indoor temperature.
Temp. reference	Operating method of temperature limit mode is displayed. - Average: This is the method of operating the temperature limit operation function based on the average temperature detected for the indoor units within the group - Fixed: This is the method of operating the temperature limit operation function based on the temperature detected from the first registered indoor unit within the group
En/Disable	Whether temperature limit operation function is applied is displayed.
Unit count	Number of units included in each group is displayed.

Caution: Temperature limit operation setting of Multi V



When the cooling/heating operation of Multi V changes from the temperature limit operation, it can affect the operation of other indoor units not set for temperature limit operation.

Setting temperature limit operation(4-66)

To set the temperature limit operation function, proceed in the following order.

1. Select 'Auto control' menu from the menu of AC Smart. When you select the 'Auto control' menu, the following auto control screen is displayed. Click on the [Set option] button.

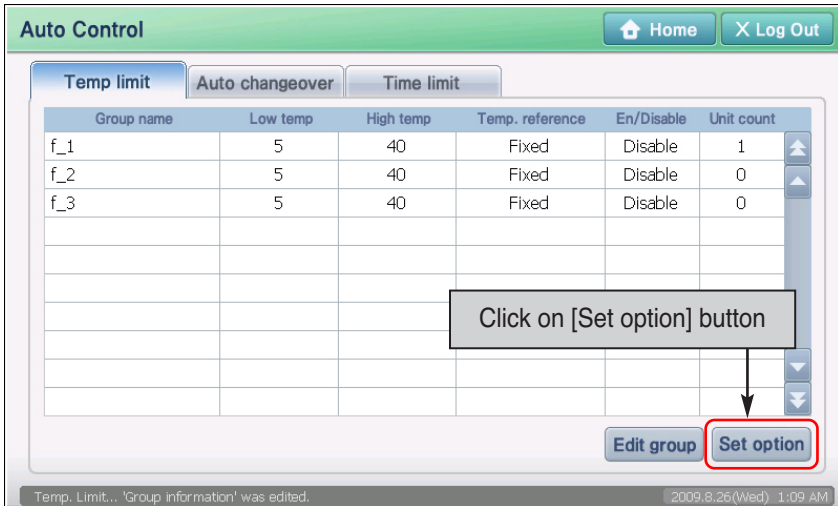

2. The 'Condition setting' screen is displayed. Select the temperature limit operation group to set the temperature limit operation function and set each item. For detailed description on the setting item, refer to the following table.

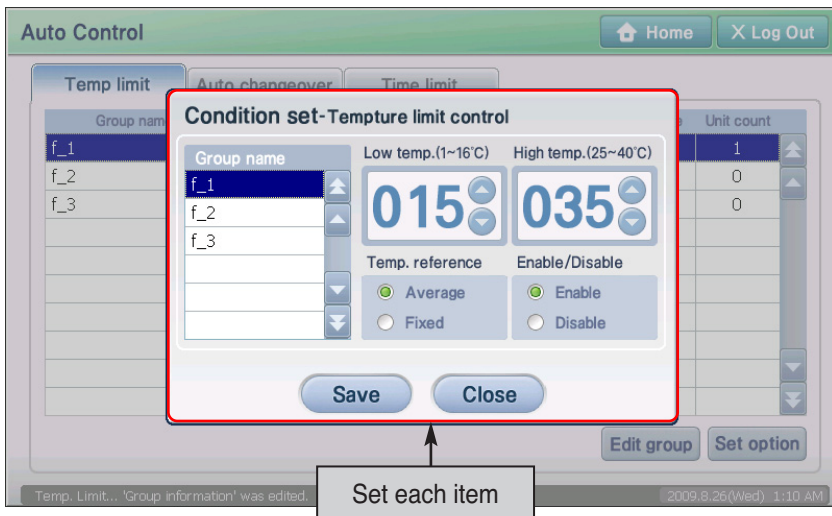

Item	Description
Group name	Name of temperature limit operation group is displayed.
Low Temp.	This sets the minimum to execute the temperature limit operation. The temperature range that can be set is 1°C~16°C.
High Temp.	This sets the maximum temperature to execute the temperature limit operation. The temperature range that can be set is 25°C~40°C.
Temp. reference	Select the method to measure the indoor temperature. Indoor temperature can be measured in one of the three methods below. - Average: This is the method of operating the temperature limit function based on the average temperature detected for the indoor units within the group. - Fixed: This is the method of operating the temperature limit function based on the temperature detected from the first registered indoor unit within the group.
Enable Disable	This sets whether to execute the temperature limit operation function or not. - Enable: Executes the temperature limit operation function. - Disable : Does not execute the temperature limit operation function.

3. When you have completed all the setting, click on the [Save] button. The 'Information' screen to ask to save will be displayed. Click on the [Yes] button.

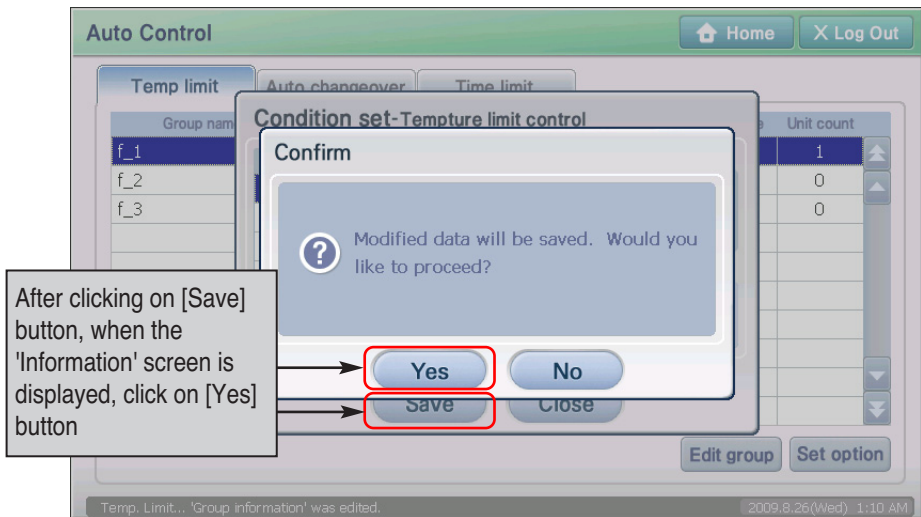

4. It is saved. When the setting is saved, the [Save] button will be deactivated and will be reactivated when the current information changes. Click on the [Close] button to move to the prior screen.

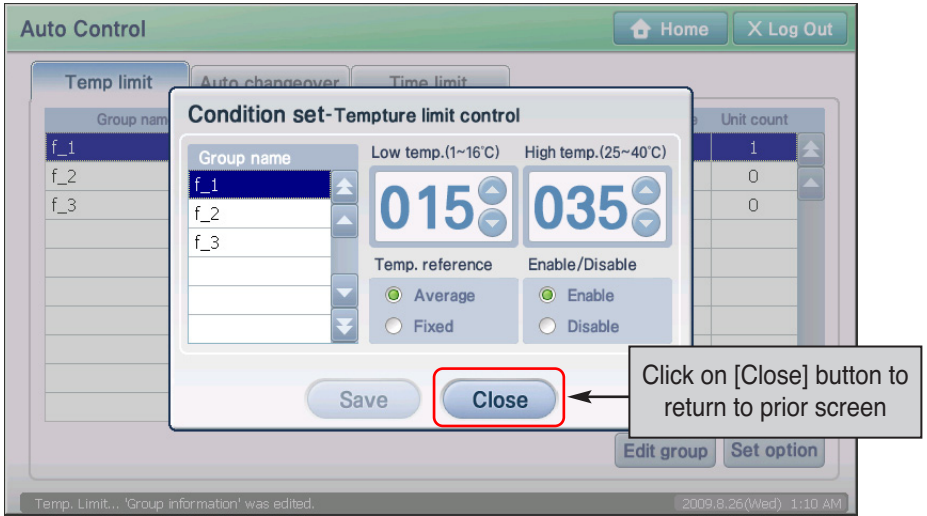

Auto change over operation (4-64)

Auto changer over operation is the function to maintain the optimal indoor temperature without any manual control through automatic change over of operating mode (Cool, heat) of the air conditioner. For example, when number of people increase to suddenly raise the indoor temperature during heating operation, AC Smart automatically changes from heat to cool mode to operate the indoor unit of the air conditioner to maintain the indoor temperature at a certain range.

The user enters the temperature difference from the reference temperature. AC Smart operates based on the input value as follows.

- When the indoor temperature exceeds the temperature difference from the reference temperature, it runs the cool operation to lower the indoor temperature.
- When the indoor temperature drops below the temperature difference from the reference temperature, it runs the heat operation to raise the indoor temperature

But when the temperature deviates from the indoor temperature range by the control/monitoring or schedule etc., the temperature is not controlled by this function.

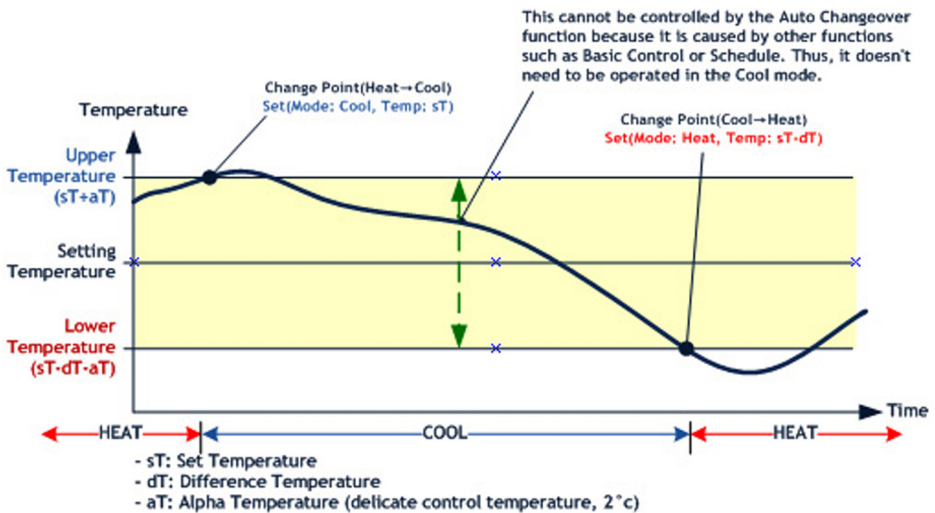

When the setting or temperature criteria is changed while the auto change over function is in operation, the changed setting will be reflected at the time the operating mode (Heat, cool) mode changes.

When you press the auto changer over operation tab from the auto control menu, the following screen to set the auto change over operation will be displayed.

The group that has been set up for the auto changer over operation and the details of the setting are displayed in table format.

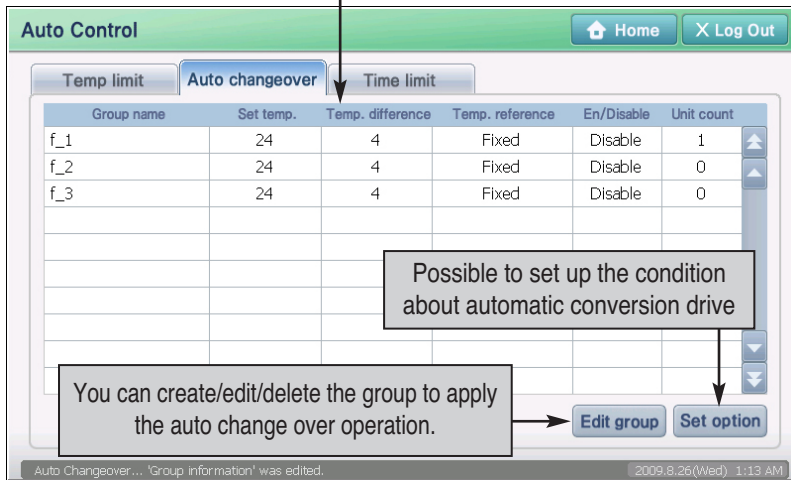

Refer to the following table for descriptions on the setting of auto change over operation.

Item	Description
Group name	Name of Auto change over operation group is displayed.
Set temperature	Set temperature(St) of Auto change over operation group is displayed.
Temperature difference	Temperature difference(dT) to maintain the temperature through heat and cool based on the temperature difference is displayed.
Temperature reference	Method to measure the temperature difference is displayed. - Fixed: Method of operating the Auto change over operation function based on the temperature detected by applicable indoor unit by designating the representative indoor unit to operate based on the set temperature within the group. - Operating: Method of operating the Auto change over operation function based on the temperature detected by applicable indoor unit by designating the representative indoor unit to operate based on the set temperature within the group. - Average: Method of operating the Auto change over operation function with the average temperature detected from the indoor units within the group.
En/Disable	Whether Auto change over operation function is applied is displayed.
Unit count	Number of units included in each group is displayed.

Setting auto change over operation (4-79)

To set the auto change over function, proceed in the following order.

1. When you press the 'Auto change over operation' tab from the 'Auto control' menu, the following screen will be displayed. To set the auto change over operation, press the [Condition setting] button.

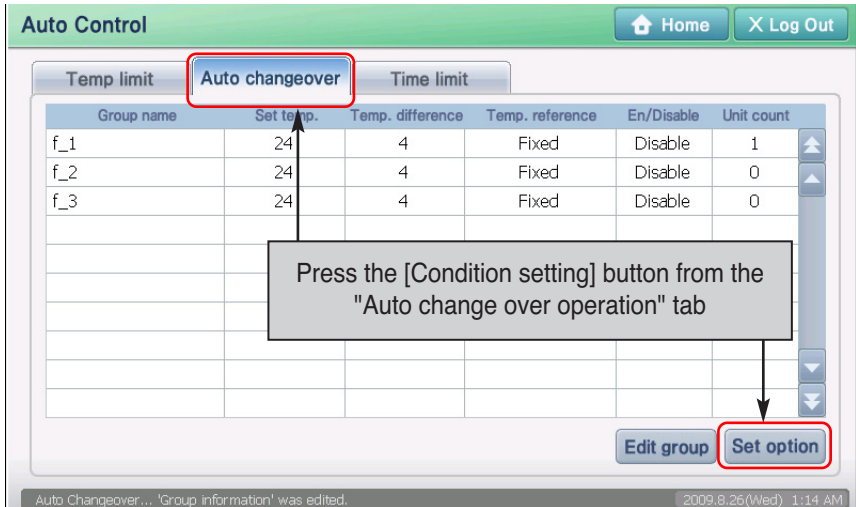

2. The 'Condition setting' screen is displayed. Select the temperature limit operation group to set the function and set each item. Refer to the following table for detailed description of each setting item.

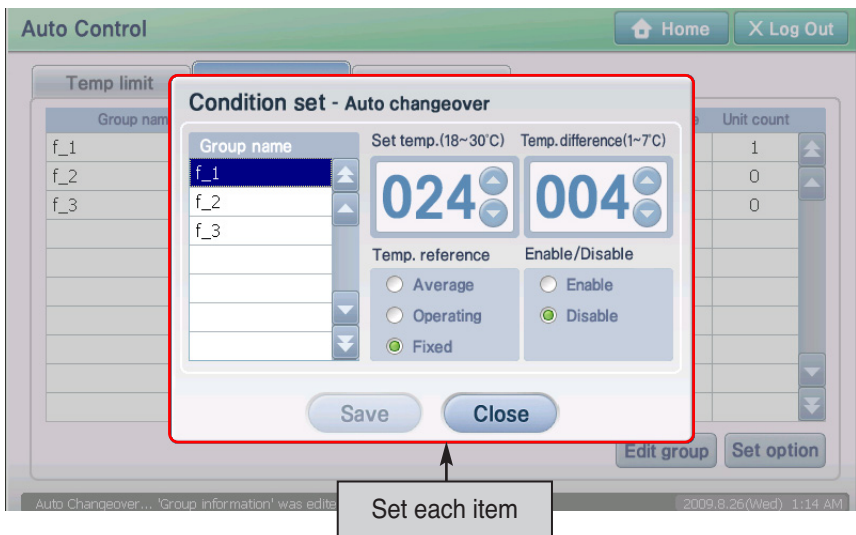

Item	Description
Group name	Select the group to apply the auto change over operation.
Set temp.	This sets the reference temperature to execute auto change over operation. The temperature range that can be set is 18°C ~30°C.
Temp. difference	Set the temperature difference so that the auto change over function can operate. When the difference between the reference and indoor temperature exceeds this temperature, it automatically cha
Temp. reference	Select the method to measure the indoor temperature. Indoor temperature can be measured in one of the three methods below. - Average: This is the method of operating the auto change over function based on the average temperature detected for the indoor units within the group. - Operating: This is the method of operating the auto change over function based on the average temperature of the operating indoor units within the group. - Fixed: This is the method of operating the auto change over function based on the temperature detected from the first registered indoor unit within the group.
Enable/Disable	This sets whether to execute the auto change over operation function or not. - Enable: Executes the auto change over operation function. - Disable: Does not execute the auto change over operation function..

3. When you have completed all the setting, click on the [Save] button. The 'Information' screen to ask to save will be displayed. Click on the [Yes] button. 4-81

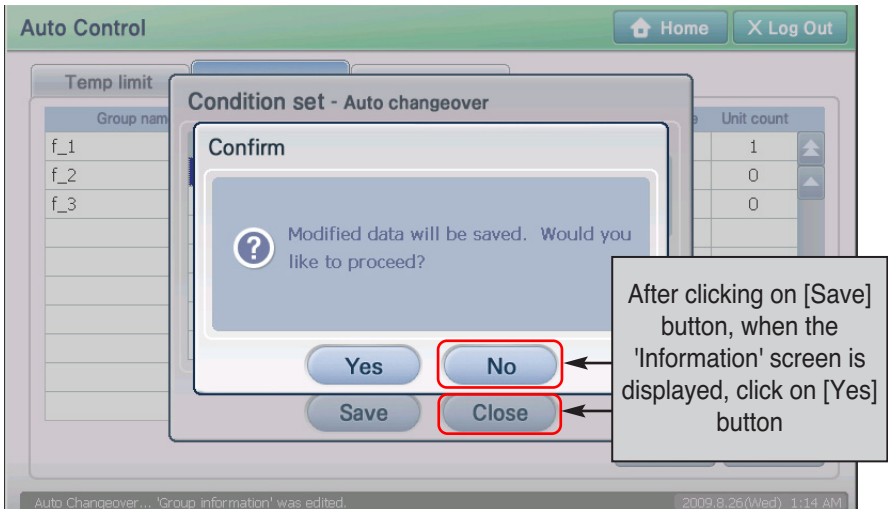

4. It is saved. When the setting is saved, the [Save] button will be deactivated and will be reactivated when the current information changes. Click on the [Close] button to move to the prior screen.

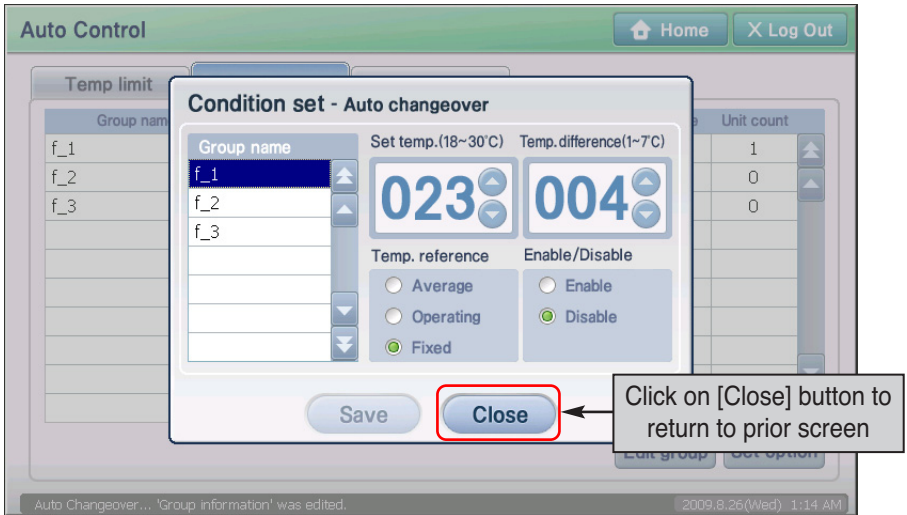

Time-limited running(4-65)

The time-limited running automatically stops the operation of the unit after the specified time. The time-limited running can reduce the waste of energy by limiting the individually used time of the unit within a specific time when the administrator is absent.

In order to set the time-limited running, specify the time and the weekday to operate. The operation time can be set to 1~4 hours (4 as default) and can be set to any weekday. Set whether to operate the time-limited running based on 0 o'clock.

The following figure shows the example for the operation of the time-limited running. The time-limited running is set to stop the unit by 4 hours on Tuesday and Wednesday from Monday to Thursday.

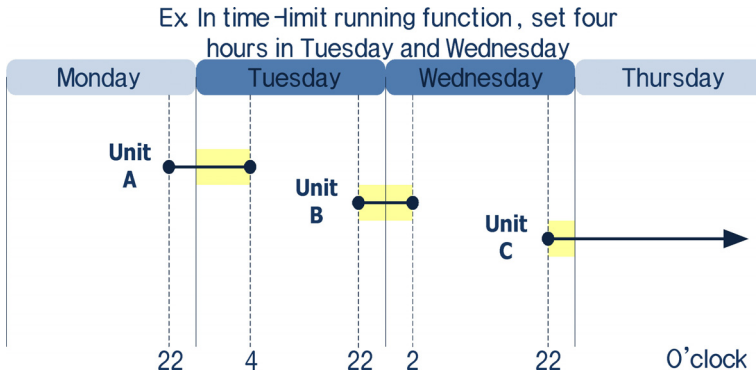

- The Unit A operates from 22:00 on Monday before applying the time-limited running. The time limited operation is applied to run the Unit A on Tuesday and to stop at 4:00 after 4 hours.
- The Unit B operates from 22:00 on Tuesday while the time-limited running is applied. Because the time-limited running is also set to Wednesday, the Unit B stops at 2:00 on Wednesday.
- The Unit C operates from 22:00 on Wednesday while the time-limited running is applied. But, the Unit C continues to operate with no time limit because the time-limited running is not applied on Thursday.

Reference: Function operation priority

When several functions of AC SMART II are operating simultaneously, it will operate in the following priority.

- 1) Emergency stop → 2) Temperature limit operation → 3) Schedule → 4) Auto change over operation → 5) Basic control (Control/Monitoring) → 6) Time limit operation

When you press the time limit operation tab from the auto control menu, the following screen to check the setting of the time limit operation will be displayed.

The group and unit that have been set up for the time limited operation and the details of the setting are displayed in table format.

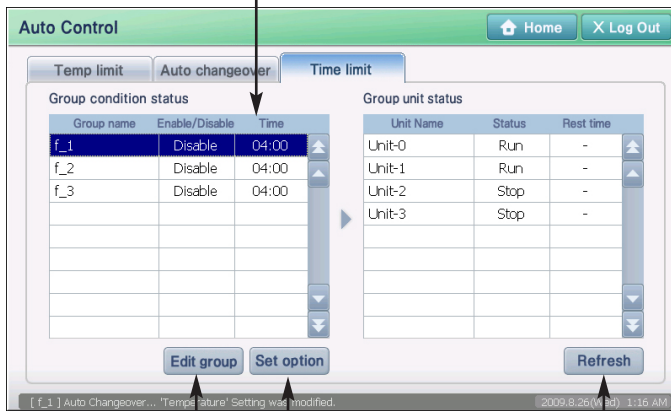

You can create/edit/delete the group to apply the time limited operation.

You can set the condition for the time limited operation.

The time of which the group and unit set for time limited operation operate is refreshed to the latest information.

The group setting status displays the set information of the time-limited running by group. The information displayed at the group setting status is as follows:

Item	Description
Group name	Name of time-limited running group.
En/Disable	Whether the time-limited running is used or not for the said group.
Time	Limited running time specified for the said group.

The unit status within group shows the status information of each unit included at the group selected at the group setting status. The information displayed at the unit status within group is as follows: (3-53)

Item	Description
Unit name	Name of each unit within the time-limited running group
Status	Whether the time-limited running of the current unit is operated or not.
Rest time	Remaining time until the operation of the said unit stops.

Setting the time-limited running (4-92)

Keep the following order to set the time-limited running function.

1. When you press the 'Time limit operation' tab from the 'Auto control' menu, the following screen will be displayed. To set the time limit operation, press the [Condition setting] button.

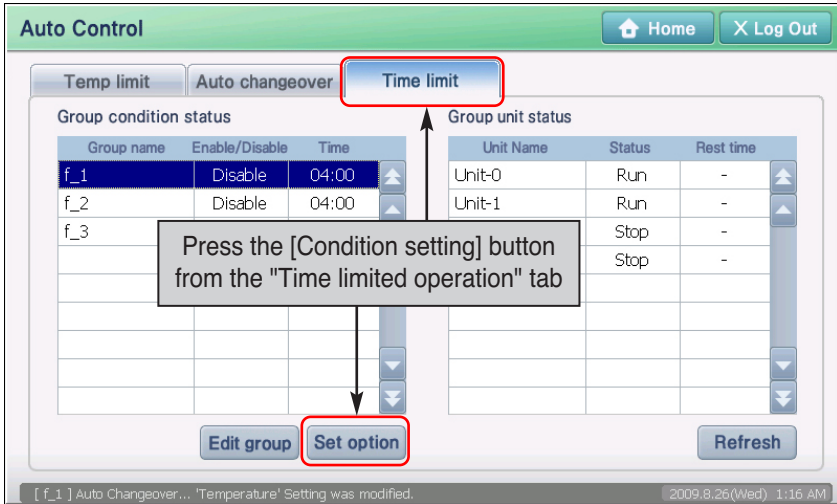

2. 'Condition setting' screen is displayed. Select the temperature limit operation group to set the function and set each item. Refer to the following table for detailed description of each setting item.

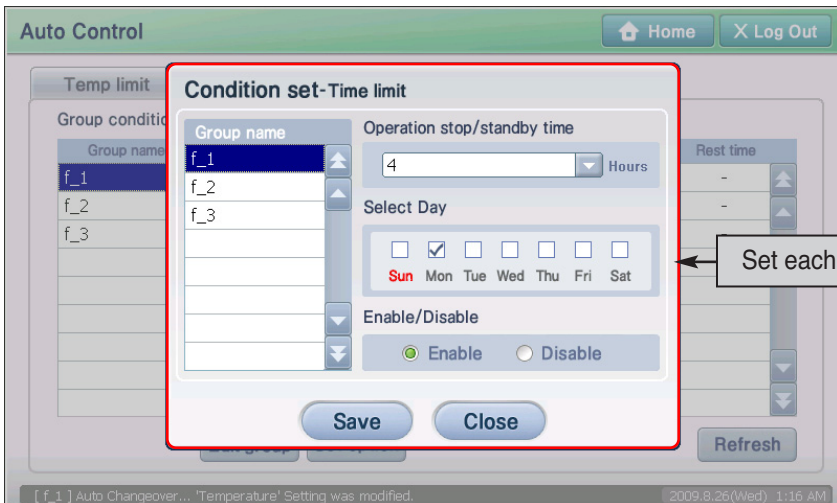

Item	Description
Group name	Select the group to apply the time limit operation.
Operation Stop/standby time	Set the time (1~4 hours) to limit the running of the time-limited running group. The time-limited running group is run for the set time and then automatically ended.
Select Day	Select the weekday to perform the time-limited running. It can be set from Monday to Sunday, and more than one weekday can be selected.
Enable/Disable	Set whether to perform the time-limited running or not. - Apply: Perform the time-limited running. - No apply: The time-limited running is not performed.

3. When finishing all settings, press [Save] button. 'Information' screen to conform saving is displayed. Press [Yes] button.

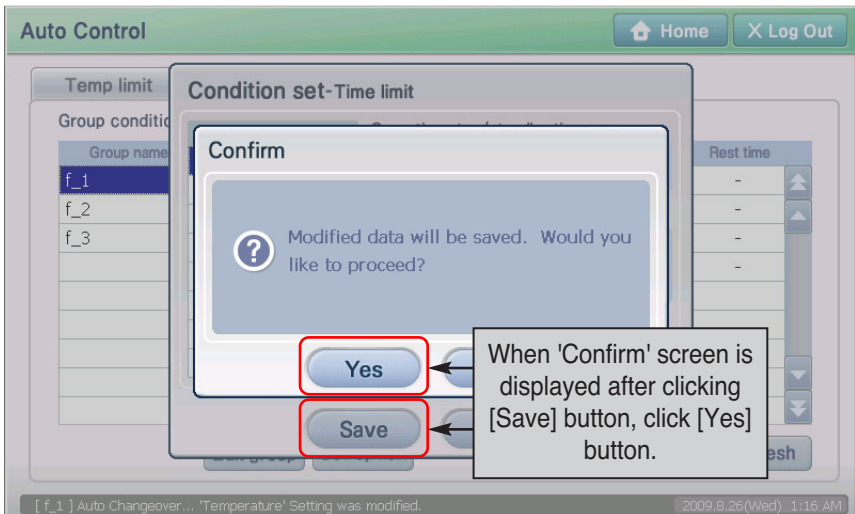

4. Saving is finished. When saving is finished, [Save] button is deactivated, and when the current information is changed, it is activated again. Click [Close] button to return to the previous screen.

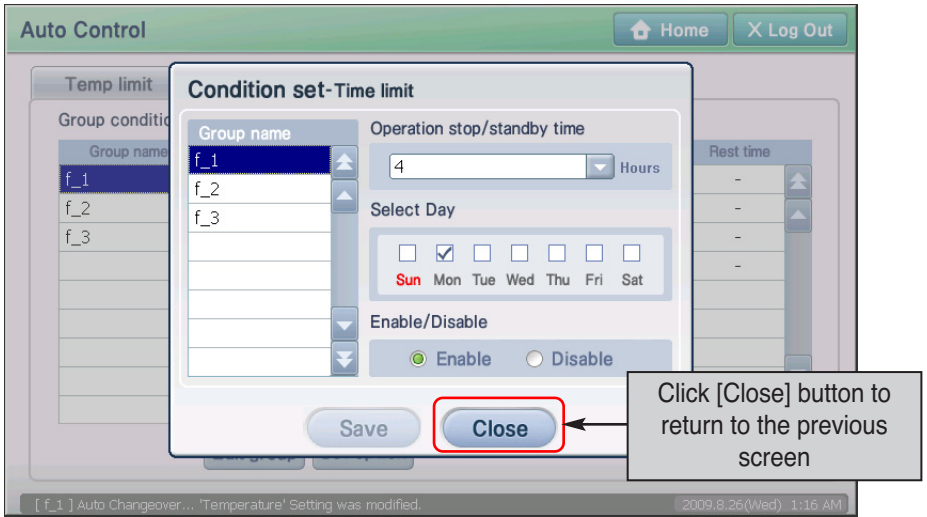

7. History menu

AC SMART II records the information when there is any change in setting or unit condition. In the history menu, you can classify and check the history by the period or the type of event. History menu can save maximum of 3000 events for 1 month.

When you select the history menu, the following screen will be displayed.

Time, unit and event of the history is displayed in table format in order with the latest showing first.

No.	Date	Time	Code	Name	Message
1	2009-08-25	21:30:58	M	Unit-0	Basic Control... Unit was controlled.
2	2009-08-25	21:28:46	M	Unit-0	Basic Control... Unit was controlled.
3	2009-08-25	21:26:15	M	-	System... Unit information is saved successf...
4	2009-08-25	21:26:15	E	Unit-0	[242] Unit error has been resolved.
5	2009-08-25	21:22:09	M	-	Login... Service Login.
6	2009-08-25	18:50:14	M	-	Time Limit... 'Group information' was edited.
7	2009-08-25	18:47:39	M	-	Time Limit... 'Group information' was edited.
8	2009-08-25	18:47:09	M	-	Time Limit... 'Group information' was edited.
9	2009-08-25	18:39:18	M	-	Login... Service Login.
10	2009-08-25	17:43:49	E	Unit-1	[10] Unit error occurred.
11	2009-08-25	17:43:20	E	Unit-1	[242] Unit error occurred.

[f.1] Time Limit... 'Apply Week' Setting was modified. 2009.8.25(Wed) 1:19 AM

You can classify/view according to the period or type of history

You can refresh/view the history with the latest information.

The type of information shown on screen is as follows.(3-41)

Item	Description
No.	Order of the event of change in setting or unit condition.
Date	Date of the event for the setting or control condition change is displayed
Time	Time of the event is displayed.
Code	Code number classified by history characteristic is displayed.
Name	Name of unit with event is displayed.
Message	Detail content of the event is displayed

Browsing specific history (4-56)

You can classify the history information displayed on the history screen by setting and type. To classify and browse the history information by time and type, proceed in the following order.

1. Click on the [Condition setting] button. 'Record search condition' to classify and search the event by history code and period is displayed.

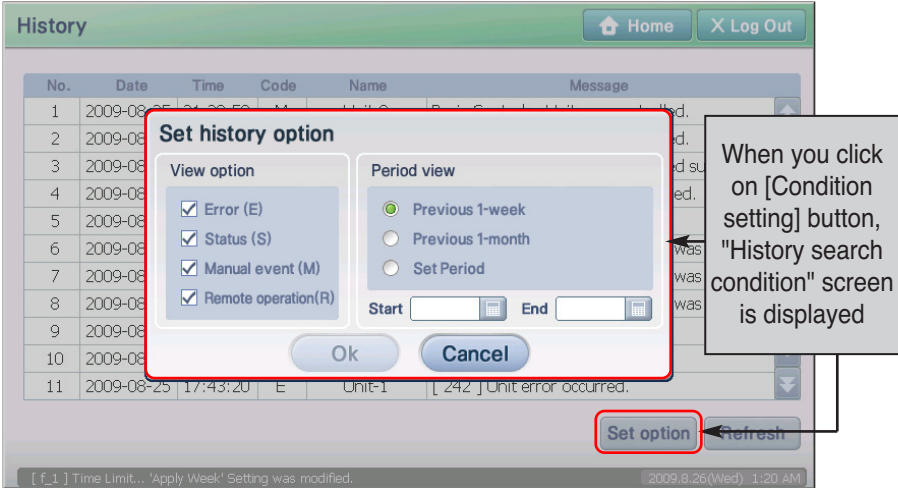

2. Designate the history code or history period and click on the [Apply] button. For detailed description of the setting item, refer to the following chart.

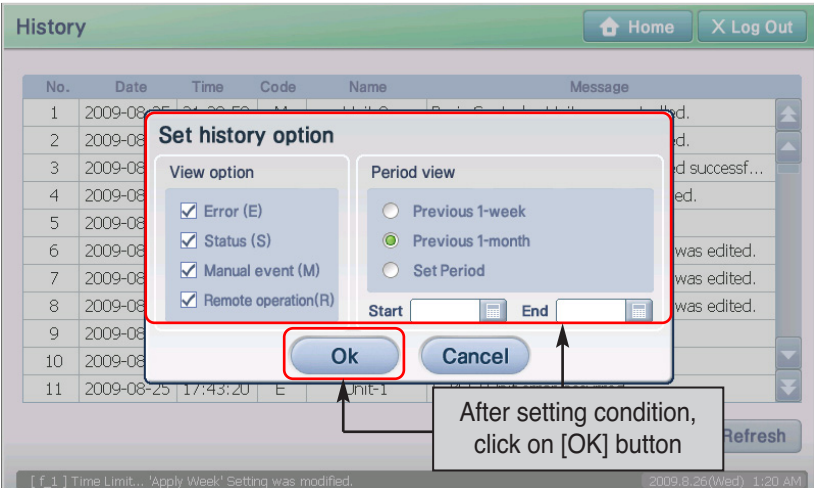

Item	Description
View option	<p>Error : This sets the history list to display the event related to error.</p> <p>Condition : This sets the history list to display the event related to condition change.</p> <p>Manual event : This sets the history list to display the event directly set by the user with the remote controller etc.</p> <p>Remote operation : This sets the history list to display the event set by the user accessing remotely.</p>
Period view	<p>Previous 1-week : This sets the history list to display the event that occurred one week back from the current time.</p> <p>Previous 1-month : This sets the history list to display the event that occurred one month back from the current time.</p> <p>Set Period: This displays the event that occurred only in the specific period. Designate the period by pressing the calendar picture displayed in start and end date.</p> <ul style="list-style-type: none"> - Start date: Designate the start date of the period. - End date: Designate the end date of the period.

3. History information that fits the set condition is displayed in the list.

The screenshot shows a 'History' window with a table of events. The table has columns for No., Date, Time, Code, Name, and Message. The events listed are:

No.	Date	Time	Code	Name	Message
1	2009-08-26	00:17:43	M	f_1	Time Limit... 'Apply Week' Setting was modi...
2	2009-08-26	00:17:43	M	f_1	Time Limit... Set to 'Enable'.
3	2009-08-26	00:15:25	M	f_1	Auto Changeover... 'Temperature' Setting w...
4	2009-08-26	00:12:48	M	-	Auto Changeover... 'Group information' was...
5	2009-08-26	00:12:30	M	-	Auto Changeover... 'Group information' was...
6	2009-08-26	00:11:24	M	f_1	Temp. Limit... 'Temp. Standard' was modified.
7	2009-08-26	00:11:24	M	f_1	Temp. Limit... 'Lowest Limit' Setting was mo...
8	2009-08-26	00:11:24	M	f_1	Temp. Limit... 'Highest Limit' Setting was m...
9	2009-08-26	00:11:24	M	f_1	Temp. Limit... Set to 'Enable'.
10	2009-08-26	00:09:31	M	-	Temp. Limit... 'Group information' was edited.
11	2009-08-26	00:08:42	M	-	Temp. Limit... 'Group information' was edited.

At the bottom of the window, there are buttons for 'Set option' and 'Refresh'. A callout box with an arrow pointing to the table says: "Press [Schedule pattern wizard] button".

Information: Refreshing with latest information

While the history information is displayed in the history screen, the setting information and changes can occur. This information is not immediately reflected to the history screen currently displayed. To view the latest history information, click on the [Refresh] button. The history displayed on the screen is refreshed to the latest information.

The screenshot shows a 'History' screen with a green header bar containing 'Home' and 'Log Out' buttons. Below the header is a table with columns: No., Date, Time, Code, Name, and Message. The table contains 11 rows of data. At the bottom right of the table area, there are two buttons: 'Set option' and 'Refresh'. The 'Refresh' button is highlighted with a red box. Below the table, there is a status bar with text: '[f_1] Time Limit... 'Apply Week' Setting was modified.' and '2009.8.26(Wed) 11:21 AM'.

No.	Date	Time	Code	Name	Message
1	2009-08-26	00:17:43	M	f_1	Time Limit... 'Apply Week' Setting was modi...
2	2009-08-26	00:17:43	M	f_1	Time Limit... Set to 'Enable'.
3	2009-08-26	00:15:25	M	f_1	Auto Changeover... 'Temperature' Setting w...
4	2009-08-26	00:12:48	M	-	over... 'Group information' was edited.
5	2009-08-26	00:12:30	M	-	Auto Changeover... 'Group information' was...
6	2009-08-26	00:11:24	M	f_1	Temp. Limit... 'Temp. Standard' was modified.
7	2009-08-26	00:11:24	M	f_1	Temp. Limit... 'Lowest Limit' Setting was mo...
8	2009-08-26	00:11:24	M	f_1	Temp. Limit... 'Highest Limit' Setting was m...
9	2009-08-26	00:11:24	M	f_1	Temp. Limit... Set to 'Enable'.
10	2009-08-26	00:09:31	M	-	Temp. Limit... 'Group information' was edited.
11	2009-08-26	00:08:42	M	-	Temp. Limit... 'Group information' was edited.

Click on [Refresh] button

Statistical menu

With AC SMART II, you can search the operating time of the indoor unit by Zone, Group and Unit. You can search the operating time of the indoor unit for specific period of on a monthly basis.

When you select the statistic menu, the following screen will be displayed.

You can view the operating time and statistical value of the indoor unit during a specific period.

You can view the monthly operating time in 3 months, 6 months and 1 year from a specific time

Statistics Home Log Out

Accumulative operation time

Monthly operation time

Period ~ Set option
Initialize Save Refresh

No.	Unit Name	Total runtime	Period statistic		
			Runtime	Percentage(%)	Avg room temp.

[f_1] Time Limit... 'Apply Week' Setting was modified.
2009.8.26(Wed) 1:22 AM

Reference: Statistical information

The statistical function provides the operating time of the indoor unit. This does not provide operating time information for ventilator, On/Off unit nor AWHP unit.

Accumulative operating time

Accumulative operating time is the function that calculates the operating time of the indoor unit for a specific period selected by the user.

When you press the accumulative operating time tab, the following screen will be displayed.

You can save the accumulative operating time as a file.

The accumulative operating time information is refreshed with the latest information for viewing.

You can reset the accumulative operating time information.

You can set the search condition and target of the accumulative operating time.

You can set the period to search the accumulative operating time of the indoor unit.

You can view the total operating time and statistical information of the indoor unit within the search period.

No.	Unit Name	Total runtime	Runtime	Period statistic	
				Percentage(%)	Avg room temp.
1	Unit-0	0	00:00	0	0
2	Unit-0	0	00:00	0	0
3	Unit-0	0	00:00	0	0
4	Unit-0	0	00:15	100	-20
5	Unit-0	0	00:00	0	0
6	Unit-2	0	00:00	0	0

* [Reset] button is only activated when logged in as installation expert.

The following information of accumulative time operation is displayed in table format.

Item	Description
Unit name	Name of target to search the accumulative operating time is displayed. This is displayed in applicable Zone, Group or Indoor unit according to the condition setting.
Total operating time	Total operating time of the target set for the period is displayed.
Statistics by period	<p>Indoor unit operating time, percentage and average indoor temperature for the set period will be displayed.</p> <ul style="list-style-type: none"> • Operating time: Indoor unit operating time for the set period is displayed. • Percentage: Operating time percentage of each unit/group/zone set during the period. The sum of the percentage of unit/group/zone must be 100%. • Average indoor temperature: Average indoor temperature detected from the indoor unit in the set period is displayed.

Searching accumulative operating time

You can check the accumulative operating time of the indoor unit during the specific period. To check the accumulative operating time, proceed as follows.

1. Press the 'Accumulative operating time' tab from the statistical menu and set the period to search the accumulative operating time from the 'Period' item. Press the  button to select the dates. And then press the [Refresh] button.

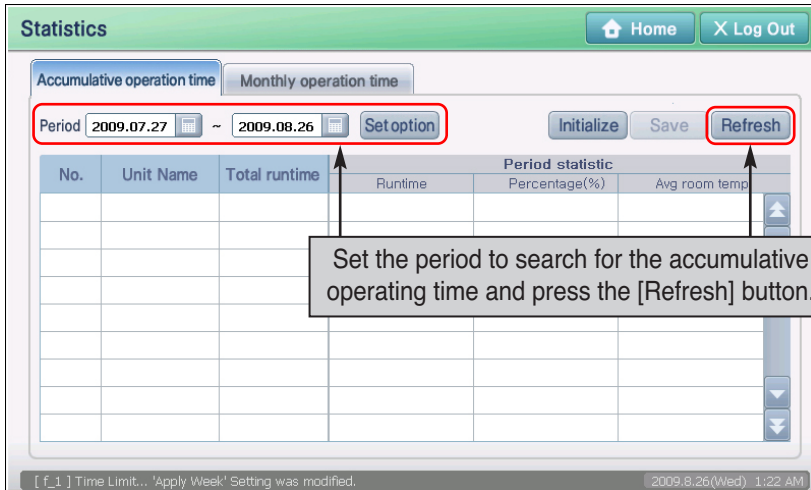

Statistics

Home Log Out

Accumulative operation time Monthly operation time

Period 2009.07.27 ~ 2009.08.26 Set option Initialize Save Refresh

No.	Unit Name	Total runtime	Period statistic		
			Runtime	Percentage(%)	Avg room temp.

[f_1] Time Limit... 'Apply Week' Setting was modified. 2009.8.26(Wed) 1:22 AM

2. The following information about the accumulative operating time is displayed.

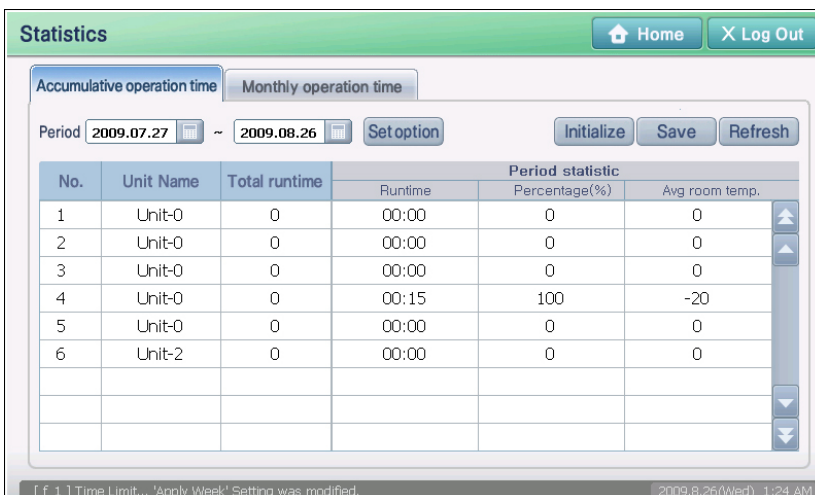

Statistics

Home Log Out

Accumulative operation time Monthly operation time

Period 2009.07.27 ~ 2009.08.26 Set option Initialize Save Refresh

No.	Unit Name	Total runtime	Period statistic		
			Runtime	Percentage(%)	Avg room temp.
1	Unit-0	0	00:00	0	0
2	Unit-0	0	00:00	0	0
3	Unit-0	0	00:00	0	0
4	Unit-0	0	00:15	100	-20
5	Unit-0	0	00:00	0	0
6	Unit-2	0	00:00	0	0

[f_1] Time Limit... 'Apply Week' Setting was modified. 2009.8.26(Wed) 1:24 AM

Monthly operating time

Monthly operating time calculates and provides the monthly operating time of the indoor unit for a specific period (3 months, 6 months, 1 year) from a specific month the user selects.

When you press the monthly operating time tab, the following screen will be displayed.

The screenshot shows the 'Statistics' screen with the following elements:

- Buttons:** Home, Log Out, Accumulative operation time, Monthly operation time, Period (calendar icon), Set option, Initialize, Save, Refresh.
- Form:** Period: 2009.06 to [radio 3-Months] [radio 6-Months] [radio 1-Year]
- Table:**

No.	Unit Name	Total	2009.06
0		00:00	
0		00:00	
0		00:00	
0		00:15	
0		00:00	
0		00:00	
- Callout Boxes:**
 - "You can save the monthly operating time information as a file." (points to Save)
 - "You can reset the monthly operating time information." (points to Initialize)
 - "You can set the search condition and target of the monthly operating time." (points to Set option)
 - "You can refresh/view the monthly operating time information with the latest information." (points to Refresh)
 - "You can refresh/view the monthly operating time information with the latest information." (points to Refresh)
 - "You can set the search condition and target of the monthly operating time." (points to Set option)
 - "You can view the total operating time and monthly operating time of the indoor unit within the search period." (points to the table)

* [Reset] button is only activated when logged in as installation expert.

The following information of accumulative time operation is displayed in table format.

Item	Description
Unit name	Name of target to search the accumulative operating time is displayed. This is displayed in applicable Zone, Group or Indoor unit according to the condition setting.
Total	Total operating time the target unit operated for the set period is displayed.
Monthly total	The operating time is displayed in month units for the set period according to the condition setting.

Searching monthly operating time

You can check the operating time of the indoor unit from a specific month for the set period based on the month level unit.

1. Press the 'Monthly operating time' tab from the statistical menu and set the month to set as basis to search the monthly operating time from 'Period' item.
When you press the  button, you can select the year and month, and the period to search the operating time (3 months, 6 months, 1 year) and then press the [Refresh] button.

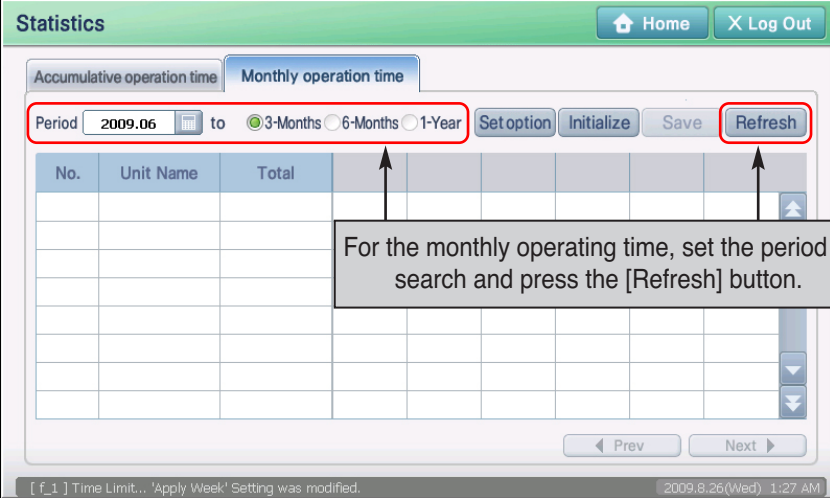

Statistics Home Log Out

Accumulative operation time **Monthly operation time**

Period 2009.06  to 3-Months 6-Months 1-Year Set option Initialize Save Refresh

No.	Unit Name	Total					

[f_1] Time Limit... 'Apply Week' Setting was modified. 2009.8.26(Wed) 1:27 AM

2. The following information for monthly operating time is displayed on the screen.

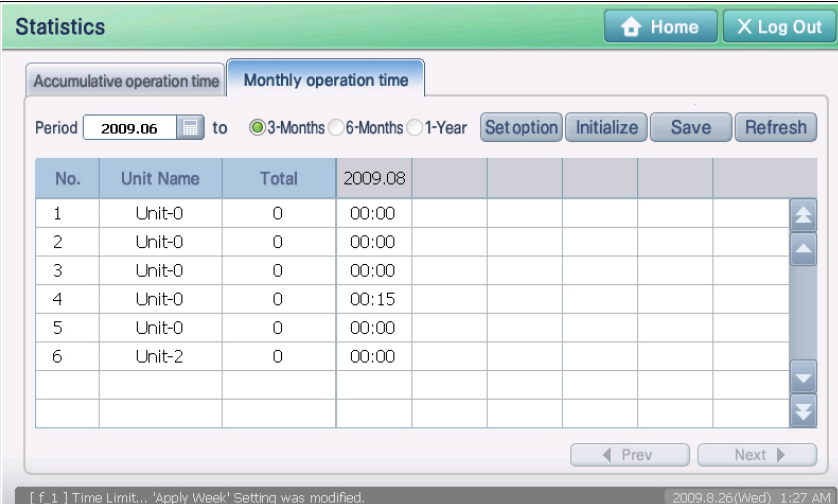

Statistics Home Log Out

Accumulative operation time **Monthly operation time**

Period 2009.06  to 3-Months 6-Months 1-Year Set option Initialize Save Refresh

No.	Unit Name	Total	2009.08				
1	Unit-0	0	00:00				
2	Unit-0	0	00:00				
3	Unit-0	0	00:00				
4	Unit-0	0	00:15				
5	Unit-0	0	00:00				
6	Unit-2	0	00:00				

[f_1] Time Limit... 'Apply Week' Setting was modified. 2009.8.26(Wed) 1:27 AM

Setting the operating time search condition

You can set the search condition for the accumulative operating time and monthly operating time. To set the search condition, proceed as follows. Accumulative operating time is used as an example. You can also set the search condition for the monthly operating time in the same way.

1. Press the [Condition setting] button located at the 'Accumulative operating time' tab. 'Condition setting' screen to set the search unit and target is displayed.

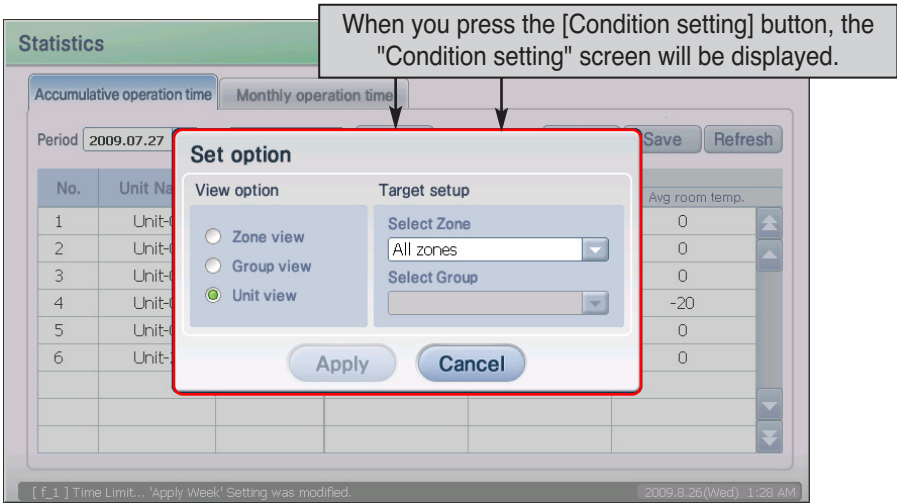

3. Set the search unit and target, and press the [Apply] button. Refer to the following table for detailed description of the setting item.

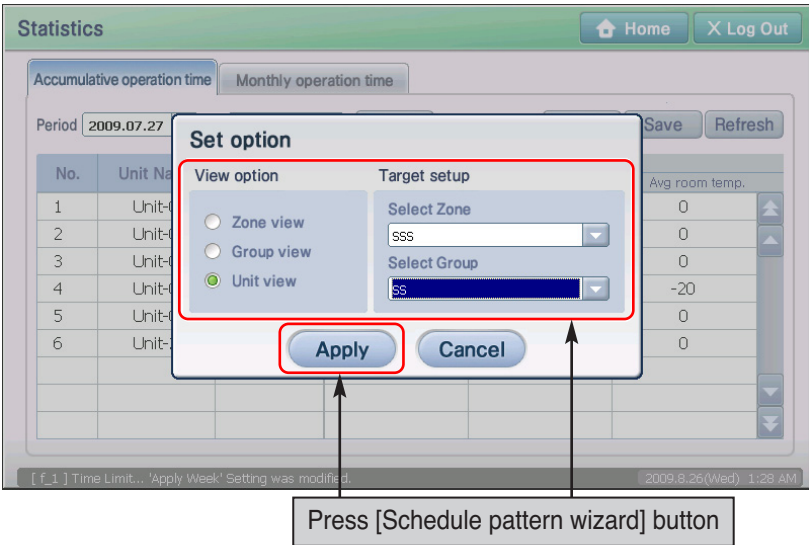

Type	Item	Description
View setting	View by Zone	Set the usage information to show by Zone.
	View by Group	Set the usage information to show by Group.
	View by Unit	Set the usage information to show by Unit.
Target setting	Zone selection	Set the Zone to show the usage information.
	Group selection	Set the Group within the Zone to show the usage information.

3. Message to confirm to save the changed information is displayed. Press the [Yes] button.

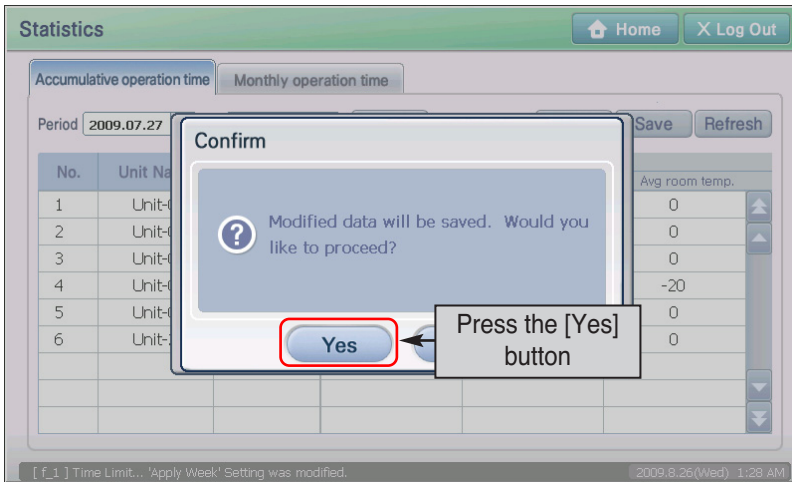

4. Accumulative operating time information is shown on the screen according to the set condition.

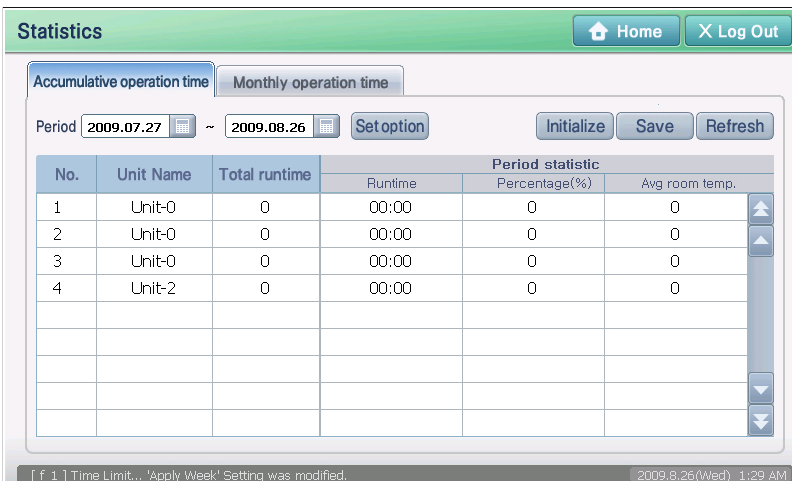

Saving operating time file

You can save the accumulative operating time information and monthly operating time information that you have searched to an Excel file on the USB memory. To save the result to a file, proceed as follows. Monthly operating time is used as an example. You can also save the accumulative operating time in the same way.

1. With the external USB memory connected to AC SMART II, search the monthly operating time. When the search result of the monthly operating time is shown on the screen, press the [Save file] button.

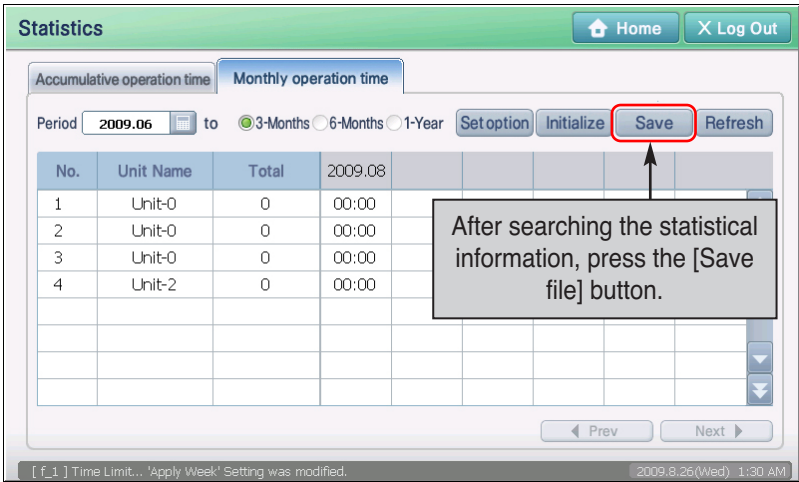

2. 'Save file as' screen is displayed. Enter the name of the Excel file to save and press the [OK] button.

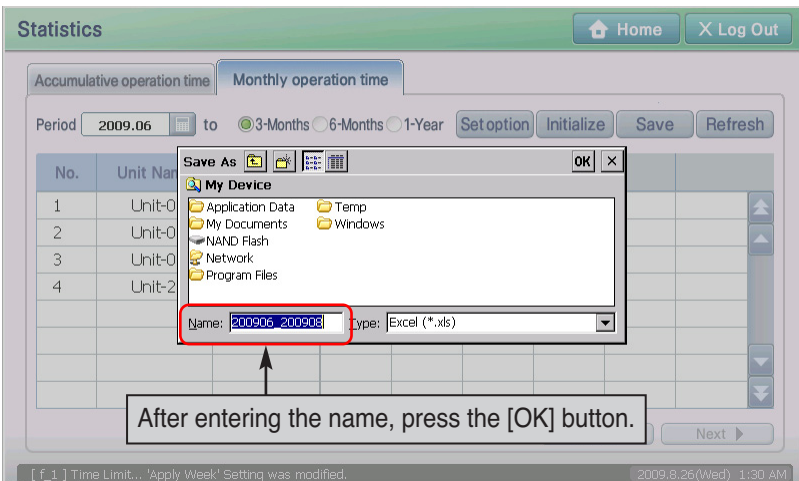

3. Message saying that the file is saved is displayed. Press the [OK] button to complete the process. And then you can remove the USB memory from AC SMART II.

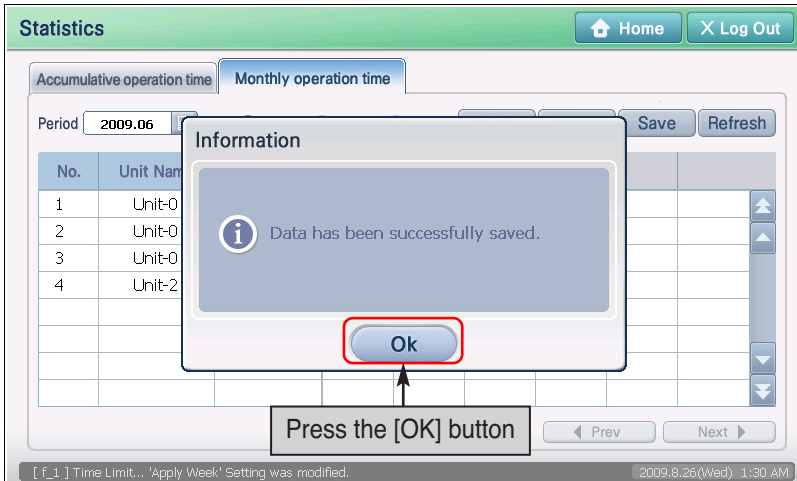

Information: Delete all schedule

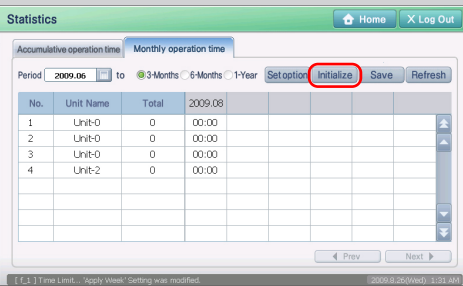

When AC SMART II is installed for the first time or when there is an error, the statistical information may not be displayed correctly. In this case press the [Reset] button to reset the previous statistical information.

The [Reset] button is only activated when logged on as installation specialist authority.

Information: Refreshing to latest statistical information

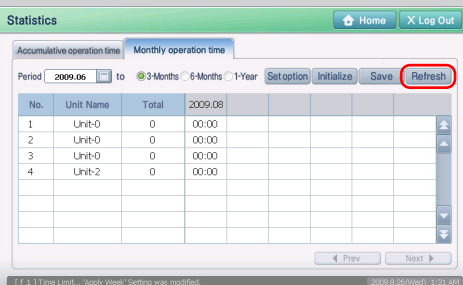

While the statistical information is displayed on the statistical menu, the units connected to AC SMART II are still operating. And the statistical information on the screen is not updated in real time.

To view the latest statistical information, press the [Refresh] button located at the right side of the accumulative and monthly operating time.

The statistical information shown on the screen will be refreshed to the latest information.

8. System

You can conveniently manage the indoor units and ventilators connected to the network with AC Smart in zone and group depending on the installed location or function characteristic.

Setting menu provides the function to include or exclude indoor unit and ventilator from group or zone depending on the physical and logical structure.

The user and administrator operates AC SMART II from the 'Control/Monitoring' menu based on the configuration of Zone, Group and Unit set from the unit management menu.

The screenshot displays the 'System' management interface. It features a top navigation bar with 'Home' and 'Log Out' buttons. The main area is divided into three sections: a tree view on the left for 'Zone and Group configuration', a central table for 'Assigned Gr/Unit' showing 'Unit-0' through 'Unit-3', and a right-hand table for 'Unassigned Gr/Unit'. Below the tree view are 'Add', 'Rename', and 'Delete' buttons. Below the assigned units table are right and left arrow buttons. Below the unassigned units table is a 'Unit Reg.' button, with 'Save' and 'Rentre' buttons below it. A status bar at the bottom shows a time limit and a date/time stamp.

Zone and Group configuration is displayed in tree format.

Press the [] and [] button to register/cancel the Group or Unit.

Unregistered Group or Unit is displayed.

You can add/delete/rename the Zone or Group.

List of Groups registered in the Zone or Units registered in the Group is displayed.

You can register a new unit or edit/delete the information of the existing unit.

Reference: Function limit by login authority

[Unit registration] button is displayed only when logged on as installation specialist authority. Therefore the user and administrator cannot use this function.

Registering unit (4-106)

When first installing AC Smart, you must register the unit to connect to AC Smart.

When you press the [Unit registration] button located at the bottom of the unit management menu, the following 'Unit registration' screen will be displayed. Here you can register a new unit or edit/delete existing units. Also you can automatically register the unit through unit search.

This is the part where you enter the information to register/edit the indoor unit, ventilator, on/off unit and AWHP unit.

You can interface with other external central controller.

Unit Registration

Type	Name <small>(Max.20 characters) (up to 2 digits 00-FF)</small>	Address <small>(Max.20 characters) (up to 5 digits)</small>	Model	Capacity
AWHP	Unit-5	91	Default	N/A

Type	Unit Name	Address	Model	Capacity
IDU	Unit-0	10	Default	N/A
Vent	Unit-1	00	Default	N/A
On/Off De...	Unit-2	02	Default	N/A
AWHP	Unit-3	60	Default	N/A
AWHP	Unit-4	81	Default	N/A
AWHP	Unit-5	91	Default	N/A

Control link

Auto

Reg. Status

Add

Delete

Modify

The connected units can be automatically searched and registered.

Number of registered units is displayed by the type of connected units.

You can add a new unit or edit/delete the information of the existing unit.

List of currently registered units is displayed.

You can register the unit by automatically registering the unit or directly entering the unit information. This section describes both methods of registering the unit.

Reference: Login authority for unit registration

To register a unit in AC SMART II, you must log in as installation specialist authority. You cannot register the unit with administrator or user login authority.

Caution: Unit registration setting



This is the menu used by the installation specialist when installing AC SMART II. Be careful not to let the user reset the product by using this menu.

Registering new unit automatically

You can automatically search and register the unit connected to AC Smart. To automatically register the unit, proceed in the following order.

1. When you select 'Unit management' menu, the following screen will be displayed. Press the [Unit registration] button located at the bottom right side of the screen. will be displayed. To create a schedule pattern, press the [Schedule pattern wizard] button.

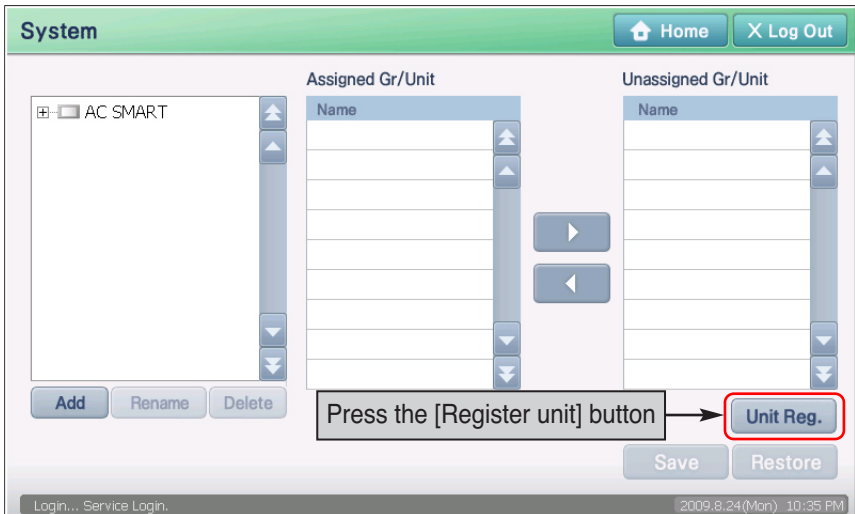

2. 'Edit unit' screen to register the unit will be displayed. Click on the [Auto setting]. When the 'Information' screen to check unit auto setting, click on the [Yes] button.

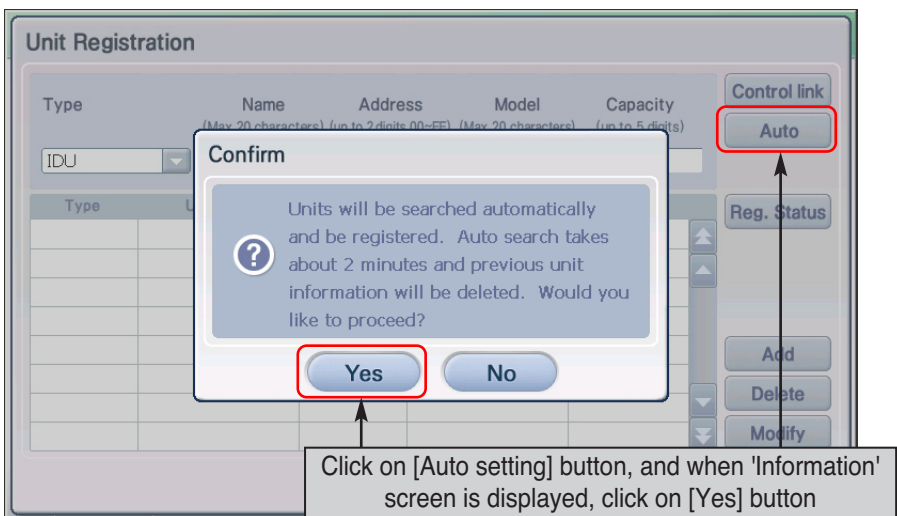

3. AC SMART II will search and register the units connected. When this process is completed, units automatically registered will be displayed in the table located below the screen.

The screenshot shows the 'Unit Registration' interface. At the top, there are input fields for 'Type' (IDU), 'Name' (Unit-0), 'Address' (10), 'Model' (Default), and 'Capacity' (N/A). Below these is a table with columns: Type, Unit Name, Address, Model, Capacity, and Reg. Status. A red box highlights a cell in the table containing a loading spinner and the text 'Waiting ... 28 %'. A callout box with an arrow points to this cell, containing the text: 'After the unit is searched, the result is displayed.' At the bottom of the screen are 'Ok' and 'Cancel' buttons.

4. Temporarily save the searched unit. When you press the [OK] button, the 'OK' screen to confirm to save will be displayed. Press the [Yes] button to save and return to the previous screen.

The screenshot shows the 'Unit Registration' interface with a 'Confirm' dialog box overlaid. The dialog box contains a question mark icon and the text: 'Modified data will be temporarily saved. Would you like to save it?'. Below the text are 'Yes' and 'No' buttons. A red box highlights the 'Yes' button. Below the dialog box, the 'Ok' and 'Cancel' buttons from the registration screen are visible, with a red box highlighting the 'Ok' button. A callout box on the left contains the text: 'Press the [OK] button to save and when the "OK" screen is displayed, press the [Yes] button.' with arrows pointing to the 'Ok' button and the 'Yes' button.

5. Lastly, you must register the unit setting that has been temporarily saved to the system. When you click on the [Save] button, an 'Information' screen to check whether to apply the current setting will be displayed. Click on the [Yes] button.

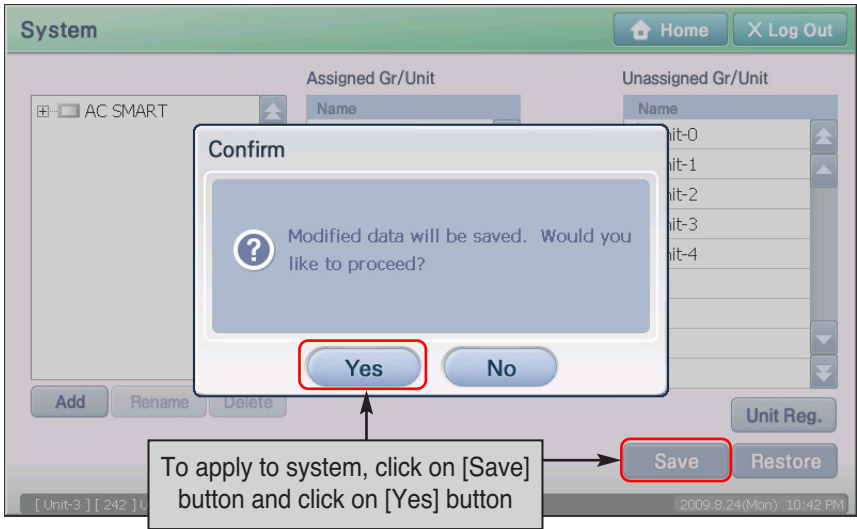

6. The setting to now will be applied to the system and you will see a message saying that you have completed saving the setting on the screen. Click on the [OK] button to complete the registration.

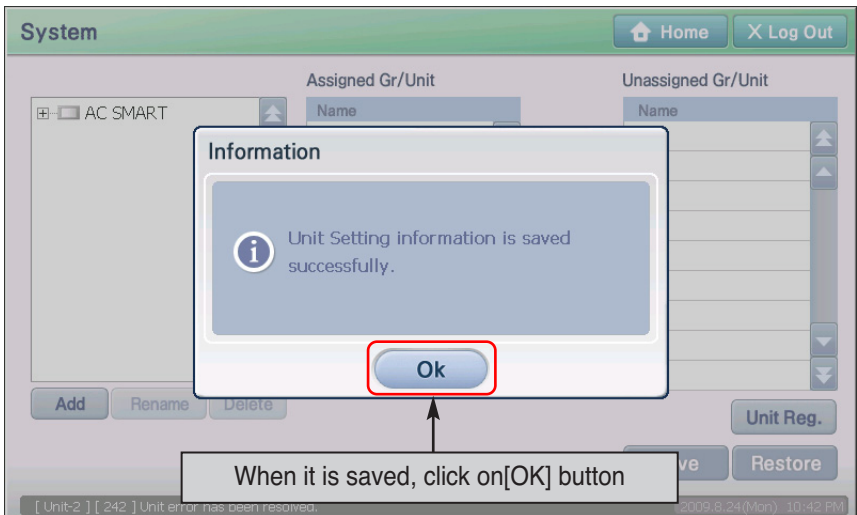

Directly registering new unit

The user can directly register the unit connected to AC Smart. To register the unit, proceed in the following order.

1. Press the [Register unit] button located at the bottom of the 'Unit management' menu.

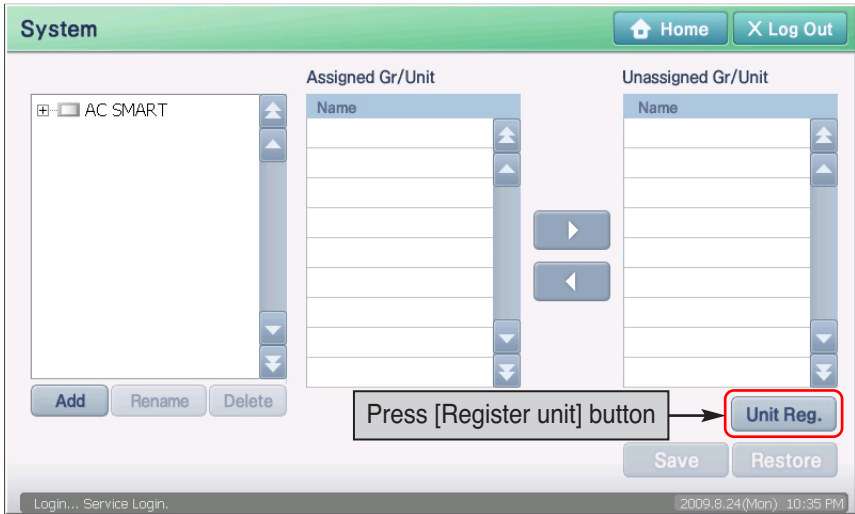

2. 'Edit unit' screen to register the unit is displayed. Enter the information of the unit and click on the [Add] button. Refer to the following chart for information to enter.

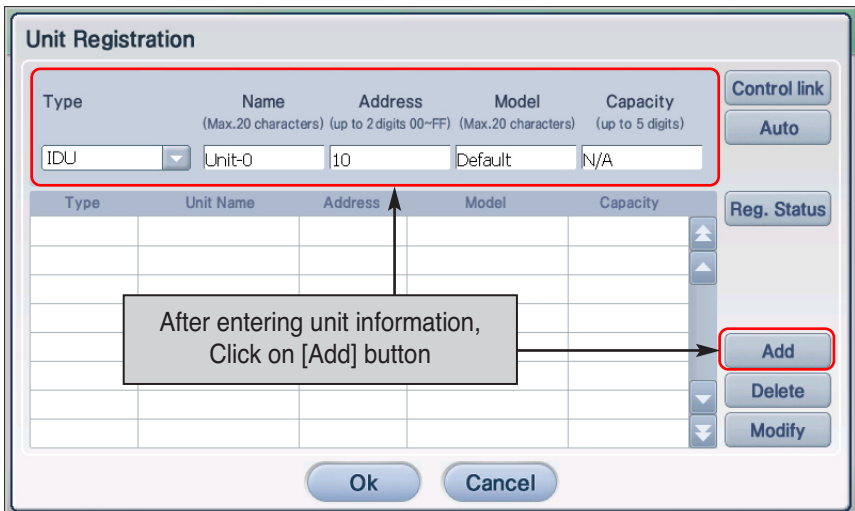

Item	Description
Type	Enter the type of unit. - Air conditioner, Ventilator, On/Off Device, AWHP
Unit name	Enter the name of the unit. You can enter up to 20 characters.
Address	Enter the physical address of the unit. The physical address value is between 00 and FF, and cannot be duplicated.
Model	Enter the model of the unit. You can enter up to 20 characters
Capacity	Enter the maximum power consumption value. The power consumption must not exceed the set value. You can enter up to 5 digits.

3. Added unit information is displayed in the table. Repeat the process in the same method to register all units to add.

To save the registered unit, click on the [OK] button.

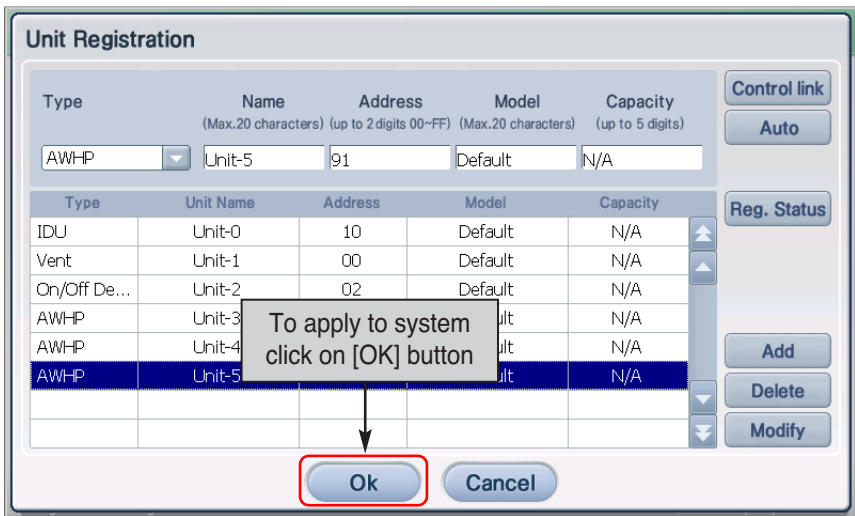

4. 'Information' screen to save the current setting temporarily is displayed. When you click on the [Yes] button, 'Edit unit' screen will be closed and it will return to the prior screen.

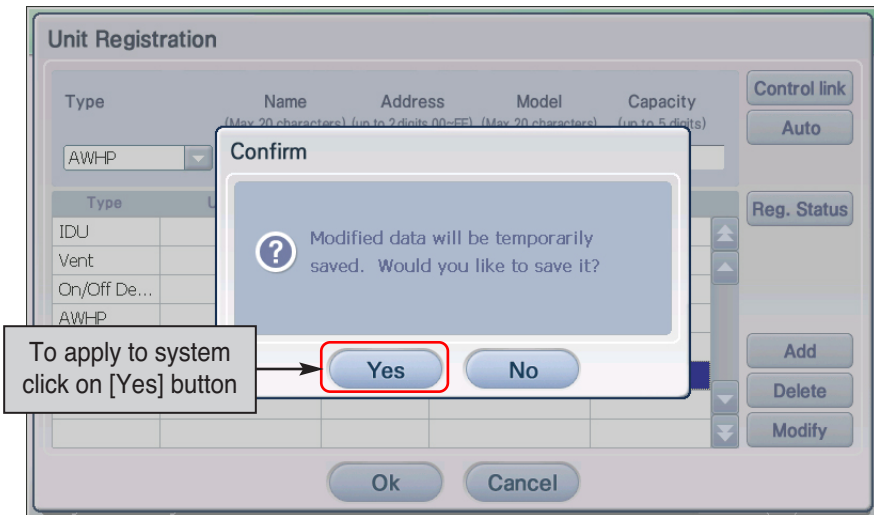

5. Lastly, you must register the temporarily saved unit setting to the system. When you click on the [Save] button, the current setting will be applied to the system and the screen will display the message saying that saving process has been completed. Click on the [OK] button to complete the registration.

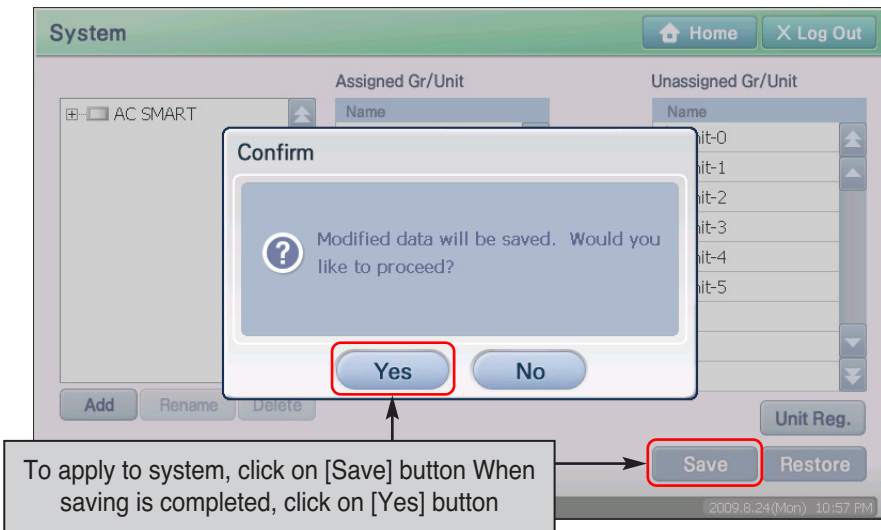

6. Current setting will be applied to the system and a message saying that the saving is completed will be displayed on the screen. Press the [OK] button to complete the registration.

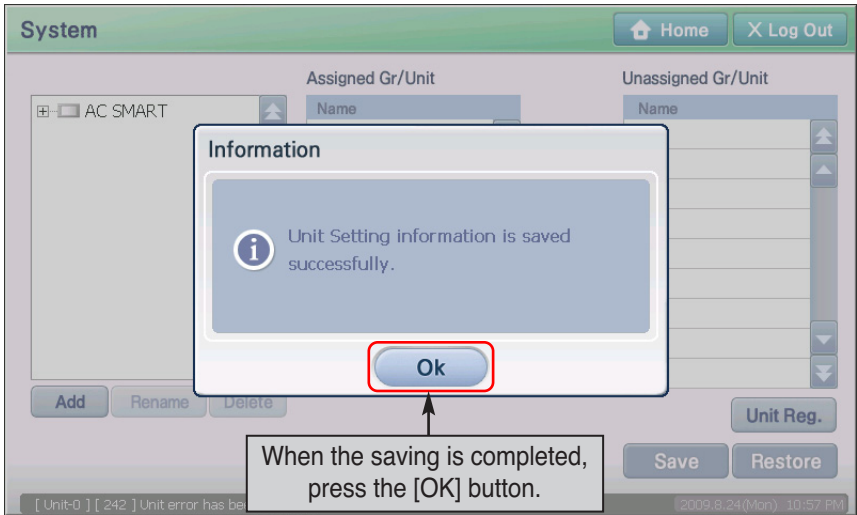

Managing zone

Zone is the logical set of Groups configured around a location of unit function etc. Zone can be composed of several Groups. When executing a specific control command to the specific Zone, all the Groups included in the Zone will execute the same control command.

Creating new zone

To create a new zone, proceed in the following order.

1. Select the 'System' menu from the menu of AC Smart. When you select the 'System' menu, the following screen is displayed. To create a new zone, click on 'AC Smart', which is the highest node of the 'System tree'. List of unregistered units is displayed in 'Unregistered unit' on the right side of the screen.

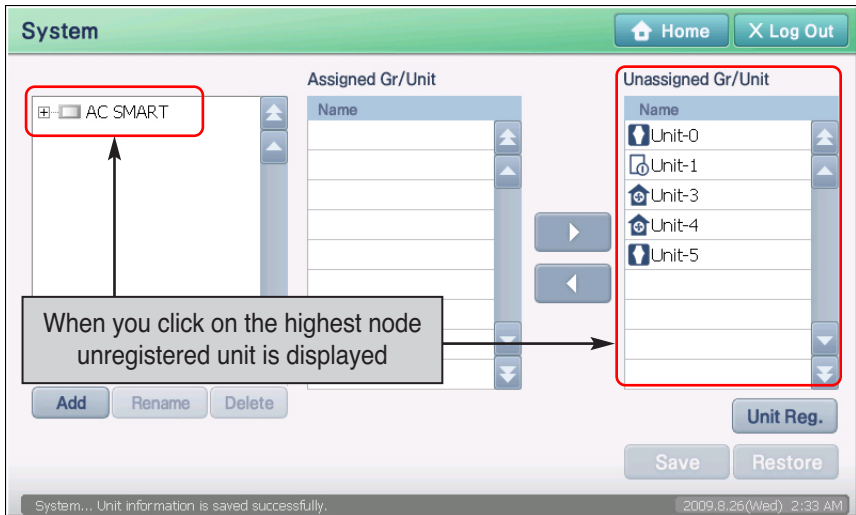

Reference: When the unregistered unit is not shown

When you initially execute AC Smart and have not executed the process of registering the unit, unregistered unit will not be displayed. Proceed after executing registering unit process. If you cannot see the unregistered unit while using AC Smart, all units are already included in specific zone and group.

2. Click on the [Add] button in the system tree screen. 'Zone name' screen to enter the name of the new zone to create is displayed.

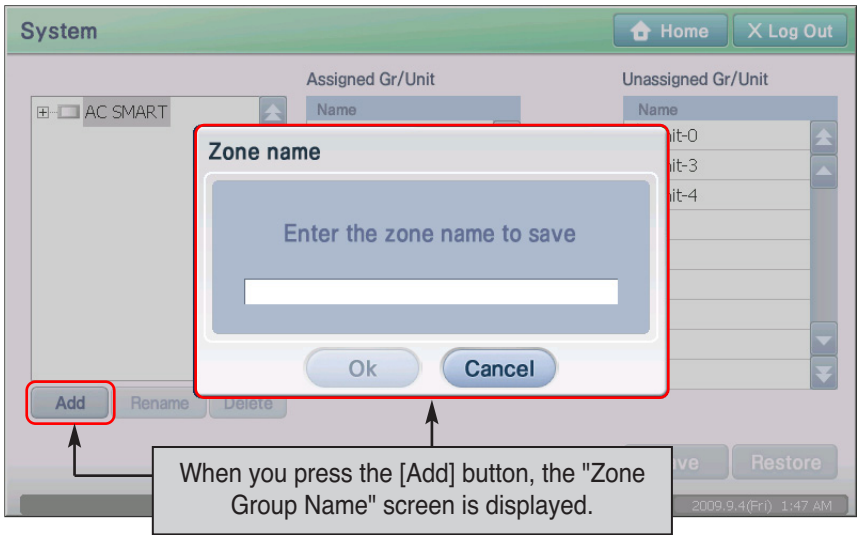

3. After entering the name of the zone to create, click on the [OK] button.

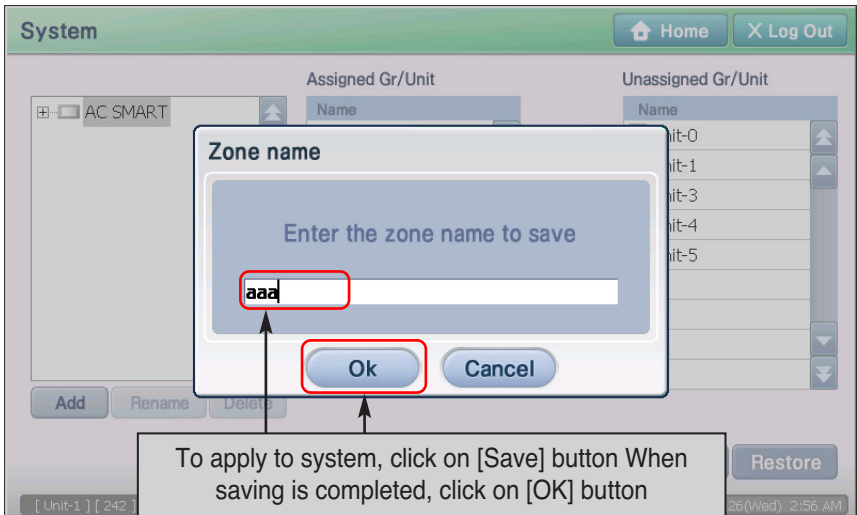

4. Check whether the applicable zone has been created at the lower node of AC Smart node.

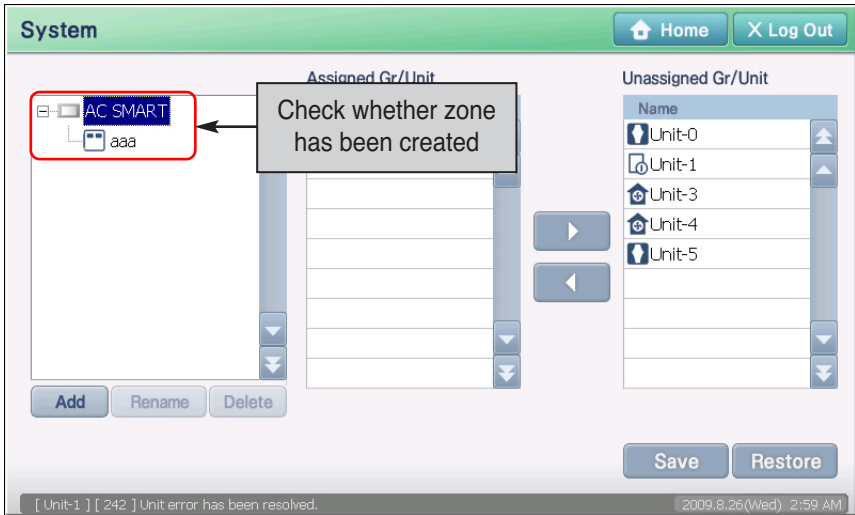

5. Click on the [Save] button to save the setting. Message confirming to save will be displayed on screen. Click on the [Yes] button.

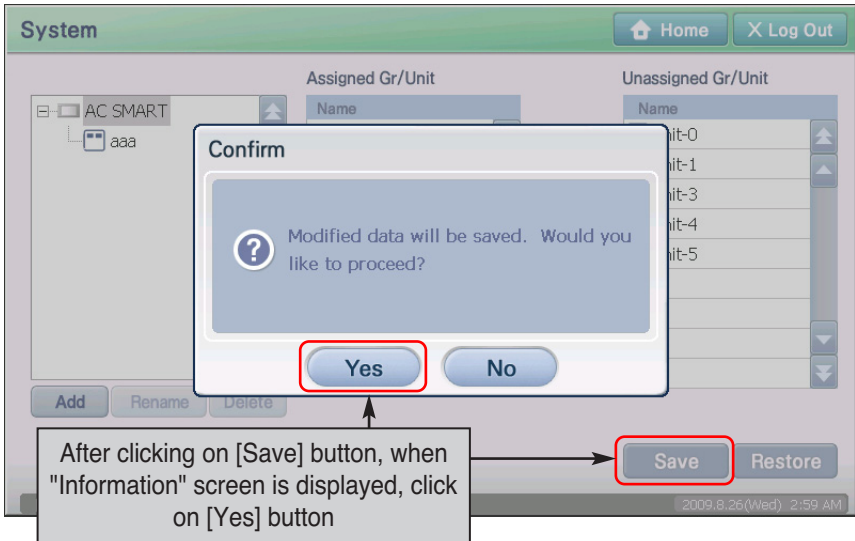

6. After the setting process is displayed on the screen, the save complete message is displayed. When you click on the [OK] button, the save process will be completed.

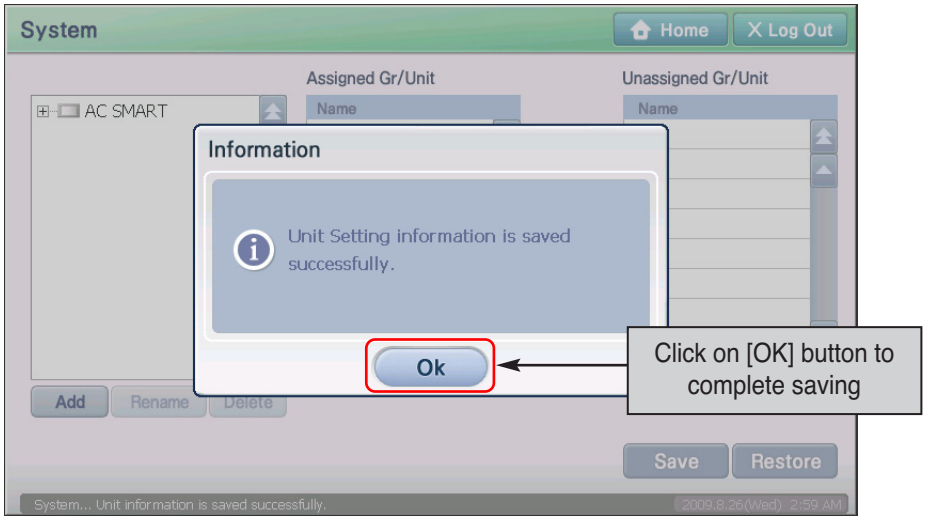

Reference: Reflecting changed unit list

After saving the setting, the list of changed units (Renamed, deleted unit information) will be reflected to the schedule, auto control and statistical function.

Deleting zone

To delete the zone, proceed in the following order.

1. Select the 'System' menu from the menu of AC Smart. When you select the 'System' menu, the following screen is displayed. Select the zone to delete from the 'System tree' and click on the [Delete] button.

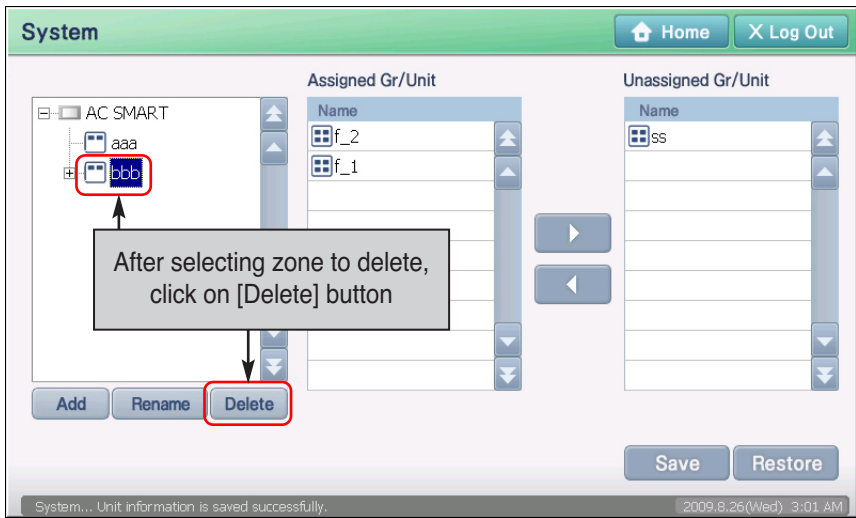

2. Applicable zone is deleted. Check whether the applicable zone has been deleted from the 'System tree'. Unit included in zone to delete is transferred to 'Unregistered unit'.

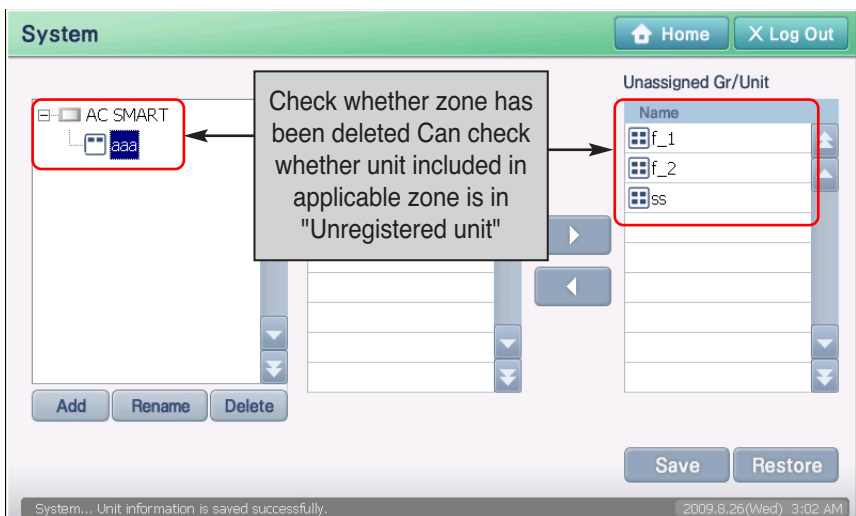

3. Click on the [Save] button to save the setting. Message confirming to save will be displayed on screen. Click on the [Yes] button.

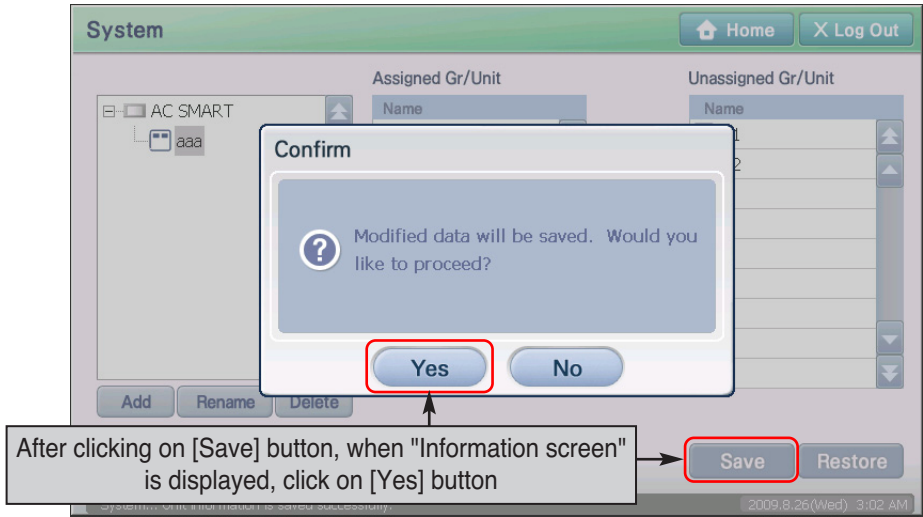

4. After the setting process is displayed on the screen, the save complete message is displayed. When you click on the [OK] button, the save process will be completed.

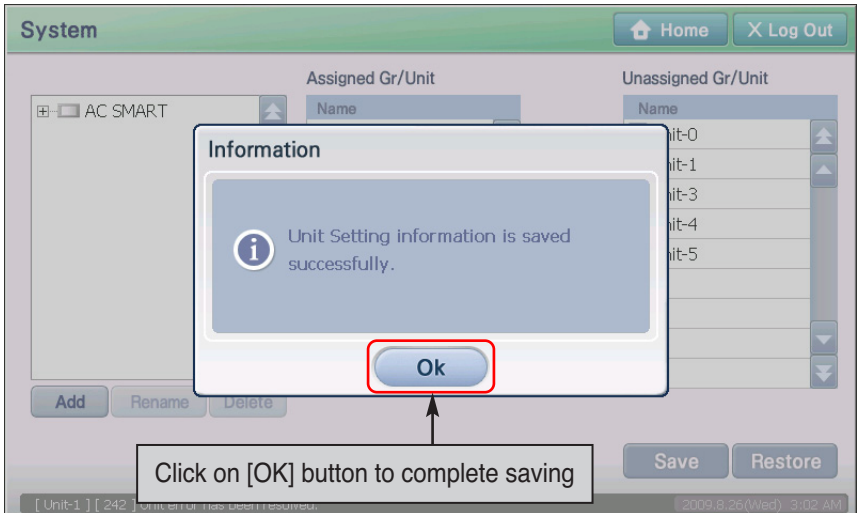

Renaming zone

To rename the zone, proceed in the following order.

1. Select the 'System' menu from the menu of AC Smart. When you select the 'System' menu, the following screen is displayed. Select the zone to rename from 'System tree'.

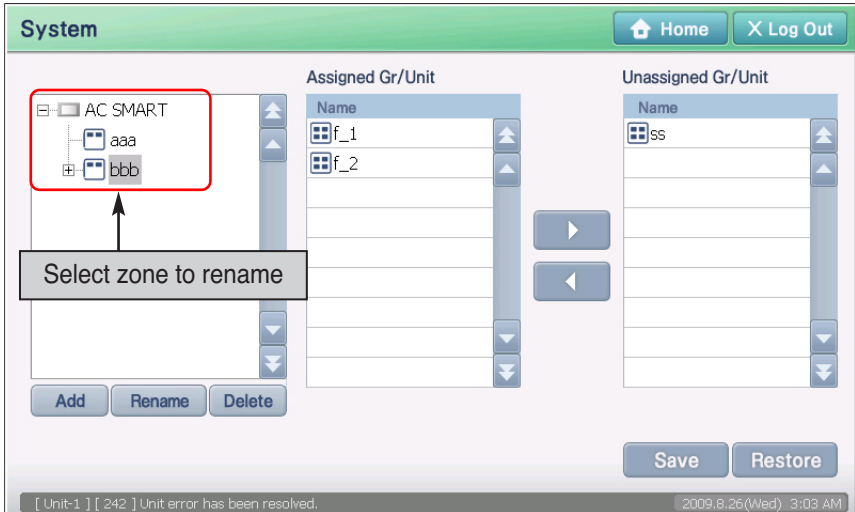

2. Click on the [Rename] button. 'Rename zone' screen to enter the name of zone is displayed.

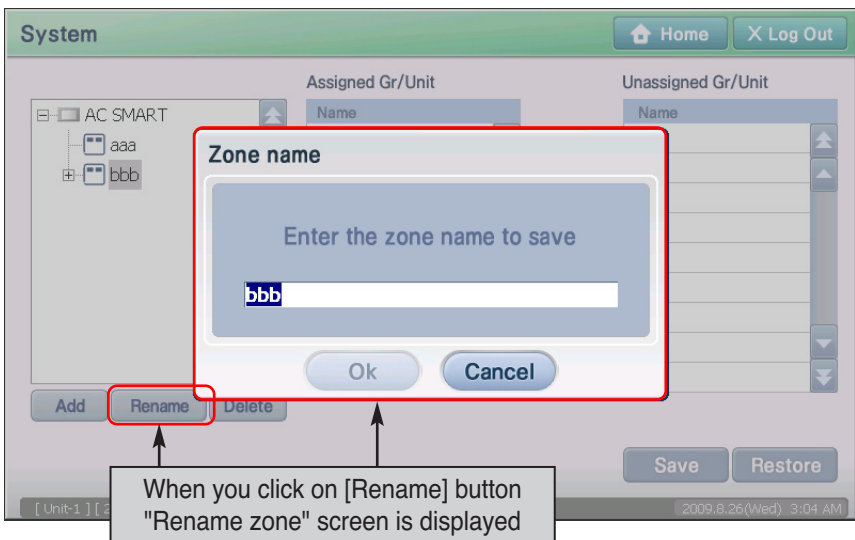

3. After renaming the zone, click on the [OK] button.

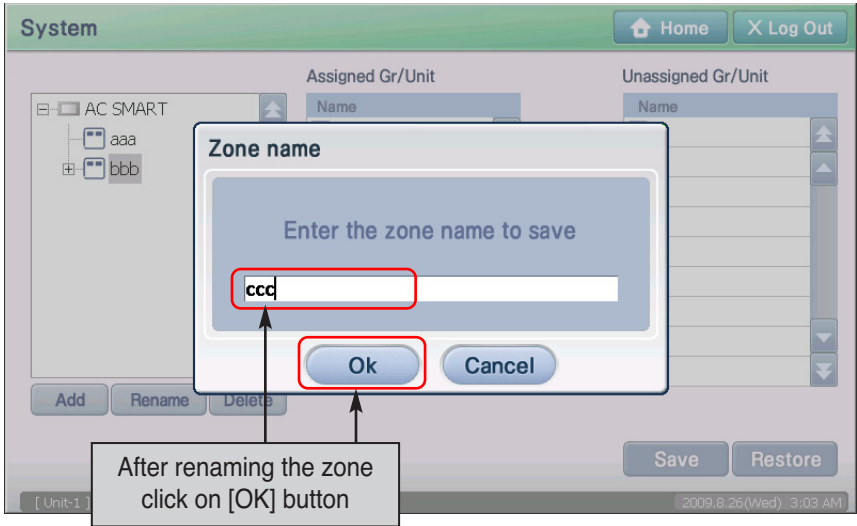

4. Check whether the applicable zone has been renamed in 'System tree'.

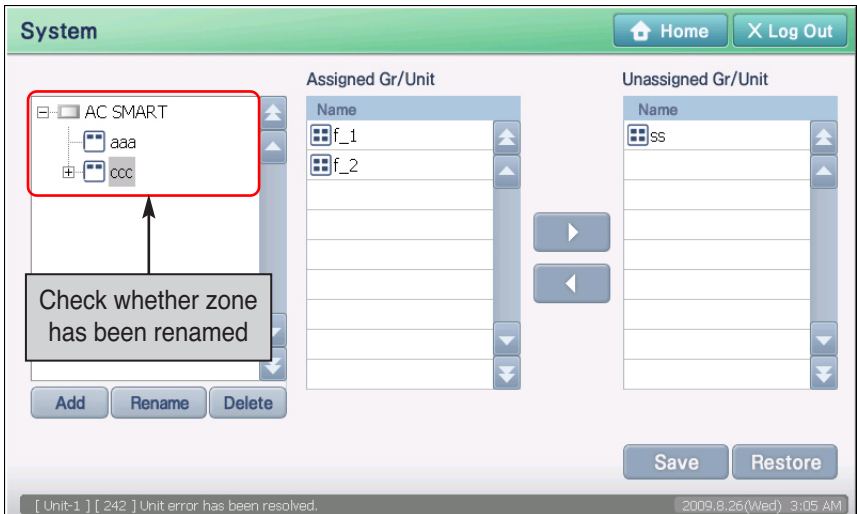

5. Click on the [Save] button to save the changes. Message confirming to save will be displayed on screen. Click on the [Yes] button.

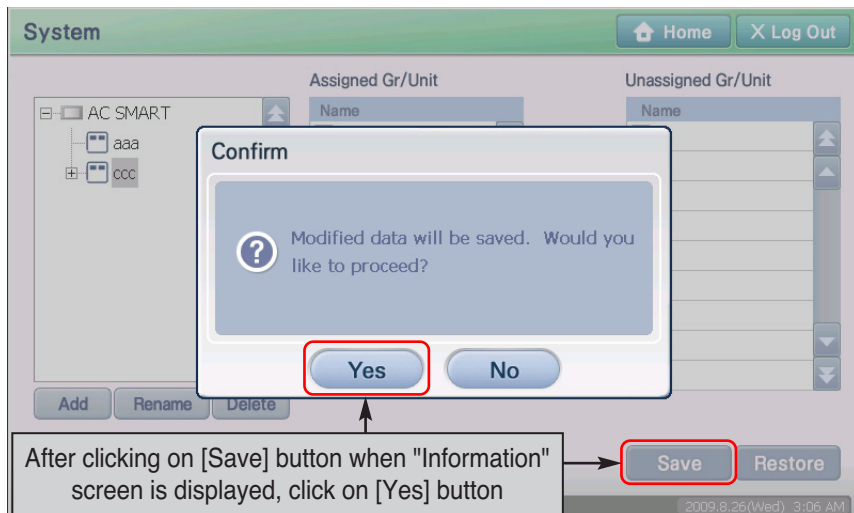

6. After the setting process is displayed on the screen, the save complete message is displayed. When you click on the [OK] button, the save process will be completed.

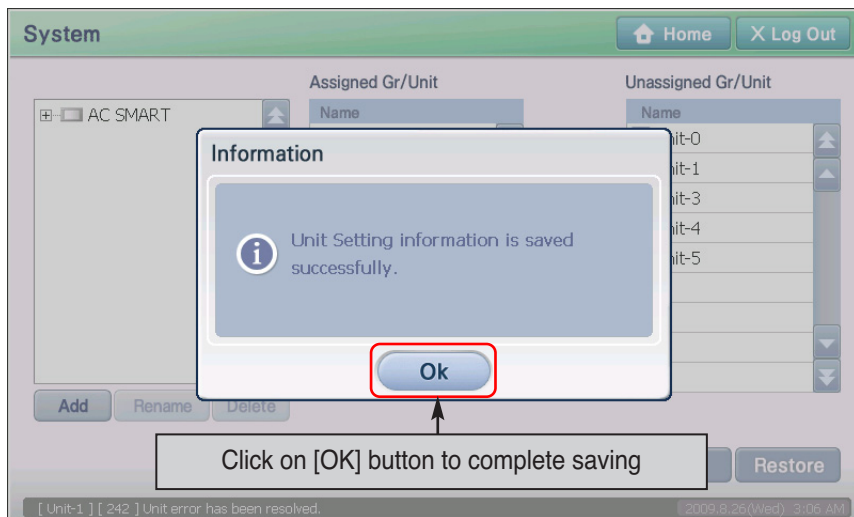

Managing group

Group is a logical gathering of device(indoor unit, ventilator, ON/OFF unit, AWHHP unit) possible to organize according to location or device function and so on. You can organize group by putting together various devices. When executing some control command to specific group, the devices included at group carry out same control command as well.

Resetting group

To reset the group, proceed in the following order.

1. Select the 'System' menu from the menu of AC Smart. When you select the 'System' menu, the following screen is displayed. Click on the name of the zone to reset the group from the 'System tree'. Select the group to reset.

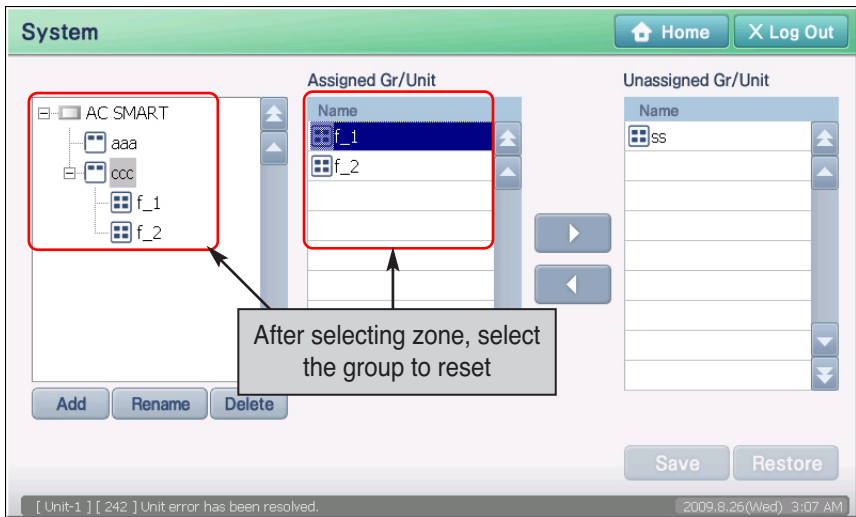

2. Reset the group. 'Registered unit' displays group current zone is included and 'Unregistered unit' includes the group not assigned to any zone. Use the [] and [] button to include or delete the group.

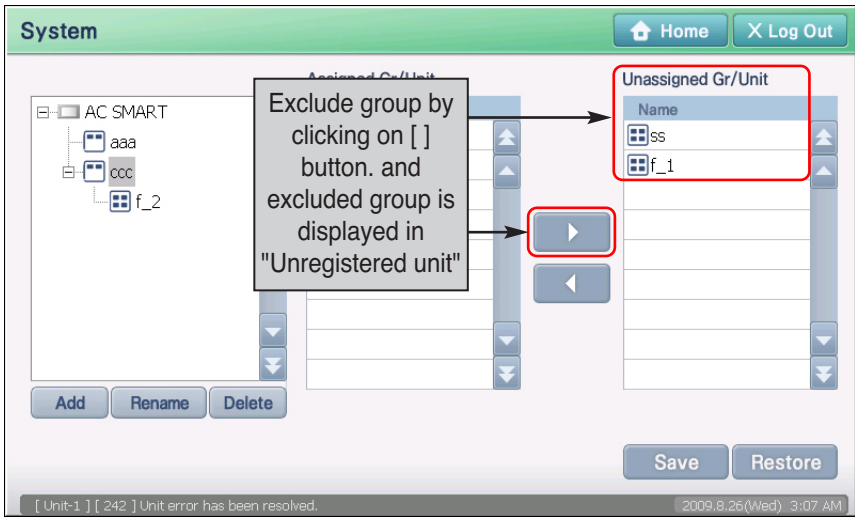

3. Select the zone to include the excluded group. 'Registered unit' displays the group including the applicable zone. Select the excluded group.

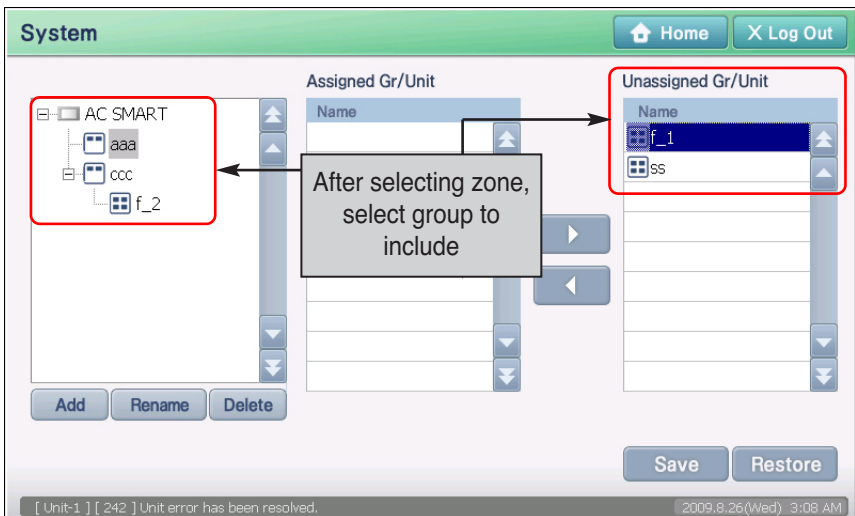

4. Click on the [] button to include the designated group to 'Registered unit'. Applicable group is moved and displayed in 'Registered unit'.

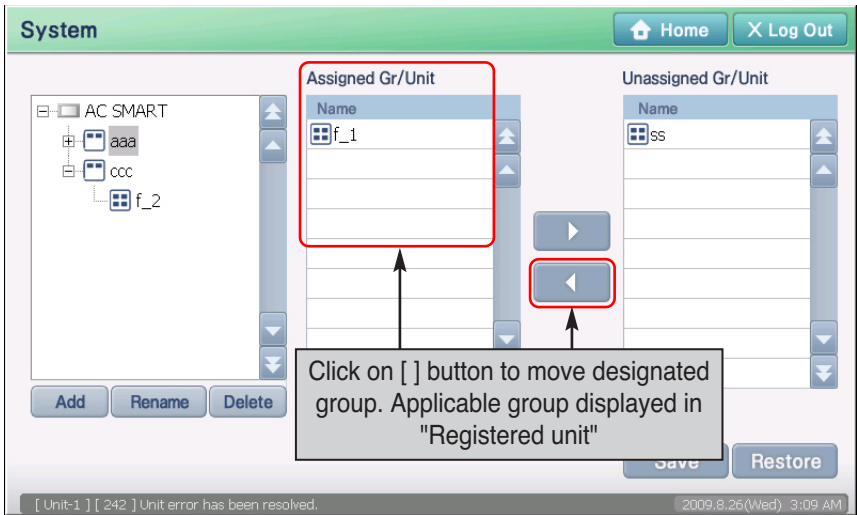

5. Click on the [Save] button to save the setting. Message confirming to save will be displayed on screen. Click on the [Yes] button.

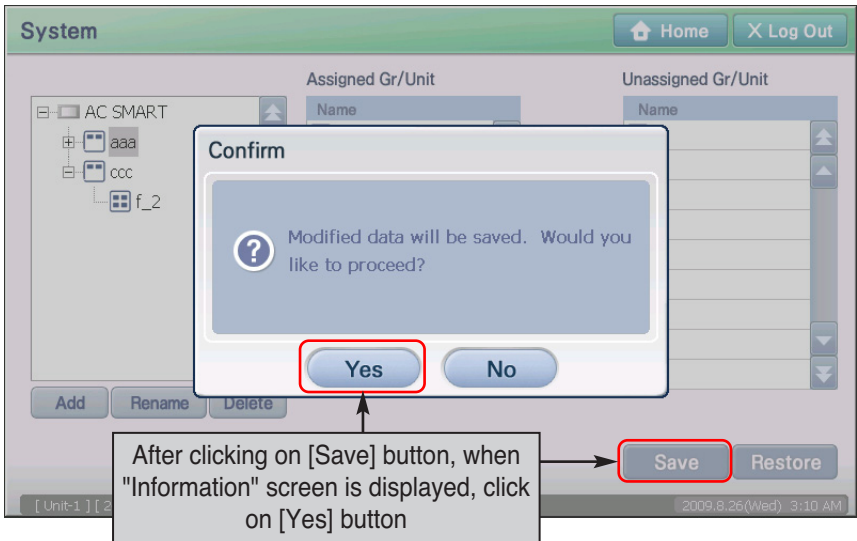

6. After the setting process is displayed on the screen, the save complete message is displayed. When you click on the [OK] button, the save process will be completed.

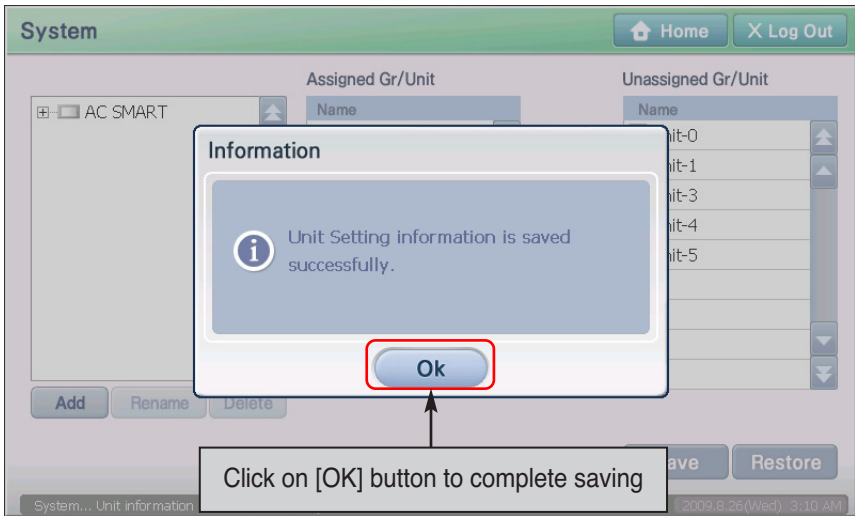

Creating new group

To create a new group, proceed in the following order.

1. Select the 'System' menu from the menu of AC Smart. When you select the 'System' menu, the following screen is displayed. Select the zone to include the new group to from the 'System tree'.

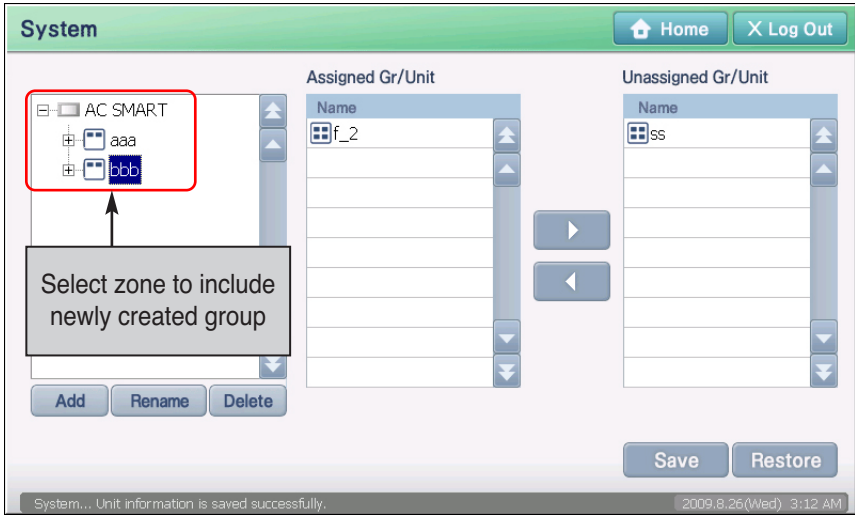

2. Click on [Add] button in system tree screen. 'Group name' screen to enter the name of the group to create is displayed.



3. After entering the name of the group to create, click on the [OK] button.

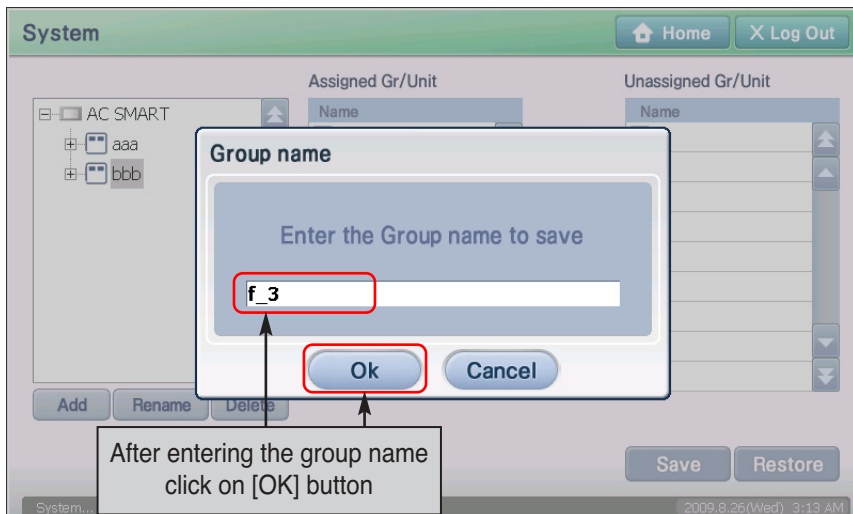

4. Check whether the applicable group is created in the lower node of the selected zone.

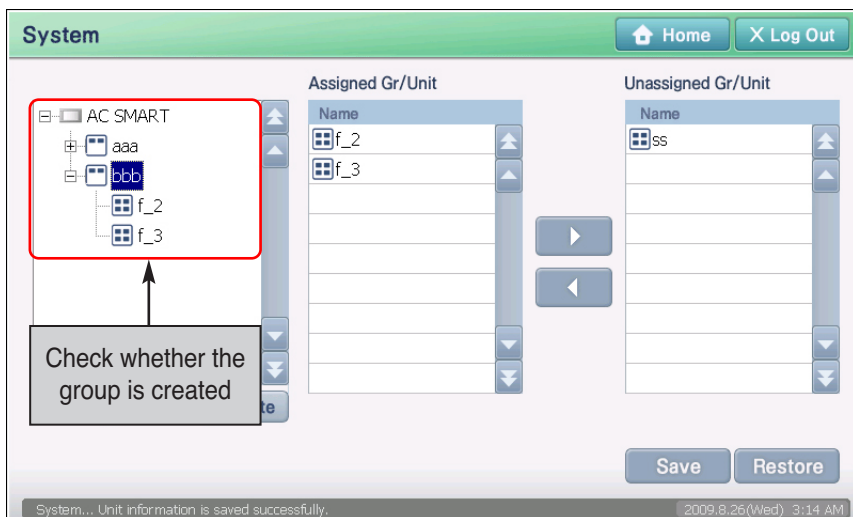

5. Click on the [Save] button to save the setting. Message confirming to save will be displayed on screen. Click on the [Yes] button.

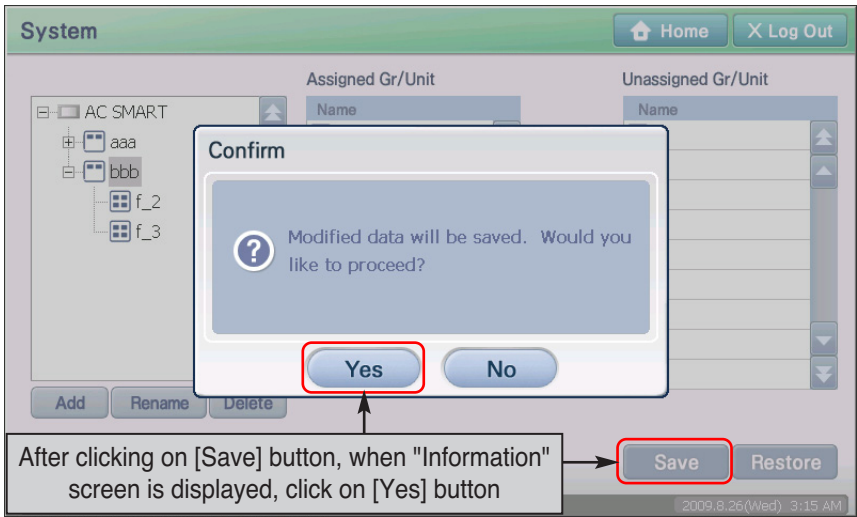

6. After the setting process is displayed on the screen, the save complete message is displayed. When you click on the [OK] button, the save process will be completed.

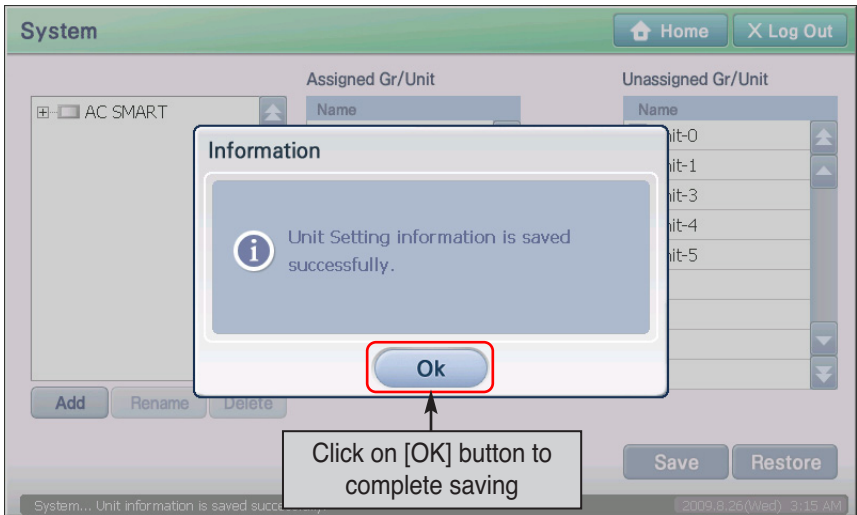

Deleting group

To delete the group, proceed in the following order.

1. Select the 'System' menu from the menu of AC Smart. When you select the 'System' menu, the following screen is displayed. Select the group to delete from 'System tree', and click on the [Delete] button.

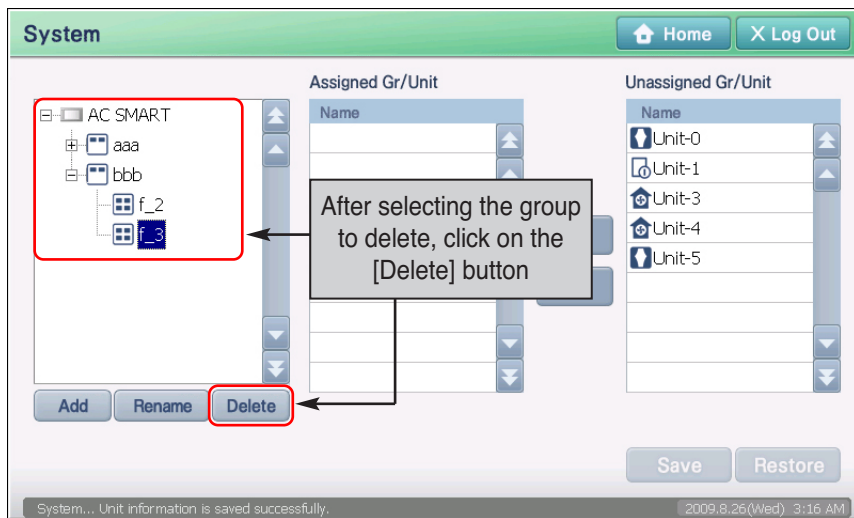

2. Applicable group is deleted. Check whether the applicable group is deleted from the 'System tree'.

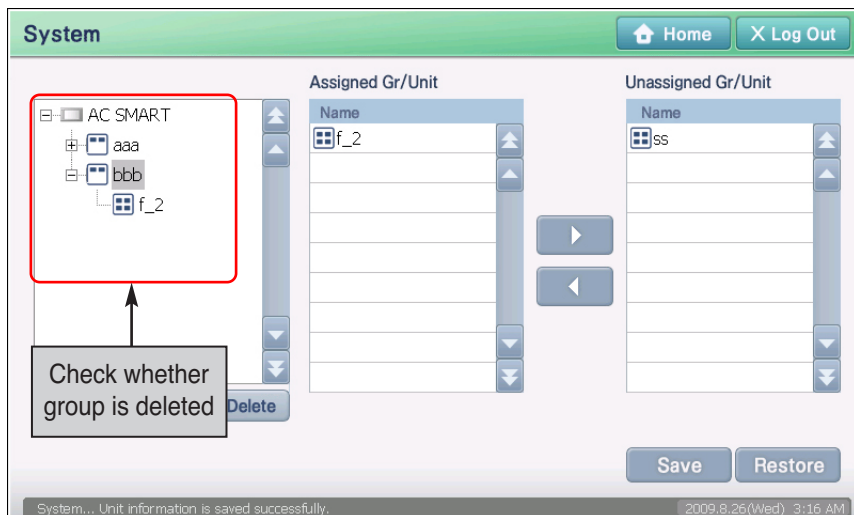

- Click on the [Save] button to save the setting. Message confirming to save will be displayed on screen. Click on the [Yes] button.

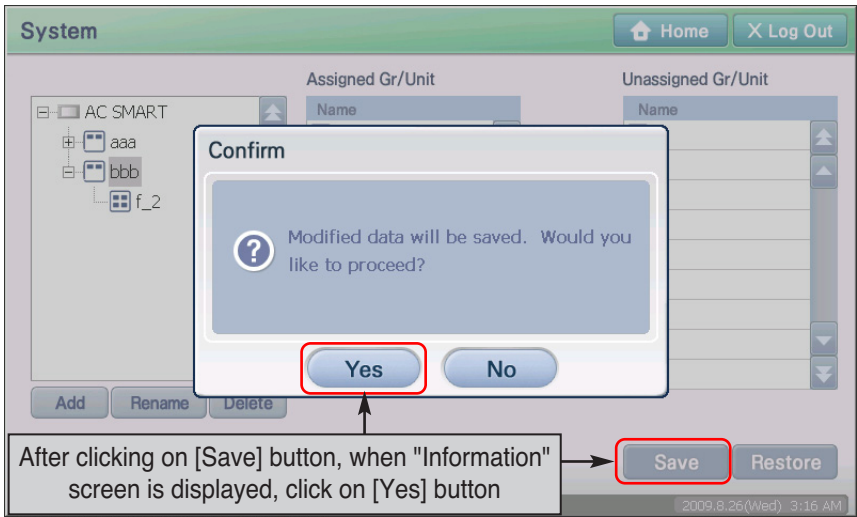

- After the setting process is displayed on the screen, the save complete message is displayed. When you click on the [OK] button, the save process will be completed. The unit included in the deleted group is moved to the 'Unregistered unit'.

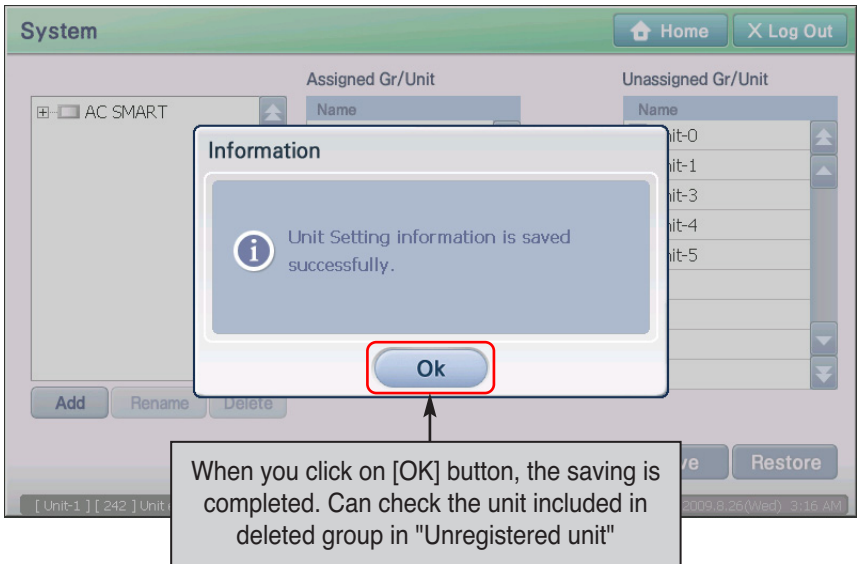

Renaming group

To rename the group, proceed in the following order.

1. Select the 'Setting' menu from the menu of AC Smart. When you select the 'Setting' menu, the following screen is displayed. Select the group to rename from the 'System tree'.

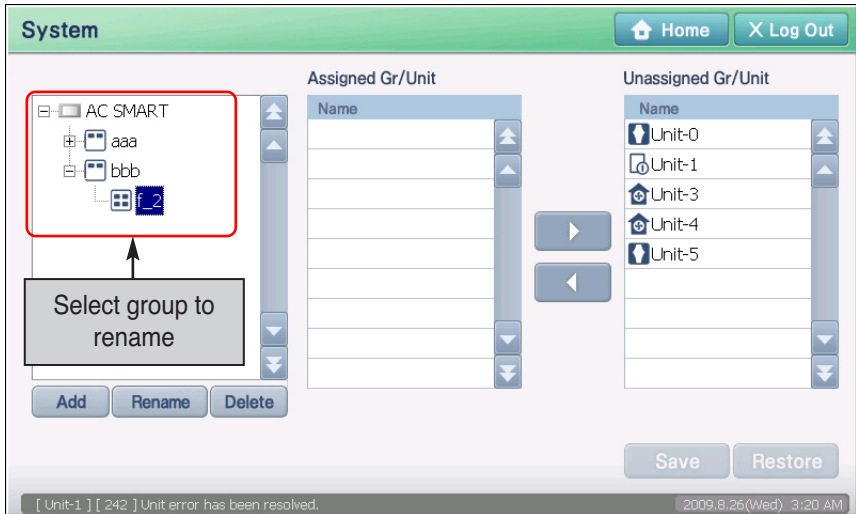

2. Click on the [Rename] button. 'Rename group' screen to enter the name of the group is displayed.

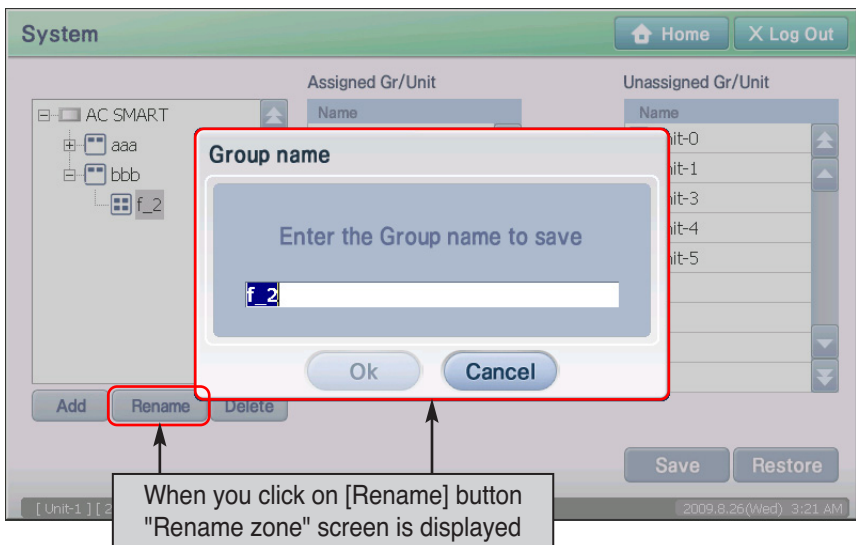

3. After renaming the group, click on the [OK] button.

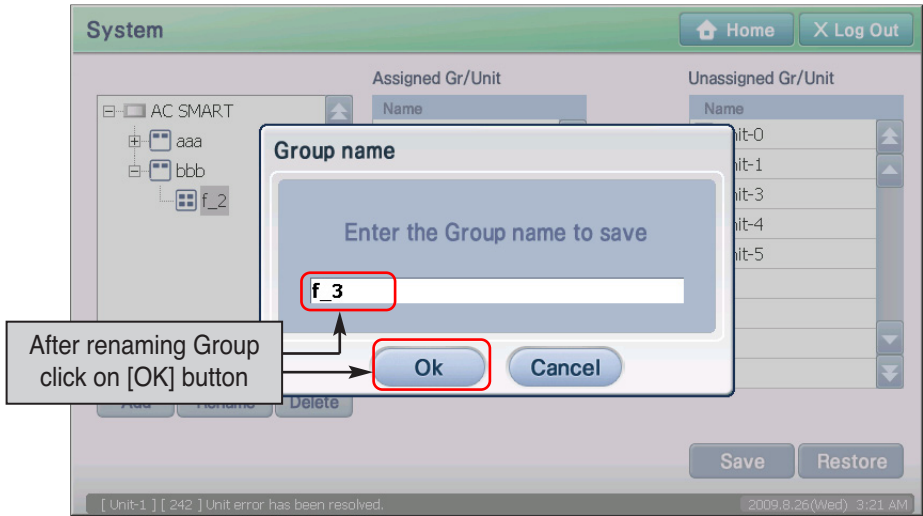

4. Check whether the name of the applicable group has been renamed in the 'System tree'.

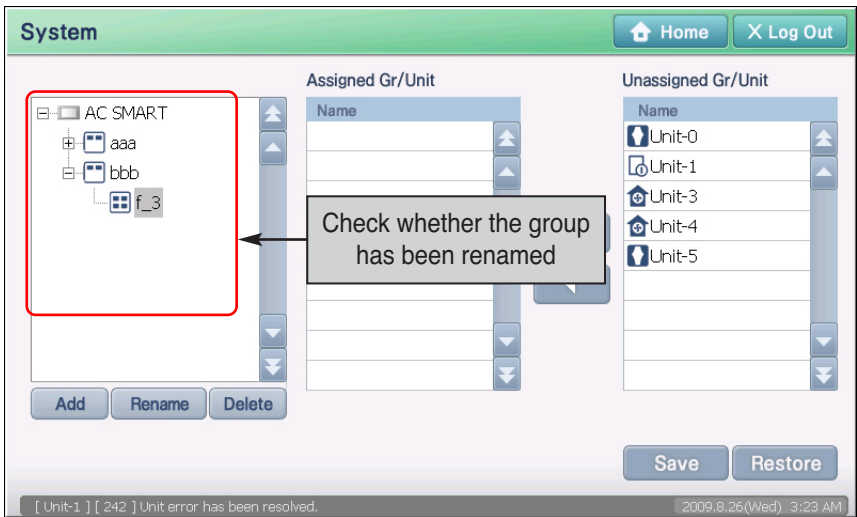

5. Click on the [Save] button to save the setting. Message confirming to save will be displayed on screen. Click on the [Yes] button.

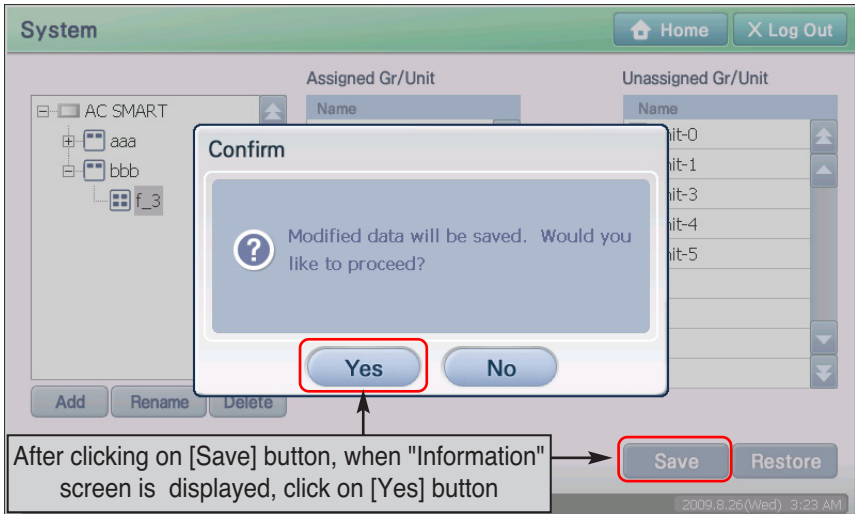

6. After the setting process is displayed on the screen, the save complete message is displayed. When you click on the [OK] button, the save process will be completed.

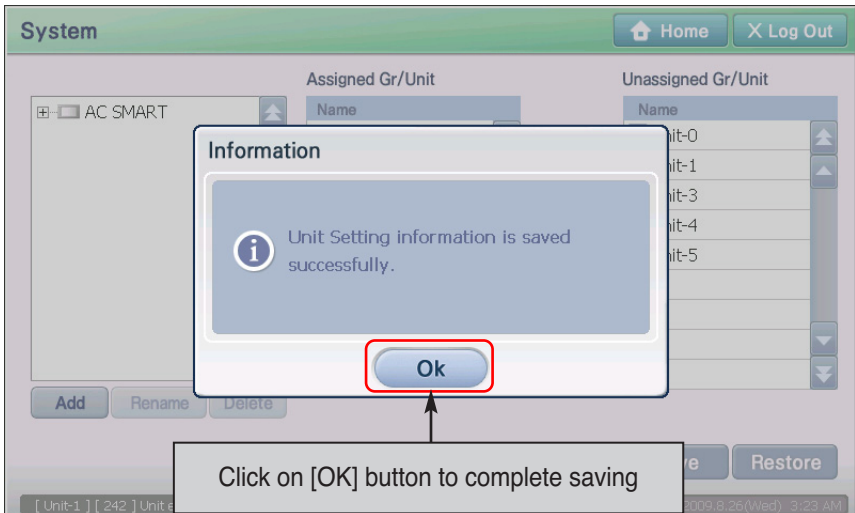

Managing the unit

Unit (Indoor unit, Ventilator, On/Off unit, AWHF unit) is the smallest control unit linked with AC SMART II.

Resetting the unit

To reset the unit, proceed in the following order.

1. Select the 'System' menu from the menu of AC Smart. When you select the 'System' menu, the following screen is displayed. Click on the name of the group to reset the unit from the 'System tree'. The unit included in the applicable group will be displayed in the 'Registered unit' list. Select the unit to reset.

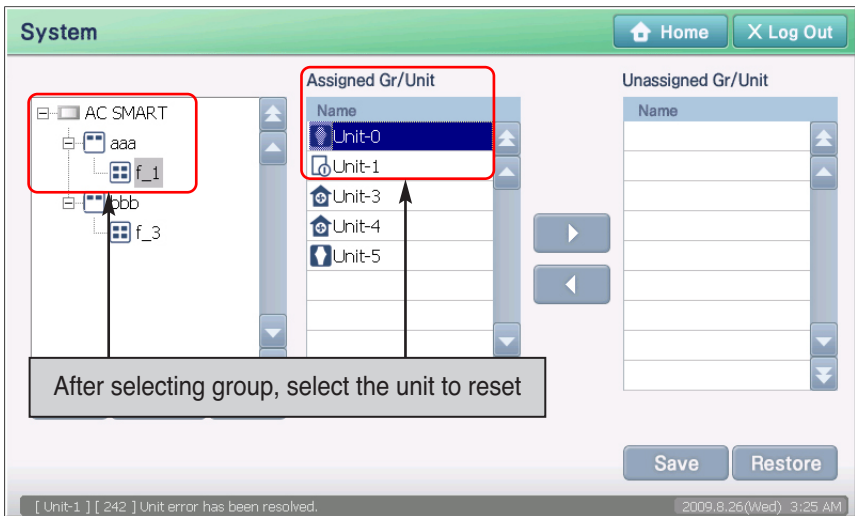

2. Rest the unit. The unit included in the current group is displayed in 'Registered unit' list and the unit not assigned to any group is displayed in the 'Unregistered unit' list. Press the [] and [] button, to add or delete the unit.

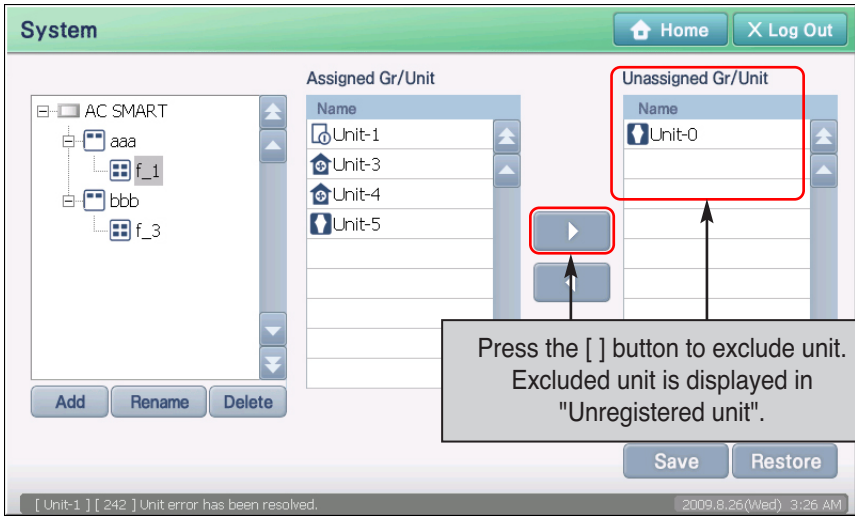

3. Select the group and unit to add the excluded unit to.

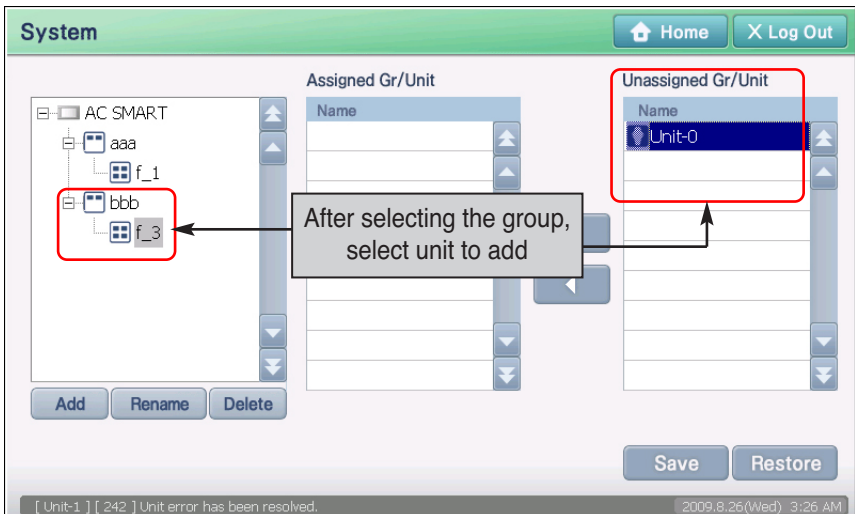

4. Press the [] button, to add the designated group to 'Registered unit'. The applicable unit will be moved and displayed in the 'Registered unit' list.

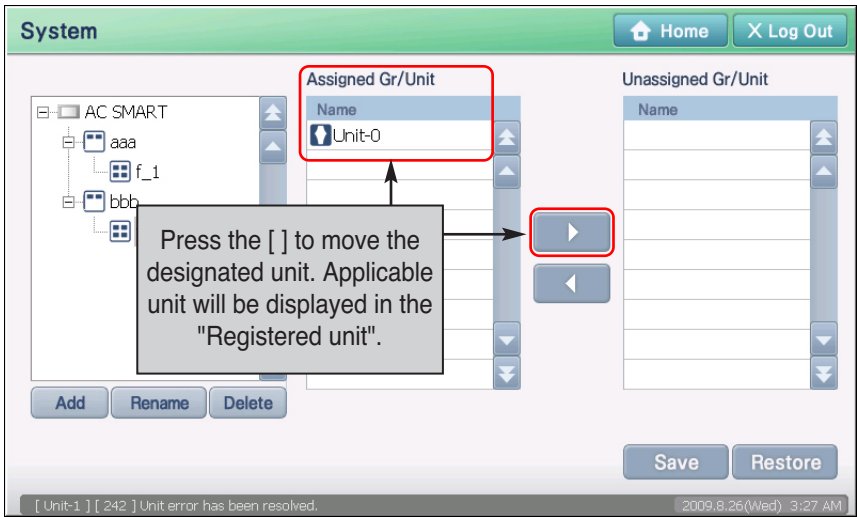

5. Click on the [Save] button to save the current setting. Message confirming to save will be displayed on screen. Click on the [Yes] button.

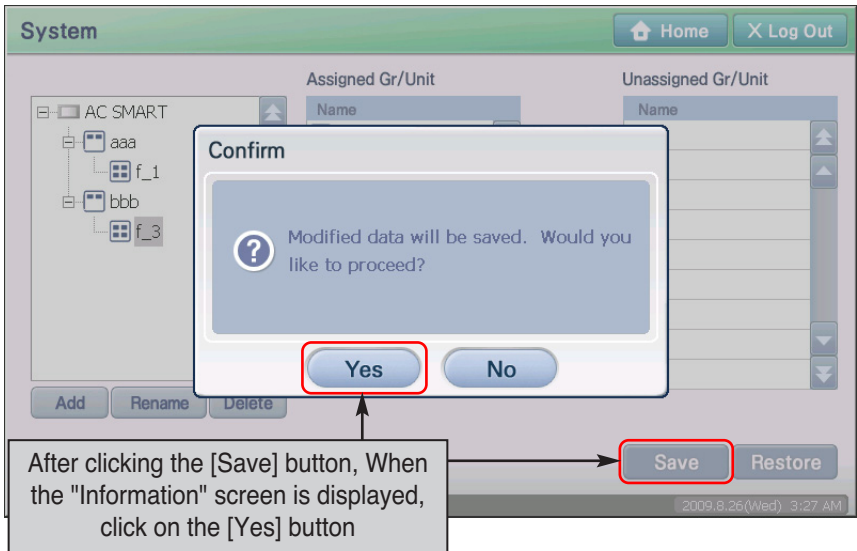

6. After the setting process is displayed on the screen, the save complete message is displayed. When you click on the [OK] button, the save process will be completed.

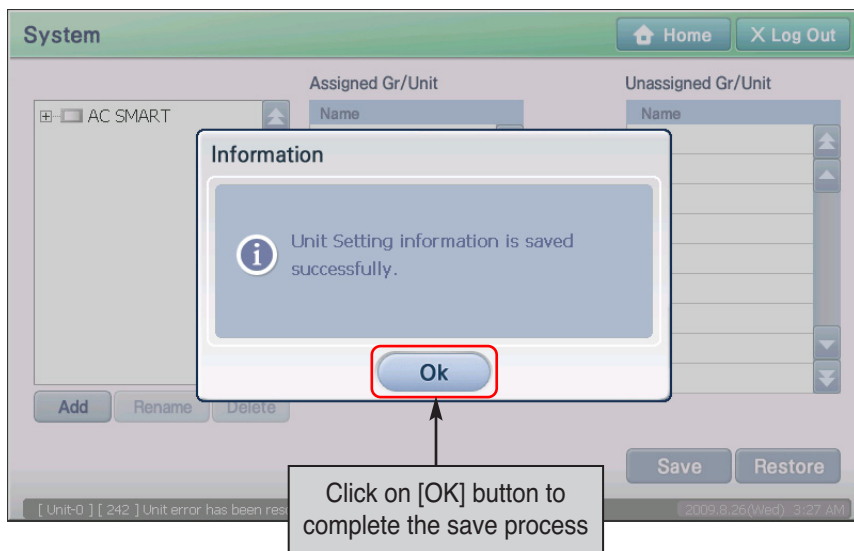

Deleting registered unit

You can delete the unit information connected and registered to AC Smart. To delete the unit information, proceed in the following order.

1. Select the 'Setting' menu from the menu of AC Smart. When you select the 'Setting' menu, the following screen is displayed. Click on the [Unit Reg.] button located on the right side of the screen.

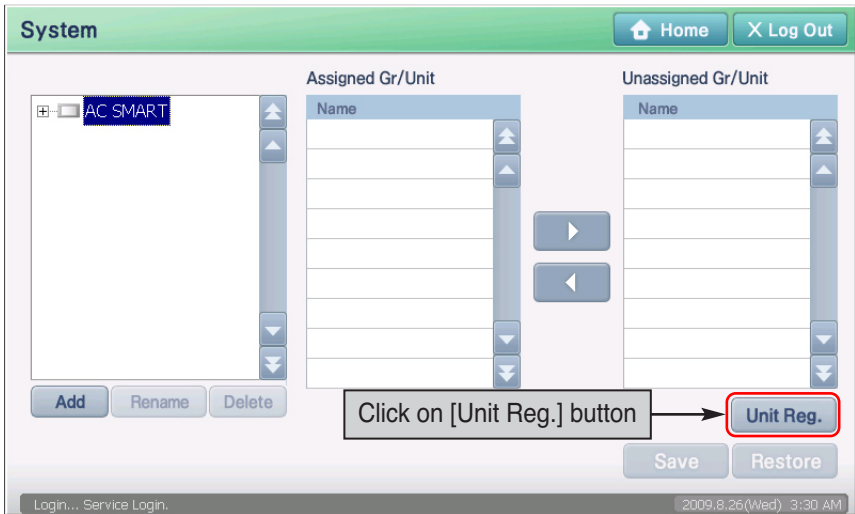

2. 'Edit unit' screen is displayed. Select the unit to delete from the registered unit list and click on the [Delete] button. The applicable unit will be deleted.

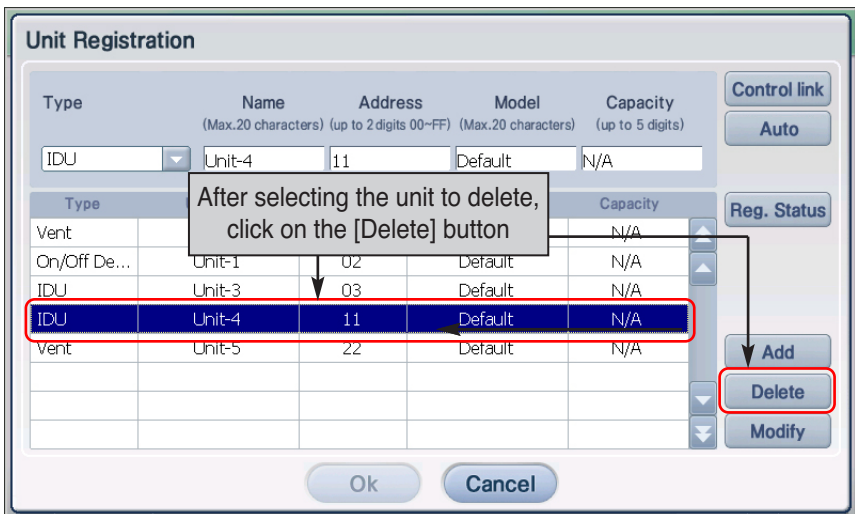

3. To save the unit you have deleted, click on the [OK] button. 'Information' screen to temporarily save the current setting is displayed. When you click on the [Yes] button, the 'Edit unit' screen will end and return to the prior screen.

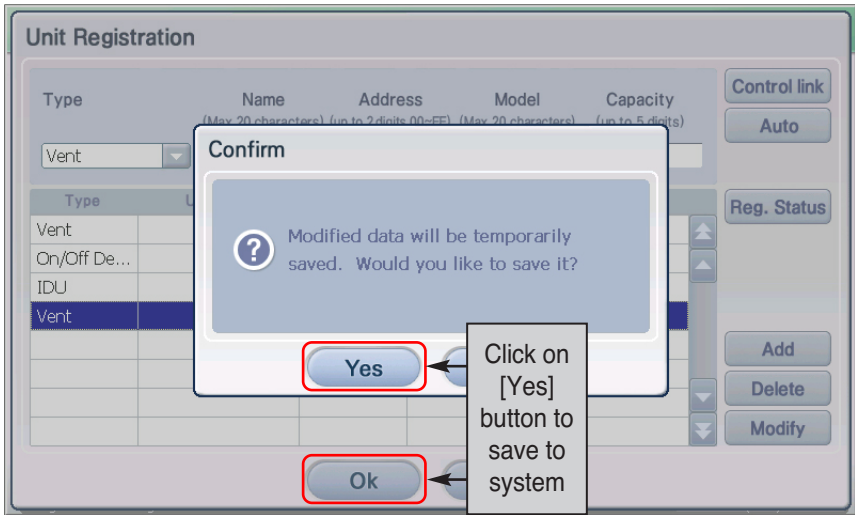

4. Lastly, you must register the setting of the unit temporarily saved. Click on the [Save] button to save the setting. Message confirming to save will be displayed on screen. Click on the [Yes] button.

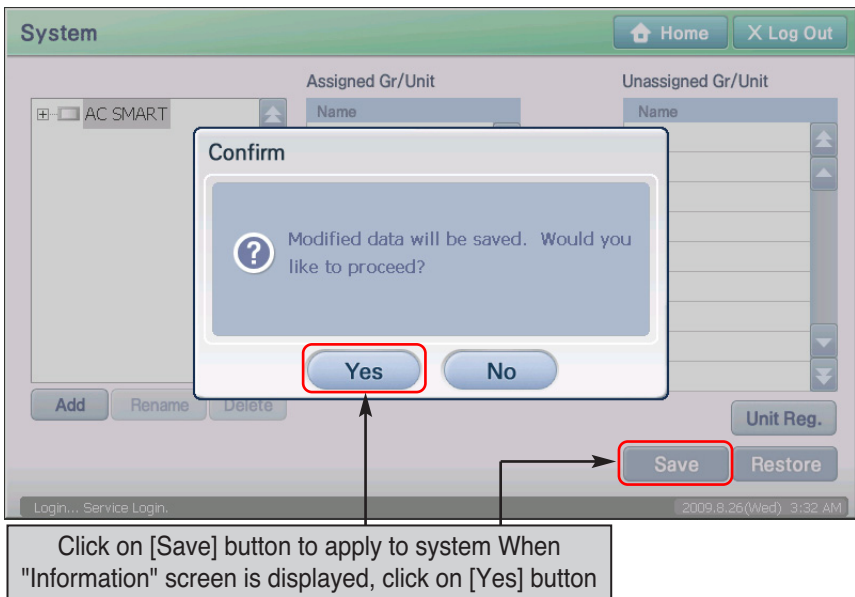

5. After the setting process is displayed on the screen, the save complete message is displayed. When you click on the [OK] button, the save process will be completed.

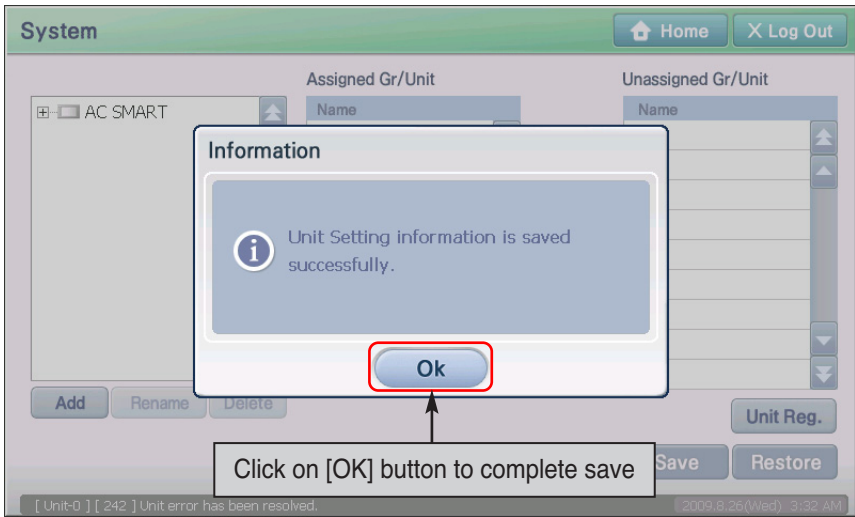

Editing registered unit

You can change the unit information connected and registered to AC Smart. To change the unit information, proceed in the following order.

1. Select the 'System' menu from the menu of AC Smart. When you select the 'System' menu, the following screen is displayed. Click on the [Unit Reg.] located on the right side of the screen.

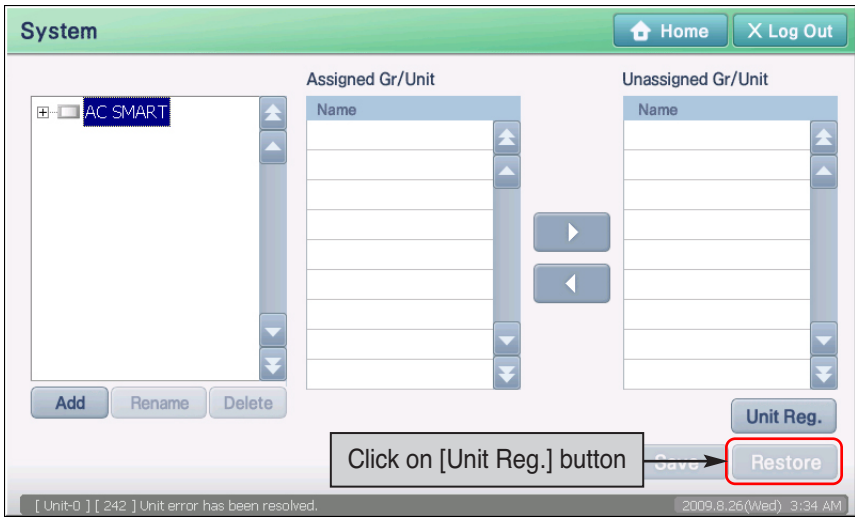

2. 'Edit unit' screen is displayed. Select the unit to change the information of from the unit list. Change the information of the selected unit. Refer to the following chart for the information entered.

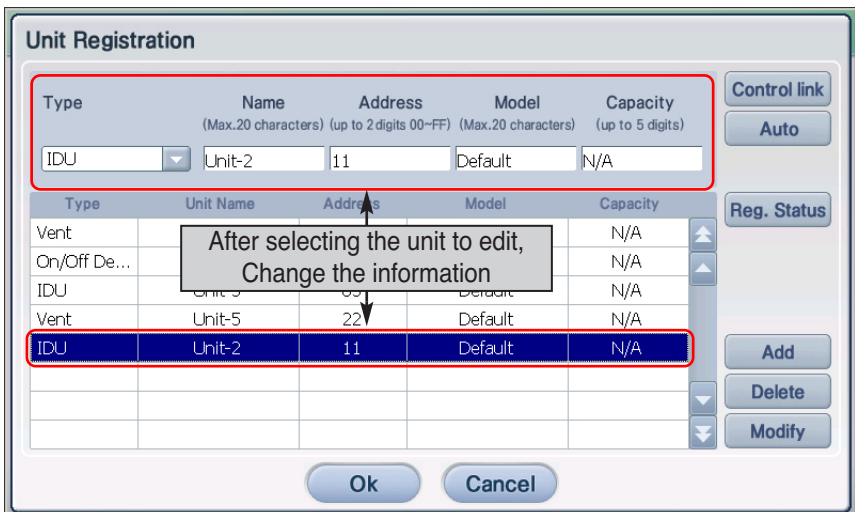

Item	Description
Type	Enter the type of unit. - Air conditioner - Ventilator - On/Off Device - AWHP
Unit name	Enter the name of the unit. You can enter up to 20 characters.
Address	Enter the physical address of the unit. The physical address value is between 00 and FF, and cannot be duplicated.
Model	Enter the model of the unit. You can enter up to 20 characters.
Capacity	Enter the maximum power consumption value. The power consumption must not exceed the set value. You can enter up to 5 digits.

3. Click on the [Modify] button. The applicable unit information is changed .

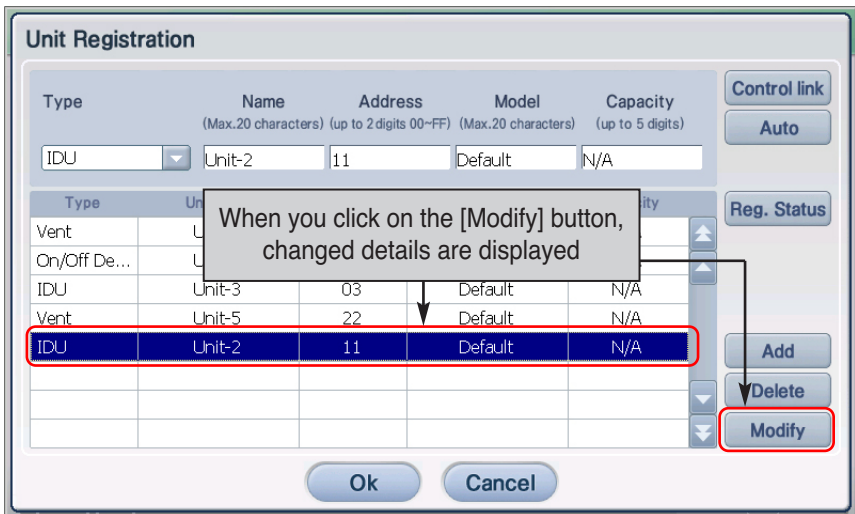

4. Click on the [OK] button to save the changes. 'Information' screen to temporarily save the current setting is displayed. When you click on the [Yes] button, the 'Edit unit' screen will end and return to the prior screen.

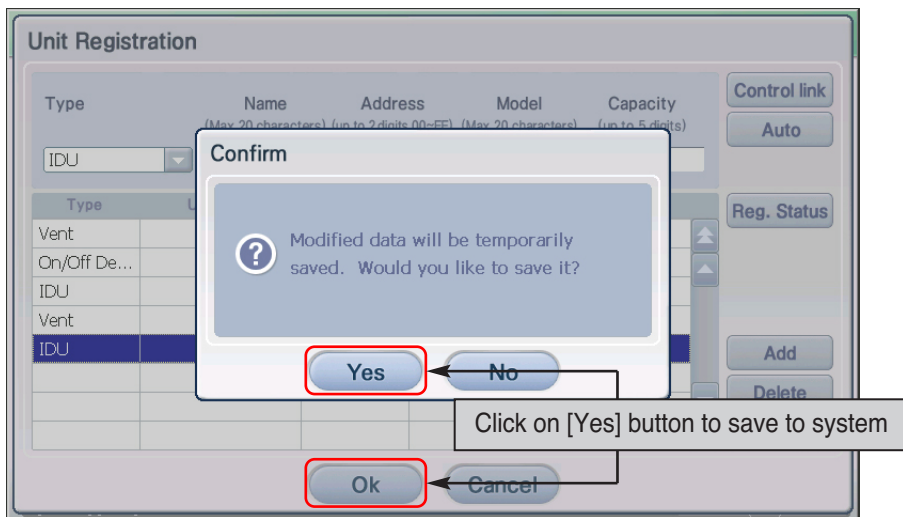

5. Lastly, you must register the setting of the unit temporarily saved. Click on the [Save] button to save the setting. Message confirming to save will be displayed on screen. Click on the [Yes] button.

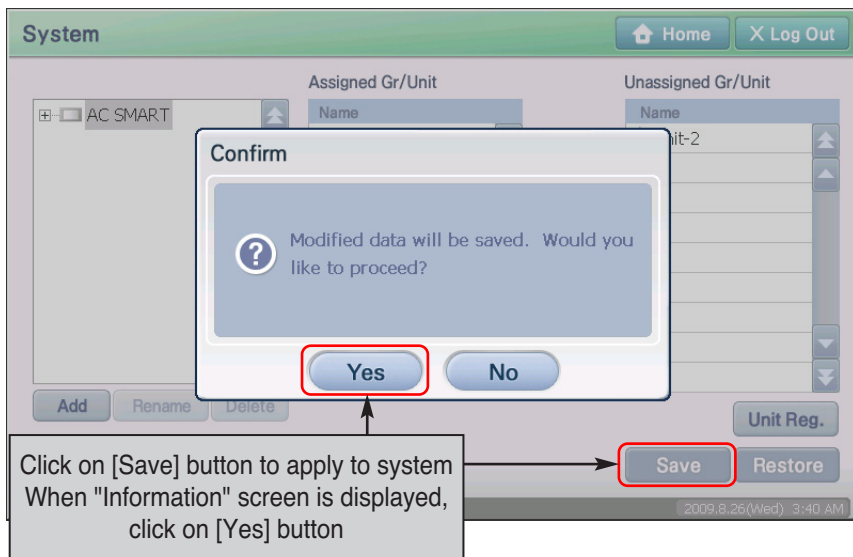

6. After the setting process is displayed on the screen, the save complete message is displayed. When you click on the [OK] button, the save process will be completed.(4-139)

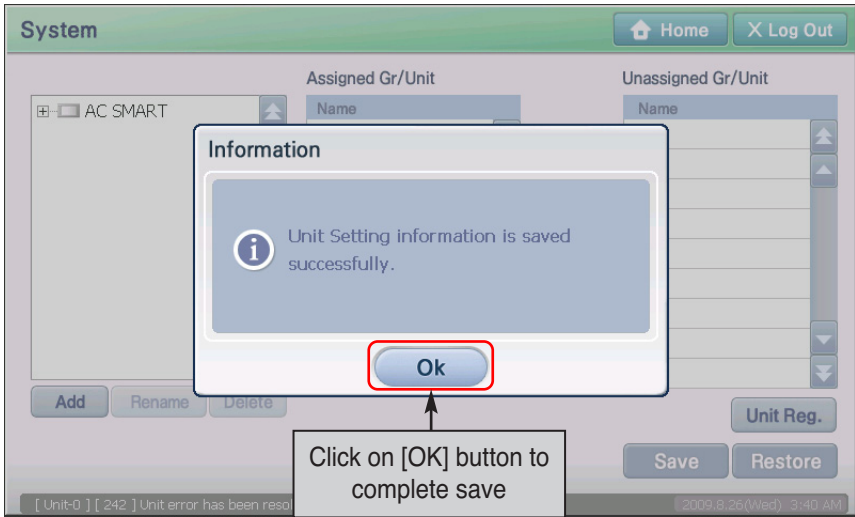

Information: Setting to interconnect the external central controller

The AC Smart offer the function controlling the unit by interconnecting with other central controllers. In this case, the external central controller operates as master while the AC Smart operates as slave. When the external central controller operates as master, the external central controller gets the right to control some functions. So, when the AC Smart operates as slave, you cannot use schedule, automatic control and detailed lock functions.

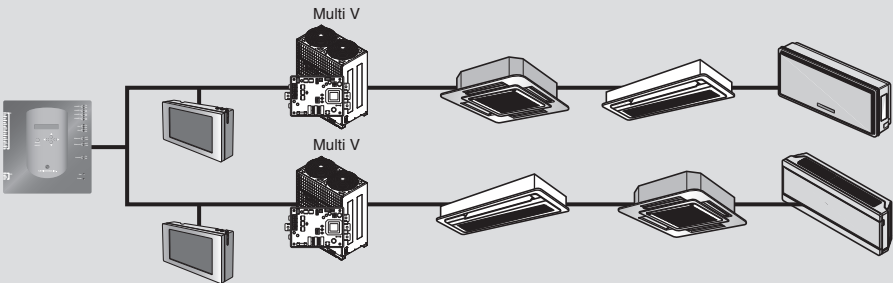

In order to set the interconnection with the external central controller, press [Control link] button 'Unit management' screen. When 'Set to interconnect with the external central controller' screen is displayed, check the check box at the bottom and press [OK] button.

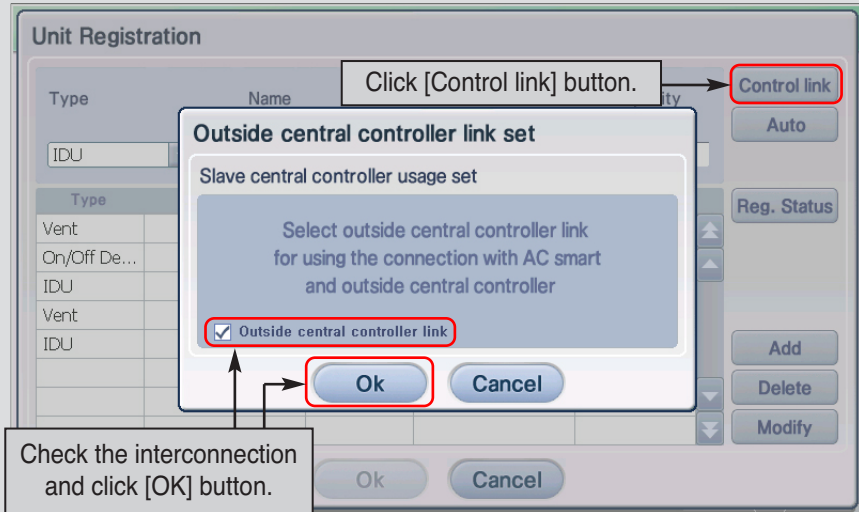

When interconnecting with the external central controller, in order to automatically register the unit at the AC Smart, the address range should be specified not to conflict with the address set the other controller. When you [Auto] button, the screen to specify the range is displayed.

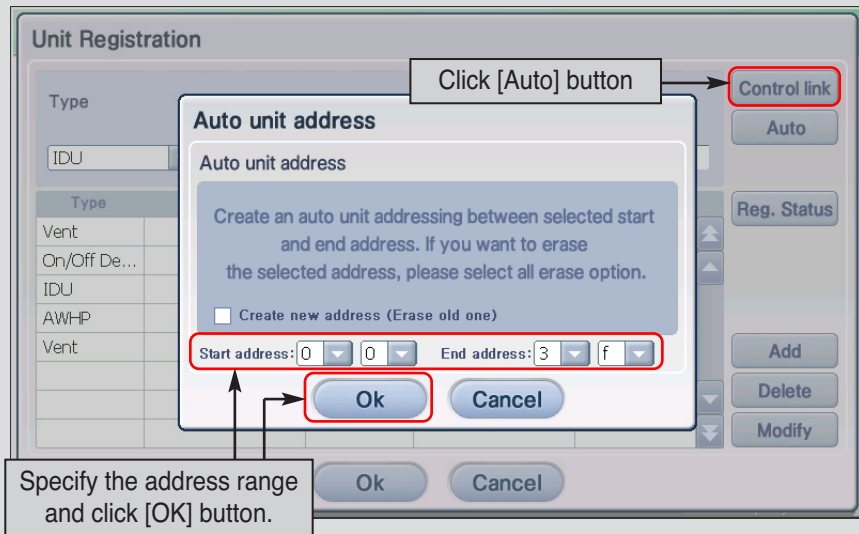

9. Environment Setting

You can check and perform the environment setting function necessary for operating the AC Smart at the Environment Setting menu. The following functions can be set at the Environment Setting menu.

- Check the S/W version information of the AC Smart
- Set and change administrator password
- Set language displayed on screen
- Set screen saver and monitor OFF setting to protect the LCD panel
- Set the alarm to notify the user of error in the unit
- Set the temperature unit (Celsius, Fahrenheit) displayed on screen
- Set system date and time
- Calibrate screen coordinate for touch screen

This section describes how to use the Environment Setting menu to check and set the operating environment of the AC Smart.

Press the tab to select each function of the Environment Setting menu.

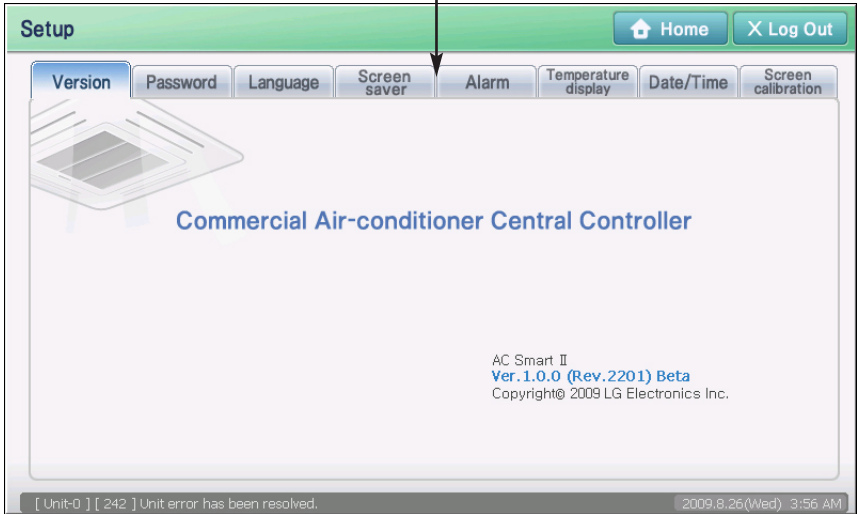

Checking the S/W version information

When you press the Environment Setting menu, you can check the version of the AC SMART II software.

The AC Smart can use the USB memory to upgrade the software. Therefore, the user should be able to check the version of the current software and upgrade the version of the software when necessary.

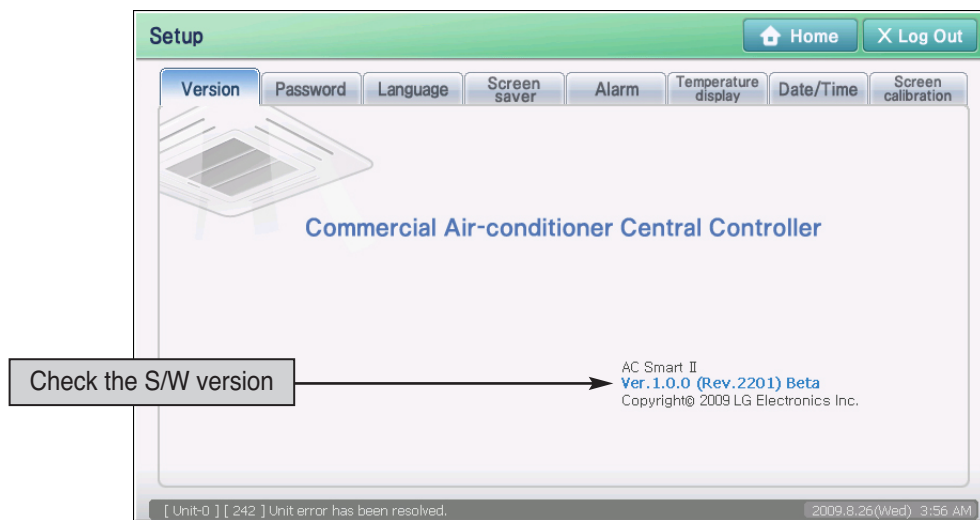

Setting the password

Only the user with the right to access the AC Smart should be able to set and control the AC Smart. Keep the following steps to set a new password.

There are two access levels; Installation access and administrator access. The installation access uses a fixed password. Therefore, you can only set the password for the administrator through this menu.

To set a new administrator password, proceed as follows.

1. When you click on 'Password' tab from the 'Environment Setting' menu, the screen to set the password will be displayed.
Enter the information for each item and press the [Apply] button. For detail description of the entry item, refer to the following table.

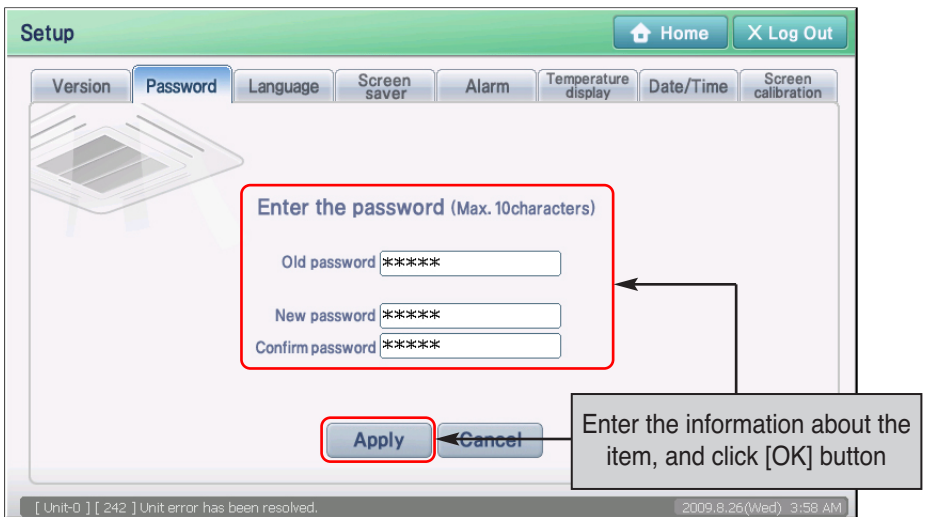

Item	Description
Old password	Enter the password currently set and used.
New password	Enter the new password to use.
Confirm the password	Enter the new password to confirm that the new password is correctly

2. Message to confirm whether to save the changed password will be displayed. Press the [Yes] button.

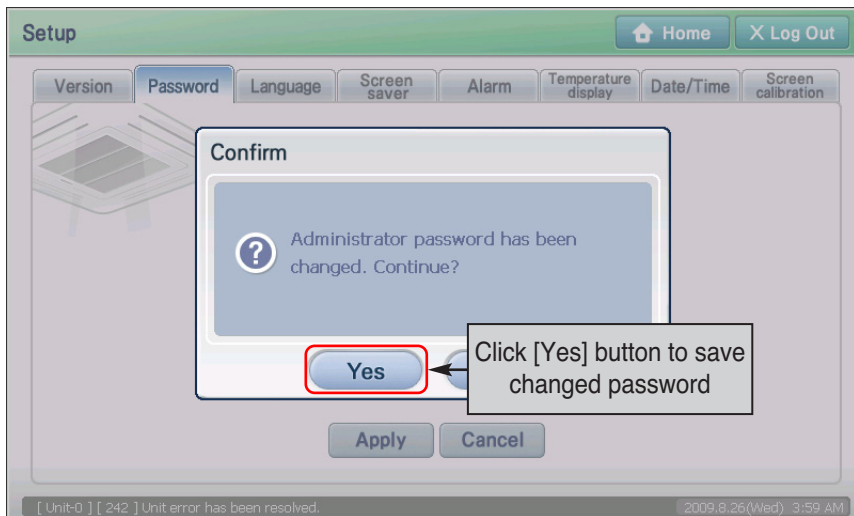

3. The message that the password is changed is displayed. Click [OK] button to finish setting the password.

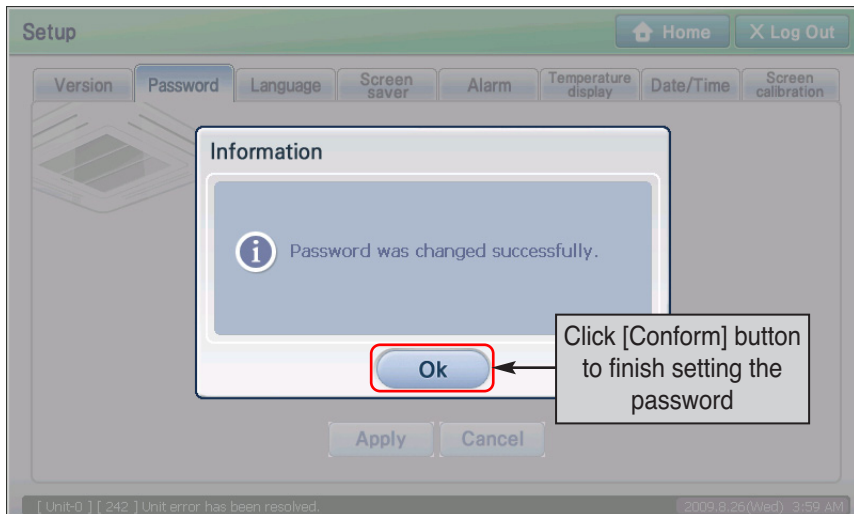

Setting Language by country

AC SMART II supports the two following languages depending on the installed country so that the user can easily understand the setting and control information of the units (Indoor unit, ventilator, On/Off unit).

- Korean, English

When you set the supported language, all menu and message provided through the AC SMART II screen will be displayed in the set language.

To change the language displayed on the screen, proceed as follows.

1. When you press the 'Language' tab from the 'Environment Setting' menu, the screen to set the language will be displayed. Select the language to display and press the [Apply] button.

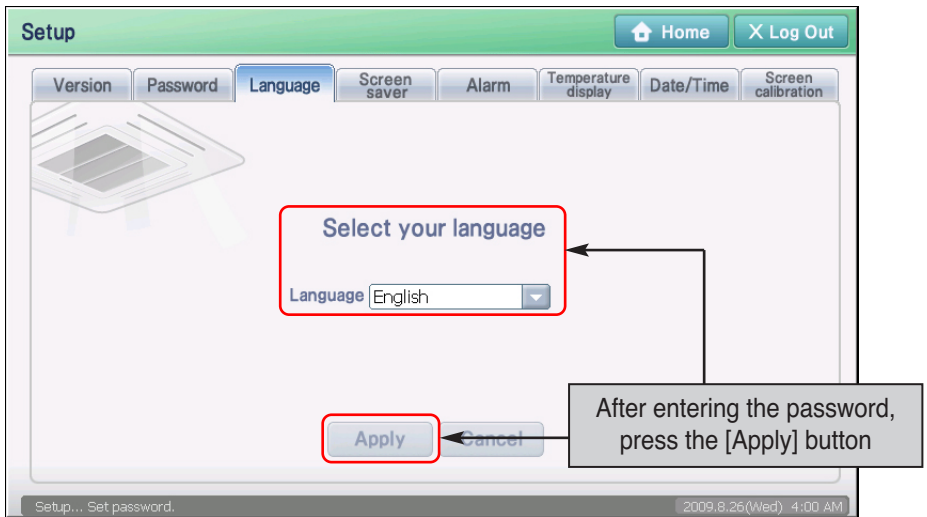

2. To apply the change in the displayed language, you must restart AC SMART II. When you see the message asking to restart, press [Yes] to restart AC SMART II.

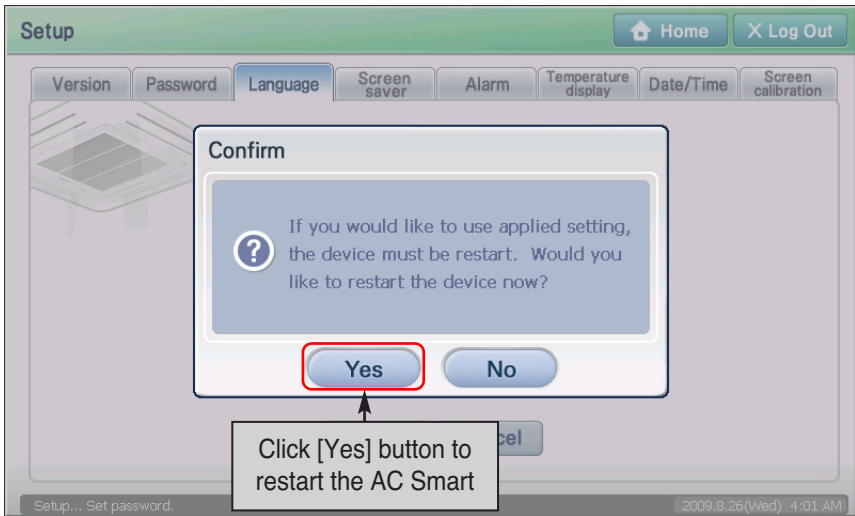

3. After the AC Smart is restarted, the login screen is displayed. The login screen of the said language is displayed according to the language setting.

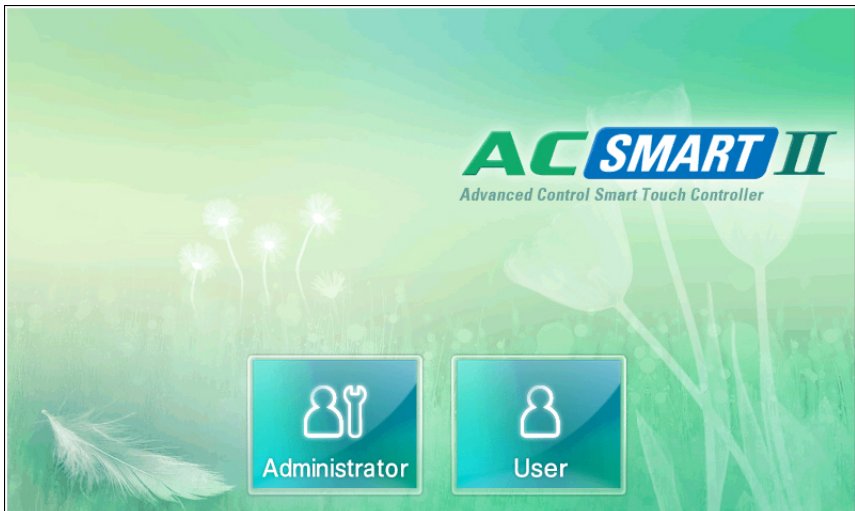

Setting the screen saver

AC SMART II provides a 7 inch LCD panel to display the information.

In the 'Screen saver' tab, you can set the screen saver to protect the LCD panel. Also you can set the LCD to be turned off when there is no entry for a certain period of time to minimize the power consumption.

The screenshot shows the 'Setup' menu with the 'Screen saver' tab selected. The 'Screen saver Setting' panel includes options for 'Enable' (checked) and 'Disable', a 'Screen saver' theme dropdown set to 'Clock', 'Set' and 'Preview' buttons, a 'Wait (Min)' dropdown set to '10', and an 'On screen protection password' checkbox. The 'Monitor power setup' panel includes 'Enable' and 'Disable' radio buttons, and a 'Turn off the monitor (Min)' dropdown. Annotations with arrows point to these specific settings from text boxes:

- Select whether to use the screen saver.** (points to the Enable/Disable radio buttons)
- You can set the screen saver option by the selected theme.** (points to the Screen saver dropdown menu)
- Select whether to use the monitor power OFF function.** (points to the Enable/Disable radio buttons in the Monitor power setup panel)
- Select the theme of the screen saver.** (points to the Screen saver dropdown menu)
- Select the standby time to operate the screen saver.** (points to the Wait (Min) dropdown menu)
- You can set the password on the screen saver to confirm before returning to previous screen.** (points to the On screen protection password checkbox)
- You can preview the selected theme of the screen saver.** (points to the Preview button)
- Select the standby time to turn off the power of the monitor.** (points to the Turn off the monitor (Min) dropdown menu)

To set the screen saver function, proceed as follows.

1. When you press the 'Screen saver' tab from the 'Environment Setting' menu, the screen to set the screen saver will be displayed. Enter the information of each item and press the [Apply] button. For detail description of each item, refer to the following table.

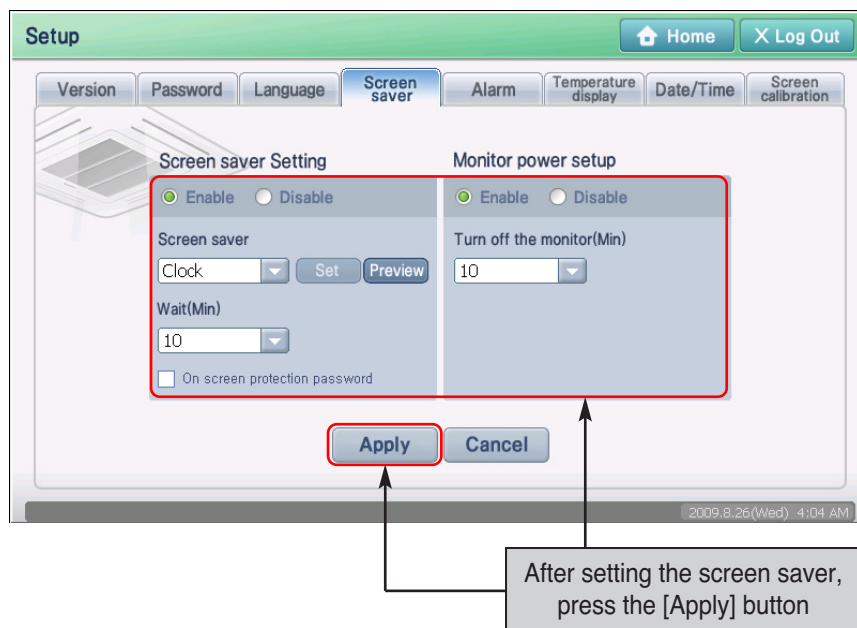

Item	Description
Screen saver setting	<p>You can set the detail item of the screen saver.</p> <ul style="list-style-type: none"> • Use, Do not use: Set whether to use the screen saver. • Screen saver: Select the theme of the screen saver and press the [Set] button. When you press the [Preview] button, you can check the selected screen saver. • [Set] : You can set the screen saver option by the selected theme. You can add or delete the image from the screen saver image list, or set the image changing speed. • [Preview]: You can preview the screen saver of the selected theme. • Standby time: Set the standby time for the screen saver to operate. When there is no entry to AC SMART II for the set time, the screen saver will operate.
Monitor power setting	<p>You can set the power of the LCD panel to be turned off.</p> <ul style="list-style-type: none"> • Use, Do not use: Set whether to use the monitor power setting function. • Monitor OFF wait time: Set the standby time for the LCD panel to be turned off. If there is no entry to AC SMART II for the set standby time, the LCD panel will be turned off.

2. Message to confirm to save the screen saver setting is displayed. Press the [Yes] button to complete the screen saver setting.

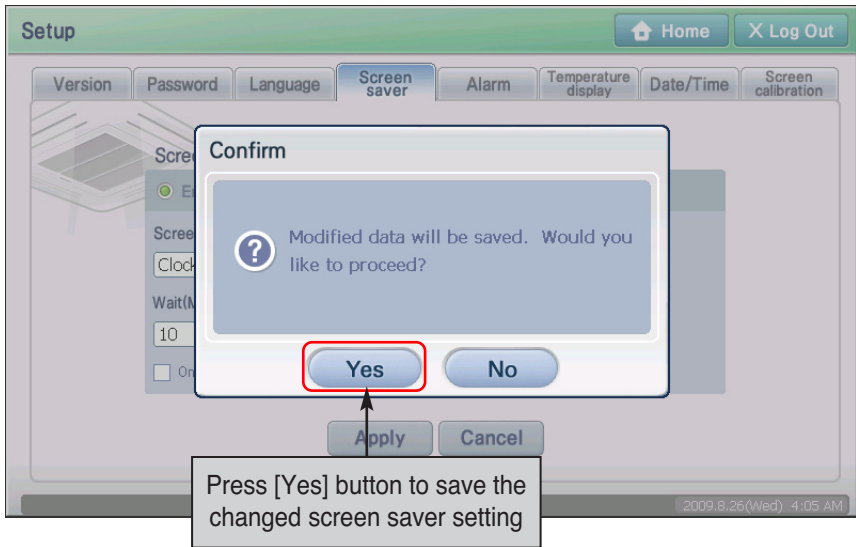

Setting the alarm

In the 'Alarm' tab, you can set the error generated from the unit to be displayed to the user. Also by setting the time to display the alarm, you can set the alarm to be cleared after a certain period of time.

To set the alarm function , proceed as follows.

1. When you press the 'Alarm' tab from the 'Environment Setting' menu, the screen to set the Alarm will be displayed. Enter the information of each item and press the [Apply] button. For detail description of each item, refer to the following table.

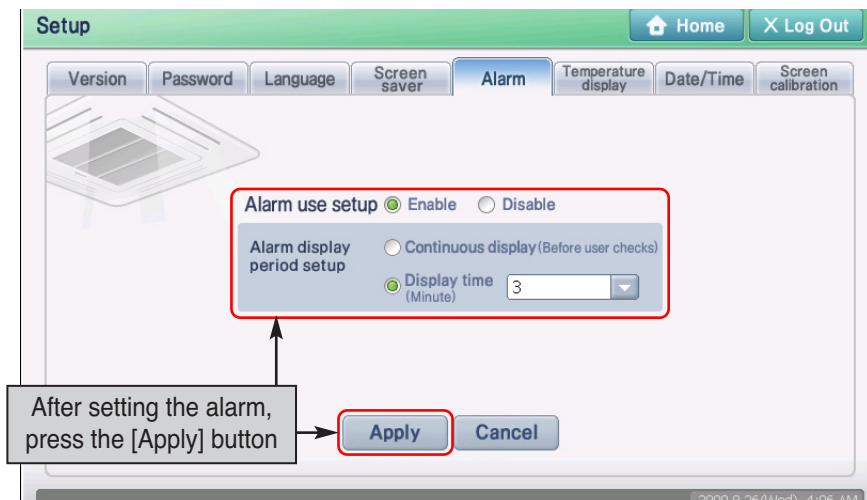

Item	Description
Alarm use setting	You can set whether to use the Alarm function. <ul style="list-style-type: none"> • Use: Set to use the Alarm function • Do not use: Set not to use the Alarm function
Alarm display period setting	You can set the time to display the Alarm. <ul style="list-style-type: none"> • Continuously display: Set to continuously display the Alarm screen • Display time: Set the time so that the Alarm screen clears after a certain period of time (3 min, 5 min, 10 min, 20 min)

2. Message to confirm whether to save the Alarm setting is displayed. Press the [Yes] button to complete the Alarm setting.

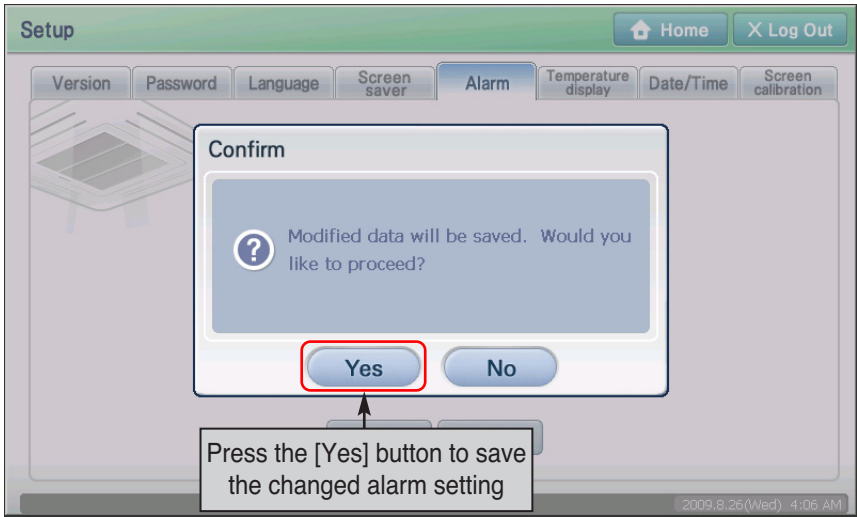

3. In case of an error in the future, the following alarm screen will be displayed.

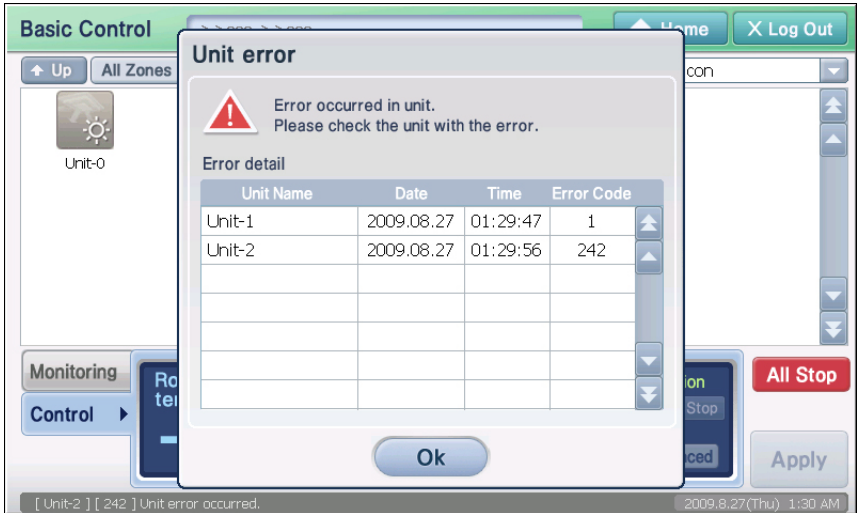

Changing the temperature display

The temperature of AC SMART II is basically displayed in Celsius ($^{\circ}\text{C}$). But the temperature unit (Celsius, Fahrenheit) can be displayed by the country. You can set the temperature unit displayed on AC SMART II from the 'Temperature display' tab.

To set the temperature unit displayed on the screen, proceed as follows.

1. When you press the 'Temperature display' tab from the 'Environment Setting' menu, the screen to set the temperature unit will be displayed. Select the temperature unit to use and press the [Apply] button.

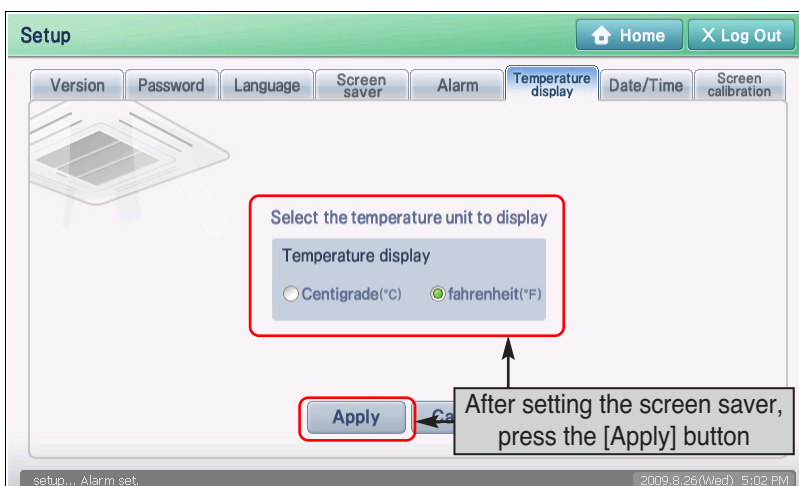

2. To change the displayed temperature, you must restart AC SMART II. When the screen to confirm to restart, press the [Yes] button to restart AC SMART II.

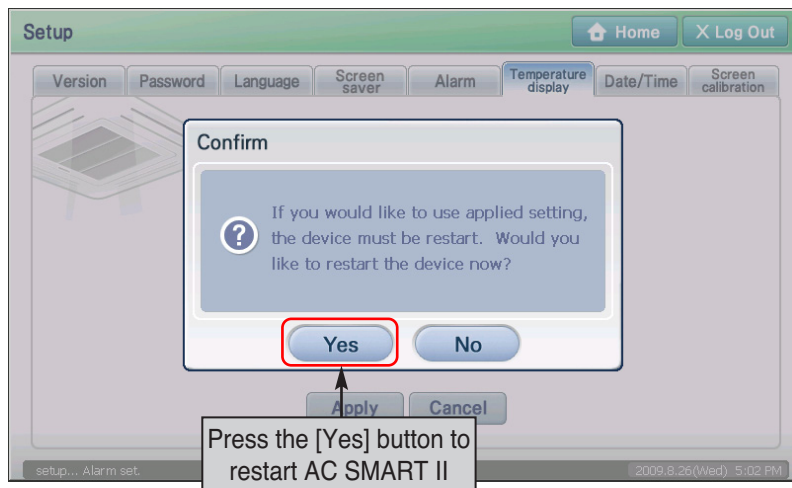

3. After restarting AC SMART II, the log in screen is displayed. Log in to check whether the set temperature unit is displayed on the screen.



Setting the time

The AC Smart needs the correct time setting to drive the air conditioner and the ventilator according to the schedule set by the user or to record the history information about the occurred event. You can set the date and the time for setting and controlling the air conditioner and the ventilator at the time setting.

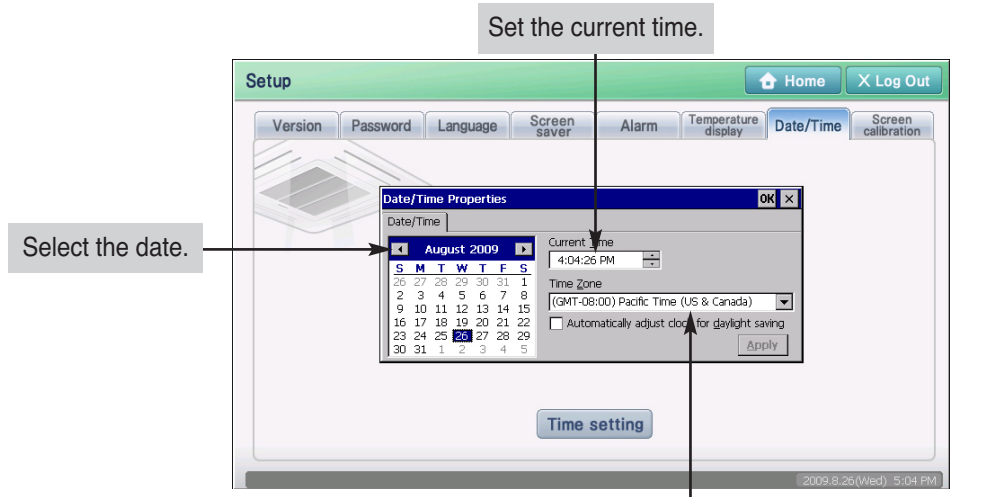

* If you change the date and time, it can affect the schedule, time limit operation and usage statistics function.

Select the time zone of the region where AC SMART II is installed.

Keep the following steps to set the time of the AC Smart system.

1. When you press the 'Date/Time' tab from the 'Environment Setting' menu, the screen to set the time will be displayed. Press the [Time setting] button.



- 'Date/Time properties' screen is displayed. Enter the time information and press the [Apply] button to apply the set time information to AC SMART II. For detail description of each input item, refer to the following table.

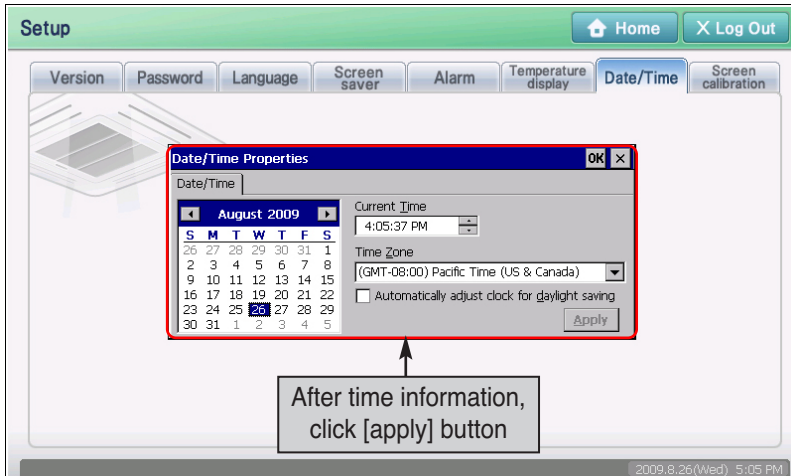

Item	Description
Date	Set the date (year, month, day).
Current time	Select the time (a.m./p.m., hour, minute, second).
Standard time zone	Select the time zone according to the reference area.

- When you press the [OK] button, the time setting will be completed, and the 'Date/Time properties' screen will be closed to return to the previous screen.

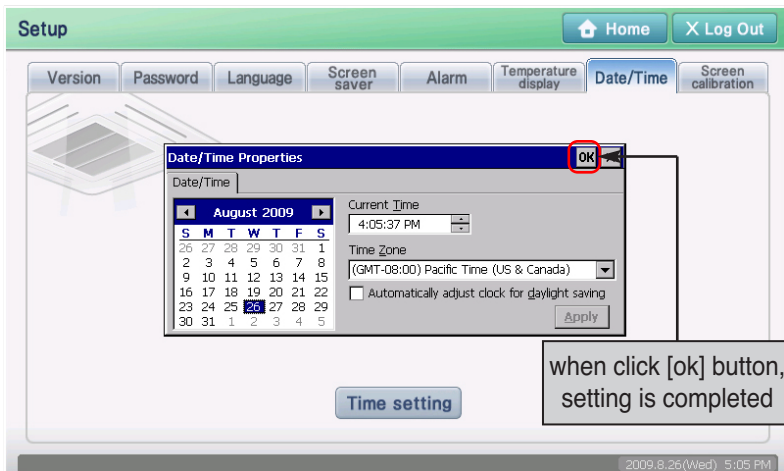

Calibrating the screen

To use AC SMART II, you must set all the information through the touch screen method. If the coordinate that the user is operating is not aligned with the coordinate of the touch screen, AC SMART II may not operate as intended by the user. In this case, you can reset the coordinates through touch screen calibration.

When you press the 'Screen calibration' tab from the Environment Setting menu, you can calibrate the touch screen.

Information: Using the external button of the AC Smart to calibrate the screen

The screen calibration function can be executed by pressing [Backlight] button and [Keyboard] button at once located at the top of the AC Smart. When you cannot perform this menu because of the incorrect screen coordinate, use this method to calibrate the screen.

Keep the following steps to calibrate the screen of the AC Smart.

1. When you press the 'Screen calibration' tab from the 'Environment Setting' menu, the following screen will be displayed. Press the [Screen calibration] button.

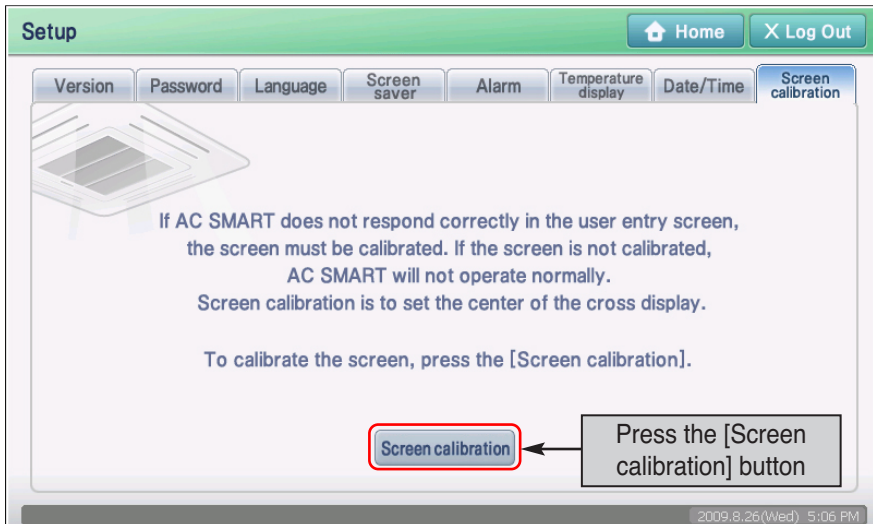

2. 'Stylus properties' screen is displayed. Press the [Re-calibrate] button from the 'Calibration' tab.

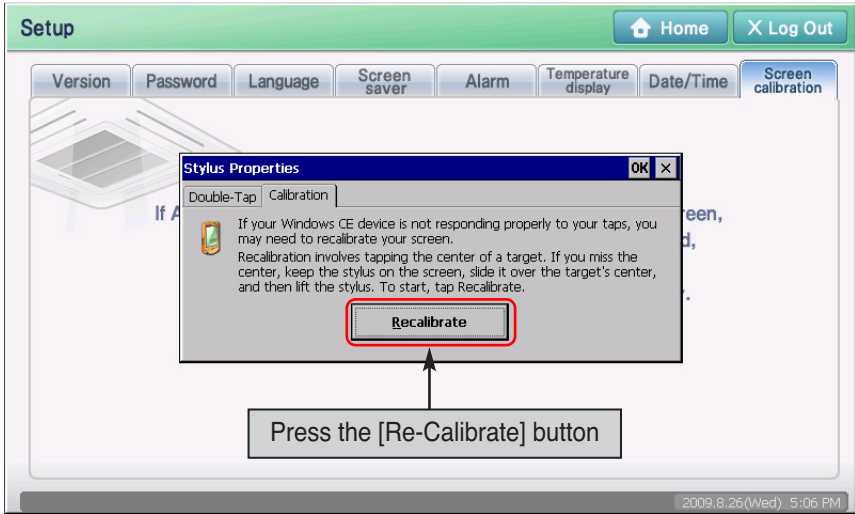

3. The cross symbol is displayed at the center of the screen. Touch the center of the cross with the stylus. Repeat this for top left, top right, bottom left and bottom right cross symbol.

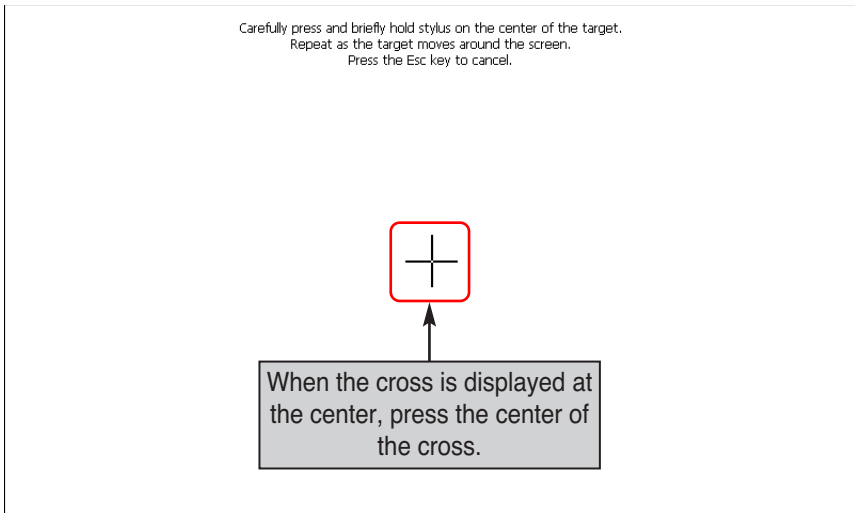

4. When the above procedure is finished, select whether to apply the current screen calibration setting to the system or not. Press the screen with the touch pen to apply it to the system.

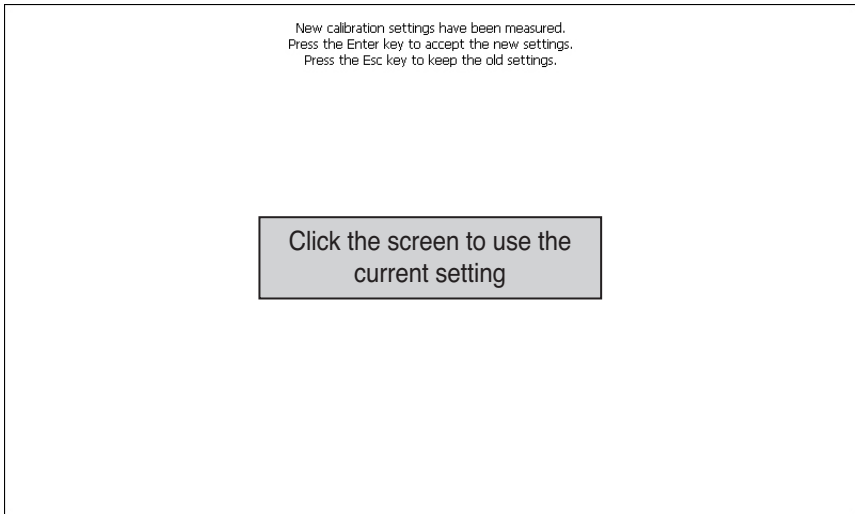

5. Return to the previous 'Stylus properties' screen. Press the [OK] button to end the screen calibration and return to the previous screen.

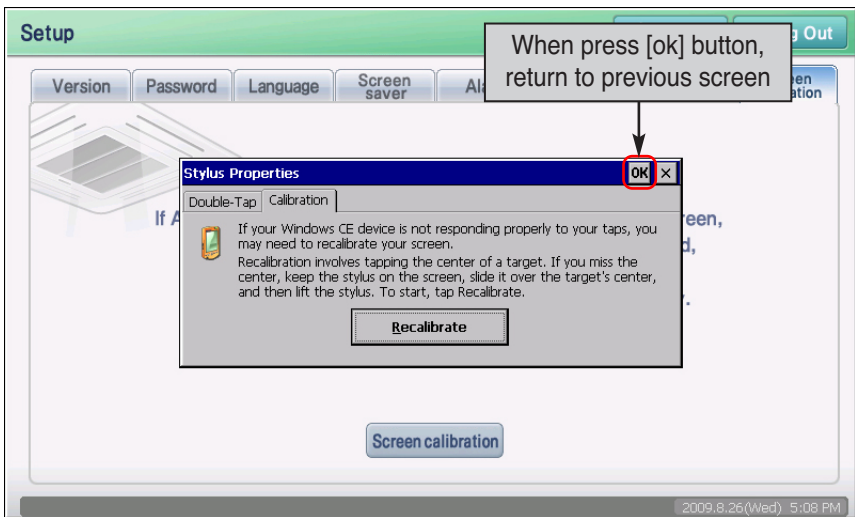

10. Introduction to Advanced Environment setting

With Advanced Environment Setting menu, you can set key function to operate AC SMART II including network, SW upgrade and database backup. The functions that can be set through Advanced Environment Setting are as follows.

- Set network information for web server function and SVCNet connection
- Set email to notify the error to administrator
- Set reference date to accurately calculate the statistical calculations of the operating time
- Set the upgrade to maintain the latest version software
- Backup and restore the database to protect important information

Press the tab to select each function of the environment setting menu.



Reference: Authentication of Advanced Environment Setting menu

Advanced Environment Setting menu can only be used by the installation ID, and the menu will not appear for other access IDs. It is recommended not to use the Advanced Environment Setting as much as possible.

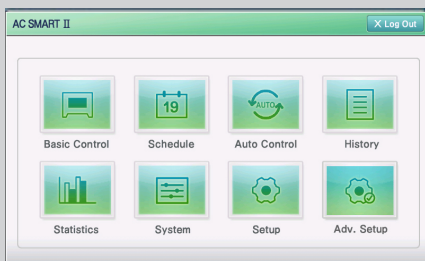

<Menu organization for setup specialist authority log-in>

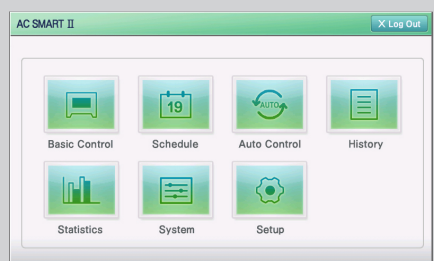

<Menu organization for manager authority log-in>

Setting the network information

The AC Smart can send/receive the information to/from other external systems via the network. The network function can be set at 'Network' for communicating the following external systems.

- SVCNet: Send/receive the history information and the current status information of the unit connected to the AC Smart
- PC Client: Remote client computer for monitoring and controlling the air conditioner by using the web server function of the AC Smart

So, the network setting of the AC Smart consists of the remote service setting for the SVCNet connection and the adapter network setting for the IP setting.

In the 'Network' tab, you can set the remote service and network adapter to communicate with the external system.

Select whether to use the remote service.

Set the network adapter.

Remote service setting Enable Disable

Adapter network setting

Remote service information

Service server address
ikeeper.codns.com

Service server port
80

Update frequency(Min)

Site information

Site address
192.168.55.101

Site name

Site code

Apply Cancel

Login... Service Login. 2009.8.25(Wed) 5:12 PM

Select the service server address, port number and cycle to update the information update for remote service.

Enter the IP address, name and code of the site where AC SMART II is installed.

Setting the remote service

Keep the following steps to set the remote service for accessing the SVCNet.

1. When you press the 'Network' tab from the 'Advanced Environment Setting', the screen to set the remote service will be displayed. Enter the remote service setting information and press the [Apply] button. For detail description of each input item, refer to the following table.

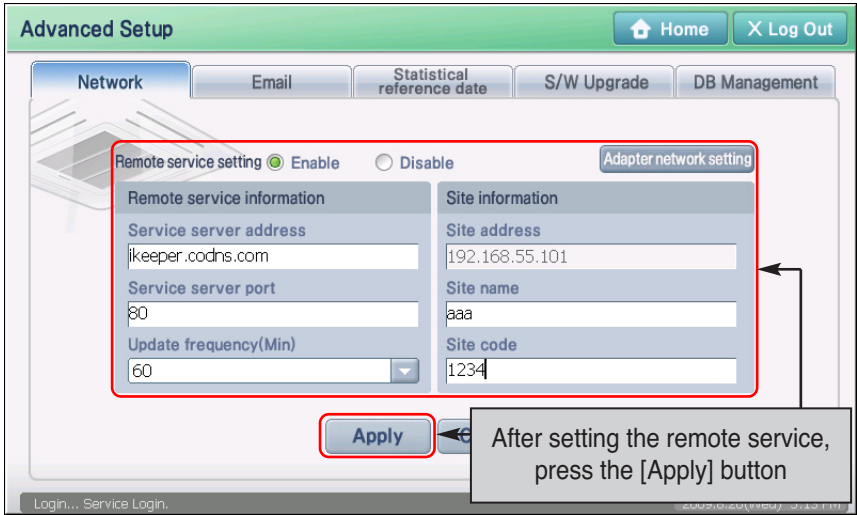

Classification	Item	Description (CHECK SMART)
Remote service setting	Enable, Disable	Select whether to use the function for sending the information of the AC Smart to the SVCNet..
Remote service Information	Service server address	Enter the server address of the SVCNet.
	Service server port	Enter the server port of the SVCNet.
	Update Frequency(Min)	Specify the period to update the information at the SVCNet by minute.
Site Information	Site address	Enter the IP address set at the current AC Smart.
	Site name	Enter the information about the location where the current AC Smart is installed.
	Site code	The code given for managing the field

2. Message confirming that the network setting has been saved will be displayed. Press the [Yes] button to complete the network setting.

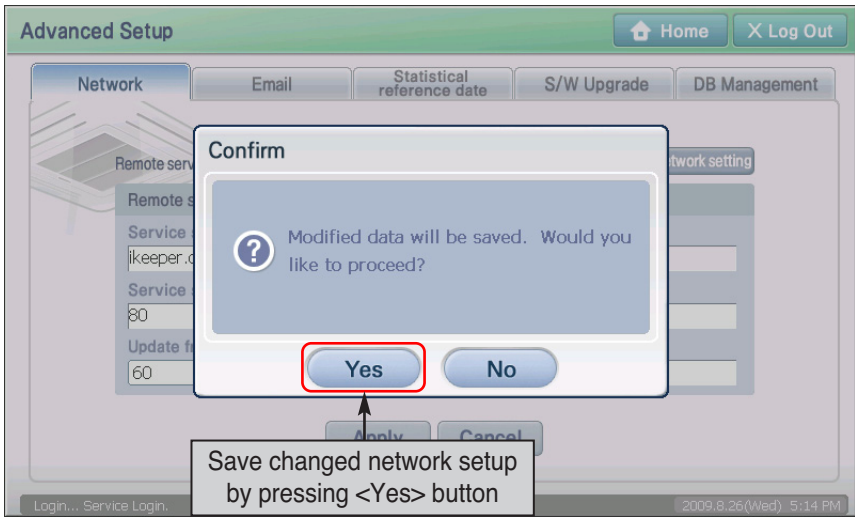

Adapter network setting

To smoothly exchange information with SVCNet or PC Client, the network adapter of AC SMART II (IP address, gateway address, DNS etc.) must be set.

To set the network adapter, proceed as follows.

1. When you select the 'Network' tab from 'Advanced Environment Setting' menu, the screen to set the network will be displayed. Press the [Network adapter setting] button.

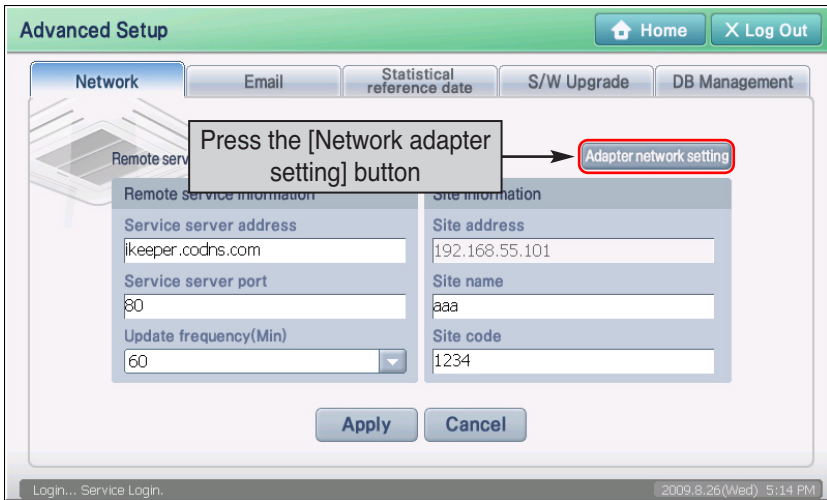

2. It will switch to the screen to set the network adapter information. When you press the 'CS89001' icon twice, the 'CS8900 setting' screen to set the network will be displayed.

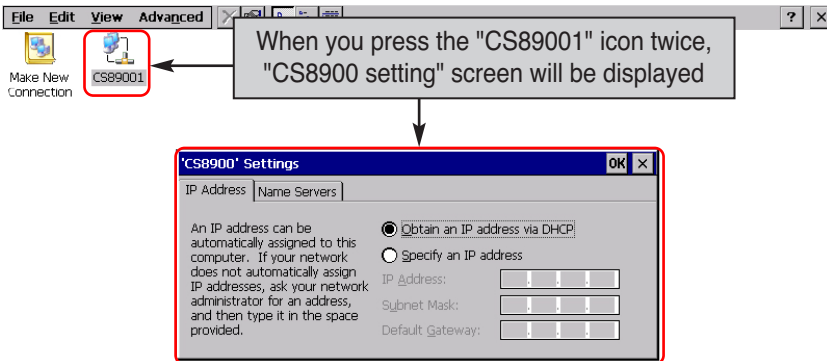

3. Press 'IP address' tab and select whether to get the IP address with the DHCP or to directly enter the IP address. When you directly enter the IP address, enter the additional information as shown at the below table.

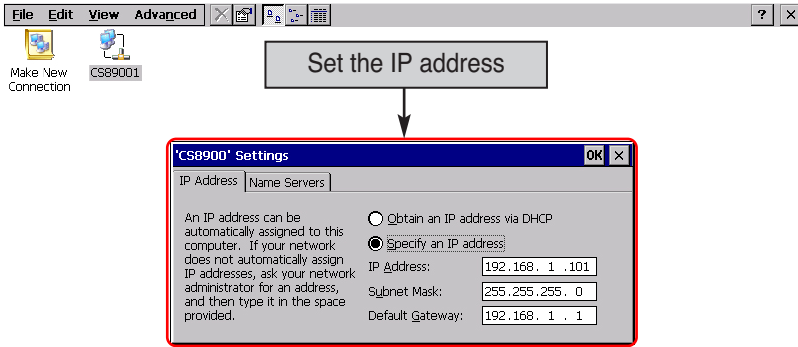

Item	Description
IP Address	Enter the IP address to be set at the AC Smart.
Subnet mask	Enter the subnet mask for the IP address.
Default gateway	Enter the IP address of the gateway.

4. Press 'Name server' tab to select whether to set the IP address of the additional DNS (Domain Name Server). When you enter the IP address of the DNS, enter the additional information as shown at the below table.

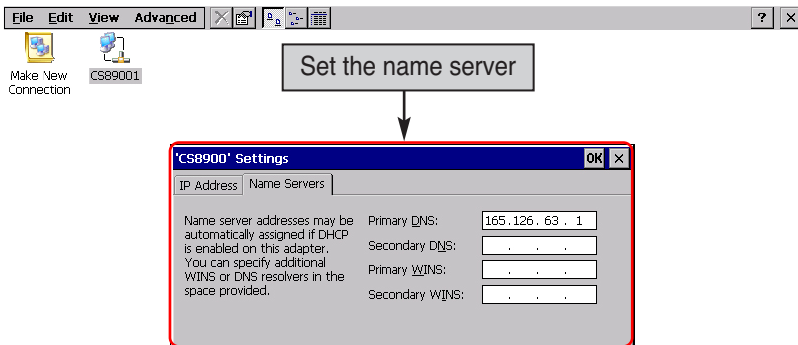

Item	Description
Primary DNS	Enter the IP address of the primary DNS server.
Secondary DNS	Enter the IP address of the secondary DNS server.
Primary WINS	Enter the IP address when the WINS is used.
Secondary WINS	Enter the secondary IP address when the WINS is used.

5. Press [OK] button to apply the current network information setting to the system. 'CS8900 Ethernet Driver setting' screen is ended and it returns to the previous adapter network setting screen. Finally, when you press [X] button at the top right on the screen, setting the adapter network is finished.

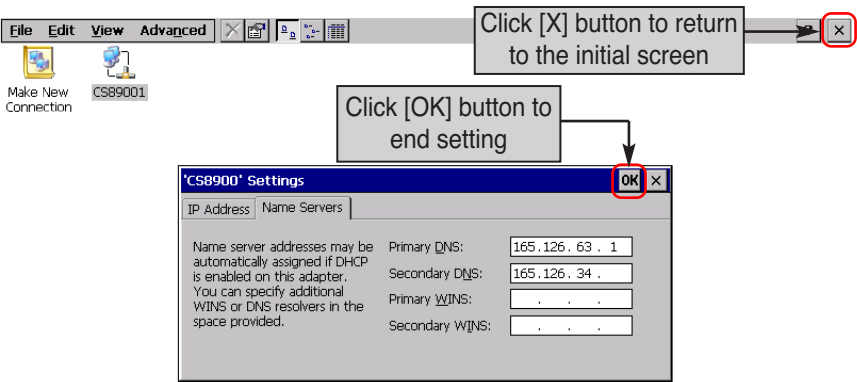

Setting the E-mail

The E-mail notifies the administrator of the critical error information of the AC Smart by the e-mail.

when the administrator is absent. The information about the e-mail to be sent to the user can be set and the account of the e-mail can be set at the 'E-mail' menu.

Select whether to use the email function.

Set the email account.

Enter the email title.

Enter the email address to send to.

Set to have email sent once a day when there is no error.

Set the email transmission frequency (10 min unit) for the error.

Reference: Email error notification

In order to stop receiving the email in error situation, you must resolve the error and maintain the error free condition.

Reference: Email account information

The "Email" screen has dummy values pre-entered to help the user understand with the entry items. But this pre-populated information is only an example and the user must set the email account properly.

Keep the following steps to set e-mail.

1. When you select the 'Email' tab from the 'Advanced Environment Setting' menu, the email setting screen will be displayed. You must first set the account to send the email. Press the [Account management] button.

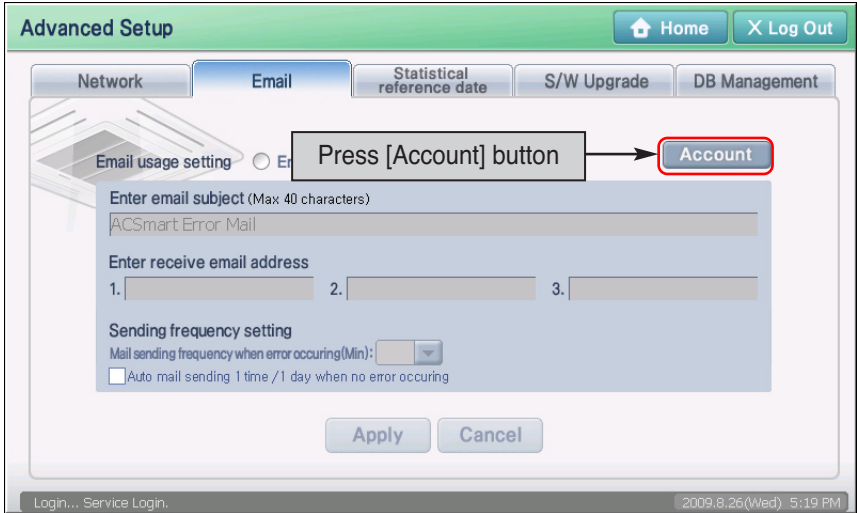

2. When the 'Email account setting' screen is displayed, enter the email account information. For detail description of each setting item, refer to the following table.

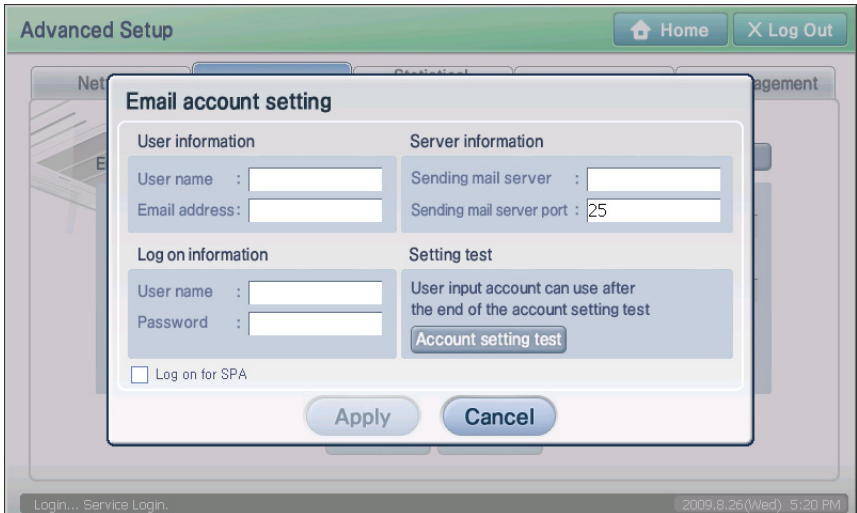

Classification	Item	Description (CHECK SMART)
User Information	User name	Enter the user's name.
	E-mail address	Enter the user's e-mail address.
Server information	Sending mail server Server information (SMTP)	Enter the mail server address.
	Sending mail server port	Enter the mail server port.
Log-on information	User name	Enter the user name for logging into the mail server.
	Password	Enter the password to log into the mail server.
-	Log-on by using the SPA (Security Password Authentication)	When you log in by using the security password authentication, check the said check box.

3. Press [Account setting test] to make sure that the set account is correct. Setting the e-mail account can be finished by passing this test. But for the email account information that has been tested, the [Account setting test] button may not be activated. In this case repeat procedure of 5.

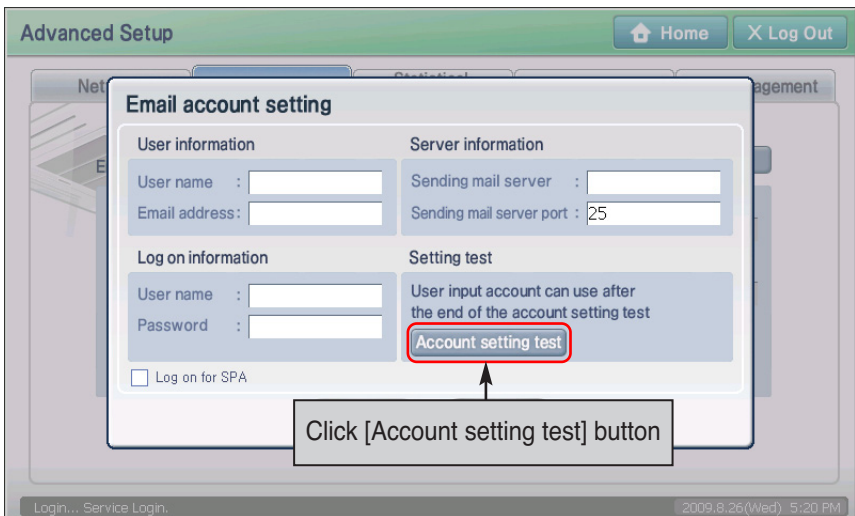

4. When the account setting test is successfully performed, the finish message is displayed. Press [OK] button to end testing.

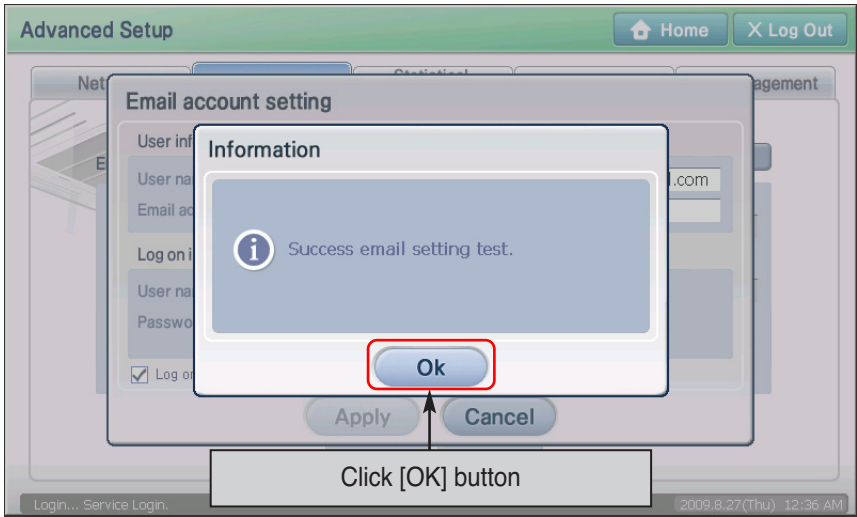

5. When it returns to 'E-mail account setting' screen, press [Apply] button to save the set account information.

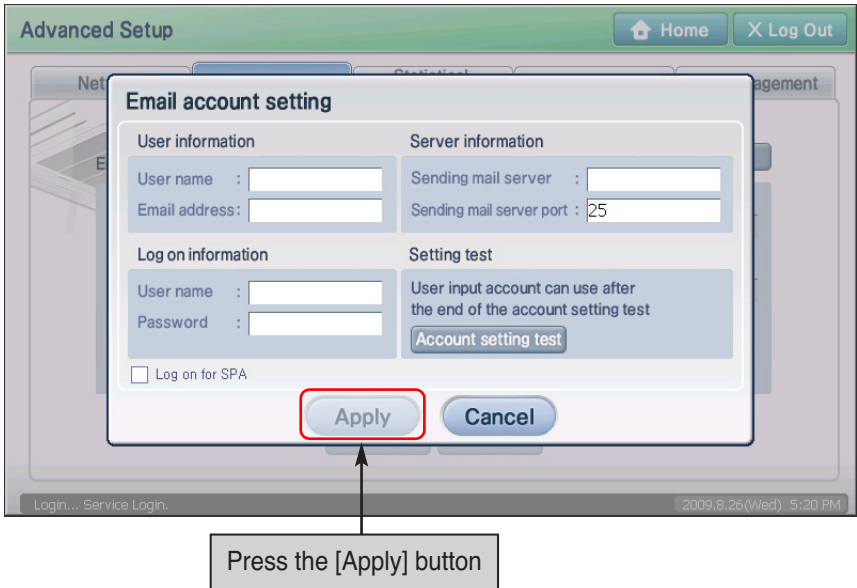

6. Message to confirm to save the changed information is displayed. Press the [Yes] button to save the setting.

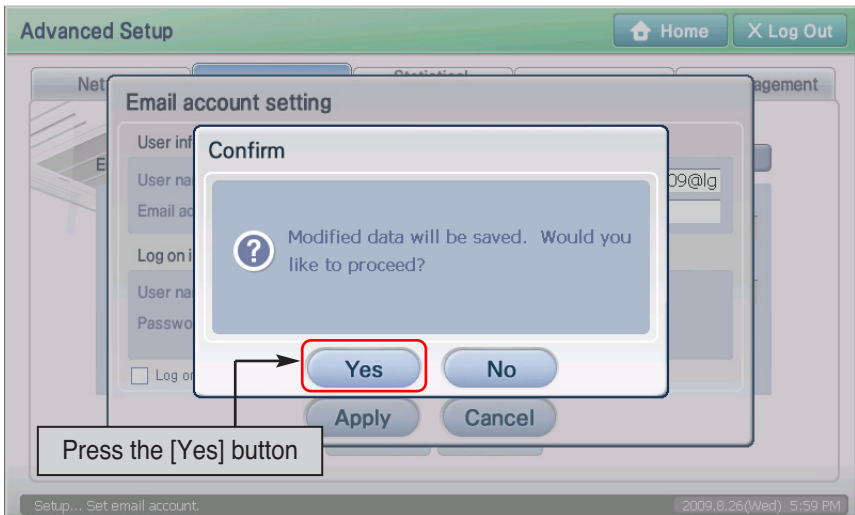

7. When it returns to the email setting screen, enter the email information. For description of each item, refer to the following table.

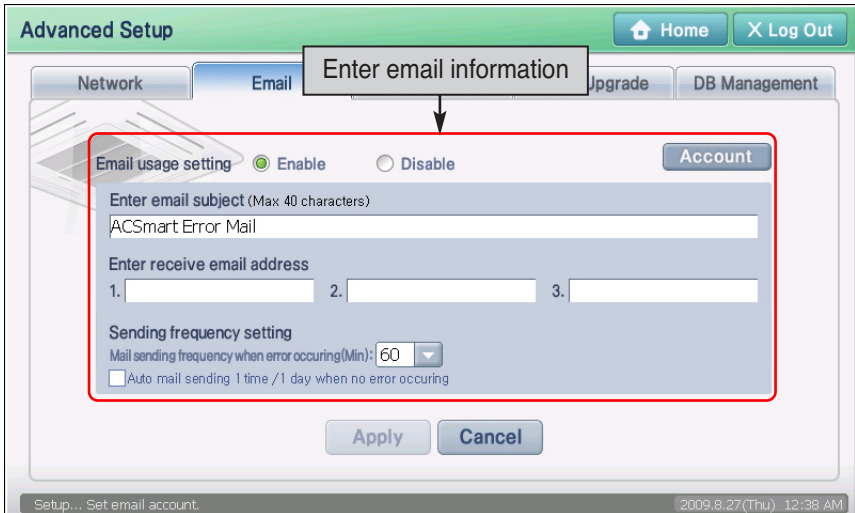

Item	Description
Email usage setting	Set whether to use 'Send the e-mail' function or not.
Enter the e-mail subject	Enter the subject of the e-mail to be sent to the receiver. You can enter it up to 40 characters.
Enter receive Email address	Enter the e-mail address of the recipient to receive the e-mail. Up to three recipients can be set
Sending Frequency/setting	When any error is occurred, the period to send the e-mail can be set within 1 hour by 10 minutes. Also, even when no error is occurred, it can be set to be automatically sent once a day.

8. When the screen returns to the email setting screen, you must save the email information entered. When you press the [Apply] button, screen to confirm to save the email setting will be displayed. When you press the [Yes] button, the email setting will be completed.

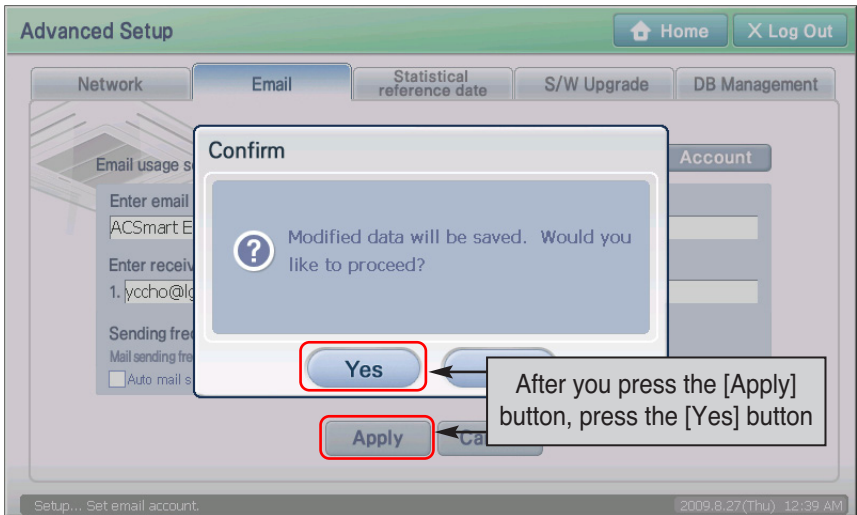

Setting the statistical reference date

Statistical reference date is the date to calculate the operating time of the indoor unit for 1 month. Here the operating time is calculated from the reference date to 1 day prior to the reference date in the following month, and provided as statistical information in the statistical menu.

Reference: Reference date setting range

For the month without the set date, the last day of the month is used as the reference date. For example, when you set the statistical reference date to 30th, the 28th is used as the reference date for February because the 30th does not exist for February..

You can set the reference date to calculate the operating time of the indoor unit from the 'Statistical reference date' tab.

1. When you select 'Statistical reference date' from 'Advanced Environment Setting' menu, the following screen will be displayed.
Enter the statistical reference setting item, and press the [Apply] button. For detail description of each entry item, refer to the following table.

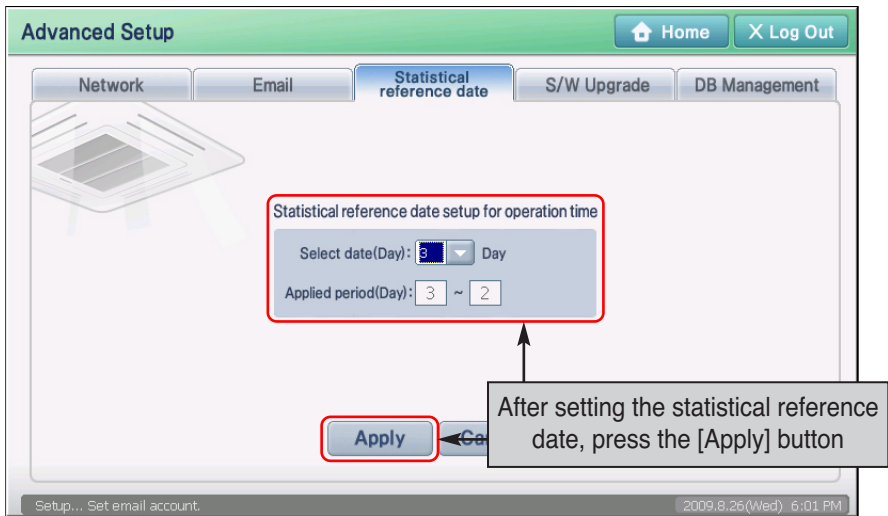

Item	Description
Select date (day)	Set the statistical reference date. You can set from 1st to the 31st.
Applied period (day)	This is not an item you can enter, and shows the statistical start and end date based on the date selected from "Select date".

2. Message to confirm to save the statistical reference date is displayed. Press the [Yes] button.

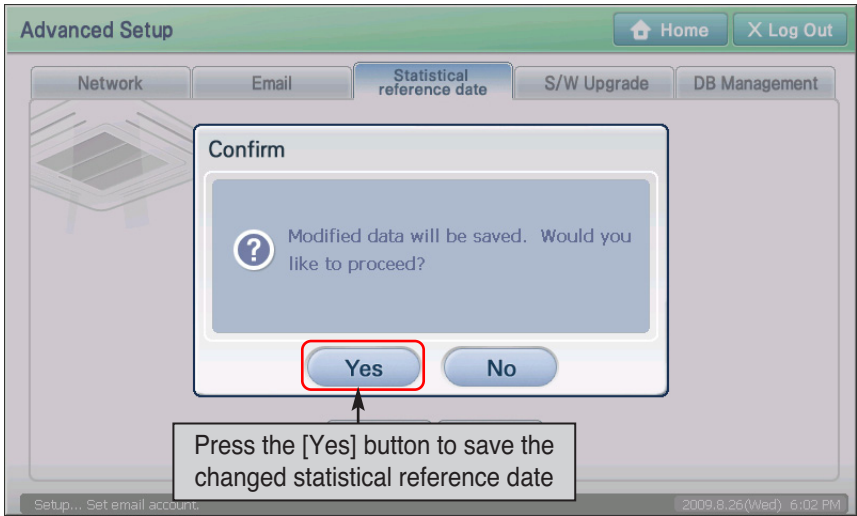

3. Message to ask whether to save the statistical reference date to the current month is displayed. Press the [Yes] button to complete the statistical reference date setting.

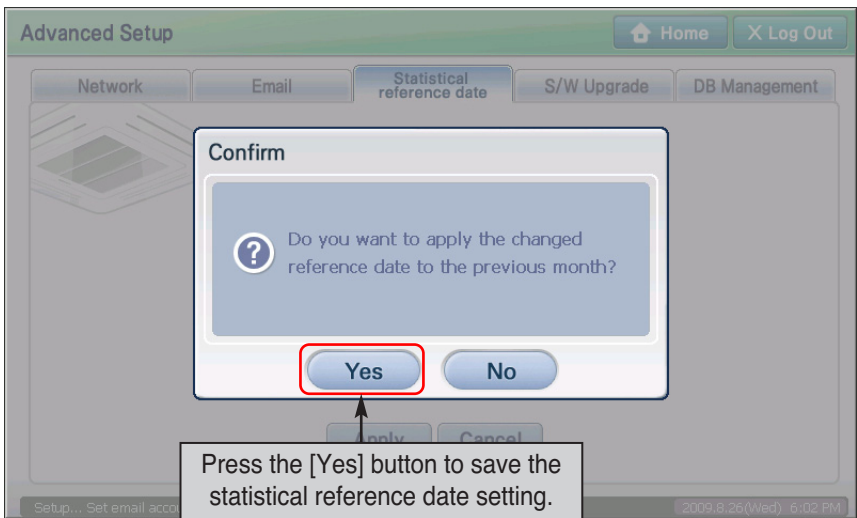

Upgrading the software

The AC Smart can use the USB memory to upgrade the software of the AC Smart. Keep the following steps to upgrade the software of the AC Software.

Note: Before upgrading the software

Before upgrading the software, the left USB port of the AC Smart should be connected to the USB device containing the software update image.

The name of the upgrade file of AC SMART II saved in the USB memory must be "acsmart_firmware.dat".

Keep the following steps to upgrade the software of the AC Smart II Software.

1. When you select the 'S/W upgrade' tab from the 'Advanced Environment Setting' menu, the following setting screen will be displayed.
When the message confirming to restart the AC Smart is displayed, press [Yes] button.

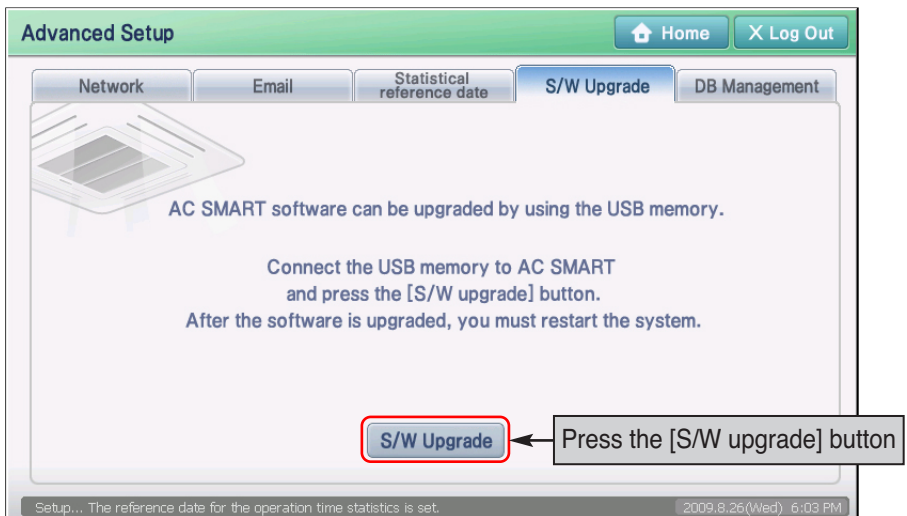

2. The message showing that it takes some time to upgrade the software is displayed. Press [OK] button.

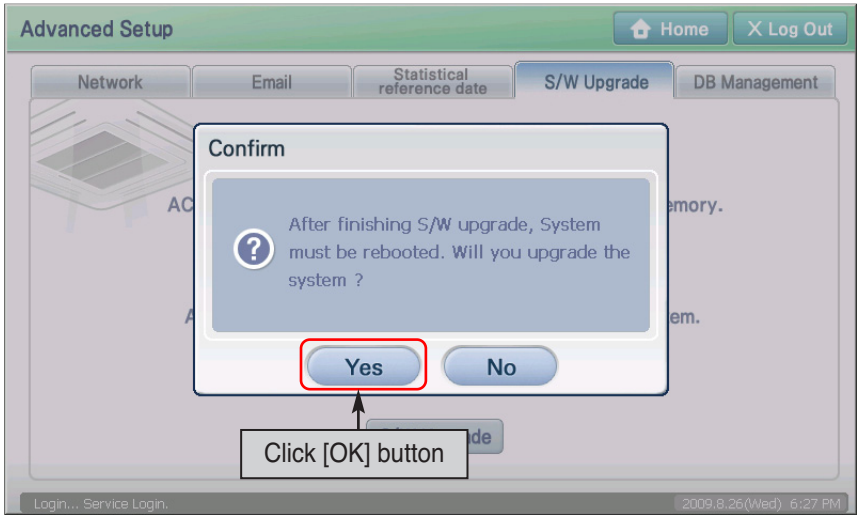

3. Message showing that it requires time to upgrade the software is displayed. Press the [OK] button.

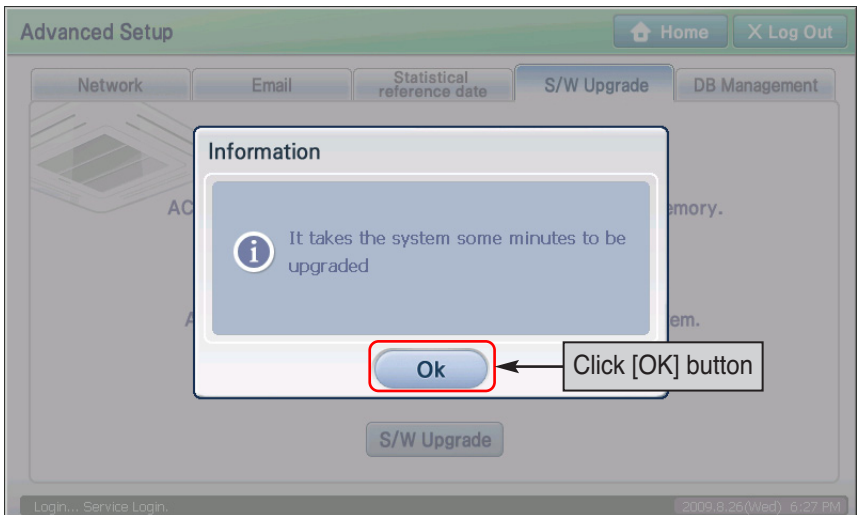

4. Progress of the software update is displayed in percentage.



5. When the procedure of the S/W upgrade is finished, the message showing that the system is to be restarted is displayed. When you press [OK] button, upgrading is ended. And then, the AC Smart is restarted and the Login screen is displayed.

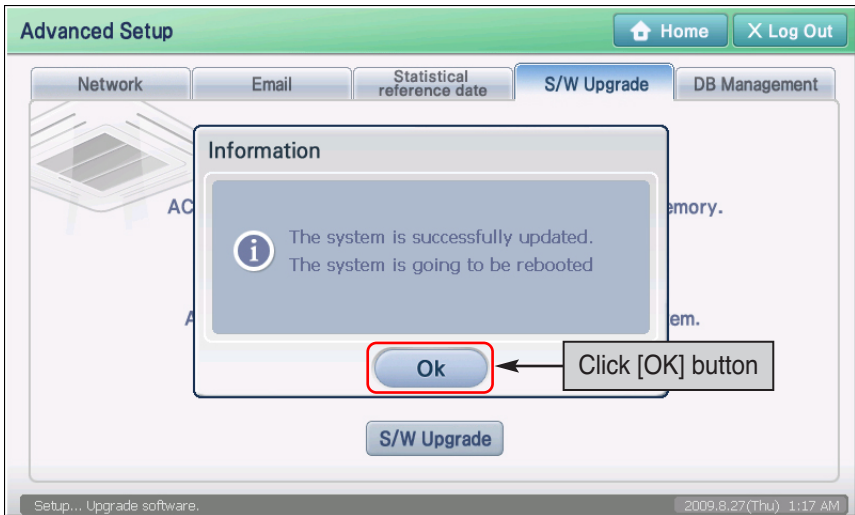

Back up and restoring the database

The AC Smart can back up the critical database to the external USB memory. Also, it can also retrieve the saved database from the external USB memory to restore.

When you press the 'DB' administration tab from the Advanced Environment Setting menu, you can back up key database of AC SMART II to the USB memory (A Type) or restore the database saved in the USB memory to AC SMART II.

Note: Before backing up and restoring the database

Before backing up and restoring the database, the left USB port of the AC Smart should be connected to the USB device containing the database.

After the database is successfully restored, the software of the AC Smart is restarted.

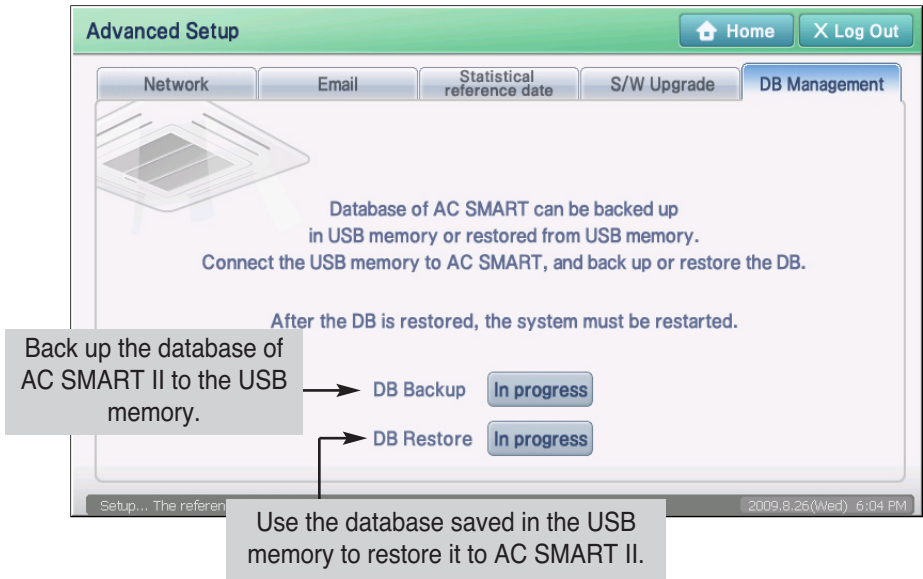

Backing up the database

Keep the following steps to export the database to the USB memory.

1. When you press the 'DB administration' tab from the 'Environment Setting' menu, the following screen will be displayed.
To back up the database, press the [Proceed] button next to the DB back up item.

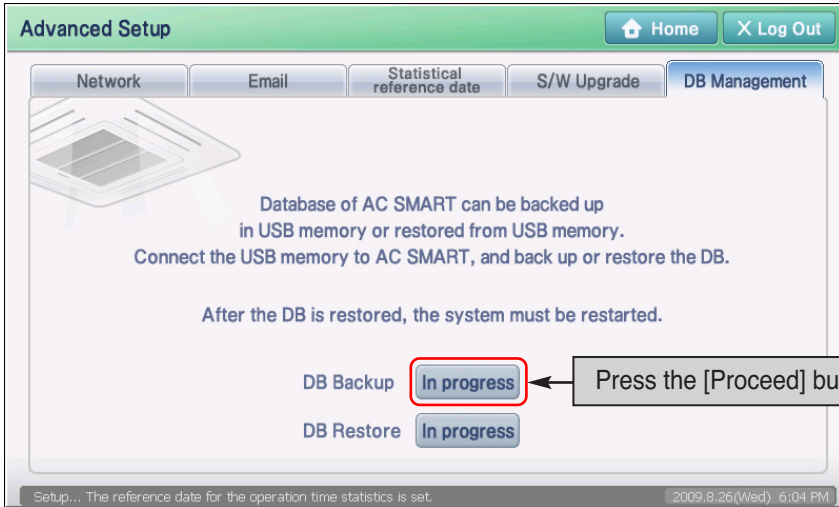

2. When the 'DB Manager' screen to back up the database is displayed, the process to back up the database will automatically proceed. When the backup is completed, the DB Manager screen will be closed to return to the previous screen.

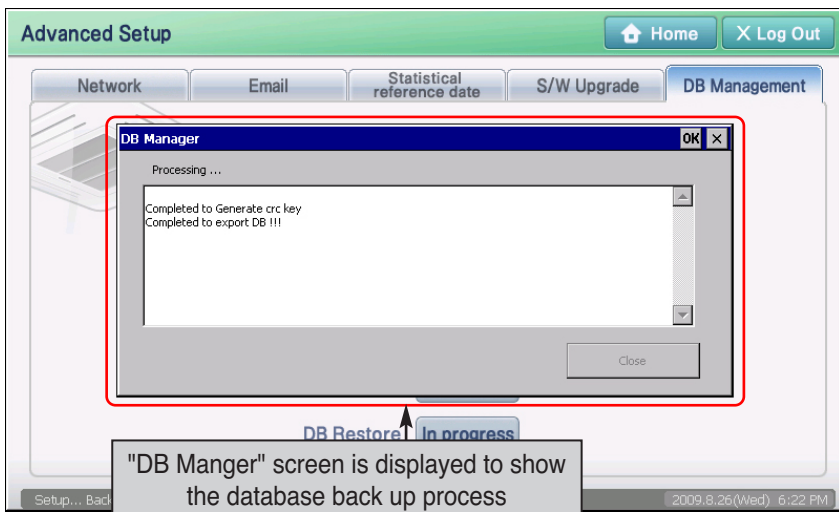

Restoring the database

Keep the following steps to import the database into the AC Smart.

1. When you press the 'DB administration' tab from the 'Environment Setting' menu, the following screen will be displayed.
To restore the database, press the [Proceed] button next to the DB restore item.

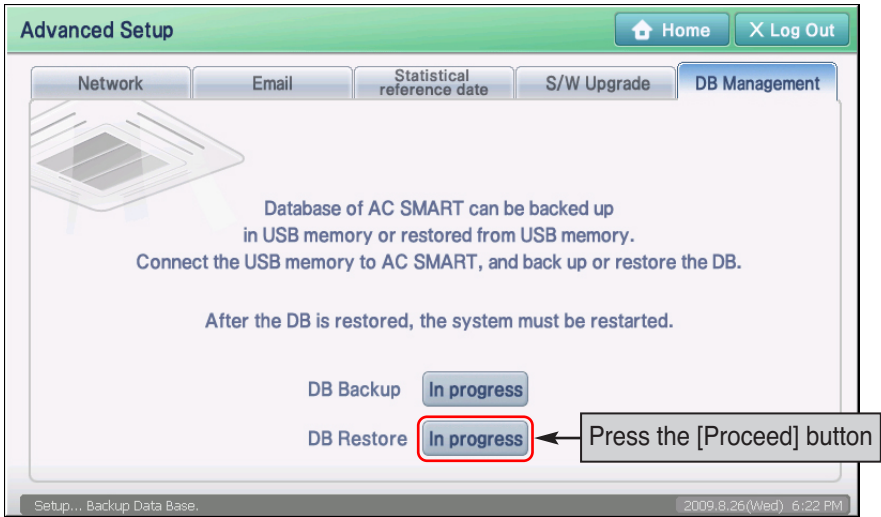

2. 'DB Manager' screen to read the database is displayed, and the screen to confirm to restart the system is also displayed. When you press the [Yes] button, the database restoring process will automatically proceed.

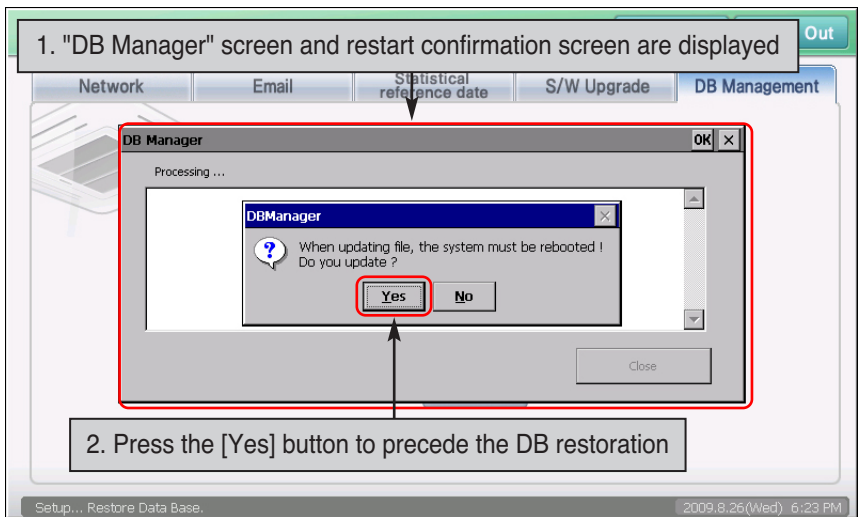

3. When the database is successfully restored, the AC Smart program is restarted and the Login screen is displayed.



11. Introduction to web server function

AC SMART II provides the web server function so that the administrator can connect and control AC SMART II remote by connecting to the network. Through this, the administrator can monitor and control units in other locations (Indoor unit, Ventilator, On/Off unit, AWHP unit). To use the web server function, the network information of AC SMART II must be set.

Reference: Network information setting

The method to set the network information for the web server function of AC SMART II, refer to the °°Network°± section of the °°Advanced Environment Setting°± menu.



Web server log in

To use the web server function of AC SMART II, you must follow the log in process.

In the log in screen, you can set the language (Korean, English) and temperature unit (Celsius, Fahrenheit).

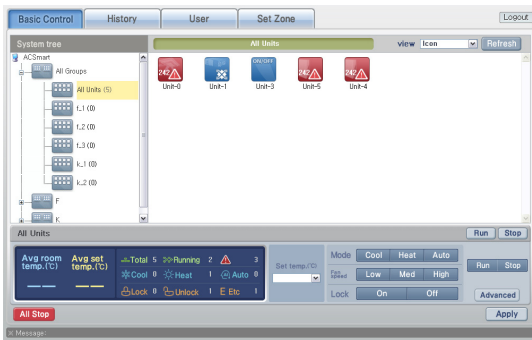

Control/Monitoring menu

"Control/Monitoring" menu is similar to the "Control/Monitoring" menu of AC SMART II. In this menu, you can view the structure of Zone and Group. Also you can check the operating condition of the units in Icon or Table format, and directly control them.

Basic Control | History | User | Set Zone | Logout

View option
 Error (E)
 Status (S)
 Manual event (M)
 Remote operation (R)

Print view
 Previous 1-week (2009.08.30 - 2009.09.06)
 Previous 1-month
 Period view

Search

No.	Date	Time	Code	Name	Message
1	2009-09-06	17:15:04	R	-	[admin] Login. User logged in.
2	2009-09-06	17:15:21	E	Unit-3	[242] Unit error has been resolved.
3	2009-09-06	17:15:20	M	-	System... Unit information is saved successfully.
4	2009-09-06	17:15:20	E	Unit-3	[242] Unit error has been resolved.
5	2009-09-06	17:15:09	E	Unit-3	[242] Unit error has been resolved.
6	2009-09-06	17:15:56	M	-	System... Unit information is saved successfully.
7	2009-09-06	17:15:56	E	Unit-1	[242] Unit error has been resolved.
8	2009-09-06	17:06:16	M	-	System... Unit information is saved successfully.
9	2009-09-06	17:06:02	E	Unit-0	[242] Unit error has been resolved.
10	2009-09-06	17:06:00	E	Unit-1	[242] Unit error has been resolved.
11	2009-09-06	17:03:03	E	Unit-0	[242] Unit error has been resolved.

1 2 3 4 5 6 7 8 9 10 >>>

Message:

Record menu

"Record" menu is similar to the "Record" menu of AC SMART II. In this menu, you can check the unit error and condition information of AC SMART II and the units by period.

Basic Control | History | User | Set Zone | Logout

You can register a new user or edit/delete an existing user.

User ID	Password	Authority	Description	User Login	Set Zone
admin	*	admin	admin	Y	N/A

Selected users:

Message:

User management menu

In the "User management" menu, you can grant or delete access to connect to the web server of AC SMART II to control the units to users other than the administrators.

Basic Control | History | User | Set Zone | Logout

User other than system administrator can be set up to control the device included in a specific zone.

Select the user to set.

Name	Assigned Zone	Unassigned Zone
		F
		K

Message:

Zone setting menu

In the "Zone setting" menu, you can set specific users other than the administrator to control only units included in specific Zone.

Reference: Manual for web server

For detail method on connecting to web server function of AC SMART II and control/monitoring the unit, refer to the manual for AC SMART II web server provided with this manual.

