

INSTALLATION MANUAL

AIR CONDITIONER

- Please read this installation manual completely before installing the product.
- Installation work must be performed in accordance with the national wiring standards by authorized personnel only.
- Please retain this installation manual for future reference after reading it thoroughly.your set and retain it for future reference.

MULTI VTM
WATER II

MODELS : ARWN Series



P/NO : MFL30215315

www.lg.com

TABLE OF CONTENTS

Safety Precautions	3
Installation Process	7
Outside units Information	8
Environment-friendly Alternative Refrigerant R410A	11
Select the Best Location	11
Installation space	12
Water control	14
Lifting method	16
Installation	17
Refrigerant piping installation	21
Device protection unit	26
Refrigerant piping system	28
Y branch pipe and header branch pipe type	45
Leakage test and vacuum	47
Electrical Wiring	49
Test Run	67
Cooling tower applied method	76
Caution For Refrigerant Leak	77
Water Solenoid Valve Control	79
Variable Water Flow Control KIT(Accessory)	80

Safety Precautions



To prevent injury to the user or other people and property damage, the following instructions must be followed.

- Incorrect operation due to ignoring instruction will cause harm or damage. The seriousness is classified by the following indications.

⚠ WARNING This symbol indicates the possibility of death or serious injury.

⚠ CAUTION This symbol indicates the possibility of injury or damage to properties only.

- Meanings of symbols used in this manual are as shown below.

	Be sure not to do.
	Be sure to follow the instruction.

⚠ WARNING

■ Installation

Have all electric work done by a licensed electrician according to "Electric Facility Engineering Standard" and "Interior Wire Regulations" and the instructions given in this manual and always use a special circuit.

- If the power source capacity is inadequate or electric work is performed improperly, electric shock or fire may result.

Ask the dealer or an authorized technician to install the air conditioner.

- Improper installation by the user may result in water leakage, electric shock, or fire.

Always ground the product.

- There is risk of fire or electric shock.

Always install a dedicated circuit and breaker.

- Improper wiring or installation may cause fire or electric shock.

For re-installation of the installed product, always contact a dealer or an Authorized Service Center.

- There is risk of fire, electric shock, explosion, or injury.

Do not install, remove, or re-install the unit by yourself (customer).

- There is risk of fire, electric shock, explosion, or injury.

Do not store or use flammable gas or combustibles near the air conditioner.

- There is risk of fire or failure of product.

Use the correctly rated breaker or fuse.

- There is risk of fire or electric shock.

Do not install the unit at the outdoor.

- Otherwise it may cause fire, electric shock and trouble.

Do not install the product on a defective installation stand.

- It may cause injury, accident, or damage to the product.

Safety Precautions

When installing and moving the air conditioner to another site, do not charge it with a different refrigerant from the refrigerant specified on the unit.

- If a different refrigerant or air is mixed with the original refrigerant, the refrigerant cycle may malfunction and the unit may be damaged.

Do not reconstruct to change the settings of the protection devices.

- If the pressure switch, thermal switch, or other protection device is shorted and operated forcibly, or parts other than those specified by LGE are used, fire or explosion may result.

Ventilate before operating air conditioner when gas leaked out.

- It may cause explosion, fire, and burn.

Securely install the cover of control box and the panel.

- If the cover and panel are not installed securely, dust or water may enter the outside unit and fire or electric shock may result.

If the air conditioner is installed in a small room, measures must be taken to prevent the refrigerant concentration from exceeding the safety limit when the refrigerant leaks.

- Consult the dealer regarding the appropriate measures to prevent the safety limit from being exceeded. Should the refrigerant leak and cause the safety limit to be exceeded, hazards due to lack of oxygen in the room could result.

Use a vacuum pump or Inert (nitrogen) gas when doing leakage test or air purge. Do not compress air or Oxygen and Do not use Flammable gases. Otherwise, it may cause fire or explosion.

- There is the risk of death, injury, fire or explosion.

■ Operation

Do not damage or use an unspecified power cord.

- There is risk of fire, electric shock, explosion, or injury.

Use a dedicated outlet for this appliance.

- There is risk of fire or electrical shock.

Be cautious that water could not enter the product.

- There is risk of fire, electric shock, or product damage.

Do not touch the power switch with wet hands.

- There is risk of fire, electric shock, explosion, or injury.

When the product is soaked (flooded or submerged), contact an Authorized Service Center.

- There is risk of fire or electric shock.

Be cautious not to touch the sharp edges when installing.

- It may cause injury.

Take care to ensure that nobody could step on or fall onto the outside unit.

- This could result in personal injury and product damage.

Do not open the inlet grille of the product during operation. (Do not touch the electrostatic filter, if the unit is so equipped.)

- There is risk of physical injury, electric shock, or product failure.

 **CAUTION**
■ Installation

Always check for gas (refrigerant) leakage after installation or repair of product.

- Low refrigerant levels may cause failure of product.

Keep level even when installing the product.

- To avoid vibration or water leakage.

Use power cables of sufficient current carrying capacity and rating.

- Cables that are too small may leak, generate heat, and cause a fire.

Keep the unit away from children. The heat exchanger is very sharp.

- It can cause the injury, such as cutting the finger. Also the damaged fin may result in degradation of capacity.

Do not install the product where the noise or hot air from the outside unit could damage the neighborhoods.

- It may cause a problem for your neighbors.

Do not install the unit where combustible gas may leak.

- If the gas leaks and accumulates around the unit, an explosion may result.

Do not use the product for special purposes, such as preserving foods, works of art, etc. It is a consumer air conditioner, not a precision refrigeration system.

- There is risk of damage or loss of property.

When installing the unit in a hospital, communication station, or similar place, provide sufficient protection against noise.

- The inverter equipment, private power generator, high-frequency medical equipment, or radio communication equipment may cause the air conditioner to operate erroneously, or fail to operate. On the other hand, the air conditioner may affect such equipment by creating noise that disturbs medical treatment or image broadcasting.

■ Operation

Do not use the air conditioner in special environments.

- Oil, steam, sulfuric smoke, etc. can significantly reduce the performance of the air conditioner or damage its parts.

Do not block the inlet or outlet.

- It may cause failure of appliance or accident.

Make the connections securely so that the outside force of the cable may not be applied to the terminals.

- Inadequate connection and fastening may generate heat and cause a fire.

Be sure the installation area does not deteriorate with age.

- If the base collapses, the air conditioner could fall with it, causing property damage, product failure, or personal injury.

Install and insulate the drain hose to ensure that water is drained away properly based on the installation manual.

- A bad connection may cause water leakage.

Be very careful about product transportation.

- Only one person should not carry the product if it weighs more than 20 kg.
- Some products use PP bands for packaging. Do not use any PP bands for a means of transportation. It is dangerous.
- Do not touch the heat exchanger fins. Doing so may cut your fingers.
- When transporting the outside unit, suspending it at the specified positions on the unit base. Also support the outside unit at four points so that it cannot slip sideways.

Safely dispose of the packing materials.

- Packing materials, such as nails and other metal or wooden parts, may cause stabs or other injuries.
- Tear apart and throw away plastic packaging bags so that children may not play with them. If children play with a plastic bag which was not torn apart, they face the risk of suffocation.

Turn on the power at least 6 hours before starting operation.

- Starting operation immediately after turning on the main power switch can result in severe damage to internal parts. Keep the power switch turned on during the operational season.

Do not touch any of the refrigerant piping during and after operation.

- It can cause a burn or frostbite.

Do not operate the air conditioner with the panels or guards removed.

- Rotating, hot, or high-voltage parts can cause injuries.

Do not directly turn off the main power switch after stopping operation.

- Wait at least 5 minutes before turning off the main power switch. Otherwise it may result in water leakage or other problems.

Auto-addressing should be done in condition of connecting the power of all indoor and outdoor units. Auto-addressing should also be done in case of changing the indoor unit PCB.

Use a firm stool or ladder when cleaning or maintaining the air conditioner.

- Be careful and avoid personal injury.

Installation Process

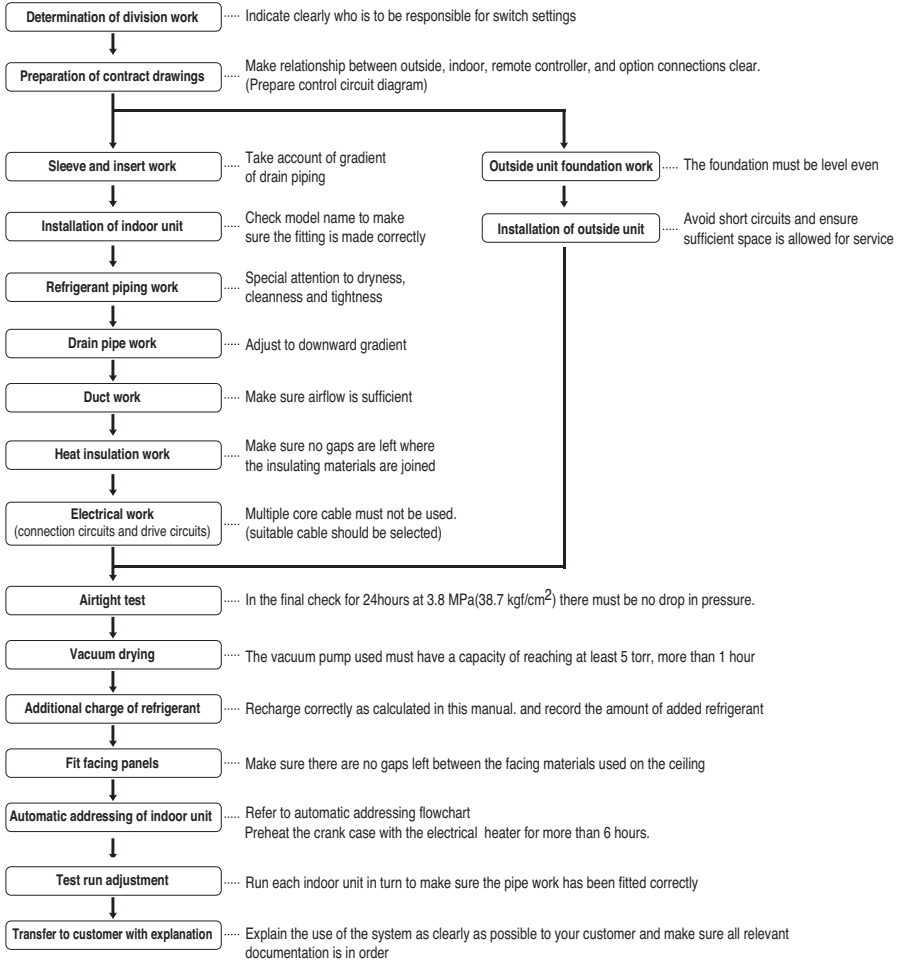

⚠ CAUTION

- The above list indicates the order in which the individual work operations are normally carried out but this order may be varied where local conditions warrants such change.
- The wall thickness of the piping should comply with the relevant local and national regulations for the designed pressure 3.8MPa.
- Since R410A is a mixed refrigerant, the required additional refrigerant must be charged in its liquid state.(If the refrigerant is charged in its gaseous state, its composition changes and the system will not work properly.)

Outside units Information

⚠ CAUTION

- Ratio of the running Indoor Units to the Outside: Within 10 ~ 100%
- A combination operation over 100% cause to reduce each indoor unit capacity.

■ Combination Ratio(50~200%)

Outside Number	Connection Capacity
Single outside units	200%
Double outside units	160%
Triple outside units	130%

Notes:

* We can guarantee the operation only within 130% Combination. If you want to connect more than 130% combination, please contact us and discuss the requirement like below.

- 1) If the operation of indoor unit is more than 130%, low airflow operation is recommended in all the indoor units.
- 2) If the operation of indoor unit is more than 130%, additional refrigerant is needed according to the Aheadquarter guidance.
- 3) Over 130%, capacity is same as capacity of 130%, Same remark is valid for power input.

Power Supply: Outside Unit (3Ø, 380 ~ 415V, 50/60Hz)

■ Heat pump

Unit		1 Unit				
System(HP)		8	10	16	18	20
Model		ARWN80LA2	ARWN100LA2	ARWN160LA2	ARWN180LA2	ARWN200LA2
		ARWN80LA2	ARWN100LA2	ARWN160LA2	ARWN180LA2	ARWN200LA2
Product Charge	kg	7.3	7.3	8.8	8.8	8.8
CF(Correction Factor)	kg	0	0	0	0	0
Max. Connectable No. of Indoor Units		13	16	26	29	32
Net Weight	kg	154	154	223	223	223
Dimension(Wx H x D)		mm	772 x 1,120 x 547	772 x 1,120 x 547	772 x 1,120 x 547	772 x 1,120 x 547
		inch	30.4 x 44.1 x 21.5	30.4 x 44.1 x 21.5	30.4 x 44.1 x 21.5	30.4 x 44.1 x 21.5
Refrigerant	Liquid(mm/inch)	9.52(3/8)	9.52(3/8)	12.7(1/2)	12.7(1/2)	12.7(1/2)
Connecting Pipes		Gas(mm/inch)		28.58(1 1/8)		28.58(1 1/8)
Water Connecting Pipes		Inlet	PT32A (internal thread)	PT32A (internal thread)	PT40A (internal thread)	PT40A (internal thread)
		Outlet	PT32A (internal thread)	PT32A (internal thread)	PT40A (internal thread)	PT40A (internal thread)
		Drain Outlet	20mm (internal thread)	20mm (internal thread)	20mm (internal thread)	20mm (internal thread)
Range of Operation		Cooling(°C)	10 ~ 45	10 ~ 45	10 ~ 45	10 ~ 45
Water Temp.		Heating(°C)	10 ~ 45	10 ~ 45	10 ~ 45	10 ~ 45

Unit		2 Unit			
System(HP)		24	26	28	30
Model		ARWN240LA2	ARWN260LA2	ARWN280LA2	ARWN300LA2
		ARWN160LA2	ARWN180LA2	ARWN180LA2	ARWN200LA2
		ARWN80LA2	ARWN100LA2	ARWN100LA2	ARWN100LA2
Product Charge	kg	7.3+8.8	7.3+8.8	7.3+8.8	7.3+8.8
CF(Correction Factor)	kg	0	0	0	0
Max. Connectable No. of Indoor Units		39	42	45	48
Net Weight	kg	154+223	154+223	154+223	154+223
Dimension(Wx H x D)		mm	(772 x 1,120 x 547) x 2	(772 x 1,120 x 547) x 2	(772 x 1,120 x 547) x 2
		inch	(30.4 x 44.1 x 21.5) x 2	(30.4 x 44.1 x 21.5) x 2	(30.4 x 44.1 x 21.5) x 2
Refrigerant	Liquid(mm/inch)	19.05(3/4)	19.05(3/4)	19.05(3/4)	19.05(3/4)
Connecting Pipes		Gas(mm/inch)		34.9(1 3/8)	
Water Connecting Pipes		Inlet	PT32A + PT40A (internal thread)	PT32A + PT40A (internal thread)	PT32A + PT40A (internal thread)
		Outlet	PT32A + PT40A (internal thread)	PT32A + PT40A (internal thread)	PT32A + PT40A (internal thread)
		Drain Outlet	20mm (internal thread)	20mm (internal thread)	20mm (internal thread)
Range of Operation		Cooling(°C)	10 ~ 45	10 ~ 45	10 ~ 45
Water Temp.		Heating(°C)	10 ~ 45	10 ~ 45	10 ~ 45

Unit		2 Unit		
System(HP)		32	34	36
Model		ARWN320LA2	ARWN340LA2	ARWN360LA2
		ARWN160LA2	ARWN180LA2	ARWN180LA2
		ARWN160LA2	ARWN160LA2	ARWN180LA2
Product Charge	kg	8.8+8.8	8.8+8.8	8.8+8.8
CF(Correction Factor)	kg	0	0	0
Max. Connectable No. of Indoor Units		52	55	58
Net Weight		223+223	223+223	223+223
Dimension(Wx H x D)		mm	(772 x 1,120 x 547) x 2	(772 x 1,120 x 547) x 2
		inch	(30.4 x 44.1 x 21.5) x 2	(30.4 x 44.1 x 21.5) x 2
Refrigerant	Liquid(mm/inch)	19.05(3/4)	19.05(3/4)	19.05(3/4)
Connecting Pipes	Gas(mm/inch)	41.3(1 5/8)	41.3(1 5/8)	41.3(1 5/8)
Water Connecting Pipes		Inlet	PT40A + PT40A (internal thread)	PT40A + PT40A (internal thread)
		Outlet	PT40A + PT40A (internal thread)	PT40A + PT40A (internal thread)
		Drain Outlet	20mm (internal thread)	20mm (internal thread)
Range of Operation	Cooling(°C)	10 ~ 45	10 ~ 45	10 ~ 45
Water Temp.	Heating(°C)	10 ~ 45	10 ~ 45	10 ~ 45

Unit		2 Unit	
System(HP)		38	40
Model		ARWN380LA2	ARWN400LA2
		ARWN200LA2	ARWN200LA2
		ARWN180LA2	ARWN200LA2
Product Charge	kg	8.8+8.8	8.8+8.8
CF(Correction Factor)	kg	0	0
Max. Connectable No. of Indoor Units		61	64
Net Weight		223+223	223+223
Dimension(Wx H x D)		mm	(772 x 1,120 x 547) x 2
		inch	(30.4 x 44.1 x 21.5) x 2
Refrigerant	Liquid(mm/inch)	19.05(3/4)	19.05(3/4)
Connecting Pipes	Gas(mm/inch)	41.3(1 5/8)	41.3(1 5/8)
Water Connecting Pipes		Inlet	PT40A + PT40A (internal thread)
		Outlet	PT40A + PT40A (internal thread)
		Drain Outlet	20mm (internal thread)
Range of Operation	Cooling(°C)	10 ~ 45	10 ~ 45
Water Temp.	Heating(°C)	10 ~ 45	10 ~ 45

Unit		3 Unit		
System(HP)		42	44	46
Model		ARWN420LA2	ARWN440LA2	ARWN460LA2
		ARWN160LA2	ARWN180LA2	ARWN180LA2
		ARWN160LA2	ARWN160LA2	ARWN180LA2
		ARWN100LA2	ARWN100LA2	ARWN100LA2
Product Charge	kg	8.8+8.8+7.3	8.8+8.8+7.3	8.8+8.8+7.3
CF(Correction Factor)	kg	0	0	0
Max. Connectable No. of Indoor Units		64	64	64
Net Weight		223+223+154	223+223+154	223+223+154
Dimension(Wx H x D)		mm	(772 x 1,120 x 547) x 3	(772 x 1,120 x 547) x 3
		inch	(30.4 x 44.1 x 21.5) x 3	(30.4 x 44.1 x 21.5) x 3
Refrigerant	Liquid(mm/inch)	19.05(3/4)	19.05(3/4)	19.05(3/4)
Connecting Pipes	Gas(mm/inch)	41.3(1 5/8)	41.3(1 5/8)	41.3(1 5/8)
Water Connecting Pipes		Inlet	PT32A + PT40A + PT40A (internal thread)	PT32A + PT40A + PT40A (internal thread)
		Outlet	PT32A + PT40A + PT40A (internal thread)	PT32A + PT40A + PT40A (internal thread)
		Drain Outlet	20mm (internal thread)	20mm (internal thread)
Range of Operation	Cooling(°C)	10 ~ 45	10 ~ 45	10 ~ 45
Water Temp.	Heating(°C)	10 ~ 45	10 ~ 45	10 ~ 45

Outside units Information

Unit		3 Unit	
System(HP)		48	50
Model		ARWN480LA2	ARWN500LA2
		ARWN200LA2	ARWN200LA2
		ARWN180LA2	ARWN200LA2
		ARWN100LA2	ARWN100LA2
Product Charge	kg	8.8+8.8+7.3	8.8+8.8+7.3
CF(Correction Factor)	kg	0	0
Max. Connectable No. of Indoor Units		64	64
Net Weight	kg	223+223+154	223+223+154
Dimension(Wx H x D)	mm	(772 x 1,120 x 547) x 3	(772 x 1,120 x 547) x 3
	inch	(30.4 x 44.1 x 21.5) x 3	(30.4 x 44.1 x 21.5) x 3
Refrigerant	Liquid(mm/inch)	19.05(3/4)	19.05(3/4)
Connecting Pipes	Gas(mm/inch)	41.3(1 5/8)	41.3(1 5/8)
	Inlet	PT32A + PT40A + PT40A (internal thread)	PT32A + PT40A + PT40A (internal thread)
Water Connecting Pipes	Outlet	PT32A + PT40A + PT40A (internal thread)	PT32A + PT40A + PT40A (internal thread)
	Drain Outlet	20mm (internal thread)	20mm (internal thread)
Range of Operation Water Temp.	Cooling(°C)	10 ~ 45	10 ~ 45
	Heating(°C)	10 ~ 45	10 ~ 45

Unit		3 Unit	
System(HP)		52	54
Model		ARWN520LA2	ARWN540LA2
		ARWN180LA2	ARWN200LA2
		ARWN180LA2	ARWN180LA2
		ARWN160LA2	ARWN160LA2
Product Charge	kg	8.8+8.8+8.8	8.8+8.8+8.8
CF(Correction Factor)	kg	0	0
Max. Connectable No. of Indoor Units		64	64
Net Weight	kg	223+223+223	223+223+223
Dimension(Wx H x D)	mm	(772 x 1,120 x 547) x 3	(772 x 1,120 x 547) x 3
	inch	(30.4 x 44.1 x 21.5) x 3	(30.4 x 44.1 x 21.5) x 3
Refrigerant	Liquid(mm/inch)	19.05(3/4)	19.05(3/4)
Connecting Pipes	Gas(mm/inch)	41.3(1 5/8)	41.3(1 5/8)
	Inlet	PT40A + PT40A + PT40A (internal thread)	PT40A + PT40A + PT40A (internal thread)
Water Connecting Pipes	Outlet	PT40A + PT40A + PT40A (internal thread)	PT40A + PT40A + PT40A (internal thread)
	Drain Outlet	20mm (internal thread)	20mm (internal thread)
Range of Operation Water Temp.	Cooling(°C)	10 ~ 45	10 ~ 45
	Heating(°C)	10 ~ 45	10 ~ 45

Unit		3 Unit		
System(HP)		56	58	60
Model		ARWN560LA2	ARWN580LA2	ARWN600LA2
		ARWN200LA2	ARWN200LA2	ARWN200LA2
		ARWN180LA2	ARWN200LA2	ARWN200LA2
		ARWN180LA2	ARWN180LA2	ARWN200LA2
Product Charge	kg	8.8+8.8+8.8	8.8+8.8+8.8	8.8+8.8+8.8
CF(Correction Factor)	kg	0	0	0
Max. Connectable No. of Indoor Units		64	64	64
Net Weight	kg	223+223+223	223+223+223	223+223+223
Dimension(Wx H x D)	mm	(772 x 1,120 x 547) x 3	(772 x 1,120 x 547) x 3	(772 x 1,120 x 547) x 3
	inch	(30.4 x 44.1 x 21.5) x 3	(30.4 x 44.1 x 21.5) x 3	(30.4 x 44.1 x 21.5) x 3
Refrigerant	Liquid(mm/inch)	19.05(3/4)	19.05(3/4)	19.05(3/4)
Connecting Pipes	Gas(mm/inch)	41.3(1 5/8)	41.3(1 5/8)	41.3(1 5/8)
	Inlet	PT40A + PT40A + PT40A (internal thread)	PT40A + PT40A + PT40A (internal thread)	PT40A + PT40A + PT40A (internal thread)
Water Connecting Pipes	Outlet	PT40A + PT40A + PT40A (internal thread)	PT40A + PT40A + PT40A (internal thread)	PT40A + PT40A + PT40A (internal thread)
	Drain Outlet	20mm (internal thread)	20mm (internal thread)	20mm (internal thread)
Range of Operation Water Temp.	Cooling(°C)	10 ~ 45	10 ~ 45	10 ~ 45
	Heating(°C)	10 ~ 45	10 ~ 45	10 ~ 45

Environment-friendly Alternative Refrigerant R410A

- The refrigerant R410A has the property of higher operating pressure in comparison with R22. Therefore, all materials have the characteristics of higher resisting pressure than R22 ones and this characteristic should be also considered during the installation. R410A is an azeotrope of R32 and R125 mixed at 50:50, so the ozone depletion potential (ODP) of R410A is 0. These days the developed countries have approved it as the environment-friendly refrigerant and encouraged to use it widely to prevent environment pollution.



CAUTION:

- The wall thickness of the piping should comply with the relevant local and national regulations for the designed pressure 3.8MPa
- Since R410A is a mixed refrigerant, the required additional refrigerant must be charged in its liquid state. If the refrigerant is charged in its gaseous state, its composition changes and the system will not work properly.
- Do not place the refrigerant container under the direct rays of the sun to prevent it from exploding.
- For high-pressure refrigerant, any unapproved pipe must not be used.
- Do not heat pipes more than necessary to prevent them from softening.
- Be careful not to install wrongly to minimize economic loss because it is expensive in comparison with R22.

Select the Best Location

Select space for installing outside unit, which will meet the following conditions:

- No direct thermal radiation from other heat sources
- No possibility of annoying neighbors by noise from unit
- No exposition to strong wind
- With strength which bears weight of unit
- Note that drain flows out of unit when heating
- With space for air passage and service work shown next
- Because of the possibility of fire, do not install unit to the space where generation, inflow, stagnation, and leakage of combustible gas is expected.
- Avoid unit installation in a place where acidic solution and spray (sulfur) are often used.
- Do not use unit under any special environment where oil, steam and sulfuric gas exist.
- It is recommended to fence round the outside unit in order to prevent any person or animal from accessing the outside unit.
- This product is prohibited for outdoor installation.
- Select installation location considering following conditions to avoid bad condition when additionally performing defrost operation.
 1. Install the outside unit at a place well ventilated and having a lot of sunshine in case of installing the product at a place with a high humidity in winter (neare beach, coast, lake, etc).
(Ex) Rooftop where sunshine always shines.
 2. Performance of heating will be reduced and preheat time of the indoor unit may be lengthened in case of installing the outside unit in winter at following location:
 - (1) Shade position with a narrow space
 - (2) Location with much moisture in neighboring floor.
 - (3) Location with much humidity around.
 - (4) Location where water gathers since the floor is not even.

Installation space

Individual Installation

Required the minimum space as shown below for installation and check. If the space is not fit on this drawing, consult with LG.

▨: Service area

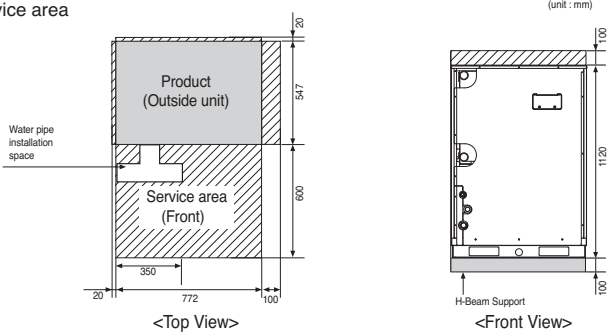

Collective / Continuous Installation

Space required for collective installation and continuous installation as shown below considering passage for air and people.

▨: Service area

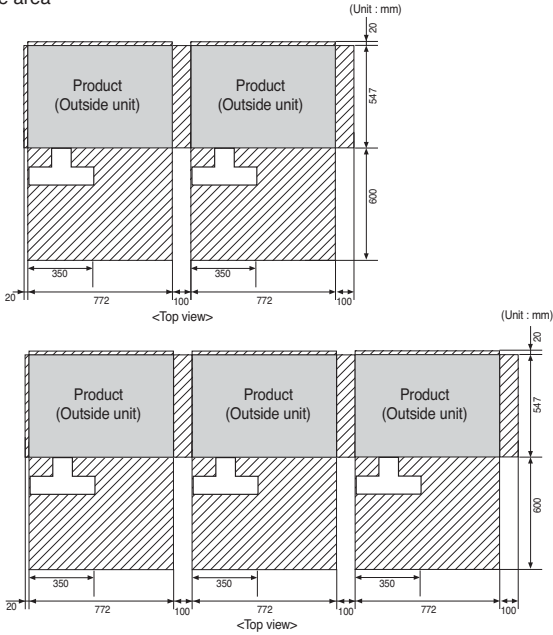

* In case of the water pipe passing side product, please make sufficient service place to avoid occurring between water pipe and product side.

Two Layer Installation

Space required for two layer installation as shown below considering passage for air and people.

▨: Service area

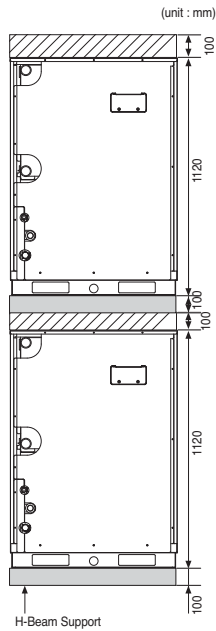

<Front View>

Water control

Water control

- Keep the water temperature between 10~45°C. Other it may cause the breakdown.
 - Standard water supply temperature is 30°C for Cooling and 20°C for heating.
- Properly control the water velocity. Otherwise it may cause the noise, pipe vibration or pipe contraction, expansion according to the temperature. Use the same water pipe size connected with the product or more.
- Refer to the water source pipe diameter and water velocity table below. As the water velocity is fast, air bubble will increase.

Diameter (mm)	Velocity range (m/s)
< 50	0.6 ~ 1.2
50 ~ 100	1.2 ~ 2.1
100 <	2.1 ~ 2.7

- Be careful of the water purity control. Otherwise it may cause the breakdown due to water pipe corrosion. (Refer to 'Standard Table for Water Purity Control')
- In case the water temperature is above 40°C, it is good to prevent the corrosion by adding the anticorrosive agent.
- Install the pipe, valve and gauge sensor in the space where it is easy to maintain. Install the water valve in the low position for drain, if required.
- Be careful not to let air in. If so, the water velocity will be unstable in the circulation, pump efficiency will also decrease and may cause the piping vibration. Therefore, install the air purge where it may generate the air.
- Choose the following anti freezing methods. Otherwise, it will be dangerous for the pipe to break in the winter.
 - Circulate the water with the pump before dropping the temperature.
 - Keep the normal temperature by boiler.
 - When the cooling tower is not operated for a long time, drain the water in the cooling tower.
 - Use an anti-freeze. (For using an anti freeze, change the DIP switch on main PCB in outside unit.)
 - Refer to the additive amount about freezing temperature as in the table given below.

Anti freeze type	Minimum temperature for anti freezing (°C)					
	0	-5	-10	-15	-20	-25
Ethylene glycol (%)	0	12	20	30	-	-
Propylene glycol (%)	0	17	25	33	-	-
Methanol (%)	0	6	12	16	24	30

- In addition to anti freeze, it may cause the change of the pressure in the water system and the low performance of the product.
- Make sure to use the closed cooling type tower.
 - When applying the open type cooling tower, use a 2nd heat exchanger to make the water supply system a closed type system.

Standard table for water purity control

The water may contain many foreign substances and hence may influence the performance and lifetime of the product due to the corrosion of the condenser and water pipe. (Use water source that complies with the below standard table for water purity control.)

If you use water supply other than the tap water to supply the water for the cooling tower, you must do a water quality inspection.

• If you use the closed cooling tower, the water quality must be controlled in accordance with the following standard table.

If you do not control the water quality in accordance with the following standard water quality table, it can cause performance deterioration to the air conditioner and severe problem to the product

Items	Closed type		Effect	
	Circulating water	Supplemented water	Corrosion	Scale
Basic Item				
pH(25C)	7.0~8.0	7.0~8.0	O	O
Conductivity[25C](mS/m)	Below 30	Below 30	O	O
Chlorine ion(mg Cl ⁻ /l)	Below 50	Below 50	O	-
Sulfuric acid ion(mg SO ₄ ²⁻ /l)	Below 50	Below 50	O	O
Acid demand[pH 4.8] (mg SiO ₂ /l)	Below 50	Below 50	-	O
Total hardness(mg SiO ₂ /l)	Below 70	Below 70	-	O
Ca hardness(mg CaCO ₃ /l)	Below 50	Below 50	-	O
Ion silica(mg SiO ₂ /l)	Below 30	Below 30	-	O
Reference Item				
Fe(mg Fe/l)	Below 1.0	Below 0.3	O	O
Copper(mg Cu/l)	Below 1.0	Below 0.1	O	-
Sulfuric acid ion(mg S ²⁻ /l)	Must not be detected	Must not be detected	O	-
Ammonium ion(mg NH ₄ ⁺ /l)	Below 0.3	Below 0.1	O	-
Residual chlorine(mg Cl/l)	Below 0.25	Below 0.3	O	-
Free carbon dioxide(mg CO ₂ /l)	Below 0.4	Below 4.0	O	-
Stability index	-	-	O	O

[Reference]

- (1) The "O" mark for corrosion and scale means that there is possibility of occurrence.
- (2) When the water temperature is 40°C or above or when uncoated iron is exposed to the water, it can result in corrosion. Therefore adding anti-corrosion agent or removing the air can be very effective.
- (3) In case of using the closed type cooling tower, the cooling water and supplementing water must satisfy the water quality criteria of closed type system in the table.
- (4) Supplementing water and supplied water must be supplied with tap water, industrial water and underground water excluding filtered water, neutral water, soft water etc.
- (5) 15 items in the table are general causes of corrosion and scale.

Lifting method

- When carrying the suspended, unit pass the ropes under the unit and use the two suspension points each at the front and rear.
- Always lift the unit with ropes attached at four points so that impact is not applied to the unit.
- Attach the ropes to the unit at an angle of 40° or less.

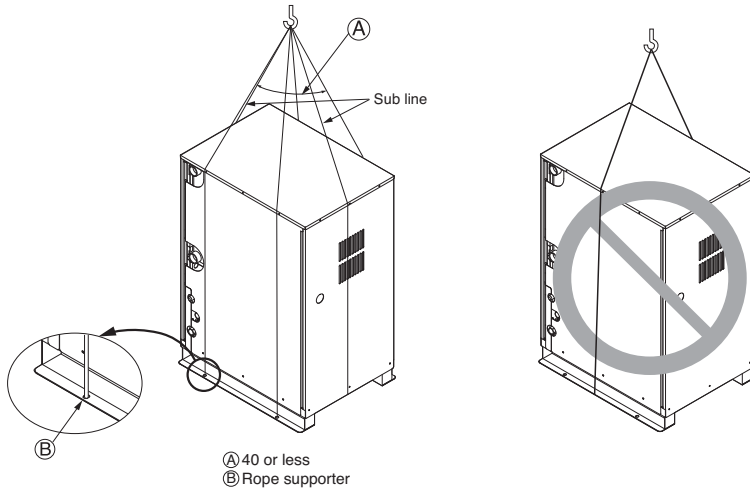

CAUTION

Be very careful while carrying the product.

- Do not have only one person carry product if it is more than 20kg.
- PP bands are used to pack some products. Do not use them as a mean for transportation because they are dangerous.
- Do not touch heat exchanger fins with your bare hands. Otherwise you may get a cut in your hands.
- Tear plastic packaging bag and scrap it so that children cannot play with it. Otherwise plastic packaging bag may suffocate children to death.
- When carrying in Outside Unit, be sure to support it at four points. Carrying in and lifting with 3-point support may make Outside Unit unstable, resulting in a fall.
- Use 2 belts of at least 8 m long.
- Place extra cloth or boards in the locations where the casing comes in contact with the sling to prevent damage.
- Hoist the unit making sure it is being lifted at its center of gravity.

Installation

Location of anchor bolt

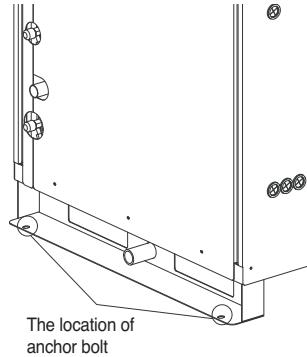
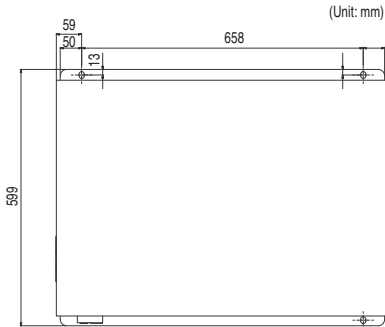

WARNING

- Be sure to install unit in a place strong enough to withstand its weight. Any lack of strength may cause unit to fall down, resulting in a personal injury.
- Have installation work in order to protect against a strong wind and earthquake. Any installation deficiency may cause unit to fall down, resulting in a personal injury.
- Especially take care for support strength of the floor surface, water drain processing (processing of water flown out from the outside unit during operation) and paths of the pipe and wiring when making a base support.

Preparation of Piping

Main cause of gas leakage is defect in flaring work. Carry out correct flaring work in the following procedure.

1) Cut the pipes and the cable.

- Use the accessory piping kit or the pipes purchased locally.
- Measure the distance between the indoor and the outside unit.
- Cut the pipes a little longer than measured distance.
- Cut the cable 1.5m longer than the pipe length.

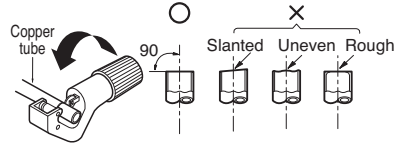

2) Burrs removal

- Completely remove all burrs from the cut cross section of pipe/tube.
- Put the end of the copper tube/pipe to downward direction as you remove burrs in order to avoid to let burrs drop in the tubing.

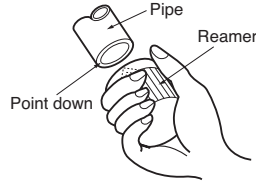

3) Flaring work

- Carry out flaring work using flaring tool as shown below.

Indoor unit [kW(Btu/h)]	Pipe		" A "	
	Gas	Liquid	Gas	Liquid
<5.6(19,100)	1/2"	1/4"	0.5~0.8	0~0.5
<16.0(54,600)	5/8"	3/8"	0.8~1.0	0.5~0.8
<22.4(76,400)	3/4"	3/8"	1.0~1.3	0.5~0.8

Firmly hold copper tube in a bar(or die) as indicated dimension in the table above.

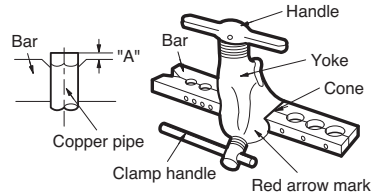

4) Check

- Compare the flared work with figure below.
- If flare is noted to be defective, cut off the flared section and do flaring work again.

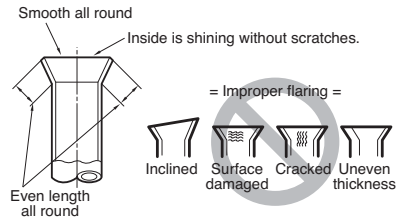

FLARE SHAPE and FLARE NUT TIGHTENING TORQUE

Precautions when connecting pipes

- See the following table for flare part machining dimensions.
- When connecting the flare nuts, apply refrigerant oil to the inside and outside of the flares and turn them three or four times at first. (Use ester oil or ether oil.)
- See the following table for tightening torque. (Applying too much torque may cause the flares to crack.)
- After all the piping has been connected, use nitrogen to perform a gas leak check.

pipe size	tightening torque(Ncm)	A(mm)	flare shape
Ø9.5	3270-3990	12.8-13.2	
Ø12.7	4950-6030	16.2-16.6	
Ø15.9	6180-7540	19.3-19.7	

CAUTION

- Always use a charge hose for service port connection.
- After tightening the cap, check that no refrigerant leaks are present.
- When loosening a flare nut, always use two wrenches in combination. When connecting the piping, always use a spanner and torque wrench in combination to tighten the flare nut.
- When connecting a flare nut, coat the flare (inner and outer faces) with oil for R410A(PVE) and hand tighten the nut 3 to 4 turns as the initial tightening.

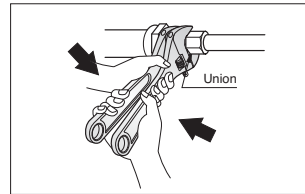

Opening shutoff valve

1. Remove the cap and turn the valve counter clockwise with the hexagon wrench.
2. Turn it until the shaft stops.
Do not apply excessive force to the shutoff valve. Doing so may break the valve body, as the valve is not a backseat type. Always use the special tool.
3. Make sure to tighten the cap securely.

Closing shutoff valve

1. Remove the cap and turn the valve clockwise with the hexagon wrench.
2. Securely tighten the valve until the shaft contacts the main body seal.
3. Make sure to tighten the cap securely.
* For the tightening torque, refer to the table on the below.

Tightening torque

Shut off Valve size	Flare nut	Cap (valve Lid)	Valve Core	Service port	Heagonal wrench
Φ6.35(1/4") (7/16-20UNF)	16.0±2.0	17.6±2.0	3.0	12.7±2.0	6.0±0.6
Φ9.52(3/8") (5/86-18UNF)	38.0±4.0	17.6±2.0	3.0	12.7±2.0	6.0±0.6
Φ12.7(1/2") (3/4-16UNF)	55.0±6.0	20.0±2.0	3.0	12.7±2.0	9.0±0.9
Φ15.88(5/8") (7/8-14UNF)	75.0±7.0	25.0±2.5	3.0	12.7±2.0	15.0±1.5
Φ19.05(3/4") (1/16-UNS)	110.0±10.0	25.0±2.5	3.0	12.7±2.0	30.0±3.0
Φ22.2(7/8")	-	25.0±2.5	3.0	12.7±2.0	30.0±3.0
Φ25.4(1")	-	25.0±2.5	3.0	12.7±2.0	30.0±3.0

HEAT INSULATION

1. Use the heat insulation material for the refrigerant piping which has an excellent heat-resistance (over 120°C).

2. Precautions in high humidity circumstance:

This air conditioner has been tested according to the "ISO Conditions with Mist" and confirmed that there is not any default. However, if it is operated for a long time in high humid atmosphere (dew point temperature: more than 23°C), water drops are liable to fall. In this case, add heat insulation material according to the following procedure:

- Heat insulation material to be prepared... EPDM (Ethylene Propylene Diene Methylene)-over 120°C the heat-resistance temperature.
- Add the insulation over 10mm thickness at high humidity environment.

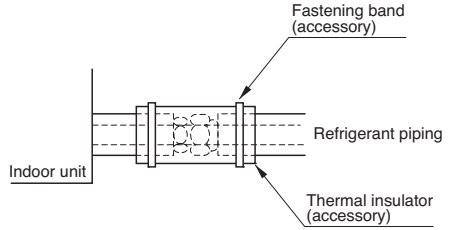

Refrigerant piping installation

⚠ WARNING

Always use extreme care to prevent the refrigerant gas (R410A) from leakage while using fire or flame. If the refrigerant gas comes in contact with the flame from any source, such as a gas stove, it breaks down and generates a poisonous gas which can cause gas poisoning. Never perform brazing in an unventilated room. Always conduct an inspection for gas leakage after installation of the refrigerant piping has been completed.

Cautions in pipe connection/valve operation

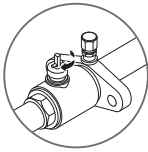

Open status when both the pipe and the valve are in a straight line.

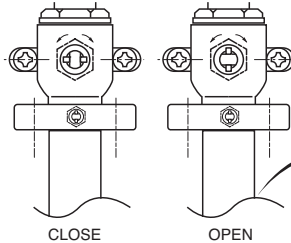

Cut both the pipe and the valve with a cutter to suit the length
(Don't cut the length of less than 70mm)

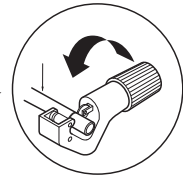

⚠ WARNING

After completing work, securely tighten both service ports and caps so that gas does not leak.

- ① Pipe joint (auxiliary parts): Securely perform brazing with a nitrogen blow into the service valve port. (Releasing pressure : 0.02 MPa or less)
- ② Flare nut: Loose or tighten flare nut by using the wrench with both ends. Coat the flare connection part with oil for the compressor.
- ③ Cap: Remove caps and operate valve, etc. After operation, always reattach caps (tightening torque of valve cap: 25Nm (250kg-cm) or more). (Don't remove the internal part of the port)
- ④ Service port: Make the refrigerant pipe vacuum and charge it using the service port. Always reattach caps after completing work (tightening torque of service cap: 14Nm (140kg-cm) or more).
- ⑤ Liquid pipe
- ⑥ Gas pipe
- ⑦ Elbow joint (field supply)

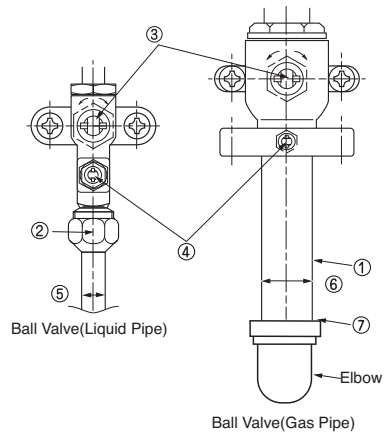

- * Remove the front panel before pipe connection
- * Must check the pipe (liquid pipe, gas pipe, high/low pressure common pipe) before pipe connection

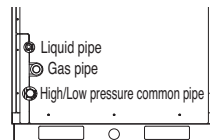

Connection of Outside units

[mm(inch)]

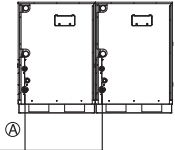
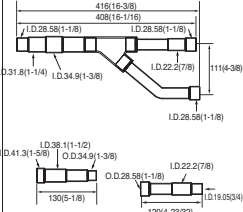
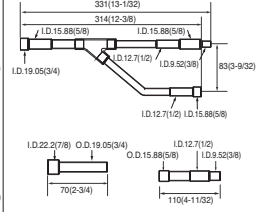
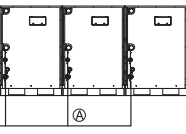
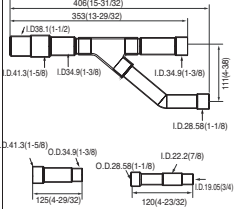
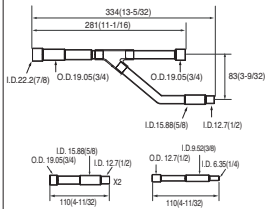
	Outdoor units	Model	Gas pipe	Liquid pipe
2 Unit		<p>Ⓐ ARCNN21</p>		
3 Unit		<p>Ⓑ ARCNN31</p>		

* Install the branch pipe between outside units so that the outlet pipe is parallel to the surface.

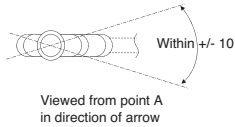

Execute the welding while pouring nitrogen

Do not cut for 70mm or less

⚠ CAUTION
 When installing the branch pipe vertically between the outside units, the refrigerant can be uneven between the outside units, leading to compressor burn and reduced capacity

Connection of High/Low Pressure Common pipe

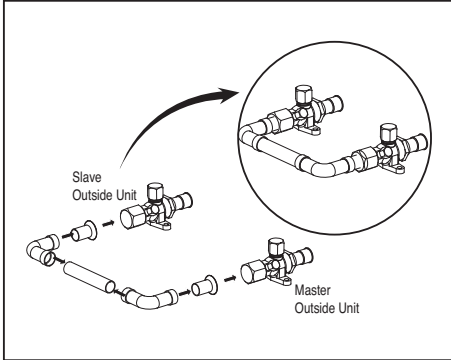

2 Outside Units

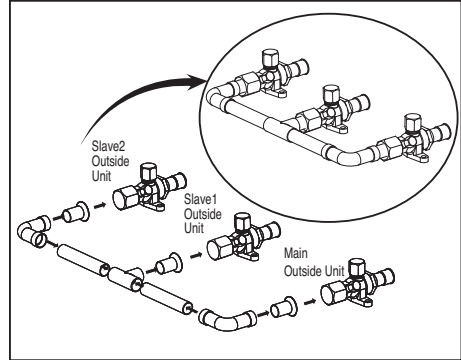

3 Outside Units

- 1) For the high/low pressure common pipe, connect both master outside unit and slave outside units to the pipe by using elbows.
- 2) For cutting the pipe, connect the high/low pressure common pipe after removing burrs, dusts and foreign material within the pipe. Otherwise, the product may not operate due to sludge within the pipe.
- 3) For the working part leakage test, apply the nitrogen gas pressure of 3.8MPa (38.7kgf/cm²).
- 4) The vacuum criteria is to maintain the vacuum level to less than 5 Torr 1 hour after reaching 5 Torr. (Execute the vacuum work again when it is below the criteria.)
- 5) Open the valve with the hexagon wrench.

Installation of water pipe

1) Water pipe system diagram

- The water pressure resistance of the water pipe system of this product is 1.98MPa
- When the water pipe passes indoors, make sure to execute heat insulation on the pipe so that water drops do not form on the outer side of the water pipe.
- The size of the drain pipe must be equal to or larger than the diameter of the connecting product.
 - Always install a trap so that the drained water does not back flush.
- Always install a strainer (50Mesh or above) at the entrance of the water pipe. (When sand, trash, rusted pieces get mixed into the water supply, it can cause problems to the product due to blocking)
 - If On/Off valve is applied, by interlocking with outside unit, it can save the energy consumption of pump by blocking the water supply to the outside unit not operating. Select appropriate valve and install on site if necessary.
- Install a pressure gauge and temperature gauge at the inlet and outlet of the water pipe.
- Flexible joints must be installed not to cause any leakage from the vibration of pipes.
- Install a service port to clean the heat exchanger at the each end of the water inlet and outlet.
- For the components of the water pipe system, always use components above the designed water pressure.

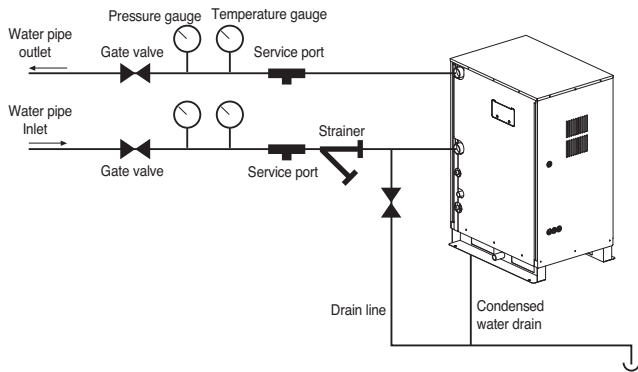

CAUTION

**Do not directly connect the drain outlet to the water pipe outlet.
(It can cause problems to the product.)**

2) Water pipe connection

- The water pipe should be the same size of the connection on the product or more.
- If necessary install the insulation material in the water pipe inlet/outlet to prevent water drop, freeze and to save energy. (Use the above 20mm thickness PE insulation material.)
- Tightly connect the socket to the water pipe refer to below table for recommended specification. (Too much torque may cause the damage of the facility.)

Pipe thickness		Shear stress		Tensile stress		Bending moment		Torque	
mm	inch	(kN)	(kgf)	(kN)	(kgf)	(N-m)	(kgf-m)	(N-m)	(kgf-m)
12.7	1/2	3.5	350	2.5	250	20	23	5	3.5
19.05	3/4	12	1200	2.5	250	20	2	115	11.5
25.4	1	11.2	1120	4	400	45	4.5	155	15.5
31.8	1 1/4	14.5	1450	6.5	650	87.5	8.75	265	26.5
38.1	1 1/2	16.5	1.7	9.5	0.95	155	16	350	35.5
50.8	2	21.5	2.2	13.5	1.4	255	26	600	61

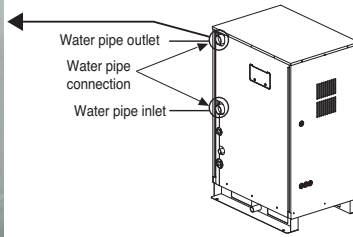

Device protection unit

Strainer on water pipe

To protect the water cooling type product, you must install a strainer with 50 mesh or more on the heat water supply pipe. If not installed, it can result in damage of heat exchanger by the following situation.

1. Heat water supply within the plate type heat exchanger is composed of multiple small paths.
2. If you do not use a strainer with 50 mesh or more, alien particles can partially block the water paths.
3. When running the heater, the plate type heat exchanger plays the role of the evaporator, and at this time, the temperature of the coolant side drops to drop the temperature of the heat water supply, which can result in icing point in the water paths.
4. And as the heating process progresses, the water paths can be partially frozen to lead to damage in plate type heat exchanger.
5. As a result of the damage of the heat exchanger from the freezing, the coolant side and the heat water source side will be mixed to make the product unusable.

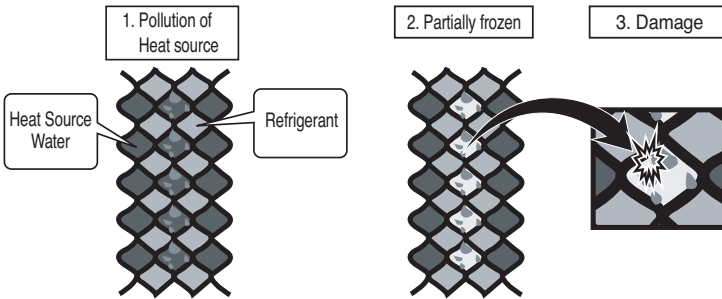

Head loss of strainer on water pipe

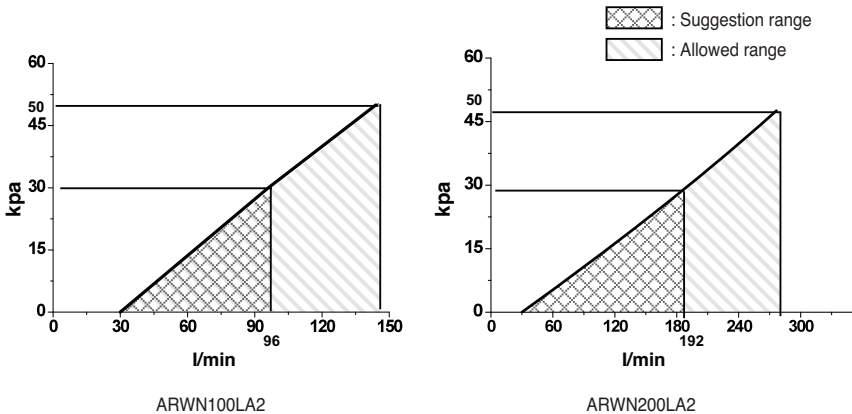

Upper graph is a theoretical value for selection and it may be different according to specification of strainer.

Flow switch work

- It is recommended to install the flow switch to the water collection pipe system connecting to the outside unit.
(Flow switch acts as the 1st protection device when the heat water is not supplied. If a certain level of water does not flow after installing the flow switch, an error sign of CH24 error will be displayed on the product and the product will stop operating.)
- When setting the flow switch, it is recommended to use the product with default set value to satisfy the minimum flow rate of this product. (The minimum flow rate range of this product is 50%. Reference flow rate : 10HP – 96LPM, 20HP – 192LPM)
- Select the flow switch with the permitted pressure specification considering the pressure specification of the heat water supply system. (Control signal from outside unit is AC 220V.)

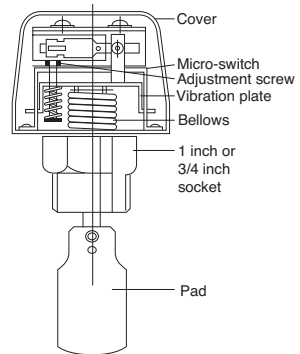

Installation of flow switch

- The flow switch must be installed at the horizontal pipe of the heat water supply outlet of the product and check the direction of the heat water flow before the installation. (Picture 1)
- When connecting the flow switch to the product, remove the jump wire to connect to the communication terminal (5(A) and 5(B)) of the outside unit control box. (Picture 2, 3) (Open the cover of the flow switch and check the wiring diagram before connecting the wires. The wiring method can differ by the manufacturer of the flow switch.)
- If necessary, adjust the flow rate detection screw after consulting with an expert and adjust to the minimum flow rate range. (Picture 4) (Minimum flow rate range of this product is 50%. Adjust the flow switch to touch the contact point when the flow rate reaches 50% of the flow rate.)
- Reference flow rate : 10HP – 96LPM, 20HP – 192LPM)



Picture 1



Picture 2



Picture 3

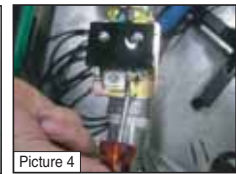

Picture 4

CAUTION

- If the set value does not satisfy the minimum flow rate or if the set value is changed by the user arbitrarily, it can result in product performance deterioration or serious product problem.
- If the product is operated with the heat water supply not flowing smoothly, it can damage the heat exchanger or cause serious product problems.
- In case of CH24 or CH180 error, there is a possibility that the plate type heat exchanger is partially frozen inside. In this case resolve the issue of partial freezing and then operate the product again. (Cause of partial freezing : Insufficient heat water flux, water not supplied, insufficient coolant, alien particle penetrated inside plate type heat exchanger)
- When the product operates while the flow switch touches the contact point at the flow rate range out of the permitted range, it can cause product performance deterioration or serious product problem.
- Must use the normal closed type flow switch
- Circuit of outside unit is normal closed type

Refrigerant piping system

Y branch method

1. When installing 1 outside unit independently

Ex) 5 indoor units connected

- Ⓐ : Outside unit
- Ⓑ : 1st branch (Y branch)
- Ⓒ : Indoor units
- Ⓓ : Indoor unit

➤ Outside unit Ⓐ ~ 1st branch Ⓑ : Main pipe diameter (A)

Outside unit capacity	Liquid pipe (mm)	Gas pipe (mm)
8, 10HP	Ø 9.52	Ø 22.2
16, 18, 20HP	Ø 12.7	Ø 28.58

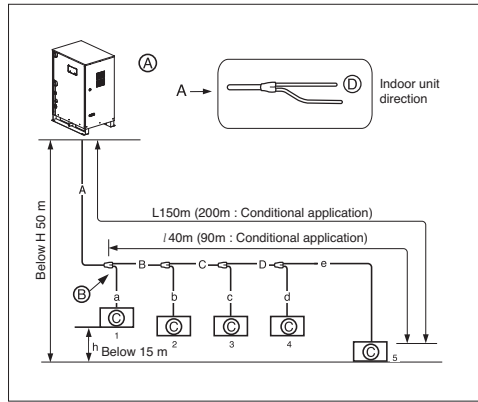

➤ Refrigerant pipe diameter from branch to branch (B,C,D)

Total capacity of indoor units connected to after branching (kW)	Liquid pipe (mm)	Gas pipe (mm)
≤ 5.6	Ø6.35	Ø12.7
< 16	Ø9.52	Ø15.88
< 22.4	Ø9.52	Ø19.05
< 33	Ø9.52	Ø22.2
< 47	Ø12.7	Ø28.58
< 71	Ø15.88	Ø28.58
< 104	Ø19.05	Ø34.9
104 ≤	Ø19.05	Ø41.3

For the first branch pipe (B), use the branch pipe that fits the main pipe diameter (A).

➤ Total pipe length = $A+B+C+D+a+b+c+d+e \leq 300m (500m^{**})$

L	Longest pipe length	Equivalent pipe length
L	$A + B + C + D + e \leq 150m(200m^{**})$	$A + B + C + D + e \leq 175m(225m^{**})$
l	Longest pipe length after 1st branching	
l	$B + C + D + e \leq 40m(90m^{**})$	
H	High/Low difference (Outside unit ↔ Indoor unit)	
H	$H \leq 50m$	
h	High/Low difference (Indoor unit ↔ Indoor unit)	
h	$h \leq 15m$	

(**) : Conditional application

⚠ WARNING

- When the pipe diameter (B) connected after 1st branching is larger than the main pipe diameter (A), install the pipe with the pipe diameter (B) after 1st branching that is the same as the main pipe diameter (A).
- Ex) When connecting with 120% of the indoor unit to 10 HP
 - 1) Outside unit main pipe diameter: 22.2 (Gas pipe) / 9.52(Liquid pipe)
 - 2) Pipe diameter after 1st branching by 120% indoor unit combination : 28.58 (Gas pipe) / 12.7 (Liquid pipe)
 Therefore set the pipe diameter (B) after 1st branching to 22.2 (Gas pipe) / 9.52 (Liquid pipe) of main pipe diameter (A).
- When the pipe distance corresponding to the farthest indoor unit from the outside unit is 90m or above, you must change the main pipe diameter according to the outside unit capacity in accordance with the following table. (This applies to both the liquid and gas pipes.)

Gas pipe (mm)	Liquid pipe (mm)
8, 10 HP.....Ø 22.2 → Ø 25.4	8, 10 HP.....Ø 9.52 → Ø 12.7
16,18,20 HP.....Ø 28.58 → Ø 31.8	16,18,20 HP.....Ø 12.7 → Ø 15.88

2. When installing 2 outside units

Ex) 5 indoor units connected

- Ⓐ : Outside units
- Ⓑ : 1st branch
- Ⓒ : Indoor units
- Ⓓ : Indoor unit direction
- Ⓔ : Connecting branch pipe between outside units

* Connecting branch pipe between outside units: ARRCN20(Ⓔ)

▷ Slave outside unit ~ Connecting branch pipe Ⓔ: Pipe diameter between outside units (E)

Liquid pipe (mm)	Gas pipe (mm)	Low/high pressure common pipe (mm)
∅9.52/12.7	∅22.2/28.58	∅19.05

▷ Connecting branch pipe Ⓔ ~ 1st branch part Ⓑ: Main pipe diameter (A)

Outside unit capacity	Liquid pipe (mm)	Gas pipe (mm)
24, 26, 28, 30 HP	∅ 19.05	∅ 34.9
32, 34, 36, 38, 40 HP	∅ 19.05	∅ 41.3

▷ Refrigerant pipe diameter from branch to branch (B, C, D)

Total capacity of indoor units connected to after branching (kW)	Liquid pipe (mm)	Gas pipe (mm)
≤ 5.6	∅6.35	∅12.7
< 16	∅9.52	∅15.88
< 22.4	∅9.52	∅19.05
< 33	∅9.52	∅22.2
< 47	∅12.7	∅28.58
< 71	∅15.88	∅28.58
< 104	∅19.05	∅34.9
104 ≤	∅19.05	∅41.3

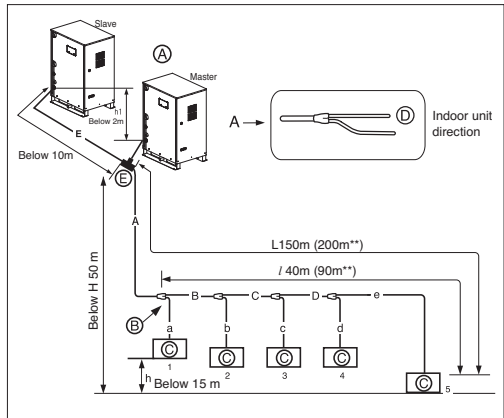

▷ Total refrigerant pipe length = $A + B + C + D + a + b + c + d + e \leq 300m (500m^{**})$

L	Longest pipe length	Equivalent pipe length
L	$A + B + C + D + e \leq 150m(200m^{**})$	$A + B + C + D + e \leq 175m(225m^{**})$
l	Longest pipe length after 1st branching	
l	$B + C + D + e \leq 40m(90m^{**})$	
H	High/Low difference (Outside unit ↔ Indoor unit)	
H	$H \leq 50 m$	
h	High/Low difference (Indoor unit ↔ Indoor unit)	
h	$h \leq 15 m$	
h1	High/Low difference (Indoor unit ↔ Indoor unit)	
h1	$h \leq 2 m$	

(**) : Conditional application

For the first branch pipe (B), use the branch pipe that fits the main pipe diameter (A).

⚠ WARNING

- When the pipe diameter (B) connected after 1st branching is larger than the main pipe diameter (A), install the pipe with the pipe diameter (B) after 1st branching that is the same as the main pipe diameter (A).
Ex) When connecting with 120% of the indoor unit to 10 HP.
1) Outside unit main pipe diameter: 22.2 (Gas pipe) / 9.52(Liquid pipe)
2) Pipe diameter after 1st branching by 120% indoor unit combination : 28.58 (Gas pipe) / 12.7 (Liquid pipe)
Therefore set the pipe diameter (B) after 1st branching to 22.2 (Gas pipe) / 9.52 (Liquid pipe) of main pipe diameter (A).
- When the pipe distance corresponding to the farthest indoor unit from the outside unit is 90m or above, you must change the main pipe diameter according to the outside unit capacity in accordance with the following table. (This applies to both the liquid and gas pipes.)

Gas pipe (mm)	Liquid pipe (mm)
24, 26, 28, 30 HP ∅ 34.9 → ∅ 38.1	24, 26, 28, 30, 32, 34, 36, 38, 40 HP
32, 34, 36, 38, 40 HP ∅ 41.3 ∅ 19.05 → ∅ 22.2

3. When installing 3 outside units

Ex) 5 Indoor Units connected

- Ⓐ : Outside Units
- Ⓑ : 1st branch (Y branch)
- Ⓒ : Indoor Units
- Ⓓ : Downward Indoor Unit
- Ⓔ : Connection branch pipe between Outside units:ARCNN30
- Ⓕ : Connection branch pipe between Outside units:ARCNN20

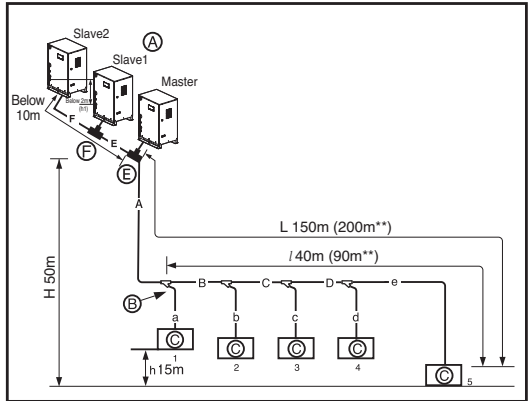

↳ Slave2 outside unit ~ Connecting branch pipe Ⓕ: Pipe diameter between outside units (F)

Liquid pipe (mm)	Gas pipe (mm)	Low/high pressure common pipe (mm)
Ø9.52/12.7	Ø22.2/28.58	Ø19.05

↳ Slave1 outside unit ~ Connecting branch pipe Ⓔ: Pipe diameter between outside units (E)

Liquid pipe (mm)	Gas pipe (mm)	Low/high pressure common pipe (mm)
Ø15.88/19.05	Ø34.9/41.3	Ø19.05

↳ Connecting branch pipe Ⓔ ~ 1st branch part Ⓑ : Main pipe diameter (A)

Outside unit capacity	Liquid pipe (mm)	Gas pipe (mm)
42, 44, 46, 48, 50, 52, 54, 56, 58, 60HP	Ø 19.05	Ø 41.3

↳ Total refrigerant pipe length =
A + B + C + D + a + b + c + d + e ≤ 300m (500m**)

L	Longest pipe length	Equivalent pipe length
	A + B + C + D + e ≤ 150m(200m**)	A + B + C + D + e ≤ 175m(225m**)
l	Longest pipe length after 1st branching	
	B + C + D + e ≤ 40m(90m**)	
H	High/Low difference (Outside unit ↔ Indoor unit)	
	H ≤ 50 m	
h	High/Low difference (Indoor unit ↔ Indoor unit)	
	h ≤ 15 m	
h1	High/Low difference (Indoor unit ↔ Indoor unit)	
	h ≤ 2 m	

(**) : Conditional application

↳ Refrigerant pipe diameter from branch to branch (B, C, D)

Total capacity of indoor units connected to after branching (kW)	Liquid pipe (mm)	Gas pipe (mm)
≤ 5.6	Ø6.35	Ø12.7
< 16	Ø9.52	Ø15.88
< 22.4	Ø9.52	Ø19.05
< 33	Ø9.52	Ø22.2
< 47	Ø12.7	Ø28.58
< 71	Ø15.88	Ø28.58
< 104	Ø19.05	Ø34.9
104 ≤	Ø19.05	Ø41.3

For the first branch pipe (B), use the branch pipe that fits the main pipe diameter (A).

⚠ WARNING

- When the pipe diameter (B) connected after 1st branching is larger than the main pipe diameter (A), install the pipe with the pipe diameter (B) after 1st branching that is the same as the main pipe diameter (A).
- Ex) When connecting with 120% of the indoor unit to 10 HP.
 - 1) Outside unit main pipe diameter: 22.2 (Gas pipe) / 9.52(Liquid pipe)
 - 2) Pipe diameter after 1st branching by 120% indoor unit combination : 28.58 (Gas pipe) / 12.7 (Liquid pipe)
 Therefore set the pipe diameter (B) after 1st branching to 22.2 (Gas pipe) / 9.52 (Liquid pipe) of main pipe diameter (A).
- When the pipe distance corresponding to the farthest indoor unit from the outside unit is 90m or above, you must change the main pipe diameter according to the outside unit capacity in accordance with the following table. (This applies to both the liquid and gas pipes.)

Gas pipe (mm)	Liquid pipe (mm)
42, 44, 46, 48, 50, 52, 54, 56, 58, 60HPØ 41.3	42, 44, 46, 48, 50, 52, 54, 56, 58, 60HPØ 19.05 → Ø 22.2

Header branch method

1. When installing 1 outside unit independently

Ex) 6 indoor units connected

- Ⓐ Outside unit
- Ⓑ Header branch
- Ⓒ Indoor unit
- Ⓓ Seal

⊃ Outside unit Ⓐ ~ Header branch part Ⓑ : Main pipe diameter (A)

Outside unit capacity	Liquid pipe (mm)	Gas pipe (mm)
8, 10HP	∅ 9.52	∅ 22.2
16, 18, 20HP	∅ 12.7	∅ 28.58

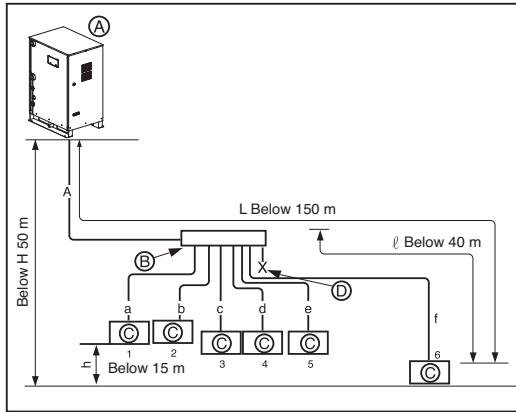

⊃ Total refrigerant pipe length = A + a + b + c + d + e + f ≤ 300m (500m**)

L	Longest pipe length (Equivalent pipe length)
	A + f ≤ 150 m (175 m)
l	Longest pipe length after 1st branching
	f ≤ 40 m
H	High/Low difference (Outside unit <-> Indoor unit)
	H ≤ 50 m
h	High/Low difference (Indoor unit <-> Indoor unit)
	h ≤ 15 m

⚠ WARNING

- For the pipe length after the header branch (a-f), it is recommended to install the unit so that the difference of the pipe distance connected to the indoor unit is minimized.
- The large difference in pipe distance can cause performance difference between indoor units.
- After the header branch, you cannot use the Y branch and header branch.
- When the pipe distance corresponding to the farthest indoor unit from the outside unit is 90m or above, you must change the main pipe diameter according to the outside unit capacity in accordance with the following table.
(This applies to both the liquid and gas pipes.)

Gas pipe (mm)	Liquid pipe (mm)
8, 10 HP.....∅ 22.2 → ∅ 25.4	8, 10 HP.....∅ 9.52 → ∅ 12.7
16,18,20 HP.....∅ 28.58 → ∅ 31.8	16,18,20 HP.....∅ 12.7 → ∅ 15.88

2. When installing 2 outside units

Ex) 6 indoor units connected

- Ⓐ : Outside units
- Ⓑ : Header branch
- Ⓒ : Indoor unit
- Ⓓ : Seal
- Ⓔ : Connecting branch pipe between outside units

* Connecting branch pipe between outside units: ARRCN20(Ⓔ)

↳ Slave outside unit ~ Connecting branch unit (Ⓔ) : Pipe diameter between outside units (E)

Liquid pipe (mm)	Gas pipe (mm)	Low/high pressure common pipe(mm)
Ø9.52/12.7	Ø22.2/28.58	Ø19.05

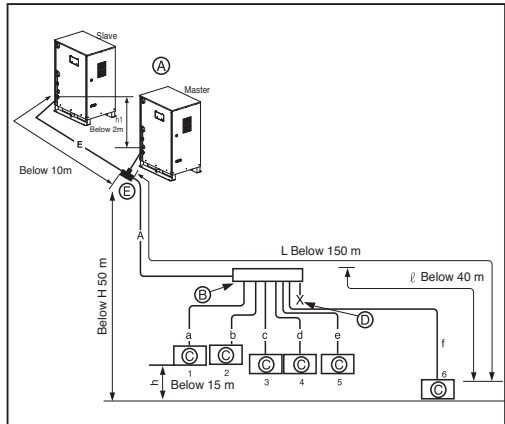

↳ Connecting branch pipe (Ⓔ) ~ Header branch part (Ⓑ) : Main pipe diameter (A)

Outside unit capacity	Liquid pipe (mm)	Gas pipe (mm)
24, 26, 28, 30 HP	Ø 19.05	Ø 34.9
32, 34, 36, 38, 40 HP	Ø 19.05	Ø 41.3

↳ Total refrigerant pipe length = A + B + C + D + a + b + c + d + e ≤ 300m (500m)**

L	Longest pipe length (Equivalent pipe length) A + f ≤ 150 m(175 m)
l	Longest pipe length after 1st branching f ≤ 40 m
H	High/Low difference (Outside unit ↔ Indoor unit) H ≤ 50 m
h	High/Low difference (Indoor unit ↔ Indoor unit) h ≤ 15 m
h1	High/Low difference (Indoor unit ↔ Indoor unit) h1 ≤ 2 m

⚠ WARNING

- For the pipe length after the header branch (a~f), it is recommended to install the unit so that the difference of the pipe distance connected to the indoor unit is minimized.
- The large difference in pipe distance can cause performance difference between indoor units.
- After the header branch, you cannot use the Y branch and header branch.
- When the pipe distance corresponding to the farthest indoor unit from the outdoor unit is 90m or above, you must change the main pipe diameter according to the outside unit capacity in accordance with the following table. (This applies to both the liquid and gas pipes.)

Gas pipe (mm)	Liquid pipe (mm)
24, 26, 28, 30 HP.....Ø 34.9 → Ø 38.1	24, 26, 28, 30, 32, 34, 36, 38, 40 HP
32, 34, 36, 38, 40 HP.....Ø 41.3Ø 19.05 → Ø 22.2

3. When installing 3 outside units

Ex) 6 Indoor Units connected

- Ⓐ : Outside Units
- Ⓑ : Header branch
- Ⓒ : Indoor Units
- Ⓓ : Sealing
- Ⓔ : Connection branch pipe between Outside units:ARCNN30
- Ⓕ : Connection branch pipe between Outside units:ARCNN20

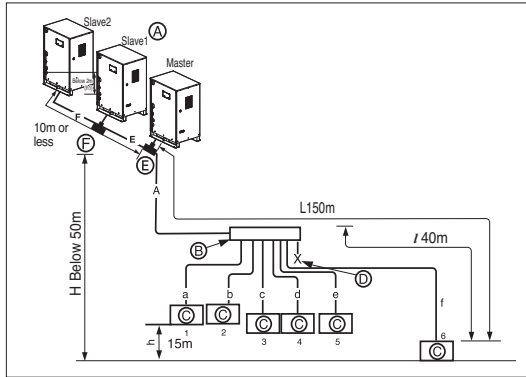

Branch pipe can not be used after header

↳ Slave2 outside unit ~ Connecting branch pipe (Ⓔ) : Pipe diameter between outside units (F)

Liquid pipe (mm)	Gas pipe (mm)	Low/high pressure common pipe(mm)
Ø9.52/12.7	Ø22.2/28.58	Ø19.05

↳ Slave1 outside unit ~ Connecting branch unit (Ⓔ) : Pipe diameter between outside units (E)

Liquid pipe (mm)	Gas pipe (mm)	Low/high pressure common pipe(mm)
Ø15.88/19.05	Ø34.9/41.3	Ø19.05

↳ Connecting branch pipe (Ⓔ) ~ Header branch part (Ⓑ) : Main pipe diameter (A)

Outside unit capacity	Liquid pipe (mm)	Gas pipe (mm)
42,44,46,48,50,52,54,56,58,60 HP	Ø 19.05	Ø 41.3

↳ Total refrigerant pipe length = A + B + C + D + a + b + c + d + e ≤ 300m (500m**)

L	Longest pipe length (Equivalent pipe length) A + f ≤ 150 m(175 m)
l	Longest pipe length after 1st branching f ≤ 40 m
H	High/Low difference (Outside unit ↔ Indoor unit) H ≤ 50 m
h	High/Low difference (Indoor unit ↔ Indoor unit) h ≤ 15 m
h1	High/Low difference (Indoor unit ↔ Indoor unit) h1 ≤ 2 m

⚠ WARNING

- For the pipe length after the header branch (a-f), it is recommended to install the unit so that the difference of the pipe distance connected to the indoor unit is minimized.
- The large difference in pipe distance can cause performance difference between indoor units.
- After the header branch, you cannot use the Y branch and header branch.
- When the pipe distance corresponding to the farthest indoor unit from the outside unit is 90m or above, you must change the main pipe diameter according to the outside unit capacity in accordance with the following table. (This applies to both the liquid and gas pipes.)

Gas pipe (mm)	Liquid pipe (mm)
42, 44, 46, 48, 50, 52, 54, 56, 58, 60 HP.....Ø 34.9	42, 44, 46, 48, 50, 52, 54, 56, 58, 60 HP.....Ø 19.05 → Ø 22.2

Y/Header branch method

1. When installing 1 outside unit independently

Ex) 5 indoor units connected

- (A) : Outside unit
- (B) : 1st Y branch
- (C) : 2nd Y branch
- (D) : Indoor unit
- (E) : Header branch
- (F) : Seal

Outside unit (A) ~ 1st Y branch part (B) : Main pipe diameter (A)

Outside unit capacity	Liquid pipe (mm)	Gas pipe (mm)
8, 10HP	Ø 9.52	Ø 22.2
16, 18, 20HP	Ø 12.7	Ø 28.58

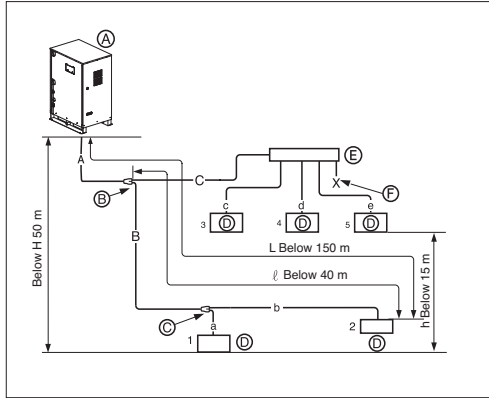

Refrigerant pipe diameter from branch to branch (B, C)

Total capacity of indoor units connected to after branching (kW)	Liquid pipe (mm)	Gas pipe (mm)
≤ 5.6	Ø6.35	Ø12.7
< 16	Ø9.52	Ø15.88
< 22.4	Ø9.52	Ø19.05
< 33	Ø9.52	Ø22.2
< 47	Ø12.7	Ø28.58
< 71	Ø15.88	Ø28.58
< 104	Ø19.05	Ø34.9
$104 \le$	Ø19.05	Ø41.3

* For the first branch pipe (B), use the branch pipe that fits the main pipe diameter (A)

Total pipe length

= A + B + C + a + b + c + d + e $\le 300\text{m}$ (500m)**

L	Longest pipe length (Equivalent pipe length) A + B + b, A + C + e $\le 150\text{ m}$ (175 m)
l	Longest pipe length after 1st branching B + b, C + e $\le 40\text{ m}$
H	High/Low difference (Outside unit ↔ Indoor unit) H $\le 50\text{ m}$
h	High/Low difference (Indoor unit ↔ Indoor unit) h $\le 15\text{ m}$

WARNING

- When the pipe diameter (B) connected after 1st branching is larger than the main pipe diameter (A), install the pipe with the pipe diameter (B) after 1st branching that is the same as the main pipe diameter (A). Ex) When connecting with 120% of the indoor unit to 10 HP.
 - 1) Outside unit main pipe diameter: 22.2 (Gas pipe) / 9.52 (Liquid pipe)
 - 2) Pipe diameter after 1st branching by 120% indoor unit combination : 28.58 (Gas pipe) / 12.7 (Liquid pipe)
 Therefore set the pipe diameter (B) after 1st branching to 22.2 (Gas pipe) / 9.52 (Liquid pipe) of main pipe diameter (A).
- For the pipe length after the header branch (c~e), it is recommended to install the unit so that the difference of the pipe distance connected to the indoor unit is minimized.
- The large difference in pipe distance can cause performance difference between indoor units.
- After the header branch, you cannot use the Y branch and header branch.
- When the pipe distance corresponding to the farthest indoor unit from the outside unit is 90m or above, you must change the main pipe diameter according to the outside unit capacity in accordance with the following table. (This applies to both the liquid and gas pipes.)

Gas pipe (mm)	Liquid pipe (mm)
8, 10 HP.....Ø 22.2 → Ø 25.4	8, 10 HP.....Ø 9.52 → Ø 12.7
16,18,20 HP.....Ø28.58 → Ø31.8	16, 18,20 HP.....Ø 12.7 → Ø 15.88

2. When installing 2 outside units
Ex) 5 indoor units connected

- Ⓐ : Outside units
- Ⓑ : 1st Y branch
- Ⓒ : 2nd Y branch
- Ⓓ : Indoor unit
- Ⓔ : Header branch
- Ⓕ : Seal
- Ⓖ : Connecting branch pipe between outside units

* Connecting branch pipe between outside units:
 ARRCN20(Ⓒ)

↳ **Slave outside unit ~ Connecting branch pipe Ⓒ : Pipe diameter between outside units (E)**

Liquid pipe (mm)	Gas pipe (mm)	Low/high pressure common pipe(mm)
Ø9.52/12.7	Ø22.2/28.58	Ø19.05

↳ **Connecting branch pipe Ⓒ ~ 1st Y branch part Ⓑ : Main pipe diameter (A)**

Outside unit capacity	Liquid pipe (mm)	Gas pipe (mm)
24, 26, 28, 30 HP	Ø19.05	Ø34.9
32, 34, 36, 38, 40 HP	Ø19.05	Ø41.3

↳ **Refrigerant pipe diameter from branch to branch (B, C)**

Total capacity of indoor units connected to after branching (kW)	Liquid pipe (mm)	Gas pipe (mm)
≤ 5.6	Ø6.35	Ø12.7
< 16	Ø9.52	Ø15.88
< 22.4	Ø9.52	Ø19.05
< 33	Ø9.52	Ø22.2
< 47	Ø12.7	Ø28.58
< 71	Ø15.88	Ø28.58
< 104	Ø19.05	Ø34.9
104 ≤	Ø19.05	Ø41.3

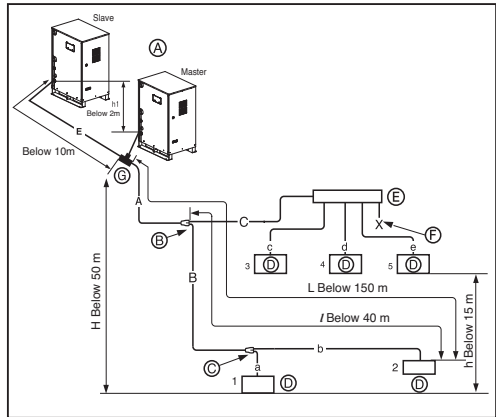

↳ **Total refrigerant pipe length = A + B + C + a + b + c + d + e ≤ 300m (500m**)**

L	Longest pipe length (Equivalent pipe length)
A + B + b, A + C + e ≤ 150 m (175 m)	
l	Longest pipe length after 1st branching
B + b, C + e ≤ 40 m	
H	High/Low difference (Outside unit ↔ Indoor unit)
H ≤ 50 m	
h	High/Low difference (Indoor unit ↔ Indoor unit)
h ≤ 15 m	
h1	High/Low difference (Indoor unit ↔ Indoor unit)
h1 ≤ 2 m	

For the first branch pipe (B), use the branch pipe that fits the main pipe diameter (A).

⚠ WARNING

- When the pipe diameter (B) connected after 1st branching is larger than the main pipe diameter (A), Install the pipe with the pipe diameter (B) after 1st branching that is the same as the main pipe diameter (A).
- Ex) When connecting with 120% of the indoor unit to 10 HP.
 - 1) Outside unit main pipe diameter: 22.2 (Gas pipe) / 9.52 (Liquid pipe)
 - 2) Pipe diameter after 1st branching by 120% indoor unit combination : 28.58 (Gas pipe) / 12.7 (Liquid pipe)
 Therefore set the pipe diameter (B) after 1st branching to 22.2 (Gas pipe) / 9.52 (Liquid pipe) of main pipe diameter (A).
- For the pipe length after the header branch (c~e), it is recommended to install the unit so that the difference of the pipe distance connected to the indoor unit is minimized.
- The large difference in pipe distance can cause performance difference between indoor units.
- After the header branch, you cannot use the Y branch and header branch.
- When the pipe distance corresponding to the farthest indoor unit from the outside unit is 90m or above, you must change the main pipe diameter according to the outside unit capacity in accordance with the following table. (This applies to both the liquid and gas pipes.)

Gas pipe (mm)	Liquid pipe (mm)
24, 26, 28, 30 HP.....Ø 34.9 → Ø 38.1	24, 26, 28, 30, 32, 34, 36, 38, 40 HP
32, 34, 36, 38, 40 HP.....Ø 41.3Ø 19.05 → Ø 22.2

3. When installing 3 outside units

Ex) 5 Indoor Units connected

- (A) : Outside Units
- (B) : 1st branch(Y branch)
- (C) : Y branch
- (D) : Indoor Unit
- (E) : Connection branch pipe between Outside units:ARCNN30
- (F) : Connection branch pipe between Outside units:ARCNN20
- (G) : Header
- (H) : Sealing

↳ Slave2 outside unit ~ Connecting branch pipe (F) : Pipe diameter between outside units (F)

Liquid pipe (mm)	Gas pipe (mm)	Low/high pressure common pipe(mm)
Ø9.52/12.7	Ø22.2/28.58	Ø19.05

↳ Slave1 outside unit ~ Connecting branch pipe (E) : Pipe diameter between outside units (E)

Liquid pipe (mm)	Gas pipe (mm)	Low/high pressure common pipe(mm)
Ø15.88/19.05	Ø34.9/41.3	Ø19.05

↳ Connecting branch pipe (E) ~ 1st Y branch part (B) : Main pipe diameter (A)

Outside unit capacity	Liquid pipe (mm)	Gas pipe (mm)
42, 44, 46, 48, 50, 52, 54, 56, 58, 60HP	Ø 19.05	Ø 41.3

↳ Refrigerant pipe diameter from branch to branch (B, C)

Total capacity of indoor units connected to after branching (kW)	Liquid pipe (mm)	Gas pipe (mm)
≤ 5.6	Ø6.35	Ø12.7
< 16	Ø9.52	Ø15.88
< 22.4	Ø9.52	Ø19.05
< 33	Ø9.52	Ø22.2
< 47	Ø12.7	Ø28.58
< 71	Ø15.88	Ø28.58
< 104	Ø19.05	Ø34.9
104 ≤	Ø19.05	Ø41.3

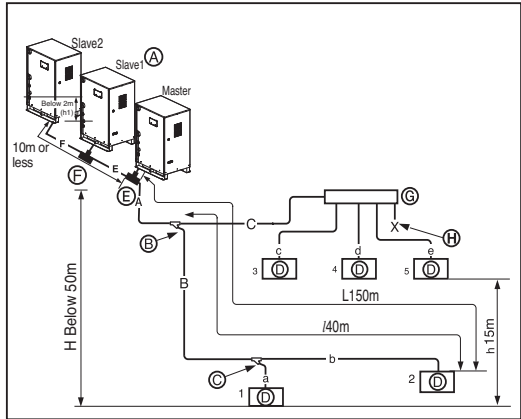

Branch pipe can not be used after header

↳ Total refrigerant pipe length = A + B + C + a + b + c + d + e ≤ 300m (500m)**

L	Longest pipe length (Equivalent pipe length) A + B + b, A + C + e ≤ 150 m (175 m)
l	Longest pipe length after 1st branching B + b, C + e ≤ 40 m
H	High/Low difference (Outside unit ↔ Indoor unit) H ≤ 50 m
h	High/Low difference (Indoor unit ↔ Indoor unit) h ≤ 15 m
h1	High/Low difference (Indoor unit ↔ Indoor unit) h ≤ 2 m

For the first branch pipe (B), use the branch pipe that fits the main pipe diameter (A).

⚠ WARNING

- When the pipe diameter (B) connected after 1st branching is larger than the main pipe diameter (A), Install the pipe with the pipe diameter (B) after 1st branching that is the same as the main pipe diameter (A).
- Ex) When connecting with 120% of the indoor unit to 10 HP.
 - 1) Outside unit main pipe diameter: 22.2 (Gas pipe) / 9.52 (Liquid pipe)
 - 2) Pipe diameter after 1st branching by 120% indoor unit combination : 28.58 (Gas pipe) / 12.7 (Liquid pipe)
 Therefore set the pipe diameter (B) after 1st branching to 22.2 (Gas pipe) / 9.52 (Liquid pipe) of main pipe diameter (A).
- For the pipe length after the header branch (c~e), it is recommended to install the unit so that the difference of the pipe distance connected to the indoor unit is minimized.
- The large difference in pipe distance can cause performance difference between indoor units.
- After the header branch, you cannot use the Y branch and header branch.
- When the pipe distance corresponding to the farthest indoor unit from the outside unit is 90m or above, you must change the main pipe diameter according to the outside unit capacity in accordance with the following table. (This applies to both the liquid and gas pipes.)

Gas pipe (mm)	Liquid pipe (mm)
42, 44, 46, 48, 50, 52, 54, 56, 58, 60HPØ 41.3	42, 44, 46, 48, 50, 52, 54, 56, 58, 60HPØ 19.05 → Ø 22.2

()Conditional Application (Incase of D10 is farthest indoor)**

Below condition must be satisfied for 40 ~ 90m piping length after first branch.

- 1) Diameter of pipes between first branch and the last branch should be increased by one step, except pipe diameter B, C, D is same as Diameter A (Main pipe diameter).
 $\text{Ø}6.35 \rightarrow \text{Ø}9.52 \rightarrow \text{Ø}12.7 \rightarrow \text{Ø}15.88 \rightarrow \text{Ø}19.05 \rightarrow \text{Ø}22.2 \rightarrow \text{Ø}25.4^* \rightarrow \text{Ø}28.58 \rightarrow \text{Ø}31.8^* \rightarrow \text{Ø}34.9 \rightarrow \text{Ø}38.1^*$
 * : It is not necessary to size up.
 ※ If available on site, it use this size. Otherwise it can't be increased.
- 2) While calculating total refrigerant piping length, pipe B, C, D length should be calculated twice
 $A+Bx2+Cx2+Dx2+a+b+c+d+e \leq 500 \text{ m}$
- 2) Length of pipe from each indoor unit to the closest branch (a,b,c,d,e) $\leq 40 \text{ m}$
- 3) [Length of pipe from outdoor unit to the farthest indoor unit 5 (A+B+C+D+e)]
 - [Length of pipe outdoor unit to the closest indoor unit 1 (A+a)] $\leq 40 \text{ m}$

Indoor unit connection

→ Indoor unit connecting pipe from branch (a~f)

Indoor unit capacity [kW(Btu/h)]	Liquid pipe [mm(inch)]	Gas pipe [mm(inch)]
$\leq 5.6(19,100)$	Ø6.35(1/4)	Ø12.7(1/2)
$< 16.0(54,600)$	Ø9.52(3/8)	Ø15.88(5/8)
$< 22.4(76,400)$	Ø9.52(3/8)	Ø19.05(3/4)
$< 33(112,600)$	Ø9.52(3/8)	Ø22.2(7/8)

Oil trap application method between outside units

- Because of the possibility of oil being accumulated in the outside unit that has stopped, when there is a height difference between outside unit pipes or if the pipe distance between the outside units is over 2m, you must always apply an oil trap. (But, the oil trap between outside units is limited to 1 time and is only applied to the gas pipe.)
- If the pipe distance between the outside units is 2m or below, and if the location of the main pipe is lower than that of the outside unit and if the location of the main pipe is lower than that of the outside unit, the oil trap does not have to be applied.
- If the location of the main pipe is higher than the location of the outside unit, be careful since the oil can be accumulated in the stopped outside unit.
- If there is high/low difference between the outside unit pipes, oil can be accumulated to the outside unit on the lower location until the unit stops.

• When pipe distance between the outside units is 2m or less

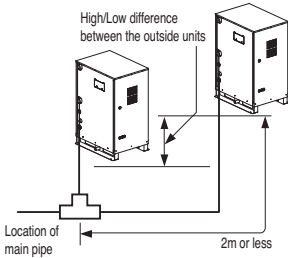

• When pipe distance between the outside units exceed 2m

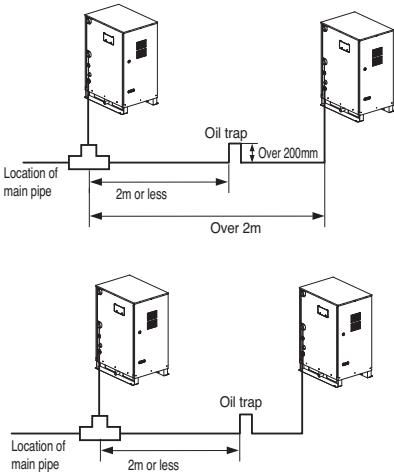

• Example of incorrect installation

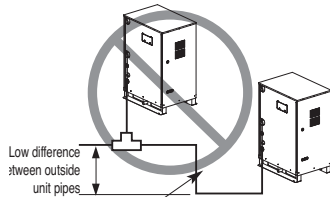
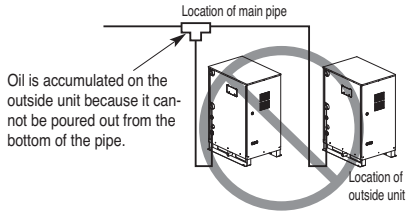

• Example of correct installation

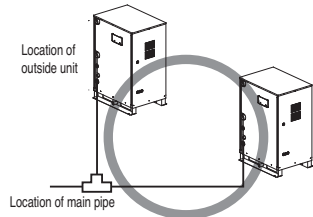
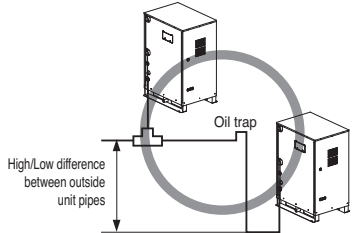

Calculation of amount of refrigerant

The calculation of the additional charge should take into account the length of pipe.

(A)	Product Charge(kg)	
(B)	Additional charge (kg)	
=	Total liquid pipe (m): Ø22.2mm	x 0.354(kg/m)
+	Total liquid pipe (m): Ø19.05mm	x 0.266(kg/m)
+	Total liquid pipe (m): Ø15.88mm	x 0.173(kg/m)
+	Total liquid pipe (m): Ø12.7mm	x 0.118(kg/m)
+	Total liquid pipe (m): Ø9.52mm	x 0.061(kg/m)
+	Total liquid pipe (m): Ø6.35mm	x 0.022(kg/m)
+	CF(kg) (Correction Factor)	
	Total amount(kg)	= (A) + (B)

CAUTION If a negative result is obtained from the calculation, no refrigerant needs to be added.

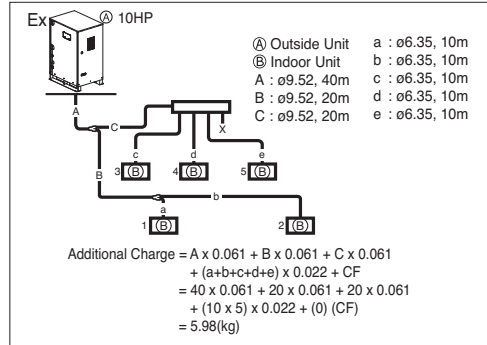

◆ Special condition

In case of the No. of CST TQ/RAC SE/ARTCOOL SF models are over than 50% of the connected indoor units when the total No. of connected indoor units are over than 50% of the max. connectable indoor units.

$$\text{Total amount(kg)} = (A) + (B) + (C)$$

■ Additional refrigerant charging amount (kg) : (C)

$$= (A \times \alpha + B \times \beta) - (AVG \times \beta)$$

- A = Total No. of TQ,SE and SF Indoor units, $\alpha = 0.5$
- B = Total No. of except TQ,SE and SF Indoor units, $\beta = 0.3$
- AVG = 50% of Max. No. of connectable Indoor units.

Example)

1) Installation Information

- Outside unit : 6HP
- Total indoor units : 6 units (TQ 3 units, SE 2 units, BH 1 unit)

2) Information from PDB

- Max. No. of connectable indoor units : 10 units
- Calculated additional refrigerant amount = 2 kg : (B)

3) Indoor refrigerant charging amount

$$= (5 \text{ units} \times 0.5 + 1 \text{ unit} \times 0.3) - (5 \text{ units} \times 0.3) = 1.3 \text{ kg} : (C)$$

- ▶ Revised the total additional charging amount = (B) + (C) = 2 kg + 1.3 kg = 3.3 kg

Note:

Fill in the f-gas Label attached on outside about the quantity of the fluorinated greenhouse gases

- ① Manufacturing site (See Model Name label)
- ② Installation site (If possible being placed adjacent to the service points for the addition or removal of refrigerant)
- ③ The total Charge (①+②)

⚠ WARNING

- ▶ Regulation for refrigerant leakage
: the amount of refrigerant leakage should satisfy the following equation for human safety.

$$\frac{\text{Total amount of refrigerant in the system}}{\text{Volume of the room at which Indoor Unit of the least capacity is installed}} \leq 0.44 \text{ (kg / m}^3 \text{)}$$

If the above equation can not be satisfied, then follow the following steps.

- Selection of air conditioning system: select one of the next
 1. Installation of effective opening part
 2. Reconfirmation of Outside Unit capacity and piping length
 3. Reduction of the amount of refrigerant
 4. Installation of 2 or more security device (alarm for gas leakage)
- Change Indoor Unit type
: installation position should be over 2m from the floor (Wall mounted type → Cassette type)
- Adoption of ventilation system
: choose ordinary ventilation system or building ventilation system
- Limitation in piping work
: Prepare for earthquake and thermal stress

⚠ WARNING

- ▶ Refer to model information since the CF Value of correction factor differs depending on model.

Caution

- Use the following materials for refrigerant piping.
 - Material: Seamless phosphorous deoxidized copper pipe
 - Wall thickness : Comply with the relevant local and national regulations for the designed pressure 3.8MPa. We recommend the following table as the minimum wall thickness.

Outer diameter [mm]	6.35	9.52	12.7	15.88	19.05	22.2	25.4	28.58	31.8	34.9	38.1	41.3
Minimum thickness [mm]	0.8	0.8	0.8	0.99	0.99	0.99	0.99	0.99	1.1	1.21	1.35	1.43

- Commercially available piping often contains dust and other materials. Always blow it clean with a dry inert gas.
- Use care to prevent dust, water or other contaminants from entering the piping during installation.
- Reduce the number of bending portions as much as possible, and make bending radius as big as possible.
- Always use the branch piping set shown below, which are sold separately.

Y branch		Header		
		4 branch	7 branch	10 branch
ARBLN01621	ARBLN03321	ARBL054	ARBL057	ARBL1010
ARBLN07121	ARBLN14521	ARBL104	ARBL107	ARBL2010

- If the diameters of the branch piping of the designated refrigerant piping differs, use a pipe cutter to cut the connecting section and then use an adapter for connecting different diameters to connect the piping.
- Always observe the restrictions on the refrigerant piping (such as rated length, difference in height, and piping diameter).
Failure to do so can result in equipment failure or a decline in heating/cooling performance.
- A second branch cannot be made after a header. (These are shown by ⊘.)

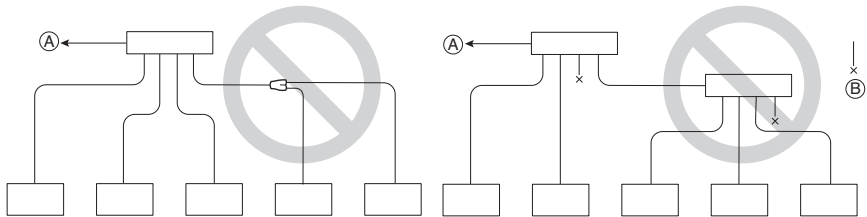

- (A) To Outside Unit
(B) Sealed Piping

- The Multi V will stop due to an abnormality like excessive or insufficient refrigerant. At such a time, always properly charge the unit. When servicing, always check the notes concerning both the piping length and the amount of additional refrigerant.
- Never perform a pump down. This will not only damage the compressor but also deteriorate the performance.**
- Never use refrigerant to perform an air purge. Always evacuate using a vacuum pump.**

Branch pipe Fitting

Y branch

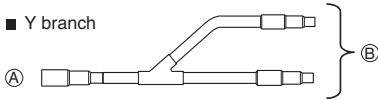

- (A) To Outside Unit
- (B) To Branch Piping or Indoor Unit

- Ensure that the branch pipes are attached horizontally or vertically (see the diagram below.)

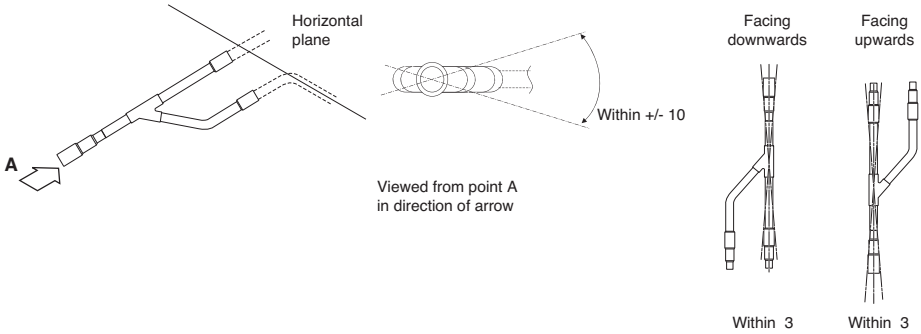

- There is no limitation on the joint mounting configuration.
- If the diameter of the refrigerant piping selected by the procedures described is different from the size of the joint, the connecting section should be cut with a pipe cutter.
- Branch pipe should be insulated with the insulator in each kit.

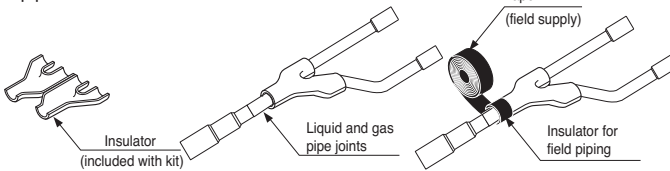

Header

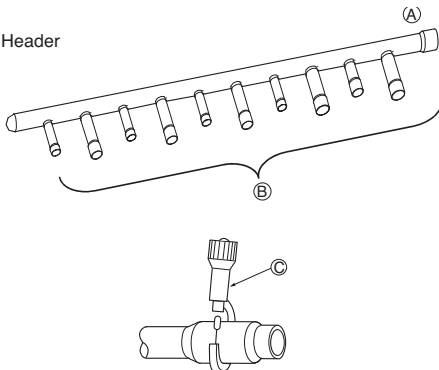

- (A) To outside unit
- (B) To indoor unit

- The indoor unit having larger capacity must be installed closer to (A) than smaller one.
- If the diameter of the refrigerant piping selected by the procedures described is different from the size of the joint, the connecting section should be cut with a pipe cutter.

(C) Pipe cutter

- When the number of pipes to be connected is smaller than the number of header branches, install a cap to the unconnected branches.

- When the number of indoor units to be connected to the branch pipes is less than the number of branch pipes available for connection then cap pipes should be fitted to the surplus branches.

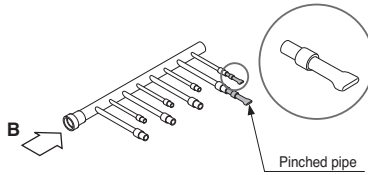

- Fit branch pipe lie in a horizontal plane.

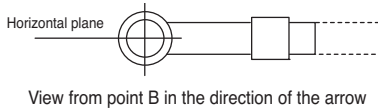

- Header should be insulated with the insulator in each kit.

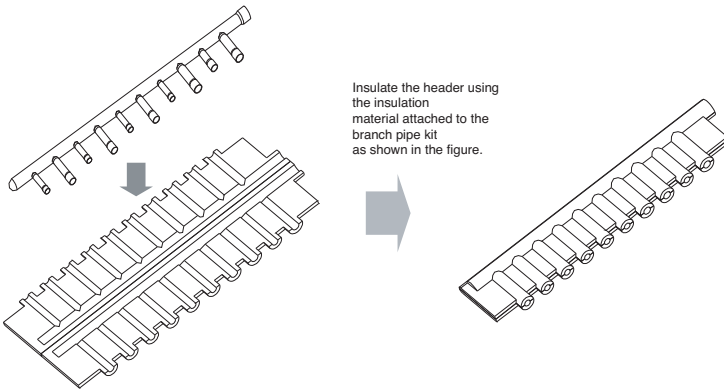

- Joints between branch and pipe should be sealed with the tape included in each kit.

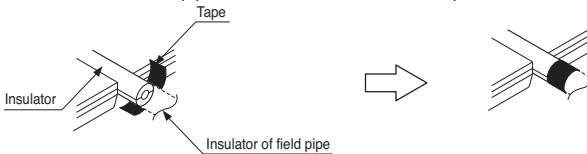

- Any cap pipe should be insulated using the insulator provided with each kit and then taped as described above.

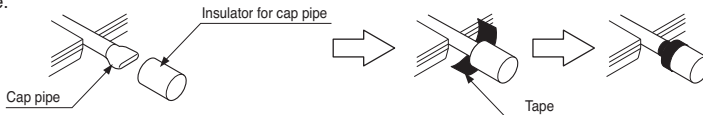

Thermal insulation of refrigerant piping

Be sure to give insulation work to refrigerant piping by covering liquid pipe and gas pipe separately with enough thickness heat-resistant polyethylene, so that no gap is observed in the joint between indoor unit and insulating material, and insulating materials themselves. When insulation work is insufficient, there is a possibility of condensation drip, etc. Pay special attention to insulation work to ceiling plenum.

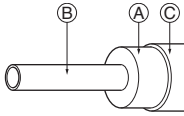

- (A) Heat insulation material
- (B) Pipe
- (C) Outer covering
(Wind the connection part and cutting part of heat insulation material with a finishing tape.)

Heat insulation material	Adhesive + Heat - resistant polyethylene foam + Adhesive tape	
Outer covering	Indoor	Vinyl tape
	Floor exposed	Water-proof hemp cloth + Bronze asphalt
	Outside	Water-proof hemp cloth + Zinc plate + Oily paint

Note:
When using polyethylene cover as covering material, asphalt roofing shall not be required.

<p>Bad example</p>	<ul style="list-style-type: none"> • Do not insulate gas or low pressure pipe and liquid or high pressure pipe together. • Be sure to fully insulate connecting portion.
<p>Good example</p>	<p>(A) Liquid pipe (B) Gas pipe (C) Power lines (D) Finishing tape (E) Insulating material (F) Transmission lines</p> <p>(A) These parts are not insulated.</p>

Penetrations

Inner wall (concealed)

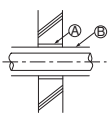

Outer wall

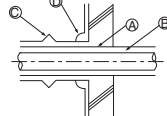

Outer wall (exposed)

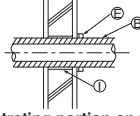

Floor (fireproofing)

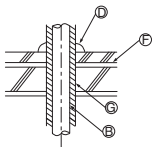

Roof pipe shaft

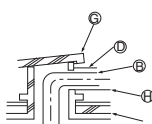

Penetrating portion on fire limit and boundary wall

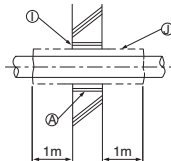

- (A) Sleeve
- (B) Heat insulating material
- (C) Lagging
- (D) Caulking material
- (E) Band
- (F) Waterproofing layer
- (G) Sleeve with edge
- (H) Lagging material
- (I) Mortar or other incombustible caulking
- (J) Incombustible heat insulation material

When filling a gap with mortar, cover the penetration part with steel plate so that the insulation material will not be caved in. For this part, use incombustible materials for both insulation and covering. (Vinyl covering should not be used.)

Y branch pipe and header branch pipe type

Y branch pipe

[unit:mm]

Models	Gas pipe	Liquid pipe
<p>ARBLN01621</p>		
<p>ARBLN03321</p>		
<p>ARBLN07121</p>		
<p>ARBLN14521</p>		

* For example. Indicated Ø9.52 is the outer diameter(O.D..) of field jointed piping

Header

[unit:mm]

Models	Gas pipe	Liquid pipe
4 branch ARBL054		
7 branch ARBL057		
4 branch ARBL104		
7 branch ARBL107		
10 branch ARBL1010		
10 branch ARBL2010		

Leakage test and vacuum

Leak test

Leak test should be made by pressurizing nitrogen gas to 3.8 MPa(38.7kgf/cm²). If the pressure does not drop for 24 hours, the system passes the test. If the pressure drops, check where the nitrogen leaks. For the test method, refer to the following figure. (Make a test with the service valves closed. Be also sure to pressurize liquid pipe, gas pipe and high/low pressure common pipe)

The test result can be judged good if the pressure has not been reduced after leaving for about one day after completion of nitrogen gas pressurization.

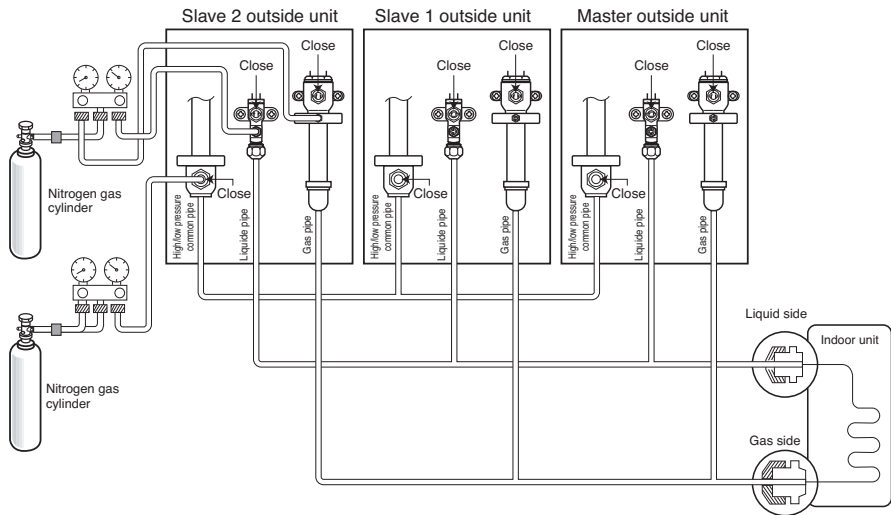

Note:

If the ambient temperature differs between the time when pressure is applied and when the pressure drop is checked, apply the following correction factor

There is a pressure change of approximately 0.1 kg/cm² (0.01 MPa) for each 1°C of temperature difference.

Correction= (Temp. at the time of pressurization – Temp. at the time of check) X 0.1

For example: Temperature at the time of pressurization (3.8 MPa) is 27 °C

24 hour later: 3.73 MPa, 20°C

In this case the pressure drop of 0.07 is because of temperature drop

And hence there is no leakage in pipe occurred.

CAUTION

To prevent the nitrogen from entering the refrigeration system in the liquid state, the top of the cylinder must be at higher position than the bottom when you pressurize the system. Usually the cylinder is used in a vertical standing position.

Vacuum

Vacuum drying should be made from the service port provided on the outside unit's service valve to the vacuum pump commonly used for liquid pipe, gas pipe and high/low pressure common pipe. (Make Vacuum from liquid pipe, gas pipe and high/low pressure common pipe with the service valve closed.)

* Never perform air purging using refrigerant.

• Vacuum drying: Use a vacuum pump that can evacuate to -100.7kPa (5 Torr, -755mmHg).

1. Evacuate the system from the liquid and gas pipes with a vacuum pump for over 2 hrs and bring the system to -100.7kPa .
After maintaining system under that condition for over 1 hr, confirm the vacuum gauge rises. The system may contain moisture or leak.
2. Following should be executed if there is a possibility of moisture remaining inside the pipe.
(Rainwater may enter the pipe during work in the rainy season or over a long period of time)
After evacuating the system for 2 hrs, give pressure to the system to 0.05MPa (vacuum break) with nitrogen gas and then evacuate it again with the vacuum pump for 1hr to -100.7kPa (vacuum drying). If the system cannot be evacuated to -100.7kPa within 2 hrs, repeat the steps of vacuum break and its drying.
Finally, check if the vacuum gauge does not rise or not, after maintaining the system in vacuum for 1 hr.

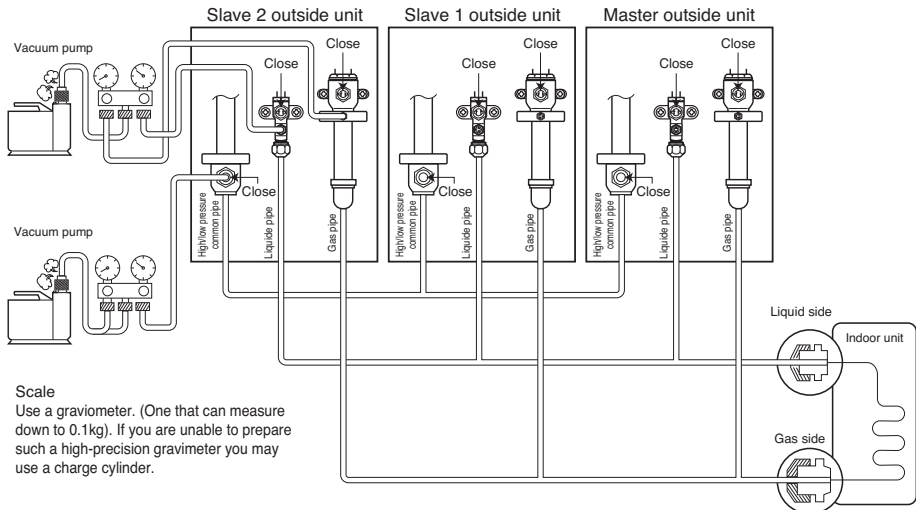

Scale

Use a gravimeter. (One that can measure down to 0.1kg). If you are unable to prepare such a high-precision gravimeter you may use a charge cylinder.

Note : Always add an appropriate amount of refrigerant. (For the refrigerant additional charge)
Too much or too little refrigerant will cause trouble.
To use the Vacuum Mode
(If the Vacuum mode is set, all valves of Indoor units and Outside units will be opened.)

• Vacuum should be done for 3 hours or more after the pressure is under 0.5 torr.

WARNING

When installing and moving the air conditioner to another site, recharge after perfect evacuation.

- If a different refrigerant or air is mixed with the original refrigerant, the refrigerant cycle may malfunction and the unit may be damaged.

Electrical Wiring

Caution

1. Follow ordinance of your governmental organization for technical standard related to electrical equipment, wiring regulations and guidance of each electric power company.

⚠ WARNING

Be sure to have authorized electrical engineers do the electric work using special circuits in accordance with regulations and this installation manual. If power supply circuit has a lack of capacity or electric work deficiency, it may cause an electric shock or fire.

2. Install the Outside Unit transmission line away from the power source wiring so that it is not affected by electric noise from the power source. (Do not run it through the same conduit.)
3. Be sure to provide designated grounding work to Outside Unit.

⚠ CAUTION

Be sure to correct the outside unit to earth. Do not connect earth line to any gas pipe, water pipe, lightning rod or telephone earth line. If earth is incomplete, it may cause an electric shock.

4. Give some allowance to wiring for electrical part box of Indoor and Outside Units, because the box is sometimes removed at the time of service work.
5. Never connect the main power source to terminal block of transmission line. If connected, electrical parts will be burnt out.
6. Use 2-core shield cable for transmission line. (O mark in the figure below) If transmission lines of different systems are wired with the same multicore cable, the resultant poor transmitting and receiving will cause erroneous operations. (⊗ mark in the figure below)
7. Only the transmission line specified should be connected to the terminal block for Outside Unit transmission.

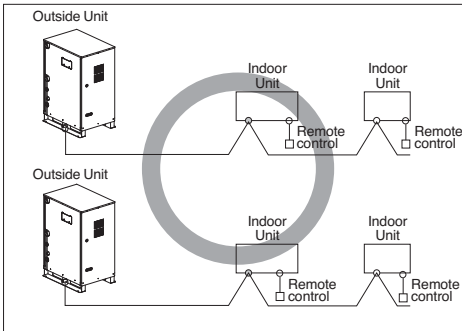

2-core shield cable

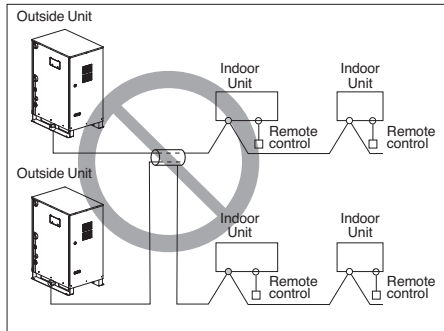

Multi-core cable

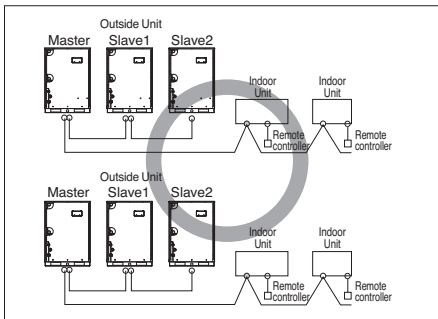

2-Core Shield Cable

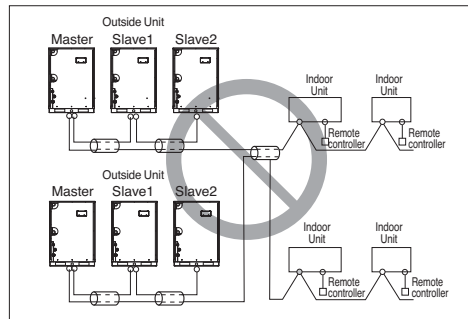

Multi-Core Cable

⚠ CAUTION

- Use the 2-core shield cables for transmission lines. Never use them together with power cables.
- The conductive shielding layer of cable should be grounded to the metal part of both units.
- Never use multi-core cable
- As this unit is equipped with an inverter, to install a phase leading capacitor not only will deteriorate power factor improvement effect, but also may cause capacitor abnormal heating. Therefore, never install a phase leading capacitor.
- Make sure that the power unbalance ratio is not greater than 2%. If it is greater the units lifespan will be reduced.

◆ Precautions when laying power wiring

Use round pressure terminals for connections to the power terminal block.

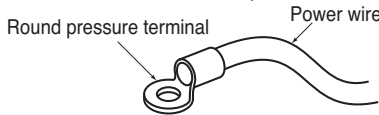

When none are available, follow the instructions below.

- Do not connect wiring of different thicknesses to the power terminal block. (Slack in the power wiring may cause abnormal heat.)
- When connecting wiring which is the same thickness, do as shown in the figure below.

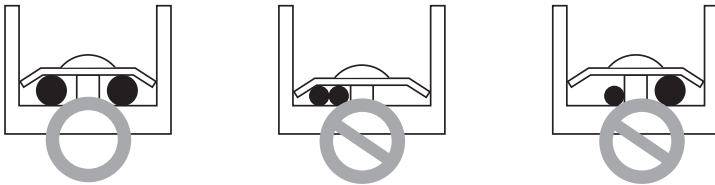

- For wiring, use the designated power wire and connect firmly, then secure to prevent outside pressure being exerted on the terminal block.
- Use an appropriate screwdriver for tightening the terminal screws. A screwdriver with a small head will strip the head and make proper tightening impossible.
- Over-tightening the terminal screws may break them.

⚠ CAUTION

When the 400 volt power supply is applied to "N" phase by mistake, replace inverter PCB and transformer in control box.

⚠ CAUTION

The Power cord connected to the unit should be selected according to the following specifications.

Control Box and Wiring Location

- Unscrew all the screw, pull out the panel.
- Connect the transmission wire between outside unit and indoor unit, the connection between outside unit and central controller system pass through the sub PCB for central control.
- When connecting indoor unit with the shield cable, ground at the grounding screw.
When connecting central controller with the shield cable, ground at the grounding screw.
- Refer to next page about the distance between main power cable and communication cable.

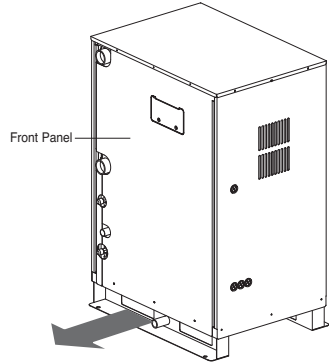

Transmission and Power Lines

1) Transmission cable

- Types : shielding wire
- Diameter : 1.0 ~ 1.5mm²
- Maximum allowable temperature: 60°C
- Maximum allowable line length: under 300m

2) Remote control cable

- Types : 3-core cable

3) Simple central control cable

- Types : 4-core cable (Shielding wire)
- Diameter : 1.0 ~ 1.5mm²

4) Separation of transmission and power lines

- If transmission and power lines are run alongside each other then there is a strong likelihood of operational faults developing due to interference in the signal wiring caused by electrostatic and electromagnetic coupling.

The tables below indicates our recommendation as to appropriate spacing of transmission and power lines where these are to be run side by side

Current capacity of power line		Spacing
100V or more	10A	300mm
	50A	500mm
	100A	1000mm
	Exceed 100A	1500mm

Note:

1. The figures are based on assumed length of parallel cabling up to 100m. For length in excess of 100m the figures will have to be recalculated in direct proportion to the additional length of line involved.
 2. If the power supply waveform continues to exhibit some distortion the recommended spacing in the table should be increased.
- If the lines are laid inside conduits then the following point must also be taken into account when grouping various lines together for introduction into the conduits
 - Power lines(including power supply to air conditioner) and signal lines must not be laid inside the same
 - In the same way, when grouping the lines power and signal lines should not be bunched together.

CAUTION

If apparatus is not properly earthed then there is always a risk of electric shocks, the earthing of the apparatus must be carried out by a qualified person.

◆ Wiring of Main Power Supply and Equipment Capacity

1. Use a separate power supply for the Outside Unit and Indoor Unit.
2. Bear in mind ambient conditions (ambient temperature, direct sunlight, rain water, etc.) when proceeding with the wiring and connections.
3. The wire size is the minimum value for metal conduit wiring. The power cord size should be 1 rank thicker taking into account the line voltage drops. Make sure the power-supply voltage does not drop more than 10%.
4. Specific wiring requirements should adhere to the wiring regulations of the region.
5. Power supply cords of parts of appliances for outside use should not be lighter than polychloroprene sheathed flexible cord.
6. Don't install an individual switch or electrical outlet to disconnect each of indoor unit separately from the power supply.

⚠ WARNING

- Follow ordinance of your governmental organization for technical standard related to electrical equipment, wiring regulations and guidance of each electric power company.
- Make sure to use specified wires for connections so that no external force is imparted to terminal connections. If connections are not fixed firmly, it may cause heating or fire.
- Make sure to use the appropriate type of overcurrent protection switch. Note that generated overcurrent may include some amount of direct current.

⚠ CAUTION

- Some installation site may require attachment of an earth leakage breaker. If no earth leakage breaker is installed, it may cause an electric shock.
- Do not use anything other than breaker and fuse with correct capacity. Using fuse and wire or copper wire with too large capacity may cause a malfunction of unit or fire.

1. 50Hz

◆ Example Connection of Transmission Cable

1 Outside Unit

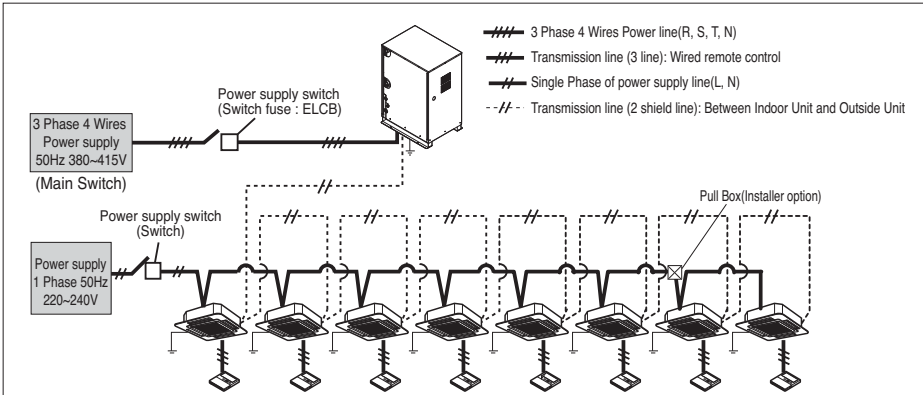

⚠ WARNING

- Indoor Unit ground Lines are required for preventing electrical shock accident during current leakage, Transmission disorder by noise effect and motor current leakage (without connection to pipe).
- Don't install an individual switch or electrical outlet to disconnect each of indoor unit separately from the power supply.
- Install the main switch that can interrupt all the power sources in an integrated manner because this system consists of the equipment utilizing the multiple power sources.
- If there exists the possibility of reversed phase, lose phase, momentary blackout or the power goes on and off while the product is operating, attach a reversed phase protection circuit locally. Running the product in reversed phase may break the compressor and other parts.

Between Indoor and Master Outside unit

SODU	IDU	INTERNET	DRY1	DRY2	GND	12V	Master Outside unit
B	A		B	A			

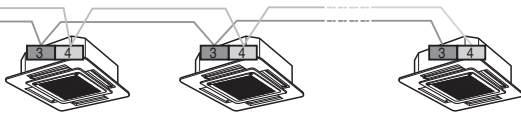

The GND terminal is a 'L' terminal for the central controller, not Ground Line

◆ Example Connection of Transmission Cable 2 Outside Units

■ When the power source is connected in series between the units.

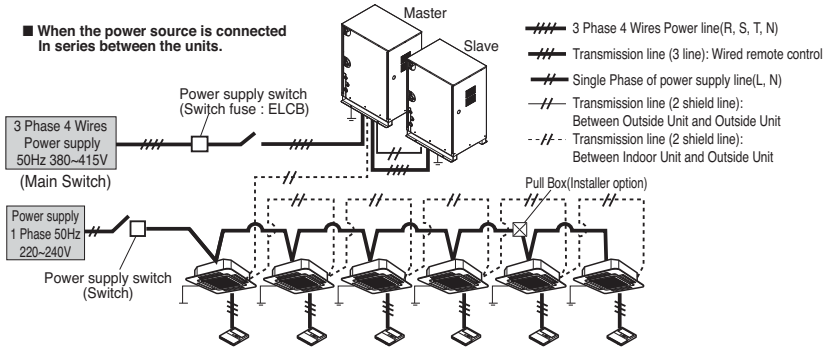

■ When the power source is supplied to Each outside unit individually.

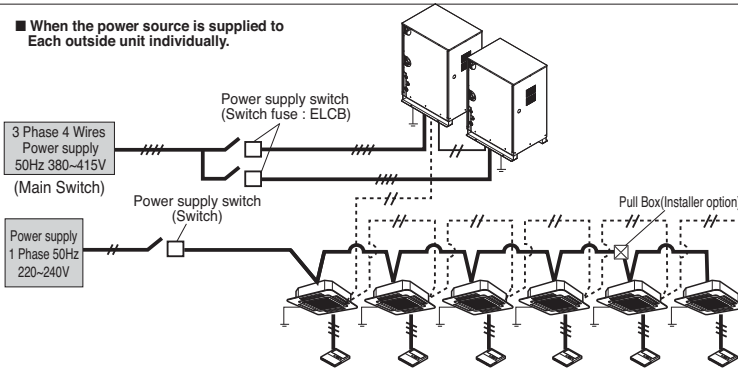

⚠ WARNING

- Indoor Unit ground Lines are required for preventing electrical shock accident during current leakage, Transmission disorder by noise effect and motor current leakage (without connection to pipe).
 - Don't install an individual switch or electrical outlet to disconnect each of indoor unit separately from the power supply.
 - Install the main switch that can interrupt all the power sources in an integrated manner because this system consists of the equipment utilizing the multiple power sources.
 - If there exists the possibility of reversed phase, lose phase, momentary blackout or the power goes on and off while the product is operating, attach a reversed phase protection circuit locally.
- Running the product in reversed phase may break the compressor and other parts.

Between Indoor and Master Outside unit

SODU	IDU	INTERNET	DRY1	DRY2	GND	12V
B	A					

Master
Outside unit

SODU	IDU	INTERNET	DRY1	DRY2	GND	12V
B	A					

Master
Outside unit



SODU	IDU	INTERNET	DRY1	DRY2	GND	12V
B	A					

Slave
Outside unit

The GND terminal is a 'L' terminal for the central controller, not Ground Line

- Make sure that terminal number of master and slave outside units are matched.(A-A,B-B)

◆ Example Connection of Transmission Cable 3 Outside Units

■ When the power source is connected in series between the units.

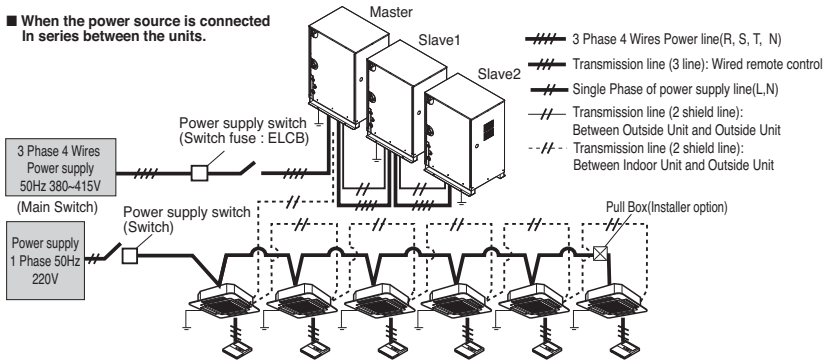

■ When the power source is supplied to Each outside unit individually.

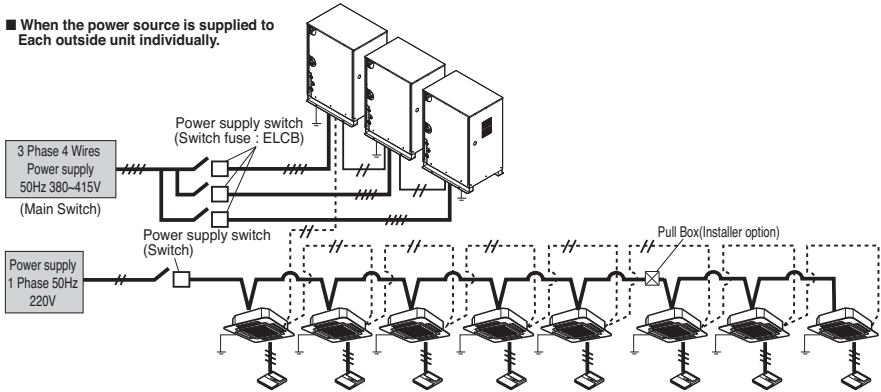

⚠ WARNING

- Indoor Unit ground Lines are required for preventing electrical shock accident during current leakage, Transmission disorder by noise effect and motor current leakage (without connection to pipe).
- Don't install an individual switch or electrical outlet to disconnect each of indoor unit separately from the power supply.
- Install the main switch that can interrupt all the power sources in an integrated manner because this system consists of the equipment utilizing the multiple power sources.
- If there exists the possibility of reversed phase, lose phase, momentary blackout or the power goes on and off while the product is operating, attach a reversed phase protection circuit locally.
Running the product in reversed phase may break the compressor and other parts.

Between Indoor and Master Outside unit

SODU	IDU	INTERNET	DRY1	DRY2	GND	12V
B	A		B	A		

Master Outside unit



The GND terminal is a \perp terminal for the central controller, not Ground Line

SODU	IDU	INTERNET	DRY1	DRY2	GND	12V
B	A		B	A		

Master Outside unit

SODU	IDU	INTERNET	DRY1	DRY2	GND	12V
B	A		B	A		

Slave1 Outside unit

SODU	IDU	INTERNET	DRY1	DRY2	GND	12V
B	A		B	A		

Slave2 Outside unit

2. 60Hz

◆ Example Connection of Transmission Cable

1 Outside Unit

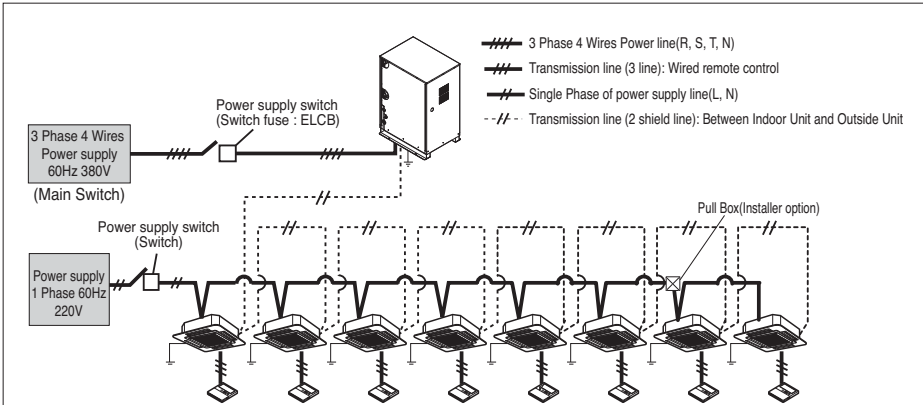

⚠ WARNING

- Indoor Unit ground Lines are required for preventing electrical shock accident during current leakage, Transmission disorder by noise effect and motor current leakage (without connection to pipe).
- Don't install an individual switch or electrical outlet to disconnect each of indoor unit separately from the power supply.
- Install the main switch that can interrupt all the power sources in an integrated manner because this system consists of the equipment utilizing the multiple power sources.
- If there exists the possibility of reversed phase, lose phase, momentary blackout or the power goes on and off while the product is operating, attach a reversed phase protection circuit locally. Running the product in reversed phase may break the compressor and other parts.

Between Indoor and Master Outside unit

SODU	IDU	INTERNET	DRY1	DRY2	GND	12V	Master Outside unit
B	A		B	A			

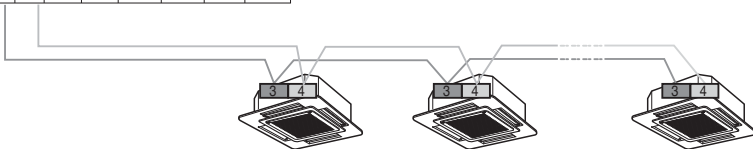

The GND terminal is a 'L' terminal for the central controller, not Ground Line

◆ Example Connection of Transmission Cable 2 Outside Units

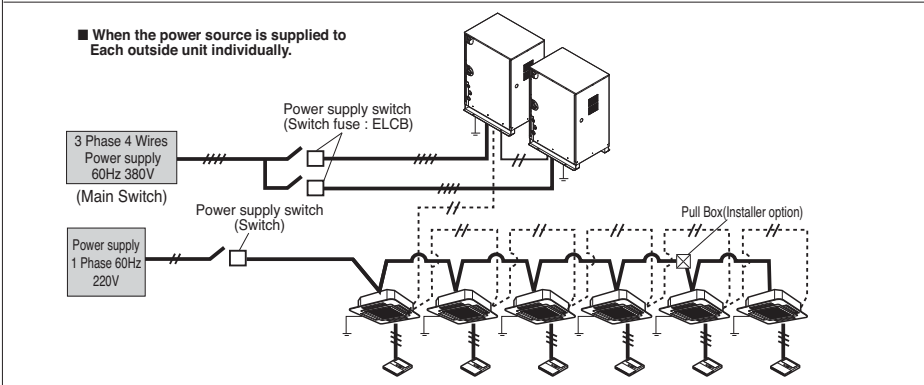
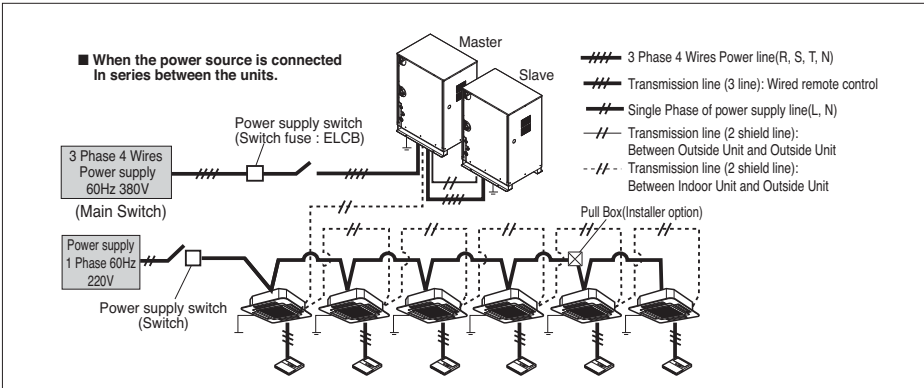

⚠ WARNING

- Indoor Unit ground Lines are required for preventing electrical shock accident during current leakage, Transmission disorder by noise effect and motor current leakage (without connection to pipe).
 - Don't install an individual switch or electrical outlet to disconnect each of indoor unit separately from the power supply.
 - Install the main switch that can interrupt all the power sources in an integrated manner because this system consists of the equipment utilizing the multiple power sources.
 - If there exists the possibility of reversed phase, lose phase, momentary blackout or the power goes on and off while the product is operating, attach a reversed phase protection circuit locally.
- Running the product in reversed phase may break the compressor and other parts.

Between Indoor and Master Outside unit

SODU	IDU	INTERNET	DRY1	DRY2	GND	12V
B	A		B	A		

Master
Outside unit

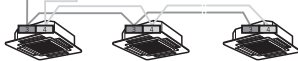

SODU	IDU	INTERNET	DRY1	DRY2	GND	12V
B	A		B	A		

Master
Outside unit

SODU	IDU	INTERNET	DRY1	DRY2	GND	12V
B	A		B	A		

Slave
Outside unit

The GND terminal is a 'L' terminal for the central controller, not Ground Line

- Make sure that terminal number of master and slave outside units are matched. (A-A, B-B)

◆ Example Connection of Transmission Cable 3 Outside Units

■ When the power source is connected in series between the units.

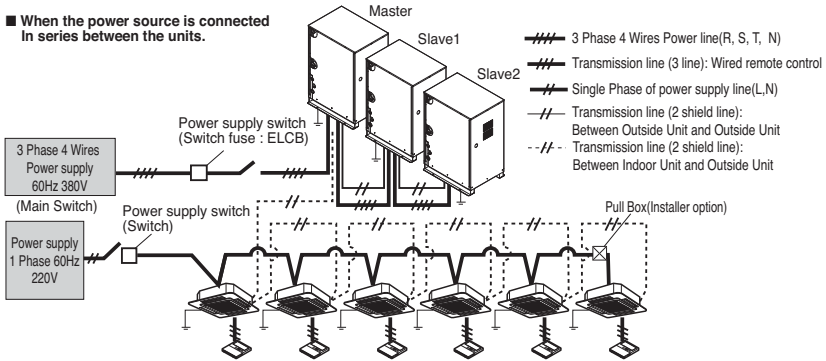

■ When the power source is supplied to Each outside unit individually.

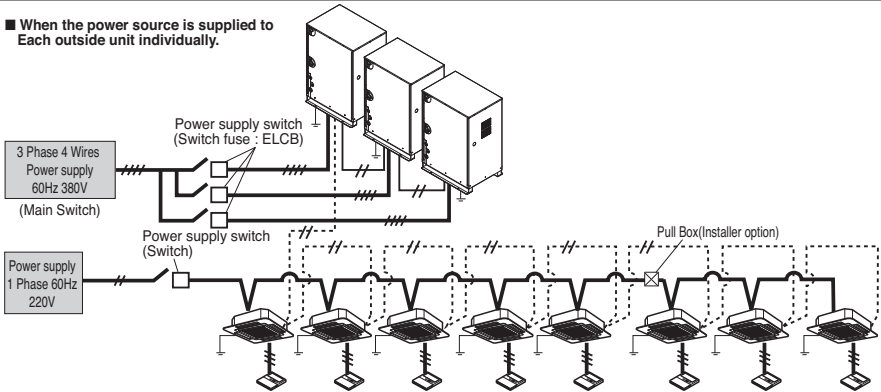

⚠ WARNING

- Indoor Unit ground Lines are required for preventing electrical shock accident during current leakage, Transmission disorder by noise effect and motor current leakage (without connection to pipe).
- Don't install an individual switch or electrical outlet to disconnect each of indoor unit separately from the power supply.
- Install the main switch that can interrupt all the power sources in an integrated manner because this system consists of the equipment utilizing the multiple power sources.
- If there exists the possibility of reversed phase, lose phase, momentary blackout or the power goes on and off while the product is operating, attach a reversed phase protection circuit locally.
Running the product in reversed phase may break the compressor and other parts.

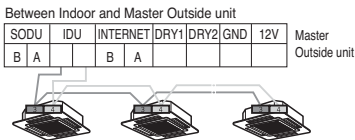

The GND terminal is a "L" terminal for the central controller, not Ground Line

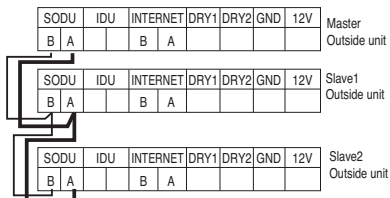

◆ Example Connection of Communication Cable

[BUS type]

• Connection of communication cable must be installed like below figure between indoor unit to outside unit.

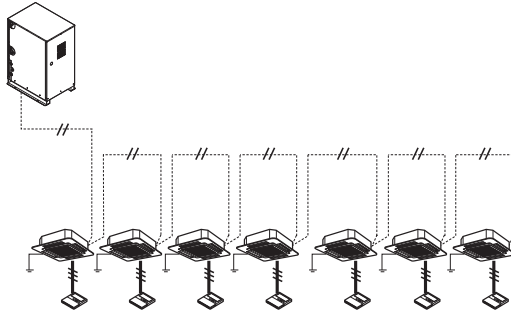

[STAR type]

• Abnormal operation can be caused by communication defect, when connection of communication cable is installed like below figure(STAR type).

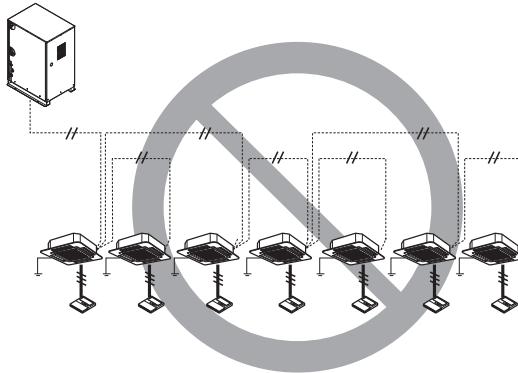

External wiring

External wires should be connected as follows.

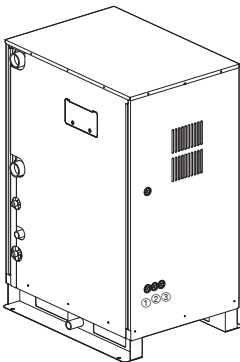

- ① Main power cable
- ② Communication cable
- ③ Solenoid valve control cable (option)
flow switch communication cable (option)

Dip switch setting

1. Location of setting switch

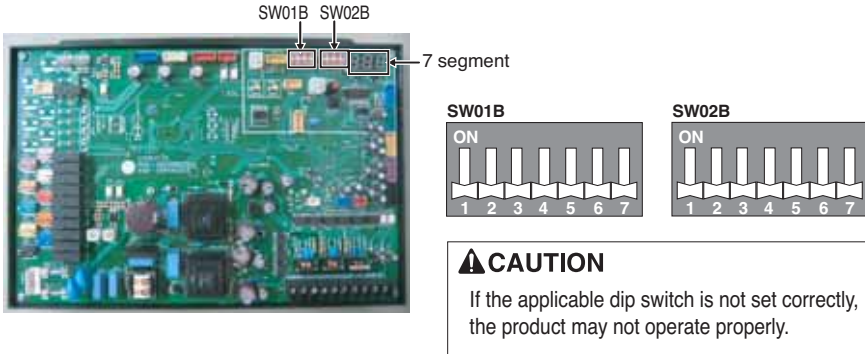

⚠ CAUTION
If the applicable dip switch is not set correctly, the product may not operate properly.

2. Dip switch setting

- 1) Set the dip switch and turn on the power of the outside unit to check whether the set value is correctly entered in the 7 segment.
- 2) This function is shown for only 2 seconds after the power is connected.

■ Check outside unit setting

- The number on the 7 segment is displayed in order after the power is connected.
- This number represents the setting condition.

Order	Number	Item
1	-	Model code
2	-	Total capacity(HP)
3	2	Heat pump model
4	25	Normal mode display (If the dip switch is set incorrectly, it is not displayed.)
5	130	Model type (Normal, 380V)

■ Mode code

Model Code	Capacity (HP)	Refrigerant
133	8	R410A
134	10	
130	16	
131	18	
135	20	
131, 130	24	
134, 130	26	
134, 131	28	
135, 134	30	
130, 130	32	
131, 130	34	
131, 131	36	
135, 131	38	
135, 135	40	
134, 130, 130	42	
134, 131, 130	44	
134, 131, 131	46	
135, 131, 134	48	
135, 135, 134	50	
131, 131, 130	52	
135, 131, 130	54	
135, 131, 131	56	
135, 135, 131	58	
135, 135, 135	60	





■ Master Outside Setting

SW01B Setting	SW02B Setting	Remark
		Normal mode at shipping factory

■ Slave outside Setting (1 unit: master outside)

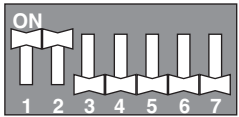
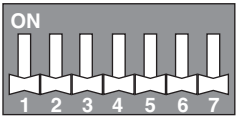
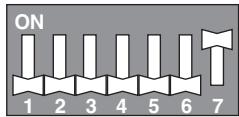
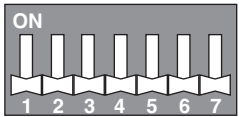
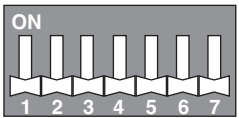
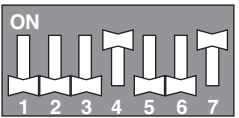
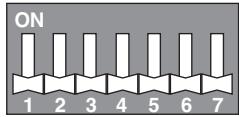
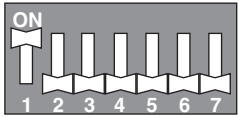
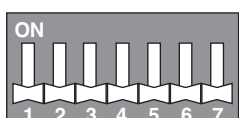
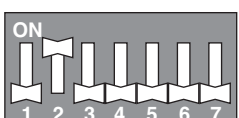
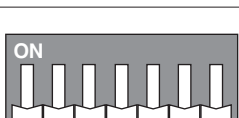
SW01B Setting	SW02B Setting	Remark
		Normal mode at shipping factory
		Slave1 outside setting (at the 2units)
		Slave2 outside setting (at the 3units)

Function	SW01B Setting	SW02B Setting	Remark
Standard			Standard mode at shipping factory
Short Pipe Length			
Long Pipe Length			

Function	SW01B Setting	SW02B Setting	Remark
longest Pipe Length			Standard mode at shipping factory
Forced Oil Return			
Vacuum Mode			
Ground source mode			Use this mode when temperature of circulation inlet water is under 10°C(50°F). (You should use an anti freeze)
Variable Water Flow Control Mode			You should install the variable water flow valve control kit before using this mode
Water Pipe Solenoid Valve 220V Functions			For water pipe Solenoid Valve 220V power
Dry contact Mode			

CAUTION

- After operating the dip switch to set the additional function, you must reset the power of the main PCB to reflect the changed function. (After recovering the dip switch to cancel the additional function, you must reset the power of the main PCB to reflect the change.)
- If the dip switch is not set accurately, it can have excessive load on the product operation. Set the dip switch properly.

Indoor unit auto addressing

• The address of indoor units would be set by auto addressing

- 1) Wait for 3 minutes after applying power supply (master and sub outside unit, indoor unit).
- 2) Press the switch of the outside unit (SW02V) for 5 seconds.
- 3) A "88" is indicated on 7-segment LED of the outside unit PCB.
- 4) For completing addressing, 2~7 minutes are required depending on numbers of indoor unit connection set.
- 5) Numbers of indoor unit connection set whose addressing is completed are indicated for 30seconds on 7-segment LED of the outside unit PCB.
- 6) After completing addressing, address of each indoor unit is indicated on the wired remote control display window.
(CH01, CH02, CH03, CH06: Indicated as numbers of indoor unit connection set.)

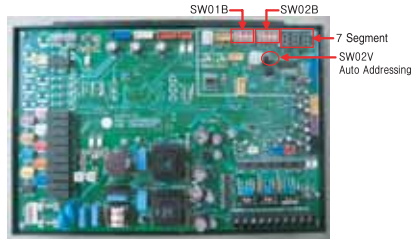

CAUTION

- In replacement of the indoor unit PCB, always perform auto address setting again. If power supply is not applied to the indoor unit, operation error occurs. Auto addressing is only possible on the main PCB
- Auto addressing has to be performed after 3 minutes to improve communication.

◆ The Procedure of Automatic Addressing

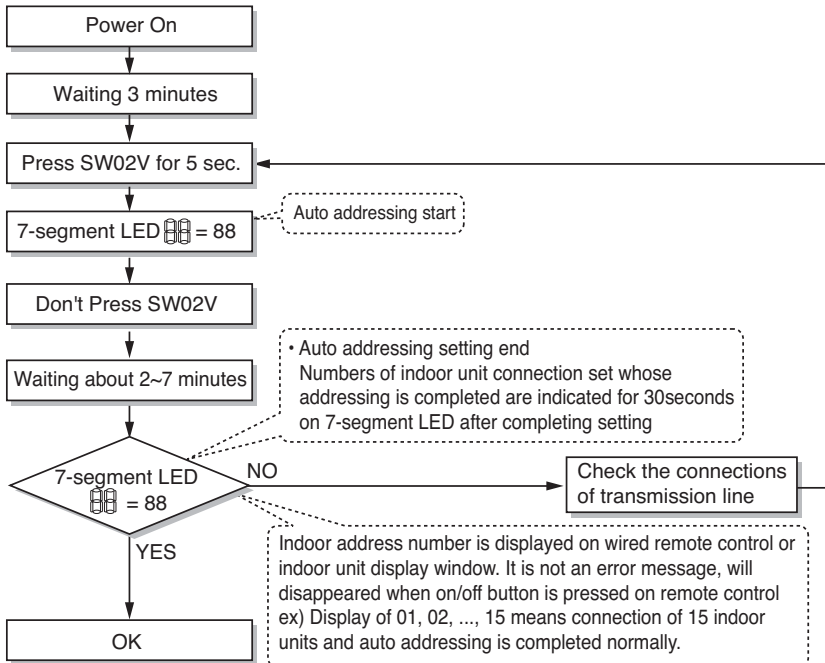

Group Number setting

Group Number setting for Indoor Units

- ① Confirm the power of whole system(Indoor Unit, Outside Unit) is OFF, otherwise turn off.
- ② The transmission lines connected to INTERNET terminal should be connected to central control of Outside unit with care for their polarity(A → A, B → B)
- ③ Turn the whole system on.
- ④ Set the group and Indoor Unit number with a wired remote control.
- ⑤ To control several sets of Indoor Units into a group, set the group ID from 0 to F for this purpose.

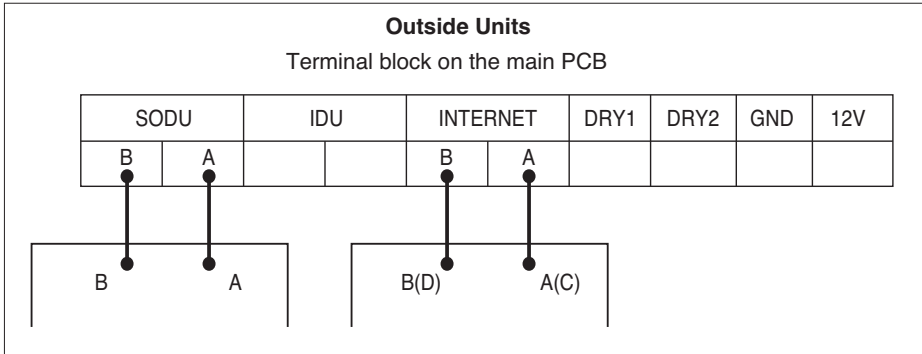

Group recognizing the simple central controller
No.0 group (00~0F)
No.1 group (10~1F)
No.2 group (20~2F)
No.3 group (30~3F)
No.4 group (40~4F)
No.5 group (50~5F)
No.6 group (60~6F)
No.7 group (70~7F)
No.8 group (80~8F)
No.9 group (90~9F)
No. A group (A0~AF)
No. B group (B0~BF)
No. C group (C0~CF)
No. D group (D0~DF)
No. E group (E0~EF)
No. F group (F0~FF)

Outside unit Dry Contact installation and connection

- Connect wires as below figure at the hole of backside of Outside Unit Dry Contact.
- Insert the wire in the connection hole pushing the "Push" button.
- Setting Main PCB Dip SW of Master Outside Unit.

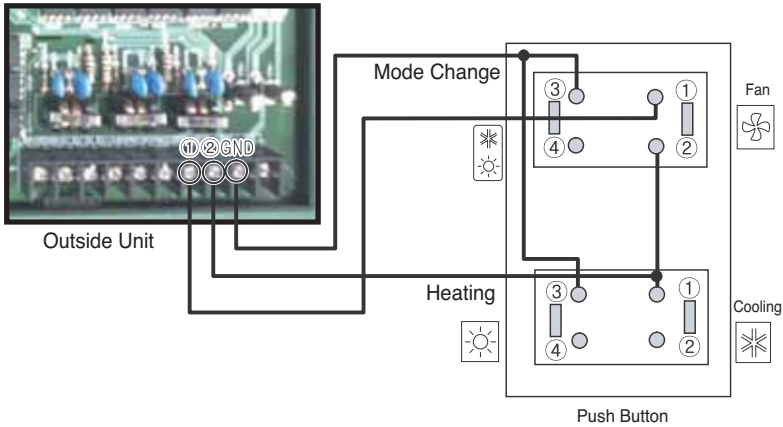

Mode setting without Cool/Heat Selector

In case of no Cool/Heat Selector, connect signal terminal block as below figure And description.
Connect signal terminal block as below figure and description.

- How to set mode without Cool/Heat Selector

• Cooling Mode Setting

- ① → GND Connection
- ② → Off (Open)

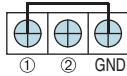

• Heating Mode Setting

- ① → GND Connection
- ② → GND Connection

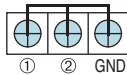

• Fan Mode Setting

- ① → Off (Open)
- ② → GND Connection

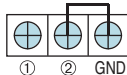

Test Run

Water supply system test run

- Before executing the test run for the product, you must first test the heat source water system. The test run for the product must be executed after checking the flow rate and temperature of the heat source water supplied.

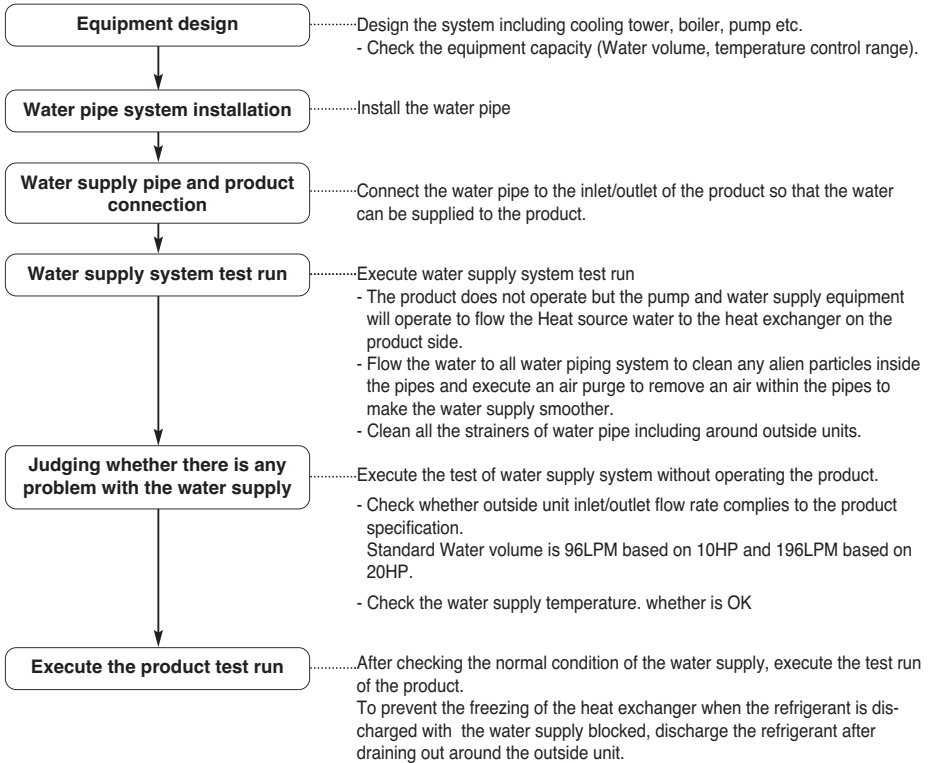

Precaution before test run

1	Check whether the air is completely removed and the water supply is flowing smoothly.
2	Check whether there is any refrigerant leakage of any disconnected or loose communication or power wire, or use the electric wiring diagram to check the wiring connection condition. Check whether the power and communication wire are connected.
3	Check whether the power cable R, S, T and N are correctly connected. Check the insulation resistance with the DB mega tester device (DC 500V) between the power terminal block and grounding, and check whether it is 2.0MΩ or above when measured. If the resistance is 2.0MΩ or less, do not operate the product. Precaution) - Never check the insulation resistance for the terminal control board. (The control board can be damaged.) - If you leave the system turned off right after the installation or for a long period of time, the refrigerant gets accumulated within the compressor and the insulation resistance reduces to less than 2 MΩ. When the insulation resistance is 2 MΩ or less, turn on the power and let the electricity be supplied to the crank case heater of the compressor and let the refrigerant including the oil inside the compressor to evaporate. Then the insulation resistance value will increase to more than 2.0 MΩ.
4	Check whether the liquid and gas pipes are open.
5	Precaution when blocking the water cooling type Multi V main power - While using the product (Air conditioning season/Heating season), always connect the main power of the outside unit. - During the test run operation after installing the product or during the operation after blocking the outside unit main power (Power outage etc.), you must always connect the power 6 hours prior to heating the crank case heater. If the crank case is not preheated for more than 6 hours with the electric heater, it can cause a burn on the compressor. (Heating the bottom part of the compressor with the crank case heater is to evaporate the refrigerant included in the oil inside the compressor.)

⚠ WARNING

- **Always check whether the water supply is flowing smoothly before the test run. (If sufficient amount of water is not flowing, it can burn the product.)**
- **During the initial test run after installing the product, leaving the product for more than 3 days or after replacing the compressor, power must be connected 6 hours prior to the operation to heat the compressor heater. (If the product is not heated sufficiently, it can burn the product.)**

How to Cope with Abnormal Test Run

Item	Phenomenon	Cause	Checkpoint and resolution
Whether heat water is supplied	CH24	When connecting the flow switch, heat-sourced water doesn't flow or the amount of its flow lacks due to the checked error related to heat-sourced water.	Check whether the heat source water supply pump is operating.
			Check whether the heat source water supply pipe is clogged. (Clean strainer, valve locked, valve issue, air trapped etc.)
	CH32	Heat water not supplied or flow rate is insufficient	Check whether the flow switch is normal condition. (Flow switch problem, arbitrary control, disconnection etc.)
			Check whether heat source water supply pump is operating.
	CH34	Heat water not supplied or flow rate is insufficient(During Cooling)	Check whether the heat source water supply pipe is clogged. (Clean strainer, valve locked, valve issue, air trapped etc.)
			Check whether heat source water supply pump is operating.
	CH180	Heat water not supplied or flow rate is insufficient (During heating)	Check whether heat source water supply pump is operating.
			Check whether the heat source water supply pipe is clogged. (Clean strainer, valve locked, valve issue, air trapped etc.)

※ When CH24 or CH180 error occurs during the test operation of the heater, the inside of the panel heat exchanger may be partially frozen and therefore, be sure to get rid of its cause and then, re-operate the device.

(The root cause of partial freezing: The lack of flow of heat-sourced water, suspension of water, lack of cooling medium, infiltration of foreign substance inside of panel heat exchanger)

Maintenance of plate type heat exchanger

As the scales are created in the panel heat exchanger, its efficiency may decrease or damage may occur due to winter-sowing due to the decrease in its flow.

Due to this reason, regular maintenance is necessary so that the scales shouldn't be created.

- Before the season of use, check below points.(Once a year)
 - inspection on water quality to check if this is within the standard condition.
 - Clean the strainer.
 - Check if the flow is appropriate.
 - Check if the operation environment is appropriate.(Pressure, flow, output temperature)
- Below procedure should be abided by in order to clean the panel heat exchanger. (Once every 5 years)
 - Check if the service port is equipped with the water pipe in order to clean the chemical solution.

5% diluted formic acid, citric acid, oxalic acid, acetate acid, phosphoric acid and etc. are appropriate for the chemical solution for wiping out the scales.(Hydrochloric acid, sulphuric acid, nitric acid and etc. shouldn't be used due to its corrosion.)
 - Be sure to check if the gate valve of inflow/outflow pipe and the valve for outflow pipe are properly closed when cleaning.
 - Connect the water pipe for cleaning with the chemical solvent through the service plug of the pipe and fill up the panel heat exchanger with 50°C~60°C of cleaning solvent and circulate it with the pump for 2~5 hours. The circulation time may depend on the temperature of the cleaning solvent or the creation of the scales. Therefore, observe change in the color of the chemical solvent to set the circulation time for removing the scales.
 - After the circulation of the solvent, extract the solvent inside of the panel heat exchanger and fill up 1~2% of NaOH or NaHCO₃ and then, circulate it for 15~20 minutes to neutralize the heat exchanger.
 - Once the neutralization is completed, clean the inside of the panel heat exchanger with clean water. Measure the water Ph to check if the chemical solvent is properly removed or not.
 - When using a different kind of chemical solvent in the market, be sure to check if there is any corrosive action to stainless or copper in advance or not.
 - For details on the cleaning chemical solvent, be sure to consult the specialists of the related corporation.
- After cleaning, operate the device to see if it works properly once again.

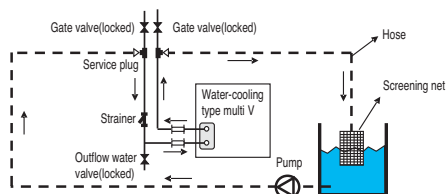

[Cleaning the panel heat exchanger]

Daily check/management

1. Water quality control

The plate type heat exchanger is not structured to be disassembled, cleaned or replaced with parts.

To prevent corrosion or scaling on the plate type heat exchanger, special care must be taken to control the water quality. Water quality must satisfy the minimum criteria of the reference water quality items.

When anti-corrosion agent or corrosion inhibitor is added, the substance must not have any corrosive effect on stainless steel and copper.

Even if the circulating water is not contaminated by the external air, it is recommended to empty the water flowing in the pipe and to resupply the water.

2. Flow rate control

If the flow rate is insufficient, it can cause freezing on the plate type heat exchanger.

Check whether the strainer is clogged or whether the pipe is filled with air and then check the temperature and pressure difference of the inlet and outlet pipe to check whether the flow rate is insufficient.

If the temperature and pressure difference is above the appropriate level, it means that the flow rate is reduced. In this case, the operation must immediately be stopped and re-operated when the root cause is resolved. (*If air is trapped in the pipe, the air must be purged. Air inside the water pipe interferes with the circulation of the heat water supply and can cause insufficient flow rate or freezing.)

3. Brine density management

When using the brine (Anti-freeze) in the heat water supply, designated type and density must be used. Calcium chloride brine can cause corrosion on the plate type heat exchanger and must not be used.

If the anti-freeze liquid is left as is, it absorbs the moisture from the air to cause a drop in the density, leading to freezing of plate type heat exchanger. Therefore minimize the contact surface with the atmosphere and periodically measure the density of the brine to supplement the brine as needed to maintain the density.

Maintenance/Repair checklist

Checkpoint \ Period (Year)	1	2	3	4	5	6	7	8	9	10	11	12	13	14	15
Product operating condition	●	●	●	●	●	●	●	●	●	●	●	●	●	●	●
Heat exchanger cleaning (Wash)					●					●					●
Strainer cleaning	●	●	●	●	●	●	●	●	●	●	●	●	●	●	●
Water quality check	●	●	●	●	●	●	●	●	●	●	●	●	●	●	●
Refrigerant leakage check	●														●
Indoor unit filter cleaning	●	●	●	●	●	●	●	●	●	●	●	●	●	●	●

(● : Check mark)

⚠ CAUTION

- The above checklist is set based on the minimum period and more frequent checking can be required depending on the operating condition/water quality condition.
- When cleaning the heat exchanger, make sure to take parts out or lock the valve so that chemical detergent does not penetrate into the pressure gauge etc.
- When cleaning the heat exchanger, check the connecting part of the water pipes prior to cleaning so that the chemical detergent does not leak.
- After sufficiently mixing the chemical detergent with water, start cleaning.
- Cleaning the heat exchanger is easier at the initial stage and becomes difficult after the scaling has accumulated.
- In areas where the water quality is poor, cleaning is required periodically.
Because chemical detergent has strong acidity, it must be washed off thoroughly with water.
- To check whether it is cleaned well inside, remove the hose and check the inside.
- Purge the air to remove any air inside the water pipe.
- After checking, always check whether the heat water supply is flowing normally flowing before operating the product.

Self-Diagnosis Function

Error Indicator

- This function indicates types of failure in self-diagnosis and occurrence of failure for air condition.
- Error mark is displayed on display window of indoor units and wired remote controller, and 7-segment LED of outside unit control board as shown in the table.
- If more than two troubles occur simultaneously, lower number of error code is first displayed.
- After error occurrence, if error is released, error LED is also released simultaneously.

Error Display

1st,2nd LED of 7-segment indicates error number, 3rd LED indicates unit number.

- Ex) 211 : No.21 error of master unit
 213 : No.21 error of slave2
 011 → 051 : No.105 error of master unit

	Display number	Error item	Root cause of error
Indoor unit	0 1 -	Air temperature sensor of indoor unit	Air temperature sensor of indoor unit is open or short
	0 2 -	Inlet pipe temperature sensor of indoor unit	Inlet pipe temperature sensor of indoor unit is open or short
	0 3 -	Transmission error : wired remote controller ↔ indoor unit	Failing to receive wired remote controller signal in indoor unit PCB
	0 4 -	Drain pump	Malfunction of drain pump
	0 5 -	Transmission error : outside unit ↔ indoor unit	Failing to receive outside unit signal in indoor unit PCB
	0 6 -	Outlet pipe temperature sensor of indoor unit	Outlet pipe temperature sensor of indoor unit is open or short
	0 7 -	Different operation mode	Operation mode between indoor unit and outside unit is different
	0 9 -	Indoor EEPROM Error	In case when the serial number marked on EEPROM of Indoor unit is 0 or FFFFFFFF
	1 0 -	Poor fan motor operation	Disconnecting the fan motor connector/Failure of indoor fan motor lock
	Outside unit	2 1 1	Master outside unit inverter compressor IPM/IGBT fault
2 1 2		Slave1 outside unit inverter compressor IPM/IGBT fault	Slave1 outside unit inverter compressor drive IPM/IGBT error
2 1 3		Slave2 outside unit inverter compressor IPM/IGBT fault	Slave2 outside unit inverter compressor drive IPM/IGBT error
2 2 1		Master outdoor unit inverter compressor over-current (RMS)	Exceeding input current(RMS) of Master outdoor unit.
2 2 2		Slave1 outdoor unit inverter compressor over-current (RMS)	Exceeding input current(RMS) of slave1 outdoor unit.
2 2 3		Slave2 outdoor unit inverter compressor over-current (RMS)	Exceeding input current(RMS) of slave2 outdoor unit.
2 3 1		Master outside unit inverter compressor DC link under-voltage	DC voltage is not charged after master outside unit operating relay is turned on
2 3 2		Slave1 outside unit inverter compressor DC link under-voltage	DC voltage is not charged after slave1 outside unit operating relay is turned on
2 3 3		Slave2 outside unit inverter compressor DC link under-voltage	DC voltage is not charged after slave2 outside unit operating relay is turned on
2 4 1		Master outside unit high pressure switch	Compressor maintenance by master outside unit high pressure switch Flow rate insufficiency or flow switch trouble of master outside unit
2 4 2		Slave1 outside unit high pressure switch	Compressor maintenance by slave1 outside unit high pressure switch Flow rate insufficiency or flow switch trouble of slave1 outside unit
2 4 3		Slave2 outside unit high pressure switch	Compressor maintenance by slave2 outside unit high pressure switch Flow rate insufficiency or flow switch trouble of slave1 outside unit
2 5 1		Master outside unit input voltage over-voltage/under-voltage	Master outside unit input voltage of 487V or above or 270V or less
2 5 2		Slave1 outside unit input voltage over-voltage/under-voltage	Slave1 outside unit input voltage of 487V or above or 270V or less
2 5 3		Slave2 outside unit input voltage over-voltage/under-voltage	Slave2 outside unit input voltage of 487V or above or 270V or less

Test Run

			Display number	Error item	Root cause of error
Outside unit	2	6	1	Master outside unit inverter compressor operation failure error	Initial operation failure due to master outside unit inverter compressor error
	2	6	2	Slave1 outside unit inverter compressor operation failure error	Initial operation failure due to slave1 outside unit inverter compressor error
	2	6	3	Slave2 outside unit inverter compressor operation failure error	Initial operation failure due to slave2 outside unit inverter compressor error
	2	7	1	Master PSC/PFC Fault error	Master PSC/PFC Communication error
	2	7	2	Slave1 PSC/PFC Fault error	Slave1 PSC/PFC Communication error
	2	7	3	Slave2 PSC/PFC Fault error	Slave2 PSC/PFC Communication error
	2	8	1	Master outside unit inverter DC link over-voltage error	Compressor turned Off due to master outside unit inverter DC voltage over-charge
	2	8	2	Slave1 outside unit inverter DC link over-voltage error	Compressor turned Off due to slave1 outside unit inverter DC voltage over-charge
	2	8	3	Slave2 outside unit inverter DC link over-voltage error	Compressor turned Off due to slave2 outside unit inverter DC voltage over-charge
	2	9	1	Master outside unit inverter compressor over-current	Master outside unit inverter compressor error or operating component (IPM/IGBT) error operation
	2	9	2	Slave1 outside unit inverter compressor over-current	Slave1 outside unit inverter compressor error or operating component (IPM/IGBT) error operation
	2	9	3	Slave2 outside unit inverter compressor over-current	Slave2 outside unit inverter compressor error or operating component (IPM/IGBT) error operation
	3	1	1	Master outside unit inverter CT under-current error	Compressor turned off due to master outside unit inverter CT under-current
	3	1	2	Slave1 outside unit inverter CT under-current error	Compressor turned off due to slave1 outside unit inverter CT under-current
	3	1	3	Slave2 outside unit inverter CT under-current error	Compressor turned off due to slave2 outside unit inverter CT under-current
	3	2	1	Master outside unit inverter compressor discharge temperature over-rise	Compressor turned off due to master outside unit inverter compressor discharge temperature over-rise Flow rate insufficiency or flow switch trouble of master outside unit
	3	2	2	Slave1 outside unit inverter compressor discharge temperature over-rise	Compressor turned off due to slave1 outside unit inverter compressor discharge temperature over-rise Flow rate insufficiency or flow switch trouble of slave1 outside unit
	3	2	3	Slave2 outside unit inverter compressor discharge temperature over-rise	Compressor turned off due to slave2 outside unit inverter compressor discharge temperature over-rise Flow rate insufficiency or flow switch trouble of slave2 outside unit
	3	3	1	Master outside unit static speed compressor discharge temperature over-rise	Compressor turned off due to master outside unit static speed compressor discharge temperature over-rise
	3	3	2	Slave1 outside unit static speed compressor discharge temperature over-rise	Compressor turned off due to slave1 outside unit static speed compressor discharge temperature over-rise
	3	3	3	Slave2 outside unit static speed compressor discharge temperature over-rise	Compressor turned off due to slave2 outside unit static speed compressor discharge temperature over-rise
	3	4	1	Master outside unit high pressure over-rise	Compressor turned off due to master outside unit high pressure over-rise Flow rate insufficiency or flow switch trouble of master outside unit
	3	4	2	Slave1 outside unit high pressure over-rise	Compressor turned off due to slave1 outside unit high pressure over-rise Flow rate insufficiency or flow switch trouble of slave1 outside unit
	3	4	3	Slave2 outside unit high pressure over-rise	Compressor turned off due to slave2 outside unit high pressure over-rise Flow rate insufficiency or flow switch trouble of slave2 outside unit
	3	5	1	Master outside unit low pressure over-drop.	Compressor turned off due to master outside unit low pressure over-drop.
	3	5	2	Slave1 outside unit low pressure over-drop.	Compressor turned off due to slave1 outside unit low pressure over-drop.
	3	5	3	Slave2 outside unit low pressure over-drop.	Compressor turned off due to slave2 outside unit low pressure over-drop.
	3	9	1	Master Communication error between Master outside unit PFC and inverter board	Master outside unit inverter compressor current detection (CT) sensor disconnection or short circuit
	3	9	2	Master Communication error between Master outside unit PFC and inverter board	Slave1 outside unit inverter compressor current detection (CT) sensor disconnection or short circuit
	3	9	3	Master Communication error between Master outside unit PFC and inverter board	Slave2 outside unit inverter compressor current detection (CT) sensor disconnection or short circuit

Display number			Error item	Root cause of error	
Outside unit	4	0	1	Master outside unit inverter compressor CT sensor error	Master outside unit inverter compressor current detection (CT) sensor disconnection or short circuit
	4	0	2	Slave1 outside unit inverter compressor CT sensor error	Slave1 outside unit inverter compressor current detection (CT) sensor disconnection or short circuit
	4	0	3	Slave2 outside unit inverter compressor CT sensor error	Slave2 outside unit inverter compressor current detection (CT) sensor disconnection or short circuit
	4	1	1	Master outside unit inverter compressor discharge temperature sensor error	Master outside unit inverter compressor discharge temperature sensor disconnection or short circuit
	4	1	2	Slave1 outside unit inverter compressor discharge temperature sensor error	Slave1 outside unit inverter compressor discharge temperature sensor disconnection or short circuit
	4	1	3	Slave2 outside unit inverter compressor discharge temperature sensor error	Slave2 outside unit inverter compressor discharge temperature sensor disconnection or short circuit
	4	2	1	Master outside unit under-voltage sensor error	Master outside unit under-voltage sensor disconnection or short circuit
	4	2	2	Slave1 outside unit under-voltage sensor error	Slave1 outside unit under-voltage sensor disconnection or short circuit
	4	2	3	Slave2 outside unit under-voltage sensor error	Slave2 outside unit under-voltage sensor disconnection or short circuit
	4	3	1	Master outside unit over-voltage sensor error	Master outside unit over-voltage sensor disconnection or short circuit
	4	3	2	Slave1 outside unit over-voltage sensor error	Slave1 outside unit over-voltage sensor disconnection or short circuit
	4	3	3	Slave2 outside unit over-voltage sensor error	Slave2 outside unit over-voltage sensor disconnection or short circuit
	4	4	1	Master outside unit air temperature sensor error	Master outside unit air temperature sensor disconnection or short circuit
	4	4	2	Slave1 outside unit air temperature sensor error	Slave1 outside unit air temperature sensor disconnection or short circuit
	4	4	3	Slave2 outside unit air temperature sensor error	Slave2 outside unit air temperature sensor disconnection or short circuit
	4	5	1	Master outside unit heat exchange temperature sensor (A) error	Master outside unit heat exchange temperature sensor (A) disconnection or short circuit
	4	5	2	Slave1 outside unit heat exchange temperature sensor (A) error	Slave1 outside unit heat exchange temperature sensor (A) disconnection or short circuit
	4	5	3	Slave2 outside unit heat exchange temperature sensor (A) error	Slave2 outside unit heat exchange temperature sensor (A) disconnection or short circuit
	4	6	1	Master outside unit suction temperature sensor error	Master outside unit suction temperature sensor disconnection or short circuit
	4	6	2	Slave1 outside unit suction temperature sensor error	Slave1 outside unit suction temperature sensor disconnection or short circuit
	4	6	3	Slave2 outside unit suction temperature sensor error	Slave2 outside unit suction temperature sensor disconnection or short circuit
	4	7	1	Master outside unit static speed compressor discharge temperature sensor error	Master outside unit static speed compressor discharge temperature sensor disconnection or short circuit
	4	7	2	Slave1 outside unit static speed compressor discharge temperature sensor error	Slave1 outside unit static speed compressor discharge temperature sensor disconnection or short circuit
	4	7	3	Slave2 outside unit static speed compressor discharge temperature sensor error	Slave2 outside unit static speed compressor discharge temperature sensor disconnection or short circuit
	4	8	1	Master outside unit Plate type heat exchanger temperature sensor error	Master outside unit Plate type heat exchanger temperature sensor disconnection or short circuit
	4	8	2	Slave1 outside unit Plate type heat exchanger temperature sensor error	Slave1 outside unit Plate type heat exchanger temperature sensor disconnection or short circuit
	4	8	3	Slave2 outside unit Plate type heat exchanger temperature sensor error	Slave2 outside unit Plate type heat exchanger temperature sensor disconnection or short circuit
	4	9	1	Master outside unit IGBT temperature sensor error	Master outside unit IGBT temperature sensor disconnection or short circuit
	4	9	2	Slave1 outside unit IGBT temperature sensor error	Slave1 outside unit IGBT temperature sensor disconnection or short circuit
	4	9	3	Slave2 outside unit IGBT temperature sensor error	Slave2 outside unit IGBT temperature sensor disconnection or short circuit
5	0	1	Master outside unit 3 phase power missing	Master outside unit power line phase missing	
5	0	2	Slave1 outside unit 3 phase power missing	Slave1 outside unit power line phase missing	

Test Run

	Display number	Error item	Root cause of error
0 Outside unit	5 0 3	Slave2 outside unit 3 phase power missing	Slave2 outside unit power line phase missing
	5 1 -	Over-capacity (Indoor unit capacity sum is excessive) connection	Excessive connection of indoor unit connection display value (Different from outside unit)
	5 2 1	Communication error with master outside unit inverter controller	When the inverter controller signal is not received from the master outside unit inverter controller
	5 2 2	Communication error with slave1 outside unit inverter controller	When the inverter controller signal is not received from the slave1 outside unit inverter controller
	5 2 3	Communication error with slave2 outside unit inverter controller	When the inverter controller signal is not received from the slave2 outside unit inverter controller
	5 3 -	Communication error with master outside unit controller and indoor unit	When the indoor unit control signal is not received from the master outside unit controller
	5 4 1	Master outside unit 3 phase power reverse phase	Master outside unit 3 phase power reverse phase connection
	5 4 2	Slave1 outside unit 3 phase power reverse phase	Slave1 outside unit 3 phase power reverse phase connection
	5 4 3	Slave2 outside unit 3 phase power reverse phase	Slave2 outside unit 3 phase power reverse phase connection
	5 7 1	Master Outdoor Unit Communication Error with Inverter Controller	Master Outdoor Unit Controller part cannot receive inverter control signals (usually happens after onboarding)
	5 7 2	Slave1 Outdoor Unit Communication Error with Inverter Controller	Slave1 Outdoor Unit Controller part cannot receive inverter control signals (usually happens after onboarding)
	5 7 3	Slave2 Outdoor Unit Communication Error with Inverter Controller	Slave2 Outdoor Unit Controller part cannot receive inverter control signals (usually happens after onboarding)
	5 9 -	Wrong setting between master and slave outside unit	When the dip switch(No.8) setting is different between master and slave outside unit
	6 0 1	Master outside unit inverter PCB EEPROM error	Master outside unit inverter PCB EEPROM ACCESS error
	6 0 2	Slave1 outside unit inverter PCB EEPROM error	Slave1 outside unit inverter PCB EEPROM ACCESS error
	6 0 3	Slave2 outside unit inverter PCB EEPROM error	Slave2 outside unit inverter PCB EEPROM ACCESS error
	6 2 1	Master Outdoor Unit Inverter Heatsink High Temperature	System is turned off by Master Outdoor Unit Inverter Heatsink High Temperature
	6 2 2	Slave1 Outdoor Unit Inverter Heatsink High Temperature	System is turned off by Slave1 Outdoor Unit Inverter Heatsink High Temperature
	6 2 3	Slave2 Outdoor Unit Inverter Heatsink High Temperature	System is turned off by Slave2 Outdoor Unit Inverter Heatsink High Temperature
	6 5 1	Master Outdoor Unit Inverter Heatsink Temperature Sensor Fault	Master Outdoor Unit Inverter Heatsink Temperature Sensor open or short
	6 5 2	Slave1 Outdoor Unit Inverter Heatsink Temperature Sensor Fault	Slave1 Outdoor Unit Inverter Heatsink Temperature Sensor open or short
	6 5 3	Slave2 Outdoor Unit Inverter Heatsink Temperature Sensor Fault	Slave2 Outdoor Unit Inverter Heatsink Temperature Sensor open or short
	7 0 1	Master outside unit static speed CT sensor error	Master outside unit static speed CT sensor disconnection or short circuit
	7 0 2	Slave1 outside unit static speed CT sensor error	Slave1 outside unit static speed CT sensor disconnection or short circuit
	7 0 3	Slave2 outside unit static speed CT sensor error	Slave2 outside unit static speed CT sensor disconnection or short circuit
	7 1 1	Variable Water Flow Control KIT(Accessory)	Master Outdoor Unit PFC CT Sensor open or short
	7 1 2	Variable Water Flow Control KIT(Accessory)	Slave1 Outdoor Unit PFC CT Sensor open or short
	7 1 3	Variable Water Flow Control KIT(Accessory)	Slave2 Outdoor Unit PFC CT Sensor open or short
	7 3 1	Master outside unit inverter PCB input instant over-current (Peak)	Master outside unit inverter PCB input instant over-current (Peak) exceeded
	7 3 2	Slave1 outside unit inverter PCB input instant over-current (Peak)	Slave1 outside unit inverter PCB input instant over-current (Peak) exceeded
7 3 3	Slave2 outside unit inverter PCB input instant over-current (Peak)	Slave2 outside unit inverter PCB input instant over-current (Peak) exceeded	

			Display number	Error item	Root cause of error	
Outside unit	7	4	1	Master outside unit inverter PCB phase imbalance	When the master outside unit inverter PCB input current is different	
	7	4	2	Slave1 outside unit inverter PCB phase imbalance	When the slave1 outside unit inverter PCB input current is different	
	7	4	3	Slave2 outside unit inverter PCB phase imbalance	When the slave2 outside unit inverter PCB input current is different	
	8	6	1	Master outside unit master PCB EEPROM error	Communication error between master outside unit master MICOM and EEPROM or EEPROM missing	
	8	6	2	Slave1 outside unit master PCB EEPROM error	Communication error between slave1 outside unit master MICOM and EEPROM or EEPROM missing	
	8	6	3	Slave2 outside unit master PCB EEPROM error	Communication error between slave2 outside unit master MICOM and EEPROM or EEPROM missing	
	8	8	1	Master PFC PCB EEPROM error	Master Communication error between master outside unit master PFC and EEPROM or EEPROM missing	
	8	8	2	Slave1 PFC PCB EEPROM error	Slave1 Communication error between master outside unit master PFC and EEPROM or EEPROM missing	
	8	8	3	Slave2 PFC PCB EEPROM error	Slave2 Communication error between master outside unit master PFC and EEPROM or EEPROM missing	
	1	0	4	1	Master Communication Error Between Master Outdoor Unit and Other Outdoor Unit	Master Failing to receive Slave Unit signal at main PCB of Master Outdoor Unit
	1	0	4	2	Slave1 Communication Error Between Master Outdoor Unit and Other Outdoor Unit	Slave1 Failing to receive Slave Unit signal at main PCB of Master Outdoor Unit
	1	0	4	3	Slave2 Communication Error Between Master Outdoor Unit and Other Outdoor Unit	Slave2 Failing to receive Slave Unit signal at main PCB of Master Outdoor Unit
	1	1	3	1	Master Outdoor Unit Liquid pipe Temperature Sensor Error	Master Liquid pipe temperature sensor of Master Outdoor Unit is open or short
	1	1	3	2	Slave1 Outdoor Unit Liquid pipe Temperature Sensor Error	Slave1 Liquid pipe temperature sensor of Master Outdoor Unit is open or short
	1	1	3	3	Slave2 Outdoor Unit Liquid pipe Temperature Sensor Error	Slave2 Liquid pipe temperature sensor of Master Outdoor Unit is open or short
	1	1	4	1	Master Outdoor Unit Subcooling Inlet Temperature Sensor Error	Master Outdoor Unit Subcooling Inlet Temperature Sensor open or short
	1	1	4	2	Slave1 Outdoor Unit Subcooling Inlet Temperature Sensor Error	Slave1 Outdoor Unit Subcooling Inlet Temperature Sensor open or short
	1	1	4	3	Slave2 Outdoor Unit Subcooling Inlet Temperature Sensor Error	Slave2 Outdoor Unit Subcooling Inlet Temperature Sensor open or short
	1	1	5	1	Master outside unit over-cooling outlet temperature sensor error	Master outside unit over-cooling outlet temperature sensor disconnection or short circuit
	1	1	5	2	Slave1 outside unit over-cooling outlet temperature sensor error	Slave1 outside unit over-cooling outlet temperature sensor disconnection or short circuit
	1	1	5	3	Slave2 outside unit over-cooling outlet temperature sensor error	Slave2 outside unit over-cooling outlet temperature sensor disconnection or short circuit
	1	5	-	-	Outside unit 4 way valve switch failure	Outside unit 4 way valve switch error
	1	7	3	1	Master outside unit static speed compressor error	Master outside unit static speed compressor burn, locking and over-current
	1	7	3	2	Slave1 outside unit static speed compressor error	Slave1 outside unit static speed compressor burn, locking and over-current
	1	7	3	3	Slave2 outside unit static speed compressor error	Slave2 outside unit static speed compressor burn, locking and over-current
	1	8	0	-	Plate type heat exchanger freeze prevention	Plate type heat exchanger freeze prevention error
1	8	1	-	Water temperature sensor error	Water temperature sensor open/short	
1	8	2	-	Communication error between MICOMs	Communication error between main MICOM and sub MICOM	

■ Refer to the troubleshooting guide of service technical manual for each error.

Cooling tower applied method

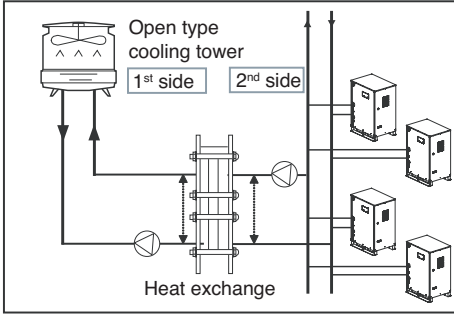

[Open type cooling tower + Second heat exchanger]

Heat exchanger is installed between the cooling tower and outside unit system piping, and the temperature difference between 1st side and 2nd side is maintained constantly

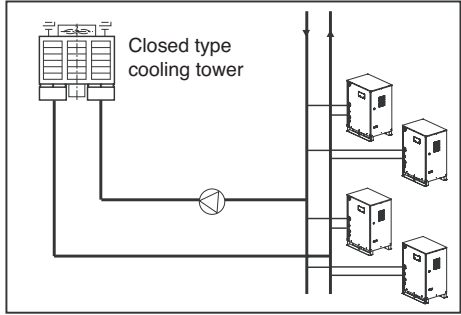

[Closed type cooling tower]

Heat source water of the cooling tower is supplied directly to the outside unit system.

⚠ CAUTION

When the open type cooling tower is used and the water supply is directly connected to the 2nd heat exchanger, product damage by alien particle cannot be repaired for free.

- Always use the 2nd heat exchanger.

Caution For Refrigerant Leak

The installer and system specialist shall secure safety against leakage according to local regulations or standards. The following standards may be applicable if local regulations are not available.

Introduction

Though the R410A refrigerant is harmless and incombustible itself, the room to equip the air conditioner should be large to such an extent that the refrigerant gas will not exceed the limiting concentration even if the refrigerant gas leaks in the room.

Limiting concentration

Limiting concentration is the limit of Freon gas concentration where immediate measures can be taken without hurting human body when refrigerant leaks in the air. The limiting concentration shall be described in the unit of kg/m^3 (Freon gas weight per unit air volume) for facilitating calculation.

Limiting concentration: $0.44\text{kg}/\text{m}^3$ (R410A)

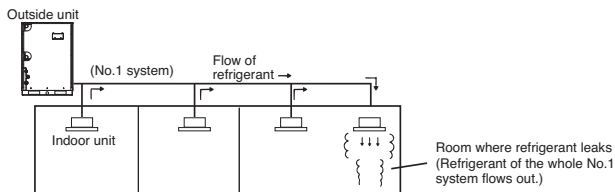

Checking procedure of limiting concentration

Check limiting concentration along following steps and take appropriate measure depending on the situation.

Calculate amount of all the replenished refrigerant (kg) per each refrigerant system.

$$\begin{array}{r}
 \text{Amount of replenished} \\
 \text{refrigerant per one outside} \\
 \text{unit system} \\
 \downarrow \\
 \text{Amount of replenished} \\
 \text{refrigerant at factory shipment}
 \end{array}
 +
 \begin{array}{r}
 \text{Amount of additional} \\
 \text{replenished refrigerant} \\
 \downarrow \\
 \text{Amount of additionally} \\
 \text{replenished refrigerant} \\
 \text{depending on piping} \\
 \text{length or piping} \\
 \text{diameter at customer}
 \end{array}
 =
 \begin{array}{r}
 \text{Total amount of replenished} \\
 \text{refrigerant in refrigerant} \\
 \text{facility (kg)}
 \end{array}$$

Note : In case one refrigerant facility is divided into 2 or more refrigerant systems and each system is independent, amount of replenished refrigerant of each system shall be adopted.

Calculate minimum room capacity

Calculate room capacity by regarding a portion as one room or the smaller room.

(1) Without partition

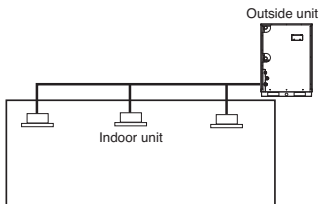

(2) With partition and with opening which serve as passage of air to adjoining room

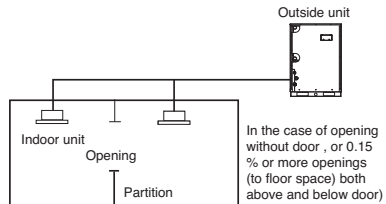

(3) With partition and without opening which serve as passage of air to adjoining room

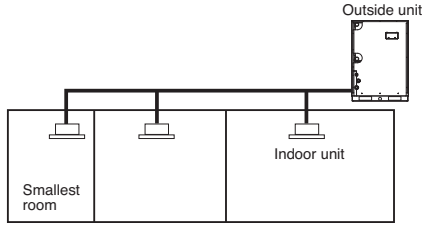

■ Calculate refrigerant concentration

$$\frac{\text{Total amount of replenished refrigerant in refrigerant facility (kg)}}{\text{Capacity of smallest room where indoor unit is installed (m}^3\text{)}} = \text{Refrigerant concentration (kg/m}^3\text{)} \quad \text{(R410A)}$$

In case the result of calculation exceeds the limiting concentration, perform the same calculations by shifting to the second smallest, and the third smallest rooms until at last the result is below the limiting concentration.

■ In case the concentration exceeds the limit

When the concentration exceeds the limit, change original plan or take one of the countermeasures shown below:

• **Countermeasure 1**

Provide opening for ventilation.

Provide 0.15% or more opening to floor space both above and below door, or provide opening without door.

• **Countermeasure 2**

Provide gas leak alarm linked with mechanical ventilator.

Reducing the outside refrigerant qty.

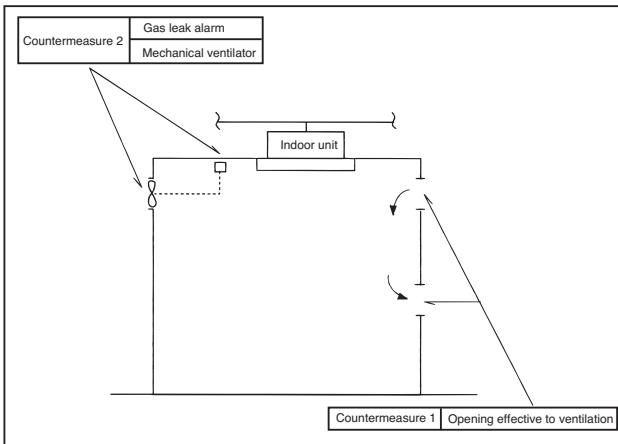

Pay a special attention to the place, such as a basement, etc. where refrigerant can stay, since refrigerant is heavier than air.

Water Solenoid Valve Control

Central Control (Use DDC Port)

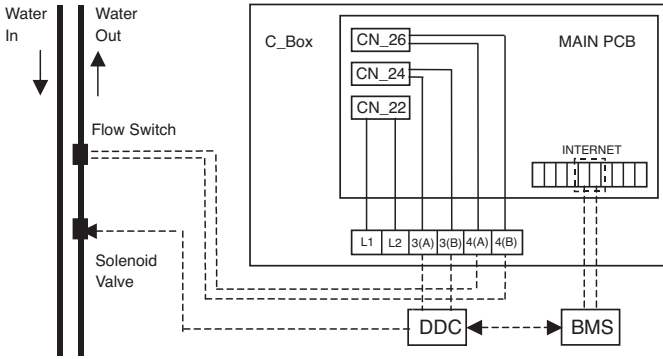

Individual Control (Use 220V Out Port)

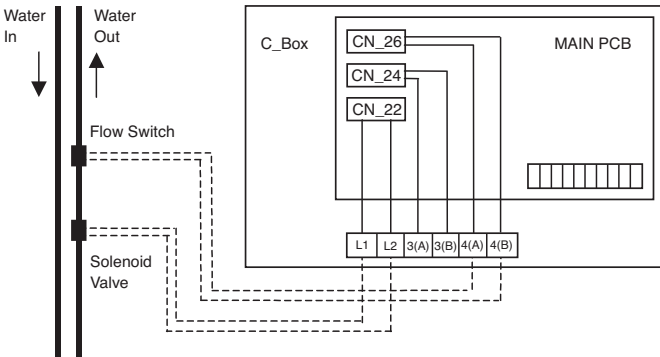

Set the dip switch refer to Fig.1 and turn on the power when you individual control for water solenoid valve control.

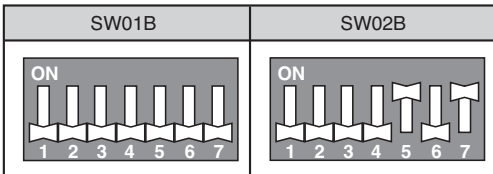
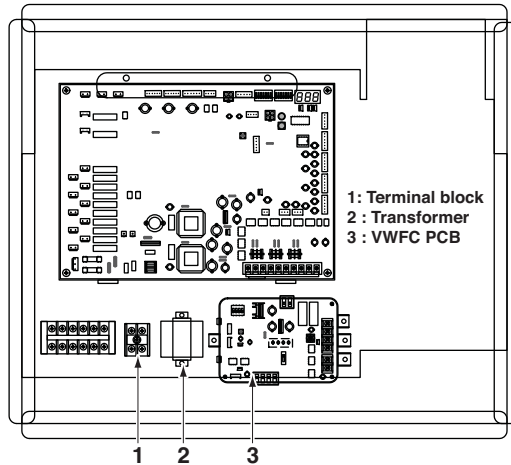

Fig.1

Variable Water Flow Control KIT(Accessory)

1. Shut off the main power line of outdoor unit.
2. Install the VWFC(Variable Water Flow Control) PCB in the C/BOX by using screws.
3. Install the transformer in the C/BOX by using screws.
4. Install the terminal block in the C/BOX by using screws.
5. Connect the Main PCB(CN41) to VWFC(CN_OUT) by using the cable assy.
6. Connect the blue wire of transformer to the Main PCB (JIG1(L), JIG2(N)).
7. Connect the red wire of transformer to the terminal block (2Pin Yellow terminal block).
8. Connect a power cable (DC 12V) to CN_PWR(12V, GND) of VWFC.
9. Connect a signal cable (DC 0~10V) of water flow control valve to CN_AO(AO_01(A+), GND(A-)) of VWFC.
10. Case of two water flow control valve, Connect a signal cable (DC 0~10V) of water flow control valve to CN_AO(AO_02(B+), GND(B-)) of VWFC.
11. Connect a power cable (AC 24V) of water flow control valve to the terminal block (2Pin Yellow terminal block, Max current 0.42A).
12. Connect the RS-485 communication cable to CN_COMM(BUS_A, BUS_B) of VWFC
13. Set up the main function Dip S/W of VWFC PCB.
14. Set up the Dip SW of outdoor main PCB.
15. Turn on the main power line of outdoor unit.
16. Check the signal of water flow control valve to CN_AO(AO_01, GND) of VWFC and the water flow rate.



CAUTION

1. Install the product on flat surface and screw at least 2 places. Otherwise the VWFC PCB may not be anchored properly.
2. Do not deform the case at random. It may cause malfunction of the Variable Water Flow Control PCB
3. This is a class A product. In a non-industrial environment, this product may cause radio interference, in which case the user may be required to take adequate measures.

