



User's Guide

V-NET™ ACS

After reading, store this User's Guide in an easily accessible place for all users.

Model Name: AC Smart Premium

Model No.: PQCSW421E0A

Explanatory Notes

Copyrights

The contents of this AC Smart Premium User Guide are protected by international copyright laws, and the Computer Program Protection Act. The contents of the User Guide and the programs mentioned herein may only be used under license from LG Electronics in strict adherence to the user agreement.

You may not reproduce or distribute, by any means, copies of this User Guide, or any part of it, without prior approval from LG Electronics.

Copyright © 2013 LG Electronics. All rights reserved. Twin Towers 20, Yeouido, Yeongdeungpo-gu, Seoul

Registered Trademarks

AC Smart Premium is a registered trademark of LG Electronics. All other products and company names are trademarks of their respective owners and are used for illustrative purposes only.

Product Features

Convenience

- **Auto-changeover**
Automatically switches the indoor unit into the correct mode to optimize space comfort.
- **Web access**
Allows distributed control from a remote location.
- **Visual and e-mail alarm notification**
Immediately indicates when a system is not operating at optimal conditions.
- **Visual Navigation**
Allows for accessing unit data by navigating uploaded floorplans.

Energy Savings

- **Scheduling**
Conditions the space only when necessary.
- **Setpoint Range Limit**
Prevents the setpoint from being set to extremes that can result in overcooling or overheating of the space.
- **Remote Controller Lock**
Prevents users from changing indoor unit operation.
- **Setback**
Allows indoor units to be shut off during unoccupied periods with an override feature to keep interior temperatures from reaching extremes.
- **Time Limit**
Allows a unit to be turned on during unoccupied times and automatically shut down after a specified amount of run time.
- **Peak/Demand Control**
Allows for electronically limiting power usage.

Integration

- **Interlocking**
Allows interlocked operation between devices or between digital inputs and outputs on the AC Smart and devices.

AC Manager Plus Interface

You can connect AC Smart Premium with a PC based AC Manager Plus to use the various AC Manager Plus functions. You can also use the scheduling function, even if the PC with AC Manager Plus is turned off.

How to Use This Guide

Please read from beginning to end this User Guide before using AC Smart Premium. Store this guide so that is also easily accessible.

Notations Used In This Guide

- Control buttons displayed within the system are marked by boldface text in square brackets (**[]**).

Example: **[OK]**, **[Save]**

- Option titles displayed in the program are marked by boldface text.

Example: **Start**, **Programs**

- Keyboard strokes used by the system are marked by boldface text in angle brackets (**< >**).

Example: **<Esc>**

 MEMO

Table of Contents

1 Safety Precautions

- 1 Warning
- 5 Caution

9 Preparation

- 9 AC Smart Premium Overview
- 9 Components
- 10 Product Specifications
- 11 Features and Functions
- 12 Installation and Configuration
 - 12 – Installation
 - 21 – Configure an emergency stop
- 22 Information Input Method

23 Starting

- 23 Turning on/off the screen
 - 23 – Turning on the screen
 - 23 – Turning off the screen
- 24 Rebooting
- 24 Login and logout
 - 25 – Login
 - 25 – Logout
- 26 Home screen composition and features

27 Using the Program

- 27 Control/Monitor
 - 27 – Control/Monitoring screen composition and features
 - 32 – Device Control
 - 52 – Monitoring a Device
- 53 Schedule
 - 53 – Schedule Screen composition and features
 - 54 – Creating Schedules

- 57 – Checking Schedules
- 58 – Editing Schedules
- 59 – Deleting Schedules
- 60 Auto Logic
 - 60 – Peak Control
 - 69 – Demand Control
 - 72 – Time-limit Operation
 - 78 – InterLocking
- 82 Statistics
 - 82 – Statistics Screen Composition and Features
 - 83 – Querying Statistics
- 85 Report
 - 85 – Report screen composition and features
 - 86 – Querying Report
- 87 Installing
 - 87 – Registering Device
 - 92 – Managing Device
- 96 Environment
 - 96 – General Setting
 - 102 – Screen Setting
 - 108 – Advance Setting
 - 113 – Customer Setting
 - 119 – Network Setting
 - 123 – E-Mail Setting
 - 128 – TMS Setting

135 Hint

- 135 Control Codes
- 135 Error Codes
 - 135 – Indoor Device, ERV or ERV DX, AWHP(Hydro kit), AHU error
 - 137 – Outdoor Unit Errors
 - 139 – MultiV 20Hp, 30Hp, 40Hp, error
 - 141 – Super Errors
 - 142 – Central Controller Errors
- 143 Pre-Tech Support Checklist
- 143 Guide to Open Source Software

 MEMO

Safety Precautions

- This product must be installed by an installation professional from an LG authorized service center.
- Any issues stemming from an installation by an unauthorized person is the responsibility of the user and will not be covered by warranty.
- The following safety precautions are to prevent any unforeseen dangers or damage.
- This product has been designed for business use, or for areas outside the home, and has passed the Electromagnetic Interference Test.



Warning

If the instructions are not followed, injury or death is possible.

Installation

- **To reinstall the product, please contact the dealer from where you purchased the product, or a service center for reinstallation service.**

Installation of the product by an unauthorized person may result in fire, electric shock, explosion, injury, or a malfunctioning of the product.

- **Do not twist or damage the power cord.**

It may cause fire or electric shock.

- **For electrical work, please contact the dealer from where you purchased the product, or a service center.**

Disassembly or repair by an unauthorized person may result in fire or electric shock.

- **Install the product in an area shielded from rain.**

If water gets into the product, it may malfunction.

- **Do not install the product in a humid area.**

If the product is damp, it may malfunction.

- **For installation of the product, please contact the dealer from where you purchased the product, or a service center.**

Installation of the product by an unauthorized person may result in fire, electric shock, explosion, injury, or a malfunctioning of the product.

- **For electrical work, please have an electrician do the work based on the installation manual and specified circuit diagram.**
Using an unsuitable cord, or having a non-professional work on the electricals may result in fire or electrical shock.
- **Do not place the product near a fire source.**
It may result in the product catching fire.
- **If the product is installed in a hospital or a communication base station, provide sufficient protective equipment against electrical noise.**
The product may malfunction or other products may work abnormally.
- **Securely install the product.**
If the product is not secured during installation, it may fall or malfunction.
- **Read the manual thoroughly to correctly install the product.**
If not, an incorrect installation may cause fire or electric shock.
- **When wiring the product, do not use a non-standard cable, nor extend the cable excessively.**
It may cause a fire or electric shock.
- **Securely install the power cord and communication cable.**
An unsecure installation may result in a fire or electric shock.
- **Do not connect the power cord to the communication terminal.**
It may cause a fire, electric shock, or a product malfunction.
- **Do not install the product in an area near combustible gas.**
It may result in fire, electric shock, explosion, injury, or a malfunctioning of the product.

Use

- **Do not place a heavy object on the power cord.**
It may cause a fire or electric shock.
- **Do not change or extend the power cord arbitrarily.**
It may cause a fire or electric shock.
- **Use the cord specific to the product.**
Using an unauthorized non-standard cord may result in a fire or electric shock.
- **Do not use a heat device near the power cord.**
It may cause a fire or electric shock.
- **Ensure that water never gets into the product.**
It can result in an electric shock, or the product may malfunction.
- **Do not place any container with liquid on the product.**
The product may malfunction.
- **Do not touch the product with wet hands.**
It may cause a fire or electric shock.
- **Use standard components.**
Use of an unauthorized product may result in fire, electric shock, explosion, injury, or a malfunctioning of the product.
- **If the product has been submerged in water, you should contact a service center.**
It may cause a fire or electric shock.
- **Do not shock the product.**
The product may malfunction.
- **Do not store or use any combustible gas or flammable substances near the product.**
It may cause a fire, or a product malfunction.
- **Do not disassemble, repair, or revamp the product arbitrarily.**
It may cause a fire or electric shock.
- **Children and the elderly should use the product under the supervision of a guardian.**
Carelessness may cause an accident, or the product to malfunction.
- **The guardian should prevent children from accessing the product.**
The product may be damaged or it may fall, causing injury to children.

- **Keep in mind the operating temperature range specified in the manual. if there is no operating temperature range in the manual, use the product between 0 and 40°C (32 and 104°F).**
If the product is used outside this range, the product may be severely damaged.
- **Do not press the switch or button with a sharp object.**
It can result in an electric shock, or the product may malfunction.
- **Do not wire the product while it is turned on.**
It may cause a fire or electric shock.
- **If the product sounds or smells different, stop using the product.**
It may cause a fire or electric shock.
- **Do not place a heavy object on the product.**
The product may malfunction.
- **Do not spray water on the product, or clean it with a water-soaked cloth.**
It may cause a fire or electric shock.
- **Do not use the product for the preservation of animals and plants, precision instruments, art pieces, or for other special purposes.**
It may cause property damage.
- **Dispose the packing material safely.**
The packing material may result in personal injuries.



Caution

Not following the instructions may result in injury or property loss.

Installation

- **Securely install the product in an area where the weight of the product can be supported.**
The product may fall and be destroyed.
- **Do not use the product where there is oil, steam, or sulfuric gas.**
It may effect the product's performance, or damage it.
- **Check the rated power capacity.**
It may cause a fire, or a product malfunction.
- **Use the adapter provided with the product or power from a class 2 24 VAC transformer, depending on model.**
If a non-standard adapter is used, the product may malfunction. The adaptor is not provided with the AC Smart package sold in the U.S.
- **Be careful not to drop or damage the product when moving it.**
The product may malfunction or the person may sustain an injury.
- **Ensure that the cord is connected securely to prevent dew, water, or insects from getting into the product.**
If a foreign substance gets inside, it may cause an electric shock or the product may malfunction.

Use

- **Clean the product with a soft cloth, but not with a solvent-based detergent.**
The use of a solvent-based detergent may cause a fire or deform the product.
- **Do not touch the panel using a pointy or sharp object.**
It can result in an electric shock, or the product may malfunction.
- **Do not let the product come into contact with a metal substance.**
The product may malfunction.
- **When sterilizing or disinfecting, stop using the product.**
The product may work abnormally.
- **Do not touch inside the product.**
The product may malfunction.
- **Check the condition of the product after using the product for an extended period of time.**
If the product is used for an extended period of time, the product's condition may be worsen, causing injury to the user.
- **Do not leave the product near a flower base, water bottle, or any other liquids.**
It may cause a fire or electric shock.

Transformer selection:

- Select an insulating product that complies with IEC61558-2-6 and NEC Class 2.
- In addition, consider the combined power consumption of the modules, accessories, and field devices installed for the selection of an appropriate transformer.
Main module current: AC24V 850mA
- Use the provided adaptor when using DC12V. The adaptor is not provided with the AC Smart package sold in the U.S.

Class A device**Notes**

This equipment has been tested and found to comply with the limits for a Class A digital device, pursuant to part 15 of the FCC Rules.

These limits are designed to provide reasonable protection against harmful interference when the equipment is operated in a commercial environment.

This equipment generates, uses, and can radiate radio frequency energy and, if not installed and used in accordance with the instruction manual, may cause harmful interference to radio communications. Operation of this equipment in a residential area is likely to cause harmful interference in which case the user will be required to correct the interference at his own expense.

**Caution**

Changes or modifications not expressly approved by the manufacturer responsible for compliance could void the user's authority to operate the equipment.

**Disposal of your old appliance**

1. When this crossed-out wheeled bin symbol is attached to a product it means the product is covered by the European Directive 2002/96/EC.
2. All electrical and electronic products should be disposed of separately from the municipal waste stream via designated collection facilities appointed by the government or the local authorities.
3. The correct disposal of your old appliance will help prevent potential negative consequences for the environment and human health.
4. For more detailed information about disposal of your old appliance, please contact your city office, waste disposal service or the shop where you purchased the product.

 MEMO

Preparation

The following provides information on the AC Smart Premium components, how to install and configure, and other required information necessary to use the product.

AC Smart Premium Overview

AC Smart Premium is a central controller installed in the management office of a building, or in the administration office of a school, to monitor or operate, via touch screen, the indoor units, ERV (ERV: Energy Recovery Ventilator, ERV DX: Direct Expansion Energy Recovery Ventilator), DI/DOs, DOKITs, AWHPs and AHUs installed inside the building. AC Smart Premium can manage, collectively or individually, the indoor units, ERV, DI/DOs, DOKITs, AWHPs and AHUs for up to 128 devices.

Components

The following components are included in the package box. Open the box and verify that all components are included.

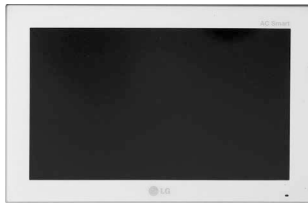

AC Smart Premium



AC Smart Premium
User's Guide

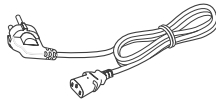

Power Cord

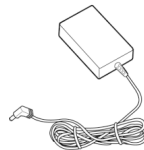

Power Adapter



Quick Guide

Power Cord, Power Adaptor and Quick Guide are not provided with the AC Smart package sold in the U.S.

**Notes**

The figures of the components and optionally purchased products shown may differ from the actual components and products.

Product Specifications

The product specifications for AC Smart Premium are as follows.

Item	Specifications
CPU	PCIMX5150D <ul style="list-style-type: none"> • ARM Cortex A8™ core • 800MHz
MEMORY	128 x 4 MB (DDR2 SDRAM)
Storage	4GB (INAND FLASH)
LCD	10.2 inch WSVGA (1024 x 600) TFT LCD
Speaker	MONO 300mW
RS485	2 Ports
USB/SD	<ul style="list-style-type: none"> • MICRO USB 1EA (for external USB memory) • MINI USB 1EA (for service) • SD Card 1EA
DI	2 Ports
DO	2 Ports
Touch Screen	R-Type 4Wire Touch Panel
Button Key	Less than 9 seconds (LCD POWER ON/OFF), 10 seconds (SYSTEM RESET)
POWER	12V DC (3.33A), 24V AC
OS	Linux

Features and Functions

The features and functions of AC Smart Premium are as follows.

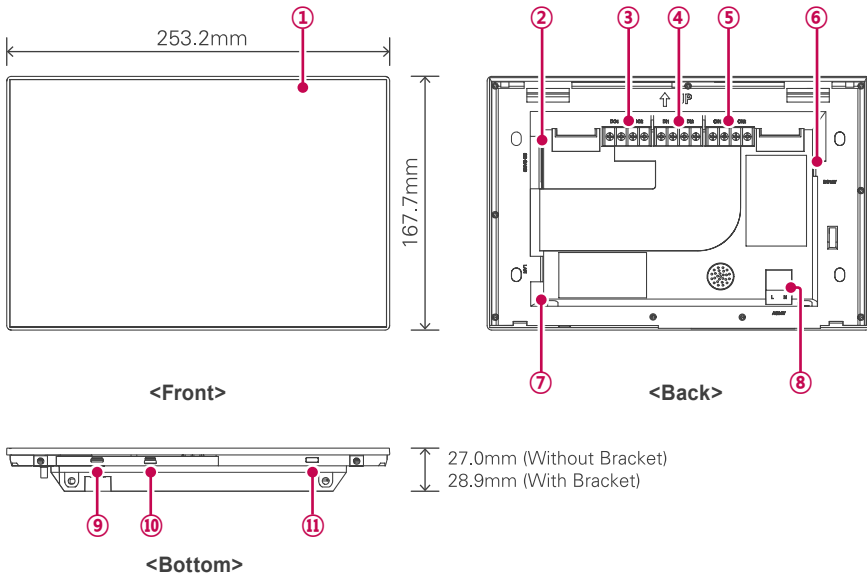

Number	Item	Description
①	Touch Screen	<ul style="list-style-type: none"> 10.2 inch LCD control panel AC Smart Premium control and information display
②	SD Memory Slot (for service)	SD card memory slot for software upgrade
③	DO Port	2CH DO port
④	DI Port	2CH DI port
⑤	485 Port	2CH 485 port (CH1: AHU, CH2: devices other than AHU)
⑥	DC 12V Input Port	DC 12V power input port
⑦	LAN Port	LAN cable port for Ethernet connection (100Mbps/10Mbps)
⑧	AC 24V Input Port	AC 24V power input port
⑨	Micro USB Port	USB 2.0 to connect USB memory sticks storing floor plans, reports, statistics, etc.
⑩	Mini USB Port (for service)	PC port for software upgrade
⑪	Power ON/OFF	<ul style="list-style-type: none"> Push less than 10 seconds to control AC Smart Premium LCD backlight. Push 10 seconds or more to reset AC Smart Premium. If you are not going to use AC Smart Premium for a long time, it is recommended that the product be turned off to prolong the LCD backlight's life.

Installation and Configuration

This chapter explains how to install and configure AC Smart Premium.

Installation

To use AC Smart Premium, build an environment for which AC Smart Premium can communicate with devices like the indoor unit, ERV, DI/DO, DOKIT, AWHP, and AHU. Use AC Smart Premium to register those devices.

AC Smart Premium should be installed in the following order:

STEP 1. Check the installation environment and configure the device address.

Check the network configuration against the interfaced devices before installing AC Smart Premium and allocate a unique central control address for each connected device.

STEP 2. Connect V-Net devices with AC Smart Premium.

Use an RS485 cable to connect V-Net devices with AC Smart Premium.

STEP 3. Login and register the devices.

Login to AC Smart Premium and register those devices that have their address set.



Caution

The installation of AC Smart Premium must be done by a professional. Be sure to contact a qualified engineer for the installation. If you have a question or request regarding the installation, contact an installation professional at an authorized LG service center or LG Electronics.

Check the installation environment and configure the device address

AC Smart Premium can connect up to 128 devices (including indoor units, ERV, DI/DOs, DOKITs, AWHPs, AHUs).

The following shows an example of connecting AC Smart Premium with such devices.

AC Smart Premium connects with PI485 and uses RS485 to communicate and exchange information. Allocate unique addresses to those devices (indoor units, ERV, DI/DOs, DOKITs, AWHPs, AHUs) that will connect with AC Smart Premium. The addresses are hexadecimal numbers that can be chosen from 00 to FF.

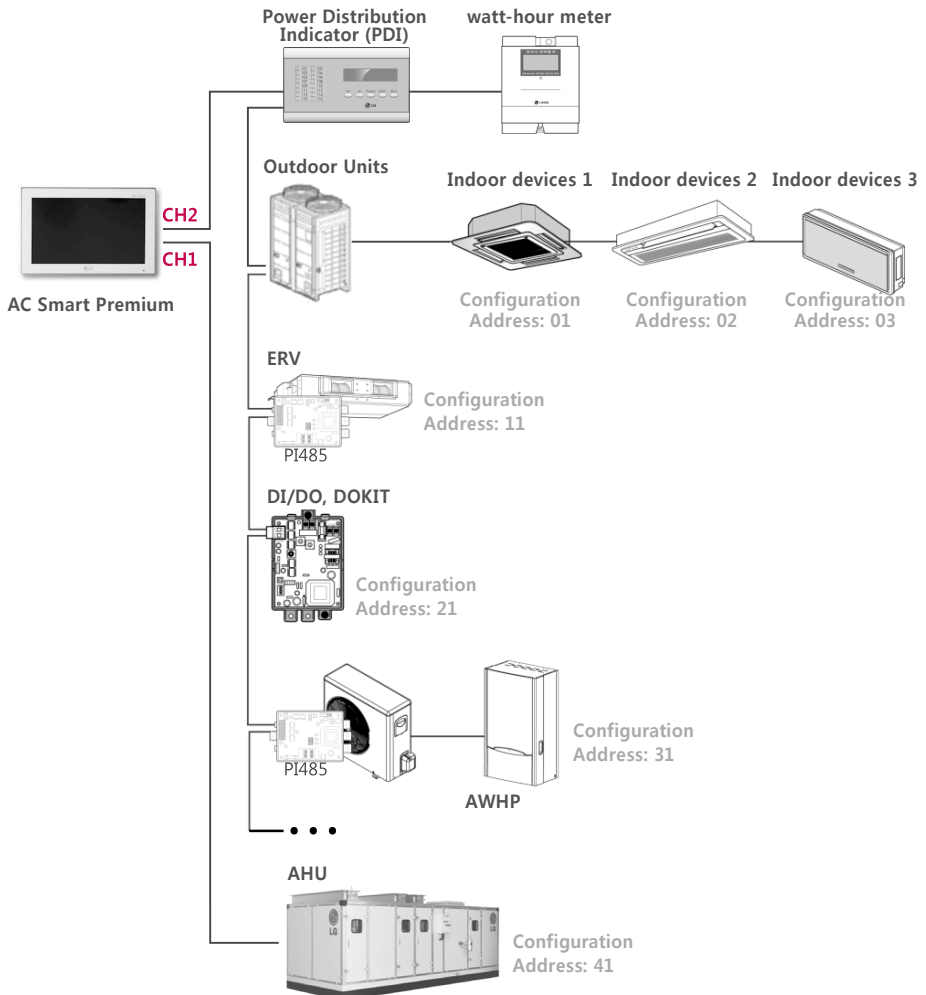

**Notes**

- The maximum allowed communication distance guaranteed by LG Electronics is 1,000m. It means that the distance between AC Smart Premium and the farthest device should not exceed 1,000m. It is recommended that the communication cable use 0.75mm square or more.
- For indoor units, ERV, DI/DOs, DOKITs, AWHPs, and AHUs, you cannot allocate identical addresses among devices of the same type. Allocate different addresses for devices of the same type. (the indoor unit and DOKIT cannot use the same address.)
- Each device which can be used with PDI must be set to a unique address when connected with PDI. For further information about the devices can be used with PDI, please refer to the PDI manual.

AC Smart Premium's RS485 connection

An AC Smart Premium can have up to 128 indoor units. If there are many outdoor units to be connected, connect them to a bus. If not, AC Smart Premium may malfunction.

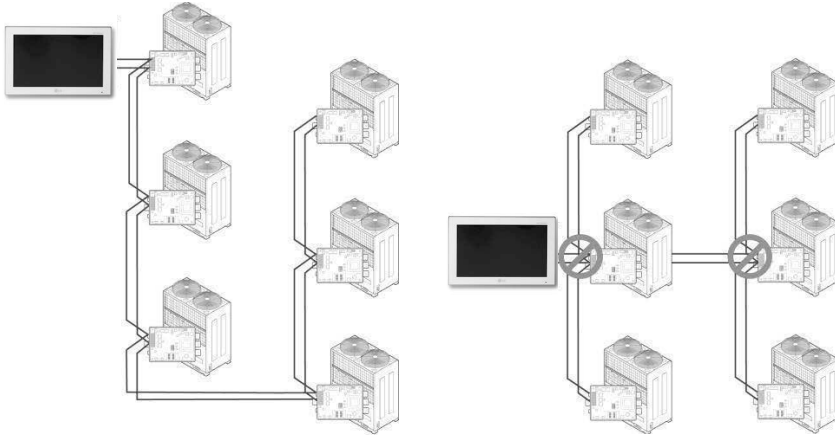

<Good example: RS485 BUS form connection>

<Bad example: RS485 STAR form connection>

! Notes

Maximum node numbers which can be connected to RS485 communication line.

- **Multi V**
Maximum of 16 nodes can be connected to 1 RS485 line.
- **Multi/Single**
Maximum of 32 nodes can be connected to 1 RS485 line.
- **ERV**
Maximum of 32 nodes can be connected to 1 RS485 line.

Connect AC Smart Premium

You can install AC Smart Premium and its cables as follows.

1. Choose a space for AC Smart Premium.
 - Prior to securing AC Smart Premium, check if the space is suitable for installing AC Smart Premium, an RS485 cable, power cord, and an Ethernet cable.
2. Secure the back panel of AC Smart Premium to the wall under which the RS485 cable is located.

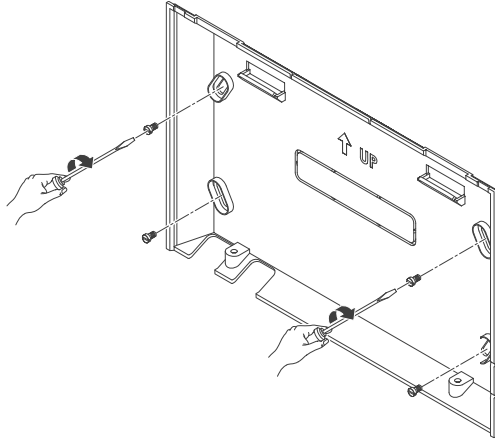

3. Extend the RS485 cable through the top opening of the back panel.

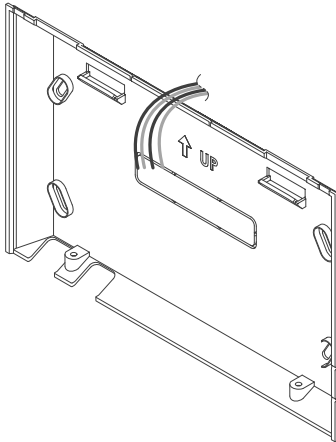

4. Connect the RS485 cable, which is located behind the AC Smart Premium, to the RS485 terminal.

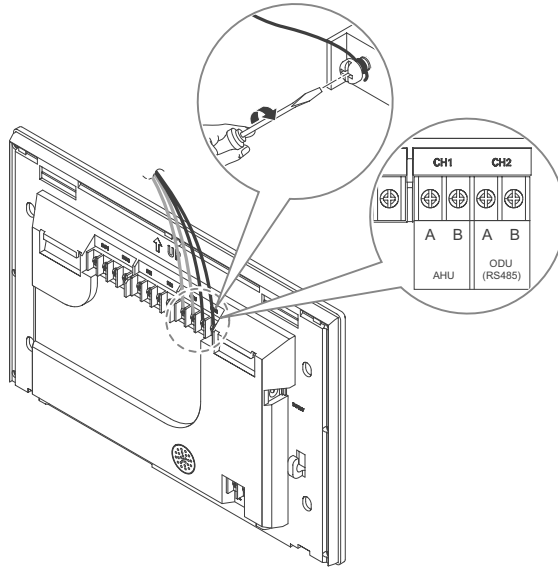
**Caution**

The RS485 cable has polarity, so be careful about keeping polarity when connecting the cables.

5. To use the network functions (email transmission and web control) provided by AC Smart Premium, connect an Ethernet cable to the LAN port on the back of AC Smart Premium.

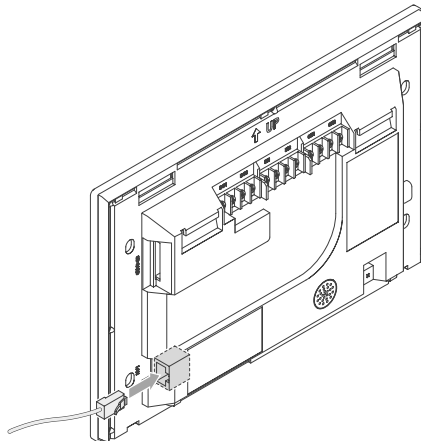

6. Connect the power.

- For global models
 - On the back of AC Smart Premium, connect the power adapter to the power port.

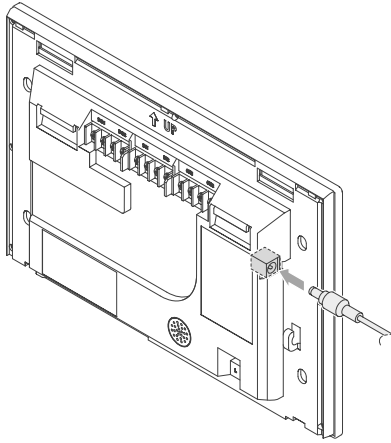

The adaptor is not provided with the AC Smart package sold in the U.S.

 **Notes**

You can hang the power cord on the power cord hanger located below the power port.

- For US models
 - At the bottom of AC Smart Premium, connect the power cord to the power port.

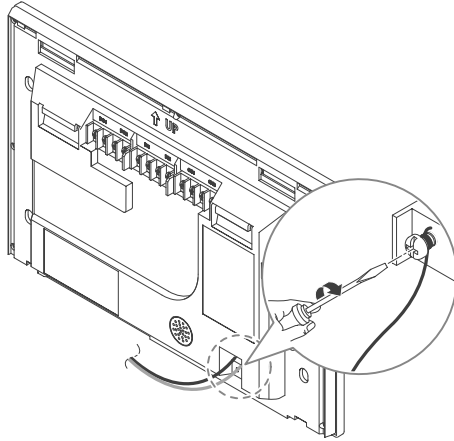

! **Notes**

In some countries, except for the U.S., you can connect the 12V power to the AC Smart Premium by using the provided adapter. If necessary, connect the 24V power to the AC Smart Premium.

7. After attaching the hook on the top of the main body to the top of the rear panel installed on the wall, please push the top of the main body unit forward for firm attachment.

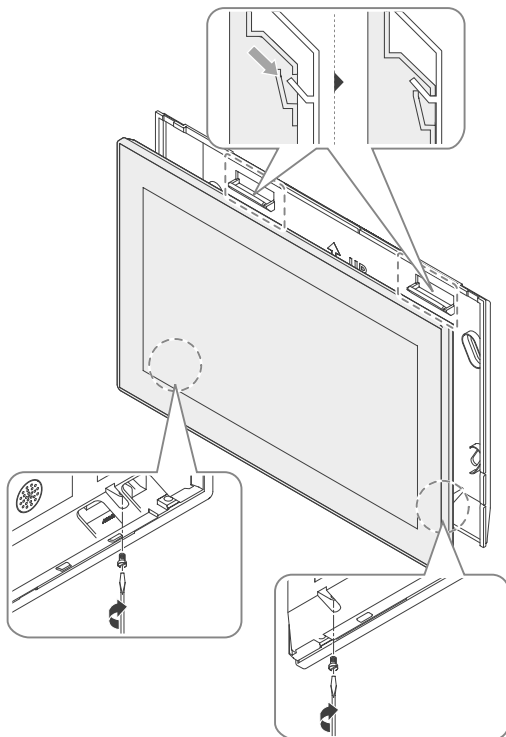
**Caution**

Please screws 2 points from the bottom of the unit to prevent from falling.

**Notes****Product removal**

After removing 2 screws from the bottom of the body, slightly pull the body using the flatblade screwdriver and lift up the body to remove the product.

8. Connect the power cord of the power adapter to the power plug.

Configure an emergency stop

In the event of an emergency, like a fire, AC Smart Premium can stop all connected devices (indoor units, ERV, DOKITs, AWHPs, and AHUs). The fire detection sensor detects a fire and sends an closed contacts signal to the AC Smart Premium DI1 port, which stops the operation of all connected devices.

You must connect the external fire detection sensor to the DI1 port of dry contact terminal on the back of AC Smart Premium (see graphic below) before you can use the emergency stop.

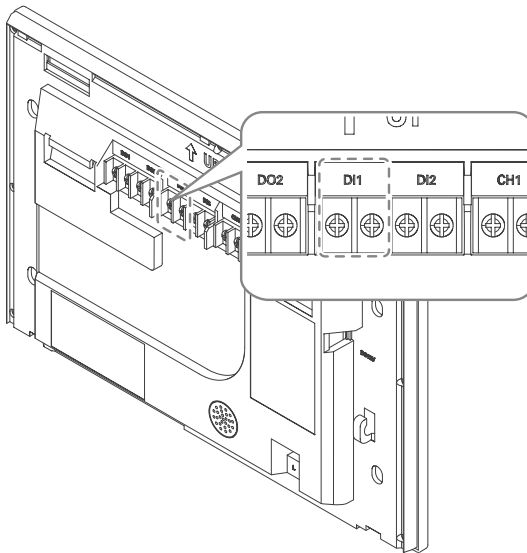

Caution

The DI1 port should always be open except when a fire occurs.

Information Input Method

ENGLISH

Touch the AC Smart Premium information input box and a touch keyboard at the bottom of the panel will appear. Use the touch keyboard to input information.



Starting

This section explains how to connect to the system and register devices to setup the environment (prior to using AC Smart Premium).

Turning on/off the screen

The following explains how to turn on or off the AC Smart Premium screen.

Turning on the screen

You can turn on the screen as follows.

1. Press the power button on the bottom of the unit.
 - The screen turns on.

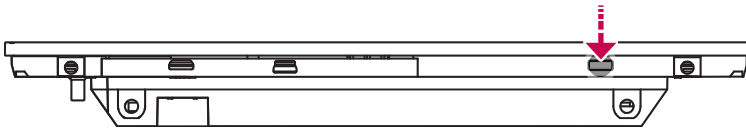

Turning off the screen

You can turn off the screen as follows.

1. Briefly press the power button on the bottom of the unit.
 - The screen turns off.

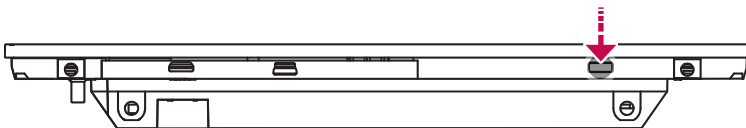

Notes

If you are not going to use AC Smart Premium for a long time, it is recommended that the screen be turned off.

Rebooting

You can reboot the device as follows.

1. Press the power button on the bottom of the unit for 10 or more seconds.
 - The device reboots.

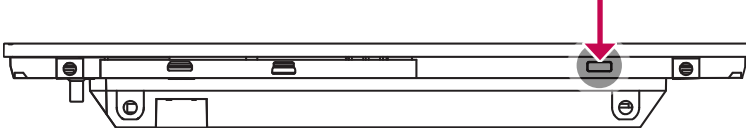

Login and logout

The following explains how to log in and out of AC Smart Premium.

AC Smart Premium is, can be controlled not only equipment, but also Web. If you enter the IP address of the AC Smart Premium in the address bar of the Internet without the installation of another program, the central control program AC Smart Premium, Web server has is executed automatically, to use the functionality of the various content I can.

The Manual, I will explain to AC Smart Premium standard equipment.



Notes

- You will need the Adobe Flash Player be installed for the Web control.
- The special character (^), (') and (,) are not available.

Login

You can login as follows.

1. Run AC Smart Premium.
2. After entering your ID and password in the login window, click **[Confirm]**.
 - You are now logged in.

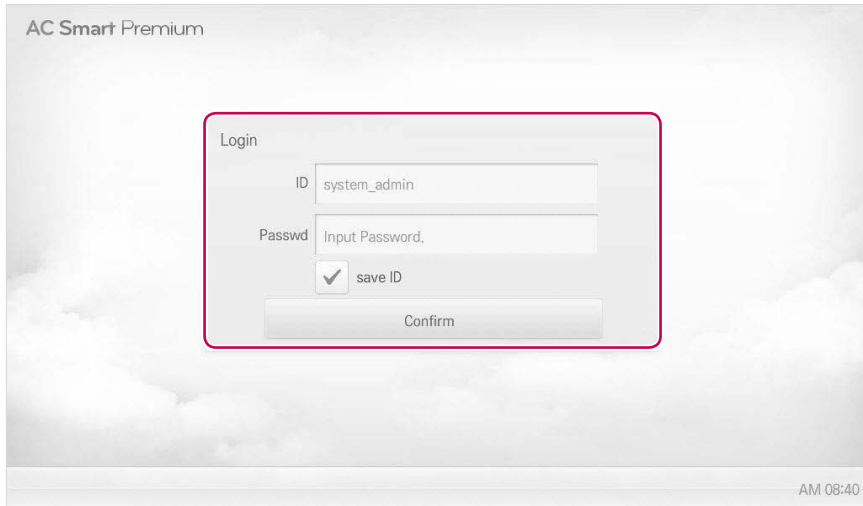

Logout

You can logout as follows.

1. On the top right of the AC Smart Premium home screen, touch the **[Logout]** button.
 - You are now logged out.

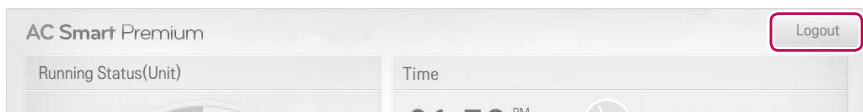

Home screen composition and features

The following explains the home screen composition and features.



Number	Item	Description
①	Running Status (Unit)	Checks if the devices are operating, stopped, or in error..
②	Time	Check the current date and time. (You need Internet connection to check the weather.)
③	Today's Schedule	<ul style="list-style-type: none"> • Check the registered schedules in chronological order. • Touch the [+] button to move to the schedule menu.
④	Main Menu	Use AC Smart Premium main menu.
⑤	Home	Return to the home screen.
⑥	View Menu	Display the active menu.
⑦	Current Menu	Display the name of the active menu.

Using the Program

The following explains how to use the AC Smart Premium functions.

Control/Monitor

The following explains the Control/Monitor menu options.

Control/Monitoring screen composition and features

The following explains Control/Monitoring screen composition and features.



Number	Item	Description
①	Select/Deselect All	Select/deselect all devices in a group.
②	[Drawing] Button	View floor plans of a group.
③	[Filter] Button	Select which device types are displayed for monitoring and control.
④	View Type Select	Select a view type for the monitoring screen (Icon/Simple/Detail) (For more on View Type , refer to page 28)
⑤	Group List	Check device group listings.
⑥	Monitoring Screen	Check the control status of a device.

Number	Item	Description
⑦	Device Control Box	<ul style="list-style-type: none"> • Display the device control menu. • The device control box shows different menus depending on the device. (For more on Control Menu per Device, refer to page 33)

View Type

Control/Monitor menu has three types of views (icon, simple, and detailed). The following shows the screen composition and features per view type.

Icon

The control status is shown in icons. The device icon has a composition and feature as follows.

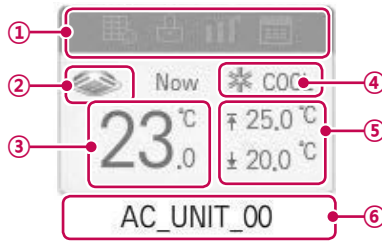

Number	Item	Description
①	Operation Mode and Device Status Icon	The color at the top of the icon box shows the current operation mode, and the status of the device is indicated as an icon.
②	Device Icon	The device to be controlled is indicated as an icon. The device shown may not represent the appearance of the actual unit.
③	Current Temperature	Display the current temperature.
④	Operation Mode	Display the operation mode of the device.
⑤	Desired Temperature	Display the desired temperature.
⑥	Device Name	Display the name of the device.

Simple

The control device and operation mode are displayed only.









Number	Item	Description
①	Operation Mode	The color of the box indicates the current operation mode.
②	Device Icon	The device to be controlled is indicated as an icon.

Detail





All properties of the control device are tabulated in detail.

Monitoring screen colors and icons









Box colors and operation mode per icon

Color	Icon	Operation Mode
 (Blue)		Cooling
		Ventilation, General
 (Orange)		Heating
		Ventilation, Electric Heat
 (Navy)		Dehumidification
 (Sky Blue)		Fan
 (Green)		Power Saving
 (Purple)		Auto
		Ventilation, Auto
 (Yellow)	-	ON & Short
 (Gray)	-	OFF & Open
	-	Error

Device status icon

Icon	Device Status
	Filter Exchange
	Full Lock On
	Peak/Demand Control
	Schedule

Control device icon

Icon	Device Type
	Indoor Device
	ERV
	AHU
	AWHP
	Chiller
	DI
	DO
	DOKIT

Device Control

You can control the devices as follows.

1. From the main menu, touch the **[Control/Monitor]** menu icon.
2. Touch the device group you want to control from the group list.
 - The monitoring screen for the device is displayed.
3. Touch the device you want to control.
 - To select all devices, click the button at the top.
 - The device control area appears at the bottom of the screen.
4. In the device control box, set the control status of the device.
 - The device control box shows a different menu depending on the device. For information about the control area for each device, refer to **Control Menu per Device** on page 33.
5. Once you have finalized the settings, touch the **[Apply]** button.

Control Menu per Device

The control box menu differs depending on the device. The following shows the control box menu per device.

Indoor Device

The following is the indoor unit control menu and features.

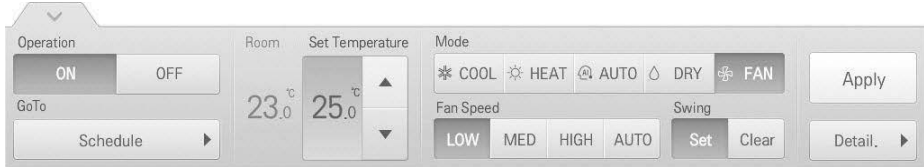

Item	Description
Operation	<ul style="list-style-type: none"> • [ON] Button: Starts the operation of the device. • [OFF] Button: Stops the operation of the device.
GoTo	[Schedule▶] Button: Move to Schedule menu.
Room	Display the current temperature.
Set Temperature	Touch [▲] / [▼] to set the temperature. (The maximum/minimum temperatures that can be set may differ depending on the model.)
Mode	<ul style="list-style-type: none"> • [COOL] Button: Operates with Cooling Mode. • [HEAT] Button: Operates with Heating Mode. • [AUTO] Button: Evaluates the operating environment conditions and automatically sets the optimum mode. • [DRY] Button: Dehumidifies during rainy seasons or whenever humidity is high. You cannot set the temperature in this mode. • [FAN] Button: Fan runs without temperature control to clean the air. You cannot set the temperature in this mode.
Fan Speed	<ul style="list-style-type: none"> • [LOW] Button: Slow fan speed. • [MED] Button: Medium fan speed. • [HIGH] Button: Fast fan speed. • [AUTO] Button: Fan speed automatically adjusts between Low, Med, and High speeds.
Swing	<ul style="list-style-type: none"> • [Set] Button: Turns on automatic oscillation of the louvers. • [Clear] Button: Turns off automatic oscillation of the louvers.
[Detail. ▶] Button	Controls details.

- Indoor unit fine control



Item	Description
Operation	<ul style="list-style-type: none"> [ON] Button: Starts the operation of the device. [Off] Button: Stops the operation of the device.
Set	Touch [▲]/[▼] to set the temperature.
Mode	<ul style="list-style-type: none"> [COOL] Button: Operates with Cooling Mode. [HEAT] Button: Operates with Heating Mode. [AUTO] Button: Evaluates the operating environment conditions and automatically sets the optimum mode. [DRY] Button: Dehumidifies during rainy seasons or whenever humidity is high. You cannot set the temperature in this mode. [FAN] Button: Fan runs without temperature control to clean the air. You cannot set the temperature in this mode.
Fan Speed	<ul style="list-style-type: none"> [LOW] Button: Slow fan speed. [MED] Button: Medium fan speed. [HIGH] Button: Fast fan speed. [AUTO] Button: Loops from Low to Medium to High speeds.
Swing	<ul style="list-style-type: none"> [Set] Button: Turns on automatic oscillation of the louvers. [Clear] Button: Turns off automatic oscillation of the louvers.
Filter Alarm	Touch the Disable button to deactivate the filter exchange alarm. (For other models, it may not work properly.)

Item	Description
Partial Lock	<ul style="list-style-type: none"> • [HardLock] Button: Disables remote control for all features. • [Clear] Button: All functions are unlocked. • [ModeLock] Button: Disables remote control for local mode setting. • [Clear] Button: Mode is unlocked. • [FanLock] Button: Disables remote control for local fan speed setting. • [Clear] Button: Fan speed is unlocked. • [TempLock] Button: Disables remote control for local temperature setting. • [Clear] Button: Temperature setting is unlocked.
Set Temp Range	Touch [▲]/[▼] to set the temperature limit.
[2Setpoint] Button	Switches between cooling and heating within the selected temperature range.

- Indoor 2Setpoint (Auto Operation Mode)

The screenshot shows a control interface for an Indoor 2Setpoint system. At the top, it is labeled 'IDU' and '2Setpoint'. The main area contains several settings:

- AutoChangeOver:** A toggle switch set to 'OFF'.
- Lower(18-30):** A temperature range selector set to 20.0.
- Upper(18-30):** A temperature range selector set to 27.0.
- Setback:** A toggle switch set to 'OFF'.
- Cooling Start Temp.:** A temperature selector set to 40.0.
- Heating Start Temp.:** A temperature selector set to 6.0.

At the bottom of the screen, there are two buttons: 'Cancel' and 'Apply'.

Item	Description
Auto Change Over	<p>Set the auto change over function to switch the operation mode automatically to keep the proper room temperature.</p> <ul style="list-style-type: none"> • [ON] Button: Enable Auto Change Over • [OFF] Button: Disable Auto Change Over
Lower	Touch [▲]/[▼] to set the lower limit temperature range (18°C~30°C / 64°F~86°F).
Upper	Touch [▲]/[▼] to set the upper limit temperature range (18°C~30°C / 64°F~86°F).

Item	Description
Setback	Set the setback function to control the proper room temperature when the indoor unit is turned off. <ul style="list-style-type: none"> • [ON] Button: Enable temperature limits • [OFF] Button: Disable temperature limits
Cooling Start Temp.	Touch [▲]/[▼] to set the cooling start temperature (21°C~40°C / 70°F~104°F).
Heating Start Temp.	Touch [▲]/[▼] to set the heating start temperature (1°C~20°C / 34°F~68°F).

ERV

The following is the ERV control menu and features.



Item	Description
Operation	<ul style="list-style-type: none"> • [ON] Button: Starts the operation of the device. • [Off] Button: Stops the operation of the device.
GoTo	[Schedule▶] Button: Move to Schedule menu.
Room	Display the current temperature.
Set Temperature	Touch [▲]/[▼] to set a desired temperature (the ERV is not activated).
Mode	<ul style="list-style-type: none"> • [AUTO] Button: Evaluates the operating environment conditions and automatically sets the optimum temperature. • [HEX] Button: Air supply and emissions are all ventilated through the heat exchanger. • [NORM] Button: Ventilate emissions without passing through the heat exchanger.
Fan Speed	<ul style="list-style-type: none"> • [LOW] Button: Slow fan speed. • [HIGH] Button: Fast fan speed. • [SUPER] Button: Maximum fan speed. • [AUTO] Button: Loops from Low to Medium to High speeds.
[Detail. ▶] Button	Control details.

- ERV Fine Control

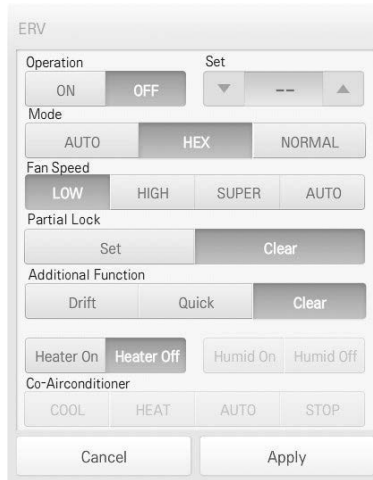

Item	Description
Operation	<ul style="list-style-type: none"> • [ON] Button: Starts the operation of the device. • [OFF] Button: Stops the operation of the device.
Set	Touch [▲] / [▼] to set a desired temperature (the ERV is not activated).
Mode	<ul style="list-style-type: none"> • [AUTO] Button: Evaluates the operating environment conditions and automatically sets the optimum temperature. • [HEX] Button: Air supply and emissions are all ventilated through the heat exchanger. • [NORMAL] Button: Ventilate emissions without passing through the heat exchanger.
Fan Speed	<ul style="list-style-type: none"> • [LOW] Button: Slow fan speed. • [HIGH] Button: Fast fan speed. • [SUPER] Button: Maximum fan speed. • [AUTO] Button: Loops from Low to Medium to High speeds.
Partial Lock	<ul style="list-style-type: none"> • [Set] Button: Disables remote control for all features. • [Clear] Button: Disable the lock.
Additional Function	<ul style="list-style-type: none"> • [Drift] Button: Reduces energy consumption by operating in the most efficient method possible. • [Quick] Button: Operates at maximum performance to prevent the room's contaminated or humid air from entering other spaces. • [Clear] Button: Disables power saving / rapid operation. • [Heater On] Button: Enables the heater function to heat the room. • [Heater Off] Button: Disables the heater function. <p>Some additional function might not be provided according to your country such as U.S.</p>

ERV DX

The following is the ERV DX control menu and features.

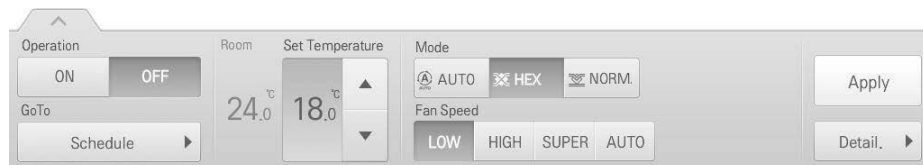

Item	Description
Operation	<ul style="list-style-type: none"> • [ON] Button: Starts the operation of the device. • [Off] Button: Stops the operation of the device.
GoTo	[Schedule ►] Button: Move to Schedule menu.
Room	Display the current temperature.
Set Temperature	Touch [▲]/[▼] to set the temperature.
Mode	<ul style="list-style-type: none"> • [AUTO] Button: Evaluates the operating environment conditions and automatically sets the optimum temperature. • [HEX] Button: Air supply and emissions are all ventilated through the heat exchanger. • [NORM] Button: Ventilate emissions without passing through the heat exchanger.
Fan Speed	<ul style="list-style-type: none"> • [LOW] Button: Slow fan speed. • [HIGH] Button: Fast fan speed. • [SUPER] Button: Maximum fan speed. • [AUTO] Button: Loops from Low to Medium to High speeds.
[Detail. ►] Button	Control details.

- ERV DX

The screenshot shows the ERV DX control panel with the following settings:

- Operation:** ON (selected), OFF, Set: 18.0
- Mode:** AUTO, HEX (selected), NORMAL
- Fan Speed:** LOW (selected), HIGH, SUPER, AUTO
- Partial Lock:** Set, Clear
- Additional Function:** Drift, Quick, Clear
- Heater/Humid:** Heater On, Heater Off (selected), Humid On, Humid Off
- Co-Airconditioner:** COOL, HEAT, AUTO, STOP (selected)
- Buttons:** Cancel, Apply

Item	Description
Operation	<ul style="list-style-type: none"> • [ON] Button: Starts the operation of the device. • [OFF] Button: Stops the operation of the device.
Set	Touch [▲] / [▼] to set the temperature.
Mode	<ul style="list-style-type: none"> • [AUTO] Button: Evaluates the operating environment conditions and automatically sets the optimum temperature. • [HEX] Button: Air supply and emissions are all ventilated through the heat exchanger. • [NORMAL] Button: Ventilate emissions without passing through the heat exchanger.
Fan Speed	<ul style="list-style-type: none"> • [LOW] Button: Slow fan speed. • [HIGH] Button: Fast fan speed. • [SUPER] Button: Maximum fan speed. • [AUTO] Button: Loops from Low to Medium to High speeds.
Partial Lock	<ul style="list-style-type: none"> • [Set] Button: Disables remote control for all features. • [Clear] Button: Disables the lock.
Additional Function	<ul style="list-style-type: none"> • [Drift] Button: Reduces energy consumption by operating in the most efficient method possible. • [Quick] Button: Operates at maximum performance to prevent the room's contaminated or humid air from entering other spaces. • [Clear] Button: Disables power saving / rapid operation. • [Heater On] Button: Enables the heater function to heat the room. • [Heater Off] Button: Disables the heater function. • [Humid On] Button: Enables the humidifier function for room humidity control. • [Humid Off] Button: Disable the humidifier function (not activated). <p>Some additional function might not be provided according to your country such as U.S.</p>

Item	Description
Co-Airconditioner	<ul style="list-style-type: none"> • [COOL] Button: Operates with Cooling Mode. • [HEAT] Button: Operates with Heating Mode. • [AUTO] Button: Operates in Auto Mode. • [STOP] Button: Stops the air conditioning function.

AHU

The following is the AHU control menu and features.

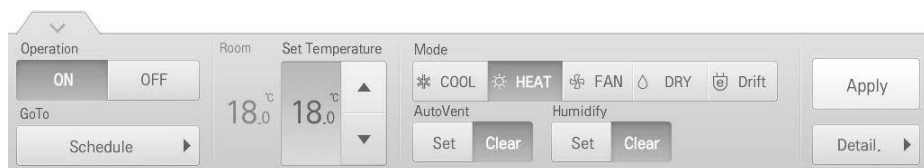

Item	Description
Operation	<ul style="list-style-type: none"> • [ON] Button: Starts the operation of the device. • [Off] Button: Stops the operation of the device.
GoTo	[Schedule ►] Button: Move to Schedule menu.
Room	Display the current temperature.
Set Temperature	Touch [▲]/[▼] to set the temperature.
Mode	<ul style="list-style-type: none"> • [COOL] Button: Operates with Cooling Mode. • [HEAT] Button: Operates with Heating Mode. • [FAN] Button: Purifies the air. • [DRY] Button: Dehumidifies the air during the rainy season or when humidity is high. • [Drift] Button: Reduces energy consumption by operating in the most efficient method possible.
AutoVent	<ul style="list-style-type: none"> • [Set] Button: If the CO2 concentration level increases during cooling or heating, increase the outdoor air volume to reduce the CO2 concentration level. • [Clear] Button: Disables AutoVent.
Humidify	<ul style="list-style-type: none"> • [Set] Button: Enables the humidifier function. • [Clear] Button: Disables the humidifier function.
[Detail. ►] Button	Control details.

- AHU Fine Control

Item	Description
Operation	<ul style="list-style-type: none"> [ON] Button: Starts the operation of the device. [OFF] Button: Stops the operation of the device.
Set	Touch [▲] / [▼] to set the temperature.
Mode	<ul style="list-style-type: none"> [COOL] Button: Operates with Cooling Mode. [HEAT] Button: Operates with Heating Mode. [FAN] Button: Purifies the air. [DRY] Button: Dehumidifies the air during the rainy season or when humidity is high. [Drift] Button: Reduces energy consumption by operating in the most efficient method possible.
AutoVent	<ul style="list-style-type: none"> [Set] Button: If the CO₂ concentration level increases during cooling or heating, increase the outdoor air volume to reduce the CO₂ concentration level. [Clear] Button: Disables AutoVent.
CO2(ppm)	Use [▲] / [▼] to set the desired carbon dioxide emission level from 500 ppm to 1,500 ppm in intervals of 100 ppm (CO ₂ is not settable in some models.).
Humidify	<ul style="list-style-type: none"> [Set] Button: Enables the humidifier function. [Clear] Button: Disables the humidifier function.
Humidity(%)	Use [▲] / [▼] to set the desired humidity from 40% to 60% in intervals of 1%.
Partial Lock	<ul style="list-style-type: none"> [Set] Button: Disables remote control for all features. [Clear] Button: Disables the lock.
OA Damper	Use [▲] / [▼] to set the OA damper from 0° to 90° in intervals of 1°.
EA Damper	Use [▲] / [▼] to set the EA damper openness from 0° to 90° in intervals of 1°.
MIX Damper	Use [▲] / [▼] to set the mix damper openness from 0° to 90° in intervals of 1°.

DOKIT

The following is the DOKIT control menu and features.



Item	Description
Operation	<ul style="list-style-type: none"> • [ON] Button: Starts the operation of the device. • [Off] Button: Stops the operation of the device.
GoTo	[Schedule▶] Button: Move to Schedule menu.

AWHP

The following is the AWHP control menu and features.



Item	Description
Operation	<ul style="list-style-type: none"> • [ON] Button: Starts the operation of the device. • [Off] Button: Stops the operation of the device.
GoTo	[Schedule▶] Button: Move to Schedule menu.
Mode	<ul style="list-style-type: none"> • [AUTO] Button: Evaluates the operating environment conditions and automatically sets the optimum temperature. • [COOL] Button: Operates with Cooling Mode. • [HEAT] Button: Operates with Heating Mode.
Air/Water Temp.	(Indicated as air or water temperature depending on the product.) Touch [▲]/[▼] to set the air/water temperature.
HotWater Temp.	Touch [▲]/[▼] to set the water heater temperature.
[Detail. ▶] Button	Control details.

- AWHP Fine Control

AWHP

Operation

ON OFF

Hotwater

ON OFF

Partial Lock

Set Clear

Mode

AUTO COOL HEAT

Air Temp.(°C) HotWater Temp.(°C)

▼ 18.0 ▲ ▼ 50.0 ▲

Cancel Apply

Item	Description
Operation	<ul style="list-style-type: none"> • [ON] Button: Starts the operation of the device. • [OFF] Button: Stops the operation of the device.
Hotwater	<ul style="list-style-type: none"> • [ON] Button: Enables the hot water function. • [OFF] Button: Disables the hot water function.
Partial Lock	<ul style="list-style-type: none"> • [Set] Button: Disables remote control for all features. • [Clear] Button: Disable the lock.
Mode	<ul style="list-style-type: none"> • [AUTO] Button: Evaluates the operating environment conditions and automatically sets the optimum temperature. • [COOL] Button: Operates with Cooling Mode. • [HEAT] Button: Operates with Heating Mode.
Air/Water Temp.	(Indicated as air or water temperature depending on the product.) Touch [▲]/[▼] to set the air/water temperature.
Hot Water Temp.	Touch [▲]/[▼] to set the water heater temperature.

DO

The following is the DO control menu and features.



Item	Description
Operation	<ul style="list-style-type: none"> • [SHORT] Button: Short signal output. • [OPEN] Button: Open signal output.
GoTo	[Schedule ►] Button: Move to Schedule menu.

Registering Floor Plan

In the Control/Monitor menu, you can register floor plans to identify and locate each device and device group. On the floor plan, you can register space information as well as the location where a device is installed.

1. In the main menu, touch the **[Control/Monitor]** menu icon.
2. Select the device group you want to monitor from the group list.
 - The monitoring screen for the device is displayed.
3. Touch **[Drawing]** button.

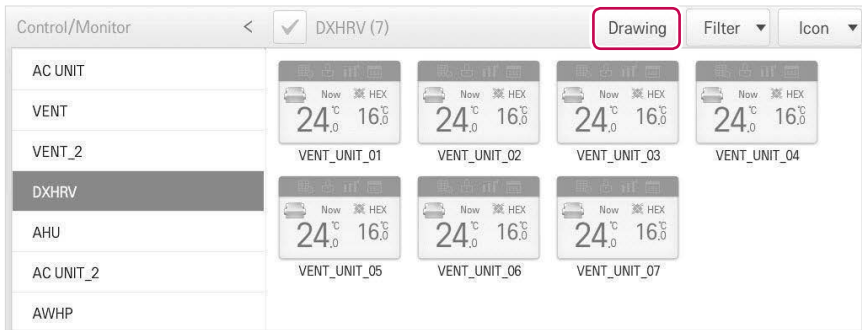

4. Touch **[Edit]** button.

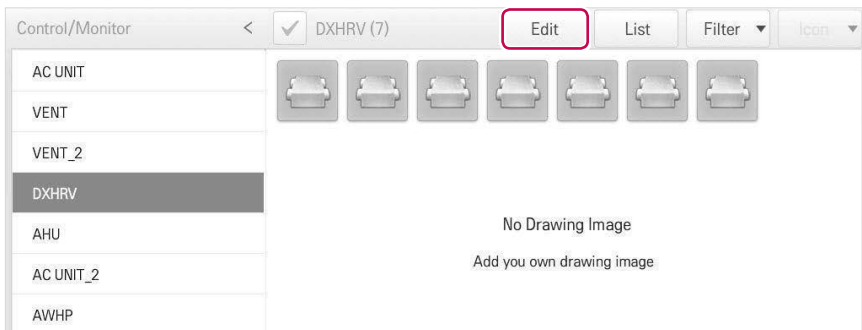

5. [Add Drawing] button.

- The Open Floor Plan window is displayed.

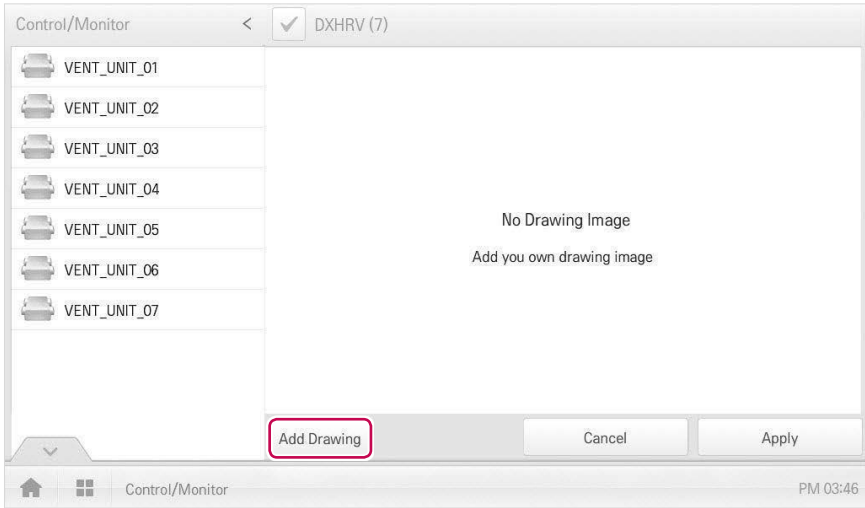

6. Select a desired floor plan from the Open Floor Plan window, then click [Confirm].

- The floor plan image is displayed.

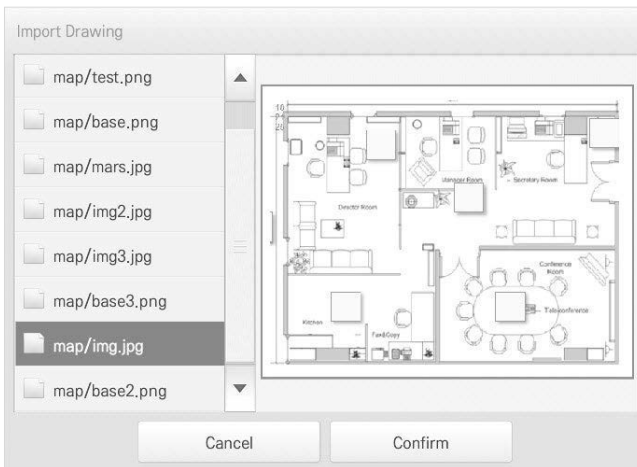

Notes

You cannot open a floor plan if the file name is in Korean. Use English file names.

7. In the device list, select a device you want to display on the floor plan and touch the device location on the plan.
- To delete a device from the plan, double-touch its icon.

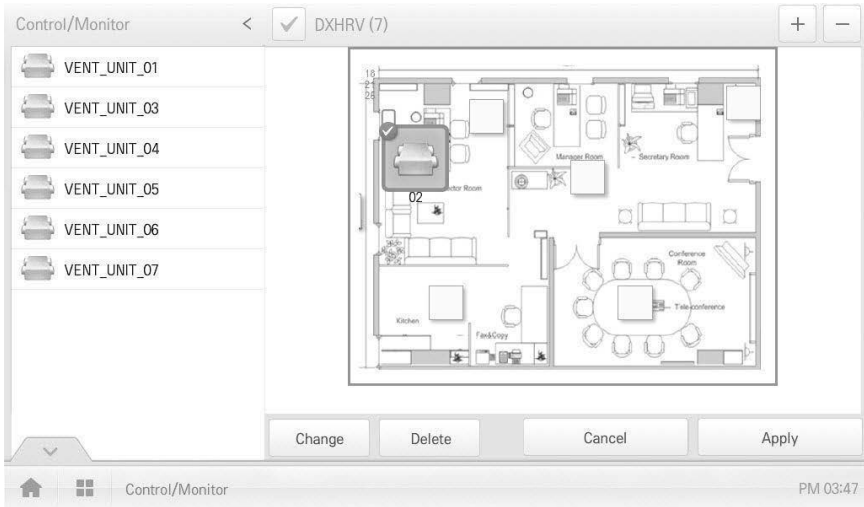

8. To complete the registration of the floor plan, touch the **[Apply]** button.



Notes

- To add a floor plan, you can only use jpg, gif, or png file formats.
- To add a floor plan, a 2MB or less image size is recommended.

Checking Floor Plan

In Control/Monitoring, you can check floor plans. On the floor plan, you can register space information as well as the location where a device is installed.

1. In the main menu, touch the **[Control/Monitor]** menu icon.
2. Select the device group you want to monitor from the group list.
 - The monitoring screen for the device is displayed.
3. Touch **[Drawing]** button.
 - The registered floor plan is displayed.

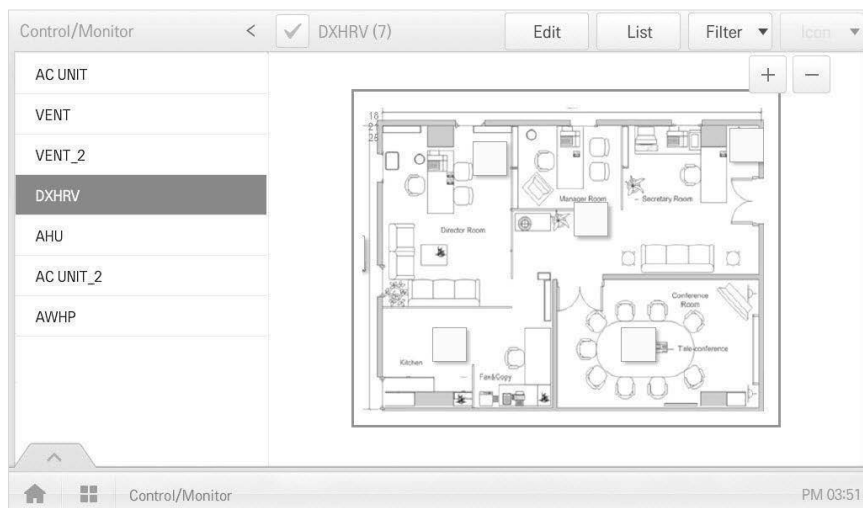

Editing the Floor Plan

You can edit a registered floor plan.

1. In the main menu, touch the **[Control/Monitor]** menu icon.
2. Select the device group you want to monitor from the group list.
 - The monitoring screen for the device is displayed.
3. Touch **[Drawing]** button.

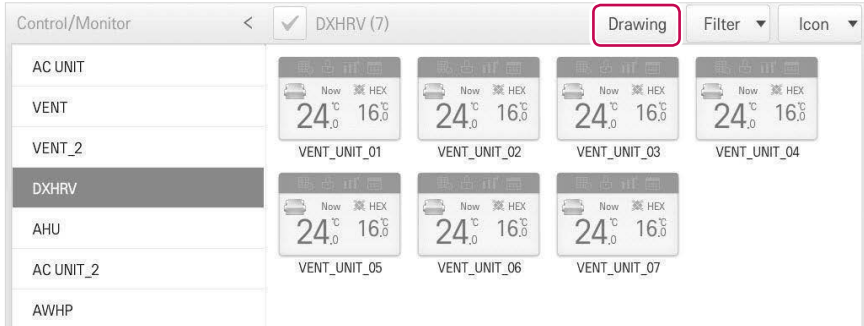

4. Touch **[Edit]** button.

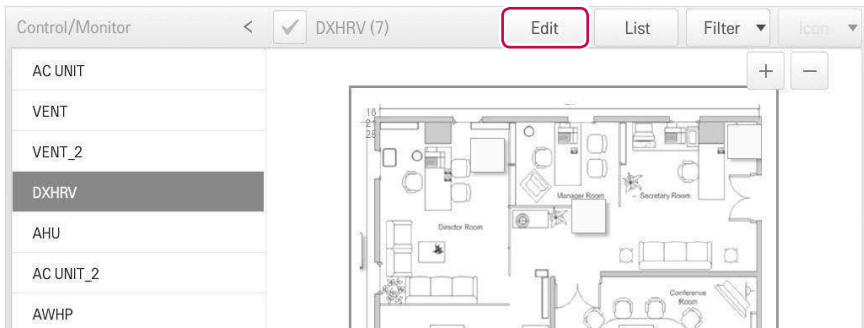

5. To change floor plan, touch **[Change]** button.
 - The Open Floor Plan window is displayed.
6. Select a desired floor plan from the Open Floor Plan window, then click **[Confirm]**.
 - The floor plan image is displayed.

- To change the location of a device, touch the icon of the device and then touch the location to which you want to move that device.

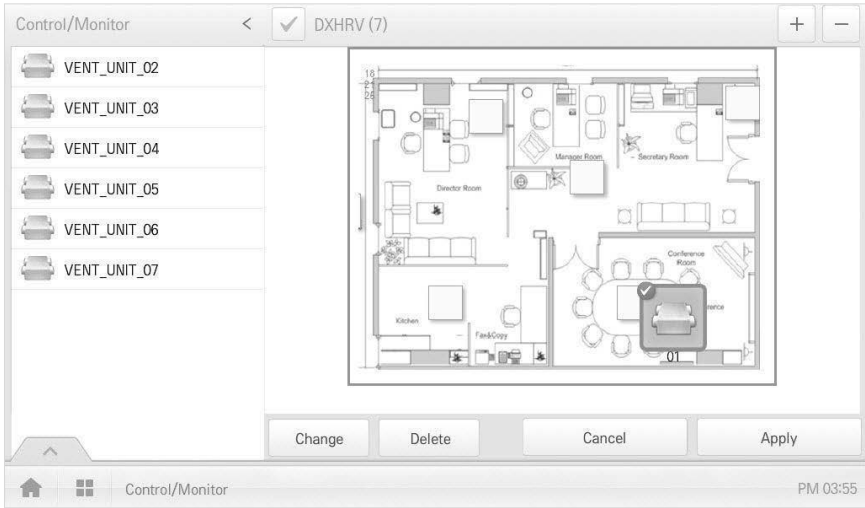

- To complete floor plan editing, touch the **[Apply]** button.



Notes

- To add a floor plan, you can only use jpg, gif, or png file formats.
- To add a floor plan, a 2MB or less image size is recommended.

Deleting the Floor Plan

You can delete a registered floor plan.

1. In the main menu, touch the **[Control/Monitor]** menu icon.
2. Select the device group you want to monitor from the group list.
 - The monitoring screen for the device is displayed.
3. Touch **[Drawing]** button.
 - The registered floor plan is displayed.
4. Touch **[Edit]** button.
5. To delete a floor plan, touch the **[Delete]** button.

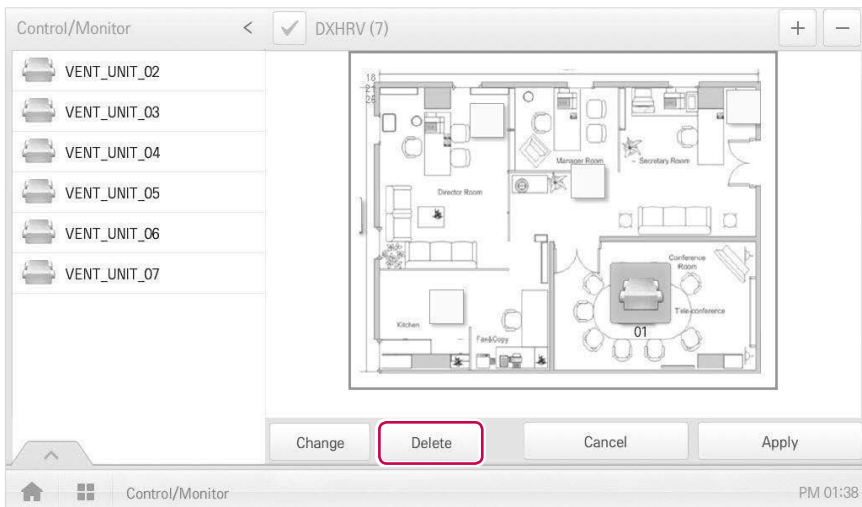

6. When you are prompted to confirm the deletion, touch **[Confirm]**.

Monitoring a Device

You can check the control state of registered devices.

1. In the main menu, touch the **[Control/Monitor]** menu icon.
2. Select the device group you want to monitor from the group list.
 - The monitoring screen for the device is displayed.
3. Touch a device you want to monitor.
4. Please check the device information in the monitoring screen.
 - The information on the monitoring screen differs depending on the view type. For details about the view types, refer to **View Type** on page 28.

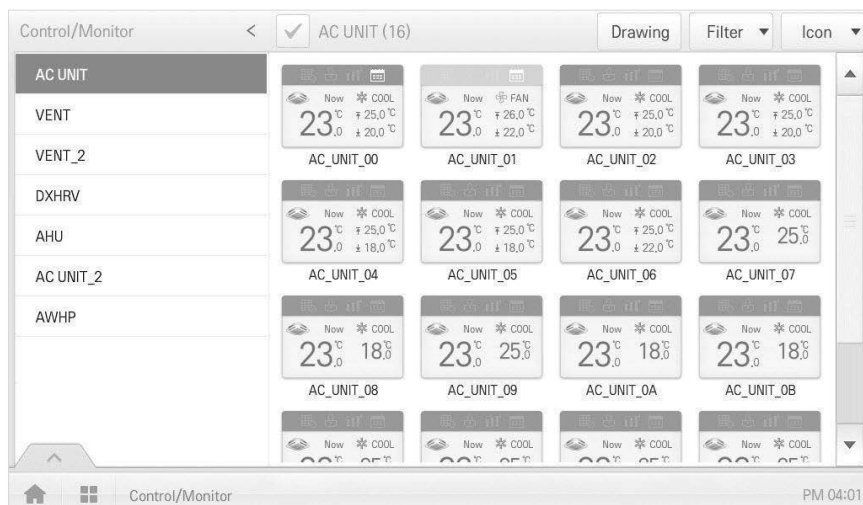

5. To check the control status of the device, touch the **[Detail.]** button.

Schedule

The Schedule feature allows you to program the behavior of the devices. If a device must adhere to a certain schedule, you can program the device to operate only at scheduled times. Scheduled devices do not activate unless programmed to do so and are managed centrally. This can significantly reduce energy consumption.

Schedule Screen composition and features

The following explains Schedule Screen composition and features.

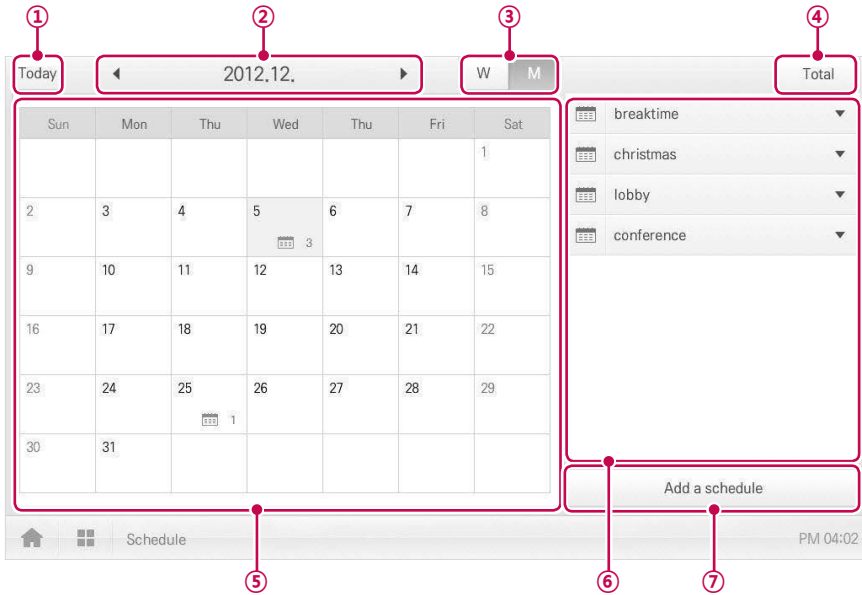

Number	Item	Description
①	[Today] Button	Display today's date, the current week, or the current month.
②	Dates	<ul style="list-style-type: none"> • Displays the selected date. • Use [◀]/[▶] to move to the previous/next date.
③	View Type	<ul style="list-style-type: none"> • [W] Button: Converts to Week View. • [M] Button: Converts to Month View.
④	[Total] Button	View full schedule list.
⑤	Calendar	<ul style="list-style-type: none"> • Displays the schedules for the selected dates. • Today's date is circled.

Number	Item	Description
⑥	Schedule List	Displays registered schedules by name.
⑦	[Add a Schedule] Button	Registers new schedules.

Creating Schedules

You can configure and add a schedule for a device.

1. In the main menu, touch **[Schedule]** menu icon.
2. **[Add a Schedule]** Button.
 - The Add Schedule window opens.
3. In the group list, touch a device for which a schedule is applied.
 - The selected device is displayed in the applied device area of the control command configuration.

Apply to

- ✓ AC UNIT
- ✓ VENT
- ✓ VENT_2
- ✓ DXHRV
- ✓ VENT_UNIT_01
- ✓ VENT_UNIT_02
- ✓ VENT_UNIT_03
- ✓ VENT_UNIT_04
- ✓ VENT_UNIT_05

Schedule Name
Please, Enter the name of schedule.

Time: PM 12:00 Period: 2012-12-05 ~ 2012-12-05

Repeat Pattern: Everyday Select day: Sun Mon Thu Wed Thu Fri Sat

Command

Apply to: Please select units on the list.

Command summary: No command

Cancel Confirm

PM 04:05

4. Configure the schedule information that controls the device.

Apply to

- ✓ RAC
- ✓ vent
- ✓ VENT_UNIT_29
- ✓ VENT_UNIT_2A
- ✓ VENT_UNIT_2B
- ✓ VENT_UNIT_2C
- ✓ VENT_UNIT_2D
- ✓ VENT_UNIT_2E
- ✓ VENT_UNIT_2F

Schedule Name
schedule1

Time PM 12:00 Period 2013-04-22 ~ 2013-04-22

Repeat Pattern Everyday Select day

Sun
 Mon
 Tue
 Wed
 Thu
 Fri
 Sat

Command

Apply to ERV(1) Command summary ERV No command

Cancel Confirm

Schedule AM 10:26

Item	Description
Schedule Name	Touch the input box. Use the displayed touch keyboard to type in a name for the schedule.
Time	<ul style="list-style-type: none"> • Touch the time area and then the [+]/[-] button to select the desired time. • Touch the [AM]/[PM] button to select before or after midday.
Period	Touch the period area and then the [+]/[-] button to select the desired period.
Repeat Pattern	<p>Touch the Repetition Pattern area and select a desired pattern.</p> <ul style="list-style-type: none"> • Select Day: Selected days the schedule will be performed. • Once: Applies a schedule once on a selected date. • Everyday: Applies the same schedule Everyday. • Mon - Fri: Applies a schedule repeatedly from Monday to Friday. • Mon - Sat: Applies a schedule repeatedly from Monday to Saturday.
Select day	Touch a desired day to apply a schedule.

5. Touch the device icon of the applied device.
 - The control configuration window for the device is displayed. The control configuration window differs depending on the device.



6. Configure the device control status, then touch the **[Confirm]** button.
 - The control list configured in the Command Summary area is displayed.

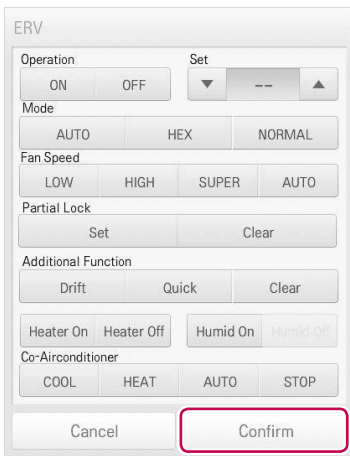

7. To complete the schedule configuration, touch the **[Confirm]** button.

Checking Schedules

You can check registered schedules.

1. In the main menu, touch the **[Schedule]** menu icon.
2. In the Date area, touch the **[◀/▶]** button to select a schedule search period.
 - The number of schedules are displayed for the selected date.

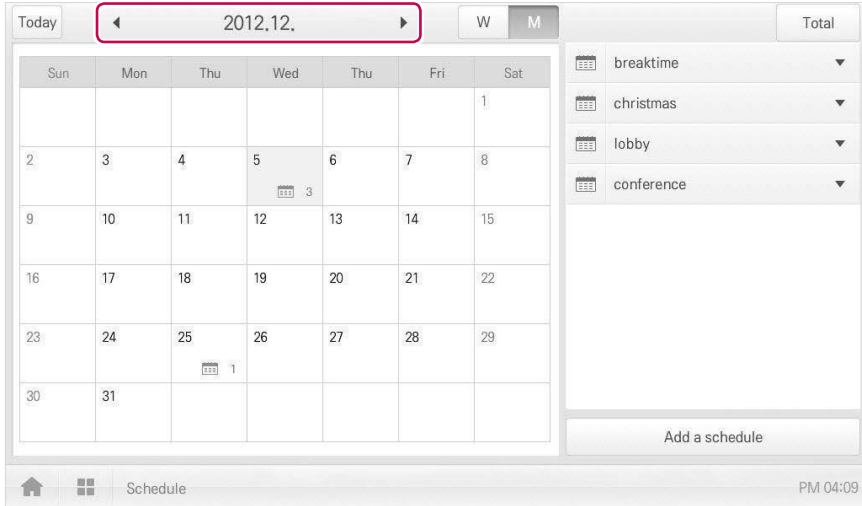

3. To check schedule details, touch a schedule you want to check in the schedule list.
 - Schedule details are displayed.

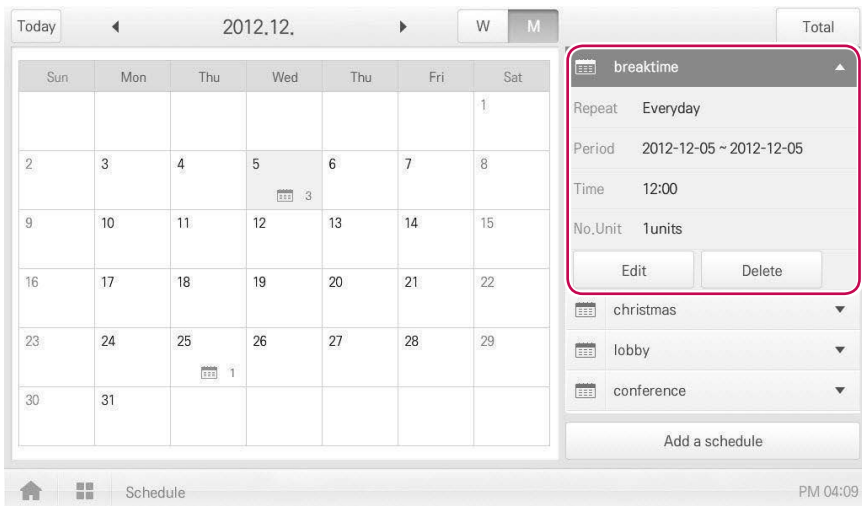

Editing Schedules

You can modify the content of a registered schedule as follows.

1. In the main menu, touch the **[Schedule]** menu icon.
2. Touch a schedule you wish to modify from the schedule list.
 - Schedule details are displayed.
3. Touch the **[Edit]** button.
 - The schedule configuration screen is displayed.

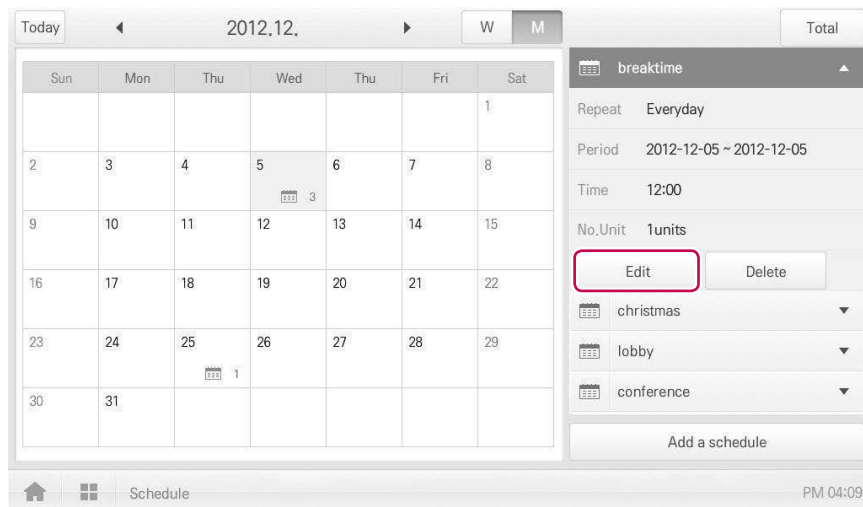

4. Modify the schedule information and device control configuration, then touch the **[Confirm]** button.
 - The changed data will be saved.

Deleting Schedules

You can delete a registered schedule as follows.

1. In the main menu, touch the **[Schedule]** menu icon.
2. Touch a schedule you wish to delete from the schedule list.
 - Schedule details are displayed.
3. Touch the **[Delete]** button.

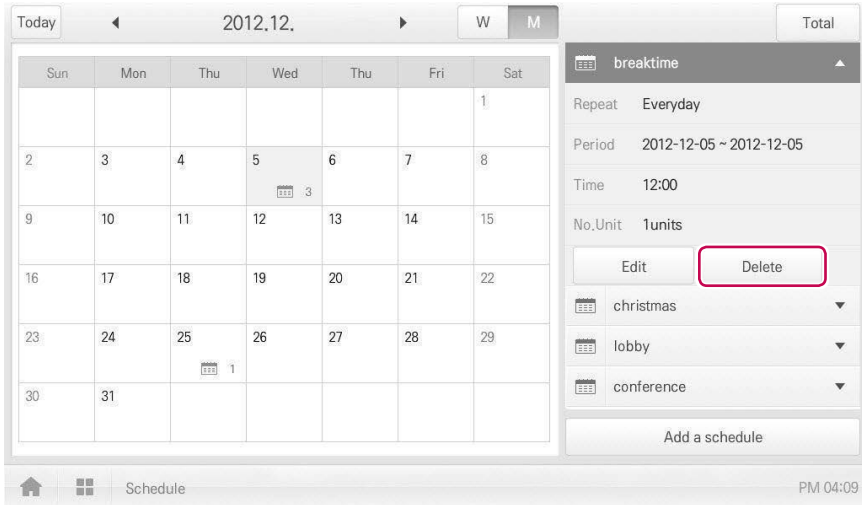

4. When you are prompted to confirm the deletion, touch **[Confirm]**.
 - The selected schedule is deleted.

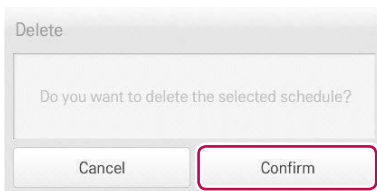

Auto Logic

Auto Logic allows the system to automatically control the power consumption of external devices. You can also set the indoor temperature to automatically adjust to outdoor conditions or activate devices for certain periods of time.



Notes

If you set a device control value in the auto logic status view, the device can operate based on that value.

Peak Control

Peak control limits peak power consumption. You can set the target operating rate so that total power consumption does not exceed the set limit. To prevent power consumption from exceeding the limit, the system will automatically change cooling mode to fan mode and cancel heating mode.



Notes

Depending on the installation site specifications, either the peak control or demand control functions can be selected. Go to **Environment > Advance Setting > Peak/Demand Set** and select a desired control type.

Editing Groups

The auto logic designates the registered devices as a group and controls them by group. The following explains how to create groups and how to edit the created groups.

Adding Groups

You can create a group as follows.

1. In the main menu, touch the **[AutoLogic > Peak Control]** menu icons.
2. Touch the **[Edit Group]** button.
 - The screen converts to Edit Group.
3. Touch the **[Add Group]** button.



Notes

By touching **[Apply default group]**, you can create a group automatically based on the group and indoor unit configuration set in the Device Management menu.

4. When the window to input a group name is displayed, use the touch keyboard to enter a group name and touch the **[Confirm]** button.
 - The group is added to the group list.

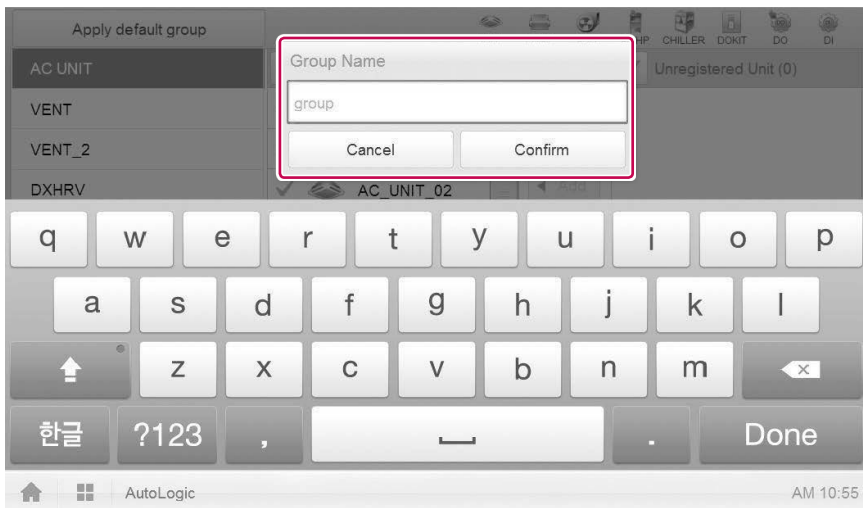

5. In the group list, touch the group added in Step 4.

6. In the non-registered device area, touch a device to add to the new group and touch the **[Add]** button.
- The selected device is moved to the registered device area.

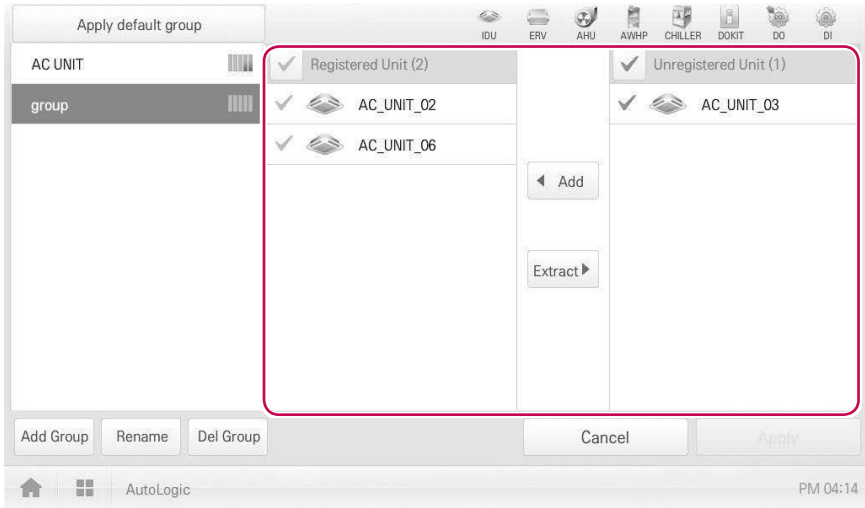

Notes

Peak control is only limited to indoor devices, therefore you cannot register other devices such as the ERV or AHU.

7. To complete group creation, touch the **[Apply]** button.

Changing Group Name

You can change the name of a registered group as follows.

1. In the main menu, touch the **[AutoLogic > Peak Control]** menu icon.
2. Touch the **[Edit Group]** button.
 - The screen converts to Edit Group.
3. In the group list, touch a group whose name you want to change and touch the **[Rename]** button.

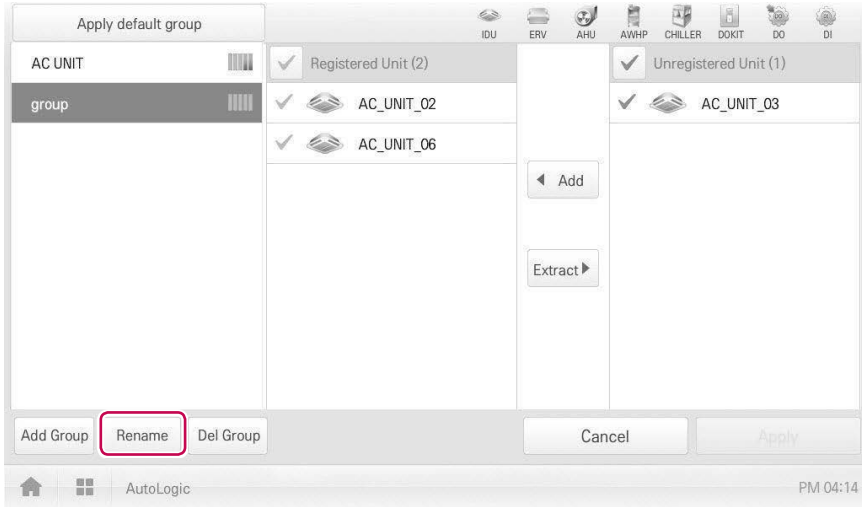

4. Use the touch keyboard to enter a new group name and touch the **[Confirm]** button.
 - The group name is now changed.
5. To complete group rename, touch the **[Apply]** button.

Deleting Groups

You can delete a registered group.

1. In the main menu, touch the **[AutoLogic > Peak Control]** menu icon.
2. Touch the **[Edit Group]** button.
 - The screen converts to Edit Group.
3. In the group list, touch a group to be deleted and touch the **[Del Group]** button.

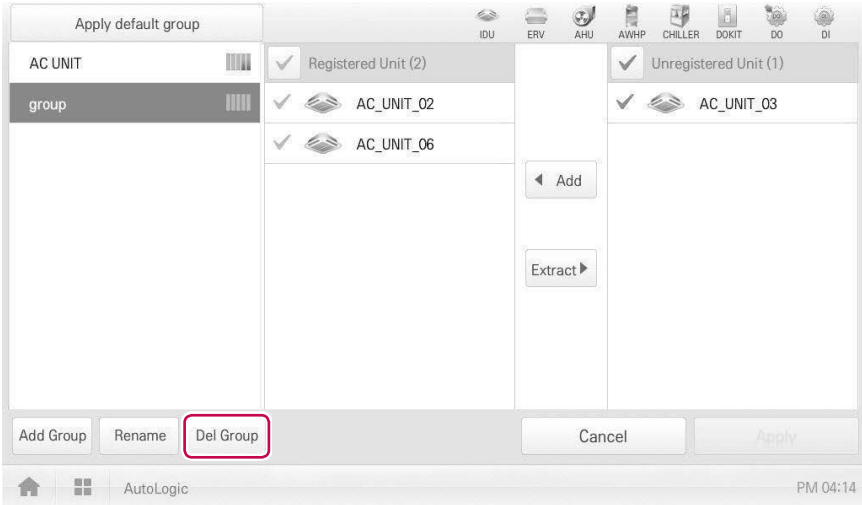

4. When you are prompted to confirm the deletion, touch **[Confirm]**.
 - The selected group is deleted and the tab removed.



Notes

- The group configured in Peak Control is also applied to Demand Control.
- If you change the group configuration in the device management menu, the group configured in Peak Control is initialized.

Configuring Peak Control

You can configure Peak Control as follows.

1. In the main menu, touch the **[AutoLogic > Peak Control]** menu icon.
2. Select the control status in the control configuration area.

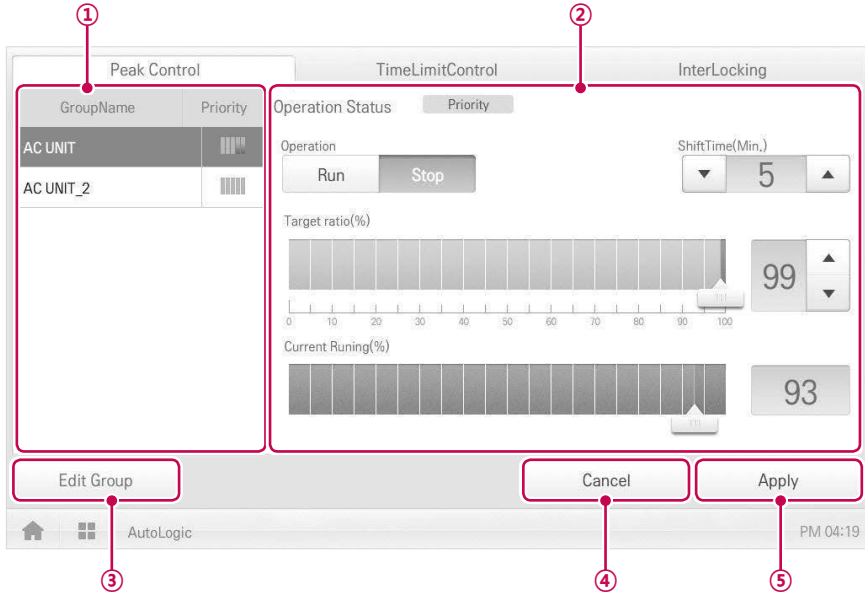

Number	Item	Description
①	Group List	Displays the device group list and group priority.
②	Control Configuration Area	Configures Peak Control configuration and details. <ul style="list-style-type: none"> • Operation Status <ul style="list-style-type: none"> - Can be configured in [Environment > Advance Setting]. - Priority Control: Control based on group priority - Outdoor Unit Control: Controls based on outdoor unit capacity limit.

Number	Item	Description
②	Control Configuration Area	<p>(Operation Status - Priority Control selected)</p> <ul style="list-style-type: none"> • Operation <ul style="list-style-type: none"> - [Run] Button: Operates the device. - [Stop] Button: Stops the operation of the device. • Shift Time(Min.): Touch [▲]/[▼] to set the time in minutes to force the operation to switch over. • Target ratio(%): Touch [▲]/[▼] to set the target rate. • Current Running(%): Displays the current rate. <p>(Operation Status - Outdoor unit capacity control selected)</p> <ul style="list-style-type: none"> • Operation <ul style="list-style-type: none"> - [Run] Button: Operates the device. - [Stop] Button: Stops the operation of the device. • Target ratio(%): Touch [▲]/[▼] to set the target rate.
③	[Edit Group] Button	Edit a control group.
④	[Cancel] Button	Cancels control configuration.
⑤	[Apply] Button	Applies control configuration.

3. To complete configuration, touch the **[Apply]** button.

Configuring Priority

1. In the main menu, touch the **[AutoLogic > Peak Control]** menu icon.
2. In the group list, touch the priority icon () of the group in question and then select a desired priority.

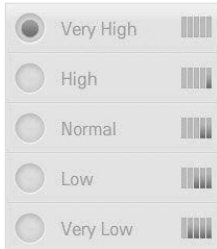

Notes

Basically, a newly added group has the highest priority. If a group is added, re-configure the priority for all groups.

Checking Peak Control Status

You can check the Peak Control configuration status as follows.

1. In the main menu, touch the **[AutoLogic > Peak Control]** menu icon.
2. Check how Peak Control is configured.

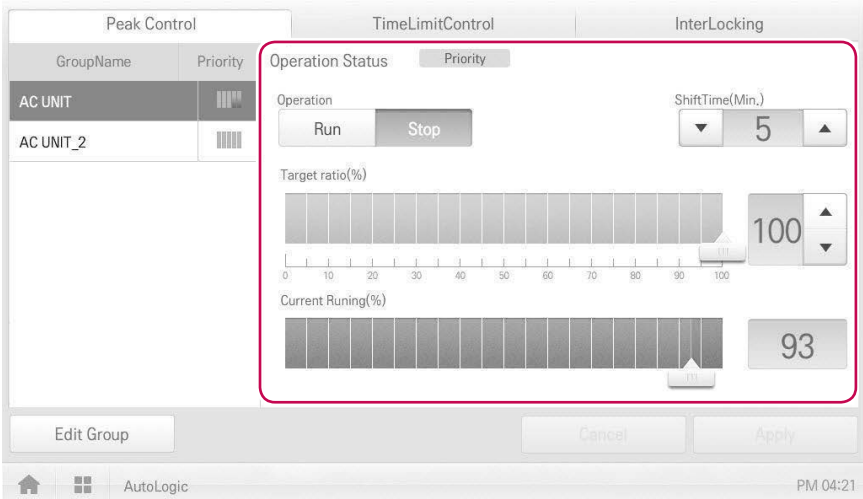

Item	Description
Control Configuration Area	Configure Peak Controls. <ul style="list-style-type: none"> • Operation Status <ul style="list-style-type: none"> - Can be configured in [Environment > Advance Setting]. - Priority: Controls based on group priority - Outdoor unit capacity control: Controls based on outdoor unit capacity limit. (Operation Status - Priority Control selected) <ul style="list-style-type: none"> • Operation <ul style="list-style-type: none"> - [Run] Button: Operates the device. - [Stop] Button: Stops the operation of the device. • ShiftTime(Min.): The cycle by which the operation switches over. • Target ratio(%): Displays the target operation rate. • Current Running(%): Displays the current rate. (Operation Status - Outdoor unit capacity control selected) <ul style="list-style-type: none"> • Operation <ul style="list-style-type: none"> - [Run] Button: Operates the device. - [Stop] Button: Stops the operation of the device. • Target ratio(%): Displays the target operation rate.

Demand Control

After observing changes in power consumption, this feature can prevent power consumption from exceeding a set limit. If you set the demand control and the program predicts that power consumption will exceed that limit, it will begin deactivating less important devices to save energy.



Notes

- For demand, depending on the installation site specifications, either the peak control or demand control functions can be selected. Go To **Environment > Advance Setting > Peak/Demand Settings** and select a desired control type.
- For outdoor capacity control, depending on the installation site specifications, either the peak control or demand control functions can be selected.
- In the Demand Control menu, you can only check the Demand Control status. You cannot **configure the operation, operation switchover cycle, desired rate, current rate**, etc.



Notes

AC Smart Premium can be used with the LG demand controllers (PCP-D11A2J), but not with the demand controllers from other manufacturers.

Checking Demand Control Status

You can check the Peak Control configuration status as follows.

1. In the main menu, touch the **[AutoLogic > Demand Control]** menu icon.
2. Check how Demand Control is configured.

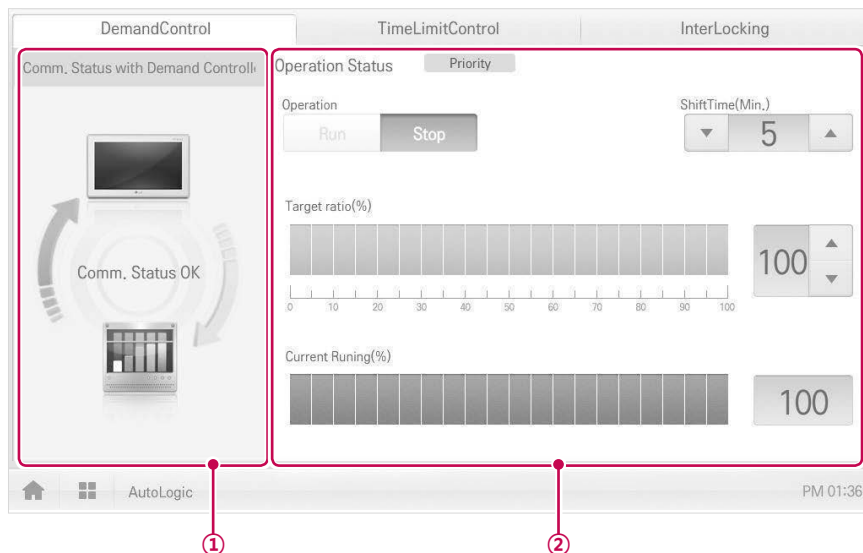

Number	Item	Description
①	Comm. Status with Demand Controller	Displays the communication status between demand controller and AC Smart Premium.
②	Control Configuration Area	Checks the demand configuration details. <ul style="list-style-type: none"> • Operation Status <ul style="list-style-type: none"> - Can be configured in [Environment > Advance Setting]. - Priority Control: Control based on group priority - Outdoor Unit Control: Controls based on outdoor unit capacity limit.

Number	Item	Description
②	Control Configuration Area	<p>(Operation Status - Priority Control selected)</p> <ul style="list-style-type: none"> • Operation <ul style="list-style-type: none"> - [Operate] Button: Operates the device. - [Stop] Button: Stops the operation of the device. • Shift Time(Min.): The cycle by which the operation switches over. • Target ratio(%): Displays the target operation rate. • Current Running(%): Displays the current rate. <p>(Operation Status - Outdoor unit capacity control selected)</p> <ul style="list-style-type: none"> • Operation <ul style="list-style-type: none"> - [Run] Button: Operates the device. - [Stop] Button: Stops the operation of the device. • Target ratio(%): Displays the target operation rate.

Time-limit Operation

The time-limit operation is to limit the amount of time the devices (indoor unit, ERV, DOKITs, AWHP, and AHU) are running individually. By setting the device operation time in advance, you can control for how long a device works and have it stop automatically.

Editing Groups

The auto logic designates the registered devices as a group and controls them by group. The following explains how to create groups and how to edit the created groups.

Adding Groups

You can create a group as follows.

1. In the main menu, touch the **[AutoLogic > TimeLimitControl]** menu icon.
2. Touch the **[Edit Group]** button.
 - The screen converts to Edit Group.
3. Touch the **[Add Group]** button.



Notes

By touching **[Apply default group]**, you can create a group automatically based on the group and indoor unit configuration set in the Device Management menu.

4. When the window to input a group name is displayed, use the touch keyboard to enter a group name and touch the **[Confirm]** button.
 - The group is added to the group list.

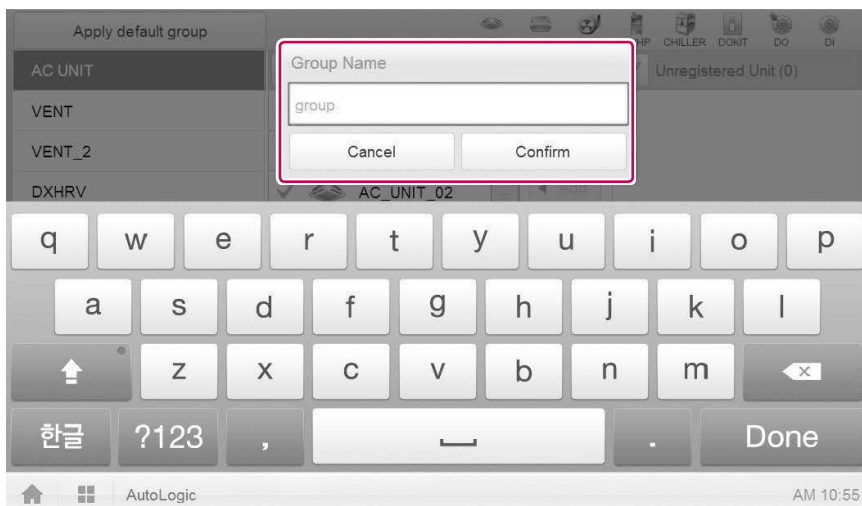

5. In the group list, touch the group added in Step 4.
6. In the non-registered device area, touch a device to add to the new group and touch **[Add]** button.
 - The selected device is moved to the registered device area.

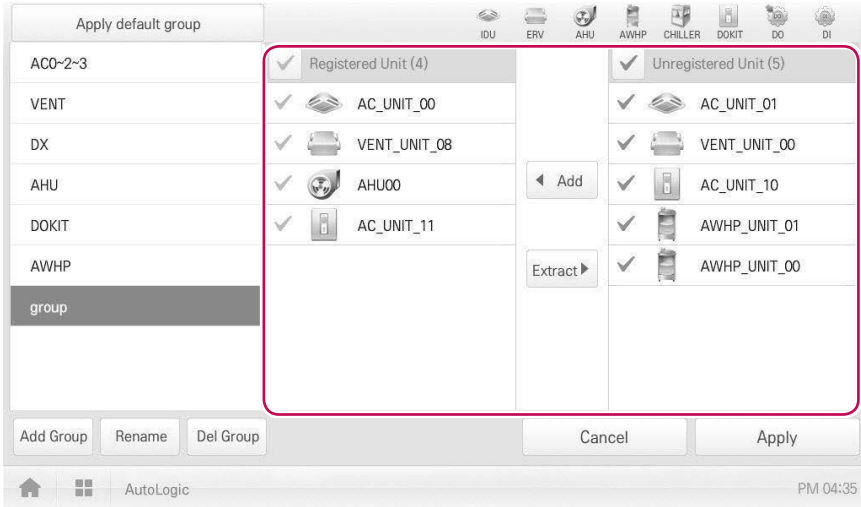

Notes

For the time-limit operation, you cannot register DI/DO.

7. To complete group creation, touch the **[Apply]** button.

Changing Group Name

You can change the name of a registered group as follows.

1. In the main menu, touch the **[AutoLogic > TimeLimitControl]** menu icon.
2. Touch the **[Edit Group]** button.
 - The screen converts to Edit Group.
3. In the group list, touch a group whose name you want to change and touch the **[Rename]** button.

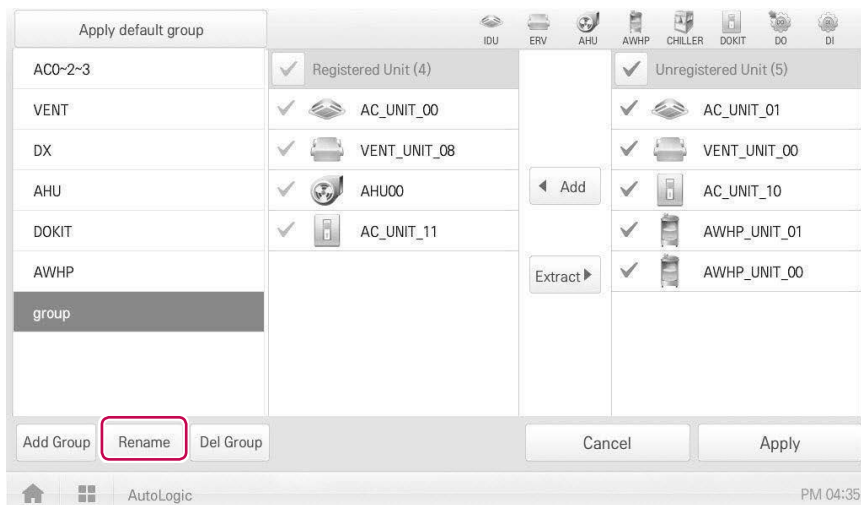

4. Use the touch keyboard to enter a new group name and touch the **[Confirm]** button.
 - The group name is now changed.
5. To complete group rename, touch the **[Apply]** button.

Deleting Groups

You can delete a registered group.

1. In the main menu, touch the **[AutoLogic > TimeLimitControl]** menu icon.
2. Touch the **[Edit Group]** button.
 - The screen converts to Edit Group.
3. In the group list, touch a group to be deleted and touch the **[Del Group]** button.

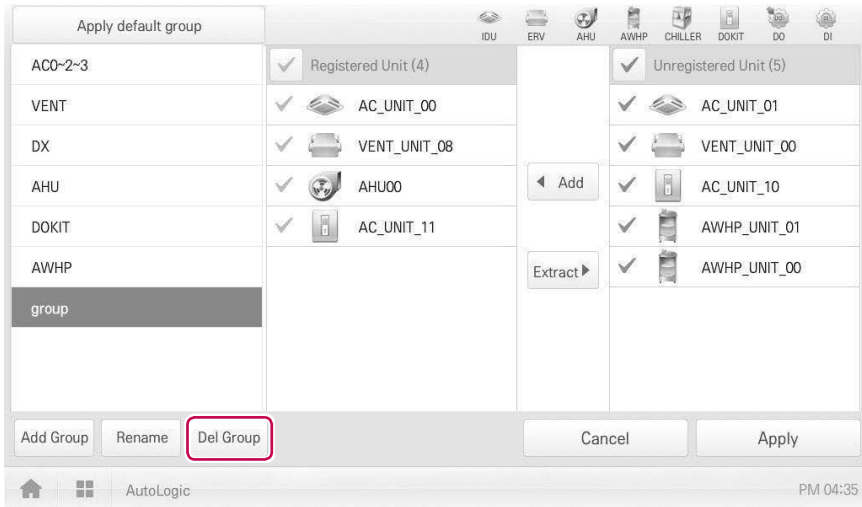

4. When you are prompted to confirm the deletion, touch **[Confirm]**.
 - The selected group is deleted and the tab removed.
5. To complete group delete, touch the **[Apply]** button.

Configuring Time-Limit Operation

1. In the main menu, touch the **[AutoLogic > TimeLimitControl]** menu icon.
2. In the group configuration status area, touch a group to be controlled.
 - The device list, status information, and condition details of the group are displayed.

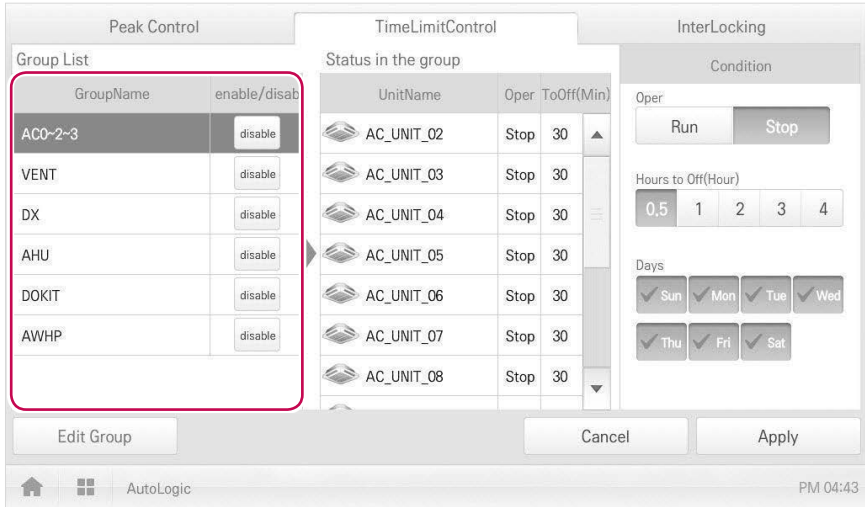

3. Select the control status in the conditions configuration area.

Item	Description
Oper	Choosing whether to run Time-Limit Operation <ul style="list-style-type: none"> • [Run] Button: Run the time-limit operation. • [Stop] Button: Stops the time-limit operation.
Hours to Off(Hour)	<ul style="list-style-type: none"> • Select the operation time limit of an operation group. • The devices included in the group operates for the selected time then stops automatically.
Days	Select a day on which to run the time-limit operation.

4. To run the time-limit operation on the group, in the group configuration operation status area, touch the **[disable]** button.
- The button changes to **[enable]**.

Peak Control		TimeLimitControl			InterLocking	
Group List		Status in the group			Condition	
GroupName	enable/disable	UnitName	Oper	ToOff(Min)	Oper	
ACQ~2~3	enable	AC_UNIT_02	Stop	30	Run Stop	
VENT	disable	AC_UNIT_03	Stop	30	Hours to Off(Hour)	
DX	disable	AC_UNIT_04	Stop	30	0.5 1 2 3 4	
AHU	disable	AC_UNIT_05	Stop	30	Days	
DOKIT	disable	AC_UNIT_06	Stop	30	Sun Mon Tue Wed	
AWHP	disable	AC_UNIT_07	Stop	30	Thu Fri Sat	
		AC_UNIT_08	Stop	30		

Buttons: Edit Group, Cancel, Apply

AutoLogic PM 04:43

5. To complete the configuration, touch the **[Apply]** button.

! Notes

If you change the operation stop standby time, it takes about 15 seconds to apply it.

InterLocking

You can integrate the system with external devices, like fire alarms, to halt the operation of all indoor units and ERV. For InterLocking, you should create a pattern for devices and apply the control configuration. The following explains how to create and manage a pattern and control device integration.

Managing Pattern

The following explains how to register integrated devices as a pattern and how to modify or delete a registered pattern.

Adding Pattern

You can add a pattern as follows.

1. In the main menu, touch the **[AutoLogic > InterLocking]** menu icon.
2. Touch the **[Add]** button.
 - A window to create a pattern is displayed.
3. Type a new pattern name in the pattern name input window and touch the **[Done]** button.



4. Click the **[Input Device]** tab.

5. In the non-registered device area, touch a device to be registered and touch the **[Add]** button.

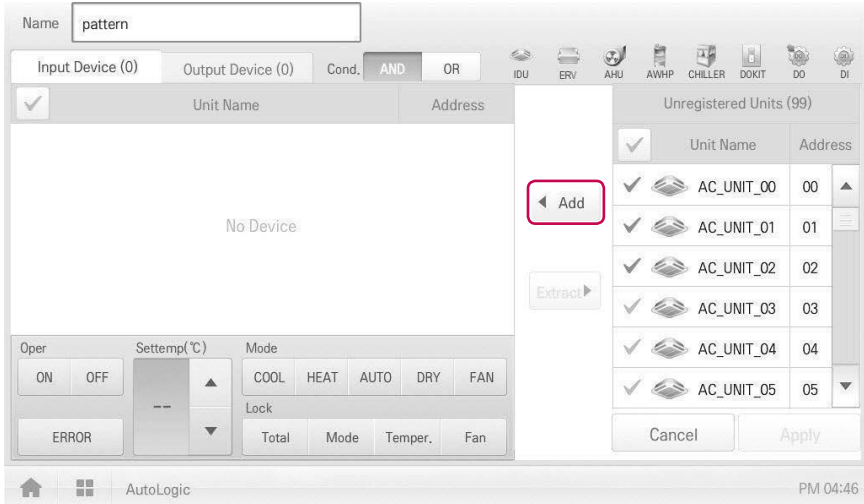

6. In the input device list, touch the device you want to trigger control.
 7. Select a control status in the control configuration area.
 8. Click the **[Output Device]** tab.
 9. In the non-registered device area, touch a device to be registered and touch the **[Add]** button.

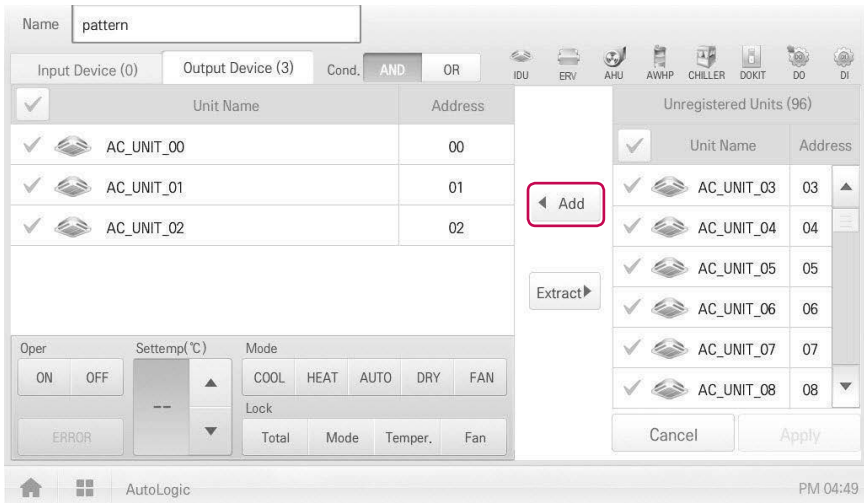

10. In the output device list, touch the device you want to control.
 11. Select a control status in the control configuration area.
 12. To complete the adding of a pattern, touch the **[Apply]** button.

Editing Pattern

You can edit a pattern as follows.

1. In the main menu, touch the **[AutoLogic > InterLocking]** menu icon.
2. Select a pattern and touch the **[Edit]** button.
 - The pattern editing screen opens.
3. Modify the pattern configuration information and touch the **[Apply]** button.

Deleting Pattern

You can delete a pattern as follows.

1. In the main menu, touch the **[AutoLogic > InterLocking]** menu icon.
2. Select a pattern to be deleted and touch the **[Delete]** button.
3. When you are prompted to confirm the deletion, touch **[Confirm]**.
 - The selected pattern is deleted.

Checking InterLocking

1. In the main menu, touch the **[AutoLogic > InterLocking]** menu icon.
2. Touch a pattern for which you want check the device integration.
 - The device integration status for the pattern is displayed.

Peak Control			TimeLimitControl		InterLocking	
Pattern			Input Device (1)			
No	Pattern Name	enable/disable	Unit Type	UnitName	Address	Operation
1	a	disable	IDU	AC_UNIT_06	06	⊕
2	aaaa	enable				
3	bbb	enable				
4	ccc	enable				
5	ddd	enable				
6	eee	enable				
			Output Device (1)			
			IDU	AC_UNIT_07	07	⊕
Add			Edit		Delete	
			Cancel		Apply	
AutoLogic			PM 04:50			

Statistics

The following explains how to use statistics and graphs to check the power consumption and operation time of a device.

Statistics Screen Composition and Features

The following explains the statistics screen composition and features.

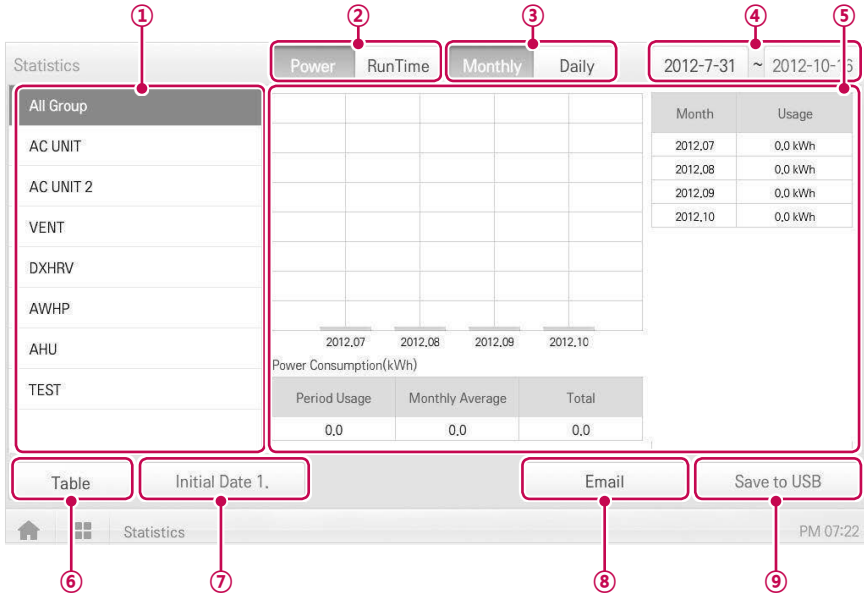

Number	Item	Description
①	Group List	Displays the device group list.
②	Statistics Items	<ul style="list-style-type: none"> • [Power] Button: You can check the power consumption of each group and total power consumption. • [RunTime] Button: You can check the operating time and the total operating time of indoor units in each group.
③	Query Unit	<ul style="list-style-type: none"> • [Monthly] Button: Queries on monthly consumption within the last four months. • [Daily] Button: Queries on daily consumption within the query period.

Number	Item	Description
④	Query Period Selection Area	<ul style="list-style-type: none"> • Selects the period for which you want to query statistics details for daily. • The start date should be no more than 31days before the end date.
⑤	Displays Statistics Information	<ul style="list-style-type: none"> • Statistics data per period: Displays power consumption per unit of query or operation time statistics and graphs. • Power consumption: Displays power consumption and use time.
⑥	[Table]/[Graph] Button	Converting Statistics Data View <ul style="list-style-type: none"> • Table: Views the queried statistics data in a table format. • Graph: Views the queried statistics data in a graphic format.
⑦	[Initial Date] Button	<ul style="list-style-type: none"> • Selects Statistics Reference Date. • Move to Settings > General Settings > Statistics Reference Date.
⑧	[Email] Button	Sends the queried statistics data to the email address registered in the Preferences menu.
⑨	[Save to USB] Button	Save the statistics data to a USB memory stick.

Querying Statistics

You can query the power consumption of a device or operation time statistics data as follows.

1. In the main menu, touch the **[Statistics]** menu icon.
2. Touch the device group you want from the group list.
3. Touch the button of the statistics item you want.
 - **[Power]** Button: You can check the power consumption of each group and total power consumption.
 - **[RunTime]** Button: You can check the operating time and the total operating time of indoor units in each group.
4. In the query period selection area, touch the date button and **[+]/[-]** button to select the desired period.
 - The start date should be no more than 31days for daily before the end date. The query period for monthly is automatically fixed to the last four months.

5. Check the statistics details in the statistics information display area.

- To change the statistics information view type, touch the **[Table]** or **[Graphic]** button.

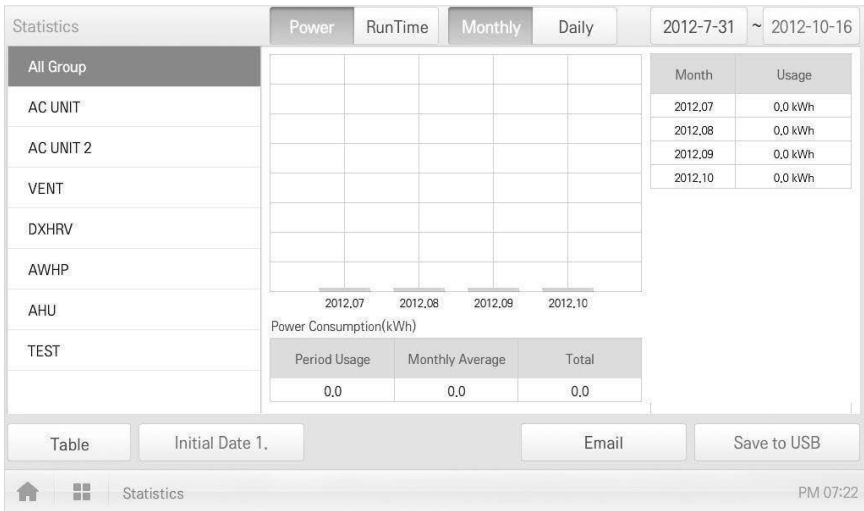

6. To send the statistics data by email, touch the **[Email]** button. To save it to a USB memory stick, touch the **[Save to USB]** button.

**Notes**

The statistics data is stored up to 6 months.

**Notes**

- Devices which can query the Run Time: Indoor units
- Devices which can query the Power consumption: devices which can be used with the PDI (For further information about the devices can be used with the PDI, please refer to the PDI manual.)

Report

The following explains how to query the device control information or error information.

Report screen composition and features

The following explains the report screen composition and features.

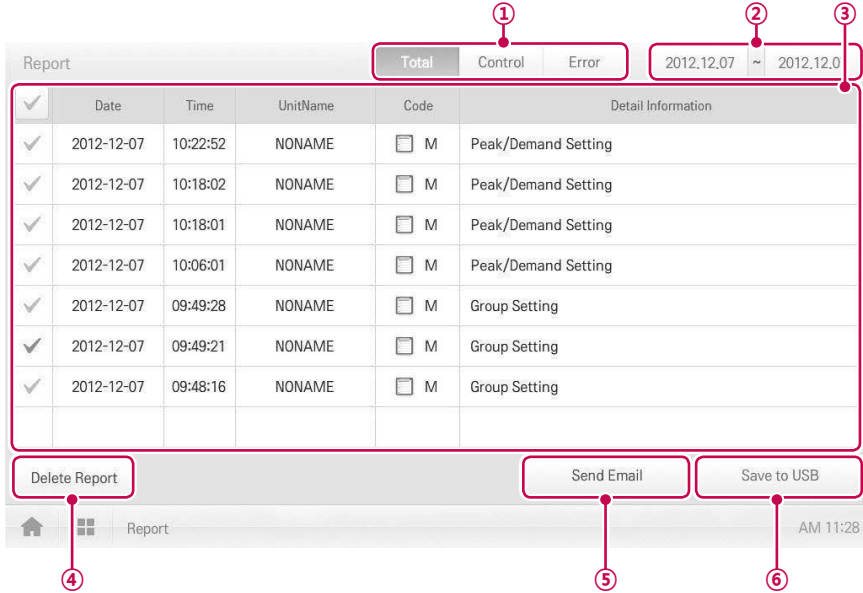

Number	Item	Description
①	Report Items	<p>Selects report query items.</p> <ul style="list-style-type: none"> • [Total] Button: Queries all reports regarding control and error. • [Control] Button: Queries control related reports only. • [Error] Button: Queries error related reports only.
②	Query Period Selection Area	<ul style="list-style-type: none"> • Selects the period for which you want to query report details. • The starting date should be no more than three months from the ending date.
③	Report detail display area	Displays the reports related to control and error.
④	[Delete Report] Button	Deletes the selected report.



Number	Item	Description
⑤	[Send Email] Button	Sends the queried reports to the email address registered in the Preferences menu.
⑥	[Save to USB] Button	Save the queried reports to a USB memory stick.

Querying Report

You can query the device control or error report as follows.

- In the main menu, touch the **[Report]** menu icon.
- In the report item, touch an item for which you want to query a report.
 - [Total]** Button: Queries all reports regarding control and error.
 - [Control]** Button: Queries control related reports only.
 - [Error]** Button: Queries error related reports only.
- In the query period selection area, touch the date button and **[+]/[-]** button to select the desired period.
 - The starting date should be no more than three months from the ending date.
- Check the report details in the report detail display area.

Report					Total	Control	Error	2012.12.07	~	2012.12.07
<input checked="" type="checkbox"/>	Date	Time	UnitName	Code	Detail Information					
<input checked="" type="checkbox"/>	2012-12-07	10:22:52	NONAME	<input type="checkbox"/> M	Peak/Demand Setting					
<input checked="" type="checkbox"/>	2012-12-07	10:18:02	NONAME	<input type="checkbox"/> M	Peak/Demand Setting					
<input checked="" type="checkbox"/>	2012-12-07	10:18:01	NONAME	<input type="checkbox"/> M	Peak/Demand Setting					
<input checked="" type="checkbox"/>	2012-12-07	10:06:01	NONAME	<input type="checkbox"/> M	Peak/Demand Setting					
<input checked="" type="checkbox"/>	2012-12-07	09:49:28	NONAME	<input type="checkbox"/> M	Group Setting					
<input checked="" type="checkbox"/>	2012-12-07	09:49:21	NONAME	<input type="checkbox"/> M	Group Setting					
<input checked="" type="checkbox"/>	2012-12-07	09:48:16	NONAME	<input type="checkbox"/> M	Group Setting					
					Delete Report		Send Email		Save to USB	



 Report AM 11:28

- To send the report detail by email, touch the **[Send Email]** button. To save it to a USB memory stick, touch the **[Save to USB]** button.



Caution

You can query up to 200 reports and email/save to USB memory up to 300 reports. Up to 5000 reports are stored.

Installing

You can add a device or change the settings of a registered device.

Registering Device

After installing AC Smart Premium, log into AC Smart Premium to register the devices to be connected.

AC Smart Premium can register a device by using one of two methods.

- Registering Device Automatically
- Registering Device Manually



Notes

To register a device on AC Smart Premium, you should login with administrator permissions. If you have logged in already with standard user permissions, you cannot proceed with this process any further.

Registering Device Automatically

Devices connected to AC Smart Premium are automatically searched for and registered. You can register a device automatically as follows.

1. In the main menu, touch the **[Installing]** menu icon.
2. Touch the **[Installing]** tab.
3. Touch the **[Auto Search]** button.

The screenshot shows the 'Installing' screen with the following components:

- Grouping:** Installing
- DeviceType:** ODU (selected)
- Unit Name(20 Characters):** Unit Name
- Address(00-FF):** Address
- Model(20 Characters):** Model
- Capacity:** Capacity
- Insert:** Button
- Unit Status:**
 - Total Unit: 130
 - ODU: 2
 - IDU: 40
 - ERV: 39
 - ERV DX: 1
 - AHU: 2
 - AWHP: 40
 - CHILLER: 0
 - DOKIT: 2
 - DO: 2
 - DI: 2
- Auto Search:** Button (highlighted with a red box)
- Table:**

DeviceType	Unit Name	Addr/Port	Model	Capacity
ODU	ODU[00]	00	MULTIV	100
ODU	ODU[01]	01	MULTIV	100
IDU	AC_UNIT_03	03	AC	3
IDU	AC_UNIT_04k	04	AC	3
IDU	AC_UNIT_05	05	AC	3
IDU	AC_UNIT_06	06	AC	3
- Buttons:** IDU Address Lock (checked), Modify Unit, Del Unit, Cancel, Apply
- Footer:** Installing, PMI 02:05



Notes

Please turn the screen saver off before **[Auto Search]**.

4. When you are prompted to confirm the setting, touch **[Confirm]**.
 - It takes 5 to 10 minutes to register a device automatically. Please turn the screen saver off before **[Auto Search]**

The 'Auto Search' dialog box contains the following text:

Find out the connected unit.
Auto Search will take about 5~10 minutes
and installing information will be replace with searched infomation
Before do this, please disable the screen saver function.
Do you want to continue?

Buttons: Cancel, Confirm (highlighted with a red box)

5. To save the searched devices, touch the **[Apply]** button.
 - Device registration is completed. 2 DIs and 2 DOs are always added to the Unit Status area as they are part of the AC Smart Premium hardware.

Registering Device Manually

Devices connected to AC Smart Premium can be registered by the user by entering relevant information. You can register a device manually as follows.

1. In the main menu, touch the **[Installing]** menu icon.
2. Touch the **[Installing]** tab.
3. Type the device information and touch the **[Insert]** button.

The screenshot shows the 'Installing' screen in the AC Smart Premium application. The top navigation bar includes icons for IDU, ERV, AHU, AWHP, CHILLER, DOKIT, DO, and DI. The main form has the following fields:

- DeviceType:** A dropdown menu currently set to 'ODU'.
- Unit Name(20 Characters):** A text input field labeled 'Unit Name'.
- Address(00-FF):** A text input field labeled 'Address'.
- Model(20 Characters):** A text input field labeled 'Model'.
- Capacity:** A text input field labeled 'Capacity'.
- Insert:** A button to register the device.

Below the form is a 'Unit Status' table:

Unit Status	DeviceType	Unit Name	Addr/Port	Model	Capacity
Total Unit					130
ODU	ODU	ODU[00]	00	MULTIV	100
IDU					40
ERV	ODU	ODU[01]	01	MULTIV	100
ERV DX					1
AHU	IDU	AC_UNIT_03	03	AC	3
AWHP					2
CHILLER	IDU	AC_UNIT_04k	04	AC	3
DOKIT					2
DO	IDU	AC_UNIT_05	05	AC	3
DI	IDU	AC_UNIT_06	06	AC	3

At the bottom of the screen, there are buttons for 'IDU Address Lock', 'Modify Unit', 'Del Unit', 'Cancel', and 'Apply'. The status bar at the bottom shows 'Installing' and the time 'PM 02:05'.

Item	Description
Device Type	Selects a device type. <ul style="list-style-type: none"> • IDU(indoor unit), ODU(Outdoor unit), ERV(Energy Recovery Ventilator), ERV DX(Direct Expansion Energy Recovery Ventilator), DI/DO, DOKIT, AWHP, or AHU
Unit Name (20 Characters)	Enter the device name. <ul style="list-style-type: none"> • Up to 20 characters.
Address (00-FF)	Type the central control of the device. <ul style="list-style-type: none"> • A central control value is a number between 00 and FF. You cannot type the same value for similar devices. • You cannot enter a duplicate value for indoor devices and DOKIT.
Model (20 Characters)	Type the device model. <ul style="list-style-type: none"> • Up to 20 characters.
Capacity (5-digit)	Type the maximum power consumption of the device. <ul style="list-style-type: none"> • Up to 5 characters. • The power consumption value of the actual device cannot exceed the input value.

4. To save the device, touch the **[Apply Change]** button.
 - Device registration is completed.

Changing Device

You can change the settings of registered devices.

1. In the main menu, touch the **[Installing]** menu icon.
2. Touch the **[Installing]** tab.
3. Touch a device to be changed in the device list.
 - The device information is displayed in the device information input box.
4. Type the device information and touch the **[Modify Unit]** button.
 - The changed device information is applied.
5. To save a change, touch the **[Apply]** button.

Deleting Device

Follow these steps to delete a device from the list.

1. In the main menu, touch the **[Installing]** menu icon.
2. Touch the **[Installing]** tab.
3. In the device list, touch a device to be deleted and touch the **[Del Unit]** button.
4. When you are prompted to confirm the deletion, touch **[Confirm]**.
 - The selected device is deleted from the list.
5. To save a change, touch the **[Apply]** button.

Managing Device

The following explains how to manage the information for a device added to the system.

Adding Groups

Follow these steps to add a new group.

1. In the main menu, touch the **[Installing]** menu icon.
2. Touch the **[Grouping]** tab.
3. Touch the **[Add Group]** button.
4. When the window to type a group name is displayed, use the touch keyboard to enter a group name and touch the **[Confirm]** button.
 - The group is added to the group list.



5. In **Grouping**, touch the group added in Step 4.

6. In the non-registered device area, touch a device to add to the new group and touch the **[Add]** button.
- The selected device is moved to the registered device area.

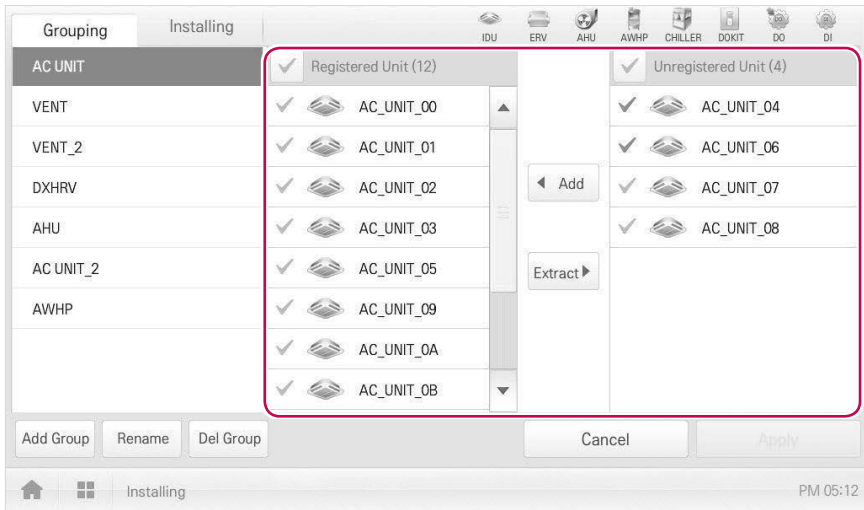

7. To complete group creation, touch the **[Apply]** button.
- When all non-registered devices are registered, the **[Apply]** button is enabled.

Changing Group Name

You can change the name of a registered group as follows.

1. In the main menu, touch the **[Installing]** menu icon.
2. Touch the **[Grouping]** tab.
3. In the device management list, touch a group whose name you want to change and touch the **[Rename]** button.

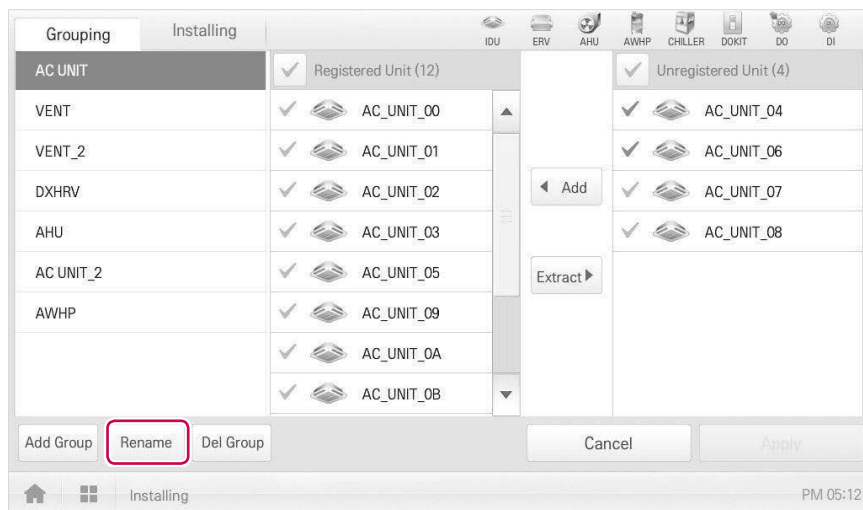

4. Use the touch keyboard to enter a new group name and touch the **[Confirm]** button.
 - The group name is changed.

Deleting Groups

You can delete a registered group.

1. In the main menu, touch the **[Installing]** menu icon.
2. Touch the **[Grouping]** tab.
3. In the device management list, touch a group to be deleted and touch the **[Del Group]** button.

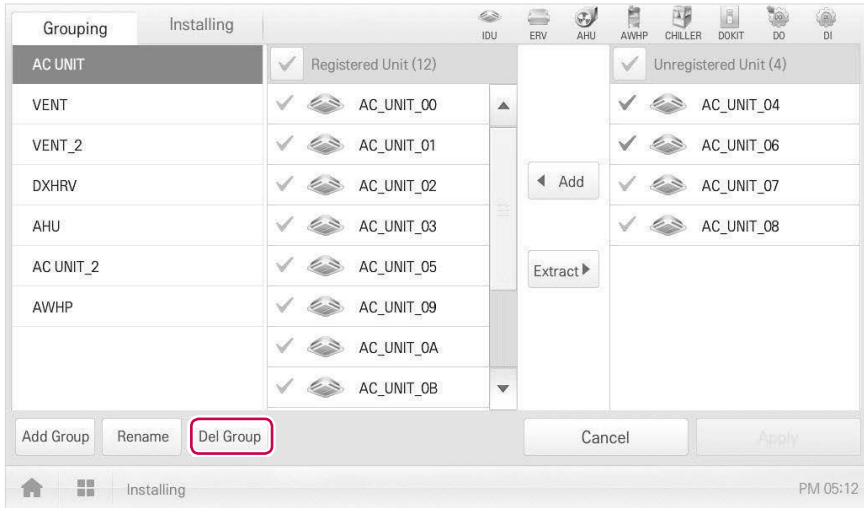

4. When you are prompted to confirm the deletion, touch **[Confirm]**.
 - The selected group is deleted and the tab removed.

Environment

The following explains how to configure the system environment for user convenience and how to check an already configured environment.

General Setting

The following explains how to configure the general system environment.

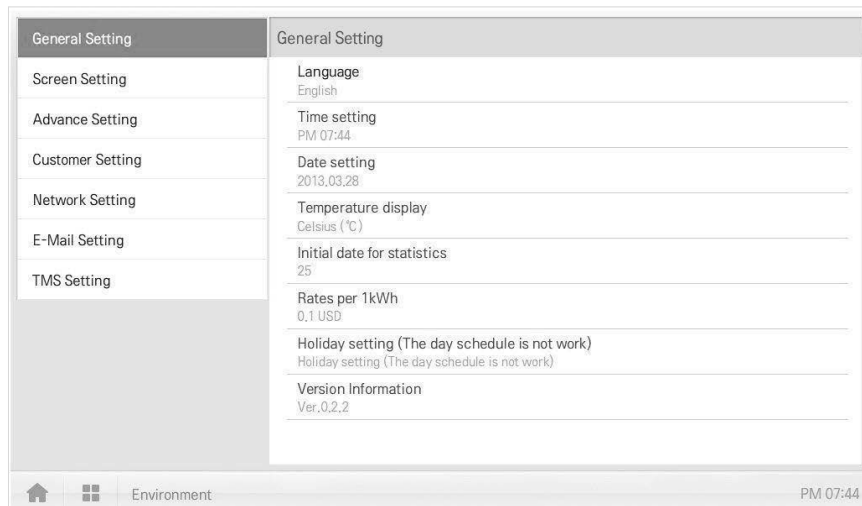

Item	Description
Language	Configures the language displayed on the screen (한국어(Korean)/ English/ Italiano/ Español/ Português/ русский язык/ Français/ Deutsch Sprache/ Türkçe/ Język Polski)
Time setting	Configures system time.
Date setting	Configures system date.
Location settings	Configures the current location.
Temperature display	Configures the temperature unit.
Initial date for statistics	Configures the reference date for querying statistical data.
Rates per 1kWh	Configures the charge per 1kWh and currency.
Holiday setting (The day schedule is not work)	Selects the days for which schedules are not be applied.
Version Information	Displays the current software version.

Language

Configures the language displayed on the screen.

1. In the main menu, touch the **[Environment]** menu icon.
2. In the settings list, touch **General Setting**.
3. In the detailed settings list, touch **Language**.
4. Touch a language you want.
 - The selected language is applied as the system language.

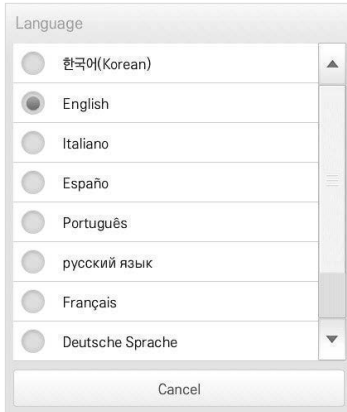

Time setting

You can configure the time used for the system as follows.

1. In the main menu, touch the **[Environment]** menu icon.
2. In the Settings list, touch **General Setting**.
3. In the detailed settings list, touch **Time setting**.
4. Apply the current time and touch the **[Apply]** button.
 - Touch **[+]/[-]** button to select the time.
 - Touch the **[AM]/[PM]** button to select before or after midday.

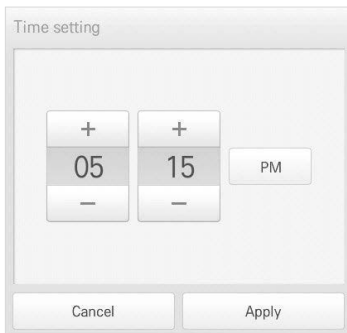

Date setting

You can configure the date used for the system as follows.

1. In the main menu, touch the **[Environment]** menu icon.
2. In the Settings list, touch **General Setting**.
3. In the detailed settings list, touch **Date setting**.
4. Modify the pattern configuration information and touch the **[Apply]** button.
 - Use **[+]/[-]** button to select a date.

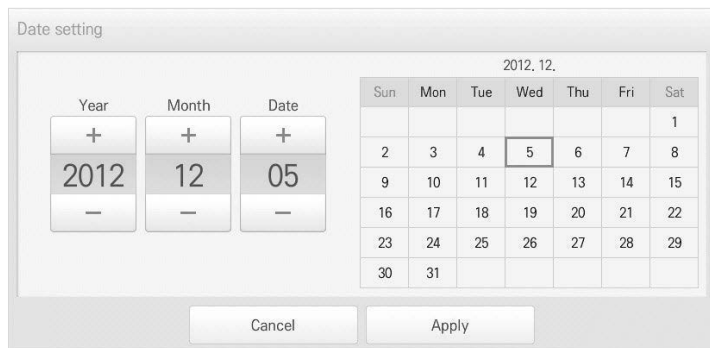

Temperature display

You can select a temperature system as follows.

1. In the main menu, touch the **[Environment]** menu icon.
2. In the Settings list, touch **General Setting**.
3. In the detailed settings list, touch **Temperature display**.
4. Touch the temperature system you want.
 - When selecting the Celsius system, in the **Minimum Celsius(°C) Temperature** window, touch the minimum temperature.

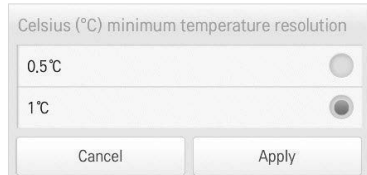

Initial date for statistics

Statistics Reference Date is the date for calculating the indoor unit's operation time by month. The operation time from this date through the previous date to the same date of the next month is calculated and provided as statistical data. You can configure Statistics Reference Date as follows.

1. In the main menu, touch the **[Environment]** menu icon.
2. In the Settings list, touch **General Setting**.
3. In the detailed settings list, touch **Initial date for statistics**.
4. **[+]/[-]** button to select a date you want and **[Apply]** button.

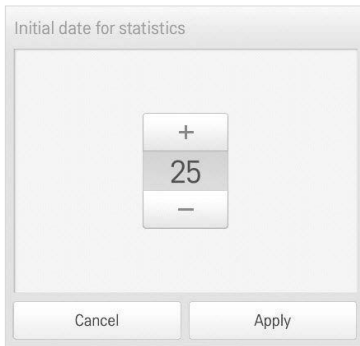

Rates per 1kWh

You can configure the charge per kWh and the currency as follows.

1. In the main menu, touch the **[Environment]** menu icon.
2. In the Settings list, touch **General Setting**.
3. In the detailed settings list, touch **Rates set**.
4. Configure the charge/kWh configuration information and touch **[Apply]** button.
 - **rates per(1kWh)**: Charge per 1kWh.
 - **Currency**: Click **[▼]** button to select the desired currency.

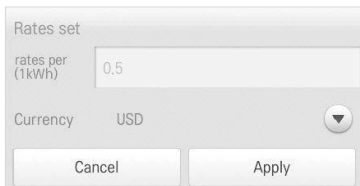

Holiday setting(The day schedule is not work)

The following explains how to register an exception date or how to delete a registered date.

Adding Exception Date

You can add a desired exception date as follows.

1. In the main menu, touch the **[Environment]** menu icon.
2. In the Settings list, touch **General Setting**.
3. In the detailed settings list, touch **Holiday setting(Days in which the schedule is ignored)**.
 - The Exception Date Configuration window opens.

4. Type a name for the exception date in the exception date input box.
5. **[+]/[-]** button to select an exception date.
6. To add the selected exception date, click **[Add]**.
 - The exception date is registered on the exception date list.
7. To complete Exception Date Configuration, touch the **[Apply]** button.

Deleting Exception Date

You can delete a registered exception date as follows.

1. In the main menu, touch the **[Environment]** menu icon.
2. In the Settings list, touch **General Setting**.
3. In the detailed settings list, touch **Holiday setting(Days in which the schedule is ignored)**.
 - The Exception Date Configuration window opens.

4. Touch an exception date in the exception date list, and touch the **[Delete]** button.
5. To complete Exception Date Configuration, touch the **[Apply]** button.

Version Information

You can check the current version of the software as follows.

1. In the main menu, touch the **[Environment]** menu icon.
2. In the Settings list, touch **General Setting**.
3. In the detailed settings list, touch **Version Information**.
 - The current version of the system is displayed in a popup window.

Screen Setting

The following explains how to configure the use environment regarding the product screen.

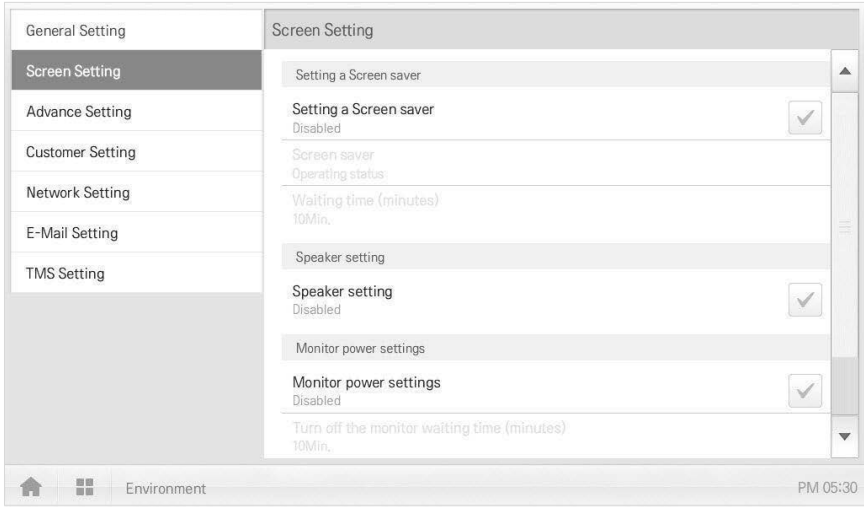

Item	Description
Setting a Screen saver	Determines whether to use a screen saver
Screen saver	Configures information to be displayed on the screen saver (operation status)
Waiting time (minutes)	Select the standby time that the screen saver waits before operation.
Speaker setting	Determines whether to use a speaker
Monitor power settings	Determines whether to use monitor power-off function
Turn off the monitor waiting time(minutes)	Selects the standby time that the monitor waits before turn-off
Calibrating the Screen	Screen calibration for accurate touch

Setting a Screen saver

You can configure the screen saver as follows.

1. In the main menu, touch the **[Environment]** menu icon.
2. In the Settings list, touch **Screen Setting**.
3. In the detailed settings list, touch **Setting a Screen saver**.
 - **Enable**, the check box turns red and the **Screen Saver** and **Waiting time (minutes)** are enabled.

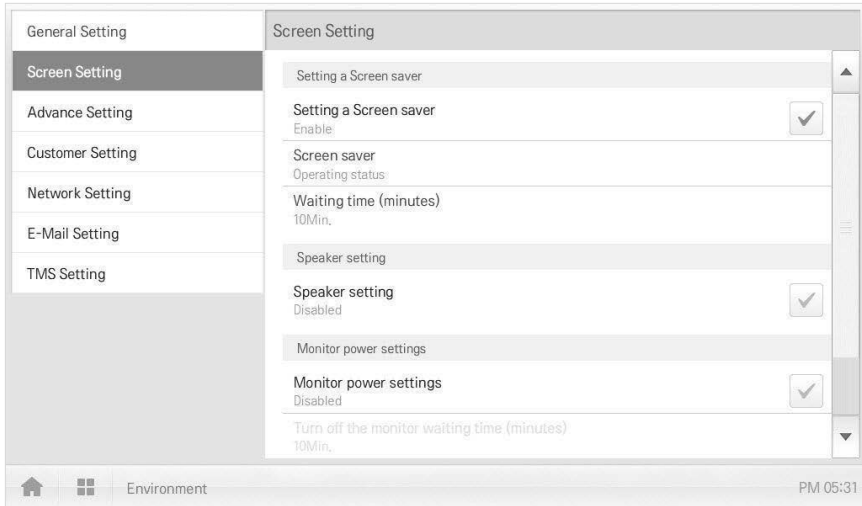

Waiting time (minutes)

You can configure the standby time that the screen saver waits before operation.

1. In the main menu, touch the **[Environment]** menu icon.
2. In the Settings list, touch **Screen Setting**.
3. In the detailed settings list, touch the **Waiting time (minutes)**.
4. In the Standby Time Configuration window, touch the standby time.

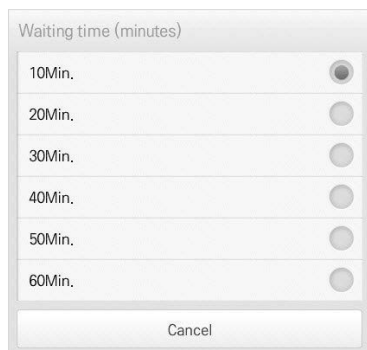

Speaker setting

You can configure the speaker setting as follows.

1. In the main menu, touch the **[Environment]** menu icon.
2. In the setting list, touch **Screen Setting**.
3. In the detailed settings list, touch **Speaker setting**.
 - **Enable**, the check box turns red and the Speaker is enabled.

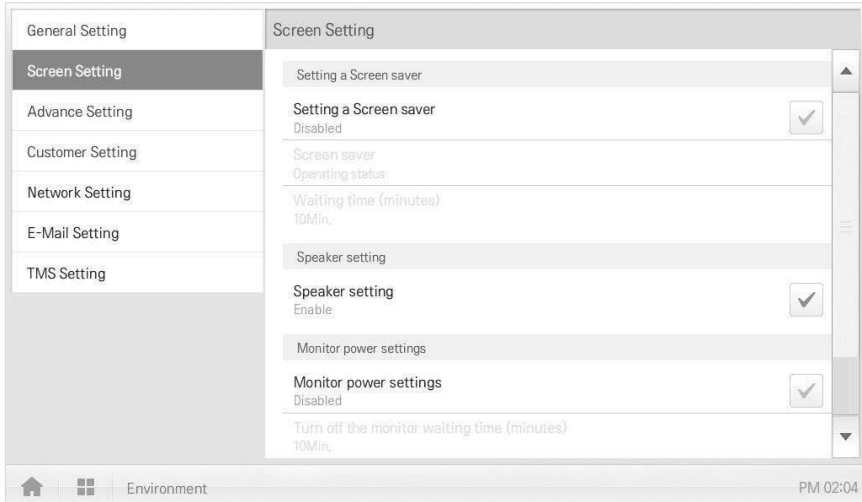

Monitor power settings

You can configure the monitor to turn off automatically, if the touch screen is not used for a certain period of time. You can configure this function as follows.

1. In the main menu, touch the **[Environment]** menu icon.
2. In the Settings list, touch **Screen Setting**.
3. In the detailed settings list, touch **Monitor power settings**.
 - **Enable**, the check box turns red and **Turn off the monitor waiting time (minutes)** is enabled.

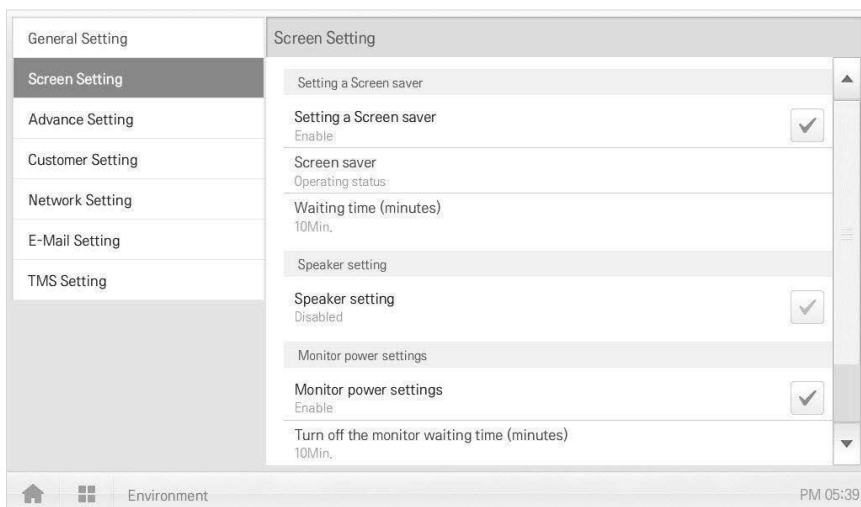

Turn off the monitor waiting time (minutes)

You can configure the monitor to turn off automatically, if the touch screen is not used for a certain period of time, as follows.

1. In the main menu, touch the **[Environment]** menu icon.
2. In the Settings list, touch **Screen Setting**.
3. In the detailed settings list, touch **Turn off the monitor waiting time (minutes)**.
4. Touch the standby time you desire.

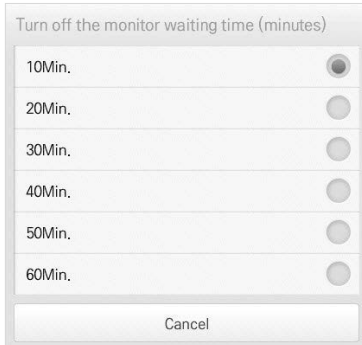

Calibrating the Screen

You can calibrate the screen for accurate touch response as follows.

1. In the main menu, touch the **[Environment]** menu icon.
2. In the Settings list, touch **Screen Setting**.
3. In the detailed settings list, touch **Calibrating the Screen**.
4. To start the screen calibration, touch the **[Start screen calibration]** button.

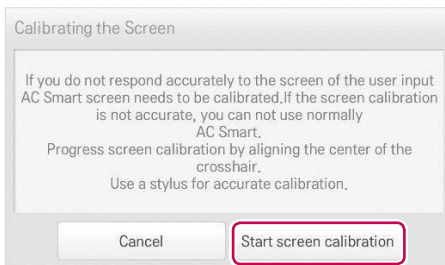

5. When the crosses appear on the screen, touch the center of each to calibrate.

Advance Setting

The following explains how to configure the functions necessary for device operation.

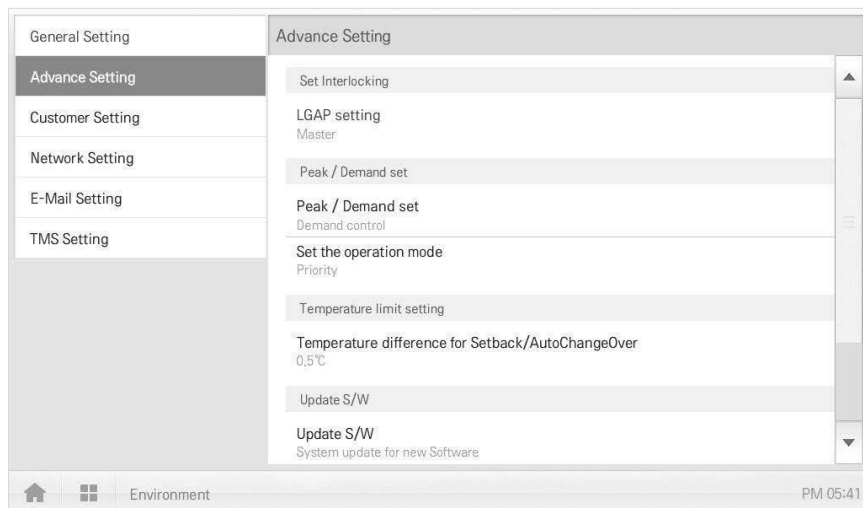

Item	Description
LGAP setting	<ul style="list-style-type: none"> • Master: AC Smart Premium is used independently. • Slave: It shares the communication line with other central controller products. <p>(If multiple AC Smart Premiums are used, one should be selected as Master and the others as Slave. In slave mode, some functions of Auto Search in the Installing menu are not available.)</p>
Peak/Demand set	<ul style="list-style-type: none"> • Peak Control: You can use the peak control feature in the auto logic menu. • Demand Control: You can use the demand control feature in the auto logic menu.
Set the operation mode	<ul style="list-style-type: none"> • Priority Control: In Peak/Demand Control menu, control the devices based on the priority of the group. • Outdoor Unit Capacity Control: In the Peak/Demand Control menu, control the outdoor capacity rate per unit.
Temperature difference for Setback/AutoChangeOver	[+]/[-] button to select the temperature gap.
Update S/W	<ul style="list-style-type: none"> • Software upgrade using a USB memory stick. • Complete upgrade and restart the system.
DB backup	Backup the DB onto a USB memory stick.
Recovery DB	Use the DB stored on the USB memory stick to restore the system.

LGAP setting

AC Smart Premium can interface with another central controller to control a device. You can configure the interface type with other devices as follows.

1. In the main menu, touch the **[Environment]** menu icon.
2. In the Settings list, touch **Advance Setting**.
3. In the detailed settings list, touch **LGAP setting**.
4. Touch a type you want.
 - **Master**: AC Smart Premium is used independently.
 - **Slave**: It shares the communication line with other central controller products.

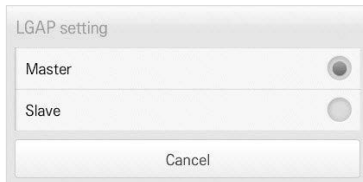

Notes

If multiple AC Smart Premiums are used, one should be selected as Master and the others as Slave.

Peak/Demand set

You can select a control type to be used for auto logic.

1. In the main menu, touch the **[Environment]** menu icon.
2. In the Settings list, touch **Advance Setting**.
3. In the detailed settings list, touch **Peak/Demand set**.
4. Touch a control type to be used for auto logic
 - **Peak Control**: You can use the peak control feature in the auto logic menu.
 - **Demand Control**: You can use the demand control feature in the auto logic menu.

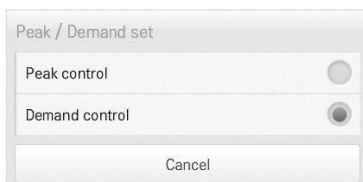

Set the operation mode

You can configure the operation type as follows.

1. In the main menu, touch the **[Environment]** menu icon.
2. In the Settings list, touch **Advance Setting**.
3. In the detailed settings list, touch **Set the operation mode**.
4. Touch an operation type you want.

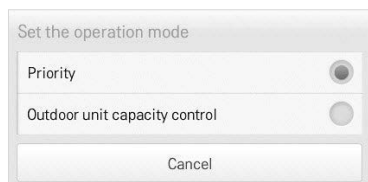

Temperature difference for Setback/AutoChangeOver

You can configure the temperature gap for auto changeover operation.

1. In the main menu, touch the **[Environment]** menu icon.
2. In the Settings list, touch **Advance Setting**.
3. In the detailed settings list, touch **Temperature difference for Setback/AutoChangeOver**.
4. **[+]/[-]** button to select a temperature gap you want and **[Apply]** button.

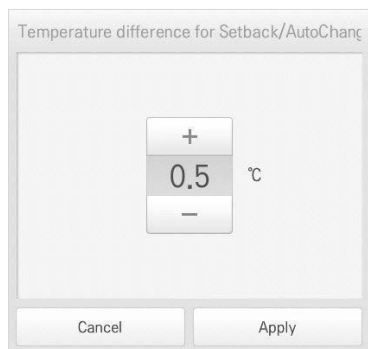

Update S/W

You can upgrade the current version of software as follows.



Notes

- To update the software, you need a USB memory stick which has patch.tar file in the ramdisk folder.
- For standard thumb drives, a USB to mini USB cable is required.

1. Connect the USB memory to AC Smart Premium.
2. In the main menu, touch the **[Environment]** menu icon.
3. In the Settings list, touch **Advance Setting**.
4. In the detailed settings list, touch **Update S/W**.
5. When the software update window appears, touch the **[Update S/W]** button.
 - When the update has been completed, the program restarts.



DB backup

You can backup the database stored in the system to USB memory as follows.

1. Connect the USB memory to AC Smart Premium.
2. In the main menu, touch the **[Environment]** menu icon.
3. In the Settings list, touch **Advance Setting**.
4. In the detailed settings list, touch **DB backup**.
5. When the DB Backup window appears, touch the **[DB backup]** button.

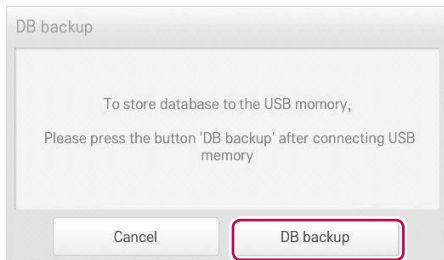
**Recovery DB**

You can use the database stored on USB memory to restore the system database.

1. Connect the USB memory stick to AC Smart Premium.
2. In the main menu, touch the **[Environment]** menu icon.
3. In the Settings list, touch **Advance Setting**.
4. In the detailed settings list, touch **Recovery DB**.
5. When the DB Recovery window appears, touch the **[Recovery DB]** button.
 - When the DB recovery has been completed, the program restarts.



Customer Setting

Only the administrator account can change user environments.

Item	Description
Change Password	Only the administrator account can change the password.
Add user	Add up to 30 new system users.
User Management	<ul style="list-style-type: none"> • [Delete] Button: Deletes a user. • [Edit] Button: Changes user information.

Change Password

The system_admin account password can be changed as follows.

1. In the main menu, touch the **[Environment]** menu icon.
2. In the Settings list, touch **Customer Setting**.
3. In the detailed settings list, touch **Change Password**.
4. After entering the current and new passwords, click **[Confirm]**.
 - **Current P/W**: Enter the current password.
 - **New P/W**: Enter the new password for system_admin..
 - **Re-type P/W**: Enter the new password to confirm that the new password has been entered correctly.

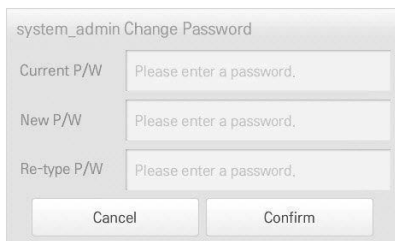

The screenshot shows a dialog box titled "system_admin Change Password". It contains three input fields, each with the placeholder text "Please enter a password." The fields are labeled "Current P/W", "New P/W", and "Re-type P/W". At the bottom of the dialog, there are two buttons: "Cancel" and "Confirm".

Add user

You can add a user as follows.

1. In the main menu, touch the **[Environment]** menu icon.
2. In the Settings list, touch **Customer Setting**.
3. In the detailed settings list, touch **Add User**.
4. When the system password input window appears, enter the password and click **[Confirm]**.

The screenshot shows a dialog box titled "Add user". Below the title, it says "To add a user, the system password is required. Enter the system password." There is a text input field with the placeholder text "Please enter a password." Below the input field are two buttons: "Cancel" and "Confirm".

5. When the Add a New User window appears, enter the user information and click **[Confirm]**.
 - **ID**: Enter the user's ID for the email server.
 - **Password**: Enter the login password.
 - **Password 'Confirm'**: Re-enter the password.
 - **User Role**: Select the user permission you want
 - **Accessible Group**: Select a controllable device group

The screenshot shows a dialog box titled "Add user" with several input fields and a list. On the left side, there are four input fields: "ID" (placeholder: "Enter the ID"), "Password" (placeholder: "Please enter a password."), "Password 'Confirm'" (placeholder: "Please enter a password."), and "User Role" (with radio buttons for "User" and "Administrator"). On the right side, there is a list titled "Accessible Group" with a scroll bar. The list contains the following items, each with a checked checkbox: "Group (7)", "AC UNIT", "VENT", "VENT_2", "DXHRV", "AHU", and "AC UNIT_2". At the bottom of the dialog box are two buttons: "Cancel" and "Confirm".



Notes

Use is limited depending on the user.

- General user menu: Control/Monitor, Schedule, Statistics for assigned Groups/Units
- Administrator menu: Control/Monitor, Schedule, AutoLogic, Statistics, Report, Installing for all Groups/Units

User Management

The following explains how to delete a registered user or edit user information.

Deleting User Information

You can delete a registered user's information as follows.

1. In the main menu, touch the **[Environment]** menu icon.
2. In the Settings list, touch **Customer Setting**.
3. In the user list, touch the **[Delete]** button for the user information you want to delete.

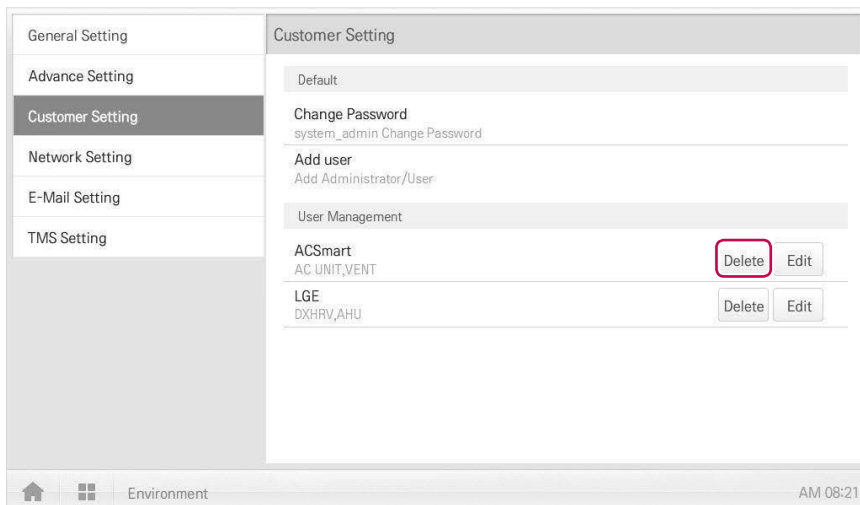

4. When the system password input window appears, enter the password and click **[Confirm]**.
 - The user information is deleted.

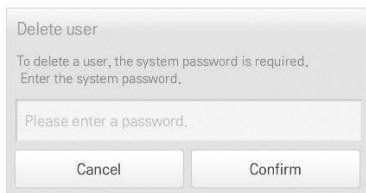

5. To complete user delete, click **[Confirm]**.

Editing User Information

You can edit a registered user's information as follows.

1. In the main menu, touch the **[Environment]** menu icon.
2. In the Settings list, touch **Customer Setting**.
3. In the user list, touch the **[Edit]** button for the user information you want to edit.

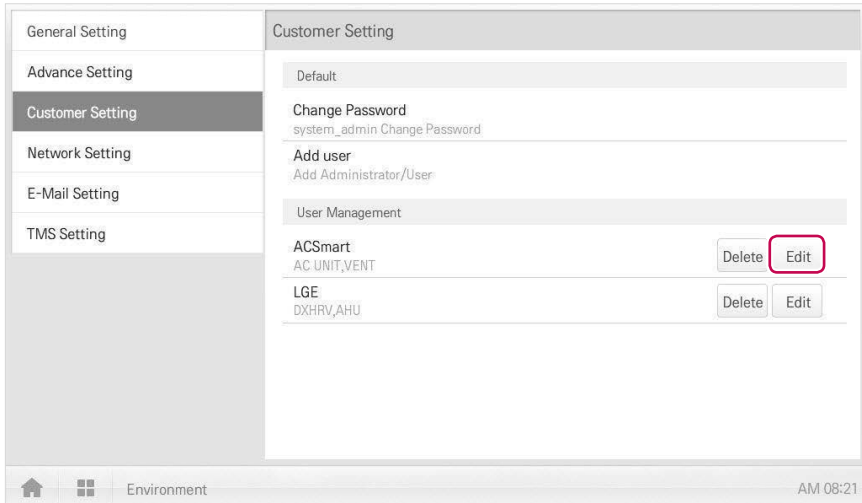

4. When the system password input window appears, enter the password, click **[Confirm]**.

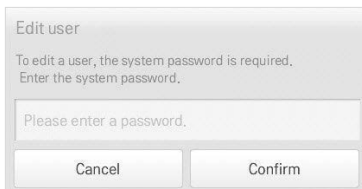

5. When the Edit User window appears, enter the user information and click **[Confirm]**.
 - The updated user information is applied.

Dialog box titled "Edit user (ACSmart)".

Fields and options:



- ID: ACSmart
- Password: Please enter a password. (Modify button)
- User Role: User, Administrator
- Accessible Group: Group (7), AC UNIT, VENT, VENT_2, DXHRV, AHU, AC UNIT_2

Buttons: Cancel, Confirm

6. To complete user edit, click **[Confirm]**.

Network Setting

The following explains how to configure the network environment.

General Setting	Network Setting
Advance Setting	IP address settings
Customer Setting	IP address settings Using Static IP address
Network Setting	IP information
E-Mail Setting	IP address 000,000,000,000
TMS Setting	Subnet mask 000,000,000,000
	Gateway 000,000,000,00
	DNS server
	Main DNS 000,000,00,0
	Sub DNS 000,000,00,0
  Environment AM 08:32	

Item	Description
IP address settings	Select IP address allocation type. <ul style="list-style-type: none"> • Get the IP address using DHCP: IP address is allocated by the network automatically. • Using Static IP address: Get IP address from the network administrator and type it manually.
IP address	Enter IP address
Subnet mask	Enter the subnet mask information for the IP address.
Gateway	Enter IP address of gateway.
Main DNS	Enter the IP address of main DNS server.
Sub DNS	Enter the IP address of secondary DNS server.

IP address settings

You can select the IP address allocation as follows.

1. In the main menu, touch the **[Environment]** menu icon.
2. In the Settings list, touch **Network Setting**.
3. In the detailed settings list, touch **IP address settings**.
4. Touch an IP address allocation type you want.
 - **Get the IP address using DHCP:** IP address is allocated by the network automatically
 - **Using Static IP address:** Get IP address from the network administrator and enter it manually

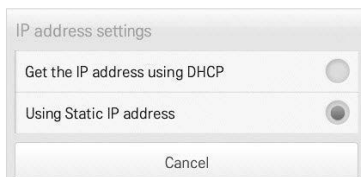

The screenshot shows a dialog box titled "IP address settings". It contains two radio button options: "Get the IP address using DHCP" (which is selected) and "Using Static IP address". At the bottom of the dialog is a "Cancel" button.

IP address

You can enter the IP address as follows.

1. In the main menu, touch the **[Environment]** menu icon.
2. In the Settings list, touch **Network Setting**.
3. In the detailed settings list, touch **IP address**.
4. When the IP information window appears, touch the **[Apply]** button.

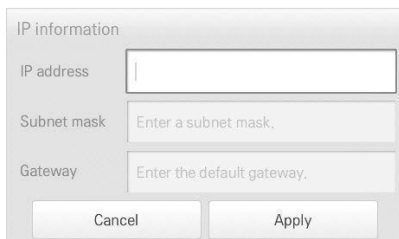

The screenshot shows a dialog box titled "IP information". It has three input fields: "IP address" (with a cursor), "Subnet mask" (with the placeholder text "Enter a subnet mask."), and "Gateway" (with the placeholder text "Enter the default gateway."). At the bottom are "Cancel" and "Apply" buttons.

Subnet mask

You can enter the subnet mask information for an IP address as follows.

1. In the main menu, touch the **[Environment]** menu icon.
2. In the Settings list, touch **Network Setting**.
3. In the detailed settings list, touch **Subnet mask**.
4. When the IP Information window appears, enter the subnet mask information, click **[Apply]**.



The screenshot shows a dialog box titled "IP information". It contains three input fields: "IP address" with the placeholder text "Enter the IP address.", "Subnet mask" which is currently empty, and "Gateway" with the placeholder text "Enter the default gateway.". At the bottom of the dialog are two buttons: "Cancel" and "Apply".

Gateway

You can enter the IP address of a gateway as follows.

1. In the main menu, touch the **[Environment]** menu icon.
2. In the Settings list, touch **Network Setting**.
3. In the detailed settings list, touch **Gateway**.
4. When the IP Information window appears, enter the IP address of the gateway and click **[Apply]**.

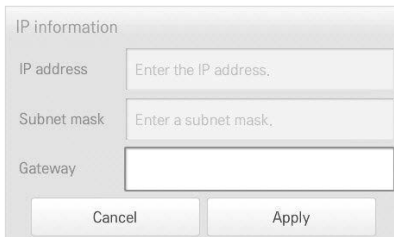

The screenshot shows a dialog box titled "IP information". It contains three input fields: "IP address" with the placeholder text "Enter the IP address.", "Subnet mask" with the placeholder text "Enter a subnet mask.", and "Gateway" which is currently empty. At the bottom of the dialog are two buttons: "Cancel" and "Apply".

Main DNS

You can enter the IP address of a main DNS server as follows.

1. In the main menu, touch the **[Environment]** menu icon.
2. In the Settings list, touch **Network Setting**.
3. In the detailed settings list, touch **Main DNS**.
4. When the DNS Server window appears, enter the IP address of the main DNS server and click **[Confirm]**.

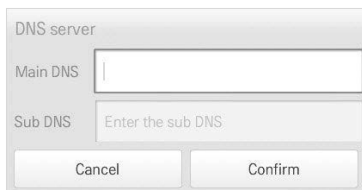

The screenshot shows a dialog box titled "DNS server". It contains two input fields: "Main DNS" and "Sub DNS". The "Main DNS" field is currently empty and has a cursor. The "Sub DNS" field contains the placeholder text "Enter the sub DNS". At the bottom of the dialog, there are two buttons: "Cancel" and "Confirm".

Sub DNS

You can enter the IP address of a secondary DNS server as follows.



1. In the main menu, touch the **[Environment]** menu icon.
2. In the Settings list, touch **Network Setting**.
3. In the detailed settings list, touch **Sub DNS**.
4. When the DNS Server window appears, enter the IP address of the secondary DNS server and click **[Confirm]**.



The screenshot shows a dialog box titled "DNS server". It contains two input fields: "Main DNS" and "Sub DNS". The "Main DNS" field contains the placeholder text "Enter the main DNS". The "Sub DNS" field is currently empty and has a cursor. At the bottom of the dialog, there are two buttons: "Cancel" and "Confirm".

E-Mail Setting

When the administrator is not present, AC Smart Premium emails any error information to the administrator for reviewing. The following explains how to configure the email.

General Setting	E-Mail Setting
Advance Setting	Account Management
Customer Setting	E-mail account settings User's e-mail account settings
Network Setting	E-mail settings
E-Mail Setting	E-mail settings <input checked="" type="checkbox"/>
TMS Setting	Enable
	Mailing configuration
	Email Subject Email_from_ACSMART
	Receiving e-mail abc@gmail.com
	The transmission cycle during error occurs (minutes) 10Min.
	Automatic daily error-notification mail <input checked="" type="checkbox"/>
	Disabled
  Environment AM 08:42	

Item	Description
E-mail account settings	Configuring user email account.
E-mail settings	Select whether to use the email.
Email Subject	Type an email subject line when sending an email.
Receiving e-mail	Register the email address of the receiver who will receive the email.
The transmission cycle during error occurs (minutes)	Set the transmission cycle to send an email if an error occurs.
Automatic daily error-notification mail	Configure an email to be sent at 00:00 every day, even if there are no errors to report.

E-mail account settings

You can configure the user's email account.

1. In the main menu, touch the **[Environment]** menu icon.
2. In the Settings list, touch **E-Mail Setting**.
3. In the detailed settings list, touch **E-mail account settings**.
4. Type the email account information.
 - **User name**: Enter the email user's name.
 - **Address e-mail**: Enter the user's e-mail address.
 - **Outgoing mail server(SMTP)**: Enter the address of the mail server.
 - **Outgoing mail server port**: Enter the port of the mail server.
 - **Server Access Account**: Enter the server connection account.
 - **Password**: Enter the password to log onto the mail server.

User Information	Server Information	Login Account
User name <input type="text"/>	Outgoing mail server(SMTP) <input type="text" value="Enter the server address."/>	Server Access Account <input type="text" value="Enter the server access account."/>
Address e-mail <input type="text" value="Enter the e-mail address."/>	Outgoing mail server port <input type="text" value="Enter the server port."/>	Password <input type="text" value="Please enter a password."/>
<input type="button" value="Test account setting"/>	<input type="button" value="Cancel"/>	<input type="button" value="Confirm"/>

5. Touch **[Test account setting]** to check if the configured account is correct.
6. When the Account Configuration Completion window appears, touch **[Confirm]**.
7. To complete the email account configuration, touch the **[Confirm]** button.

E-mail settings

You can select whether to use the email function as follows.

1. In the main menu, touch the **[Environment]** menu icon.
2. In the Settings list, touch **E-Mail Setting**.
3. In the detailed settings list, touch **E-mail settings**.
 - If **Enable** is selected, the check box turns red and the **Email Subject**, **Receiving e-mail**, **The transmission cycle during error occurs (minutes)**, and **Automatic daily errornotification mail** are enabled.

General Setting	E-Mail Setting
Advance Setting	Account Management
Customer Setting	E-mail account settings User's e-mail account settings
Network Setting	E-mail settings
E-Mail Setting	E-mail settings <input checked="" type="checkbox"/>
TMS Setting	Enable
	Mailing configuration
	Email Subject Email_from_ACSMART
	Receiving e-mail abc@gmail.com
	The transmission cycle during error occurs (minutes) 10Min.
	Automatic daily error-notification mail <input checked="" type="checkbox"/>
	Disabled

Environment AM 08:42

Email Subject

You can type an email subject line as follows.

1. In the main menu, touch the **[Environment]** menu icon.
2. In the Settings list, touch **E-Mail Setting**.
3. In the detailed settings list, touch **Email Subject**.
4. When the Configuring Email window appears, enter the email title and click **[Confirm]**.

Set mailing

Email Subject

Receiving e-mail Enter the e-mail address. Enter the e-mail address. Enter the e-mail address.

Cancel Confirm

Receiving e-mail

You can register the email address of up to three email receivers as follows.

1. In the main menu, touch the **[Environment]** menu icon.
2. In the Settings list, touch **E-Mail Setting**.
3. In the detailed settings list, touch **Receiving e-mail**.
4. When the Configuring Email window appears, enter the email address of the email receiver and click **[Confirm]**.

The screenshot shows a 'Set mailing' dialog box. It has a title bar 'Set mailing'. Below it is an 'Email Subject' label followed by a text input field containing the placeholder 'Enter email subject'. Underneath is a 'Receiving e-mail' label followed by three text input fields, each containing the placeholder 'Enter the e-mail address.'. At the bottom of the dialog are two buttons: 'Cancel' and 'Confirm'.

The transmission cycle during error occurs (minutes)

You can set the schedule for when to send an email (when an error occurs) from 10 minutes to within one hour as follows.

1. In the main menu, touch the **[Environment]** menu icon.
2. In the Settings list, touch **E-Mail Setting**.
3. In the detailed settings list, touch **The transmission cycle during error occurs (minutes)**.
4. When the Select an Email Schedule window appears, touch a sending schedule you want.

The screenshot shows a selection window titled 'The transmission cycle during error occurs (minutes)'. It lists six options: '10Min.', '20Min.', '30Min.', '40Min.', '50Min.', and '60Min.'. Each option has a radio button to its right. The radio button for '10Min.' is selected. At the bottom of the window is a 'Cancel' button.

Automatic daily error-notification mail

You can configure an email to be sent automatically once per day, even if there are no error, as follows.

1. In the main menu, touch the **[Environment]** menu icon.
2. In the Settings list, touch **E-Mail Setting**.
3. In the detailed settings list, touch **Automatic daily error-notification mail**.
 - **Enable** is selected, the check box turns red.

General Setting	E-Mail Setting
Advance Setting	Account Management
Customer Setting	E-mail account settings User's e-mail account settings
Network Setting	E-mail settings
E-Mail Setting	E-mail settings <input checked="" type="checkbox"/>
TMS Setting	Mailing configuration
	Email Subject Email_from_ACSMART
	Receiving e-mail abc@gmail.com
	The transmission cycle during error occurs (minutes) 10Min.
	Automatic daily error-notification mail <input checked="" type="checkbox"/>
	Enable

Environment AM 08:47

TMS Setting

The following explains how to configure the remote monitoring and control system.

Item	Description
TMS configuration	Select whether to use a remote control service.
TMS server address	Configure the remote control service server address.
TMS server port	Configure the remote control service port.
Update Cycle (seconds)	Configures the remote control service update cycle (in seconds).
Site address	Enter an address for the remote site.
Site name	Enter the site name.
Site code	Touch the [Request Site Code] button to enter the site code.
Admin Name	Enter the name of the site manager.
Admin Contact	Enter the site manager's phone number.

TMS configuration

You can select whether to use the remote control service as follows.

1. In the main menu, touch the **[Environment]** menu icon.
2. In the Settings list, touch **TMS Setting**.
3. In the detailed settings list, touch **TMS configuration**.
 - If Enable is selected, the check box turns red and **TMS server address**, **TMS server port**, **Update Cycle (seconds)**, **Site address**, **Site name**, **Site code**, **Admin Name**, and **Admin Contact** are enabled.

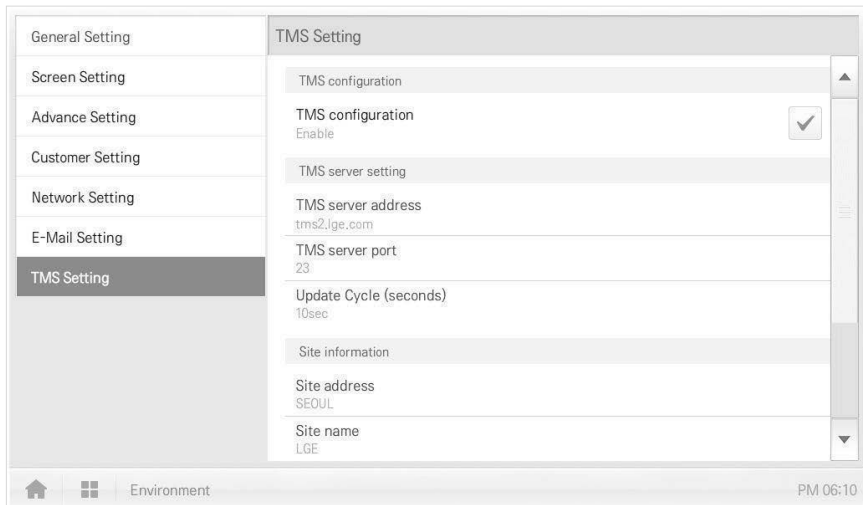

TMS server address

You can configure the server address of the remote control service as follows.

1. In the main menu, touch the **[Environment]** menu icon.
2. In the Settings list, touch **TMS Setting**.
3. In the detailed settings list, touch **TMS server address**.
4. When the Remote Service Information window appears, enter the service server address and click **[Confirm]**.

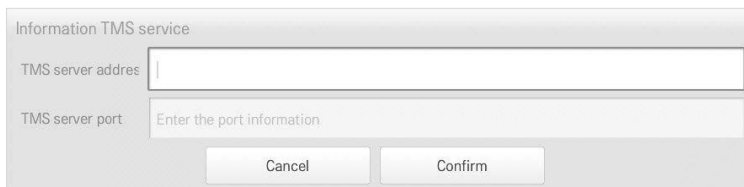

Information TMS service

TMS server address

TMS server port

Cancel Confirm

TMS server port

You can configure the server port of the remote control service as follows.

1. In the main menu, touch the **[Environment]** menu icon.
2. In the Settings list, touch **TMS Setting**.
3. In the detailed settings list, touch **TMS Server Port**.
4. When the Remote Service Information window appears, enter the service server port and click **[Confirm]**.

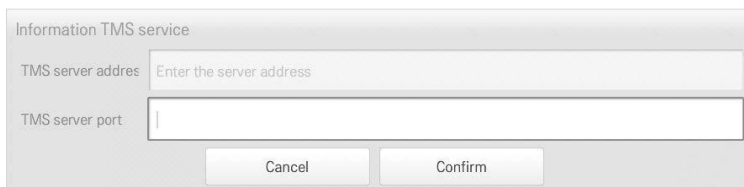

Information TMS service

TMS server address

TMS server port

Cancel Confirm

Update Cycle (seconds)

You can configure the update cycle of the remote control service information as follows.

1. In the main menu, touch the **[Environment]** menu icon.
2. In the Settings list, touch **TMS Setting**.
3. In the detailed settings list, touch **Update Cycle (seconds)**.
4. When the Configuring Update Cycle window appears, touch an update cycle you want.

Update Cycle (seconds)

10sec

30sec

60sec

90sec

120sec

Cancel

Site address

You can type the address of the site where AC Smart Premium is installed.

1. In the main menu, touch the **[Environment]** menu icon.
2. In the Settings list, touch **TMS Setting**.
3. In the detailed settings list, touch **Site address**.
4. When the Configuring Site Information window appears, enter the site address and click **[Confirm]**.

Site information

Site address

Site name

Site code

Request a site code

Cancel Confirm

Site name

You can type the name of the site where AC Smart Premium is installed.

1. In the main menu, touch the **[Environment]** menu icon.
2. In the Settings list, touch **TMS Setting**.
3. In the detailed settings list, touch **Site name**.
4. When the Configuring Site Information window appears, enter the site name and click **[Confirm]**.

Site code

You can allocate a code for site management as follows.

1. In the main menu, touch the **[Environment]** menu icon.
2. In the Settings list, touch **TMS Setting**.
3. In the detailed settings list, touch **Site code**.
4. When the Configuring Site Information window appears, touch the **[Request a site code]** button to enter the site code and touch **[Confirm]**.



Notes

You must enter the site address details before you can request the site code.

Admin Name

You can type the site manager's name as follows.

1. In the main menu, touch the **[Environment]** menu icon.
2. In the Settings list, touch **TMS Setting**.
3. In the detailed settings list, touch **Admin Name**.
4. When the Configuring Site Manager Information window appears, enter the site manager's name and click **[Confirm]**.

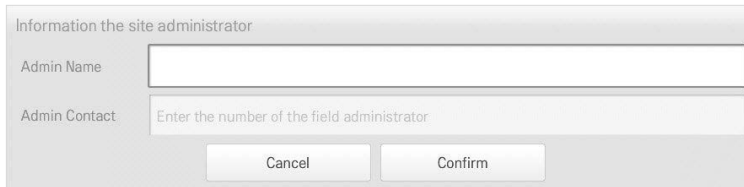

Information the site administrator

Admin Name

Admin Contact

Cancel Confirm

Admin Contact

You can type the site manager's phone number as follows.

1. In the main menu, touch the **[Environment]** menu icon.
2. In the Settings list, touch **TMS Setting**.
3. In the detailed settings list, touch **Admin Contact**.
4. When the Configuring Site Manager Information window appears, enter the site manager's phone number and click **[Confirm]**.

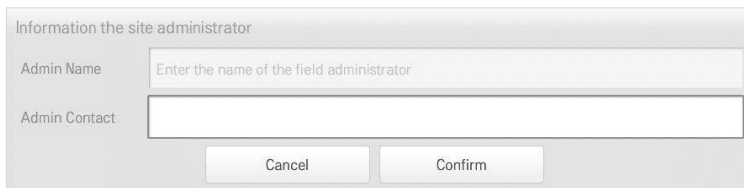

Information the site administrator

Admin Name

Admin Contact

Cancel Confirm

 MEMO

ENGLISH

Hint

Control Codes

AC Smart Premium may display the following control codes during usage

Control Code	Description
S	Displayed when the device status has changed due to the control
M	Displayed when the system settings have changed
E	Displayed when there is an error

Error Codes

The followings are the error codes that occur while using AC Smart Premium.

Indoor Device, ERV or ERV DX, AWHP(Hydro kit), AHU error

Error Code	Indoor Device	ERV or ERV DX	AWHP(Hydro kit)	AHU
0	No error	No error	No error	
1	Indoor sensor air) open/short	Air intake sensor malfunction	Indoor air thermometer malfunction	
2	Indoor sensor (intake pipe) open/short	Refrigerant intake thermometer malfunction	Refrigerant intake thermometer malfunction	Communication PCB indoor sensor (intake pipe) error
3	Remote control malfunction	Remote control malfunction	Remote control malfunction	The remote control is not functioning for 3 minutes or longer.
4	Drain pump malfunction	Drain pump malfunction		Communication PCB is not functioning for 3 minutes or longer.
5	Communication error (indoor ↔ outdoor)	Communication error (indoor ↔ outdoor)	Communication error (indoor ↔ outdoor)	Communication error (communication PCB ↔ outdoor)
6	Indoor sensor (outtake pipe) open/short	Refrigerant outtake thermometer malfunction	Refrigerant outtake thermometer malfunction	Communication PCB indoor sensor (outtake pipe) error

Error Code	Indoor Device	ERV or ERV DX	AWHP(Hydro kit)	AHU
7	Atypical operation	Atypical operation	Atypical operation	
8			Hot water thermometer malfunction	Operate smoke control through smoke detection.
9	EEPROM ERROR (indoor unit)	EEPROM ERROR (indoor unit)	EEPROM ERROR (indoor unit)	
10	Indoor fan LOCK (operation error)	Indoor fan Lock (operation error)		
11			HHU/boiler communication error (HHU)	
12	Indoor mid-pipe sensor error		Boiler error (HHU)	
13	Heater terminal block sensor (A-PAC)		Solar heat temperature sensor error	Temperature (ERV, air supply, external air, Mix) is outside acceptable range.
14			Indoor unit flow switch operation error	Humidity (ERV, air supply, external air) is outside acceptable range
15	O-ROTOR (BLDC FAN driver) communication error		Water pipe overheating	CO ₂ value is within acceptable range
16			Simultaneous AWHP temperature sensor error	Pressure (pressure change, static pressure) is outside acceptable range
17		ERV DX air out sensor	Inlet water temperature sensor error	Speed (ERV and air supply flow) is outside acceptable range.
18		ERV DX air return sensor	Outlet water temperature sensor error	
19		ERV DX Main PCB ← Sub PCB communication error	Elec/Heater outlet water temperature sensor error	

Error Code	Indoor Device	ERV or ERV DX	AWHP(Hydro kit)	AHU
20		ERV DX Main PCB → Sub PCB communication error	Elec/heater error	

Outdoor Unit Errors

Error Code	Description
21	DC peak
22	Max ct (CT 2): Maximum current error
23	DC link voltage (low)
24	High voltage/heat plate SW
25	Under-voltage/over-voltage
26	DC comp position error
27	PSC fault error
28	DC link voltage (high)
29	Comp over-current
30	Surge in static speed #2 compressor discharge temperature
31	CT err (low current)
32	Inverter discharge temperature error (high)
33	Surge in static speed #1 compressor discharge temperature
34	Surge in high voltage
35	Drop in low voltage
36	Low compression ratio error
37	Compression ratio limit exceeded
39	Communication error (inverter ↔ PFC)
40	Inverter CT sensor open/short
41	Inverter discharge temperature sensor open/short
42	Low voltage sensor open/short
43	Heat exchanger temperature sensor (top)
44	Outdoor air temperature sensor open/short
45	Outdoor pipe (top) sensor open/short
46	Compressor suction temperature sensor open/short
47	Static speed #1 compressor discharge temperature sensor error

Error Code	Description
48	Heat exchanger temperature sensor (bottom) (SUPER3: Static speed #2 compressor discharge temperature sensor error)
49	Outdoor voltage sensor error (SUPER3: IPM temperature sensor error)
50	Missing phase of outdoor 3-phase power
51	Over-capacity error (indoor unit capacity limit exceeded)
52	Communication error (inverter board → main board)
53	Communication error (indoor device → outdoor unit)
54	RST reverse phase detection
55	Communication error (central to main controller)
56	Communication error (main to central controller)
57	Communication error (main board to inverter board)
58	Incorrect connection of tax product (tax-exempt indoor unit to taxed outdoor unit)
59	Mixed installation of slave outdoor unit
60	PCB EEPROM error (MULTI V: inverter PCB EEPROM error)
61	Inverter discharge temperature error (high)
62	Heatsink error (high)
63	Outdoor pipe temperature error (low)
65	Heatsink Th error (open/short)
66	Bad connection/piping (incorrect connection of wire, pipe, LEV, etc.)
67	Outdoor fan lock error (with BLDC)
68	Static speed comp CT open (add MPS)
69	Static #1 CT sensor error
70	Static #2 CT sensor error
71	Input CT sensor error
72	Communication error (louver ↔ fan)
73	Input instant over-current (peak)
74	Inverter PCB phase unbalance
75	Fan CT sensor error
76	Fan DC link over-voltage error
77	Fan over-current error
78	Fan hall sensor error
79	Fan start failure error
80	Louver motor over-current
81	Louver limit SW error

Error Code	Description
82	A-cycle low pressure error
83	B-cycle low pressure error
84	A-cycle high pressure error
85	B-cycle high pressure error
86	Main PCB EEPROM error
87	Fan PCB EEPROM error
88	PFC PCB EEPROM error
89	Detachable type distributor communication error

MultiV 20Hp, 30Hp, 40Hp, error

Error Code	Description
100	SLAVE1 static speed compressor 1 discharge temperature surge error
101	SLAVE1 static speed compressor 2 discharge temperature surge error
102	SLAVE2 static speed compressor 1 discharge temperature surge error
103	SLAVE2 static speed compressor 2 discharge temperature surge error
104	Communication error with outdoor unit (slave to master)
105	Fan board communication error (fan to outdoor unit)
106	Fan board (IPM fault)
107	Fan board (low voltage error)
108	Communication error (outdoor unit to fan)
109	SLAVE1 (high voltage SW error)
110	SLAVE1 (reverse phase error)
111	SLAVE1 (communication error: master to slave)
112	Master outdoor unit sensor (oil pipe temperature sensor error)
113	Master outdoor unit sensor (fluid pipe temperature sensor error)
114	Master outdoor unit sensor (overcooling inlet temperature sensor error)
115	Master outdoor unit sensor (overcooling outlet temperature sensor error)
116	SLAVE1 outdoor unit sensor (high voltage sensor error)
117	SLAVE1 outdoor unit sensor (low voltage sensor error)
118	SLAVE1 outdoor unit sensor (low voltage sensor error)
119	SLAVE1 outdoor unit sensor (oil pipe temperature sensor error)
120	SLAVE1 outdoor unit sensor (suction temperature sensor error)

Error Code	Description
121	SLAVE1 outdoor unit sensor (static speed compressor 1 discharge temperature error)
122	SLAVE1 outdoor unit sensor (static speed compressor 2 discharge temperature error)
123	SLAVE1 outdoor unit sensor (heat exchanger temperature sensor A error)
124	SLAVE1 outdoor unit sensor (heat exchanger temperature sensor B error)
125	SLAVE1 outdoor unit (fluid pipe temperature sensor error)
126	SLAVE1 outdoor unit (overcooling inlet temperature sensor error)
127	SLAVE1 outdoor unit (overcooling outlet temperature sensor error)
128	SLAVE2 outdoor unit sensor (high voltage sensor error)
129	SLAVE2 outdoor unit sensor (low voltage sensor error)
130	SLAVE2 outdoor unit sensor (air temperature sensor error)
131	SLAVE2 outdoor unit sensor (oil pipe temperature sensor error)
132	SLAVE2 outdoor unit sensor (suction temperature sensor error)
133	SLAVE2 outdoor unit sensor (static speed compressor 1 discharge temperature error)
134	SLAVE2 outdoor unit sensor (static speed compressor 2 discharge temperature error)
135	SLAVE2 outdoor unit sensor (heat exchanger temperature sensor A error)
136	SLAVE2 outdoor unit sensor (heat exchanger temperature sensor B error)
137	SLAVE2 outdoor unit (fluid pipe temperature sensor error)
138	SLAVE2 outdoor unit (overcooling inlet temperature sensor error)
139	SLAVE2 outdoor unit (overcooling outlet temperature sensor error)
140	Fluid pipe sensor error of heat recovery unit
141	Overcooling inlet sensor error of heat recovery unit
142	Overcooling outlet sensor error of heat recovery unit
143	Heat recovery unit communication error
144	Heat recovery unit reserve 1
145	Heat recovery unit reserve 2
146	Heat recovery unit reserve 3
147	Heat recovery unit reserve 4
148	Heat recovery unit reserve 5
176	SLAVE2 static speed 1 compressor over-current/under-current
177	SLAVE2 static speed 2 compressor over-current/under-current
178	SLAVE3 static speed 1 compressor over-current/under-current
179	SLAVE3 static speed 2 compressor over-current/under-current
180	Anti-Freeze (water-cooling)
181	Water temperature sensor error (water-cooling)

Error Code	Description
182	Sub Micom communication error
183	Oil supply failure
184	Inverter oil pipe temperature sensor error
185	Static #1 oil pipe temperature sensor error
186	Static #2 oil pipe temperature sensor error
193	Fan board heat plate temperature surge
194	Fan board heat plate temperature sensor error

Super Errors

Error Code	Description
200	Fan board heat plate temperature sensor error
201	Fluid pipe sensor error (fluid pipe sensor of HR Unit1 open/short)
202	Overcooling inlet sensor error (overcooling inlet sensor of HR Unit1 open/short)
203	Overcooling outlet sensor error (overcooling outlet sensor of HR unit1 open/short)
204	Overcooling outlet sensor error (overcooling outlet sensor of HR unit1 open/short)
205	Fluid pipe sensor error (fluid pipe sensor of HR Unit2 open/short)
206	Overcooling inlet sensor error (overcooling inlet sensor of HR Unit2 open/short)
207	Overcooling outlet sensor error (overcooling outlet sensor of HR unit2 open/short)
208	Communication error (no outdoor unit signal for 3 min from HR unit2)
209	Fluid pipe sensor error (fluid pipe sensor of HR Unit3 open/short)
210	Overcooling inlet sensor error (overcooling inlet sensor of HR Unit3 open/short)
211	Overcooling outlet sensor error (overcooling outlet sensor of HR unit3 open/short)
212	Communication error (no outdoor unit signal for 3 min from HR unit3)
213	Fluid pipe sensor error (fluid pipe sensor of HR Unit4 open/short)
214	Overcooling inlet sensor error (overcooling inlet sensor of HR Unit4 open/short)
215	Overcooling outlet sensor error (overcooling outlet sensor of HR unit4 open/short)
216	Communication error (no outdoor unit signal for 3 min from HR unit4)
217	Fluid pipe sensor error (fluid pipe sensor of HR Unit5 open/short)
218	Overcooling inlet sensor error (overcooling inlet sensor of HR Unit5 open/short)
219	Overcooling outlet sensor error (overcooling outlet sensor of HR unit5 open/short)
220	Communication error (no outdoor unit signal for 3 min from HR unit5)
221	Fluid pipe sensor error (fluid pipe sensor of HR Unit6 open/short)

Error Code	Description
222	Overcooling inlet sensor error (overcooling inlet sensor of HR Unit6 open/short)
223	Overcooling outlet sensor error (overcooling outlet sensor of HR unit6 open/short)
224	Communication error (no outdoor unit signal for 3 min from HR unit6)
225	Fluid pipe sensor error (fluid pipe sensor of HR Unit7 open/short)
226	Overcooling inlet sensor error (overcooling inlet sensor of HR Unit7 open/short)
227	Overcooling outlet sensor error (overcooling outlet sensor of HR unit7 open/short)
228	Communication error (no outdoor unit signal for 3 min from HR unit7)
229	Fluid pipe sensor error (fluid pipe sensor of HR Unit8 open/short)
230	Overcooling inlet sensor error (overcooling inlet sensor of HR Unit 8 open/short)
231	Overcooling outlet sensor error (overcooling outlet sensor of HR unit8 open/short)
232	Communication error (no outdoor unit signal for 3 min from HR unit8)
233	Fluid pipe sensor error (fluid pipe sensor of HR Unit9 open/short)
234	Overcooling inlet sensor error (overcooling inlet sensor of HR Unit9 open/short)
235	Overcooling outlet sensor error (overcooling outlet sensor of HR unit9 open/short)
236	Communication error (no outdoor unit signal for 3 min from HR unit9)

Central Controller Errors

Error Code	Description
240	Communication error (PC central controller ↔ I-GW)
242	Communication error (central controller ↔ indoor unit)
246	Data in time out error from central controller
247	Communication error (ACM Client ↔ ACM Server)
248	Communication error (ACP Client ↔ ACP Server)
250	Checksum error
251	Communication error (AC Smart to 128-room expansion kit)

Pre-Tech Support Checklist

If the product malfunctions, please check the following before calling the service center.

Symptom	Check	Actions
The alarm sound does not stop.	<ul style="list-style-type: none"> Is the demand controller working normally? Is the LAN cable connected to the product? 	<ul style="list-style-type: none"> Check if the demand controller is normal. Check if the LAN cable is connected correctly to the device.
All products continue to turn off.	Is DI1 CH short-circuited?	Check if DI1 CH is open or short circuited. (DI1 CH should be always open except when a fire occurs.)
The product was reset at midnight.	The product is automatically reset every morning at 02:05 am.	
The device is not controlled.	Is the device you want to control not locked?	Check if the lock is on and if so, disable the lock.
The device icon has an error mark.	Is the device with errors connected correctly?	If devices are not correctly connected, the error sign is displayed. Check the connection status of the devices.

Guide to Open Source Software

The following GPL/LGPL execution file and libraries used for this product follows GPL/LGPL license contract.

If you request source code to LG Electronics through the following e-mail, we will send them in CDROM with the payment necessary for medium and transportation.

opensource@lge.com

This suggestion is valid for 3 years after you received this product from LG Electronics. You can receive the original GPL/LGPL license from <http://opensource.lge.com>.

Part of the software used for this product follows the following copyright.
Copyright ©1998-2002 Daniel Veillard. All Rights Reserved

 MEMO

 MEMO

 MEMO

 MEMO

 MEMO

ENGLISH

 MEMO

 MEMO

ENGLISH

