

INSTALLATION MANUAL

AIR CONDITIONER

- Please read this installation manual completely before installing the product.
- Installation work must be performed in accordance with the national wiring standards by authorized personnel only.
- Please retain this installation manual for future reference after reading it thoroughly.

TYPE : WALL MOUNTED



P/NO : MFL67450901

www.lg.com

TIPS FOR SAVING ENERGY

Here are some tips that will help you minimize the power consumption when you use the air conditioner. You can use your air conditioner more efficiently by referring to the instructions below:

- Do not cool excessively indoors. This may be harmful for your health and may consume more electricity.
- Block sunlight with blinds or curtains while you are operating the air conditioner.
- Keep doors or windows closed tightly while you are operating the air conditioner.
- Adjust the direction of the air flow vertically or horizontally to circulate indoor air.
- Speed up the fan to cool or warm indoor air quickly, in a short period of time.
- Open windows regularly for ventilation as the indoor air quality may deteriorate if the air conditioner is used for many hours.
- Clean the air filter once every 2 weeks. Dust and impurities collected in the air filter may block the air flow or weaken the cooling / dehumidifying functions.

For your records

Staple your receipt to this page in case you need it to prove the date of purchase or for warranty purposes. Write the model number and the serial number here:

Model number : _____

Serial number : _____

You can find them on a label on the side of each unit.

Dealer's name : _____

Date of purchase : _____

IMPORTANT SAFETY INSTRUCTIONS

READ ALL INSTRUCTIONS BEFORE USING THE APPLIANCE.

Always comply with the following precautions to avoid dangerous situations and ensure peak performance of your product

WARNING

It can result in serious injury or death when the directions are ignored

CAUTION

It can result in minor injury or product damage when the directions are ignored

WARNING

- Installation or repairs made by unqualified persons can result in hazards to you and others.
- Installation **MUST** conform with local building codes.
- The information contained in the manual is intended for use by a qualified service technician familiar with safety procedures and equipped with the proper tools and test instruments.
- Failure to carefully read and follow all instructions in this manual can result in equipment malfunction, property damage, personal injury and/or death.

Installation

- Don't use a power cord, a plug or a loose socket which is damaged.
 - Otherwise, it may cause a fire or electrical shock.
- For electrical work, contact the dealer, seller, a qualified electrician, or an Authorized Service Center.
 - Do not disassemble or repair the product. There is risk of fire or electric shock.
- Always ground the product.
 - There is risk of fire or electric shock.
- Install the panel and the cover of control box securely.
 - There is risk of fire or electric shock.
- Always install a dedicated circuit and breaker.
 - Improper wiring or installation may cause fire or electric shock.
- Use the correctly rated breaker or fuse.
 - There is risk of fire or electric shock.
- Do not modify or extend the power cable.
 - There is risk of fire or electric shock.
- Do not let the air conditioner run for a long time when the humidity is very high and a door or a window is left open.
 - Moisture may condense and wet or damage furniture.
- Be cautious when unpacking and installing the product.
 - Sharp edges could cause injury. Be especially careful of the case edges and the fins on the condenser and evaporator.
- For installation, always contact the dealer or an Authorized Service Center.
 - There is risk of fire, electric shock, explosion, or injury.

4 IMPORTANT SAFETY INSTRUCTIONS

- Do not install the product on a defective installation stand.
 - It may cause injury, accident, or damage to the product.
- Be sure the installation area does not deteriorate with age.
 - If the base collapses, the air conditioner could fall with it, causing property damage, product failure, and personal injury.
- There is a risk of fire and explosion.
 - Inert gas (nitrogen) should be used when you check plumbing leaks, cleaning or repairs of pipes etc.
If you are using combustible gases including oxygen, product may have the risk of fires and explosions.
- Use a vacuum pump or Inert (nitrogen) gas when doing leakage test or air purge. Do not compress air or Oxygen and do not use Flammable gases. Otherwise, it may cause fire or explosion.
 - There is the risk of death, injury, fire or explosion.

Operation

- Do not store or use flammable gas or combustibles near the product.
 - There is risk of fire or failure of product.



CAUTION

Installation

- Always check for gas (refrigerant) leakage after installation or repair of product.
 - Low refrigerant levels may cause failure of product.
- Install the drain hose to ensure that water is drained away properly.
 - A bad connection may cause water leakage.
- Keep level even when installing the product.
 - To avoid vibration or water leakage.
- Do not install the product where the noise or hot air from the outdoor unit could damage the neighborhoods.
 - It may cause a problem for your neighbors.
- Use two or more people to lift and transport the product.
 - Avoid personal injury.
- Do not install the product where it will be exposed to sea wind (salt spray) directly.
 - It may cause corrosion on the product. Corrosion, particularly on the condenser and evaporator fins, could cause product malfunction or inefficient operation.

TABLE OF CONTENTS

3 IMPORTANT SAFETY INSTRUCTIONS

6 INSTALLATION PARTS



6 INSTALLATION TOOLS

7 INSTALLATION MAP

8 INSTALLATION



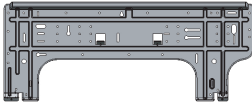







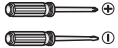

- 8 Select the best Location
- 8 Fixing Installation Plate
- 9 Drill a Hole in the Wall
- 9 Flaring Work
 - 9 - Cut the pipes and the cable
 - 9 - Burrs removal
 - 9 - Putting nut on
 - 9 - Flaring work
- 10 - Check
- 10 Connecting the Piping
 - 10 - Good case
 - 11 - Bad case
 - 11 - Installation of Indoor Unit
 - 11 - Piping
 - 12 - Connecting the installation pipe and drain hose to the indoor unit.
 - 13 - Wrap the insulation material around the connecting portion.
 - 13 - Finishing the indoor unit installation
- 14 Checking the Drainage
 - 14 - To check the drainage.
 - 14 - Drain piping
- 15 Installation of filters
- 16 Wiring Connection
- 17 Installation of Wired Remote controller
- 19 Installer Setting –Thermistor
- 20 Group control setting
 - 20 - Group control 1
 - 21 - Group control 2
 - 22 - Group control 3
 - 23 - Remote control
 - 24 - Accessories for Group control setting

INSTALLATION PARTS

Name	Quantity	Shape
Installation plate	1 EA	 <p>The feature can be changed according to type of model.</p>
Type "A" screw	5 EA	
Type "C" screw	2 EA	

Screws for fixing panels are attached to decoration panel.

INSTALLATION TOOLS

Figure	Name	Figure	Name
	Screw driver		Multi-meter
	Electric drill		Hexagonal wrench
	Measuring tape, Knife		Ammeter
	Hole core drill		Gas-leak detector
	Spanner		Thermometer, Level
	Torque wrench		Flaring tool set

INSTALLATION MAP

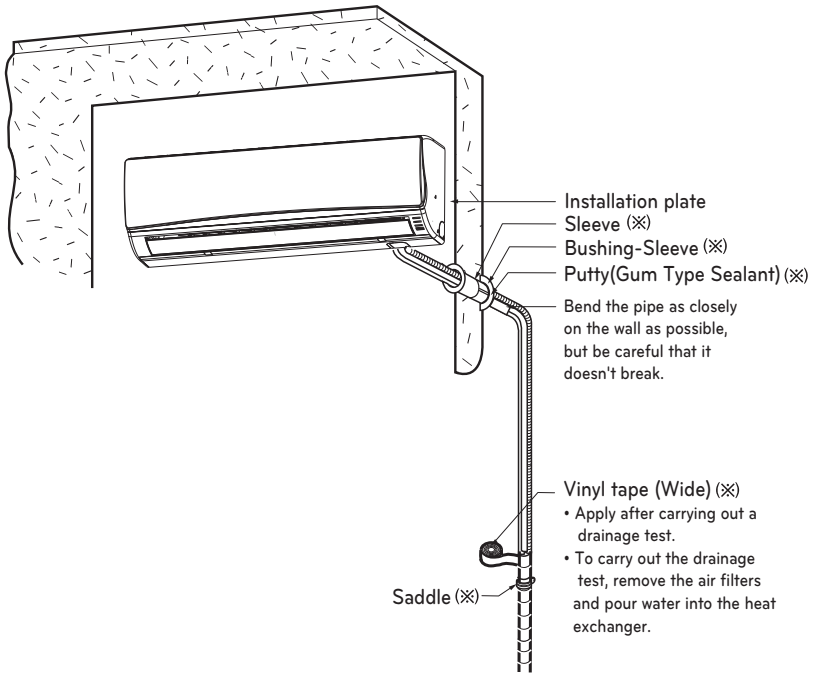

* The feature can be changed according to type of model.

! NOTE

- You should purchase the installation parts.

INSTALLATION

Select the best Location

- There should not be any heat or steam near the unit.
- Select a place where there are no obstacles around of the unit.
- Make sure that condensation drainage can be conveniently routed away.
- Do not install near a doorway.
- Ensure that the interval between a wall and the left (or right) of the unit is more than 100mm. The unit should be installed as high as possible on the wall, allowing a minimum of 200mm from ceiling.
- Use a metal detector to locate studs to prevent unnecessary damage to the wall.

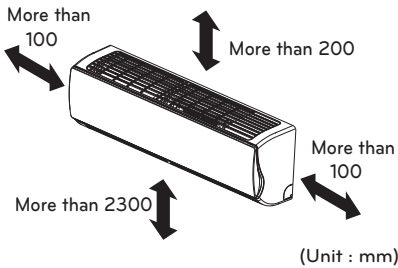

* The feature can be changed according to type of model.

! CAUTION

Install the indoor unit on the wall where the height from the floor is more than 2300mm.

Fixing Installation Plate

The wall you select should be strong and solid enough to prevent vibration

- 1 Mount the installation plate on the wall with type "A" screws. If mounting the unit on a concrete wall, use anchor bolts.
 - Mount the installation plate horizontally by aligning the centerline using Horizontal meter .

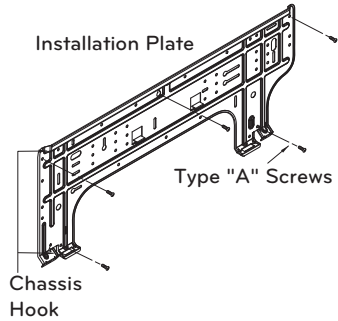

- 2 Measure the wall and mark the centerline. It is also important to use caution concerning the location of the installation plate. Routing of the wiring to power outlets is through the walls typically. Drilling the hole through the wall for piping connections must be done safely.

SB chassis

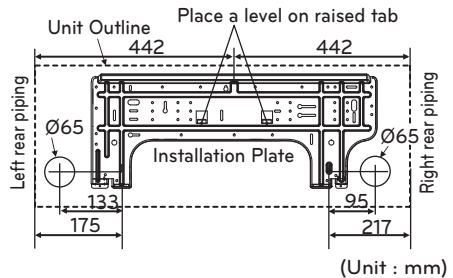

SC chassis

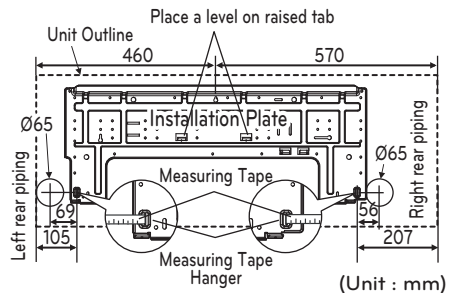

Drill a Hole in the Wall

- Drill the piping hole with a $\varnothing 65\text{mm}$ hole core drill. Drill the piping hole at either the right or the left with the hole slightly slanted to the outdoor side.

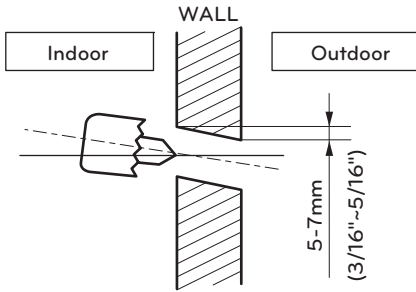

Flaring Work

Main cause for gas leakage is due to defect of flaring work. Carry out correct flaring work in the following procedure.

Cut the pipes and the cable

- 1 Use the piping kit accessory or the pipes purchased locally.
- 2 Measure the distance between the indoor and the outdoor unit.
- 3 Cut the pipes a little longer than measured distance.
- 4 Cut the cable 1.5m longer than the pipe length.

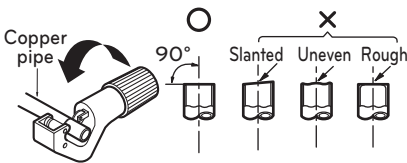

Burrs removal

1. Completely remove all burrs from the cut cross section of pipe/tube.
2. While removing burrs put the end of the copper tube/pipe in a downward direction while removing burrs location is also changed in order to avoid dropping burrs into the tubing.

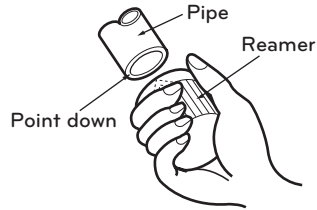

Putting nut on

- Remove flare nuts attached to indoor and outdoor unit, then put them on pipe/tube having completed burr removal. (not possible to put them on after finishing flare work)

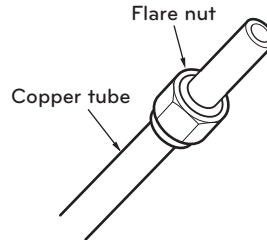

Flaring work

- 1 Firmly hold copper pipe in a bar with the dimension shown in below table table below.
- 2 Carry out flaring work with the flaring tool.

Outside diameter		A
mm	inch	mm
$\varnothing 6.35$	1/4	1.1~1.3
$\varnothing 9.52$	3/8	1.5~1.7
$\varnothing 12.7$	1/2	1.6~1.8
$\varnothing 15.88$	5/8	1.6~1.8
$\varnothing 19.05$	3/4	1.9~2.1

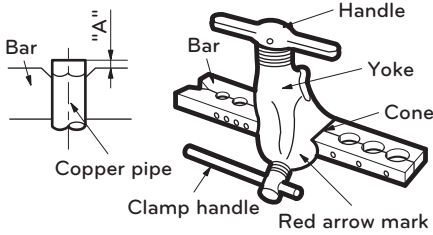

Check

- 1 Compare the flared work with the figure by.
- 2 If a flared section is defective, cut it off and do flaring work again.

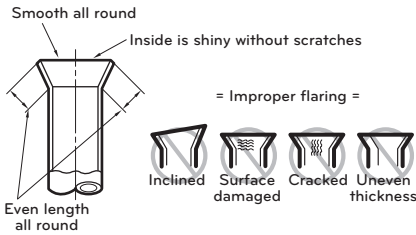

Connecting the Piping

- 1 Pull the screw cap at the bottom of the indoor unit
- 2 Remove the chassis cover from the unit by losing 2 screws

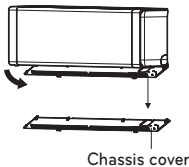
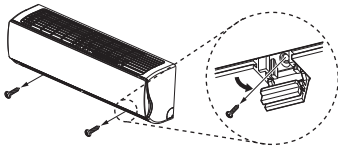

- 3 Pull back the tubing holder.
- 4 Remove pipe port cover and positioning the tubing

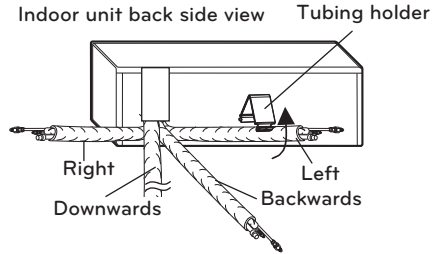

* The feature can be changed according to type of model.

Good case

- Press on the tubing cover and unfold the tubing to downward slowly. And then bend to the left side slowly.

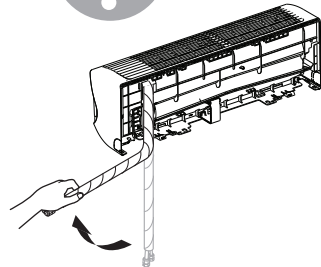
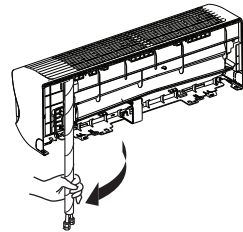

Bad case

- Following bending case from right to left directly may cause damage to the tubing.

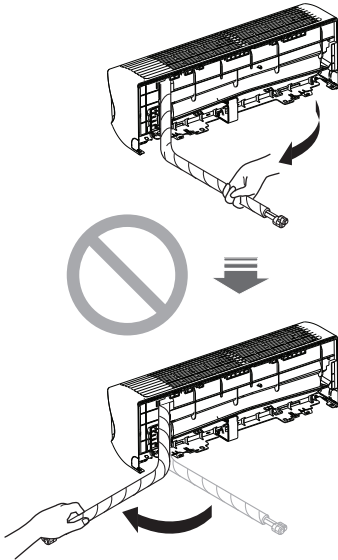

* The feature can be changed according to type of model.

CAUTION

Installation Information. For right piping. Follow the instruction above.

Installation of Indoor Unit

1 Hook the indoor unit onto the upper portion of the installation plate. (engage the three hooks at the top of the indoor unit with the upper edge of the installation plate) Ensure that the hooks are properly seated on the installation plate by moving it left and right

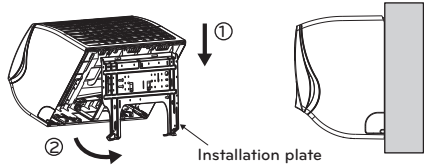

2 Unlock the tubing holder from the chassis and mount between the chassis and installation plate in order to separate the bottom side of the indoor unit from the wall.

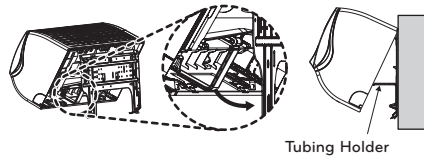

* The feature can be changed according to type of model.

Piping

1 Insert the connecting cable through the bottom side of indoor unit and connect the cable (You can see detail contents in 'Connecting the cables' section)

<Left side piping>

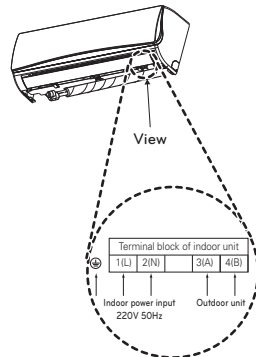

<Right side piping>

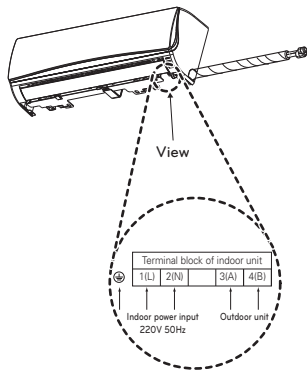

- 2 Secure the cable onto the control board with the cable retainer.
- 3 Tape the tubing pipe, drain hose and the connection cable. Be sure that the drain hose is located at the lowest side of the bundle. Locating at the upper side can cause overflow from the drain pan through the inside of the unit.

<Left side piping>

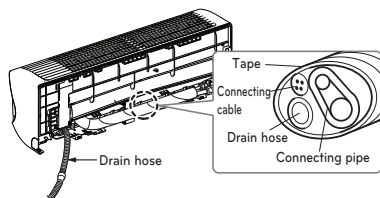

<Right side piping>

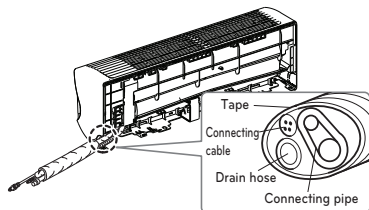

* The feature can be changed according to type of model.

CAUTION

If the drain hose is routed inside the room insulate the hose with an insulation material* so that dripping from sweating condensation will not damage furniture or floors.

* Foamed polyethylene or equivalent is recommended.

Connecting the installation pipe and drain hose to the indoor unit.

- 1 Align the center of the pipes and sufficiently tighten the flare nut by hand

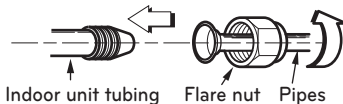

- 2 Tighten the flare nut with a wrench

Outside diameter		Torque
mm	inch	kgf.m
Ø6.35	1/4	1.8~2.5
Ø9.52	3/8	3.4~4.2
Ø12.7	1/2	5.5~6.5
Ø15.88	5/8	6.3~8.2
Ø19.05	3/4	9.9~12.1

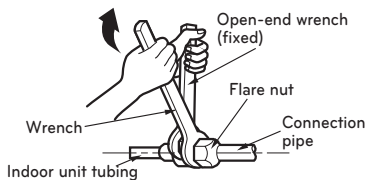

3. When needed to extend the drain hose of indoor unit, assembly the drain pipe as shown on the drawing

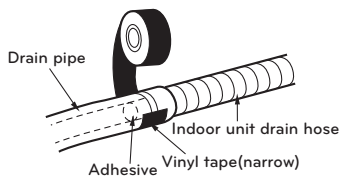

Wrap the insulation material around the connecting portion.

- 1 Overlap the connection pipe insulation material and the indoor unit pipe insulation material. Bind them together with vinyl tape so that there may be no gap.

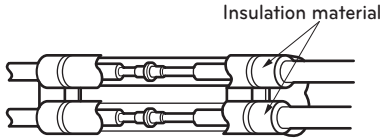

- 2 Set the tubing cutting line upward. Wrap the area which accommodates the rear piping housing section with vinyl tape.

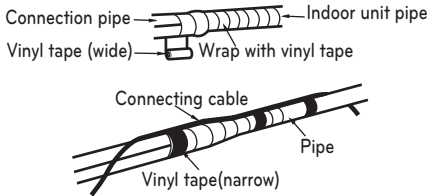
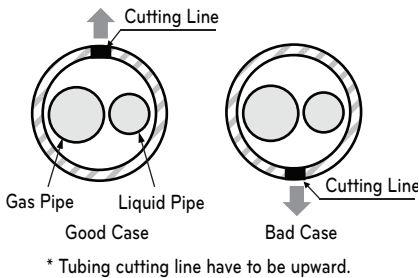

- 3 Bundle the piping and drain hose together by wrapping them with vinyl tape sufficient enough to cover where they fit into the rear piping housing section.

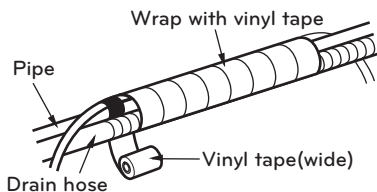

Finishing the indoor unit installation

- 1 Mount the tubing holder in the original position.
- 2 Ensure that the hooks are properly seated on the installation plate by moving it left and right.
- 3 Press the lower left and right sides of the unit against the installation plate until the hooks engage into their slots (clicking sound).
- 4 Finish the assembly by screwing the unit to the installation plate by using two pieces of type "C" screws. And assemble a chassis cover.

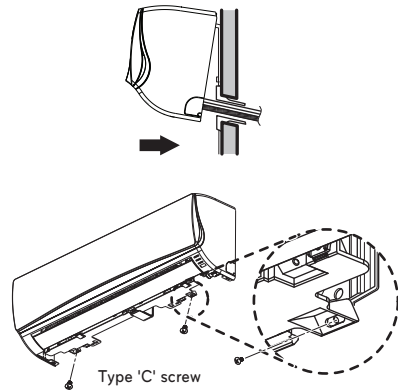

Checking the Drainage

To check the drainage.

- 1 Pour a glass of water on the evaporator.
- 2 Ensure the water flows through the drain hose of the indoor unit without any leakage and goes out the drain exit.

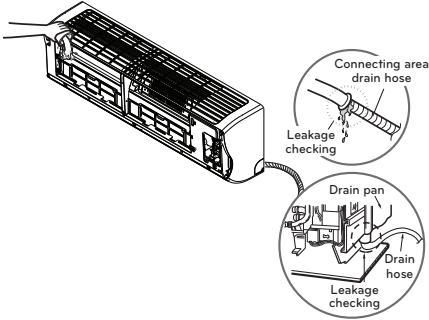

Drain piping

- 1 The drain hose should point downward for easy drain flow.

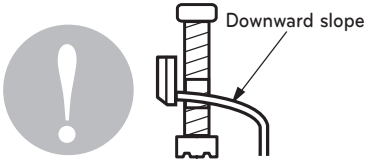

- 2 Do not make drain piping like the following.

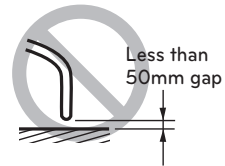
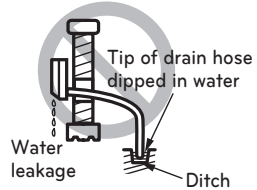
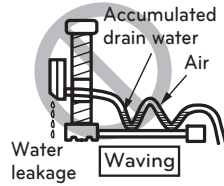
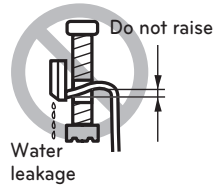

* The feature can be changed according to type of model.

Installation of filters

- 1 Pull out the [Allergy free filter + Triple Filter] from the separately packed plastic bag.
- 2 Detach the two nitto tapes from the filter.
- 3 Insert the filter into the filter case.
- 4 Detach two nitto tapes from the plasma filter.

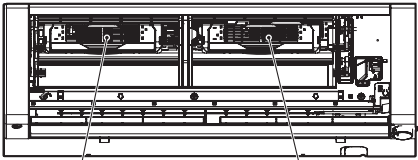

Allergy Free Filter + Triple Filter

Plasma Filter

Wiring Connection

- Connect the wires to the terminals on the control board individually according to the outdoor unit connection.
- Ensure that the color of the wires of outdoor unit and the terminal No. are the same as those of indoor unit respectively.

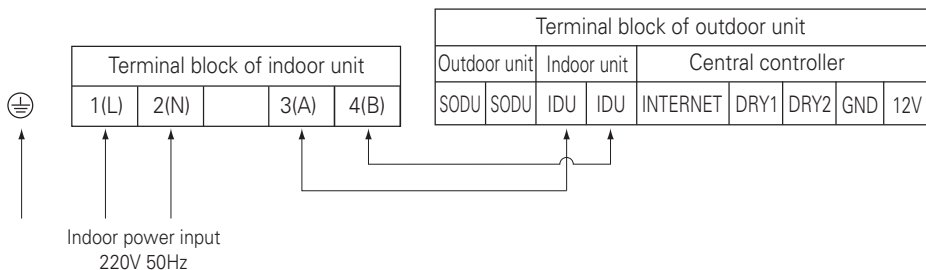

WARNING

Make sure that the screws of the terminal are free from looseness.

CAUTION

The Power cord connected to the unit should be selected according to the following specifications.

CAUTION

After the confirmation of the above conditions, prepare the wiring as follows:

- 1) Never fail to have separate power specially for the air conditioner. As for the method of wiring, follow the circuit diagram pasted on the inside of control box cover.
- 2) Provide a circuit breaker switch between power source and the unit.
- 3) The screw which fasten the wiring in the casing of electrical fittings are liable to come loose from vibrations to which the unit is subjected during the course of transportation. Check them and make sure that they are all tightly fastened. (If they are loose, it could give rise to burn-out of the wires.)
- 4) Confirm the Specification of power source
- 5) Confirm that electrical capacity is sufficient.
- 6) Be sure that the starting voltage is maintained at more than 90 percent of the rated voltage marked on the name plate.
- 7) Confirm that the cable thickness is as specified in the power sources specification. (Particularly note the relation between cable length and thickness.)
- 8) Do not install the leakage breaker in a place which is wet or moist. Water or moist may cause short circuit.
- 9) The following troubles would be caused by voltage drop-down.
 - Vibration of a magnetic switch, damage on the contact point there of, fuse breaking, disturbance to the normal function of a overload protection device.
 - Proper starting power is not given to the compressor.

Installation of Wired Remote Controller

1. Please fix tightly using provided screw after placing remote controller setup board on the place where you like to setup.
 - Please set it up not to bend because poor setup could take place if setup board bends.
 - Please set up remote controller board fit to the reclamation box if there is a reclamation box.

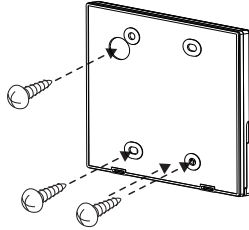

2. Can set up Wired remote controller cable into three directions.
 - Setup direction: the surface of wall reclamation, upper, right
 - If setting up remote controller cable into upper and right side, please set up after removing remote controller cable guide groove.

* Remove guide groove with long nose.

- ① Reclamation to the surface of the wall
- ② Upper part guide groove
- ③ Right part guide groove

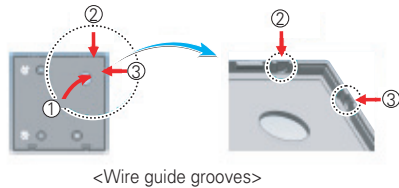

3. Please fix remote controller upper part into the setup board attached to the surface of the wall, as the picture below, and then, connect with setup board by pressing lower part.
 - Please connect not to make a gap at the remote controller and setup board's upper and lower, right and left part.

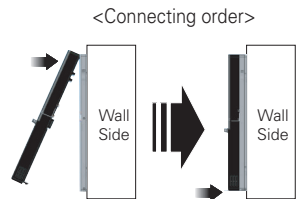

When separating remote controller from setup board, as the picture below, after inserting into the lower separating hole using screw driver and then, spinning clockwise, remote controller is separated.

- There are two separating holes. Please individually separate one at a time.
- Please be careful not to damage the inside components when separating.

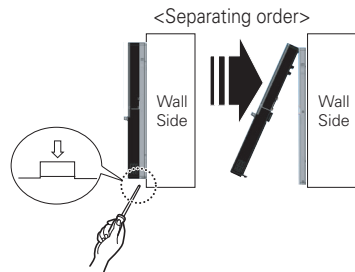

4. Please connect indoor unit and remote controller using connecting cable.

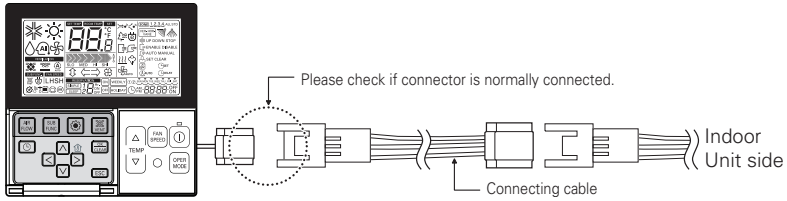

5. Please use extension cable if the distance between wired remote controller and indoor unit is more than 10m.

⚠ CAUTION

When installing the wired remote controller, do not bury it in the wall.
(It can cause damage in the temperature sensor.)

Do not install the cable to be 50m or above.

(It can cause communication error.)

- When installing the extension cable, check the connecting direction of the connector of the remote controller side and the product side for correct installation.
- If you install the extension cable in the opposite direction, the connector will not be connected.
- Specification of extension cable: 2547 1007 22# 2 core 3 shield 5 or above.

Installer Setting -Thermistor

This is the function to select the temperature sensor to judge the room temperature.

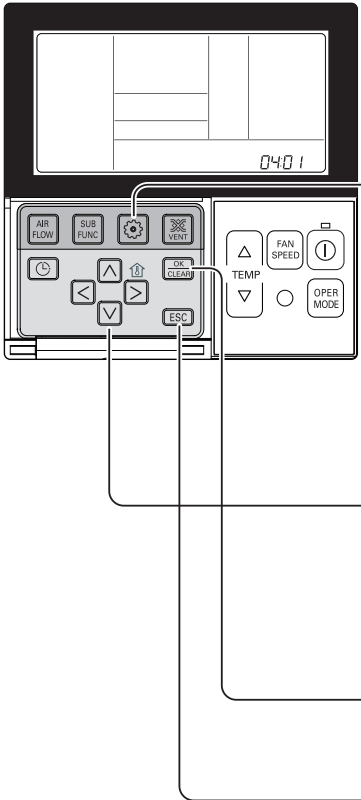

PQRCVSL0
PQRCVSL0QW

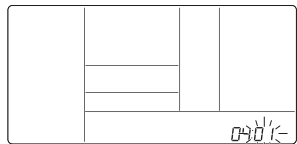

- 1** If pressing button long for 3 seconds, it enters into remote controller setter setup mode.
- If pressing once shortly, it enters into user setup mode. Please press more than 3 seconds for sure.

- 2** If moving to room temperature perception sensor selection menu by pressing button, it indicates as picture below.

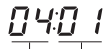
- 3** Set Thermistor value by pressing button. (01: Remote Controller, 02: Indoor, 03: 2TH)

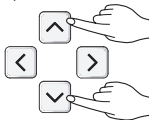
 Function Code Thermistor setting

- 4** Press button to save.



- 5** Pressing button will exit settings mode.
* After setup, it automatically gets out of setup mode if there is no button input for 25 seconds.
* When exiting without pressing set button, the manipulated value is not reflected.

Temperature sensor selection		Function
01	Remote controller	Operation in remote controller temperature sensor
02	Indoor unit	Operation in indoor unit temperature sensor
03	2TH	Cooling Operation of higher temperature by comparing indoor unit's and wired remote controller's temperature. (There are products that operate at a lower temperature.)
		Heating Operation of lower temperature by comparing indoor unit's and wired remote controller's temperature.

* The function of 2TH has different operation characteristics according to the product.

Group Control Setting

1. Group Control 1

■ Wired remote controller 1 + Standard Indoor Units

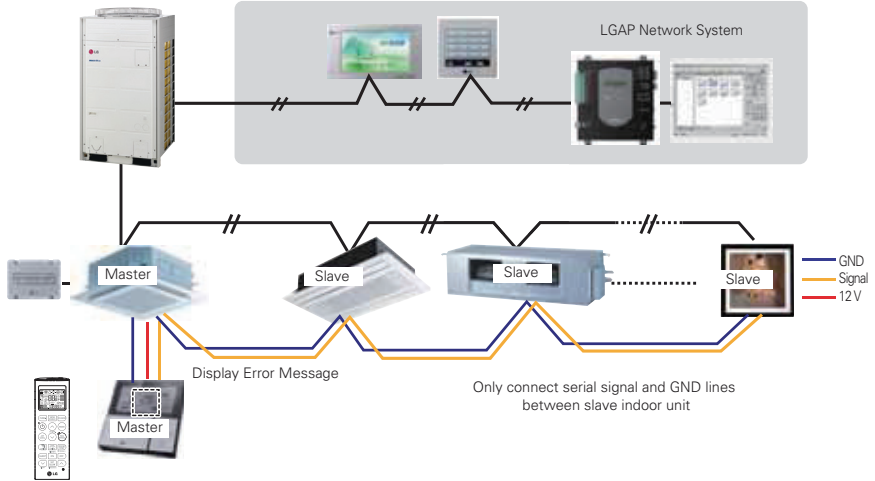

■ Dip Switch in PCB (Cassette and Duct Type indoor units)

① Master Setting

- No. 3 Off

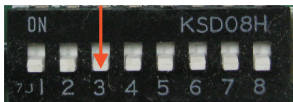

② Slave Setting

- No. 3 On

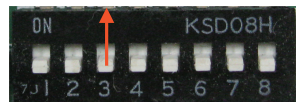

- It is possible to 16 indoor units(Max) by one wired remote controller.
Set only one indoor unit to Master, set the others to Slave.
- It is possible to connect with every type of indoor units.
- It is possible to use wireless remote controller at the same time.
- It is possible to connect with Dry Contact and Central controller at the same time.
 - The Master indoor unit is possible to recognize Dry Contact and Central Controller only.
 - In case of Central controller and Group controller at the same time, it is possible to connect standard 2series indoor units or later since Feb. 2009.
 - In case of Central controller setting, the Central controller can control indoor units after setting only the address of master indoor unit.
 - Slave indoor unit will be operated like master indoor unit.
 - Slave indoor unit can not be individually controlled by Central controller.
 - Some remote controller can't perform with Dry Contact and Central controller at the same time. So contact us further information about it.

5. In case of any error occurs at indoor unit, display on the wired remote controller.
 - Exception of the error indoor unit, an individual indoor unit control possibility.
 6. In case of Group Control, it is possible to use following functions.
 - Selection of operation options (operation/stop/mode/set temperature)
 - Control of flow rate (High/Middle/Low)
 - It is not possible at some functions.
- * Master/Slave setting of indoor units be set possible using a PCB Dip Switch.
- * It is possible to connect indoor units since Feb. 2009.
In the other cases, please contact LGE.
- * It can be the cause of malfunctions when there is no setting of master and slave.

2. Group Control 2

■ Wired remote controllers + Standard Indoor Units

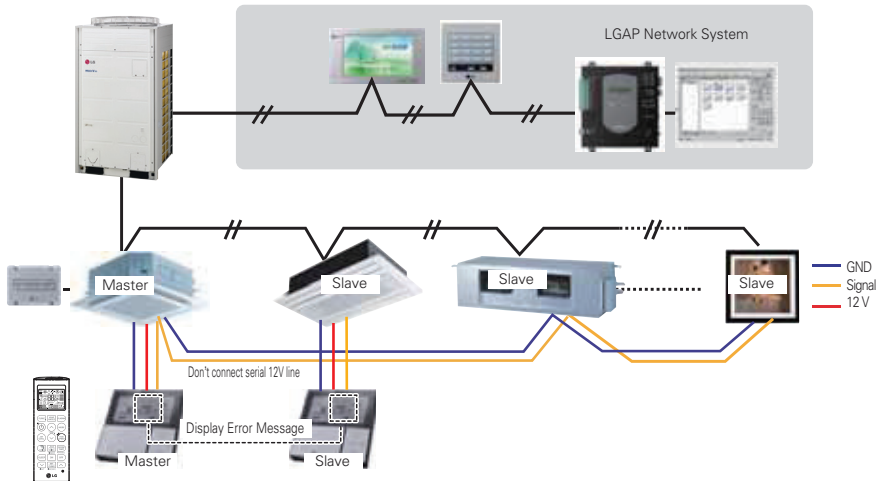

- * It is possible to control N indoor units by wired remote controller M units. ($M+N \leq 17$ Units)
- Set only one indoor unit to Master, set the others to Slave.
- Set only one wired remote controller to Master, set the others to Slave.
- Other than those, it is same with the Group Control 1.

3. Group Control 3

- Mixture connection with indoor units and Fresh Air Intake Unit

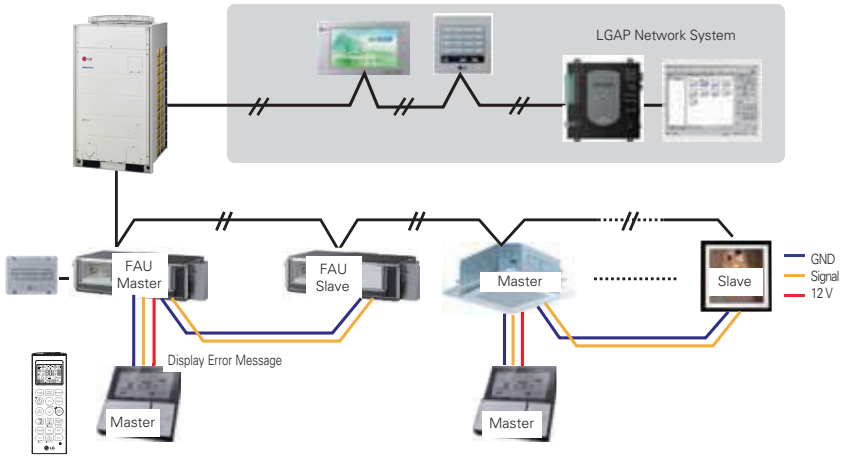

* In case of connecting with standard indoor unit and Fresh Intake Unit, separate Fresh Air Intake Unit with standard units.
(Because setting temperature are different.)

* Other than those, it is same with Group Control 1.



* FAU : Fresh Air Intake Unit
Standard: Standard Indoor Unit

Remote Control

■ Wired remote controller 2 + Indoor unit 1

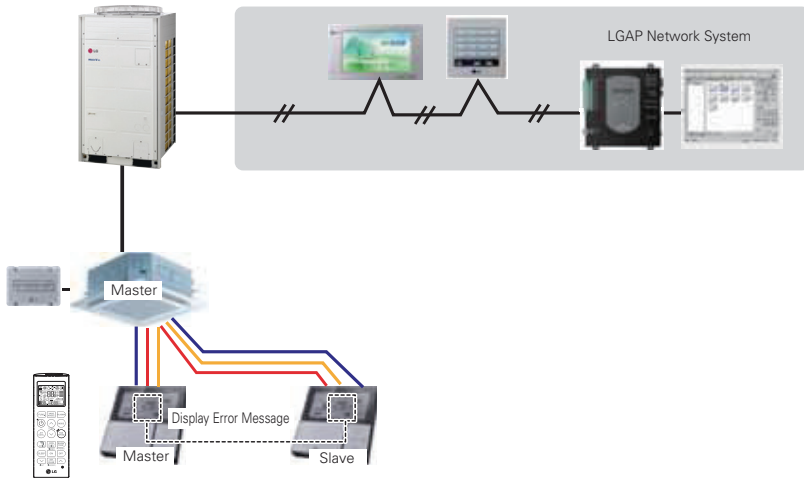

1. It is possible to connect two wired remote controllers with one indoor unit.
 2. Every types of indoor unit is possible to connect two remote controller.
 3. It is possible to use wireless remote controller at the same time.
 4. It is possible to connect with Dry Contact and Central controller at the same time.
 5. In case of any error occurs at indoor unit, display on the wired remote controller.
 6. There isn't limits of indoor unit function.
- h Maximum 2wired remote controllers can be connected with 1 indoor unit.

Accessories for group control setting

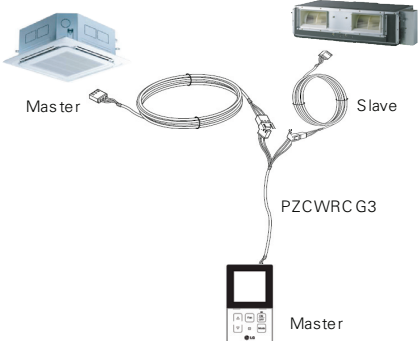
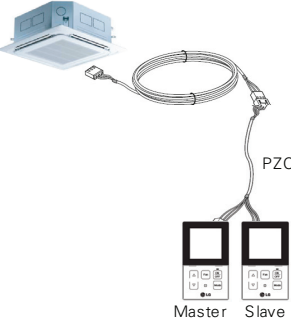
Indoor unit 2 EA +Wired remote controller	Indoor unit 1 EA +Wired remote controller 2EA
<p data-bbox="120 256 461 277">* PZCWRCG3 cable used for connection</p>  <p data-bbox="146 391 202 408">Master</p> <p data-bbox="482 391 521 408">Slave</p> <p data-bbox="400 491 501 509">PZCWRCG3</p> <p data-bbox="412 608 468 625">Master</p>	<p data-bbox="576 256 907 277">* PZCWRC2 cable used for connection</p>  <p data-bbox="841 448 927 466">PZCWRC2</p> <p data-bbox="751 596 801 614">Master</p> <p data-bbox="818 596 869 614">Slave</p>

