



# Room Air Conditioner

(Single Split Wall Mounted Type)

## OWNER'S MANUAL

Before using your air conditioner please read this manual carefully and keep it for future reference.

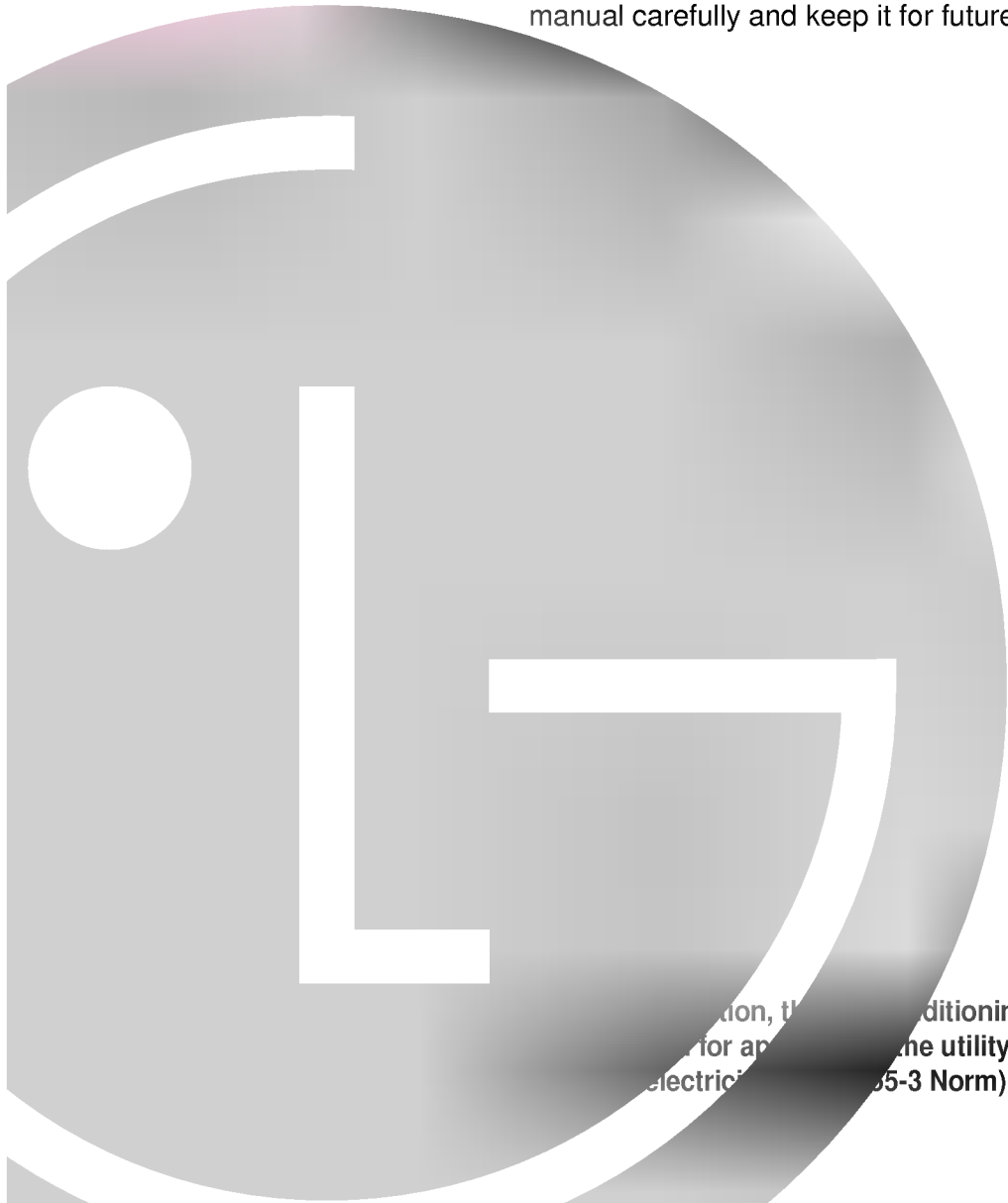

...tion, the conditioning unit must  
... for approval of the utility service which  
... electrician (KSA-3 Norm).

Safety Precautions

Safety Precautions
Installation Precautions .....3
Operation Precautions .....4

Operating Instructions

Operating Instructions
Remote Control Features...7
Operation Mode Selection..10
Additional Features .....15

Care and Maintenance

Care and Maintenance
Care and Maintenance.....19
Operation Tips.....22

Troubleshooting Tips

Troubleshooting tips
Before You Call For Service .....23

FOR YOUR RECORDS

Write the model and serial numbers here for the indoor and outdoor units:

Indoor model # Serial #
Outdoor model # Serial #

You can find them on a label on the side of each unit.

Dealer's Name
Date Purchased

READ THIS MANUAL

- Inside you will find many helpful hints on how to use and maintain your air conditioner properly.
• You'll find many answers to common problems in the chart of troubleshooting tips.

CAUTION

- Contact the authorized Service technician for repair or maintenance of this unit.
• Contact the installer for installation of this unit.
• The air conditioner is not intended for use by young children or infirm persons without supervision.
• Young children should be supervised to ensure that they do not play with the air conditioner.

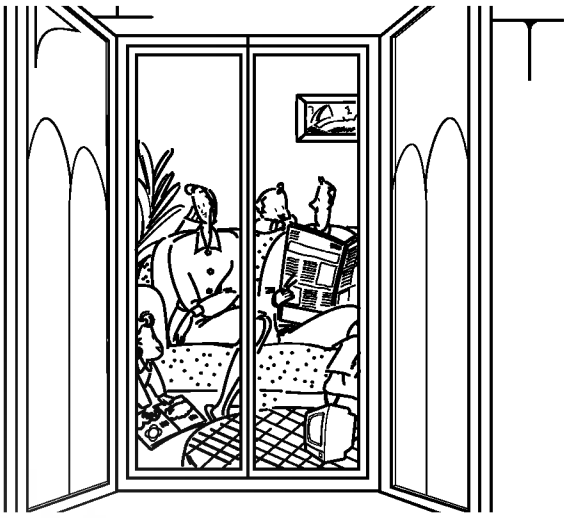



# Important safety precautions



## Read all instructions before using.

To prevent injury to the user or other people and property damage, the following instructions must be followed.

■ Incorrect operation due to ignoring of instruction will cause harm or damage, the seriousness is classified by the following indications.

	<b>WARNING</b> : This symbol indicates the possibility of death or serious injury.
	<b>CAUTION</b> : This symbol indicates the possibility of injury or damage to properties only.

■ Meanings of symbols used in this manual are as shown below.



	<b>Be sure not to do.</b>
	<b>Be sure to follow the instruction.</b>

### **WARNING**

- **Do not install, remove and reinstall the unit by yourself.**
  - Improper installation will cause water leakage, electrical shock, or fire. Please consult authorized dealer or specialist for the installation work. Please note fault caused by improper installation is not covered by warranty.
  - Unit must be installed in an easily accessible area. Any additional cost required to hire a special equipment to service the unit will be the responsibility of the customer.

### **CAUTION**

*Please confirm the following important points during installing.*

- **This room air conditioner must be earthed.**
  -  It may cause electrical shock if grounding is not perfect.
- **Do not install the unit at place where leakage of gas may occur and/or in an explosive atmosphere.**
  -  In case gas leaks, the gas may accumulates the unit and it may cause fire ignition.
- **Confirm drainage piping is connected properly.**
  -  If it is not connected perfectly, it may cause water leakage and dampen the furniture.
- The reverse cycle system of the air conditioner is based on the air cooling type heat pump which absorbs heated air from the outdoor unit and discharges it indoor. Therefore if the outdoor unit is exposed to very low temperature, specifically below 0°C, the heating capacity drops off rapidly.

Safety Precautions

Operating Instructions

Care and Maintenance

Troubleshooting Tips



Safety Precautions

Operating Instructions

Care and Maintenance

Troubleshooting Tips

 **WARNING**

- Otherwise, it will cause electrical shock or fire due to heat generation.

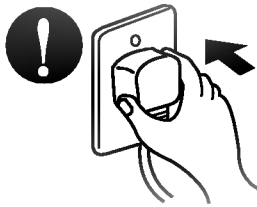

- It will cause electrical shock or fire due to heat generation.

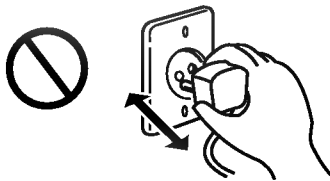

- It will cause electrical shock or fire.
- If the supply cord is damaged, it must be replaced by the manufacturer or its service agent or a similarly qualified person in order to avoid a hazard.

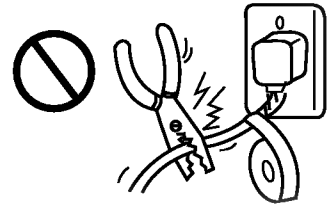

- It will cause electrical shock or fire due to heat generation.

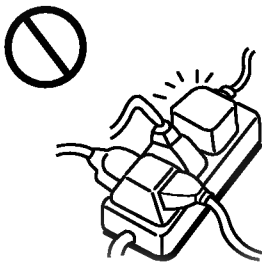

- It may cause electrical shock.



- Since the fan rotates at high speed, this may cause an injury or damage the unit.

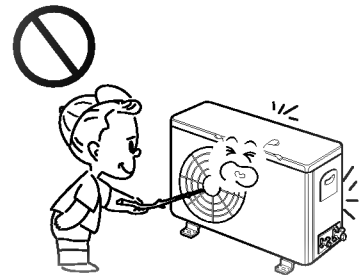

- This could damage your health.

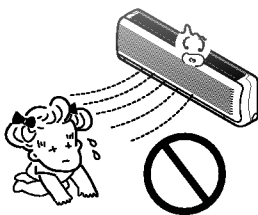

- If the unit continues to be operated in an abnormal condition, it may cause a fire, damage, etc. In this case, consult your dealer.

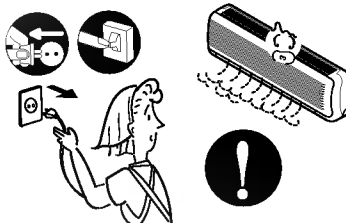

- If this is done incorrectly, it may cause a fire, electric shock, injury by dropping of the unit, water leakage, etc. Consult your dealer.

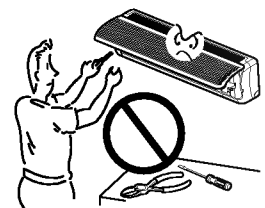

**⚠ CAUTION**

- It may cause an injury.
- Should be disconnected from supply

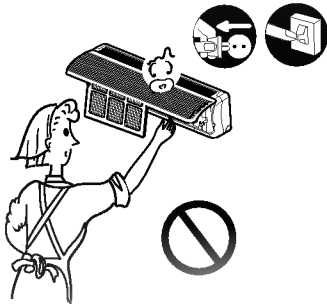

- Water may enter the unit and degrade the insulation. It may cause an electric shock.

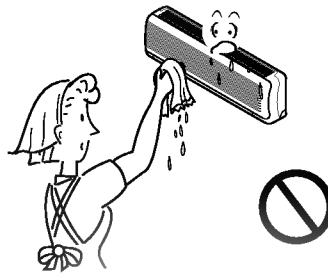

- An oxygen shortage may occur.

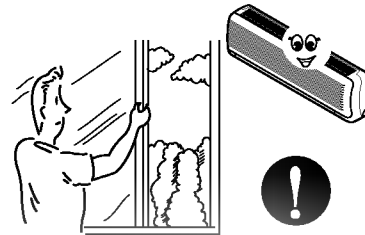

- Since the fan rotates at high speed during operation, it may cause an injury.

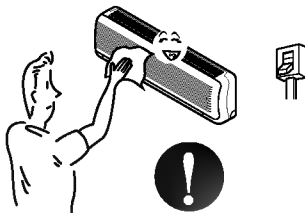

- This could injure the pet or plant.

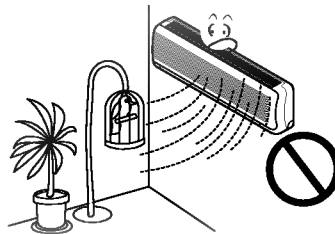

- Do not use this air conditioner to preserve precision devices, food, animal, plants, and art objects. It may cause deterioration of quality, etc.

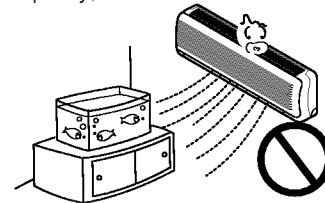

- It may cause an electric shock.



- It may cause a fire or deformation of the cabinet.

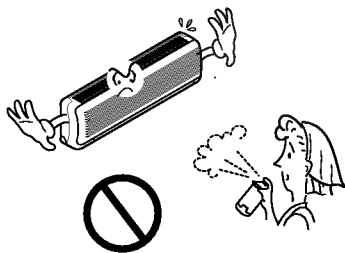

- It may affect combustion.

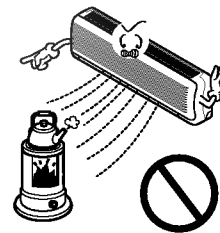

**CAUTION**

When the unit is not going to be used for a long time, turn off the circuit breaker.

- If not, dirt may collect and cause a fire.

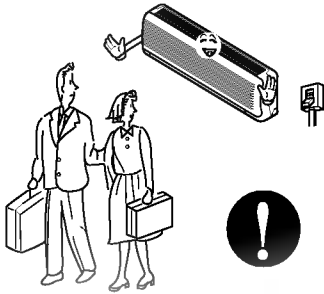

Do not operate for a long time in high humidity, e.g. leaving a door or window open.

- In the cooling mode, if it is operated in a room with high humidity (80%RH or more) for a long time, water condensed in the air conditioner may drop and may wet and spoil furniture, etc.



- It may cause an injury through dropping or falling down.
- It may cause an injury, etc. by falling down.

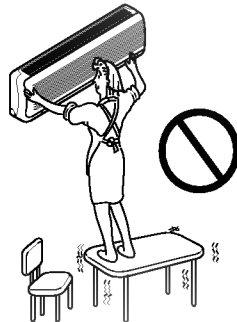
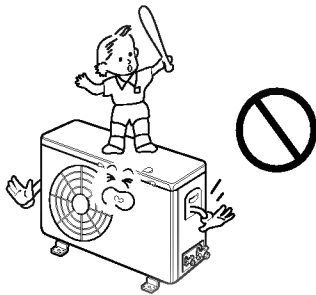

- The unit may drop or fall down and cause an injury.
- It will cause an injury by the rotating blower.

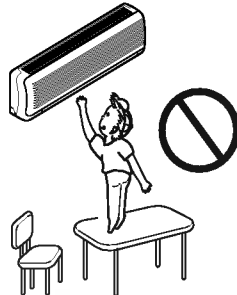
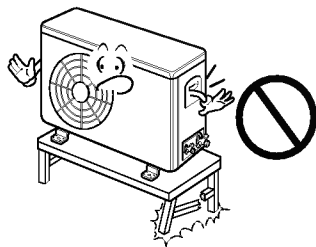

**For installation**

**WARNING**

- Consult your dealer for installing the air conditioner.

**CAUTION**

Install a ground fault interrupter depending on the place where the air conditioner is to be installed. (humid place, etc.)

- If the ground fault interrupter is not installed, it may cause an electric shock.



- If gas leaks and collect around the unit, it may cause an explosion.

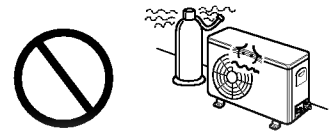

- If the drainage route is incomplete, water may drop from the unit. It may wet and spoil furniture.

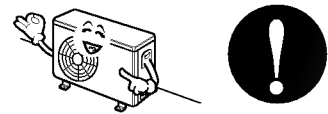

# About the remote control on the system

The remote control transmits the signals to the system.



## Features of the Remote Control- Door Opened

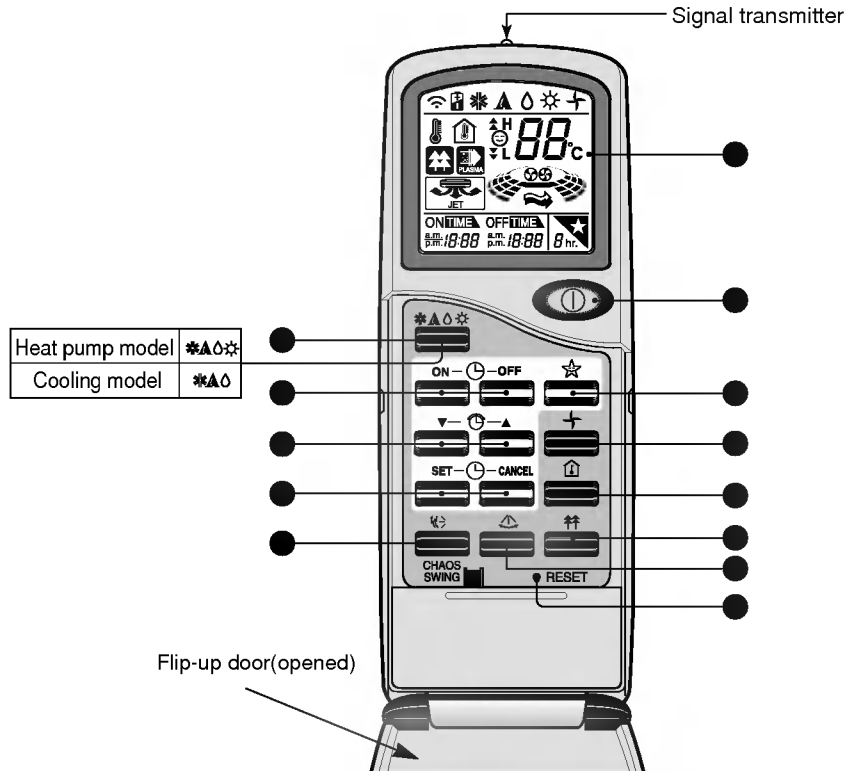

- **OPERATION DISPLAY**  
Displays the operation conditions.
- **START/STOP BUTTON**  
Operation starts when this button is pressed and stops when the button is pressed again.
- **OPERATION MODE SELECTION BUTTON**  
Used to select the operation mode. (Refer to page 8)
- **ON/OFF TIMER BUTTONS**  
Used to set the time of starting and stopping operation.
- **TIME SETTING BUTTONS**  
Used to adjust the time.
- **TIMER SET/CANCEL BUTTONS**  
Used to set the timer when the desired time is obtained and to cancel the Timer operation.
- **CHAOS SWING BUTTON**  
Used to stop or start louver movement and set the desired up/down airflow direction.
- **SLEEP MODE AUTO BUTTON**  
Used to set Sleep Mode Auto operation.
- **AIR CIRCULATION BUTTON**  
Used to circulate the room air without cooling or heating (turns indoor fan on/off).
- **ROOM TEMPERATURE CHECKING BUTTON**  
Used to check the room temperature.
- **NEGATIVE ION (Not on all models)**  
Used to generate negative ion.
- **HORIZONTAL AIRFLOW DIRECTION CONTROL BUTTON (Not on all models)**  
Used to set the desired horizontal airflow direction.
- **RESET BUTTON**  
Used prior to resetting time or after replacing batteries.

Safety Precautions

Operating Instructions

Care and Maintenance

Troubleshooting Tips



## Features of the Remote Control- Door Closed

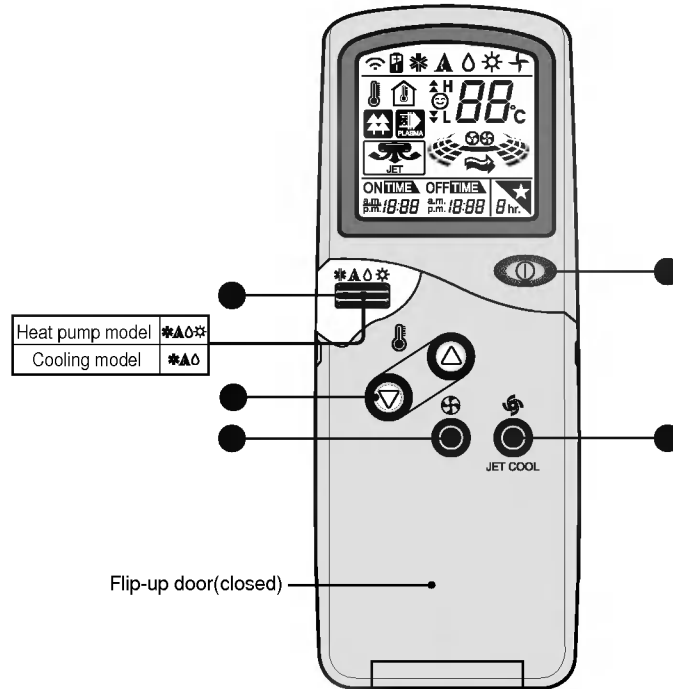

● **START/STOP BUTTON**

Operation starts when this button is pressed and stops when the button is pressed again.



● **OPERATION MODE SELECTION BUTTON**

Used to select the operation mode.



● **ROOM TEMPERATURE SETTING BUTTONS**

Used to select the room temperature.



● **INDOOR FAN SPEED SELECTOR**

Used to select fan speed in four steps-low, medium, high, or CHAOS.



● **JET COOL**

Used to start or stop the speed cooling. (Speed cooling operates super high fan speed in cooling mode.)



### Operation Mode

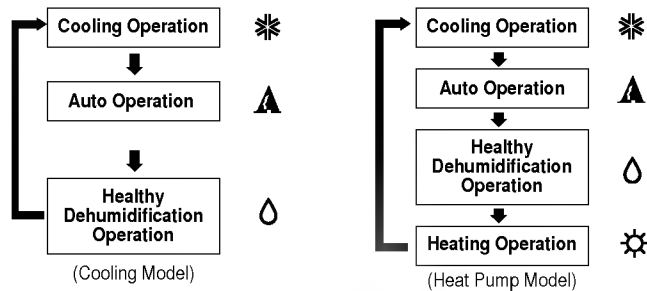



# About the remote control on the system

## Storage and Tips For Using the Remote Control

- The remote control may be stored inside the system or mounted on a wall.(except 7k, 9k model)
- To operate the room air conditioner, aim the remote control at the signal receptor.
- The remote control will operate the air conditioner at a distance of up to 7m.

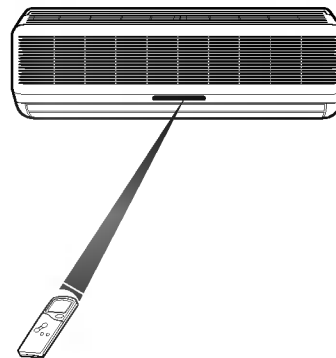
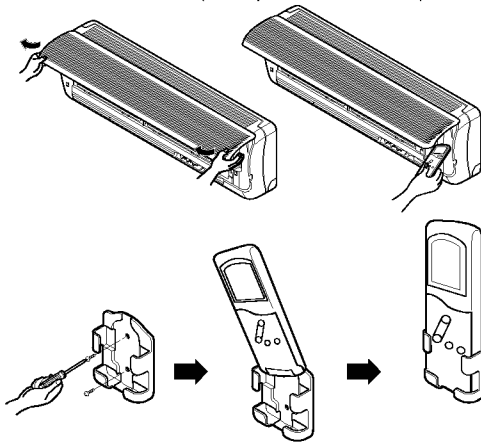

## How to Insert the Batteries

- 1 Remove the battery cover by pulling it according to the arrow direction.
- 2 Insert new batteries making sure that the (+) and (-) of battery are installed correctly.
- 3 Reattach the cover by sliding it back into position.

### NOTES:

- Use 2 AAA(1.5volt) batteries. Do not use rechargeable batteries
- Remove the batteries from the remote control if the system is not going to be used for a long time.

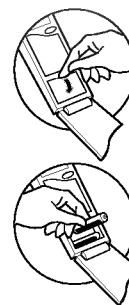

## Inside the Indoor System

### Slide Switch Operation (Refer to page 18)

**FORCED OPERATION:** Used for operation when the remote control cannot be used.

**AUTO RESTART:** In case the power comes on again after a power failure, the air conditioner will operate in "Auto Restart Operation" mode. This function automatically returns the air conditioner to the pervious operating conditions.

**REMOTE CONTROL:** If you do not want to use Auto Restart Operation

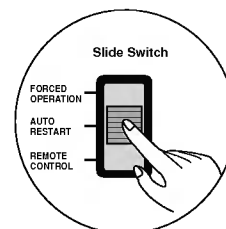

### Signal Receptor

Receives the signals from the remote control.

(Signal receiving sound: two short beeps or one long beep.

### Operation Indication Lamps

- ⓪ On/Off : Lights up during the system operation.
- ☆ Sleep Mode : Lights up during Sleep Mode Auto operation.
- ⌚ Timer : Lights up during Timer operation.
- ✱ Defrost Mode : Lights up during Defrost Mode or Hot Start operation (Heat pump model only)
- OUT DOOR UNIT OPERATION : Lights up during outdoor unit operation. (Cooling model only)

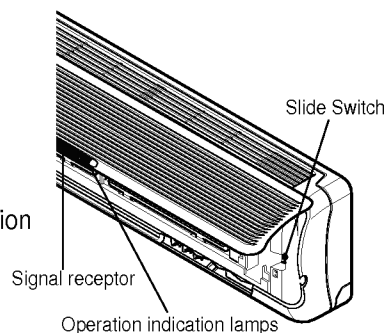

Safety Precautions

Operating Instructions

Care and Maintenance

Troubleshooting Tips



## How to use the Operation Mode Selection button



### Cooling Operation

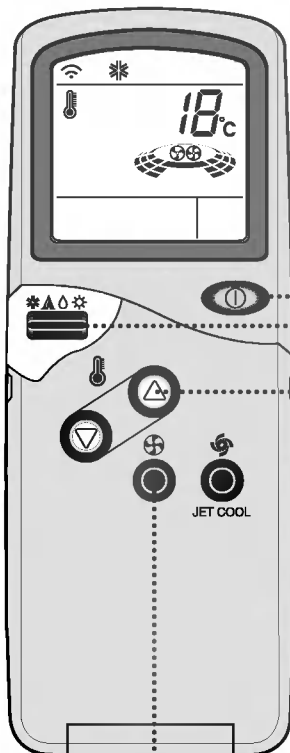

- 1 Press the Start/Stop button. The unit will respond with a beep.



- 2 Open the door on the remote control. To select **Cooling Operation**, press the Operation Mode Selection button. Each time the button is pressed, the operation mode is shifted in the direction of the arrow.

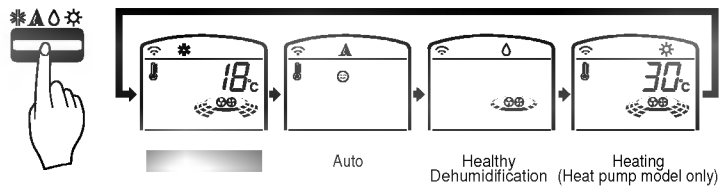

- 3 Close the door on the remote control. Set the temperature lower than the room temperature. The temperature can be set within a range of 18°C~30°C in 1°C increments.

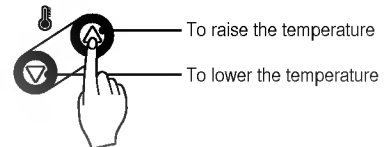

- 4 Set the fan speed again with the door of the remote control still closed. You can select the fan speed in four steps-low, medium, high, or CHAOS. Each time the button is pressed, the fan speed mode is shifted.





## Auto Operation

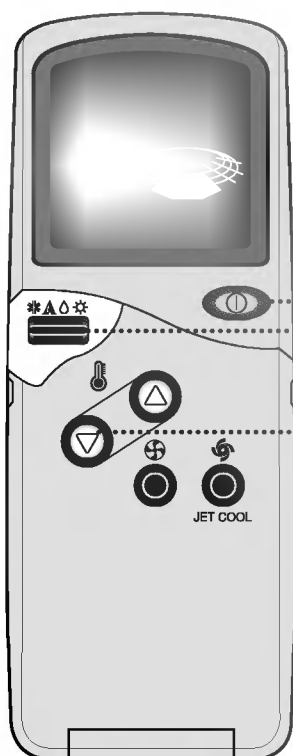

- 1 Press the Start/Stop button. The unit will respond with a beep.



- 2 Open the door on the remote control. To select **Auto Operation**, press the Operation Mode Selection button. Each time the button is pressed, the operation mode is shifted in the direction of the arrow.

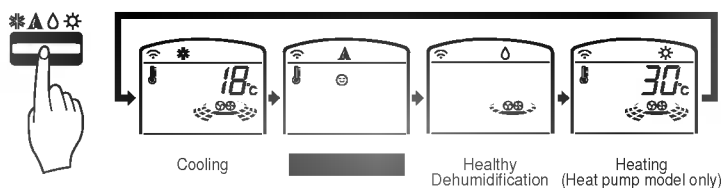

- 3 The temperature and fan speed are automatically set by the electronic controls based on the actual room temperature. If you want to change the set temperature, close the door on the remote control and press the Room Temperature Setting buttons. The cooler or warmer you feel, the more times (up to two times) you should press the button. The set temperature will then be changed automatically.

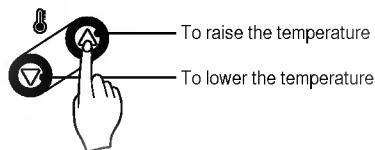
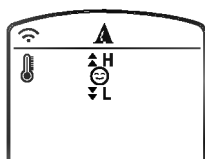

### During Auto Operation:

- ❑ You cannot switch the indoor fan speed. It has already been set by the Fuzzy rule.
- ❑ If the system is not operating as desired, manually switch to another mode. The system will not automatically switch from the cooling mode to the heating mode, or from heating to cooling, it must be done by manually resetting.
- ❑ During Auto Operation, pressing the Airflow direction Start/Stop button makes the horizontal louvers swing up and down automatically. If you want to stop auto-swing, press the Airflow Direction Start/Stop button again.



## Healthy Dehumidification Operation

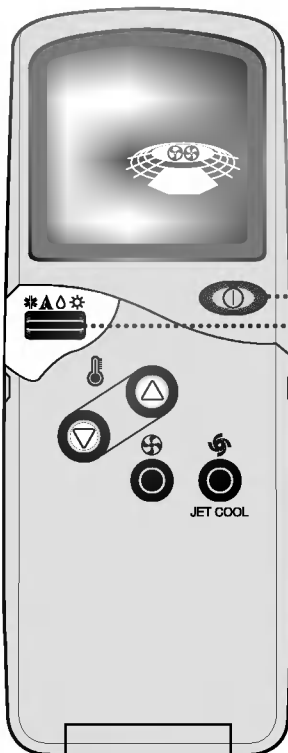

- 1 Press the Start/Stop button. The unit will respond with a beep.



- 2 Open the door on the remote control. To select **Healthy Dehumidification Operation**, press the Operation Mode Selection button. Each time the button is pressed, the operation mode is shifted in the direction of the arrow.

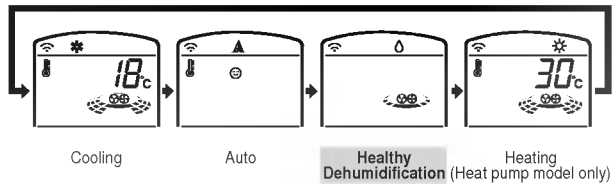

### During Healthy Dehumidification Operation:

- ❑ If you select the dehumidification mode on the operation selection button, the A/C starts to run the dehumidification function, automatically setting the room temp. and airflow volume to the best condition for dehumidification based on the sensed current room temp.  
In this case, however, the setting temp. is not displayed in the remote control and you are not able to control the room temp. either.
- ❑ During the healthy dehumidification function, the airflow volume is automatically set according to the optimization algorithm responding to the current room temp. status and makes the room condition healthy and comfortable even in the high humidity season.



## Heating Operation (Heat pump model only)

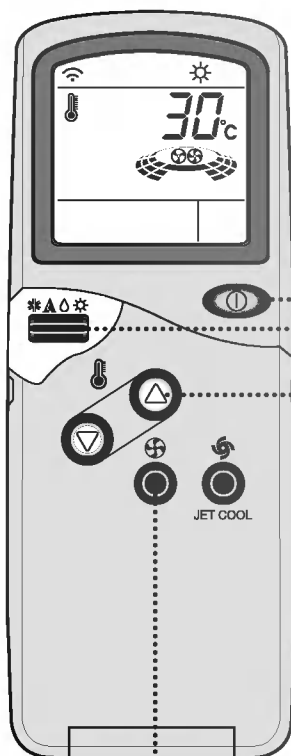

- 1 Press the Start/Stop button. The unit will respond with a beep.



- 2 Open the door on the remote control. To select **Heating Operation**, press the Operation Mode Selection button. Each time the button is pressed, the operation mode is shifted in the direction of the arrow.

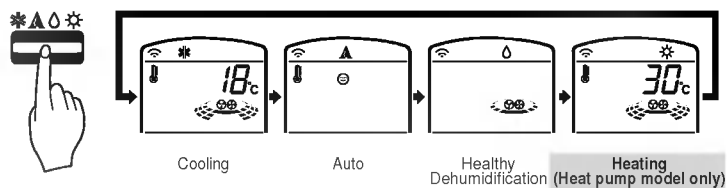

- 3 Close the door on the remote control. Set the temperature higher than the room temperature. The temperature can be set within a range of 16°C~30°C in 1°C increments.

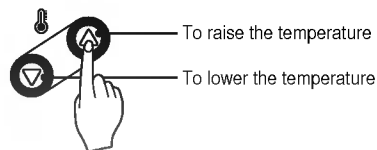

To raise the temperature

To lower the temperature

- 4 Set the fan speed again with the door of the remote control still closed. You can select the fan speed in four steps—low, medium, high, or CHAOS. Each time the button is pressed, the fan speed mode is shifted.





## Jet Cool Operation

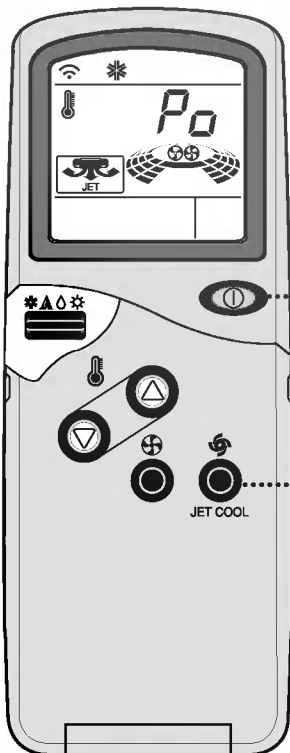

- 1 Press the Start/Stop button. The unit will respond with a beep.



- 2 Press the **Jet Cool** button to operate the speed cooling mode and the unit will operate in super high fan speed on cooling mode for 30 minutes.

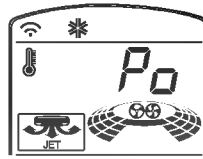

- 3 To cancel the **Jet Cool** mode, press the **Jet Cool** button again or the fan speed button or the room temperature setting button and the unit will operate in high fan speed on cooling mode.

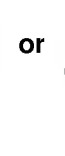
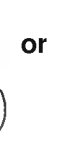

### NOTE:

- ❑ During the JET COOL function at any moment, the A/C starts to blow the cool air at extremely high speed for 30 minutes setting the room temp. automatically to 18°C. It is especially used to cool the room temp. in the shortest time in a hot summer.  
In heat pump mode or neuro fuzzy mode however, the JET COOL function is not available.
- ❑ In order to return to the normal cooling mode from the JET COOL mode, you just press either the operation mode selection button, airflow volume selection or temp. setting button or the JET COOL button again.



# Additional features

## ★ Sleep Mode

- Press the Sleep Mode Auto button to set the time you want the unit to turn off automatically. 
- The Timer is programmed in one-hour increments by pressing the Sleep Mode Auto button 1 to 7 times. The sleep mode is available for 1 to 7 times. To alter the time period in steps of 1 hour, press the Sleep Mode Button while aiming at air conditioner.
- Make sure the Sleep Mode Auto LED lights up.

To cancel the Sleep Mode, press the sleep Mode Auto button several times until the star (★) disappears from the operation display.

**NOTE:** The Sleep Mode will be operated at low fan speed (cooling) or medium fan speed (heat pump only) for quiet sleeping.

IN COOLING MODE: The temperature will automatically rise by 1°C over the next 30 minutes and by 2°C in 1 hour for comfortable sleeping.

## 🕒 Setting the Time

Time can be set only when you have pressed the Reset button. If you have just replaced the batteries, the Reset button should be pressed to reset the time.

- Press the Start/Stop button. 

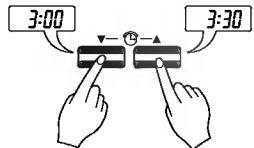
- Press the Time Setting buttons until the desired time is set. 

- Press the Timer SET button. 

**NOTE:** Check the indicator for A.M. and P.M.

## 🕒 Delay Start/Pre-Set Stop

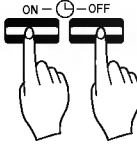
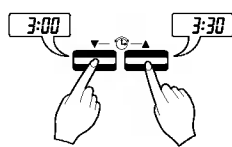
- Make sure the time is set correctly on the remote control display.
- Press the ON/OFF Timer buttons to turn Timer on or off. 
- Press the Time Setting buttons until the desired time is set. 

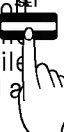
- Press the selected on/off setting by pressing the Timer SET button while aiming the remote control at the signal receptor. 

**To cancel the setting the timer.**



Press the Timer Cancel button while aiming remote control at the signal receptor. (The timer lamp on the air conditioner and the display will go out.)

**NOTE:** Select one of the following four types of operation.

with the unit running

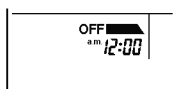

Delay OFF Timer



Delay ON Timer



Delay OFF and ON Timer



Delay ON and OFF Timer



## Vertical Airflow Direction Control

The up/down airflow (Vertical Airflow) can be adjusted by using the remote control.

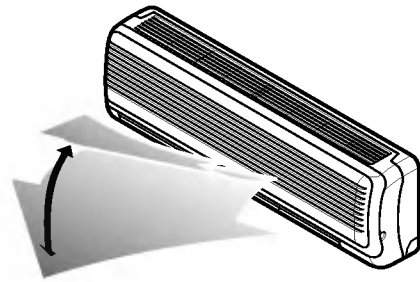

- Press the Start/Stop button to start the unit.
- Open the door on the remote control. Press Chaos Swing button and the louvers will swing up and down. Press the CHAOS Swing button again to set the vertical louver at the desired airflow direction.



### NOTE:

- If you press the CHAOS swing button, the horizontal airflow direction is changed automatically based on the CHAOS algorithm to distribute the air in the room evenly and at the same time to make the human body feel most comfortable, as if enjoying a natural breeze.
- Always use the remote control to adjust the up/down airflow direction. Manually moving the vertical airflow direction louver by hand could damage the air conditioner.
- When the unit is shut off, the up/down airflow direction louver will close the air outlet vent of the system.

### To adjust left/right(Horizontal Airflow) direction

**Caution :** Ensure unit is turned off before adjusting the horizontal airflow direction control. Carefully open vertical louver to allow access to the horizontal airflow direction.

Adjust the left/right airflow direction by hand.

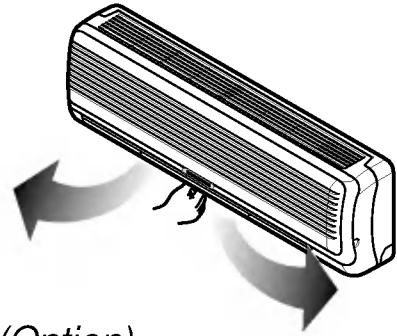

## Horizontal Airflow Direction Control (Option)

The left/right(Horizontal Airflow) can be adjusted by using the remote control.

- Press the Start/Stop button to start the unit.
- Open the door on the remote control. Press the Airflow Direction Start/Stop button and the louvers will swing left and right. Press the Horizontal Airflow Direction Control Button again to set the horizontal louver at the desired airflow direction.

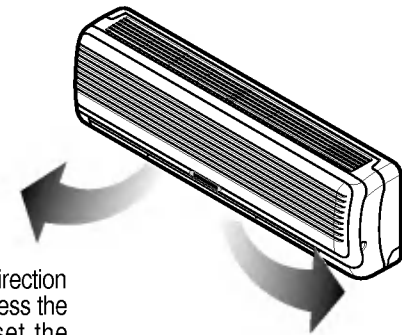
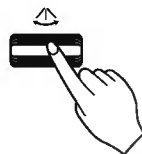





## Air Circulation Mode

Circulates the room air without cooling or heating.

- Press the Start/Stop button. the unit will respond with a beep.
- Open the door on the remote control. Press the Air Circulation button. Close the door on the remote control. Now each time that you press the Indoor Fan Speed Selector, the fan speed is shifted from low to CHAOS and back to low again.

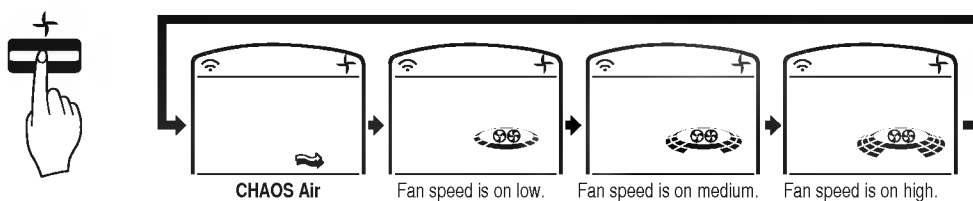

### NOTE:

- **CHAOS Air** economizes power consumption and prevents overcooling. The fan speed is automatically changed from high to low or vice versa, depending on the ambient temperature.



## Negative Ion (Option)

Negative ions are known as 'the vitamins of the air'. In contrast, polluted air contains positive ions, which are one of the major contributors to "Sick Building Syndrome", where people suffer from headaches, stress, and fatigue.



## Slide Switch Operation

### FORCED OPERATION

Operation procedures when the remote control can't be used.

Open the front panel upward and move the Slide Switch to the Forced Operation position.

If you want to stop operation, move the Slide Switch to the Auto Restart or the Remote Control position.

In case the power comes on again after power failure on the Forced Operation position, the operating conditions are automatically set as follows:

During Forced Operation, the initial mode continues.

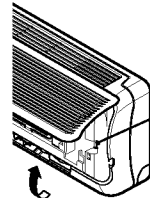

Open the front panel upward

Slide Switch

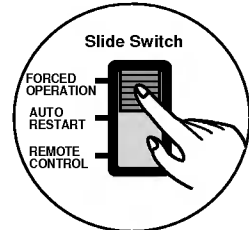

	Cooling Model	Heat pump Model		
		Room Temp. $\geq 24^{\circ}\text{C}$	$21^{\circ}\text{C} \leq$ Room Temp. $< 24^{\circ}\text{C}$	Room Temp. $< 21^{\circ}\text{C}$
Operating mode	Cooling	Cooling	Healthy Dehumidification	Heating
Indoor FAN Speed	High	High	Healthy Dehumidification Rule	High
Setting Temperature	$22^{\circ}\text{C}$	$22^{\circ}\text{C}$	$23^{\circ}\text{C}$	$24^{\circ}\text{C}$

### AUTO RESTART

In case the power comes on again after a power failure, Auto Restarting Operation is the function to operate procedures automatically to the previous operating conditions.

In case the air conditioner does not receive any signal from the remote control, it will turn off automatically after 7 hours.

If you want to use this operation, Open the front panel upward and move the slide switch to the Auto Restart position.

If you do not want to use this operation, move the Slide Switch to the Remote Control position.

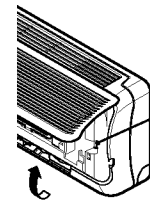

Open the front panel upward

Slide Switch

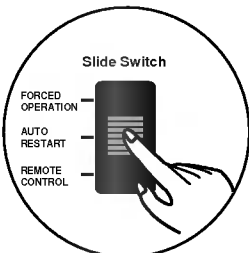

When you are out for a while, put the Slide Switch on the REMOTE CONTROL

## Operation Details

### Natural wind by the CHAOS logic

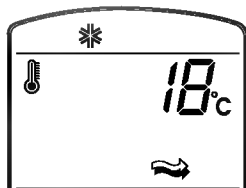

For more fresh feeling than other fan speed, press the Indoor Fan Speed Selector and set to CHAOS mode. In this mode, the wind blows like natural breeze by automatically changing fan speed according to the CHAOS logic.

### Helpful information

Fan speed and cooling capacity.

The cooling capacity indicated in the specification is the value when the fan speed is set to high, and the capacity will be lower at low or medium fan speed.

High fan speed is recommended when you wish to cool the room quickly.

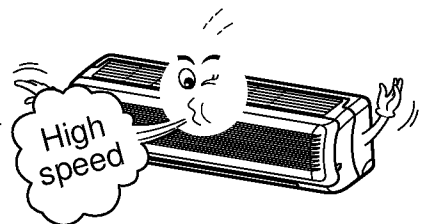

# Care and maintenance of the air conditioner

**CAUTION:** Before performing any maintenance, turn off the main power to the system.

## Indoor Unit

### Grille, Case, and Remote Control

- Turn the system off before cleaning. To clean, wipe with a soft, dry cloth. Do not use bleach or abrasives.

**NOTE:**

Supply power must be disconnected before cleaning the indoor unit.

- Never use any of the followings:
  - Water hotter than 40°C  
Could cause deformation and/or discoloration.
  - Volatile substances  
Could damage the surfaces of the air conditioner.

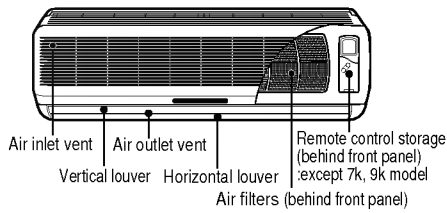

### Air Filters

The air filters behind the front grille should be checked and cleaned once every 2 weeks or more often if necessary.

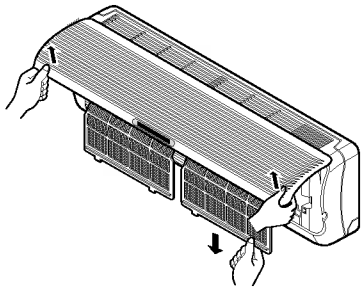

- Lift the front access panel and pull the filter tab slightly forward to remove the filter.
- Clean the filter with a vacuum or warm, soapy water.
  - If dirt is conspicuous, wash with a solution of detergent in lukewarm water.
  - If hot water (40°C or more) is used, it may be deformed.
- After washing with water, dry well in the shade.
- Re-install the air filter.

### Air Purifying Filters (Option)

This filter consists of two filters. One is electrostatic filter to remove very fine dust as small as 0.1 micron such as tobacco smoke and pollen etc., the other is deodorant filter to remove unpleasant smell such as food, sweat, and fungus.

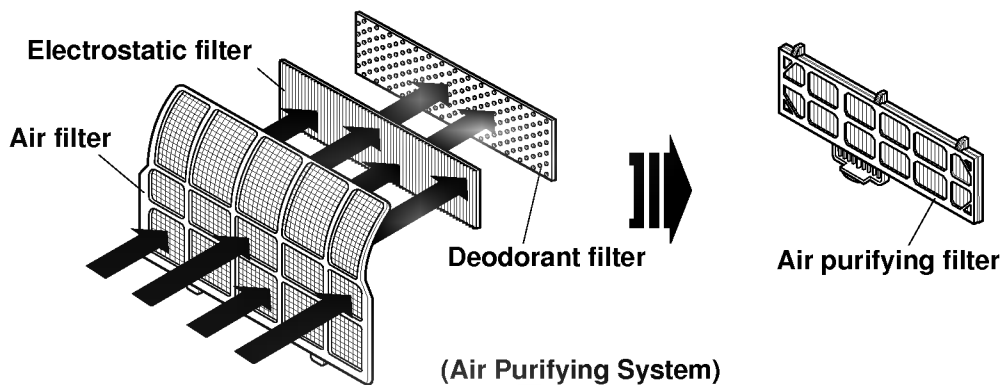

Safety Precautions

Operating Instructions

Care and Maintenance

Troubleshooting Tips



### Replacement of Purifying Filter

• Recommended use period : About 2 years

- Open front panel and remove air filters.

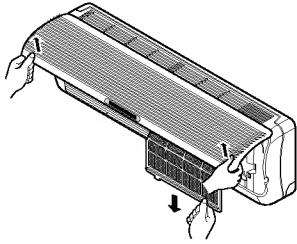

- Remove air purifying filters.

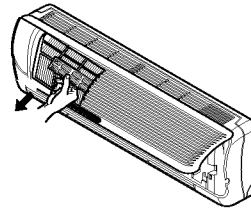

- Insert new air purifying filters.

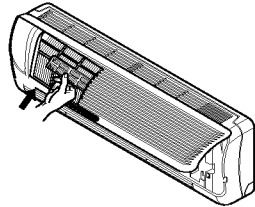

- Reinsert air filters and close front panel.

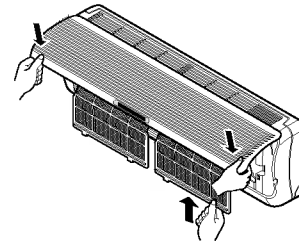

### Outdoor Unit

The heat exchanger coils and panel vents of the outdoor unit should be checked regularly. If clogged with dirt or soot, the heat exchanger and panel vents may be professionally steam cleaned.

**NOTE:**

*Dirty or dogged coils will reduce the operating efficiency of the system and cause higher operating costs.*

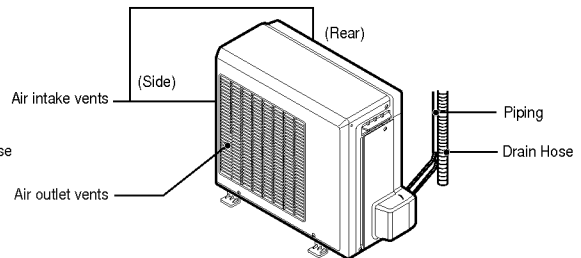
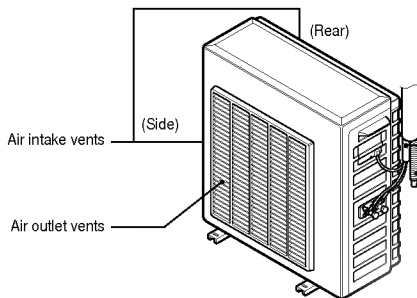
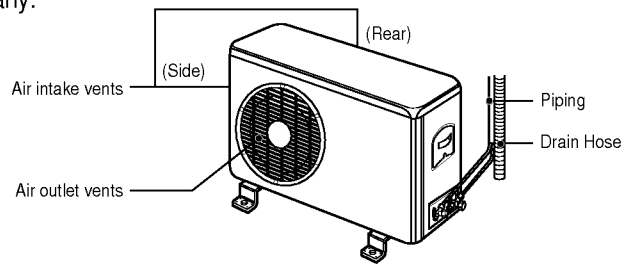

*When the air conditioner is not going to be used for a long time.*

**When air conditioner is not going to be used for a long time.**

- 1 Operate the air conditioner on Air circulation mode (Refer to page 17) for 2 to 3 hours.

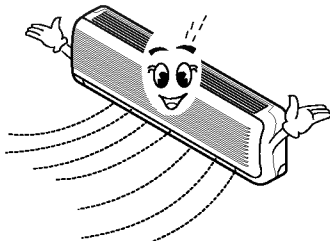

- This will dry out the internal mechanisms.

- 2 Turn off the circuit breaker, and disconnect the plug.

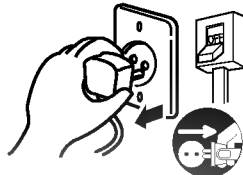

**Turn off the circuit breaker when the air conditioner is not going to be used for a long time.**

Dirt may collect and may cause a fire.

- 3 Remove the batteries from the remote control.

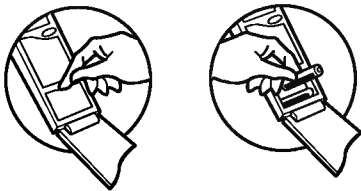

**When the air conditioner is to be used again.**

- 1 Clean the air filter and install it in the indoor unit. (Refer to page 19 for cleaning filters.)

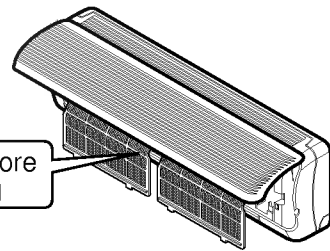

Clean it before installing

- 2 Check that the air inlet and outlet of the indoor/outdoor unit are not blocked.

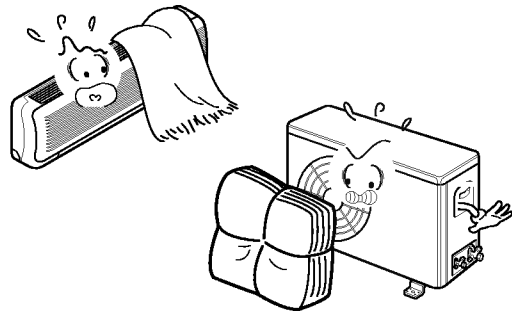

**Helpful information**

The air filters are your electric bill. If the air filters become clogged with dust, the cooling capacity will drop, and 6% of the electricity used to operate the air conditioner will be wasted.

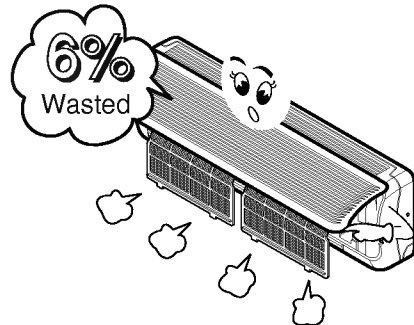

Operation Tips

This is not good for the health and wastes electricity.

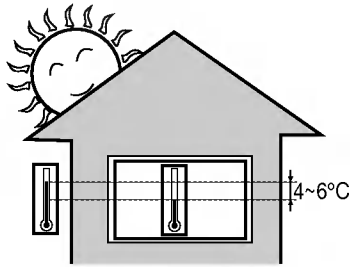

Do not let direct sunshine enter the room when the air conditioner is in operation.

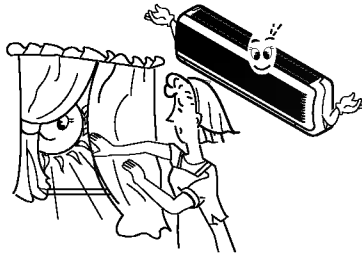

Adjust the vertical and horizontal airflow direction to ensure a uniform temperature in the room.

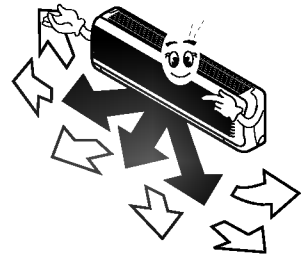

Avoid opening doors and windows as much as possible to keep the cool air in the room.

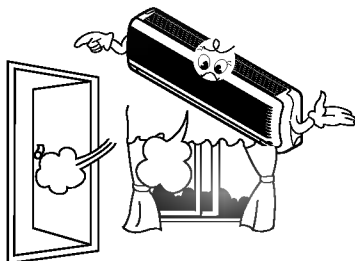

Blockages in the air filter reduce the airflow and lower cooling and dehumidifying effects. Clean at least once every two weeks.

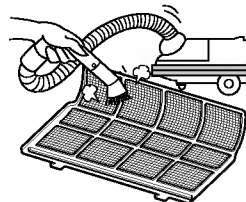

Since windows are kept closed, it is a good idea to open them and ventilate the room now and then.

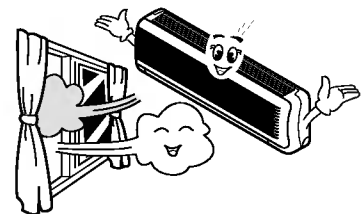



# Before you call for service...

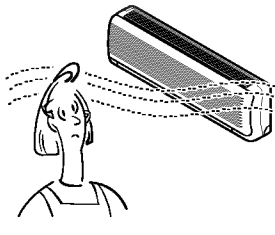
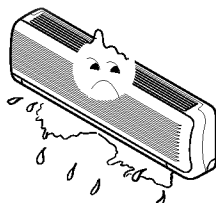
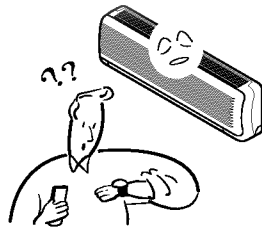
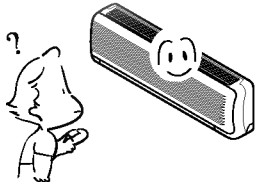
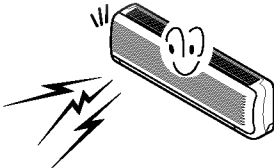

## Troubleshooting Tips! Save time and money!

Check the following points before requesting repairs or service.... If the fault persists, please contact your dealer or service center.

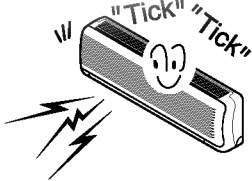
 <ul style="list-style-type: none"> <li>• Have you made a mistake in timer operation?</li> <li>• Has the fuse blown or has the circuit breaker been tripped?</li> </ul>	 <ul style="list-style-type: none"> <li>• Check that this is not a damp smell exuded by the walls, carpet, furniture, or cloth items in the room.</li> </ul>	 <ul style="list-style-type: none"> <li>• Condensation occurs when the airflow from the air conditioner cools the warm room air.</li> </ul>	 <ul style="list-style-type: none"> <li>• This is the protector of the mechanism.</li> <li>• Wait about three minutes and operation will begin.</li> </ul>
 <ul style="list-style-type: none"> <li>• Is the air filter dirty? See air filter cleaning instructions. (Refer to page 19)</li> <li>• Has the temperature been set incorrectly?</li> <li>• Are the indoor unit's air inlet or outlet vents obstructed?</li> </ul>	 <ul style="list-style-type: none"> <li>• For a noise that sounds like water flowing.                             <ul style="list-style-type: none"> <li>-This is the sound of freon flowing inside the air conditioner unit.</li> </ul> </li> <li>• For a noise that sounds like the compressed air releasing into atmosphere.                             <ul style="list-style-type: none"> <li>-This is the sound of the dehumidifying water being processed inside the air conditioning unit.</li> </ul> </li> </ul>	 <ul style="list-style-type: none"> <li>• Are the batteries depleted?</li> <li>• Are the batteries inserted in the opposite (+) and (-) directions?</li> </ul>	 <ul style="list-style-type: none"> <li>• This sound is generated by the expansion/constriction of the front panel, etc. due to changes of temperature.</li> </ul>

### NOTE

**WATER RESISTANT:** The outdoor side of this appliance is WATER RESISTANT. The indoor side is not water resistant and should not be exposed to excess water.

Safety Precautions

Operating Instructions

Care and Maintenance

Troubleshooting Tips





**LG Electronics Inc.**