

Masina de spalat automata

MANUAL DE UTILIZARE

MODELE : WF - 562SPP
WF - 611STP

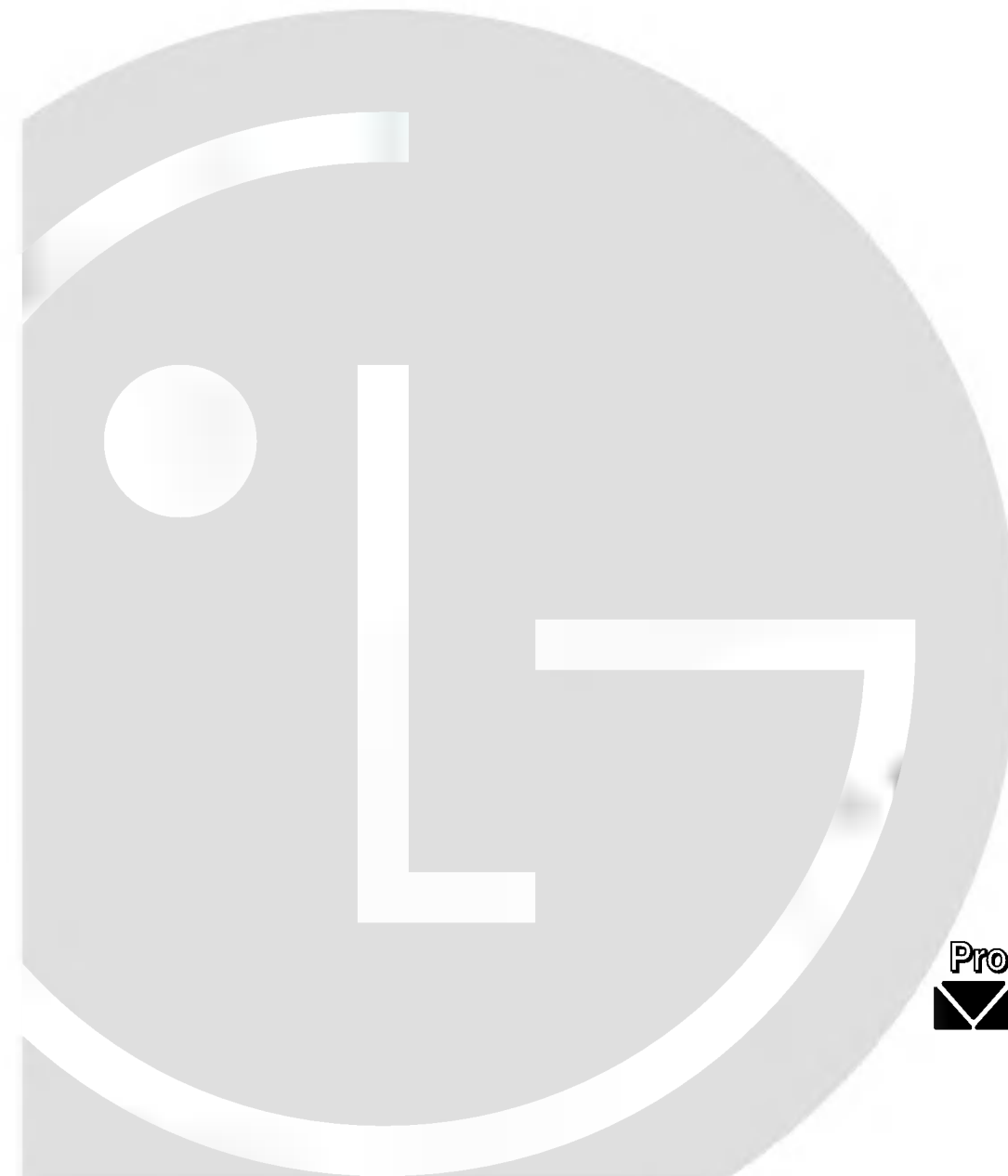

CUPRINS

CARACTERISTICI	3
PARTI COMPONENTE	4
FUNCTIILE SELECTOARELOR	5
INSTALARE	6-8
PROGRAM DE SPALARE	9
ALTE PROGRAME DE SPALARE.....	10-11
ETAPELE PROGRAMARII	12-13
MODURI DE SPALARE SELECTABILE	14
INTRETINERE	15
RECOMANDARI PENTRU PROTECTIE	16
GHIDUL DEFECTIUNILOR.....	17-18
MENTIUNI	19

CARACTERISTICI

- FUZZY
 - ECONOMY
 - SOAK
 - WOOL
- 
- 

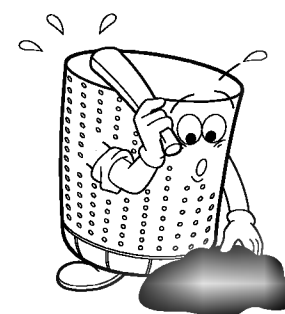
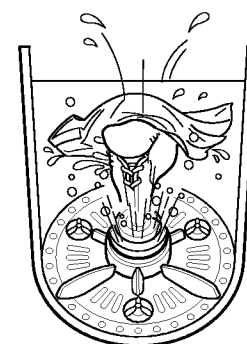

SPALARE NORMALA (FUZZY)

- Apasati butonul AUTO OFF si apoi butonul START.
- Microcomputerul masinii de spalat este activat si va alege cantitatea adecvata de apa necesara spalarii, va intrerupe automat alimentarea electrica si va inchide automat masina de spalat dupa 10 secunde de la terminarea programului de spalare.

NOU MOD DE SPALARE

- Trei mici aripioare genereaza un puternic si concentrat curent de apa ducand la o spalare uniforma a rufelor.
- Ajustarea miscarii verticale si rotationale a impulsului de spalare reduce aglomerarea rufelor si marestea capacitatea de spalare.

PROGRAMARE SI AFISARE

- Programati timpul (intervalul de timp) pana la terminarea programului de spalare pentru a preveni sifonarea rufelor cat timp sunteti plecati (vezi pagina 13).
- Afisarea timpului ramas pana la terminarea procesului de spalare (TIME LEFT & MIN.) sau a intervalului de timp programat pentru terminarea procesului de spalare (RES. & HOUR).

PERETE GURIT (TUBUL) DE SPALARE

- Peretele gaurit (stantat) al camerei, impreuna cu undele ritmice de apa maresc capacitatea de spalare prin impact energetic si prin frecarea rufelor.
- Aditivi anticorozivie biochimica care previn depunerea microbilor in jurul tubului rotativ sunt adaugati in materialul plastic din care acesta este confectionat.

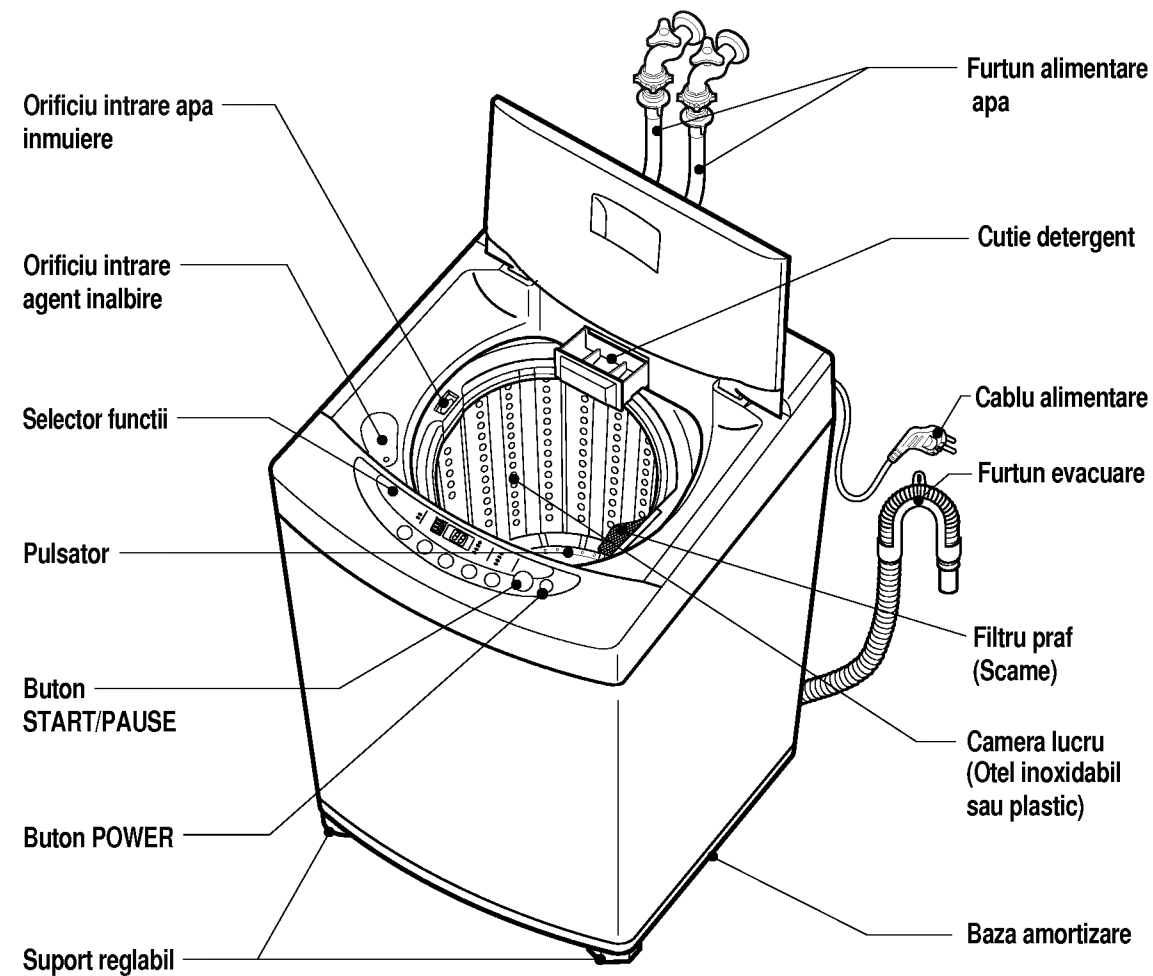

ACCESORII

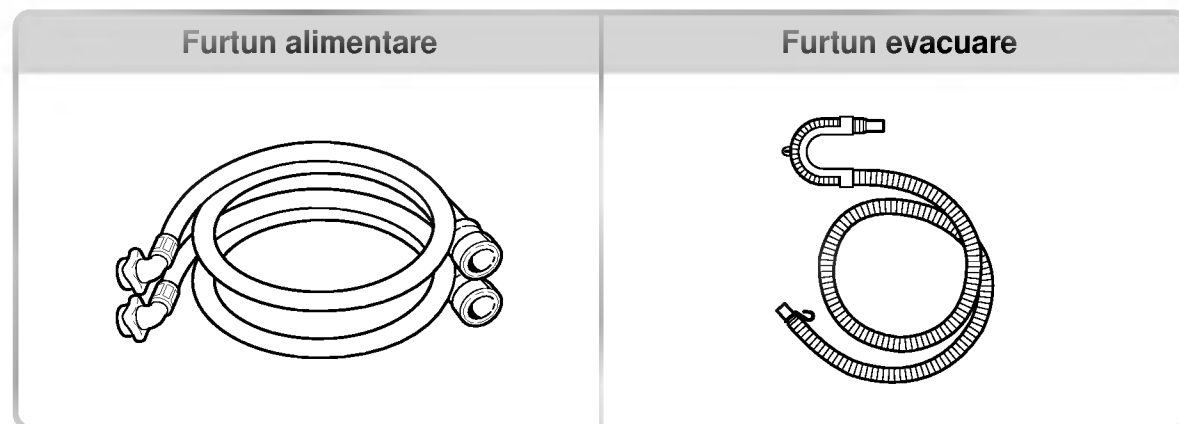

- Daca semnalele sonore va deranjeaza, in special noaptea apasati butoanele PROCESS si PROGRAM in acelasi timp. Semnalizarea sonora va fi reactivata dupa apasarea simultana a butoanelor inca o data.

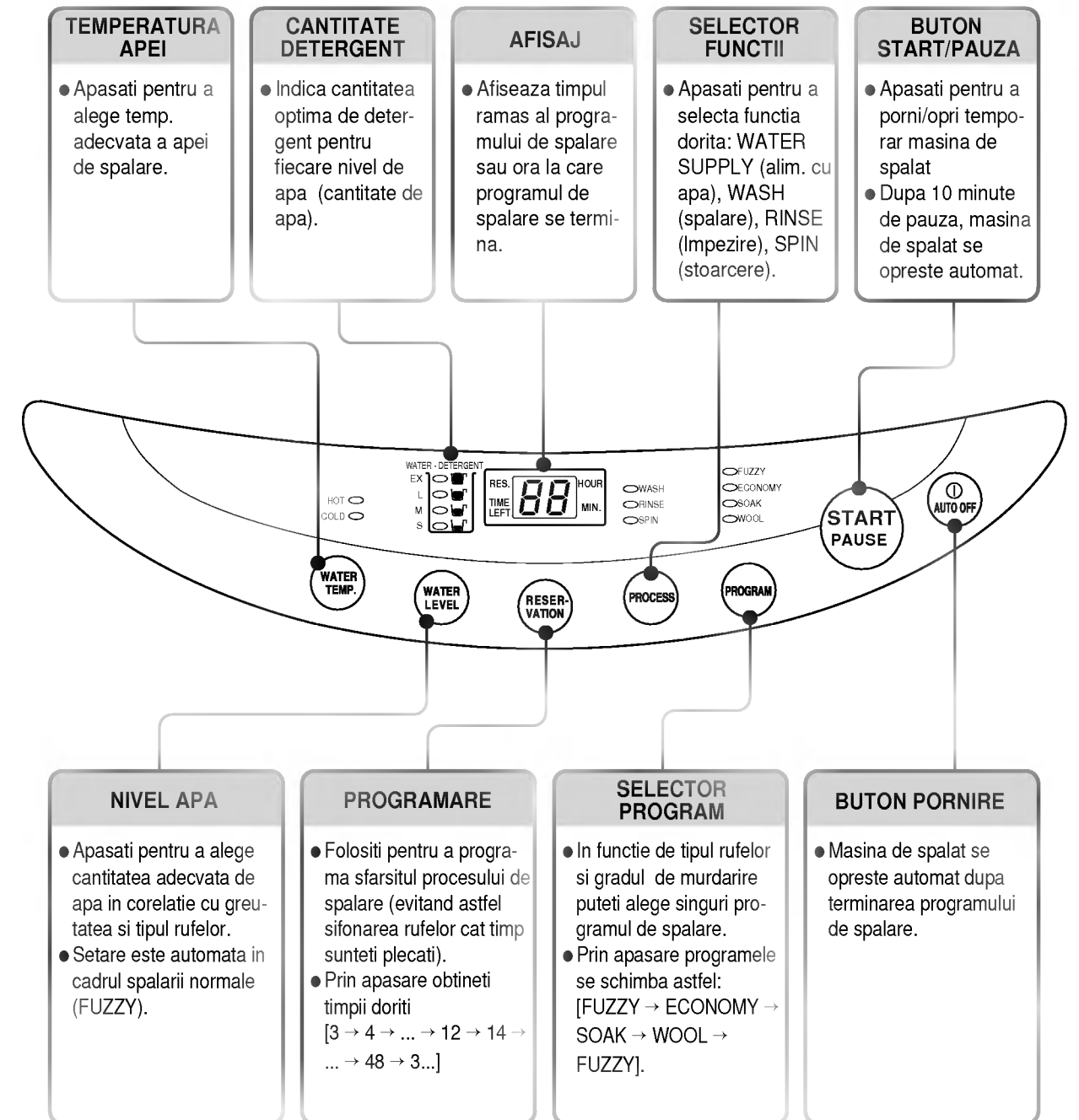

INSTALATI MASINA DE SPALAT PE UN LOC STABIL SI PLAN

- Instalati masina de spalat pe un loc solid si neted.
- Lasati intre masina de spalat si perete cel putin 15 cm pentru a preveni zgomotele in timpul stoarcerii.

- Cand masina de spalat nu este la nivel rotiti de suportul reglabil pentru a o aduce la nivel.

NECTAREA FURTUNULUI DE EVACUARE

- Conectati furtunul de evacuare la orificiul special prevazut la partea din spate a masinii de spalat.
- Fixati furtunul cu clema speciala. Apoi impingeti furtunul in orificiu asa cum se arata in figura.
- Verificati daca furtunul este suficient ridicat pentru evacuare.
- Nu folositi extensii la furtun.
- Inaltimea de evacuare este aproximativ 0.9-1.3 m de la podea.

NECTAREA FURTUNULUI DE ALIMENTARE

- Cum sa conectati furtunul la robinet

Folositi robinetul orizontal.

Robinet orizontal



Robinet extins



Robinet patrat



1 Desfaceti surubul conectorului superior.

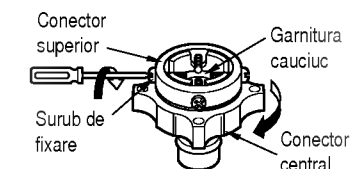

- Daca diametrul robinetului este mare indepartati saiba de ghidare.

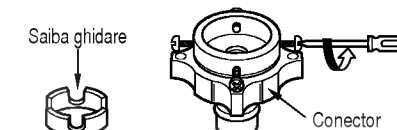

2 Introduceti conectorul superior in robinet pana cand garnitura de cauciuc face contact cu acesta. Strangeti cele 4 suruburi.

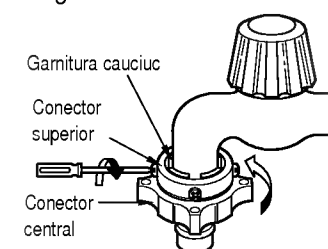

- Rotiti conectorul central astfel incat sa nu aveti scurgeri de apa.

3 Prindeti furtunul de alimentare de conectorul central apasand talerul de ghidare in jos.

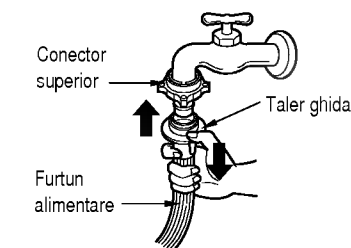

- Pentru a desface furtunul de alimentare de conectorul central opriti apa. Trageți fur tunul in jos, apasand talerul de ghidare

- Conectati furtunul de alimentare la valva de intrare a masinii de spalat iar apoi strangeti-l, rotind conectorul de prindere. Verificati ca garnitura de etansare sa fie in interiorul conectorului.

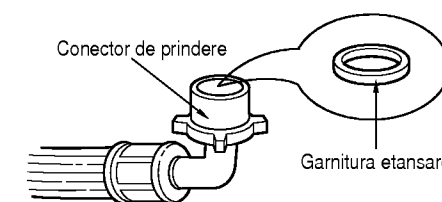
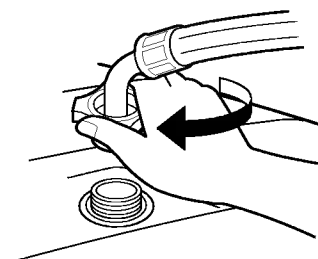

INSTALARE

Cum sa conectati capul de intrare al furtunului

- Rotiti capul de intrare spre dreapta asa cum se arata in figura. Strangeti-l bine pentru a preveni scurgerile de apa.
- Conectati cealalta parte a furtunului la valva de intrare a apei. Evitati scurgerile de apa.
- Verificati ca garnitura de etansare sa fie in interiorul capului de intrare.

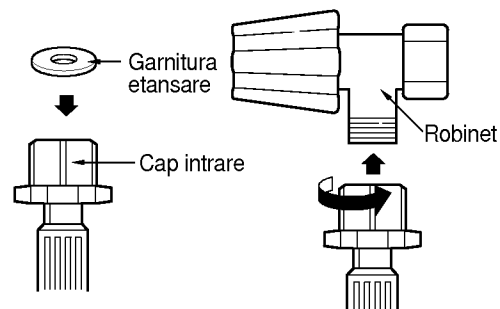



CONNECTAREA LA PAMANT (INPAMANTARE)

- Cablul de inpamantare este instalat pentru a preveni electrocutarile cauzate de descarcarile electrice.
- Cablul de inpamantare este fixat in partea din spate a masinii de spalat. Conectati-l la un robinet de metal. In cazul conectarii la un robinet de plastic efectul este anulat. Cand cablul de alimentare cu curent are inpamantare, aceasta nu mai este necesara.

ATENTIE

- Conectati masina de spalat la pamant inainte de a o conecta la rețeaua de curent.
- Nu conectati niciodata cablul de inpamantare la o conducta de gaz, la un fir de telefon sau la un cablu de curent electric.
- Daca cablul de alimentare este deteriorat, acesta va fi inlocuit cu unul nou similar procurat de la producator sau de la centrul de service. Dupa eventualele modificari ale sistemului de alimentare, toate componentele de izolatie vor fi montate in locul lor initial.
- Fantele de la baza masinii nu trebuie sa fie astupate in cazul in care aceasta este asezata pe un covor.

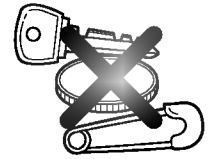
INAINTE DE SPALARE

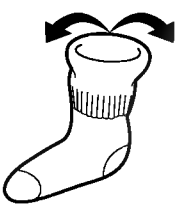
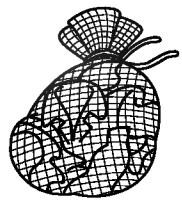
 <ul style="list-style-type: none"> ● Verificati daca rufele sunt lavabile in apa. 	 <ul style="list-style-type: none"> ● Indepartati obiecte ca chei, monede sau ace din rufe. 	 <ul style="list-style-type: none"> ● Spalati rufele colorate si pe cele uleioase separat.
 <ul style="list-style-type: none"> ● Scuturati rufele de praf inainte de spalare. 	 <ul style="list-style-type: none"> ● Spalati rufele pufoase intor candu-le pe dos. 	 <ul style="list-style-type: none"> ● Pentru rufe sensibile folositi o plasa.

PROGRAM DE SPALARE

SPALARE NORMALA (FUZZY)



- Folositi acest program pentru haine normale si nu paturi, haine de lana, lenjerie de corp etc.
- Toate operatiile sunt setate automat de microcomputer.

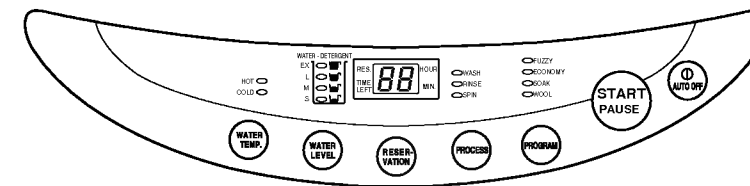

PROCEDURA DE SPALARE

1 Apasati butonul de pornire.

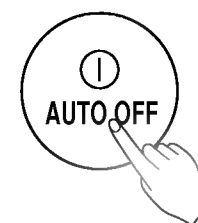

- Cand masina este pornita indicatorul programului normal de spalare (FUZZY) este aprins.

2 Puneti rufele in camera de spalare.

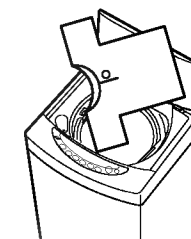

3 Apasati butonul START/PAUZA.

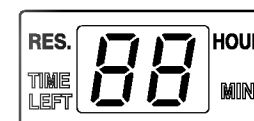

4 Puneti detergent atat cat este indicat pe afisaj sau dupa instructiunile producatorului. Inchideti capul.

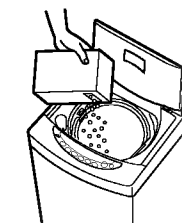
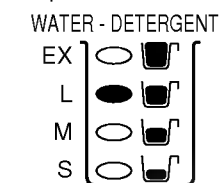

- Alimentarea cu energie este automat intrerupta dupa terminarea programului de spalare.

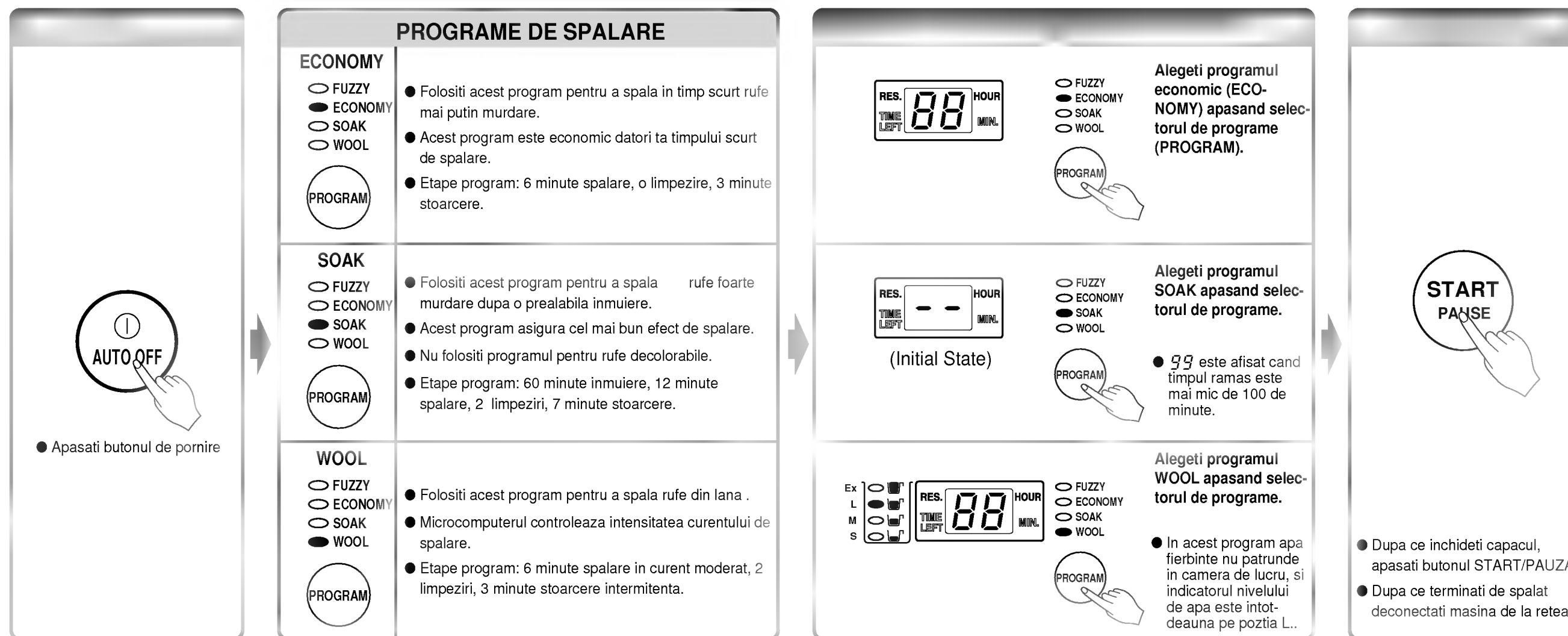

- * **Daca doriti sa schimbati conditiile de spalare selectati-le manual.**
- * **Etapele programelor mai sus mentionate se schimba automat in functie de program.**

- Scoateti rufe.
- Uscati rufe de lana la umbra.
- Deconectati masina de la retea.
- Inchideti robinetul.
- Curatati masina de spalat.

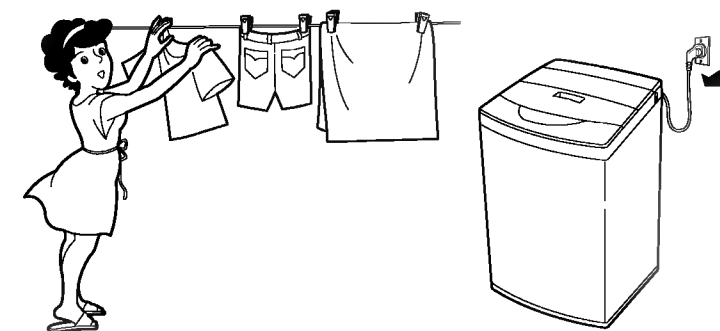

ETAPELE PROGRAMARII

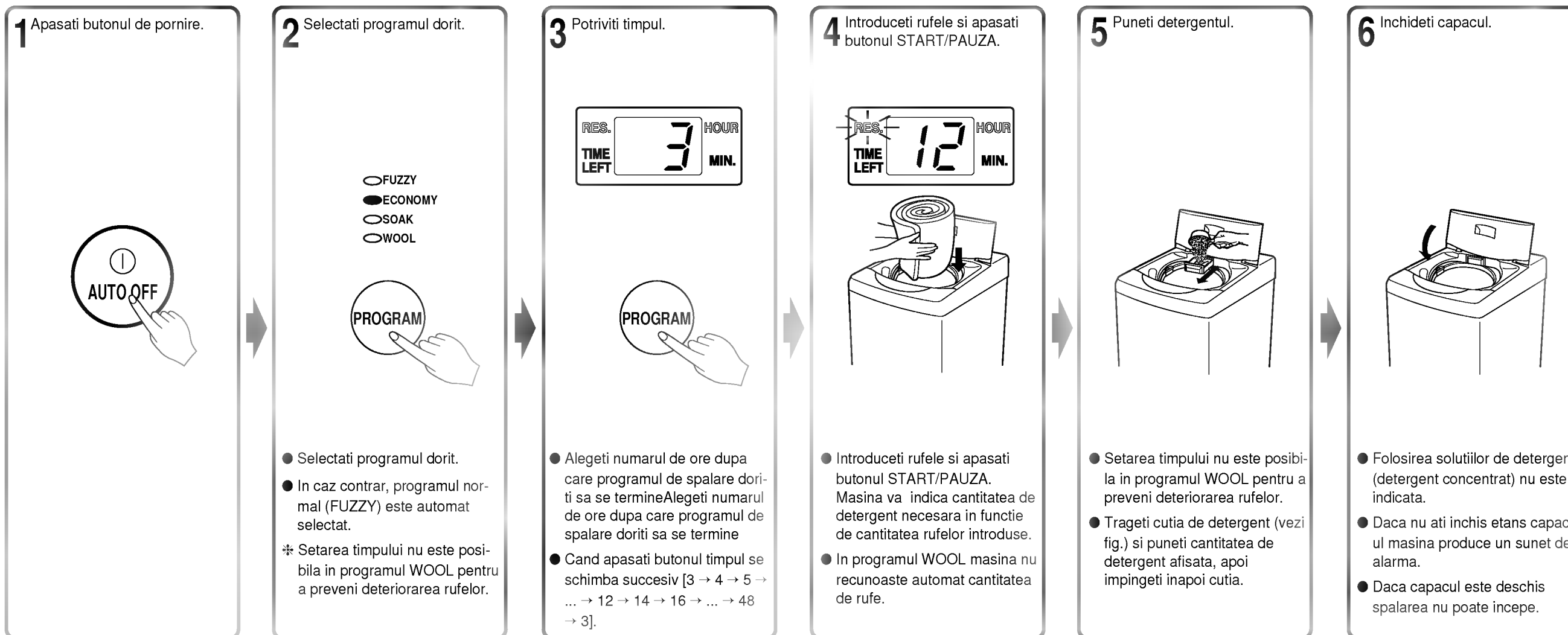

EX. Este ora 7 a.m. Daca doriti ca programul de spalare sa se termine la ora 9 p.m. (21), potriviti timpul ca in figura de mai jos.

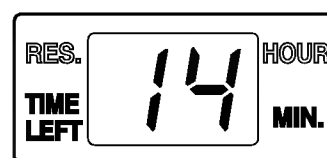

14 ore : 7 a.m. - 9 p.m.

ATENTIE

- Prezenta apei in cutia de detergent poate cauza solidificarea acestuia.
- Nu folositi sapun razuit.
Capacul deschis duce la nefunctionarea masinii si la producerea unui semnal de alarma.
- Daca doriti sa anulati acest program apasati butonul de pornire (AUTO OFF).

MODURI DE SPALARE SELECTABILE

MAI SPALARE

● Apasati butonul de pornire.

● Selectati pozitia WASH (spalare) apasand butonul PROCESS

● Apasati butonul START/PAUZA dupa ce inchideti capacul.

● Spalarea se termina. (In acest moment apa din tub nu este evacuata.)

MAI LIMPEZIRE

! Introduceti lichide deodorante la ultima etapa a limpezirii.

● Apasati butonul de pornire.

● Selectati pozitia RINSE (limpezire) apasand butonul PROCESS

● Apasati butonul START/PAUZA dupa ce inchideti capacul.

● Limpezirea se termina. (In acest moment apa din tub nu este evacuata.)

MAI STOARCERE

● Apasati butonul de pornire.

● Selectati pozitia SPIN (stoarcere) apasand butonul PROCESS.

● Apasati butonul START/PAUZA dupa ce inchideti capacul.

● Spalarea se termina.

INTRETINERE

□ Curatati filtrul valvei de intrare cand alimentarea cu apa este inadecvata sau valva este infundata cu impuritati.

1 Deconectati aparatul de la sursa de curent.

2 Scoateti afara filtrul valvei de intrare (vezi fig.)

3 Folositi o periuta de dinti pentru a indeparta reziduurile. Puneti filtrul la loc.

□ Curatati filtrul de retinere.

1 Scoateti filtrul de retinere din tub tragand in directia indicata de sageata (fig.)

2 Intoarceti-l pe dos pentru a indeparta reziduurile (vezi figura)

3 Puneti filtrul la locul sau initial.

□ Curatati camera pompei cand scurgerea este dificila.

1 Desfaceti cele doua suruburi ale capacului din spate.

2 Rotiti de cap in directia aratata in figura si desurubati-l.

3 Reasamblati capul in directia aratata in figura si insurubati-l.







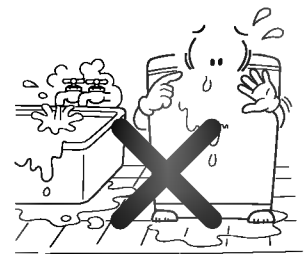

(Vedere de jos)

(Vedere de jos)

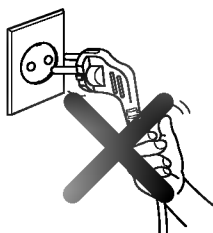



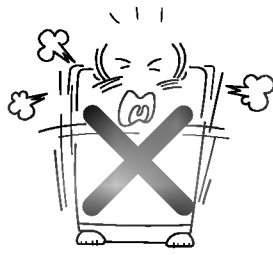

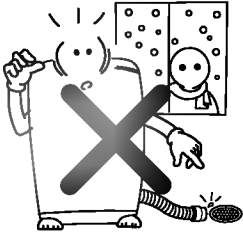

* **ATENTIE.** Dupa montare verificati daca se produc scurgeri de apa. (Garnitura este bine fixata.)

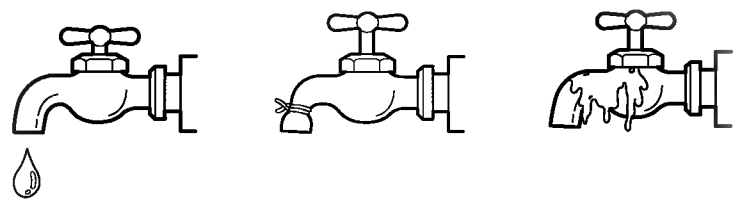
RECOMANDARI PENTRU PROTECTIE

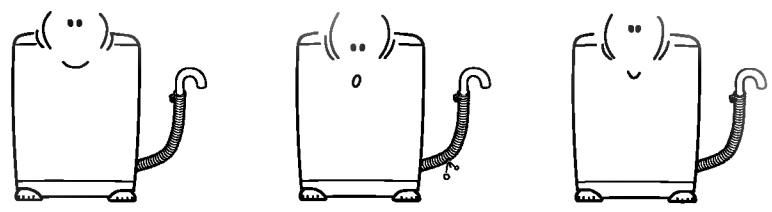

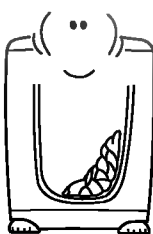
☐ Cititi urmatoarele recomandari pentru protectia si rezistenta in timp a masinii de spalat.

<ul style="list-style-type: none"> ● Nu expuneti masina de spalat razelor solare sau ploii. 	<ul style="list-style-type: none"> ● Nu instalati masina de spalat intr-un loc umed. 	<ul style="list-style-type: none"> ● Nu stropiti butoanele cu apa. 
<ul style="list-style-type: none"> ● Nu folositi o singura priza pentru mai multe aparate in acelasi timp. 	<ul style="list-style-type: none"> ● Cand deconectati de la sursa nu apucati cablul ci stecherul. 	<ul style="list-style-type: none"> ● Nu lasati copiii in preajma masinii de spalat. 
<ul style="list-style-type: none"> ● Pastrati masina de spalat departe de foc sau de surse se foc. 	<ul style="list-style-type: none"> ● Nu turnati soda caustica sau inalbitor pe masina de spalat. Se distruge piesele de cauciuc. 	<ul style="list-style-type: none"> ● Nu turnati in camera de lucru apa cu o temperatura mai mare de 50 0C. 
<ul style="list-style-type: none"> ● Asigurati-va ca ati inchis capacul, mai ales in timpul stoarcerii. 	<ul style="list-style-type: none"> ● Nu bagati mana in camera de lucru. 	<ul style="list-style-type: none"> ● Lasa-ti apa sa curga com plet prin furtunul de evac uare. 

GHIDUL DEFECTIUNILOR

DEFECTIUNE	VERIFICATI
Absenta apei. 	 <p>Robinetul este inchis? Alimentarea cu apa este intrerupta? Robinetul este inghetat?</p>
Evacuarea nu se produce. 	 <p>Verificati daca aveti curent. Furtunul de evacuare nu este inghetat? Furtunul de evacuare este atarnat corespunzator? Inaltimea optima descararii este 0.9 - 1.3 m (pt. pompa).</p>
Stoarcerea nu se produce 	 <p>Cantitatea de rufe este neechilibrata?</p>
Stoarcerea nu se produce 	 <p>Capacul este inchis?</p>
ALTE DEFECTIUNI 	<p>APELATI LA CENTRUL SERVICE.</p>

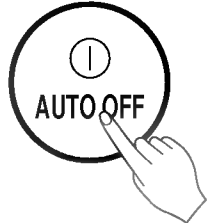
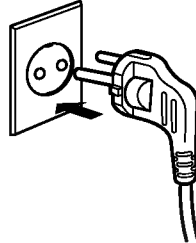
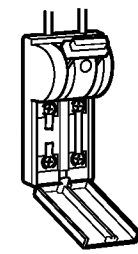
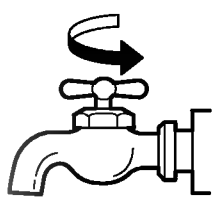
GHIDUL DEFECTIUNILOR

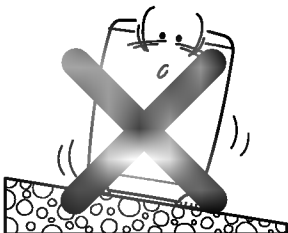
<p>Masina nu are curent.</p>	<div style="display: flex; justify-content: space-around; align-items: center;"> <div style="text-align: center;">  <p>Butonul de pornire este apasat?</p> </div> <div style="text-align: center;">  <p>Stecherul este bagat in priza?</p> </div> <div style="text-align: center;">  <p>Pana de curent? Sigurante arse?</p> </div> </div>
<p>Masina nu functioneaza.</p>	<div style="display: flex; justify-content: space-around; align-items: center;"> <div style="text-align: center;">  <p>Robinetul este inchis?</p> </div> <div style="text-align: center;">  <p>Nivelul apei este normal?</p> </div> <div style="text-align: center;">  <p>A fost apasat butonul START/PAUZA?</p> </div> </div>
<p>Vibratii si zgomot puternic in timpul stoarcerii.</p>	<div style="text-align: center;">  <p>Masina de spalat este asezata pe o suprafata orizontala?</p> </div>

MENTIUNI

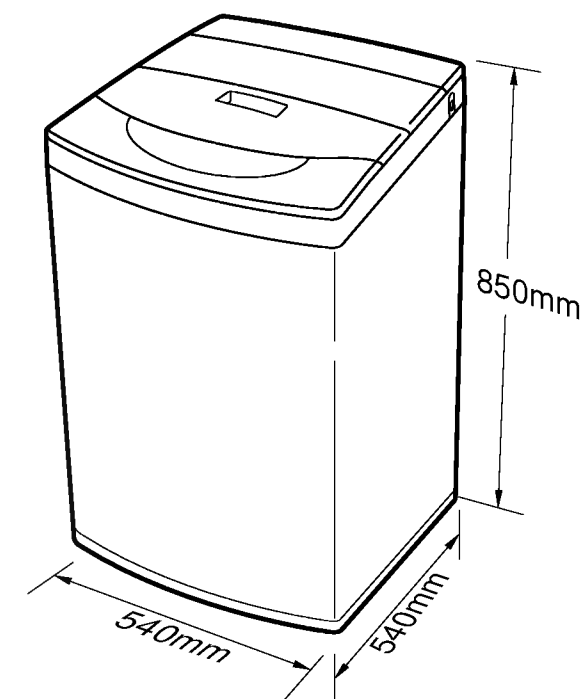

□ ALIMENTARE ELECTRICA	: PE PLACUTA INDICATOARE
□ PRESIUNEA APEI	: 0.3 - 10kgf/cm ² (30 ~ 1000kPa)
□ GREUTATE	: 32 kg
□ DIMENSIUNI	: 540(W) × 540(D) × 850(H)
□ NIVEL STANDARD APA	: FOARTE MARE : 55 litri MARE : 46 litri MEDIU : 33 litri MIC : 24 litri

* Aspectul si caracteristicile pot fi schimbate fara preaviz pentru a mari calitatea produsului.