



**NICAM/Hi-Fi STEREO
Video Cassette Recorder
with ShowView**

OWNER'S MANUAL

MODEL: AF998NY



**Before connecting, operating or adjusting this product,
please read this instruction booklet carefully and completely.**

Precaution & features Information



Position your VCR so that no bright light or sunlight falls directly onto it.

Care should be taken not to expose your VCR to any unnecessary vibration, moisture, dust or heat.

During electrical storms it is advisable to unplug both the aerial cable and mains plug to prevent accidental damage to your VCR and TV.

Do not operate your VCR if it is damaged. Your VCR should not be repaired by anyone except qualified service personnel.

Never remove the back cover of your VCR as this can expose you to very high voltage and other hazards. If your VCR does not operate properly, please check the Troubleshooting Check List (see p.34). If your VCR still does not operate properly, unplug it and call your dealer.



This product is manufactured to comply with the radio interference requirements of EEC DIRECTIVE 89/336/EEC, 93/68/EEC and 73/23/EEC.



Just to name a few examples of the extraordinary features:

- HQ (High Quality)- picture enhancement system
- Programmable 80 channel memory with Frequency synthesised tuner
- ACMS (Automatic Channel Memory System)
- 7 event/1 month programmable timer
- Built-in ShowView programming
- VPS/PDC function
- Recording and playback for 16:9 Wide-screen format
- LP - Long Play - recording & playback
- Shuttle Controls
- Energy Saving function
- ICON OSD (On Screen Display)
- NTSC playback on PAL TV
- Logic & Picture Search
- Child Lock
- Auto Head Cleaner
- Auto Power on and Play
- Fine still, Frame advance & Fixed Slow functions
- Real Time Counter
- Quick Start function
- Auto Tracking System
- Digital Stereo decoder for reception of NICAM Stereo, Bilingual & Mono sound
- Hi-Fi Audio System
- Simulcast Recording



Welcome to LG

Thank you for buying this LG video cassette recorder Model **AF998NY**.

Description	2 - 5	Advanced Operations	24 - 32
Precaution & Features information	2	Timer Recording	24 - 27
Remote Control Location & functions	4	● ShowView Programming	24 - 25
Your VCR's Controls	5	● Timer Recording Using On Screen	
Setting Up	6 - 15	Display	26 - 27
Connecting to a TV	6	Energy Saving	28
Connecting to your Hi-Fi & Camcorder	7	On Screen Display	28
Tuning in a video channel On your TV	8 - 9	Tape Counter Memory Stop	29
How to Using the main menu	10	Child Lock	29
Tuning in TV Stations Automatically	11	Wide Screen Compatibility (16:9)	30
Tuning in TV Stations Manually	12 - 13	Memory Shut-Off	31
Changing the order of TV Stations	14	Self-Diagnosis	31
Deleting TV Stations	15	Hi-Fi Stereo Sound System	32
Basic Operations	16 - 23	Helpful Hints	33 - 34
Playback a tape	16 - 17	Tape Copying	33
Other Playback features	18 - 19	Specifications	33
Recording TV programmes	20 - 21	Troubleshooting Check List	34
To set the Colour System	22		
Setting the Clock Manually	23		

Table of Contents

Remote Control Location & functions

To install batteries:

Your REMOTE CONTROL HANDSET is powered by two AA type batteries.

1. To insert them, push the tab backwards and lift off the cover of the handset.
2. Put the two batteries into the compartment making sure the + and - are correctly positioned.
3. Replace the cover.

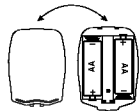

Your video recorder (VCR) is designed so that almost all of its features can be controlled from the REMOTE CONTROL HANDSET. Some features can also be controlled from the FRONT PANEL of the video recorder. The maximum operating distance that you may control your video recorder is about 7.5 metres (25 feet). It must also be within an angle of 30 degrees either side of the REMOTE SENSOR on the front of your video recorder.

To avoid damage from possible battery leakage, remove the batteries if you do not plan to use the remote control handset for an extended period of time. Do not use batteries of differing age or type. Always discard batteries safely.

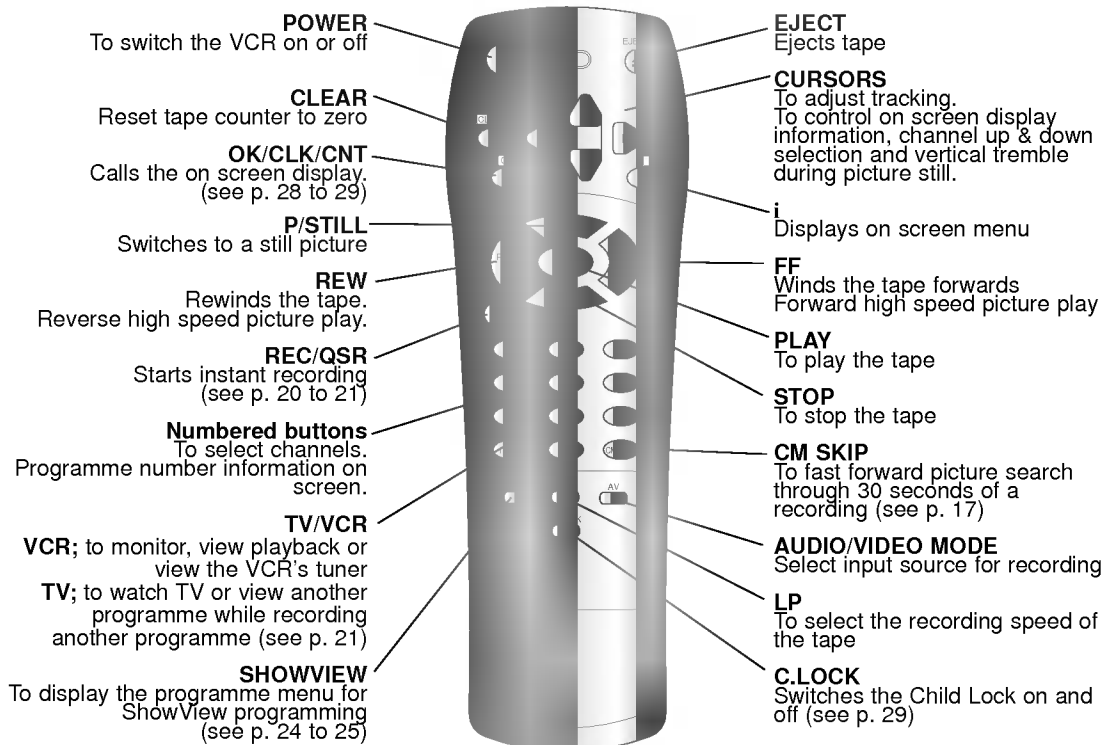

YOUR VCR'S Controls



Each button on your VCR has the same function as its corresponding button on the remote control handset.

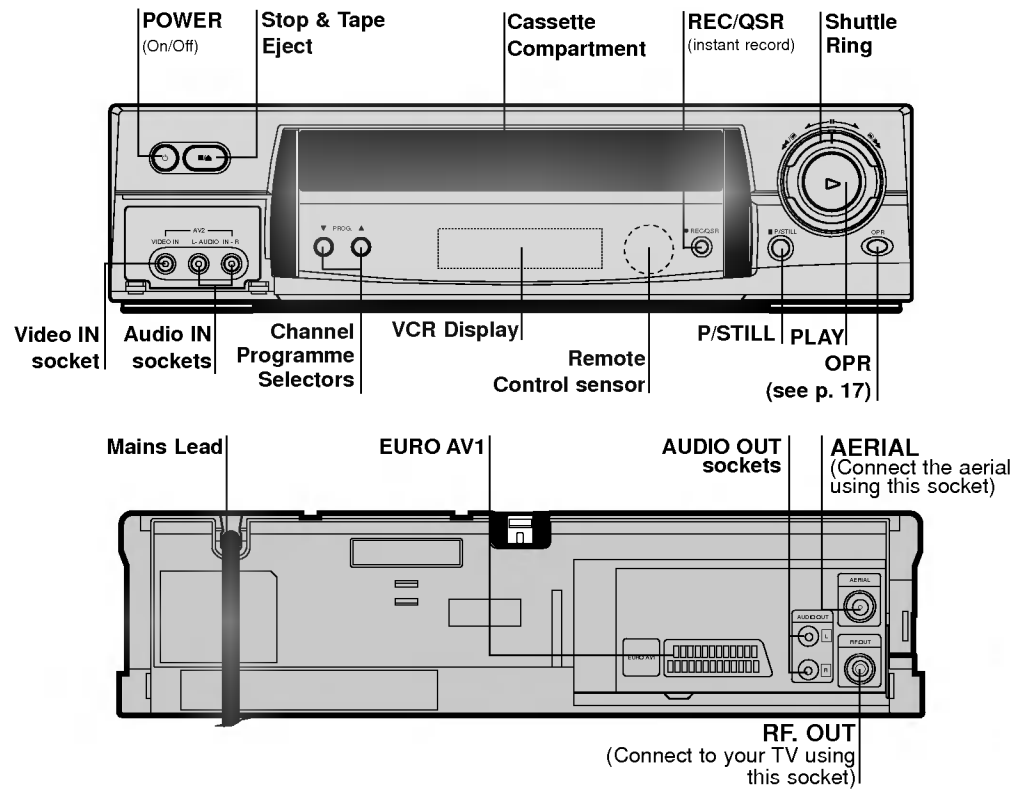

Connections To a TV

Using your VCR very first time

Following picture will display on the TV screen when you have just connected your video recorder for the very first time.

To make tuning TV stations, please follow stages 3 to 4 as shown "ACMS" (see p. 11).

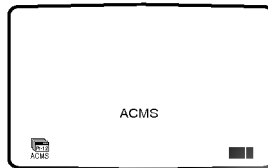

The guidance given on the next two pages is the most common forms of connection. However please check with your manufacturers instruction books for specific information. Make sure all connections are made with both your VCR and additional appliance unplugged from the mains to avoid damaging your equipment. To enjoy playing back you must connect the VCR to the TV using a SCART lead.

All connections must be made with both your VCR and TV unplugged from the mains.

Television

Back view of your VCR

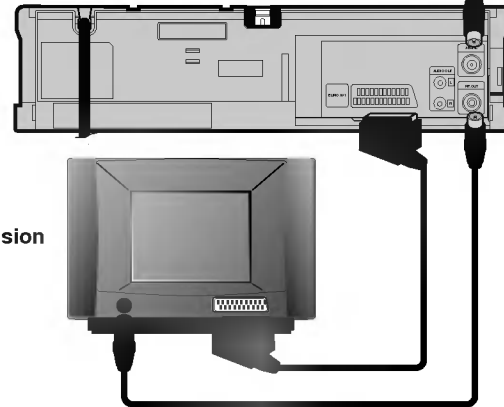

Aerial

The quality of the sound and picture can be greatly influenced by the positioning, quality and state of repair of your external aerial.

Aerial Connection Cable (75 ohms)

Do not try and force the connector into place, it should plug in easily.

An audio system can be connected to the AUDIO OUT sockets on the back of your VCR. Please remember to turn the volume to minimum on your Hi-Fi, then gradually increase the volume; this will prevent damaging your speakers and save you from an extremely noisy shock!

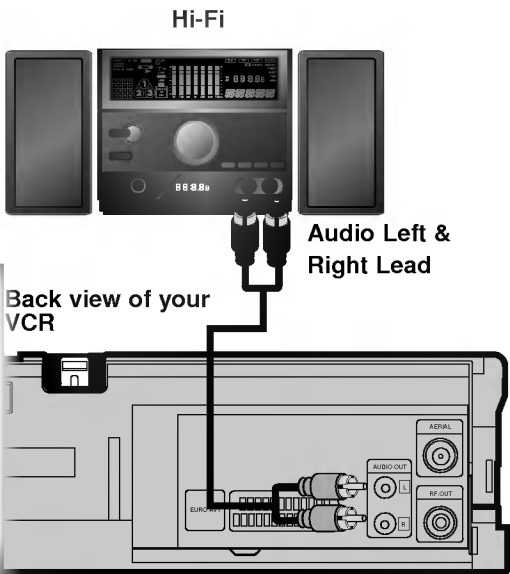

Audio out sockets & Phono Leads

The phono sockets for connecting your VCR to your Hi-Fi are on the back of the set; L = Left sound output, R = Right sound output. You normally have to select the AUX function on your Hi-Fi.

Make sure all connections are made with both your VCR and camcorder unplugged from the mains to avoid damaging your equipment. To make connecting your camcorder easier we have designed the Audio IN (Left and Right) and Video IN sockets on the front panel of your VCR.

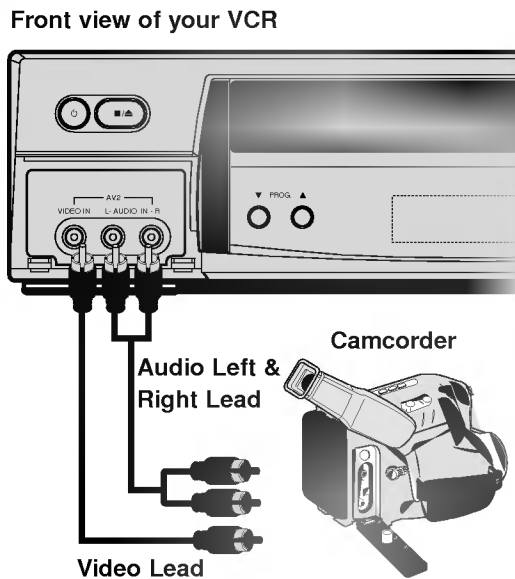

**Connections
To your Hi-Fi &
Camcorder**

Tuning in a Video channel On your TV

The output frequency of this video recorder (VCR) is set at UHF channel 36. If channel 36 is already used by another TV station, or if the picture is distorted, you can change the transmitter channel of your VCR. Stages 5 ~ 8 will show you how to change the output frequency of your VCR.



Your TV receives signals from the video recorder (VCR) like another TV station. You have to select a channel number on your TV and tune it in so that you may watch video tapes. If you have used **SCART** or **AUDIO** and **VIDEO** cables then your TV should already have a dedicated video channel built into it, usually called **AV**.

1

Make sure that you have correctly installed your VCR as described earlier in this book.

Press **POWER** to turn on your VCR.

Turn on your TV.

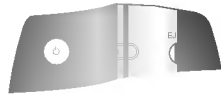

2

Insert a pre-recorded video tape into your VCR and press **PLAY** on the remote control.



Select a TV channel number on which you wish to watch video's.

Don't worry if you don't have a video-tape to play at this stage! If you switch your VCR on and continue stages **3 ~ 4**, instead of seeing video playback tune your TV until you see a bright blue screen.

3

Tune this channel until the video picture is sharp and the sound is clear.

If you have used a **SCART** or **AUDIO** and **VIDEO** cables you will not have to tune your TV, simply select the **AV** channel. The **AV** channel is already pre-tuned for optimum video playback on your TV.

4

Store this channel on your TV.

You will need to look at the TV instruction book if you do not know how to do this.

5

Only carry out stages 5 ~ 8 if you cannot obtain clear video playback as described in stages 1 ~ 4.

Select a TV channel number on which you wish to watch video's.

Make sure that your VCR is in **STANDBY** (only the clock will be displayed).

6

Hold down both **PROG. ▲** and **▼** on the front of your VCR for more than 4 seconds.

RF C36 will appear in the VCR display.

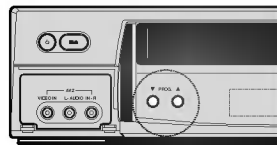

7

Press **PROG. ▲** or **▼** to select another video channel.

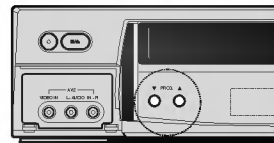

You may select any channel number between 22 and 68, until the test pattern shown the below is appeared.



8

Select a TV channel number on which you wish to watch video's.

Tune this channel so that a bright blue screen appears.

Store this channel on your TV.

Press **⏻** on the front of your VCR when you have finished.

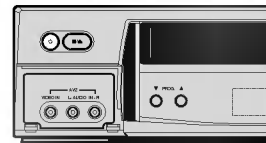

Make sure that you have correctly installed your VCR and successfully tuned in a dedicated video channel on your TV. If you do not tune in a dedicated video channel on your TV you will be unable to view and record video tapes!

How to Using the main menu



This VCR can easily be programmed by using the menus displayed on screen. The menus are controlled from the REMOTE CONTROL HANDSET.

1

Switch on your TV set and video recorder by pressing the **POWER** button.



2

Press **i** button.
The main menu will appear on the TV screen.



3

Press **◀** and **▶** to select the desired menu.
Press **OK** and press **▲** or **▼** to select.



4

Press **"i"** to return to a TV picture.

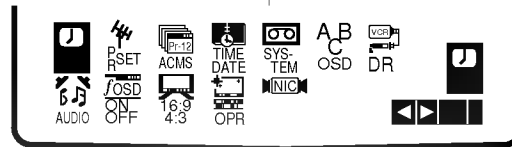

LANGUAGE SELECTION

You can select the language among English, Russian, Deutsch, Français, and Polski.

- **REC** - Timer recording setting (see p. 26 to 27).
- **PR SET** - Manual tuning setting (see p. 12 to 13).
- **ACMS** - ACMS (Automatic Channel Memory System) (see p. 11).
- **TIME DATE** - Date & clock setting (see p. 23).
- **SYSTEM** - To set the Colour TV System (see p. 22).
- **ABC OSD** - To change the language setting for OSD (see left).
- **DR** - To check a problem with your VCR (see p. 31).

- **AUDIO** - To select the channel for audio output (see p. 32).
- **RF AUDIO** - To select the channel of audio output according to your TV type ("D/K" for PAL D/K TV, "B/G" for PAL B/G TV).
- **OSD ON/OFF** - To display the operational mode of your VCR (see p. 28).
- **16:9/4:3** - To select the aspect ratio of your TV (see p. 30).
- **OPR** - To improve the playback picture (see p. 17).
- **NIC** - To activate or deactivate the NICAM digital sound (see p. 32).



If the TV broadcast signal is weak your VCR may not detect the necessary information and will be and to store them correctly. To overcome this problem please turn to the **MANUAL TUNING** section on page 12 to 13.

1

Press **POWER** to turn on your VCR.

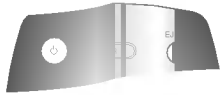

2

Press **i**.

The main menu will appear on the TV screen.

Press **◀** or **▶** to select the **ACMS**.

Press **OK**.

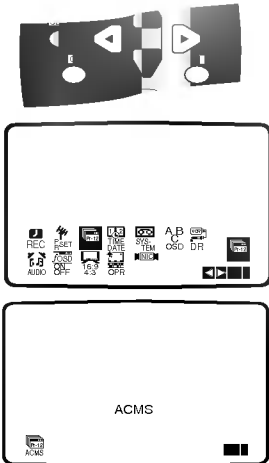

3

Press **OK** again to start the automatic tuning process.

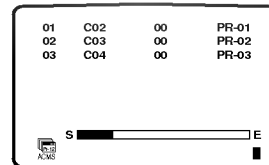

4

The **TV STATION TABLE** will appear when tuning is complete.

If **"PLEASE CHECK"** appears on the TV screen after automatic tuning starts, please make sure that you have connected the aerial cables correctly.

Press **i** to save your settings.

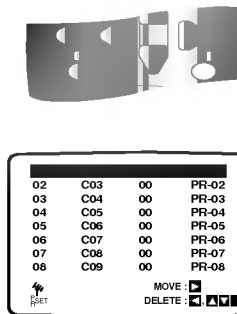

Tuning in TV Stations Automatically

Tuning in TV Stations Manually



In certain areas of the country broadcast signals may be too weak for your VCR's automatic tuning process to find or assign TV stations correctly. You must tune in these weaker broadcast stations manually in order for your VCR to store them.

1

Press **i**.

The main menu will appear on the TV screen.

Press **◀** or **▶** to select the **PR SET**.

Press **OK**.

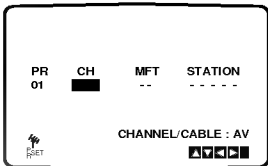
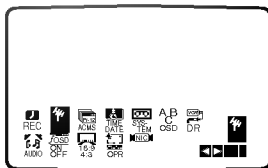
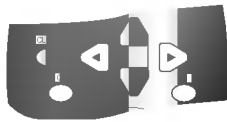

2

Press **AV** to select **C** (Standard stations) or **S** (Cable stations): C02 - C71, S01 - S41.



Repeatedly press **▲** or **▼** to tune in the TV station.

If you know the broadcast station number of your particular TV station you may enter its number directly by using the number buttons on the remote control.

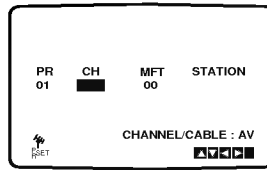

3

Press **▶** to select **MFT**. Press **▲** or **▼** to adjust.

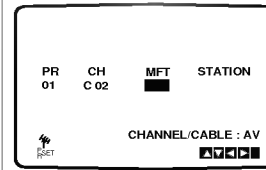

4

Press **▶** to select **STATION** so that you may name your TV station.

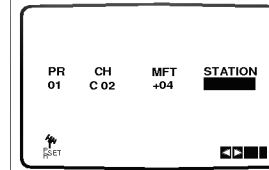

5

Press OK.

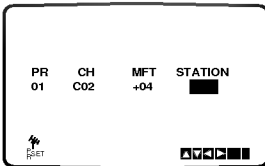

6

Press ▲ or ▼ to select **letters** and **numbers** for the new station name.

Press ◀ or ▶ to move back and forth between characters.

Press OK.

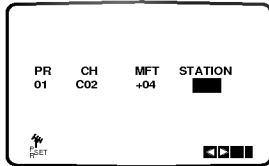

7

Press i, confirm the station placement.

If you wish to manually tune other stations repeat stages 1 - 7.

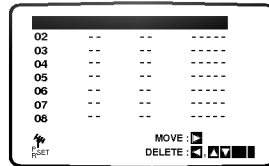

8

Press i again.

Your new TV station has now been tuned into your VCR.



Changing the order of TV Stations



After tuning TV stations into your VCR you may wish to **change** the order in which they are stored without having to retune them against! The instructions given on this page will show you how you can simply move them into your desired order.

1

Press **i**.

The main menu will appear on the TV screen.

Press **◀** or **▶** to select the **PR SET**.

Press **OK**.

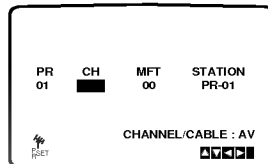
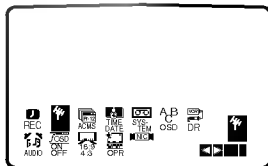
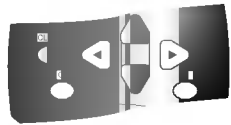

2

Press **i**.

Press **▲** or **▼** to select the **programme number** you want to move (for example, PR 03).

Press **▶**.

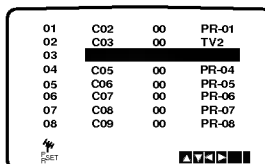
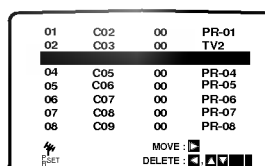

3

Press **▲** or **▼** to select the **programme number** you want to move to (for example, PR 05).

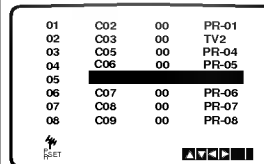

4

Press **OK**.

The selected **programme** will be moved to the **new programme number**.

If you wish to move other TV stations repeat stages 1 - 4.

Press **i** to remove the menus from the TV screen.

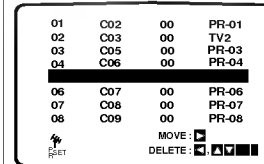



After tuning TV stations into your VCR you may wish to **delete** a station.
The instructions given on this page will show you how easily delete any unwanted TV stations.

1

Press **i**.

The main menu will appear on the TV screen.

Press **◀** or **▶** to select the **PR SET**.

Press **OK**.

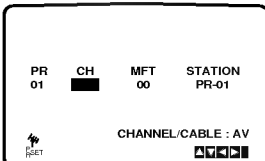
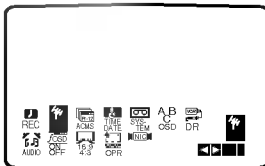

2

Press **i**.

Press **▲** or **▼** to select the **programme number** you want to delete.

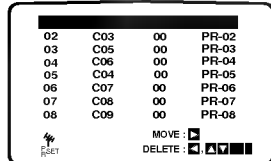

3

Press **◀**.

After a short while, the selected station will be deleted.

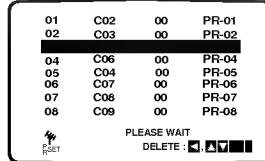

4

Press **i** to remove the menus from the TV screen.

If you wish to delete other TV stations repeat stages **1 - 3**.

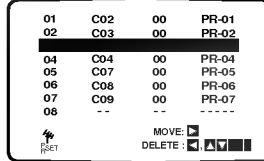

Deleting TV Stations



How to selecting Stored TV stations:

Stored TV stations can be selected in either of two ways.
Press **▲** or **▼** to select different stations that are tuned into your VCR.



You may also directly select stations using the **numbered buttons** on the remote control.

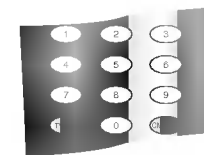

Playback a tape



You will only be able to load and eject video cassettes when your VCR is plugged into the mains. Your VCR may also playback recordings from NTSC tapes (on PAL TV).

1

Make sure that you have correctly connected your VCR as described earlier in this book.

Turn on your TV.

Press **POWER** to turn on your VCR.



2

Insert the video cassette into your VCR.

The video cassette should have the window side facing up and the arrow facing away from you.

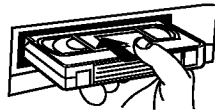

3

Press **PLAY** to start playing your tape.



If you load a video cassette which has had its record protection tab removed (playback of the cassette will start automatically).

AUTO TRACKING

Your VCR will automatically adjust the tracking to give the best picture quality. **A.TRK** will appear in your video recorder's display while it is doing this.

4

Press **P/STILL** to still a picture.

Press **P/STILL** repeatedly to advance the tape frame by frame.



Tapes can be paused for up to 5 minutes. After 5 minutes your VCR will stop the tape to prevent damaging the tape or your VCR .

Still picture quality can be improved slightly by pressing **▲** or **▼**.



5

Press **PLAY** to continue playing your tape.

Picture search:

During playing back press either **FF** or **REW** to this will enable you to rapidly wind the tape (7 times normal playback) see where you are on the tape.

Logic search:

During fast forwarding or rewinding press and hold **FF** or **REW** the picture will be played back at 7 times normal playback speed.



6

Press **STOP** to end playback.



Press **EJECT**.

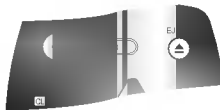

If the end of the tape is reached, your VCR will stop playback automatically, rewind, stop, eject the tape and place itself into power off mode.

CM (Commercial Message) Skip:

This feature enables you during playback of a tape to skip a commercial break in a few seconds, then resume normal playback.

While tape is playing press **CM SKIP** on the remote control to skip commercial (or another programme material).



Repeatedly press **CM SKIP** to skip:

- 1 Press 30 seconds
- 2 Press 60 seconds
- 3 Press 90 seconds
- 4 Press 120 seconds
- 5 Press 150 seconds
- 6 Press 180 seconds

OPR (Optimum Picture Response):

This feature automatically improves playback picture quality by adjusting your VCR to the condition of the tape.

Press **i**.

Press **◀** or **▶** to select **OPR**.

Press **OK**.

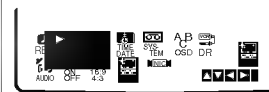

Press **▲** or **▼** repeatedly to select: **OFF**, **SOFT** or **SHARP**.

Please note you may only set **OPR** when playing a tape.

Press **i** return to screen.



During playback of a video cassette you can select picture sharpness by pressing **OPR** on the front of your VCR.

Press 1:
To make a picture **softer**.

Press 2:
To make it **clearer**.

Press 3:
To switch off.



Other Playback features



Your VCR incorporates a number of tape search features that enable you to quickly search a tape for your particular recording. The use of the **SHUTTLE RING** allows you to find a scene by playing the tape in forward and reverse directions.

1

During playing back or still picture press ◀ or ▶ repeatedly to obtain different playback speeds.

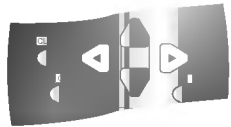

2

Press ▲ or ▼ to improve picture quality.



3

Press **PLAY** to play your tape back at normal speed.

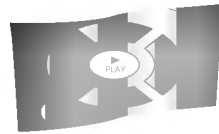

You may also visually search (when playing) a tape or rapidly search a tape (after pressing **STOP**) by using the **SHUTTLE RING**.

Turn the **SHUTTLE RING** clockwise to go forward.

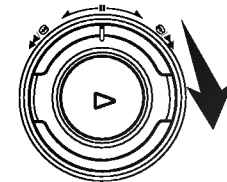

Turn the **SHUTTLE RING** counterclockwise to go backward.

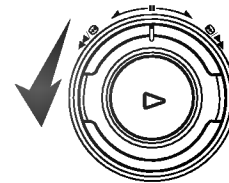

4

Press **STOP**.

STOP will appear for a few seconds on the TV screen.



Fast Forward (FF):

Press **FF**.
The tape will rapidly wind forwards.

FF will appear for a few seconds on the TV screen.



You may also rapidly wind a tape turning the **SHUTTLE RING** clockwise to fast forward.

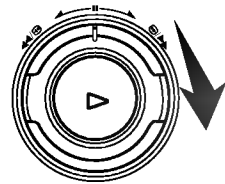

Rewind (REW):

Press **REW**.
The tape will rapidly wind backwards.

REW will appear for a few seconds on the TV screen.



You may also rapidly wind a tape turning the **SHUTTLE RING** counterclockwise to rewind.

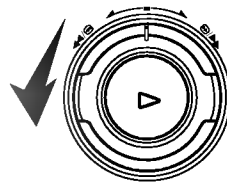

If during fast forward you turn the **SHUTTLE RING** clockwise you will be able to briefly view the picture.

If during rewinding you turn the **SHUTTLE RING** counterclockwise you will be able to briefly view the picture.

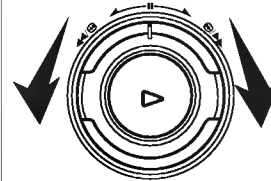

Recording TV programmes

If you do not wish to record on a tape (this can happen quite easily by accident!) remove the protection tab on the back edge of the video cassette.

It is possible to record on a video cassette with the record protection tab removed by covering the hole with self adhesive tape.

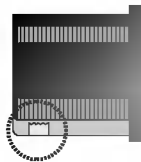
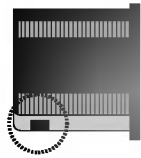

Your VCR allows you to make recordings using a variety of simple methods:
Quick Set Recording (QSR) start recording immediately for a set period of time or until the video cassette runs out.

1

Make sure that you have correctly connected your VCR as described earlier in this book.

Press **POWER** to turn on your VCR.

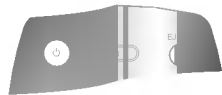

2

Insert a video cassette with protection tab into your VCR.

The video cassette should have the window side facing up and the arrow facing away from you.

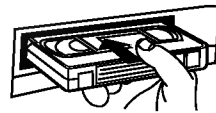

3

Press **▲** or **▼** to select the **programme number** you wish to record.



You may also directly select programme number using the **numbered buttons** on the remote control.

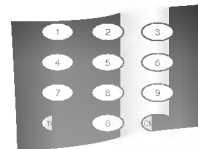

4

If you wish to record directly from the SCART or AUDIO sockets repeatedly press **AV** until the socket you wish to record from is displayed.



SC01 Hi-Fi Sound only recording using the AUDIO IN sockets on the front of your VCR.

AV 1 Sound and Picture recording using the SCART socket on the back of your VCR.

AV 2 Recording from VIDEO IN and AUDIO IN (Left & Right) using the sockets on the front of your VCR.



Your VCR incorporates Long Play (LP) which enables you to record up to twice the amount of time on a video cassette. For example an E-180 will record up to 180 minutes using Standard Play (SP); using LP you will be able to record up to 360 minutes. **Please note** there will be a slight loss in picture and sound quality when using LP.

5

Press **LP** if you wish to record in Long Play or Standard Play.

SP will produce improved picture and sound quality, however LP will provide twice as much recording time as SP.

SP or LP will be displayed in your VCR display to let you know which you have selected.

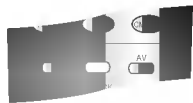

6

Press **REC/QSR** to start recording.

RECORD will appear on the TV screen.

Press **REC/QSR** several times. Each successive press will increase the record time by 30 minutes until you reach a maximum of 9 hours.



7

Press **P/STILL** to avoid recording unwanted scenes.

Press **P/STILL** to continue recording.

Tapes can be paused for up to 5 minutes; RECP will be displayed when a tape is paused. After 5 minutes your VCR will stop recording to prevent damaging the tape or your VCR.

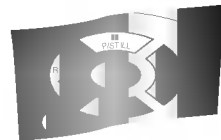

8

Press **STOP** to end recording.

Press **EJECT**.

EJECT will appear on the TV screen and on the video recorder's display for a few seconds.

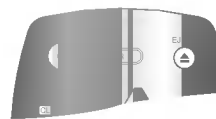
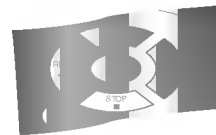

Remember you can record one programme while watching another by starting your instant recording, press **TV/VCR** to select TV mode and then selecting a different channel on your TV.

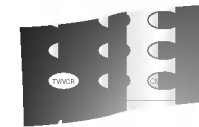



The clock in your VCR controls time and date settings for your VCR.
For ShowView to work correctly the current time and date must be set.

1

Press **i**.

Press **◀** or **▶** to select
TIME DATE.

Press **OK**.

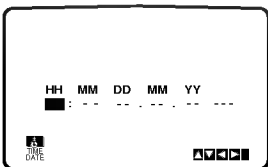

2

Use the **numbered buttons** on the remote control to alter the **HOURS, MINUTES, DAY, MONTH** and **YEAR**.

Please note your VCR uses a 24 hour clock.
e.g. 1pm will be displayed as 13:00.

The day of the week will appear automatically when you enter the year.

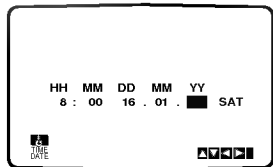
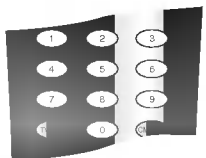

3

If you make a mistake press **◀** or **▶** and enter the correct details.



4

Press **i**.

Your new clock settings are stored and will appear on your video recorder's display.

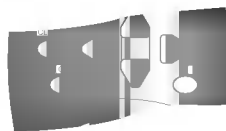

Setting the clock Manually

ShowView IF Programming ADVANCED



ShowView greatly simplifies entering the date, channel, start and end times of a Timer Recording by simply entering a ShowView Code. ShowView Codes are published in most TV guide magazines; they can vary one to nine numbers in length.

Timer Recording you may record at a later time (up to 1 month from the present). Up to 7 of these automatic recordings may be set.

1

Make sure that TV channels have been tuned and stored in correct SHOWVIEW order.

Insert a video cassette with protection tab into your VCR.

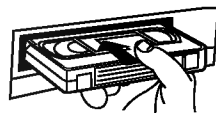

2

Press **SHOWVIEW**.

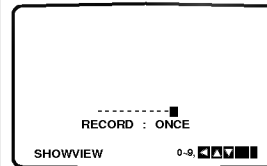
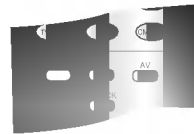

3

Press **▲** or **▼** to select the recording type.

ONCE: To record once.

WEEKLY: To record at the same time every week.

DAILY: To record every day (except Saturday and Sunday) at the same time.

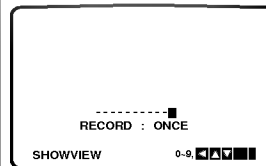

4

Press the **numbered buttons** to enter the **ShowView Code** of the TV programme that you wish to record.

If you make a mistake press **◀** then enter the revised number.

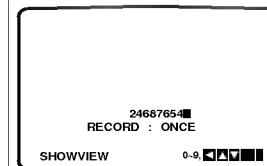
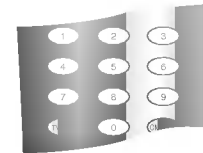



SHOWVIEW is a registered trademark of Gemstar Development Corporation.
The SHOWVIEW System is manufactured under licence from Gemstar Development Corporation.

5

Press **OK**.

If **PLEASE CHECK** is displayed it means that you have entered the wrong ShowView number, entered the ShowView number incorrectly.

If "- ." is displayed, you have to enter the programme number of the station, you want to record from.



PR	DATE	TIME	SP
█	12	10:11-11:55	SP
--	--	-----	SP
--	--	-----	SP
--	--	-----	SP
--	--	-----	SP
--	--	-----	SP
--	--	-----	SP
--	--	-----	SP
VPS : OFF			

6

Press ◀ or ▶ to select the settings that you wish to revise. (PR, DATE, TIME, VPS/PDC and SP).

Press ▲ or ▼ to enter the correct information.

If you are recording from stations that do not broadcast VPS/PDC switch to VPS/PDC off! (* symbol will disappear on the TV screen).



PR	DATE	TIME	SP
PR-01	12	10:11-11:55	SP
--	--	-----	SP
--	--	-----	SP
--	--	-----	SP
--	--	-----	SP
--	--	-----	SP
--	--	-----	SP
--	--	-----	SP
VPS : OFF			

7

Press ▲ or ▼ if you wish to record in Long Play.

SP will produce improved picture and sound quality, however LP will provide twice as much recording time as SP.

Check that the timer event details are correct.



If you wish to record from AUDIO IN(L/R) and VIDEO IN on the front or from the EURO SCART socket on the back of VCR, press AV to select for correct display (AV1, or AV2).

PR	DATE	TIME	SP
PR-01	12	10:11-11:55	SP
--	--	-----	SP
--	--	-----	SP
--	--	-----	SP
--	--	-----	SP
--	--	-----	SP
--	--	-----	SP
--	--	-----	SP
REC. SPEED : SP			

8

If you want to make another ShowView recording repeat stages 2 - 7.

Press **i** twice.

If **PLEASE CHECK** is displayed, you have entered incorrect information and will need to re-enter the data.

Press **POWER** to switch your VCR power off mode.



TIMER will appear in the video recorder's display while your VCR waits to make the recording.



The Video Programme System (VPS)/ Programme Delivery Control (PDC) system adjusts the start and end times of a timer record event. This can be particularly useful with sports events which may run over into extra time. The VPS/PDC signal is transmitted by the broadcaster and this controls your video recorder's timer. Currently only a limited number of TV companies transmit VPS/PDC signals.

Please make sure that when recording from channels that do not broadcast VPS/PDC that you turn VPS/PDC OFF.

Timer recording Using On Screen Display ADVANCED



If you choose not to use ShowView, you can set timed recordings manually. You may set up to seven timer record events within one month of the current date **PLEASE NOTE!** before setting the timer make sure that you have set the VCR clock correctly and you know which stations you have tuned TV stations on your VCR.

1

Insert a video cassette with protection tab into your VCR.

The video cassette should have the window side facing up and the arrow facing away from you.

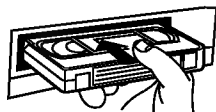

2

Press i.

Press ◀ or ▶ to select REC.

Press OK.

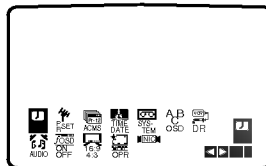

PR	DATE	TIME	
---	---	---	SP
---	---	---	SP
---	---	---	SP
---	---	---	SP
---	---	---	SP
---	---	---	SP

DELETE: [Left] [Right] [Up] [Down]

3

Press OK to start setting the timer record event.

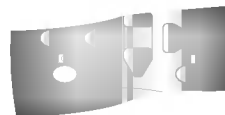

If all timer record events are full press ▲ or ▼ to select the event that you wish to remove and replace.

Press ◀ to delete the event.

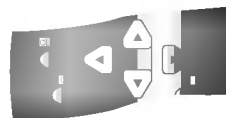

PR	DATE	TIME	
---	---	---	SP
---	---	---	SP
---	---	---	SP
---	---	---	SP
---	---	---	SP
---	---	---	SP

[Left] [Right] [Up] [Down]

4

Press the **numbered buttons** to enter the station that you wish to record.

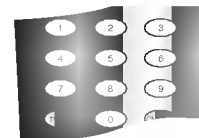

When selecting stations 1 - 9, press 0 first, then the channel number; for example Stations 3 - 03. You may also select Channels by pressing ▲ or ▼. Once selected press ▶.

If you wish to record from AUDIO IN(L/R) and VIDEO IN on the front or from the EURO SCART socket on the back of VCR, press AV to select for correct display (AV1, or AV2).

PR	DATE	TIME	
---	---	---	SP
---	---	---	SP
---	---	---	SP
---	---	---	SP
---	---	---	SP
---	---	---	SP

[Left] [Right] [Up] [Down]



If at a later date you wish to **delete** or **change** any of the settings in timer event memory you may do so without having to enter all the timer event information again. Simply display the timer event screen. Press **▲** or **▼** to select the event that you wish to **delete** or **change**.

Press **◀** to delete the event...or

Press **OK** to change; then press **◀** or **▶** to select; Station, Date, Start and End times, VPS/PDC and LP. Press **▲** or **▼** to enter the correct information.

5

Press the **numbered buttons** to enter the date of the programme.

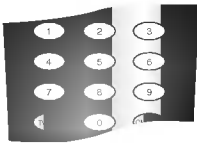

If you press **OK** before entering the date you may select one of the following automated recording features. Press **◀** or **▶** to select, then press **OK** to confirm.

DLY To record every day (except Saturday and Sunday) at the same time.

Weekly To record at the same time every week.

PR	DATE	T I M E	SP
PR-01	■	-----	SP
--	--	-----	SP
--	--	-----	SP
--	--	-----	SP
--	--	-----	SP
--	--	-----	SP
--	--	-----	SP
--	--	-----	SP
--	--	-----	SP
■	SU MO TU WE TH FR SA		

6

Press the **numbered buttons** to enter the recording start and end times of the programme that you wish to record.

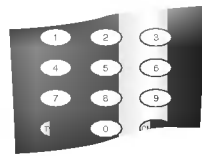

Please note your VCR uses a 24 hour clock. e.g. 1pm will be displayed as 13:00. You may also select the the start and end times by pressing **▲** or **▼**.

PR	DATE	T I M E	SP
PR-01	16	19:00-20:00	SP
--	--	-----	SP
--	--	-----	SP
--	--	-----	SP
--	--	-----	SP
--	--	-----	SP
--	--	-----	SP
--	--	-----	SP
--	--	-----	SP

7

Press **▲** or **▼** to switch VPS/PDC on or off.

If you are recording from stations that do not broadcast VPS/PDC switch VPS/PDC off! (* symbol will disappear on the TV screen).

Press **◀** or **▶** and press **▲** or **▼** if you wish to record in Long Play.



PR	DATE	T I M E	SP
PR-01	16	19:00-20:00	SP
--	--	-----	SP
--	--	-----	SP
--	--	-----	SP
--	--	-----	SP
--	--	-----	SP
--	--	-----	SP
--	--	-----	SP
VPS: ON			

8

Check that the timer event details are correct.

Press **i** twice.

If **PLEASE CHECK** is displayed, you have entered incorrect and will need to re-enter the data.

Press **POWER** to switch your VCR Standby.



TIMER will appear in the video recorder's display while your VCR waits to make the recording.



If Timer record events Overlap...

Make sure that the preset times of the timer recording events do not overlap. If they do, the earlier programme will always be given priority.

Example:

Programme 1 is programmed to start at 16:00 and end at 17:00.

Programme 2 is programmed to start at 16:30 and end at 18:00.

(In this case, Programme 1 will be recorded in its entirety, but only the last 30 minutes of Programme 2 will be recorded.)

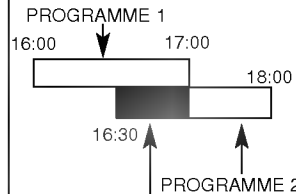

(This portion will not be recorded)

Energy Saving Advanced On/Screen Display



Your VCR has an Energy Save feature which if set will place your VCR into an economic power save where the clock display will disappear. If you have programmed a recording, this feature will not work.

1

Press **0** on the VCR.

The SP, VCR and clock will appear on the video recorder's display.

2

Press **0** on the VCR again and your VCR will go into **Energy Save**.

The SP, VCR and clock display will disappear.

Press **0** to switch off **Energy Save**.

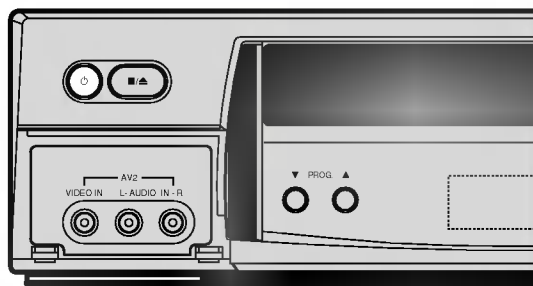

You may easily display the current time or tape counter, amount of tape left, day, month, year, day of week, programme channel, and operational mode of your VCR will appear on the TV screen. If a recording is taking place these On Screen Displays will not be recorded onto the tape.

1

Press **OK/CLK/CNT** to display.

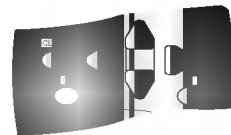

VCR Function Channel Programme



Day/Month/
Year/Day of
Week

Clock/Tape
Counter &
Amount of
Tape Left

2

Press **OK/CLK/CNT** repeatedly to display the **TAPE COUNTER**.

Press **OK/CLK/CNT** again to remove all displays from the TV screen.

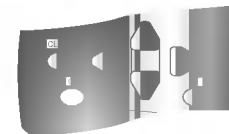

After 3 seconds the display will clear only leaving the **CLOCK** on display.



The **Digital Tape Counter** can be displayed on your VCR's display instead of the time by pressing **OK/CLK/CNT** on the remote control. The Digital Tape Counter indicates the relative positions of recordings on the tape.

1

Press **OK/CLK/CNT**.
Press **CLEAR** to set the counter to 0:00:00.

Press **PLAY** or start recording.

The tape counter will display the actual play time in hours, minutes and seconds.

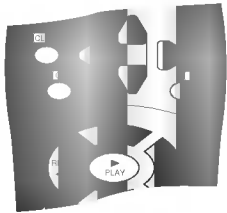

2

Press **STOP** when playback or recording is complete.

Press **REW**.

The tape will rewind and automatically stop when the counter returns to 0:00:00.

Press **OK/CLK/CNT** to return to clock.

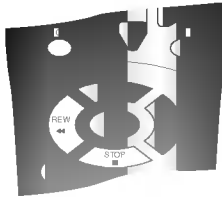

The control buttons on the front of the VCR can be switched off so that your VCR can only be operated using the remote control.

1

Press **C.LOCK**.

 will appear from your video recorder's display.

None of the buttons on the front of your VCR will work (except **STOP/EJECT**)

If any buttons on the front of your VCR are pressed  will flicker in your video recorder's display.

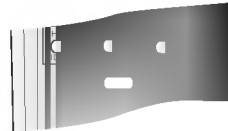

2

Press **C.LOCK** again to switch off the child lock.

 will disappear from your video recorder's display.

Tape Counter Memory Stop



Wide Screen Compatibility Advanced 16:9



Your VCR can record and play back wide screen aspect ratio programmes (16:9). To record a wide screen format programme successfully the correct type of wide screen signal must be broadcast by the TV station.

1

Switch on your VCR.

Press **i**.

Press **◀** or **▶** to select **16:9/4:3**.

Press **OK**.

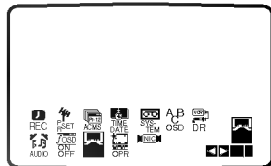

2

Press **▲** or **▼** repeatedly to select: **AUTO**, **4:3** or **16:9**.



AUTO:
Automatically plays back Wide-Screen programmes as Wide-Screen and Normal programmes as normal.

4:3:
Only for playing back and recording Normal format recordings (4:3).

16:9:
Only for playing back and recording Wide-Screen format recordings (16:9).

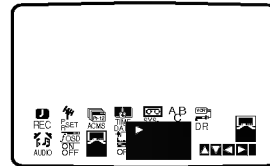

3

Press **i** to remove the menus from the TV screen.

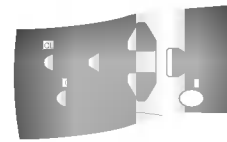

To enjoy Wide-Screen playback you must connect your VCR to the TV using a SCART cable.



Automatic Memory Shut-Off

This feature of your VCR enables you to switch off your VCR automatically after tape rewind has been completed.

1

Press **POWER** during tape rewind.



2

The tape will rewind to the beginning and your VCR will automatically switch itself off.



Automatic Switch Off

This usually occurs at the end of the evening when TV stations stop broadcasting.



Self-Diagnosis (VIDEO DOCTOR)

This feature informs you that there is a problem with your VCR. These error messages will appear on the TV screen and in your video recorder's display.

1

Press **i**.

Press **◀** or **▶** to select **DR**.

Press **OK**.

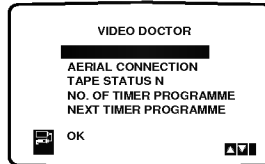
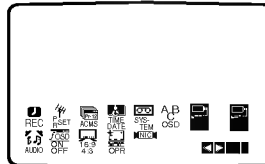

2

Press **▲** or **▼** to check a problem.

HEAD STATUS

- **PLEASE CLEAN:**
Clean your video heads.

AERIAL CONNECTION

- **PLEASE CHECK:**
Connect your VCR to a TV aerial and TV.

- **AV MODE/ PLAY MODE:**
Shows the current mode of VCR.

- **EMPTY PR:**
Appears when a station has not memorized.

TAPE STATUS

- **NOT RECORDABLE:**
Insert a tape with its protection tab in place

NO. OF TIMER PROGRAMME

- **2**
Shows the number of timer recording.

NEXT TIMER PROGRAMME

- **1 26 10:00~11:00**
Shows the current status of timer recording.

Press **i**.

Memory Shut-Off Self-Diagnosis



A second VCR (for tape copying) should be connected to the AV sockets on the front of your VCR or one of the SCART sockets on the back of your VCR.

Remember to select the appropriate audio/video mode by pressing the **AV** button on the remote control.

Back view of your VCR
Place the video tape that you wish to record **ON** into this VCR

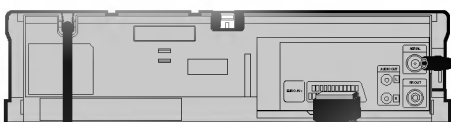

All connections must be made with both your VCR's and TV unplugged from the mains

SCART Lead
If you use a SCART lead picture quality will be improved and you will be able to enjoy stereo sound when playing tapes



Back view of playing VCR
Place the video tape that you wish to record **FROM** into this VCR



General

Power 100-240V~, 50Hz.
Power consumption Approx. 20 Watts (Energy saving mode: 3 Watts)
Video Head System Double azimuth 4 heads, helical scanning.
Tape speed 23.39 mm/sec (SP mode)/ 11.69 mm/sec (LP mode).
Tape format Tape width 12.7 mm (0.5 inch).
Maximum recording time 4 hours (SP mode, E-240 tape)/ 8 hours (LP mode, E-240 tape).
Rewind time Approx. 180 sec.(E-180 tape).
Dimensions 360 x 94 x 270 mm (W x H x D)
Weight 4.1 Kg.
Operating temperature 5°C - 35°C
Operating humidity Less than 80%.
Timer 24 hours display type.

Video

Television system CCIR standard (625 lines, 50 fields)
PAL/SECAM colour signal
Recording format PAL/MESECAM
RF Reception PAL/SECAM (B/G, D/K)
RF Output PAL G, SECAM K
Input level VIDEO IN (SCART, RCA type) 1.0 Vp-p, 75 Ohm, unbalanced
VIDEO OUT (SCART type) 1.0 Vp-p, 75 Ohm, unbalanced
Output level
Signal to noise ratio More than 43 dBm.
RF Modulator UHF 22-68 (Adjustable)

Audio

Input level AUDIO IN (SCART, RCA type) SCART type: -5.0 dBm, more than 10 kohms
RCA type: -5.0 dBm, more than 47 kohms
Output level AUDIO OUT (SCART, RCA type) SCART type: -5.0 dBm, less than 1 kohms
RCA type: -5.0 dBm, less than 1 kohms
Track Mono track & Hi-Fi track
Frequency response Normal: 100 Hz-10 kHz (-6/+3 dB)
Hi-Fi: 20 Hz-20 kHz (-3/+3 dB)
Signal to noise ratio Normal : More than 43 dB (at SP mode)
Hi-Fi : More than 70 dB (at SP mode)

Specifications

Tape Copying



The design and specifications are subject to change without notice.

Troubleshooting

Check List



Video Head Cleaning

Whenever a video cassette is inserted into or ejected from your VCR the video head is automatically cleaned. This should mean that additional head cleaning should not be necessary. However dirt accumulating on the head after a long period of time can cause the playback picture to become blurred or broken up. High quality video cassette tapes will not normally deposit dirt onto the video head, but old or damaged tapes might.

Symptom	Check points	Symptom	Check points
No picture & no sound	<p>Is the mains plug plugged in and switched on?</p> <p>Is the TV switched on?</p> <p>Try another channel, maybe a weak signal.</p> <p>Check aerial is it plugged in? Check aerial, is the lead broken or damaged?</p> <p>Have you tuned in a dedicated channel on your TV to watch video on?</p> <p>If you have used a SCART lead to connect your VCR and TV have you selected the AV channel on your TV?</p> <p>Check tuning, carry out Automatic Tuning again</p>	Video cassette cannot be inserted	<p>Is the cassette compartment empty?</p> <p>Are you trying to insert the cassette the right way round?</p>
No playback or poor picture	<p>Are the TV channels tuned in properly?</p> <p>Have you tried using another cassette?</p> <p>Can you minimise the noise bars to an acceptable level with the 0 or ▲ or ▼ buttons?</p>	Remote control does not work	<p>Is the mains plug plugged in and switched on?</p> <p>Is the VCR switched on</p> <p>Check the batteries in remote control.</p>
TV programmes cannot be recorded	<p>Can you get a picture on the TV?</p> <p>Are the aerial leads and special RF connector lead between your VCR and TV connected?</p> <p>Are the TV channels tuned in properly; are they tuned in order?</p> <p>Has the safety tab on the video cassette been removed to prevent recording?</p> <p>Try another station, maybe a weak signal</p> <p>Check aerial is it plugged into TV?</p>	The top of the playback picture is unstable	<p>Is the video cassette damaged, have you tried using another one?</p> <p>Adjust the horizontal control on your TV.</p> <p>Check aerial is it plugged into VCR?</p> <p>Check aerial, is the lead broken or damaged?</p> <p>Check for local interference</p> <p>Make sure that you are using a dedicated TV channel on your TV.</p>
		No NICAM sound recording	<p>Make sure NICAM in the menu is set to AUTO for the station to be recorded.</p>
		No Hi-Fi sound	<p>Switch "AUDIO" in the menu to STEREO.</p>
		Auto Play does not work	<p>Has the safety tab been removed from the video cassette?</p>



P/N:3834RP0034Y