

LG

Room Air Conditioner

(Single Split Wall Mounted Type)

OWNER'S MANUAL

Before using your air conditioner please read this manual carefully and keep it for future reference.

Prior to installation, this air-conditioning unit must be submitted for approval by the utility service which provides electricity (EN 60555-3 Norm).



Safety Precautions

Safety Precautions

Installation Precautions3
Operation Precautions4

Operating Instructions

Operating Instructions

Remote Control Features...7
Operation Mode Selection..10
Additional Features14

Care and Maintenance

Care and Maintenance

Care and Maintenance.....18
Operation Tips.....21

Troubleshooting Tips

Troubleshooting tips

Before You
Call For Service22

FOR YOUR RECORDS

Write the model and serial numbers here for the indoor and outdoor units:

Indoor model # _____ Serial # _____

Outdoor model # _____ Serial # _____

You can find them on a label on the side of each unit.

Dealer's Name _____

Date Purchased _____

READ THIS MANUAL

- Inside you will find many helpful hints on how to use and maintain your air conditioner properly. Just a little preventive care on your part can save you a great deal of time and money over the life of your air conditioner.
- You'll find many answers to common problems in the chart of troubleshooting tips. If you review our chart of **Troubleshooting Tips** first, you may not need to call for service at all.

CAUTION

- **Contact the authorized Service technician for repair or maintenance of this unit.**
- **Contact the installer for installation of this unit.**
- **The air conditioner is not intended for use by young children or infirm persons without supervision.**
- **Young children should be supervised to ensure that they do not play with the air conditioner.**

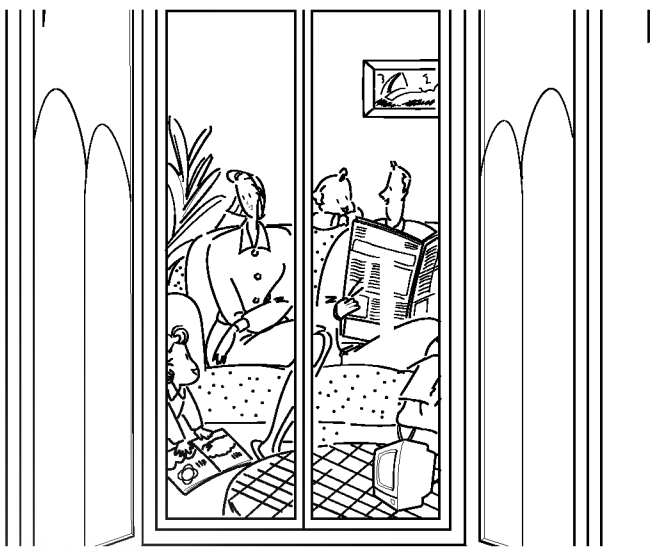



Important safety precautions



Read all instructions before using.

To prevent injury to the user or other people and property damage, the following instructions must be followed.

- Incorrect operation due to ignoring of instruction will cause harm or damage, the seriousness is classified by the following indications.

	WARNING : This symbol indicates the possibility of death or serious injury.
	CAUTION : This symbol indicates the possibility of injury or damage to properties only.

- Meanings of symbols used in this manual are as shown below.



	Be sure not to do.
	Be sure to follow the instruction.



WARNING

- **Do not install, remove and re-install the unit by yourself.**
Improper installation will cause water leakage, electrical shock, or fire. Please consult authorized dealer or specialist for the installation work.

CAUTION

- Please confirm the following important points during installing.*
- **This room air conditioner must be grounded.**
 It may cause electrical shock if grounding is not perfect.
 - **Do not install the unit at place where leakage of gas may occur and/or in an explosive atmosphere.**
 In case of gas leaks and the gas may accumulate the unit, it may cause fire ignition.
 - **Confirm drainage piping is connected properly.**
 If it is not connected perfectly, it may cause water leakage and dampen the furniture.
 - The reverse cycle system of the air conditioner is based on the air cooling type heat pump which absorbs heated air from the outdoor unit and discharges it indoor.
 Therefore if the outdoor unit is exposed to very low temperature, specifically below 0°C, the heating capacity drops off rapidly. In this case, we recommend customers don't operate the air conditioner.

Safety Precautions

Operating Instructions

Care and maintenance

Troubleshooting Tips



WARNING

• Otherwise, it will cause electrical shock or fire due to heat generation.

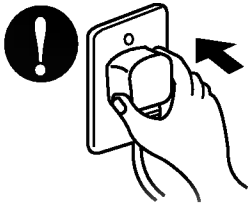

• It will cause electrical shock or fire due to heat generation.

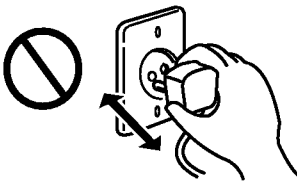

• It will cause electrical shock or fire.
• If the supply cord is damaged, it must be replaced by the manufacturer or its service agent or a similarly qualified person in order to avoid a hazard.

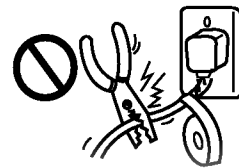

• It will cause electrical shock or fire due to heat generation.

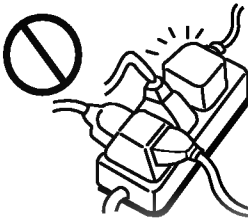

• It will cause electrical shock.



• Since the fan rotates at high speed, this may cause an injury or damage the unit.

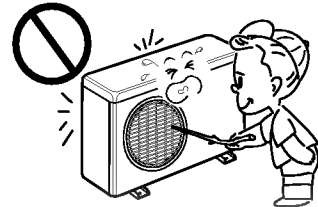

• This could damage your health.

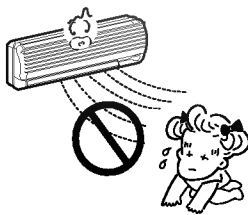

• If the unit continues to operate in an abnormal condition, it may cause fire, damage, etc. In this case, consult your dealer.

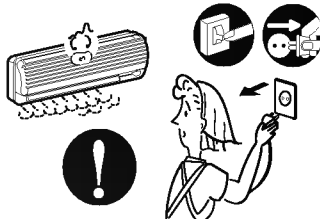

• If this is done incorrectly, it may cause a fire, electric shock, injury by dropping of the unit, water leakage, etc. Consult your dealer.

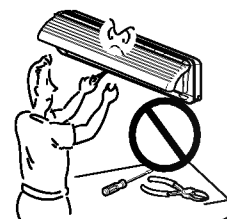

⚠ CAUTION

- It may cause an injury.
- Should be disconnected from supply

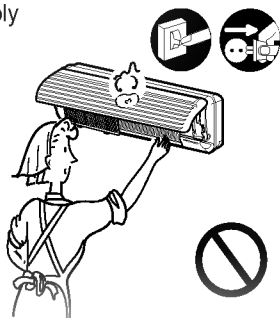

- Water may enter the unit and degrade the insulation. It may cause an electric shock.

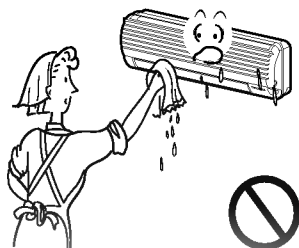

- An oxygen shortage may occur.

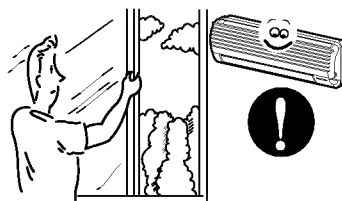

- Since the fan rotates at high speed during operation, it may cause an injury.

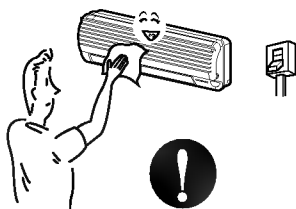

- This could injure the pet or plant.

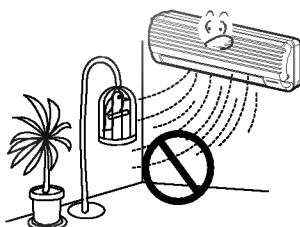

- Do not use this air conditioner to preserve precision devices, food, animal, plants, and art objects. It may cause deterioration of quality, etc.

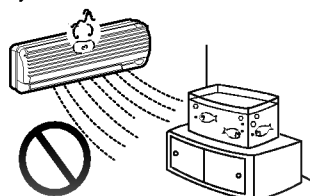

- It may cause an electric shock.

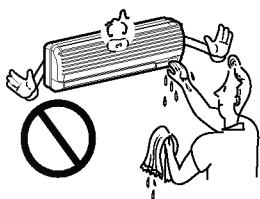

- It may cause a fire or deformation of the cabinet.

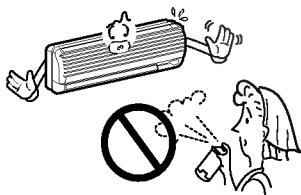

- It may affect combustion.

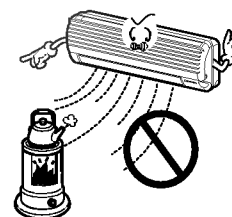

CAUTION

When the unit is not going to be used for a long time, turn off the circuit breaker.

- If not, dirt may collect and cause a fire.

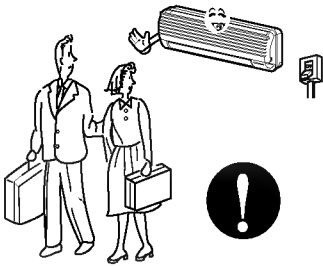

Do not operate for a long time in high humidity, e.g. leaving a door or window open.

- In the cooling mode, if it is operated in a room with high humidity (80%RH or more) for a long time, water condensed in the air conditioner may drop and may wet and spoil furniture, etc.



- It may cause an injury through dropping or falling down.

- It may cause an injury, etc. by falling down.

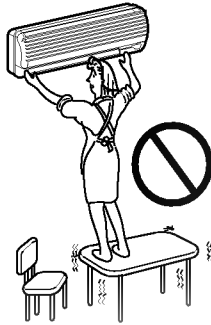
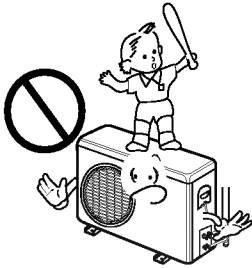

- The unit may drop or fall down and cause an injury.



- It will cause an injury by the rotating blower.

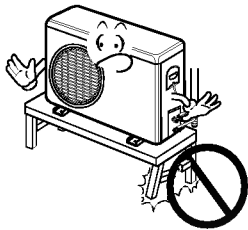

For installation

WARNING

- Consult your dealer for installing the air conditioner.

CAUTION

- Do not connect a grounding wire to a gas pipe, water pipe, lightning rod, or ground wire of a telephone. If grounding is incorrect, it may cause an electric shock.



Install a ground fault interrupter depending on the place where the air conditioner is to be installed. (humid place, etc.)

- If the ground fault interrupter is not installed, it may cause an electric shock.



- If gas leaks and collects around the unit, it may cause an explosion.

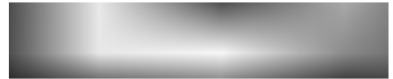

- If the drainage route is incomplete, water may drop from the unit. It may wet and spoil furniture.

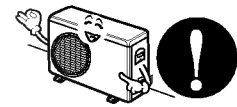

About the remote control on the system

The remote control transmits the signals to the system.



Features of the Remote Control- Door Open

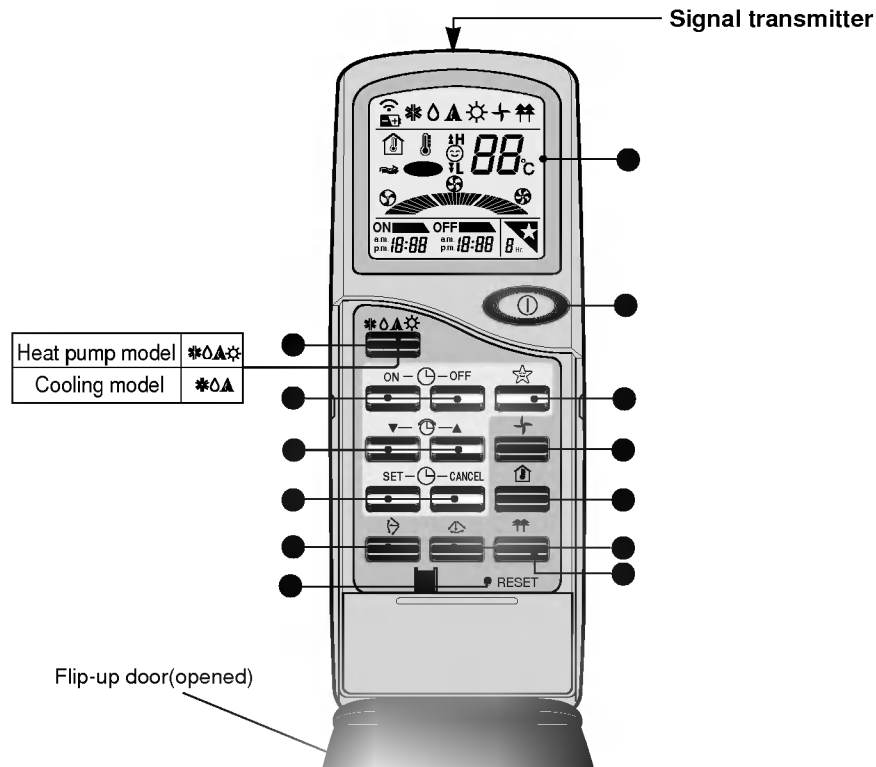

- **OPERATION DISPLAY**
Displays the operation conditions.
- **START/STOP BUTTON**
Operation starts when this button is pressed and stops when the button is pressed again.
- **OPERATION MODE SELECTION BUTTON**
Used to select the operation mode. (Refer to page 8)
- **ON/OFF TIMER BUTTONS**
Used to set the time of starting and stopping operation.
- **TIME SETTING BUTTONS**
Used to adjust the time.
- **TIMER SET/CANCEL BUTTONS**
Used to set the timer when the desired time is obtained and to cancel the Timer operation.
- **VERTICAL AIRFLOW DIRECTION START/STOP BUTTON**
Used to stop or start louver movement and set the desired up/down airflow direction.
- **SLEEP MODE AUTO BUTTON**
Used to set Sleep Mode Auto operation.
- **AIR CIRCULATION BUTTON**
Used to circulate the room air without cooling or heating (turns indoor fan on/off).
- **ROOM TEMPERATURE CHECKING BUTTON**
Used to check the room temperature.
- **HORIZONTAL AIRFLOW DIRECTION START/STOP BUTTON (Not on all models)**
Used to stop or start louver movement and set the desired left/right airflow direction.
- **NEGATIVE ION BUTTON (Not on all models)**
Used to generate negative ion.
- **RESET BUTTON**
Used prior to resetting time or after replacing batteries.

Safety Precautions

Operating Instructions

Care and maintenance

Troubleshooting Tips



Features of the Remote Control- Door Closed

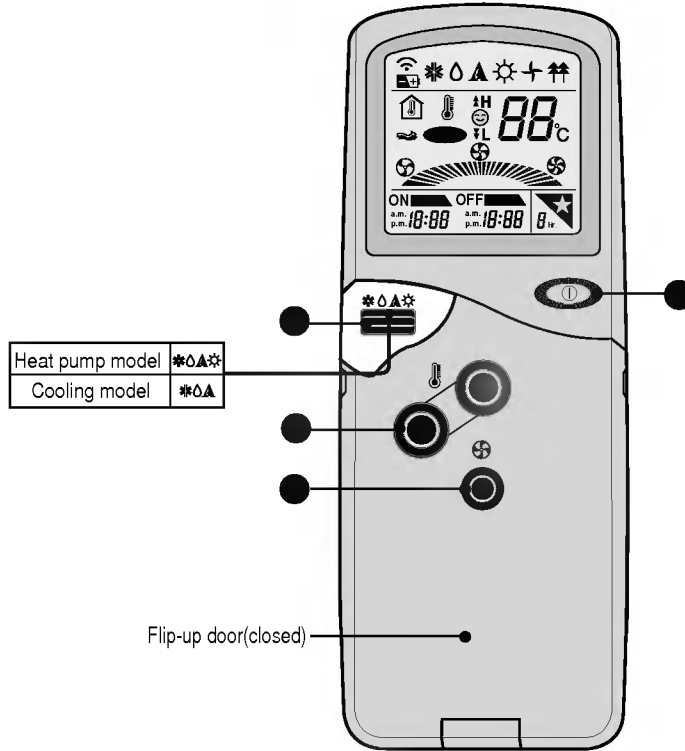

START/STOP BUTTON
Operation starts when this button is pressed and stops when the button is pressed again.

OPERATION MODE SELECTION BUTTON
Used to select the operation mode.



ROOM TEMPERATURE SETTING BUTTONS
Used to select the room temperature.



INDOOR FAN SPEED SELECTOR
Used to select fan speed in four steps-low, medium, high, or CHAOS.



Operation Mode

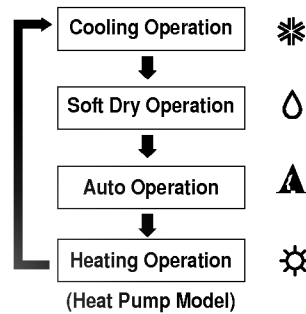
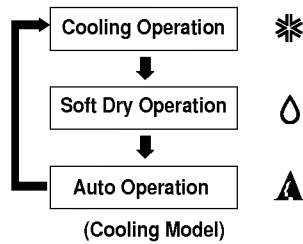

About the remote control on the system

Storage and Tips For Using the Remote Control

- The remote control may be stored inside the system or mounted on a wall.
- To operate the room air conditioner, aim the remote control at the signal receptor.
- The remote control will operate the air conditioner at a distance of up to 7m.

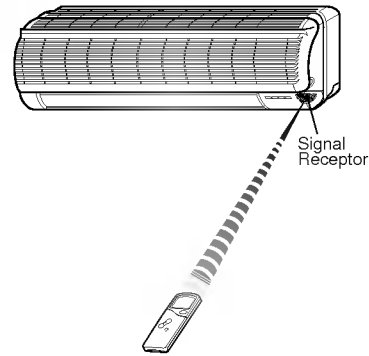
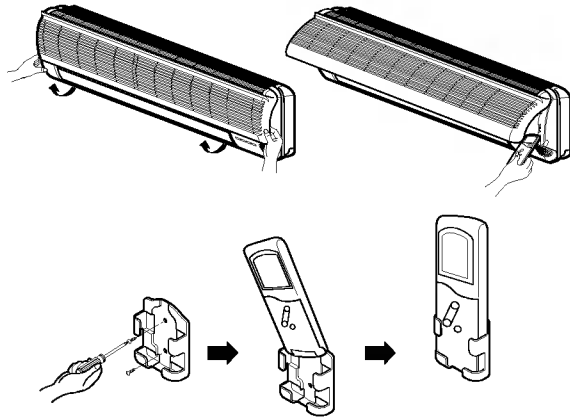

How to Insert the Batteries

- 1 Remove the battery cover by pulling it according to the arrow direction.
- 2 Insert new batteries making sure that the (+) and (-) of battery are installed correctly.
- 3 Reattach the cover by pushing it back into position.

NOTES:

- Use 2 AAA(1.5volt) batteries. Do not use rechargeable batteries
- Remove the batteries from the remote control if the system is not going to be used for a long time.

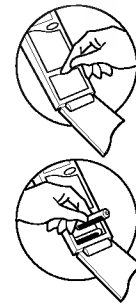

Inside the Indoor System

Some controls are located inside the indoor unit. Open the front panel by lifting it up.

Slide Switch Operation (Refer to page 16)

FORCED OPERATION: Used for operation when the remote control cannot be used.

AUTO RESTART: In case the power comes on again after a power failure, the air conditioner will operate in "Auto Restart Operation" mode. This function automatically returns the air conditioner to the previous operating conditions.

REMOTE CONTROL: If you do not want to use Auto Restart Operation

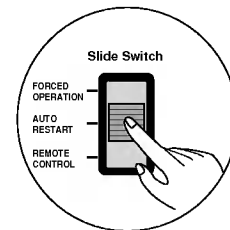

Signal Receptor

Receives the signals from the remote control.

(Signal receiving sound: two short beeps or one long beep.)

Operation Indication Lamps

- ⓘ On/Off : Lights up during the system operation.
- ☆ Sleep Mode : Lights up during Sleep Mode Auto operation.
- ⌚ Timer : Lights up during Timer operation.
- ❄️ Defrost Mode : Lights up during Defrost Mode or Hot Start operation (Heat pump model only)
- OUT DOOR : OUTDOOR UNIT OPERATION : Lights up during outdoor unit operation. (Cooling model only)

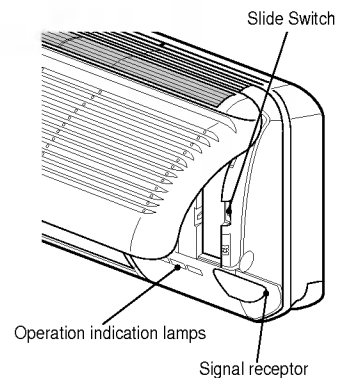

Safety Precautions

Operating Instructions

Care and maintenance

Troubleshooting Tips



How to use the Operation Mode Selection button



Cooling Operation

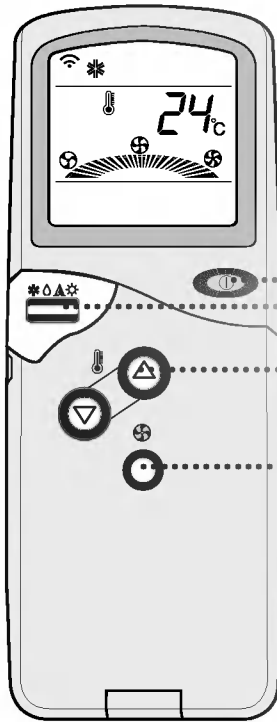

1

Press the Start/Stop button. The unit will respond with a beep.



2

Open the door on the remote control. To select **Cooling** operation, press the Operation Mode Selection button. Each time the button is pressed, the operation mode is shifted in the direction of the arrow.

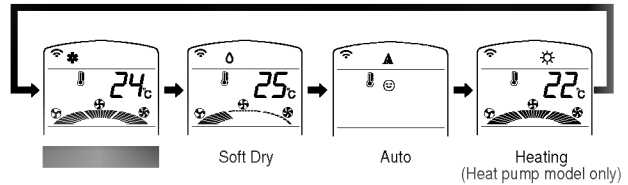

3

Close the door on the remote control. Set the temperature lower than the room temperature. The temperature can be set within a range of 18°C~30°C in 1°C increments.



— To raise the temperature
— To lower the temperature

4

Set the fan speed again with the door of the remote control still closed. You can select the fan speed in four steps—low, medium, high, or CHAOS. Each time the button is pressed, the fan speed mode is shifted.





Soft Dry Operation

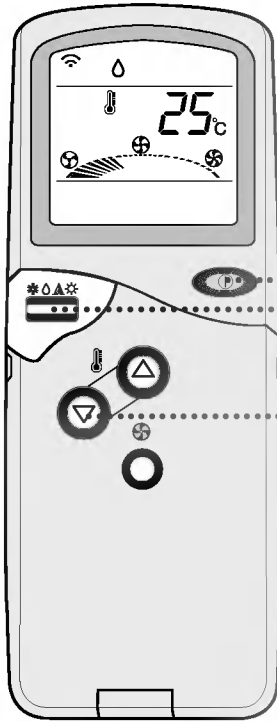

- 1 Press the Start/Stop button. The unit will respond with a beep.



- 2 Open the door on the remote control. To select **Soft Dry** operation, press the Operation Mode Selection button. Each time the button is pressed, the operation mode is shifted in the direction of the arrow.

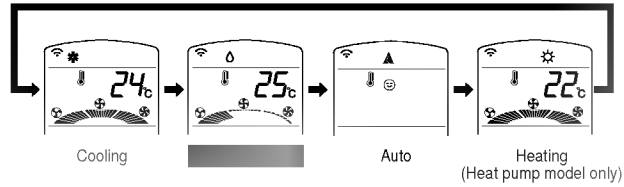

- 3 Close the door on the remote control. Set the temperature lower than the room temperature. The temperature can be set within a range of 18°C~30°C in 1°C increments.

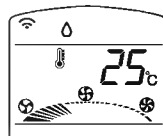

— To raise the temperature
— To lower the temperature

During Soft Dry Operation:

- ❑ The indoor fan speed is automatically set to low speed and cannot be adjusted.



Auto Operation

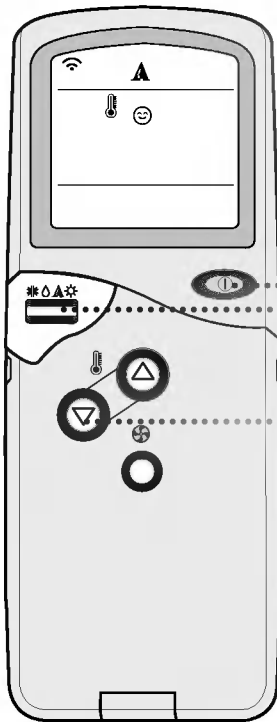

1

Press the Start/Stop button. The unit will respond with a beep.



2

Open the door on the remote control. To select **Auto** operation, press the Operation Mode Selection button. Each time the button is pressed, the operation mode is shifted in the direction of the arrow.

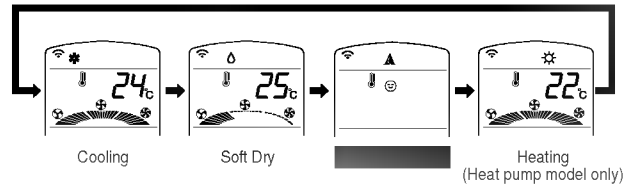

3

The temperature and fan speed are automatically set by the electronic controls based on the actual room temperature. If you want to change the set temperature, close the door on the remote control and press the Room Temperature Setting buttons. The cooler or warmer you feel, the more times (up to two times) you should press the button. the set temperature will then be changed automatically.

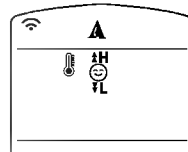

— To raise the temperature

— To lower the temperature

During Auto Operation:

- ❑ You cannot switch the indoor fan speed. It has already been set by the Fuzzy rule.
- ❑ If the system is not operating as desired, manually switch to another mode. The system will not automatically switch from the cooling mode to the heating mode, or from heating to cooling, it must be done by manually resetting.
- ❑ During Auto Operation, pressing the Airflow direction Start/Stop button makes the horizontal louvers swing up and down automatically. If you want to stop auto-swing, press the Airflow Direction Start/Stop button again.



Heating Operation(Heat pump model only)

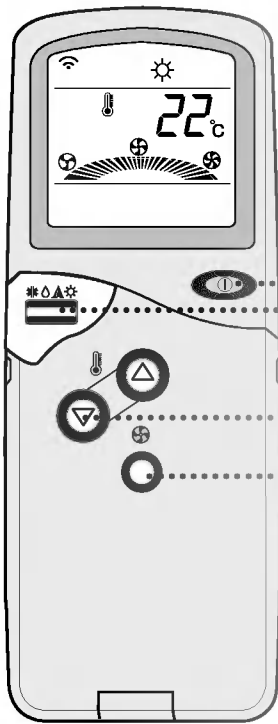

- 1 Press the Start/Stop button. The unit will respond with a beep.



- 2 Open the door on the remote control. To select **Heating** operation, press the Operation Mode Selection button. Each time the button is pressed, the operation mode is shifted in the direction of the arrow.

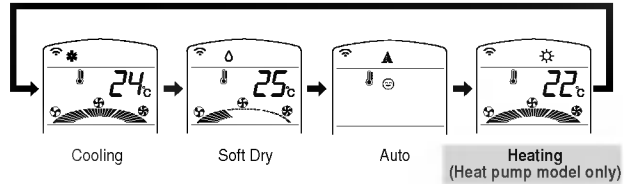

- 3 Close the door on the remote control. Set the temperature higher than the room temperature. The temperature can be set within a range of 16°C~30°C in 1°C increments.



To raise the temperature

To lower the temperature

- 4 Set the fan speed again with the door of the remote control still closed. You can select the fan speed in four steps—low, medium, high, or CHAOS. Each time the button is pressed, the fan speed mode is shifted.



Safety Precautions

Operating Instructions

Care and maintenance

Troubleshooting Tips

Additional features

Sleep Mode

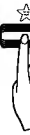
- Press the Sleep Mode Auto button to set the time you want the unit to turn off automatically. 
- The Timer is programmed in one-hour increments by pressing the Sleep Mode Auto button 1 to 7 times. The sleep mode is available for 1 to 7 times. To alter the time period in steps of 1 hour, press the Sleep Mode Button while aiming at air conditioner.
- Make sure the Sleep Mode Auto LED lights up.

To cancel the Sleep Mode, press the sleep Mode Auto button several times until the star (☆) disappears from the operation display.

NOTE: The Sleep Mode will be operated at low fan speed (cooling) or medium fan speed (heat pump only) for quiet sleeping.

IN COOLING MODE: The temperature will automatically rise by 1°C over the next 30 minutes and by 2°C in 1 hour for comfortable sleeping.

Setting the Time

Time can be set only when you have pressed the Reset button. If you have just replaced the batteries, the Reset button should be pressed to reset the time.

- Press the Start/Stop button. 

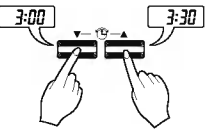
- Press the Time Setting buttons until the desired time is set. 

- Press the Timer SET button. 

NOTE: Check the indicator for A.M. and P.M.

Delay Start/Pre-Set Stop

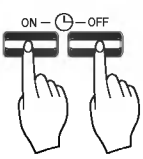
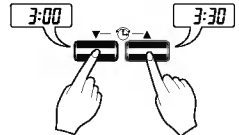
- Make sure the time is set correctly on the remote control display.
- Press the ON/OFF Timer buttons to turn Timer on or off. 
- Press the Time Setting buttons until the desired time is set. 

- Press the selected on/off setting by pressing the Timer SET button while aiming the remote control at the signal receptor. 

To cancel the setting the timer.



Press the Timer Cancel button while aiming remote control at the signal receptor. (The timer lamp on the air conditioner and the display will go out.)

NOTE: Select one of the following four types of operation.

with the unit running



Delay OFF Timer



Delay ON Timer

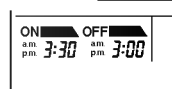

Delay OFF and ON Timer

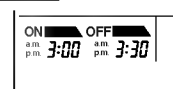

Delay ON and OFF Timer





Airflow Direction (Indoor unit)

Vertical Airflow Direction Control

The up/down airflow (Vertical Airflow) can be adjusted by using the remote control.

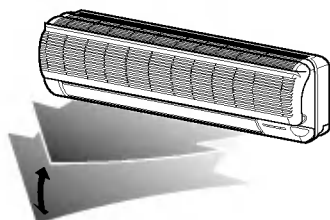

- Press the Start/Stop button to start the unit.

- Open the door on the remote control. Press the Airflow Direction Start/Stop button and the louvers will swing up and down. Press the Vertical Airflow Direction Control Button again to set the vertical louver at the desired airflow direction.



Horizontal Airflow Direction Control (Option)

The left/right (Horizontal Airflow) can be adjusted by using the remote control.

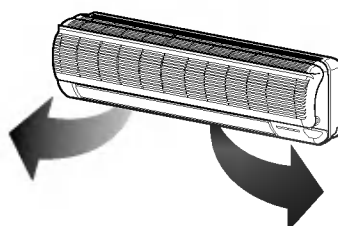

- Press the Start/Stop button to start the unit.

- Open the door on the remote control. Press the Airflow Direction Start/Stop button and the louvers will swing left and right. Press the Horizontal Airflow Direction Control Button again to set the horizontal louver at the desired airflow direction.

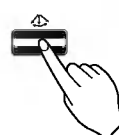

NOTE:

- ❑ Always use the remote control to adjust the up/down or left/right airflow direction. Manually moving the airflow direction louver by hand could damage the air conditioner.
- ❑ When the unit is shut off, the up/down airflow direction louver will close the air outlet vent of the system.



Air Circulation Mode

Circulates the room air without cooling or heating.

- Press the Start/Stop button. the unit will respond with a beep.
- Open the door on the remote control. Press the Air Circulation button. Close the door on the remote control. Now each time that you press the Indoor Fan Speed Selector, the fan speed is shifted from low to CHAOS and back to low again.

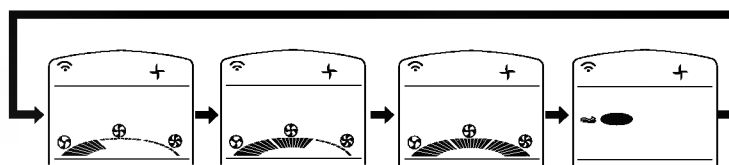

Fan speed is on low. Fan speed is on medium. Fan speed is on high. CHAOS Air

NOTE:

- ❑ The fan speed of the indoor unit will automatically cycle depending on the room temperature.
- ❑ **CHAOS Air** economizes power consumption and prevents overcooling. The fan speed is automatically changed from medium to low or vice versa, depending on the ambient temperature.



Negative Ion (Option)

Negative ions are known as 'the vitamins of the air'. In contrast, polluted air contains positive ions, which are one of the major contributors to "Sick Building Syndrome", where people suffer from headaches, stress, and fatigue.

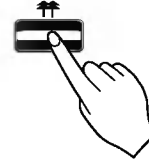

Slide Switch Operation

FORCED OPERATION

Operation procedures when the remote control can't be used. Open the front panel upward and move the Slide Switch to the Forced Operation position.

If you want to stop operation, move the Slide Switch to the Auto Restart or the Remote Control position.

In case the power comes on again after power failure on the Forced Operation position, the operating conditions are automatically set as follows:

During Forced Operation, the initial mode continues.

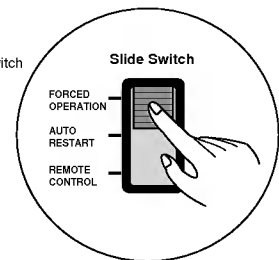

	Cooling Model	Heat pump Model		
		Room Temp. $\geq 24^{\circ}\text{C}$	$21^{\circ}\text{C} \leq$ Room Temp. $< 24^{\circ}\text{C}$	Room Temp. $< 21^{\circ}\text{C}$
Operating mode	Cooling	Cooling	Soft Dry	Heating
Indoor FAN Speed	High	High	Soft Dry Rule	High
Setting Temperature	22°C	22°C	Air Intake Temperature	24°C

AUTO RESTART

In case the power comes on again after a power failure, Auto Restarting Operation is the function to operate procedures automatically to the previous operating conditions.

In case the air conditioner does not receive any signal from the remote control, it will turn off automatically after 7 hours.

If you want to use this operation, Open the front panel upward and move the slide switch to the Auto Restart position.

If you do not want to use this operation, move the Slide Switch to the Remote Control position.

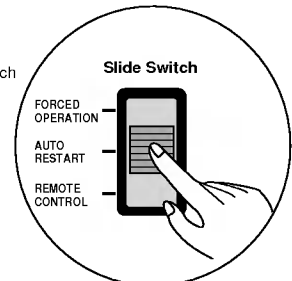

When you are out for a while, move the Slide Switch to the REMOTE CONTROL

Operation Details

Soft Dry Operation Mode (Refer to page 11)

When the room temperature is higher than the set temperature, it operates in cooling mode at the set temperature, the set fan speed (if CHAOS mode, then medium.), and then it will be automatically switched to Soft Dry Mode when the room temperature reaches the set temperature.

In Soft Dry Operation, the indoor fan speed is automatically switched to the low.

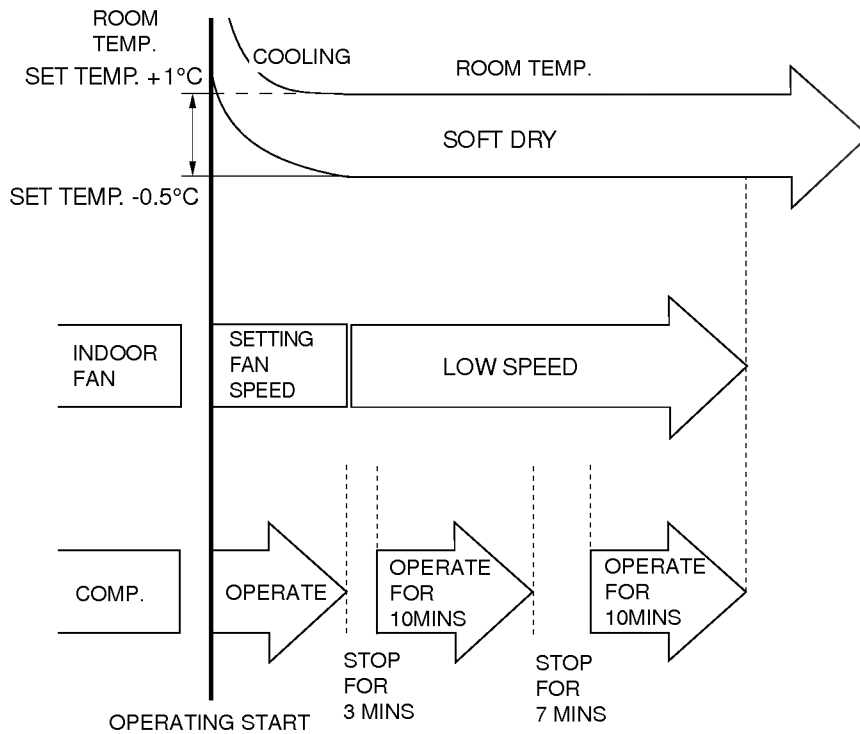

Natural wind by the CHAOS logic (Refer to page 15)

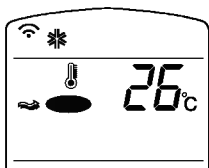

For more fresh feeling than other fan speed, press the Indoor Fan Speed Selector and set to CHAOS mode. In this mode, the wind blows like natural breeze by automatically changing fan speed according to the CHAOS logic.

Helpful information

Fan speed and cooling capacity.

The cooling capacity indicated in the specification is the value when the fan speed is set to high, and the capacity will be lower at low or medium fan speed.

High fan speed is recommended when you wish to cool the room quickly.

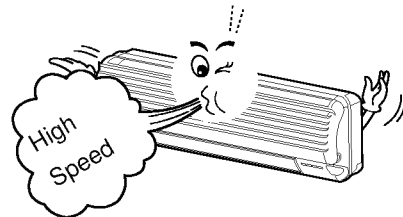

Care and maintenance of the air conditioner

CAUTION: Before performing any maintenance, turn off the main power to the system.

Indoor Unit

Grille, Case, and Remote Control

- Turn the system off before cleaning. To clean, wipe with a soft, dry cloth. do not use bleach or abrasives.

NOTE:

Supply power must be disconnected before cleaning the indoor unit.

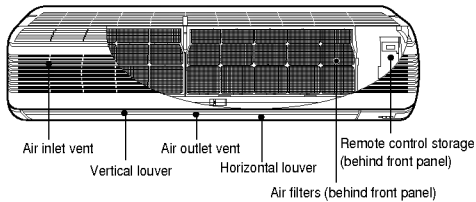

- Never use any of the followings:
 - Water hotter than 40°C
Could cause deformation and/or discoloration.
 - Volatile substances
Could damage the surfaces of the air conditioner.



Air Filters

The air filters behind the front grille should be checked and cleaned once every 2 weeks or more often if necessary.

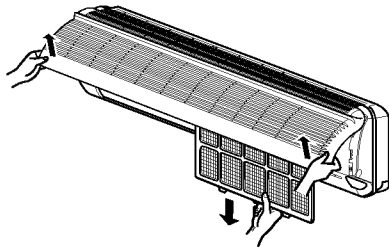

- Lift the front access panel and pull the filter tab slightly forward to remove the filter.
- Clean the filter with a vacuum or warm, soapy water.
 - If very dirty, wash with a solution of detergent in lukewarm water.
 - If hot water (50°C or more) is used, filter may be deformed.
- After washing with water, dry well in the shade.
- Re-install the air filter.

Air Purifying Filters(Optional)

This filter consists of two filters. One is electrostatic filter to remove very fine dust as small as 0.1 micron such as tobacco smoke and pollen etc., the other is deodorant filter to remove unpleasant smell such as food, sweat, and fungus.

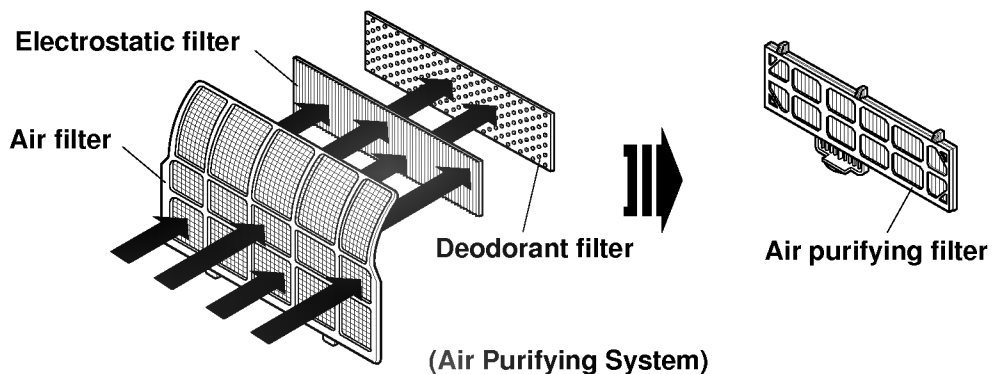

Replacement of Purifying Filter

• Recommended use period : About 2 years

- Open front panel and remove air filters.

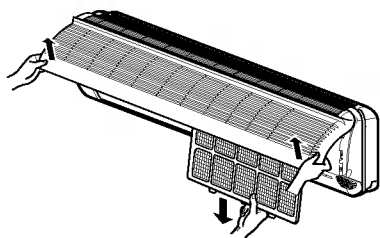

- Remove air purifying filters.

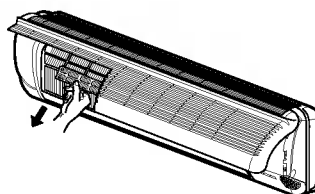

- Insert new air purifying filters.

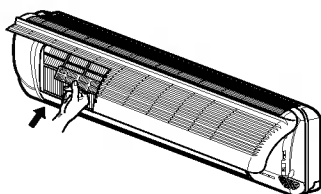

- Reinsert air filters and close front panel.

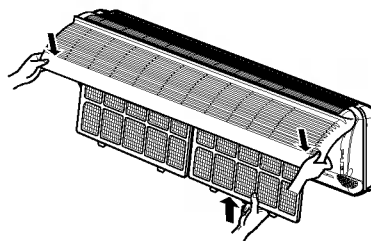

Outdoor Unit

The heat exchanger coils and panel vents of the outdoor unit should be checked regularly. If clogged with dirt or soot, the heat exchanger and panel vents may be professionally steam cleaned.

NOTE:

Dirty or dogged coils will reduce the operating efficiency of the system and cause higher operating costs

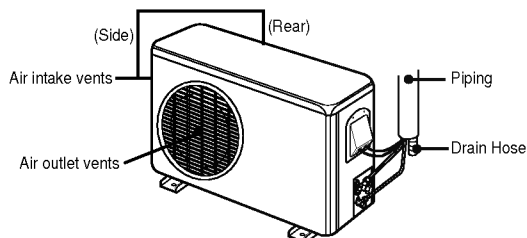

When the air conditioner is not going to be used for a long time.

- 1 Operate the air conditioner on Air circulation mode (Refer to page 15) for 2 to 3 hours.

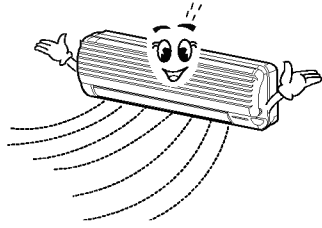

- This will dry out the internal parts.

- 2 Turn off the circuit breaker, and disconnect the plug.

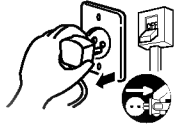

Turn off the circuit breaker when the air conditioner is not going to be used for a long time.
Dirt may collect and may cause a fire.

- 3 Remove the batteries from the remote control.

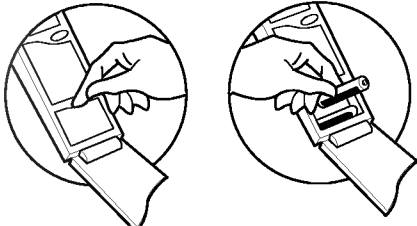

- 1 Clean the air filter and re-install it in the indoor unit.
(Refer to page 18 for cleaning filters.)

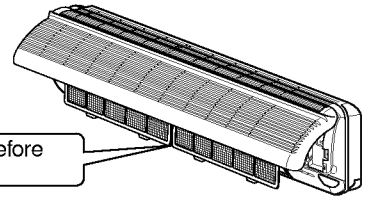

Clean it before installing.

- 2 Check that the air inlet and outlet of the indoor/outdoor unit are not blocked.

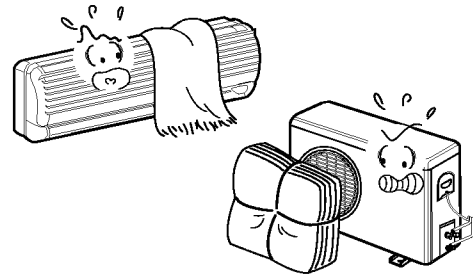

Helpful information

The air filters and your electric bill.
If the air filters become clogged with dust, the cooling capacity will drop, and 6% of the electricity used to operate the air conditioner will be wasted.

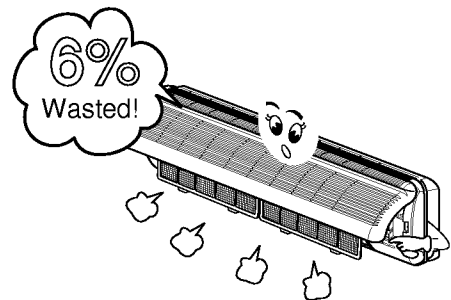

Operation Tips

This is not good for your health and wastes electricity.

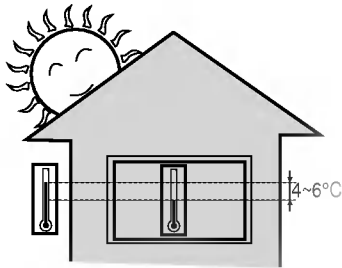

Do not let direct sunshine enter the room when the air conditioner is in operation.

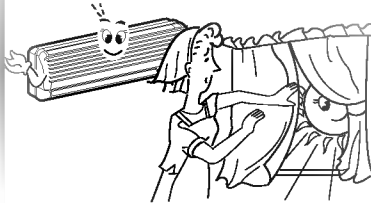

Adjust the vertical and horizontal airflow direction to ensure a uniform temperature in the room.

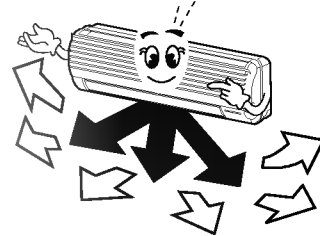

Avoid opening doors and windows as much as possible to keep the cool air in the room.

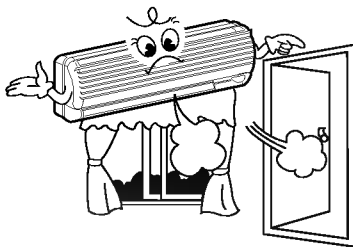

Blockages in the air filter reduce the airflow and lower cooling and dehumidifying effects. Clean at least once every two weeks.

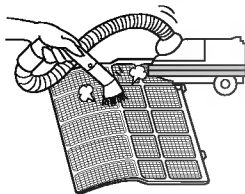

Since windows are kept closed, it is a good idea to open them and ventilate the room now and then.

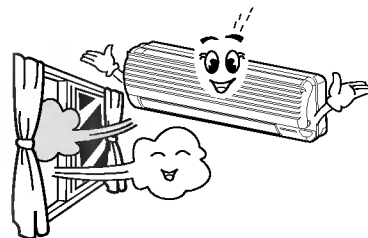

Safety Precautions

Operating Instructions

Care and maintenance

Troubleshooting Tips







Before you call for service...

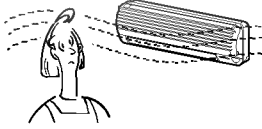

Troubleshooting Tips! Save time and money!

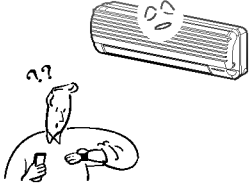
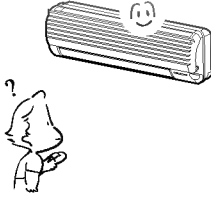
Check the following points before requesting repairs or service.... If the fault persists, please contact your dealer or service center.

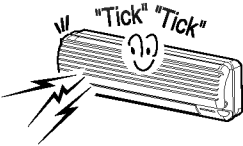
 <ul style="list-style-type: none"> • Have you made a mistake in timer operation? • Has the fuse blown or has the circuit breaker been tripped? 	 <ul style="list-style-type: none"> • Check that this is not a damp smell exuded by the walls, carpet, furniture, or cloth items in the room. 	 <ul style="list-style-type: none"> • Condensation occurs when the airflow from the air conditioner cools the warm room air. 	 <ul style="list-style-type: none"> • This is the Protection device of the air conditioner . • Wait about three minutes and operation will begin.
 <ul style="list-style-type: none"> • Is the air filter dirty? See air filter cleaning instructions. (Refer to page 18) • The room may have been very hot when the room air conditioner was first turned on. Allow time for it to cool down. • Has the temperature been set incorrectly? • Are the indoor unit's air inlet or outlet vents obstructed? 	 <ul style="list-style-type: none"> • For a noise that sounds like water flowing. -This is the sound of freon flowing inside the air conditioner unit. • For a noise that sounds like the compressed air releasing into atmosphere. -This is the sound of the dehumidifying water being processed inside the air conditioning unit. 	 <ul style="list-style-type: none"> • Are the batteries depleted? • Are the batteries inserted in the opposite (+) and (-) directions? 	 <ul style="list-style-type: none"> • This sound is generated by the expansion/contraction of the front panel, etc. due to changes of temperature.

NOTE

WATER RESISTANT: The outdoor side of this appliance is WATER RESISTANT.
The indoor side is not water resistant and should not be exposed to excess water.





P/NO.: 3828AR7109Q

Printed in Korea