

1C-340NF

- **Manual de instrucciones.**
- **Manual de instruções.**
- **Operating instructions.**
- **Mode d'emploi.**

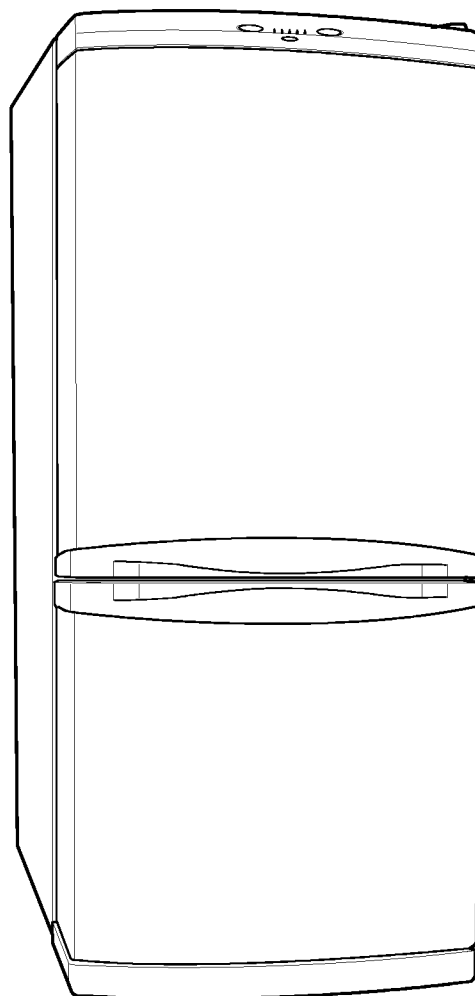

 edesa



Table of Contents

Introduction	Registration 32
	Important Safety Instruction 32
	Identification of Parts 34
Installation	Installation 35
	Starting 35
Operation	Temperature Control 36
	Quick Freeze 36
	Vacation 37
	Self Test 37
	Door Alarm 37
	Ice Making 37
	Defrosting 37
Suggestion On Food storage	Storing Food 38
Care and Maintenance	General Information 39
	Lamp Replacement 39
	Cleaning 40
Trouble Shooting	Trouble Shooting 41



Introduction

Introduction

Registration

The model and serial number are found on the rear of this unit. This number is unique to this unit and not available to others. You should record requested information here and retain this guide as a permanent record of your purchase. Staple your receipt here.

Date of Purchase : _____

Dealer Purchased From : _____

Dealer Address : _____

Dealer Phone No. : _____

Model No. : _____

Serial No. : _____

Precaution

Important Safety Instruction

This fridge-freezer must be properly installed and located in accordance with the Installation Instruction before it is used.

Never unplug your fridge-freezer by pulling on the power cord. Always grip plug firmly and pull straight out from the outlet.

When moving your appliance away from the wall, be careful not to roll over or damage the power cord.

After your fridge-freezer is in operation, do not touch the cold surfaces in the freezer compartment, particularly when hands are damp or wet. Skin may adhere to these extremely cold surfaces.

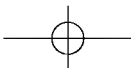



Important Safety Instruction

Precaution

Pull out the power plug prior to cleaning the fridge-freezer.

Never damage, severely bend, pull out, or twist the power cord because power cord damage may cause a fire or electronic shock.

Never place glass products in the freezer because they may be broken when their inner contents are frozen.

Don't Use an Extension Cord

If possible, connect the fridge-freezer to its own individual electrical outlet to prevent it and other appliances or household lights from causing an overload.

Power Cord Replacement

If the supply cord is damaged, it must be replaced by a special cord or assembly from the manufacturer or its service agent.

Danger

Risk of child entrapment.
Before you throw away your old refrigerator or freezer:
Take off the doors.
Leave the shelves in place so that children may not easily climb inside.

Don't store

Don't store or use gasoline or other flammable vapors and liquids in the vicinity of this or any other appliance.

Grounding (Earthing)

In the event of an electric short circuit, grounding (earthing) reduces the risk of electric shock by providing an escape wire for the electric current. In order to prevent possible electric shock, this appliance must be grounded. Improper use of the grounding plug can result in an electric shock. Consult a qualified electrician or service person if the grounding instructions are not completely understood, or if you have doubts on whether the appliance is properly grounded.

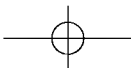



Identification of Parts

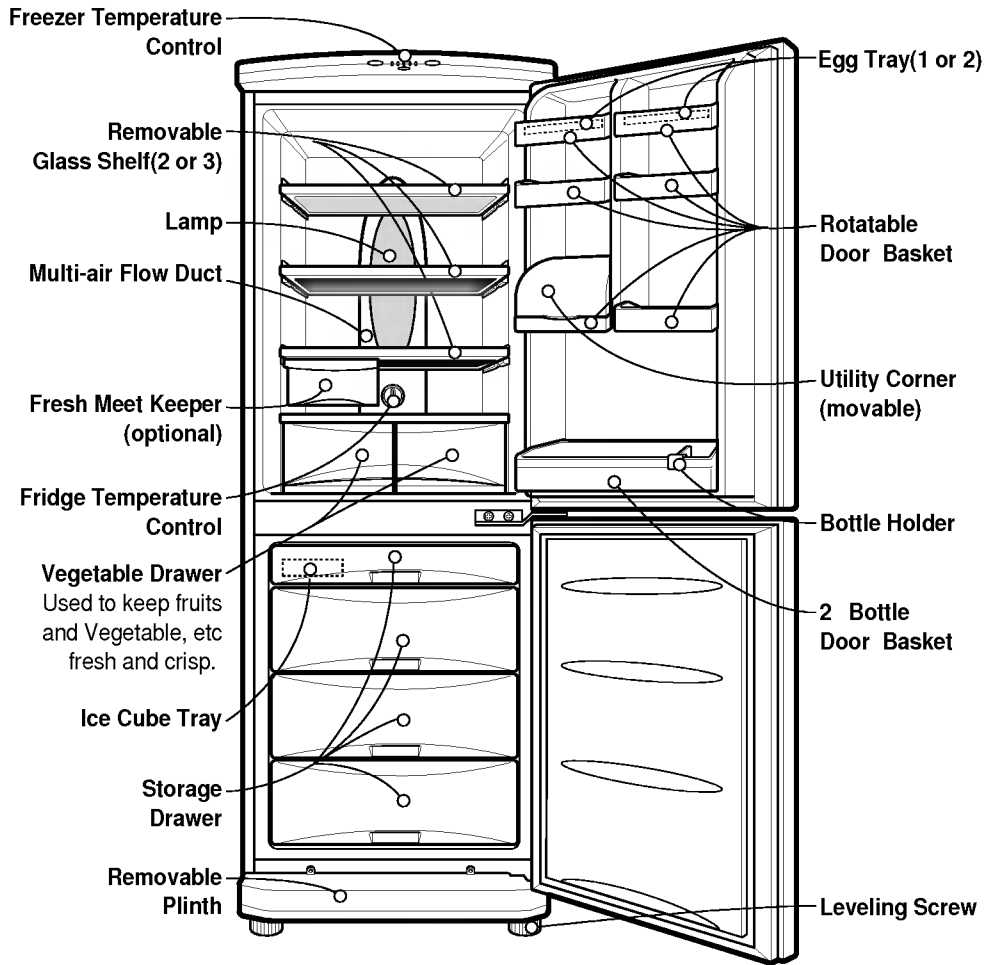

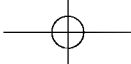

If you found some parts missing from your unit, they may be parts only used in other models.



Installation

Installation

1. Select a good location.
Place your fridge-freezer where it is easy to use.
2. Avoid placing the unit near heat sources, direct sunlight or moisture.
3. There must be proper air circulation around your fridge-freezer to keep it operating efficiently.
If your fridge-freezer is placed in a recessed area in the wall, allow at least 2 inches(5 cm) above.
4. To avoid vibration, the unit must be leveled.
If required, adjust the leveling screws to compensate for the uneven floor.
The front should be slightly higher than the rear to aid in door closing.
Leveling screws can be turned easily by tipping the cabinet slightly.
Turn the leveling screws counterclockwise() to raise the unit, clockwise() to lower it.
5. Clean your fridge-freezer thoroughly and wipe off all dust accumulated during shipping.
6. Install accessories such as ice cube box, etc., in their proper places.They are packed together to prevent possible damage during shipment.
7. Connect the power supply cord (or plug) to the outlet.
Don't double up with other appliances on the same outlet.

Starting

When your fridge-freezer is installed, allow it 2-3 hours to stabilize at normal operating temperature prior to filling it with fresh or frozen foods.
If power plug is disconnected, allow 5 minutes delay before restarting.
Your fridge-freezer is now ready for use.

Operation

Temperature Control

Your fridge-freezer has two controls that let you regulate the temperature in the fridge and freezer compartments.

Fridge

- Initially set the TEMP. CONTROL at "4". Then adjust the compartment temperature according to your desire.

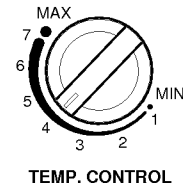

- If you want an inside temperature slightly less cold or colder, turn the knob towards MIN or MAX, respectively. When the surrounding temperature is low, adjust the TEMP. CONTROL 'MIN'.

Freezer

- Freezer temperature control is on the top of the fridge-freezer. Initially set the Freeze Temp at mid-point. By pressing the Freezer Temp button, you can adjust the temperature of the Freezer as indicated by the numbers of lamps lit. (the setting is composed of five steps, 5 lamps lit indicates coldest.)
- When you starting the Fridge-Freezer or connecting the power plug to the outlet, temperature setting is automatically set to the mid-point.

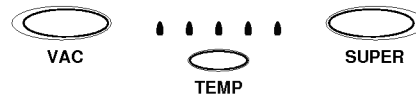

Quick Freeze

- This function is used when you want to freeze the foods quickly. Press the 'SUPER' button once, and then the quick freeze operation starts with the lamp lit.

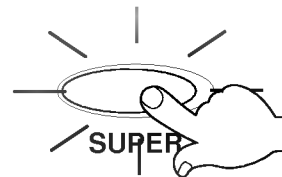

The quick freeze operation takes about 3 hours.

When its operation ends,

it automatically returns to the normal state.

If you want to stop the quick freeze operation, press the 'SUPER' button once more, the lamp goes out, and the quick freeze operation stops and the refrigerator returns to the normal state.

Vacation

This function makes the fridge-freezer work in a power saving mode which is useful for when you are away on holiday, by reducing energy consumption as much as possible. Pressing 'VAC' starts operation with lamp ON and pressing it again stops the operation.

For better functioning, you should set the TEMP. CONTROL to "MIN" .

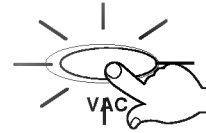
**Self Test**

This function allows you to check for operational problems. If you think you have a problem with your fridge-freezer, then press the temperature control button:

- If the indicate lights move up or down, then there is no problem with your fridge-freezer.
- If the indicate lights do not move up or down, then please leave the power connected and call your nearest service agent.

Door Alarm

When the door of the fridge-freezer or the freezer is left opened for a while, the alarm sounds.

Ice Making

- To make ice cubes, fill the ice tray to the water level and place it in the freezer.
- If ice cubes are required fast, press the 'SUPER' button.
- To remove ice cubes, hold the tray at its ends and twist gently.

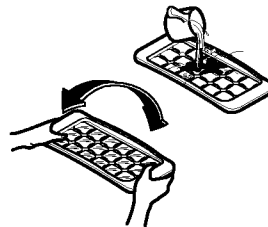

To remove ice cubes easily, run water on the tray before twisting.

Defrosting

Defrosting takes place automatically. The defrosting water flows down to the evaporating tray and is evaporated automatically.



Storing Food

- Do not store food which goes bad easily at low temperature, such as banana, and melon.
- Allow hot food to cool prior to storing. Placing hot food in the fridge-freezer could spoil other food, and lead to higher electric bills.
- When storing the food, use a container with a lid. This prevents moisture from evaporating, and helps food to keep its taste and nutrients.
- Do not block air vents with food. Smooth circulation of cold air keeps fridge-freezer temperature even.
- Do not open the door frequently. Opening the door lets warm air enter the fridge-freezer, and cause temperature to rise.
- To adjust the temperature control easily, do not store food near the temperature control dial.
- Never keep too many foods in door rack, as this may stop the door from fully closing.
- Do not store bottles in the freezer compartment - they may break when frozen.
- Do not refreeze food that has been thawed. This causes loss of taste and nutrition.

If you keep the fridge-freezer in a hot, and humid place, frequently open its door or put a lot of vegetables in it, dew may form in it, which has no effect on its performance.
Remove the dew with dust cloth free from care.

Care and Maintenance

General Information

Power Failure

- 1~2 hour power failure does no harm to the foods stores. Try to avoid opening and closing the door too frequently.

If You Move

- Take out foods from the fridge-freezer and firmly fix the loose items with tape.
- Turn the leveling screws until they stop before moving the fridge-freezer. Otherwise the screw may scratch the floor or the fridge-freezer cannot move.

Anti Condensation Pipe

- The Anti-Condensation pipe is installed around the front side of fridge-freezer as well as on the partition between fridge compartment and freezer compartment to prevent dewing.

Anti-Condensation Pipe

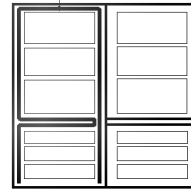

- Especially after installation or when ambient temperature is high, the fridge-freezer may feel hot, which is quite normal.

Lamp Replacement

1. Unplug the power cord from the outlet.
2. Remove fridge shelves.
3. To remove the lamp cover, insert \ominus type driver in the underside of the lamp cover and pull it out forwards.
4. Turn the lamp counterclockwise.
5. Assemble in reverse order of disassembly.
Replacement lamp must be the same specification as original.

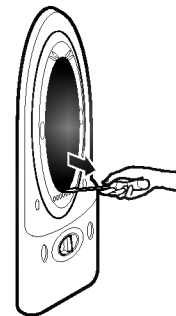



Cleaning

Before Cleaning

Be sure to unplug the power.

Exterior

Clean the outside of the fridge-freezer with a soft cloth soaked with hot water or liquid detergent. If you use a detergent, be sure to wipe it with a clean wet cloth.

Interior

As above.

After Cleaning

Check that the power cord is not damaged, power plug has not overheated, and that the power plug is tightly inserted into the outlet.

Warning

Be sure to dry the appliance with a cloth after washing it with water.

Do not use abrasive, petroleum, benzene, thinner, hydrochloride acid, boiling water, rough brush, etc, as they may damage parts of the fridge-freezer.

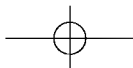
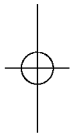

Trouble Shooting

**Before calling for service, check this list.
It may save you both time and expense.
This list includes common occurrences that are not
the result of defective workmanship or materials in
this appliance.**

Problem	Possible Causes
Fridge-Freezer does not operate	<ul style="list-style-type: none"> • Power plug may be unplugged from the electric outlet. Plug it in securely. • House fuse has blown or circuit breaker has tripped. Check and/or replace fuse and reset circuit breaker. • Power cut. Check house lights.
Fridge or Freezer Compartment Temperature too warm	<ul style="list-style-type: none"> • Temperature control not set on proper position. Refer to Temperature Control section. • Appliance is placed close to heat source. • Warm weather-frequent door openings. • Door left open for a long time. • Package holding door open or blocking air duct in freezer compartment.
Vibration or Rattling or Abnormal Noise	<ul style="list-style-type: none"> • The floor on which the fridge-freezer is installed may be uneven or the fridge-freezer may be unstable. Make it even by rotating the leveling screw. • Unnecessary objects placed in the back side of the fridge-freezer.
Frost or Ice Crystals on frozen Food	<ul style="list-style-type: none"> • Door may have been left ajar or package holding door open. • Too frequent or too long door openings. • Frost within package is normal.
Moisture forms on Cabinet Surface	<ul style="list-style-type: none"> • This phenomenon is likely to occur in a wet space. Wipe it with a dry towel.

Trouble Shooting

Problem	Possible Causes
Moisture collects inside	<ul style="list-style-type: none">• Too frequent or too long door openings.• In humid weather, air carries moisture into fridge when doors are opened.
Fridge has odor	<ul style="list-style-type: none">• Foods with strong odors should be tightly covered or wrapped.• Check for spoiled food.• Interior needs cleaning. Refer to CLEANING section
Door not closing properly	<ul style="list-style-type: none">• Food package is keeping door open. Move packages that keep door from closing.• Fridge-freezer is not level. Adjust the leveling screws.• The floor on which the fridge-freezer is installed may be uneven or the fridge-freezer may be unstable. Slightly raise the front side with the leveling screw.
Interior light does not work	<ul style="list-style-type: none">• No power at outlet.• Light lamp needs replacing. Refer to the Lamp Replacement section

To Reverse the Doors

Your fridge-freezer is designed with reversible doors, so that they may open from either the left or right hand side to suit your kitchen design.

Precaution

1. Before reversing the door, first of all, you should take out food and accessories like shelves or trays which are not fixed in the fridge-freezer.
2. Use Torque Wrench or Spanner to fix or remove the bolt.
3. Do not lay the fridge-freezer down. This will cause problems.
4. Be careful not to drop the doors in disassembling or assembling.

How to Reverse the Doors

1. Remove screw ② and remove Cover ① and move Cap Cover ③. And, remove screw ④, Hinge-L ⑤, and remove pin ⑥. Remove the Freezer Door ●, and move the position of the cap ⑦. Move the position of bracket door ⑧ and screw ⑨.
2. Remove bolt ● and remove the Hinge-C ● and the Fridge Door ●. Move the position of the cap ●. Move the position of bracket door ● and screw ●.
3. Move the position of Hinge-U pin ●, and Cap, Top cover ●. Assemble the Fridge Door ●. Assemble Hinge-C ● and bolt ●. Assemble F-Door ●. Assemble the Hinge-L ⑤ and bolt ④. Assemble Low Cover ① and screw ②.

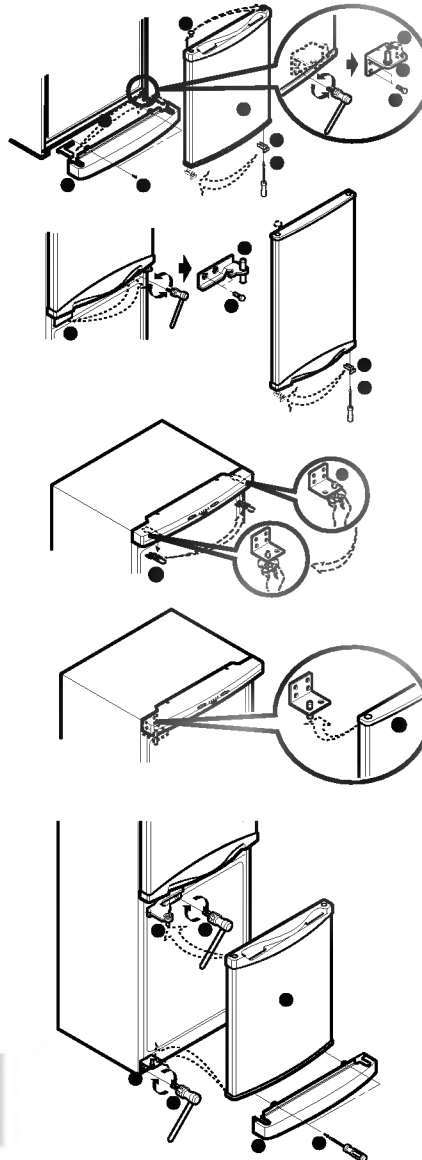

Reversing the doors is not covered by the warranty.

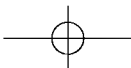
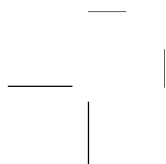
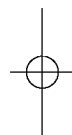
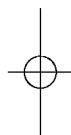
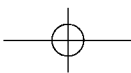

1C-340NF

- **Manual de ins**
- **Manual de ins**
- **Operating inst**
- **Mode d'emplo**