



# DVD PLAYER

## OWNER'S MANUAL

MODEL : DVD-2230P



Before connecting, operating or adjusting this product,  
please read this instruction booklet carefully and completely.

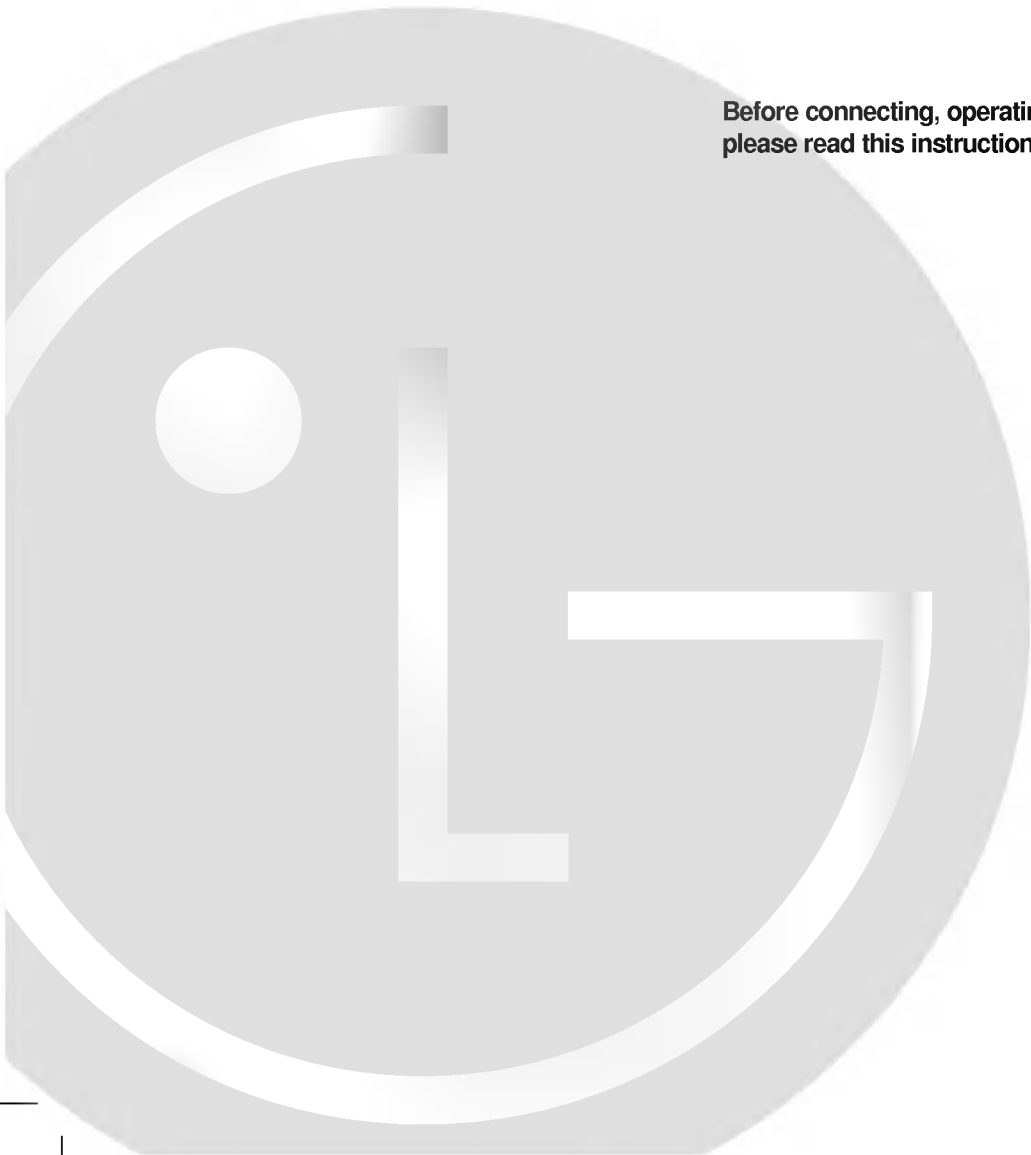

**WARNING:** TO REDUCE THE RISK OF FIRE OR ELECTRIC SHOCK, DO NOT EXPOSE THIS PRODUCT TO RAIN OR MOISTURE.

**CAUTION:** THIS DVD PLAYER EMPLOYS A LASER SYSTEM.

TO ENSURE PROPER USE OF THIS PRODUCT, PLEASE READ THIS OWNER'S MANUAL CAREFULLY AND RETAIN FOR FUTURE REFERENCE, SHOULD THE UNIT REQUIRE MAINTENANCE, CONTACT AN AUTHORIZED SERVICE LOCATION-SEE SERVICE PROCEDURE.

USE OF CONTROLS, ADJUSTMENTS OR THE PERFORMANCE OF PROCEDURES OTHER THAN THOSE SPECIFIED MAY RESULT IN HAZARDOUS RADIATION EXPOSURE.

TO PREVENT DIRECT EXPOSURE TO LASER BEAM, DO NOT TRY TO OPEN THE ENCLOSURE. VISIBLE LASER RADIATION WHEN OPEN THE ENCLOSURE. DO NOT STARE INTO BEAM.

**WARNING:** CHANGES OR MODIFICATIONS NOT EXPRESSLY APPROVED BY THE PARTY RESPONSIBLE FOR COMPLIANCE COULD VOID THE USER'S AUTHORITY TO OPERATE THE EQUIPMENT.

**CE** *This product is manufactured to comply with the radio interference requirements of EEC DIRECTIVE 89/336/EEC, 93/68/EEC and 73/23/EEC.*

RECORD YOUR MODEL NUMBER (Now, while you can see it)

The model and serial number of your new DVD player are located on the back of the DVD player cabinet. For your future convenience, we suggest that you record these numbers here:

MODEL NO. \_\_\_\_\_

SERIAL NO. \_\_\_\_\_

**Introduction**

- ❑ Safety Precautions . . . . . 2
- ❑ Table of Contents . . . . . 3
- ❑ Precautions . . . . . 4
- ❑ Notes on Discs . . . . . 5
- ❑ Identification of Controls . . . . . 6-9
  - Front Panel/Display window . . . . . 6
  - Rear Panel . . . . . 7
  - Remote Control . . . . . 8
  - Preparing the Remote Control . . . . . 9
  - Operating with the Remote Control . . . . . 9

**Connections**

- ❑ Connecting to a TV . . . . . 10
- ❑ Connecting to an Audio System . . . . . 11
- ❑ Connecting to Optional Equipment . . . . . 12-14
  - Enjoying Dolby Digital (AC-3) Sound . . . . . 12
  - Enjoying Dolby Pro Logic Surround Sound . . . . . 13
  - Enjoying 2 Channel Digital Stereo Sound . . . . . 14
  - Enjoying DTS Sound . . . . . 14

**Basic Operation**

- ❑ Basic Playback . . . . . 15-19
  - Basic Playback . . . . . 15-17
    - Playing at x2 Normal Speed or Scanning at High Speed . . . . . 18
    - Playing Frame by Frame . . . . . 18
    - Playing in Slow-Motion . . . . . 19
    - Resuming Playback from the Same Location . . . . . 19

**Operation Using GUI Menu Icons**

- ❑ General Information about GUI menu icons . . . . . 20
- ❑ Detailed description of each GUI menu icon . . . . . 21

**Advanced Operation**

- ❑ Using a title menu/DVD menu . . . . . 22
- ❑ Changing subtitle language . . . . . 23
- ❑ Changing audio soundtrack language . . . . . 24
- ❑ Viewing from another angle . . . . . 25
- ❑ Producing a 3D Surround effect . . . . . 25
- ❑ Repeat Play . . . . . 26
- ❑ Storing markers in memory to be viewed (listened to) again . . . . . 27
- ❑ Zooming Feature/Random Play . . . . . 28
- ❑ Program Play . . . . . 29

**Initial SETUP Operation**

- ❑ Setup . . . . . 30
- ❑ Selecting disc Languages . . . . . 31
- ❑ Selecting rating level and password . . . . . 32-33
- ❑ Selecting TV Aspect . . . . . 34
- ❑ Selecting Menu Language . . . . . 35
- ❑ Selecting Digital Audio Output . . . . . 36
- ❑ Table of Languages and Abbreviations . . . . . 37

**Reference**

- ❑ Disc Requirements/Copyright Information . . . . . 38
- ❑ Before Calling Service Personnel . . . . . 39
- ❑ Specifications . . . . . 40

### Notes on handling

- ❑ When shipping the DVD player, always use the original shipping carton and packing materials. For maximum protection, repack the unit as it was originally packed at the factory.
- ❑ Do not use volatile liquids, such as insect spray, near the DVD player. Do not leave rubber or plastic products in contact with the DVD player for a long time. They will leave marks on the finish.
- ❑ The top and rear panels of the DVD player may become warm after a long period of use. This is normal and not a malfunction.
- ❑ When the DVD player is not in use, be sure to remove the disc and turn off the power.
- ❑ If you do not use the DVD player for a long period, the unit may not function properly in the future. Turn on and use the DVD player occasionally.

### Notes on Locating

- ❑ When you place this DVD player near a TV, radio, or VCR, the playback picture may become poor and the sound may be distorted. In this case, move the DVD player away from the TV, radio, or VCR.

### Notes on Cleaning

#### Use a soft, dry cloth for cleaning.

- ❑ For stubborn dirt, soak the cloth in a weak detergent solution, wring well and wipe. Use a dry cloth to wipe it dry. Do not use any type of solvent, such as thinner and benzine, as they may damage the surface of the DVD player.
- ❑ If you use a chemical saturated cloth to clean the unit, follow that product's instructions.

**Warning:** Cleaning and adjustment of lenses and/or other components of playback mechanism should be performed by a qualified service technician.

### To Obtain a Clear Picture

The DVD player is a high technology, precision device. If the optical pick-up lens and disc drive parts are dirty or worn down, the picture quality becomes poor. To obtain a clear picture, we recommend regular inspection and maintenance (cleaning or parts replacement) every 1,000 hours of use depending on the operating environment. For details, contact your nearest dealer.

### Notes on Moisture Condensation

**Moisture condensation damages the DVD player. Please read the following carefully.**

Moisture condensation occurs, for example, when you pour a cold drink into a glass on a warm day, drops of water form on the outside of the glass. In the same way, moisture may condense on the optical pick-up lens inside this unit, one of the most crucial internal parts of the DVD player.

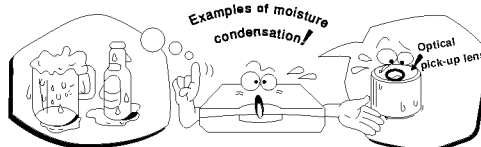

**Moisture condensation occurs during the following cases.**

- ❑ When you bring the DVD player directly from a cold place to a warm place.
- ❑ When you use the DVD player in a room where you just turned on the heater, or a place where the cold wind from the air conditioner directly hits the unit.
- ❑ In summer, when you use the DVD player in a hot and humid place just after you move the unit from an air conditioned room.
- ❑ When you use the DVD player in a humid place.

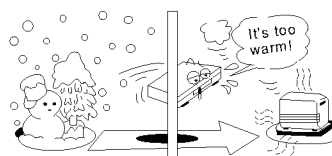

- ❑ **Do not use the DVD player when moisture condensation may occur.**

If you use the DVD player in such a situation, it may damage discs and internal parts. Remove the disc, connect the power cord of the DVD player to the wall outlet, turn on the DVD player and leave it "ON" for two or three hours. After two or three hours, the DVD player will have warmed up and evaporated any moisture. Keep the DVD player connected to the wall outlet and moisture condensation will seldom occur.

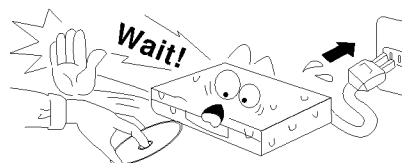

This section shows you how to handle, clean, and store discs.

### On Handling Discs

- Do not touch the playback side of the disc.

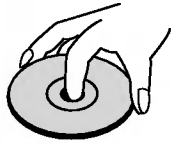

- Do not attach paper or tape to discs.



### On Storing Discs

- Do not store discs in a place subject to direct sunlight or near heat sources.
- Do not store discs in places subject to moisture and dust such as a bathroom or near a humidifier.
- Store discs vertically in a case. Stacking or placing objects on discs outside of their case may cause warping.

### On Cleaning Discs

- Fingerprints and dust on the disc cause picture and sound deterioration. Wipe the disc from the center outward with a soft cloth. Always keep the disc clean.
- If you cannot wipe off the dust with a soft cloth, wipe the disc lightly with a slightly moistened soft cloth and finish with a dry cloth.
- Do not use any type of solvents such as thinner, benzene, commercially available cleaners or anti-static spray for vinyl LPs. They may damage the disc.



### About This Owner's Manual

- This owner's manual explains the basic instructions of this DVD player.
- Some DVD video discs have functions that may not be explained in this owner's manual. Therefore, some instructions may differ from this owner's manual, and there may be extra instructions. In this case, follow the instructions displayed on the TV screen or package.
- "⊗" may appear on the TV screen during operation. This icon means the function explained in this owner's manual is not available on that specific DVD video disc.

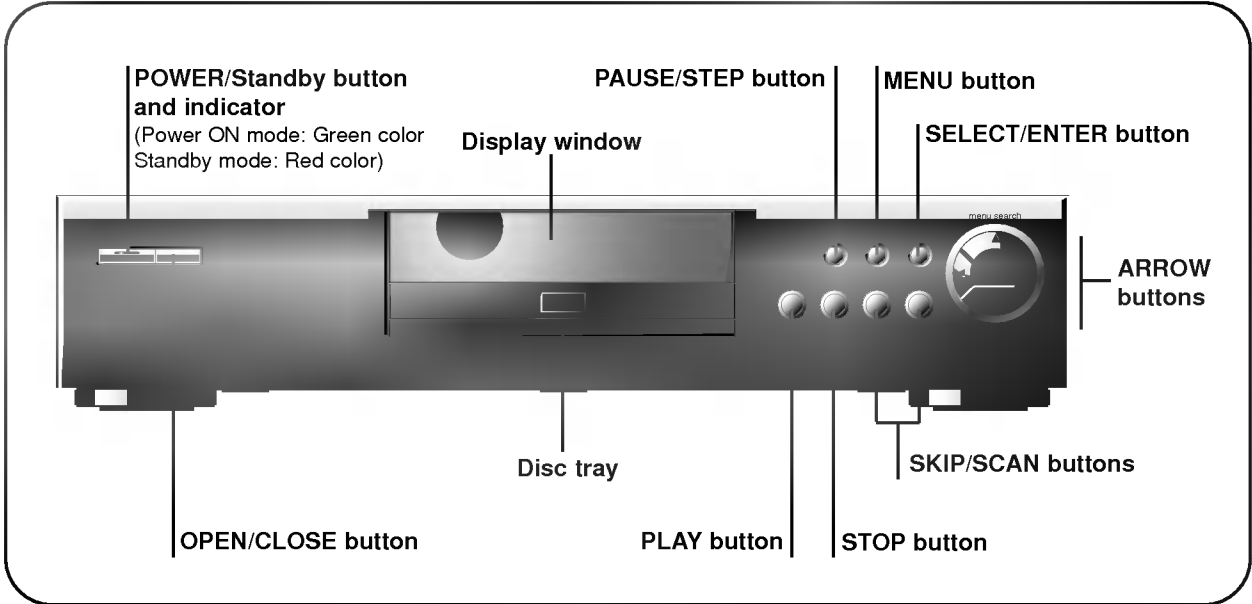

### Display Window

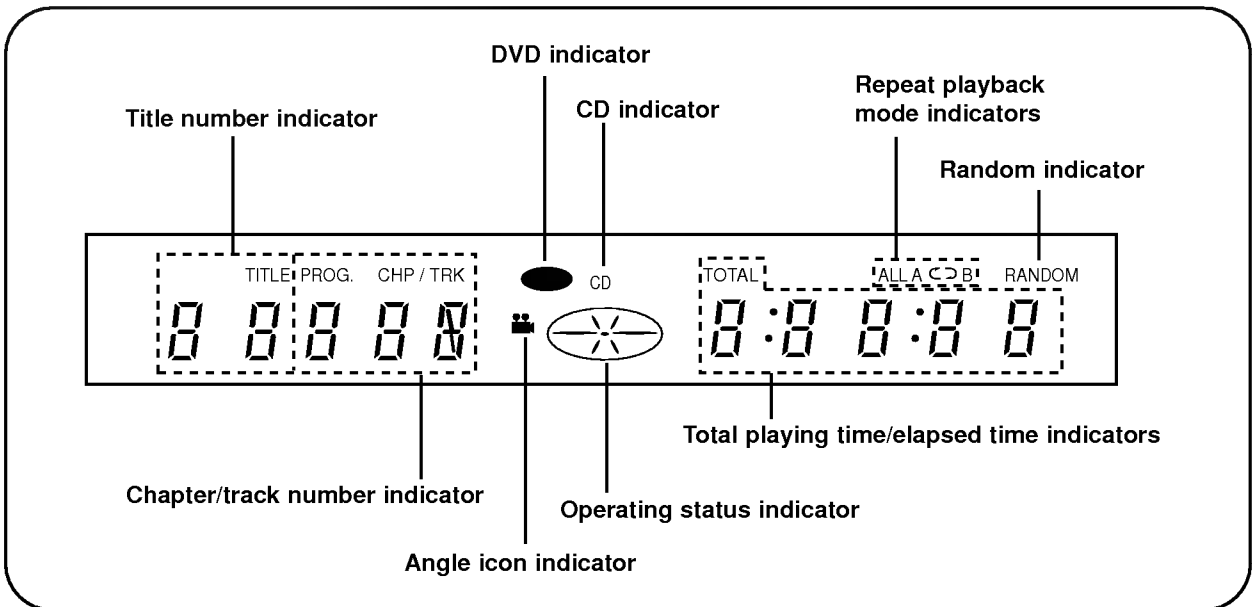

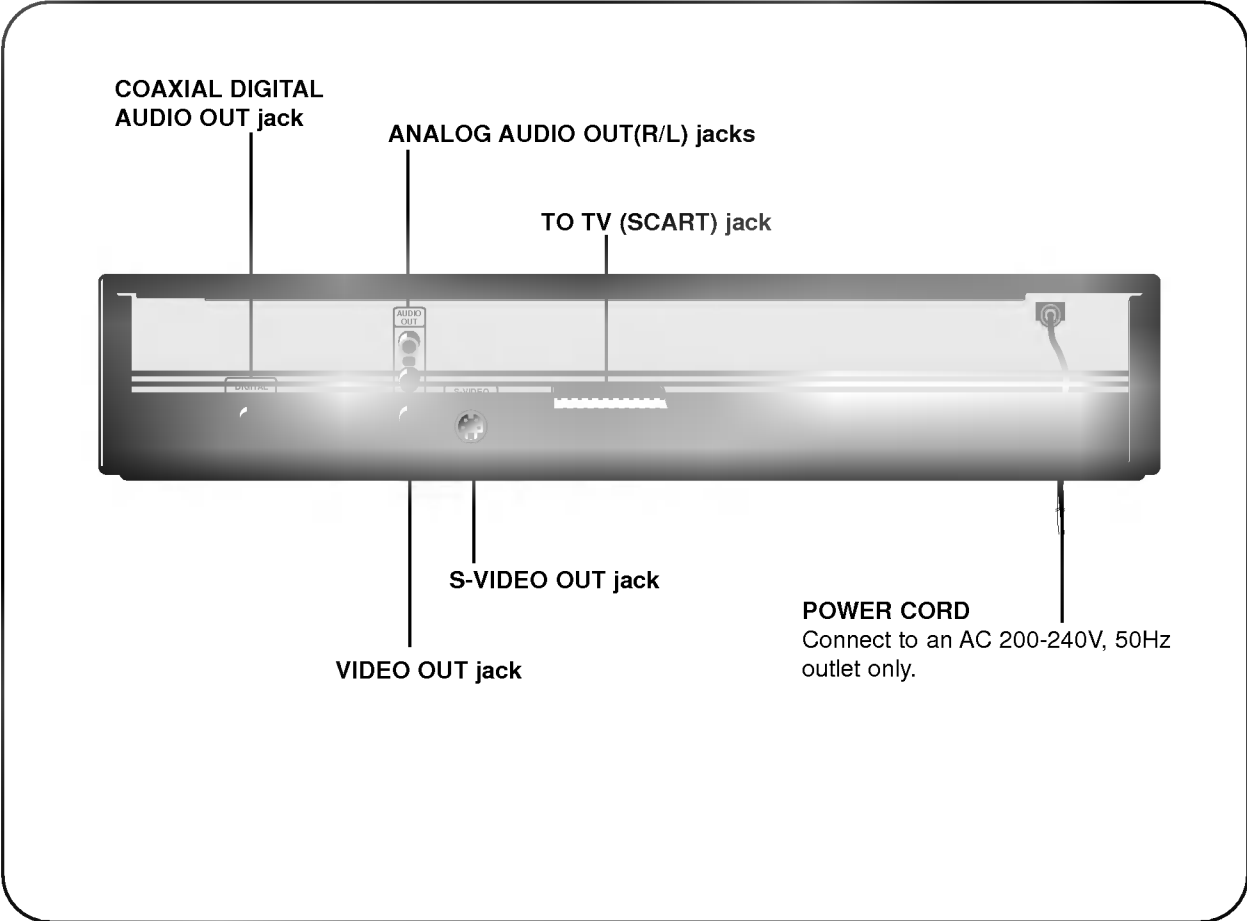

**REMOTE CONTROL**

You will find instructions for each of the remote control functions in the appropriate sections of this instruction manual.

**POWER button**

**REPEAT button**

**SETUP button**

**SUBTITLE button**

**AUDIO button**

**\*\*\*TITLE button**

**SELECT/ENTER button**

**DISPLAY button**

**ZOOM button**

**FWD/REV SCAN button**

**STOP button**

**PAUSE/STEP button**

**RESUME button**

**Number buttons**

**CLEAR button**

**OPEN/CLOSE button**

**A-B button**

**RANDOM button**

**ANGLE button**

**SOUND button**

**\*MENU button**

**\*\*ARROW buttons**

**RETURN button**

**MARKER-SEARCH button**

**PLAY button**

**FWD/REV SKIP button**

**SLOW buttons**

**PROGRAM button**

**\*\*\*TITLE button**  
Use the TITLE button to display the title screen included on DVD video discs. To operate a menu screen, follow the instructions in "Using a Title Menu" (page 22).

**\*MENU button**  
Use the MENU button to display the menu screen included on DVD video discs. To operate a menu screen, follow the instructions in "Using a DVD Menu" (page 22).

**\*\* Directional arrow buttons**  
(up, down, left, right) for use in highlighting a selection on a GUI menu screen, TITLE and MENU screen.



## Preparing the Remote Control

Insert the batteries into the remote control so you can use it to operate the DVD player.

### Open the battery cover.

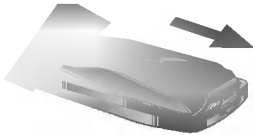

### Insert batteries (AAA size).

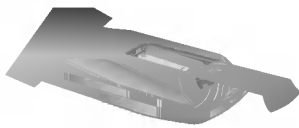

- Make sure to match the + and - on the batteries to the marks inside the battery compartment.

### Close the cover.

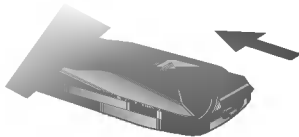

- Improper use of batteries may cause battery leakage and corrosion.
- To operate the remote control correctly, follow the instructions below.
- Do not insert the batteries into the remote control in the wrong direction.
- Do not charge, heat, open, or short-circuit the batteries. Do not throw the batteries into fire.
- Do not leave dead or exhausted batteries in the remote control.
- Do not use different types of batteries together, or mix old and new batteries.
- If you do not use the remote control for a long period of time, remove the batteries to avoid possible damage from battery corrosion.
- If the remote control does not function correctly or if the operating range becomes reduced, replace all batteries with new ones.
- If battery leakage occurs, wipe the battery liquid from the battery compartment, then insert new batteries.
- The batteries should last about one year with normal use.

## Operating with the Remote Control

This section shows you how to use the remote control.

Point the remote control at the remote sensor and press the buttons.

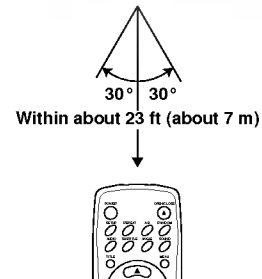

Distance: About 23 ft (7 m) from the front of the remote sensor

Angle: About 30° in each direction of the front of the remote sensor

- \* Do not expose the remote sensor of the DVD player to a strong light source such as direct sunlight or illumination. If you do so, you may not be able to operate the DVD player with the remote control.

- Direct the remote control at the remote sensor of the DVD player.
- Do not drop or give the remote control a shock.
- Do not leave the remote control near extremely hot or humid place.
- Do not spill water or put anything wet on the remote control.
- Do not open the remote control.

Connect the DVD player to your TV

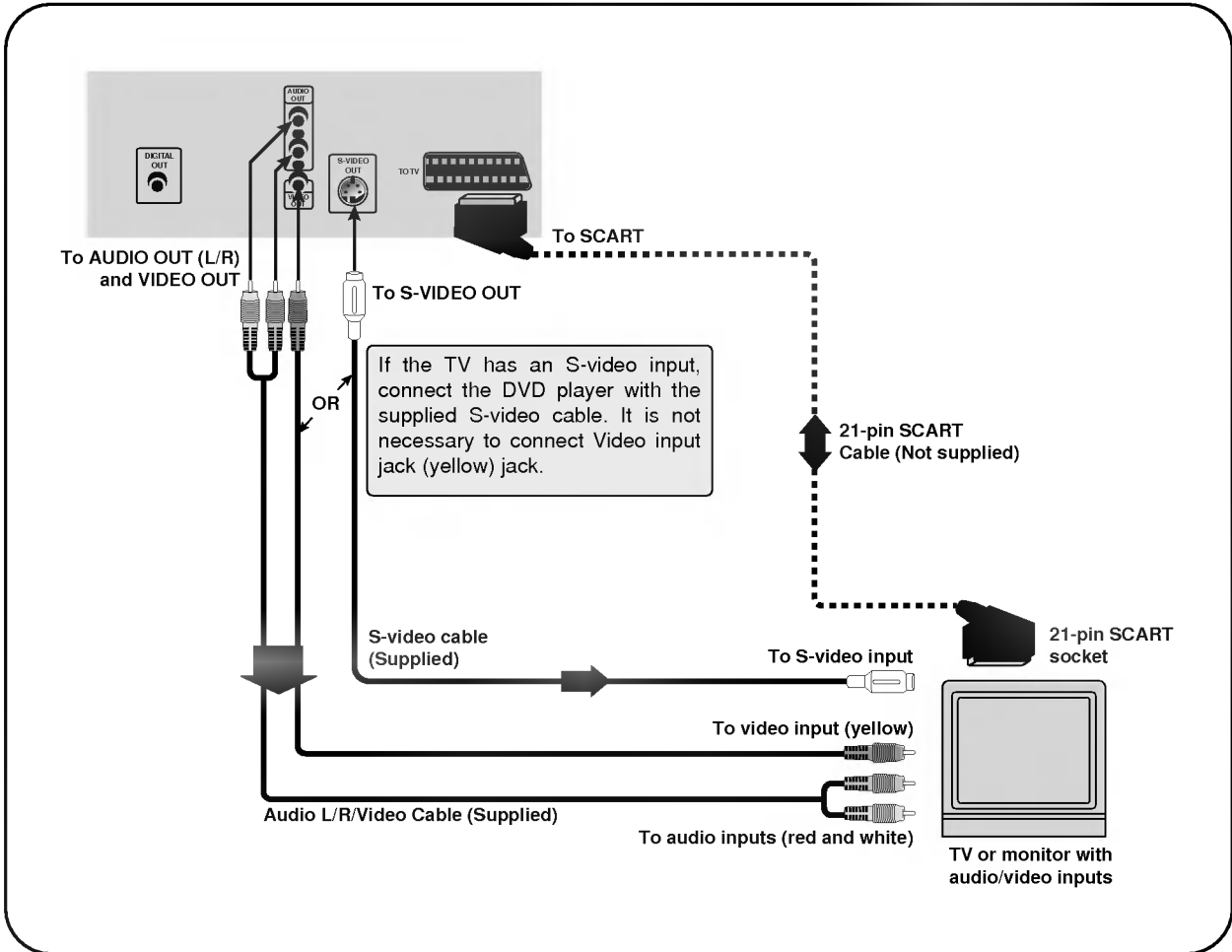

- Refer to the owner's manual of your TV as well.
- When you connect the DVD player to your TV, be sure to turn off the power and unplug both units from the wall outlet before making any connections.
- If your television set has one audio input, connect the DVD player to a Y cable adapter (not supplied) and then connect to your TV.
- Connect the DVD player to your TV directly. If you connect the DVD player to a VCR, the playback picture will be distorted because DVD video discs are copy protected.

**Warning**

Do not set the Digital Audio Output of this DVD player to "Dolby Digital" unless you are connecting the coaxial digital audio jack of this DVD player to an AV decoder that has the Dolby Digital (AC-3) decoding function. High volume sound may damage your hearing as well as the speakers. (Refer to "Selecting Digital Audio Output" on page 36.)

You can listen to the sound of audio CDs and DVD video discs in stereo.

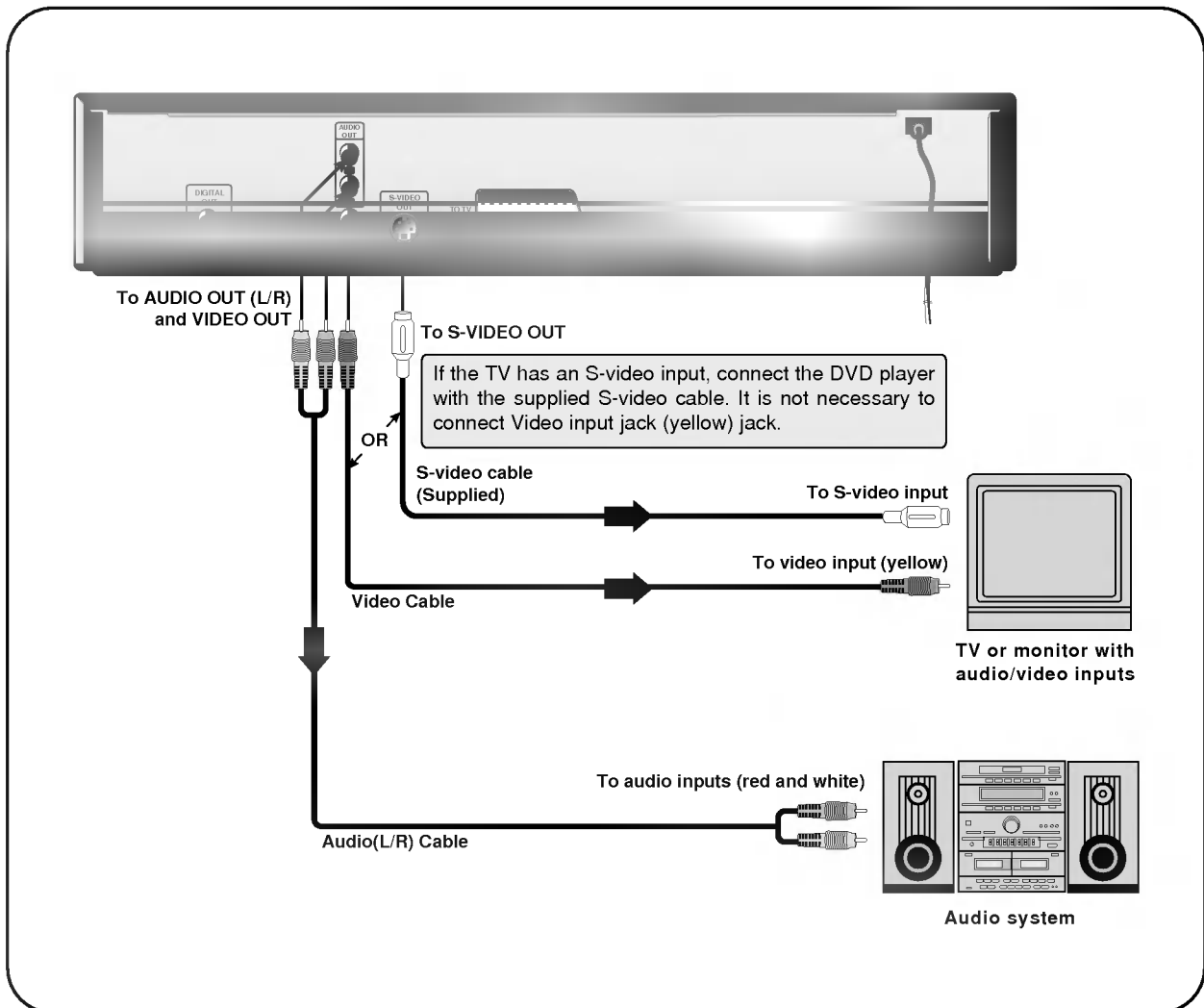

- Refer to the owner's manual of your audio system as well.
- When you connect the DVD player to other equipment, be sure to turn off the power and unplug all of the equipment from the wall outlet before making any connections.
- If you place the DVD player near a tuner or radio, the radio broadcast sound might be distorted. In this case, move the DVD player away from the tuner and radio.
- The output sound of the DVD player has a wide dynamic range. Be sure to adjust the receiver's volume to a moderate listening level. Otherwise, the speakers may be damaged by a sudden high volume sound.
- Turn off the receiver before you connect or disconnect the DVD player's power cord. If you leave the receiver power on, the speakers may be damaged.

**⚠ Warning**

Do not set the Digital Audio Output of this DVD player to "Dolby Digital" unless you are connecting the coaxial digital audio jack of this DVD player to an AV decoder that has the Dolby Digital (AC-3) decoding function. High volume sound may damage your hearing as well as the speakers. (Refer to "Selecting Digital Audio Output" on page 36.)

## Enjoying Dolby Digital (AC-3) Sound

You can enjoy the high quality dynamic sound of Dolby Digital (AC-3), Dolby Pro Logic, and 2 Channel Digital Stereo.

### Dolby Digital (AC-3)

Dolby Digital is the surround sound technology used in theaters showing the latest movies, and is now available to reproduce this realistic effect in the home. You can enjoy motion picture and live concert DVD video discs with this dynamic realistic sound by connecting the DVD player to a 6 channel amplifier equipped with a Dolby Digital (AC-3) decoder or Dolby Digital (AC-3) processor.

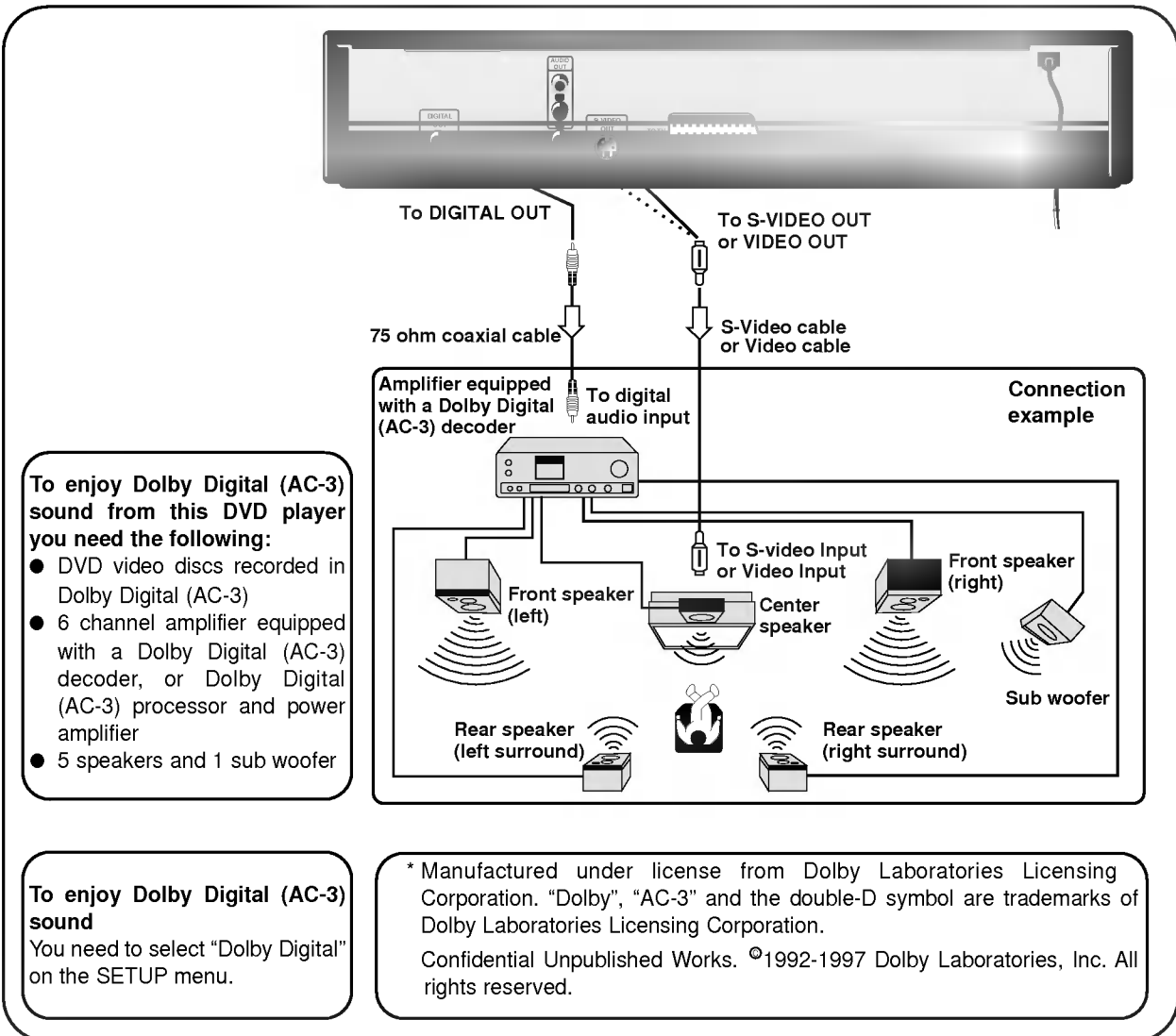

- Refer to the owner's manual of your audio equipment as well.
- When you connect the DVD player to other equipment, be sure to turn off the power and unplug all of the equipment from the wall outlet before making any connections.
- The output sound of the DVD player has a wide dynamic range. Be sure to adjust the receiver's volume to a moderate listening level. Otherwise, the speakers may be damaged by a sudden high volume sound.
- Turn off the amplifier before you connect or disconnect the DVD player's power cord. If you leave the amplifier power on, the speakers may be damaged.

## Enjoying Dolby Pro Logic Surround Sound

### Dolby Pro Logic Surround

You can still enjoy the excitement of Surround Sound even if your A/V receiver does not offer Dolby Digital (AC-3) decoding. If your A/V receiver has a Dolby Pro Logic decoder. Refer to the following connection diagram.

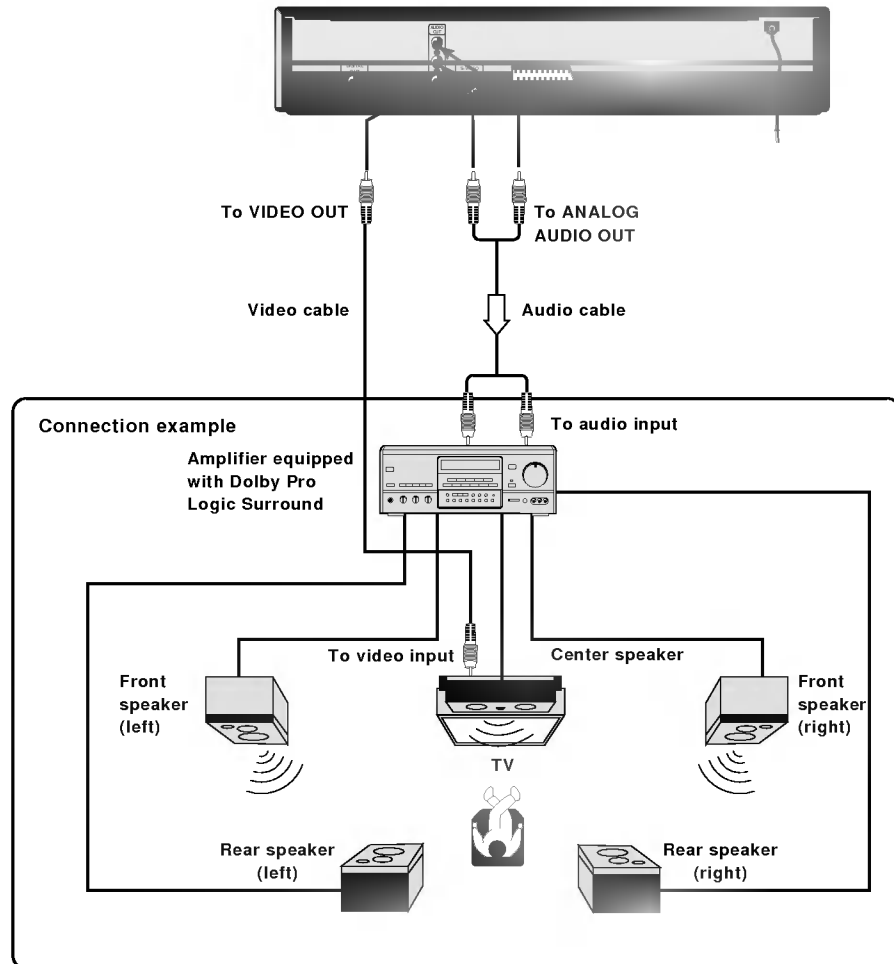

Connect one or two rear speakers. The output sound from the rear speakers will be monaural even if you connect two rear speakers.

- **With a receiver equipped with Dolby Digital (AC-3)**  
Connect the equipment the same way as described in "Enjoying Dolby Digital (AC-3) Sound" on the previous page. Refer to that receiver's owner's manual and set the receiver so you can enjoy Dolby Pro Logic Surround sound.

### ⚠ Warning

Do not set the Digital Audio Output of this DVD player to "Dolby Digital" unless you are connecting the coaxial digital audio jack of this DVD player to an AV decoder that has the Dolby Digital (AC-3) decoding function. High volume sound may damage your hearing as well as the speakers. (Refer to "Selecting Digital Audio Output" on page 36.)

## Enjoying 2 Channel Digital Stereo Sound

### 2 Channel Digital Stereo

You can enjoy the dynamic sound of 2 Channel Digital Stereo by connecting this DVD player to a receiver equipped with a digital audio input and speaker system (right and left front speakers).

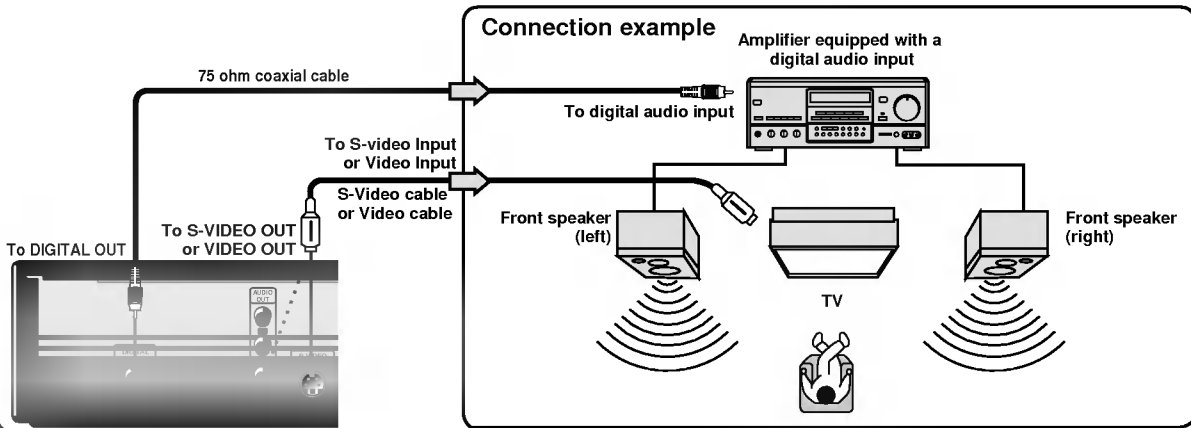

## Enjoying DTS Sound

**Introducing DTS Digital Surround™**...the finest technology ever invented to transform existing "home theater" systems into six discrete channels of exceptionally clear, better-than-compact disc, digital audio performance. DTS Digital Surround is the only 5.1 surround sound format that can deliver this revolutionary 3-dimensional experience through new music recordings on compact discs, original 5.1 soundtracks on motion picture laserdiscs, and soon, a wide variety of products on DVD.

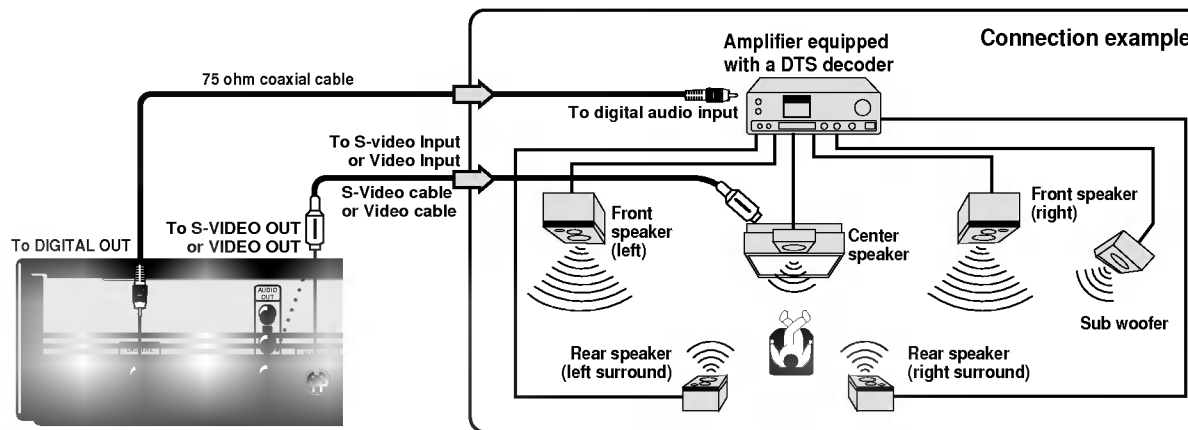

"DTS" and "DTS Digital Out" are trademarks of Digital Theater Systems, Inc.

- Refer to the owner's manual of your receiver as well.
- When you connect the DVD player to other equipment, be sure to turn off the power and unplug all of the equipment from the wall outlet before making any connections.
- The output sound of the DVD player has a wide dynamic range. Be sure to adjust the receiver's volume to a moderate listening level, otherwise, the speakers may be damaged by a sudden high volume sound.
- Turn off the receiver before you connect or disconnect the DVD player's power cord. If you leave the receiver power on, the speakers may be damaged.



This section shows you the basics on how to play back a DVD video disc.

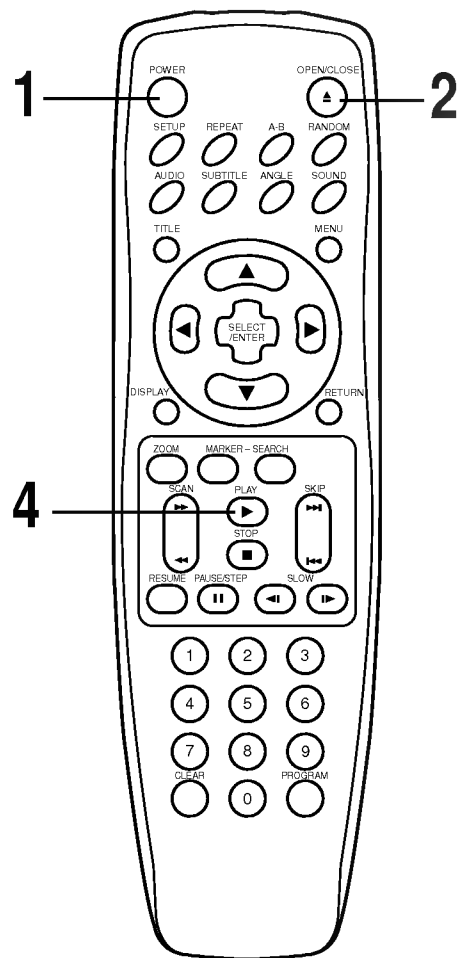
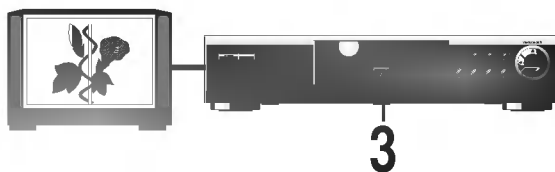

**Preparations**

- When you want to play back DVD video discs, turn on the TV and select the video input source connected to the DVD player.
- When you want to enjoy the sound of DVD video discs or audio CDs from the audio system, turn on the audio system and select the input source connected to the DVD player.
- For connection details, see pages 10 through 14.
- Set the playback picture size according to the aspect ratio of the connected TV.
- If you do not have the necessary equipment to enjoy Dolby Digital (AC-3) sound, set the Digital Audio Output at the SETUP menu to "PCM".

**Press POWER.**  
The DVD player turns on and the power indicator goes on.

**Press OPEN/CLOSE.**  
The disc tray opens.  
● You can open the disc tray by pressing this button even if the DVD player is turned off.

**Place a disc on the disc tray with the playback side down.**  
● If the disc is placed in upside down (and it is a single sided disc), the DVD display will indicate "NO DISC" or "DISC ERROR".  
● There are two different disc sizes. Place the disc in the correct guide on the disc tray. If the disc is out of the guide, it may damage the disc and cause the DVD player to malfunction.  
● Do not place anything except 3" discs or 5" discs on the disc tray.

**Press PLAY.**  
The disc tray is automatically closed and playback begins.



playback indicator

- If you insert an audio CD, the CD indicator lights up in the DVD display. The title number does not appear.
- After playing back all of the chapters in the title, the DVD player automatically stops and returns to the menu screen.

**When a menu screen appears on the TV screen.**  
In case of interactive DVDs with control, a menu screen appears on the TV screen. Perform step 5 on page 16 to start play.

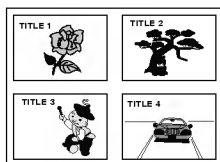

Example of interactive DVD On-Screen Menu



Press ▲/▼/◀▶ and press SELECT/ENTER, or press the numeric button(s), to select the desired item.

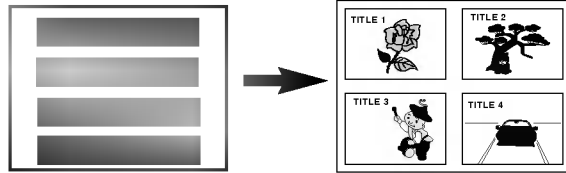
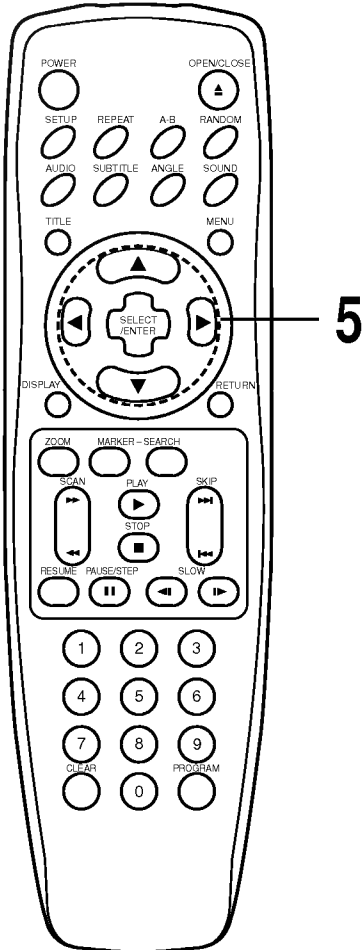

Play of the selected item now begins.

- For further info, refer to the jacket or case of the disc you are playing.

**After operation**

When the unit is not in use, remove the disc and press POWER to turn off the power.

- Do not move the DVD player during playback. Doing so may damage the disc.
- Use the OPEN/CLOSE button on the remote control or DVD player to open and close the disc tray. Do not push the disc tray while it is moving. Doing so may cause the DVD player to malfunction.
- Do not push up the disc tray or put any objects other than discs on the disc tray. Doing so may cause the DVD video player to malfunction.
- Keep your fingers well clear of the disc tray as it is closing. Be especially careful with children's fingers around the closing disc tray as there is a risk of personal injury.
- When "⊘" appears on the TV screen while a button is pressed, it means that this function is not available on the disc you are playing.
- Depending on the DVD disc, some operations may be different or restricted. Refer to the jacket or case of the disc you are playing.



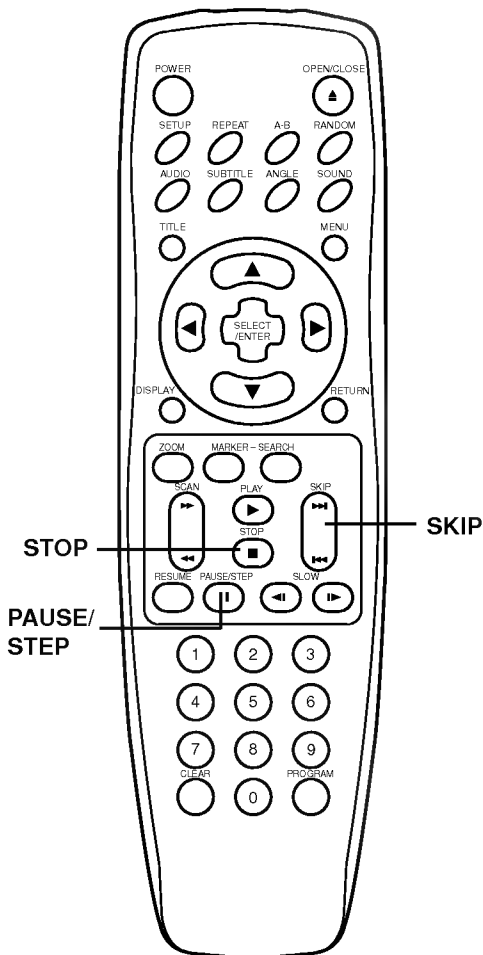

**Press STOP during playback.**

**For your convenience**

- When play is stopped, the unit records the point where STOP was pressed (RESUME function). Press RESUME, and play will resume from this point. When the tray is opened or PLAY is pressed again, the RESUME function will be cleared. The RESUME function works only with discs for which the elapsed playing time appears on the window display during playback. This feature will be cleared when the power is turned OFF and then ON.

- The Resume function may not be available on some DVD discs.
- If the player is left in the stop mode for more than 8 minutes, the power shuts off automatically.

**Press PAUSE/STEP during playback.**

- DVD  
The player will be placed in the still picture mode.
- CD  
The player will be placed in the pause mode.

**To return to normal playback, press PLAY.**

**Skipping forward**

**Press SKIP ►► during play.**

A chapter (DVD) or a track (CD) is skipped each time the button is pressed.

**Skipping back**

**Press SKIP ◄◄ during play.**

- When the button is pressed once midway through a chapter/track, the player returns to the start of that chapter/track. When it is pressed again immediately, a chapter/track is skipped each time the button is pressed.

**Playing at x2 Normal Speed or Scanning at High Speed**



You can play back discs at various speeds, and resume normal playback.

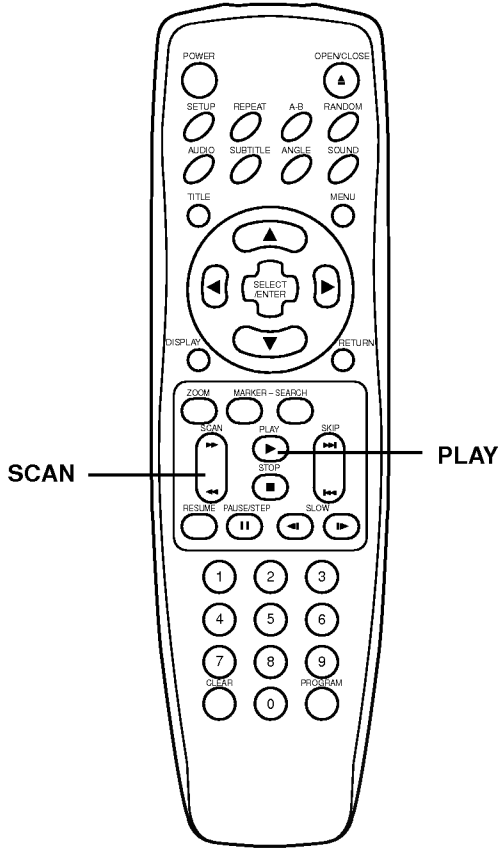

**To playback at 2 times (x2) the normal speed**

**Press SCAN ►► button during playback.**

The "SCAN 1" appears on the TV screen.

- The playback speed becomes x2 the normal speed. Pressing the PLAY button again changes the playback speed to the normal speed.
- The x2 playback does not operate in case of audio CD.

**To Scan at fast forward or fast reverse playback.**

**Hold down the SCAN ◀◀ or ►► button during playback.**

- The speed of scan is relatively slow at first and becomes faster. (The speed increases up to 3 steps in case of DVD disc.)

**To return to normal playback, release the SCAN ◀◀ or ►► button.**

- The DVD player does not play back sound during the high speed reverse and forward playback of DVD video discs. However, the DVD player plays back sound during fast forward or fast reverse playback of audio CDs.

**Playing Frame by Frame**

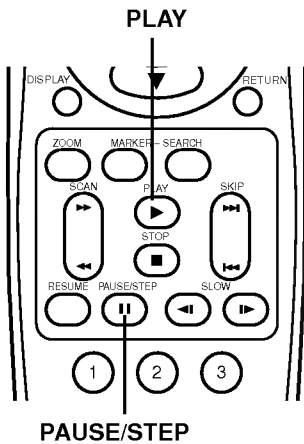

You can advance a DVD video disc frame by frame.

**Press PAUSE/STEP during still playback.**

Each time you press the PAUSE/STEP button, the picture advances one frame.

**To return to normal playback, press PLAY.**

- The sound is muted during frame by frame playback.
- The Frame advance function is operated forward only.



### Playing in slow-motion

You can play back a DVD video disc in slow-motion.

**Press SLOW ◀ or ▶ during playback.**

The playback speed becomes X1/16 the normal speed.

[TV screen]

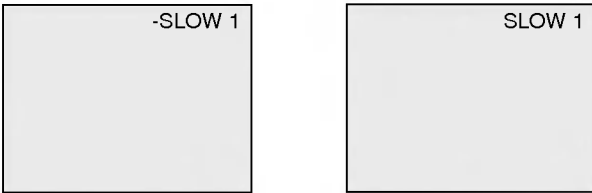

Each time you press the SLOW ◀ or ▶ button, the playback speed changes as follows.

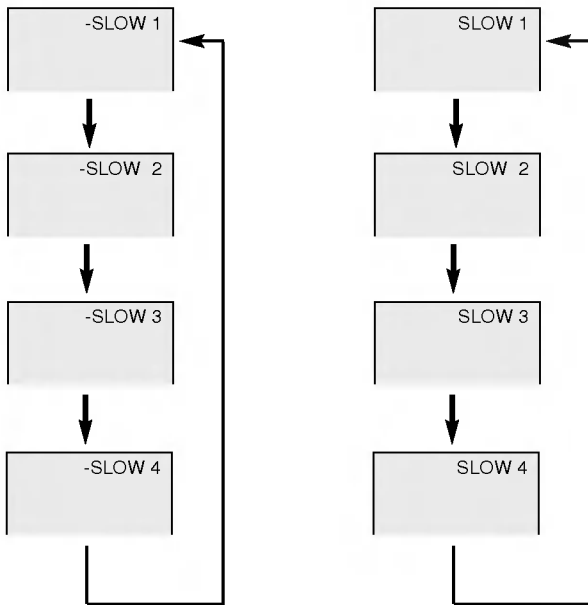

**To return to normal playback, press PLAY.**

- The sound is muted during slow-motion playback.
- Subtitles do not appear on the screen during slow motion playback.

### Resuming Playback from the same location

You can stop playback and resume playback later from the same location on the disc.

**Press STOP at the location where you want to interrupt playback.**

- The DVD player memorizes the location where you stopped playback.
- The DVD player stores that location in its memory, unless you turn off the player or open the disc tray.
- Opening the disc tray cancels this function.

**Press RESUME.**

The DVD player resumes playback immediately before the location where you stopped playback.

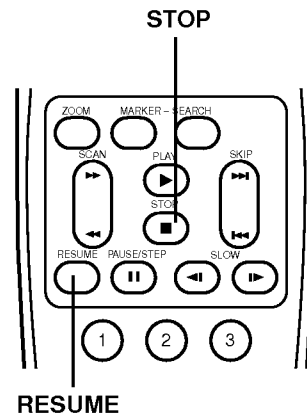

- The Resume function is cancelled if the DVD player is disconnected from the wall outlet, or if power is interrupted.
- The DVD player resumes playback from the beginning of the stopped chapter or track in case of audio CD.
- The Resume function may not be available on some DVD discs.



This unit features GUI Menu Icons showing disc information (title/chapter/track number, elapsed playing time, audio/subtitle language, angle, and sound) and player information (repeat play, play mode, marker, etc.). Some icons only show the indicated information. Other icons allow the settings to be changed.

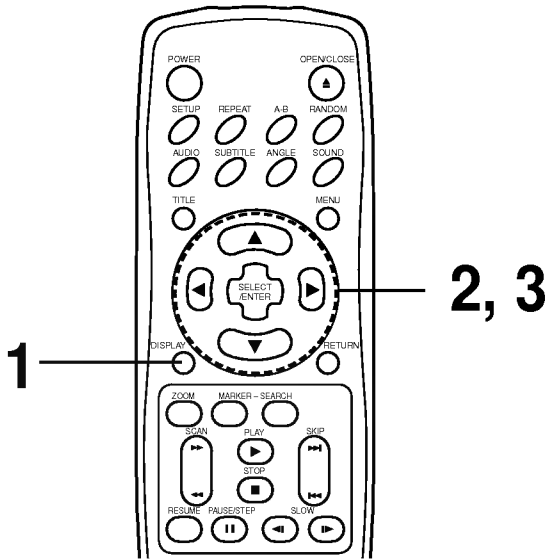

**Common procedures**

**Press DISPLAY during playback.**

- Title function can be accessed from the stop mode.

**Press ▲/▼ to select the desired item.**

- The currently selected item is indicated by a yellow frame on its GUI menu icon.

**Press ◀▶ to select the desired setting.**

- When numbers are displayed (e.g. title No.), the numeric buttons can also be used for setting instead of ◀▶.
- For some functions, the setting will be registered immediately; for others, SELECT/ENTER must be pressed.

**Press DISPLAY to clear the GUI Menu Icons.**

**Examples of GUI Menu Icons.**

(The screens may differ depending on the disc contents.)



(DVD GUI)



(CD GUI)

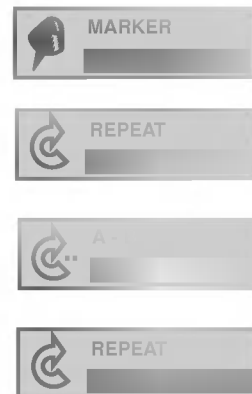

(DVD and CD GUI)



You can view information about a disc and its operational status on the TV screen.

Press DISPLAY during playback.  
[TV screen] DVD GUI



FUNCTION (Press ▲/▼ to select desired item)	SELECTION METHOD
To show the current title No. and to jump to the desired title No.	◀▶, or Numeric SELECT/ENTER
To show the current chapter No. and to jump to the desired chapter No.	◀▶, or Numeric SELECT/ENTER SKIP
To show the elapsed time and directly select scenes by the elapsed time.	Numeric SELECT/ENTER
To show the current audio soundtrack language, encoding method, channel No. and to change the settings.	◀▶, AUDIO
To show the current subtitles language and to change the setting.	◀▶, SUBTITLE
To show the current angle No. and to change the angle.	◀▶, ANGLE
To show the current sound (NORMAL or 3D SURROUND) and to change the setting.	◀▶, SOUND

Press DISPLAY during playback.  
[TV screen] CD GUI



FUNCTION (Press ▲/▼ to select desired item)	SELECTION METHOD
To show the current track No. and to jump to the desired track No.	SKIP, ◀▶,
To show the elapsed time. (Display only)	—
To show the current audio (STEREO, LEFT, RIGHT) and to select the desired audio channel.	◀▶, AUDIO
To show the current sound (NORMAL or 3D SURROUND) and to change the setting.	◀▶, SOUND

● Some DVD discs may not provide all of the above GUI menu icons.



### Using a title Menu

Some movie discs may contain two or more titles. If the disc has a title menu recorded on it, the TITLE button can be used to select the movie title. (The details of operation differ depending on the disc used.)

- Selecting a title may not be possible on certain DVD discs.

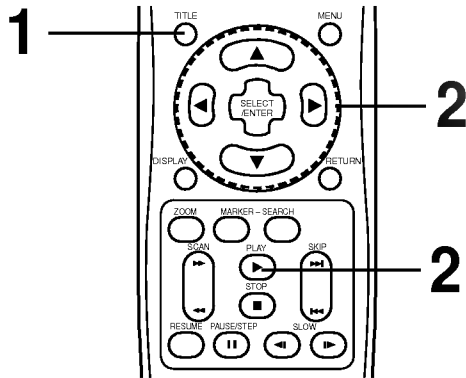

#### Press TITLE.

A list of the titles on the disc are displayed.

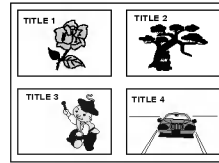

Press TITLE again to resume play from the scene when TITLE was first pressed.

#### Press ▲/▼/◀/▶ and press SELECT/ENTER or PLAY, or press the numeric button(s), to select desired title.

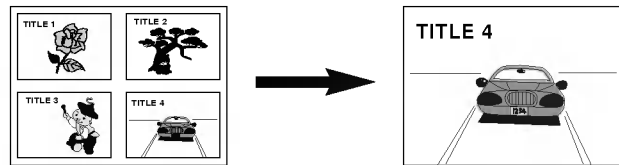

The selected title now starts playing.

### Using a DVD Menu

Some DVDs have unique menu structures called DVD menus. For example, DVDs programmed with complex contents provide guide menus, those recorded with various languages provide menus for audio and subtitle language. Although the DVD menu's contents and operation differ from disc to disc, the following explains the basic operation when this feature is used.

#### Press MENU during play.

The DVD menu available on the disc is now displayed.

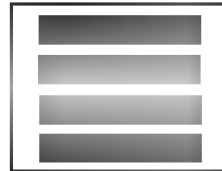

Pressing MENU again resumes play from the scene when MENU was first pressed.

#### Press ▲/▼/◀/▶ and press SELECT/ENTER, or press the numeric button(s), to select desired item.

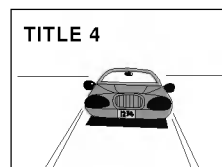

The selected item is now executed.

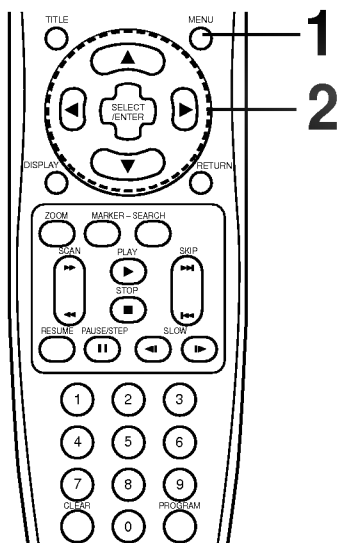



It is possible to change the subtitle language to a different language from the one selected at the initial settings. (See page 31 for further info.)

This operation works only with discs on which multiple subtitle languages are recorded.

**Press SUBTITLE during playback.**

When no subtitles are recorded, "OFF" will be displayed instead of the language number.

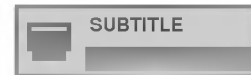

**Press SUBTITLE repeatedly until the desired language is selected.**

Number of the subtitle language being played back.

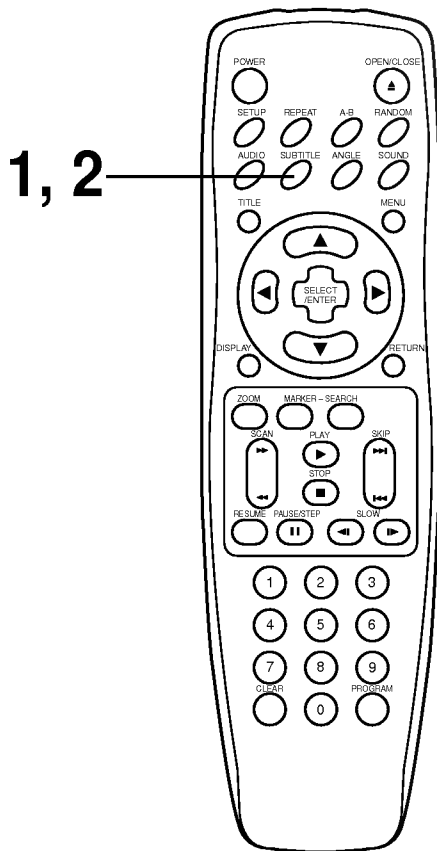
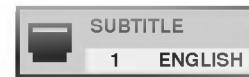

**To eliminate the On Screen Subtitles.**

Press SUBTITLE repeatedly to select OFF at step 2.

- In some cases, the subtitle language is not changed to the selected one immediately.
- When a disc supporting the closed caption is played, the subtitle and the closed caption may overlap each other on the TV screen. In this case, turn the subtitle off.
- When the desired language is not selected even after pressing the button several times, it means that the language is not available on the disc.
- When the power is turned on or the disc is removed, subtitles appear in the language selected at the initial settings. If this language is not recorded on the disc, the disc's priority language appears.



It is possible to change the audio soundtrack language to a different language from the one selected at the initial settings. (See page 31 for further info.)

This operation works only with discs on which multiple audio soundtrack languages are recorded.

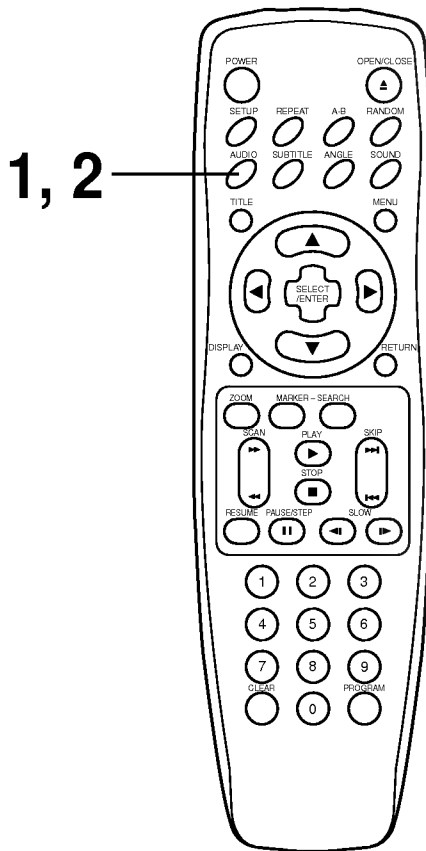

• **DVD**

 **Press AUDIO during play.**

Number of the audio soundtrack language being played back.



 **Press AUDIO repeatedly until the desired language is selected.**

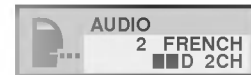

• **CD**

 **Press AUDIO during play.**



 **Press AUDIO repeatedly until the desired sound is selected.**



- When the desired language is not selected even after pressing the button several times, it means that the language is not available on the disc.
- When the power is turned on or the disc is removed, the language heard is the one selected at the initial settings. If this language is not recorded on the disc, only the available language on the disc will be heard.





Some DVDs may contain scenes which have been shot simultaneously from a number of different angles. For these discs, the same scene can be viewed from each of these different angles using the ANGLE button. (The recorded angles differ depending on the disc used.)

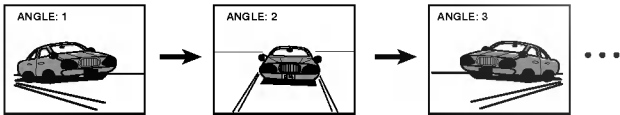

Press ANGLE during playback.

Number of angle being played back.



Press ANGLE repeatedly until the desired angle is selected.

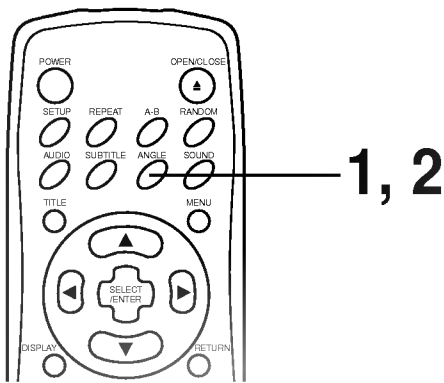

- This function only works for discs having scenes recorded at different angles.
- The ANGLE indicator on the unit lights up at scenes recorded at different angles to indicate that angle switching is possible. The angle number can be programmed beforehand; the angle will be switched to the selected number when the ANGLE indicator lights up.



This unit can produce a 3D Surround effect, using Spatializer™ N-2-2™ technology, which simulates multi-channel audio playback from two conventional stereo speakers instead of the five or more speakers normally required to listen to multi-channel audio from a home theatre. This feature works with DVD discs encoded with Dolby Pro Logic, Dolby Digital (AC-3) and DTS multi-channel audio tracks.

Press SOUND during playback.

Each time this button is pressed, the TV screen display changes:

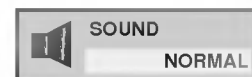

Press SOUND repeatedly until the desired sound is selected.

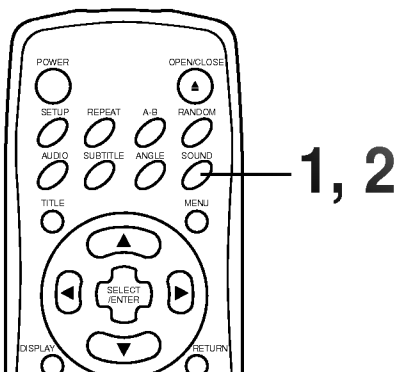
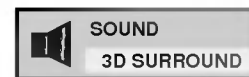

- This 3D Surround effect may not be available on some DVD discs, such as those recorded with a mono audio soundtrack.
- Turn off the TV surround sound and other surround effects when using this 3D surround effect.
- For best 3D Surround effect using only two speakers it is recommended that the two speakers be positioned approximately 6' to 8' apart, and the listening position should be 6' to 8' away from the speakers.



### Repeating viewing (listening)

#### Press REPEAT during playback.

Each time this button is pressed, the TV screen changes as shown below and the disc will repeat a chapter or title (DVD) or a track (CD).

#### • DVD

Repeat chapter being played

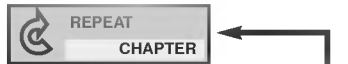

Repeat title being played



Cancel repeat mode (normal play)



#### • CD

Repeat track being played



Repeat entire disc contents



Cancel repeat mode (normal play)



#### To return to normal play

Press REPEAT several times until "OFF" is displayed.

### Repeating sections between two specific points (A-B repeat)

Press A-B during play at the point where repeat play is to start (A).



Press A-B during play at the point where repeat play is to be concluded (B).



Repeat play of the selection between points A and B starts.

#### To return to normal play

Press A-B once "OFF" is displayed.



- Repeat play works only with discs for which the elapsed playing time appears in the DVD display window during playback.
- Repeat play may not work correctly with some DVDs.
- A-B repeat play works only within a title DVD or a track CD.
- A-B repeat play works only with discs for which the elapsed playing time appears in the DVD display window during playback.
- Some subtitles recorded around point A or B may fail to appear (DVD).



Storing a MARKER in the DVD memory is similar to marking your page in a book. It allows you to quickly return to any point on the disc.

### Storing a marker in the memory

Press **MARKER** during play at the starting point to be viewed (listened to) again.



Indicates "1/5" is stored in the memory. Up to 5 markers can be stored in the memory.

### Recalling/Clearing a marker

Press **SEARCH** during playback.

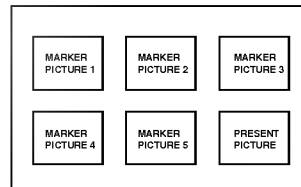

Press **▲/▼/◀/▶** to select the marker to be recalled/cleared.

Press **PLAY** or **SELECT/ENTER** to recall a marker. or Press **CLEAR** to clear a marker.

Play resumes from the point corresponding to the selected marker, or the selected marker is cleared.

- The "PRESENT PICTURE" is not cleared.

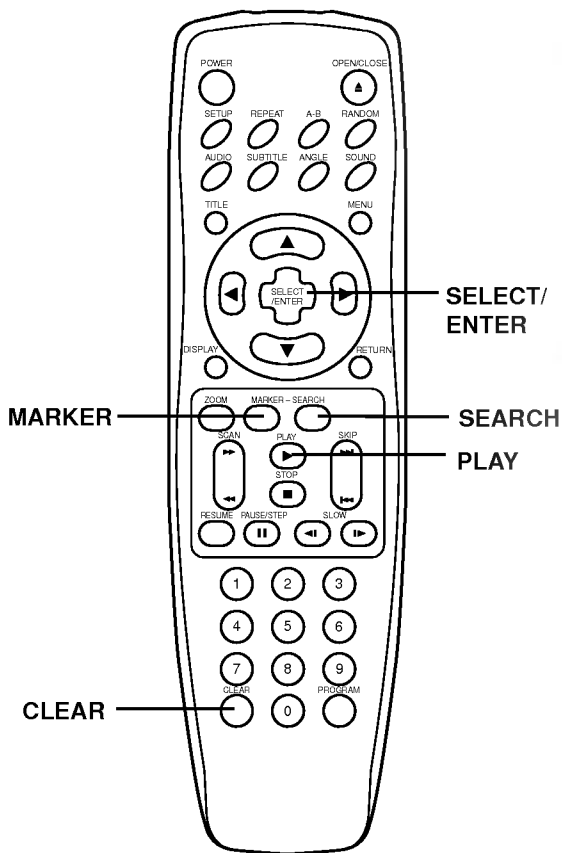

- These operations work only with discs for which the elapsed playing time appears in the DVD display window during playback.
- Some subtitles recorded around the marker may fail to appear (DVD).
- All the markers are cleared when the power is turned off or the disc is removed.



The Zoom feature allows you to “ZOOM-IN” and enlarge the picture on the screen to either 4 times (X4) or 16 times (X16) its normal size.

**Press ZOOM during normal playback or still playback.**

The DVD player magnifies the image in the center of the picture. Each press of the ZOOM button changes the TV screen in the following sequence.

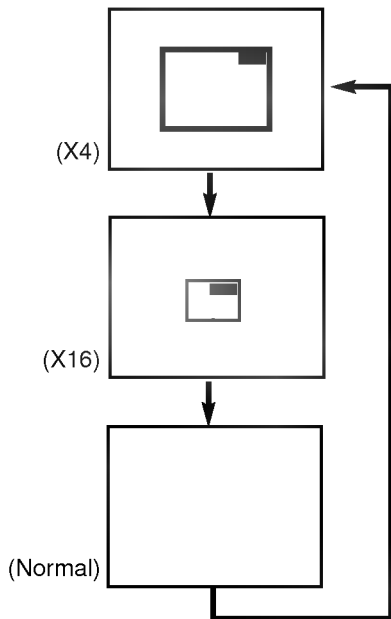

The magnification level will be displayed in the upper right corner of the zoom area.

If you press the ARROW buttons (▲/▼, ◀/▶), the zoom point shifts.

**Press SELECT/ENTER.**  
The selected frame is displayed in full size on the TV screen.

**To resume normal playback**  
Press ZOOM again to cancel Zoom feature and resume normal playback or still playback.

- Some discs may not respond to Zoom feature.
- During some scenes, the buttons may not work in the right column.
- Zoom does not work on subtitles or menus included on DVD video discs.

**Note:** Random play function only works with DVD video karaoke discs and with audio CD discs. Random does not work with DVD movies.

You can playback titles, chapters within a title, or tracks in random order (Random playback). The DVD player automatically selects the titles in a DVD video karaoke disc only and plays them back randomly.

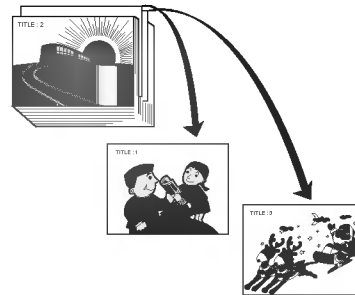

**Random play (DVD)**

**Press RANDOM during stop.**  
The DVD player starts random playback.

If you press the RANDOM button during normal playback, the DVD player will randomly select another title and begin random playback immediately.

**To resume normal playback**  
**Press RANDOM during random playback.**  
The RANDOM indicator in the DVD display window disappears.

**Random play (CD)**  
The player plays the tracks in the disc in random order.

**Press RANDOM during stop.**  
The random playback screen appears on the TV screen.

If you press the RANDOM button during normal playback, the DVD player immediately selects another track and begins random playback.

**To resume normal playback**  
**Press RANDOM during random playback.**  
The RANDOM indicator in the DVD display window disappears.

- Random playback may not be possible on certain discs.
- If you press the SKIP ►► button during random playback, the DVD player goes to another track randomly and starts playback.



**Note:** Program play function is possible only with audio CDs. It does not work with DVD movie discs.

The player plays the tracks in the disc in the order you specify.

Press **PROGRAM** during playback or stop mode.

The program playback screen appears on the TV screen.

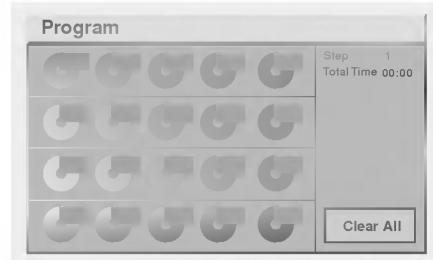

To exit the screen, press **PLAY**, **PROGRAM** or **SELECT/ENTER**.

Press **▲/▼/◀▶** and press the numeric button(s), to select the desired track number.

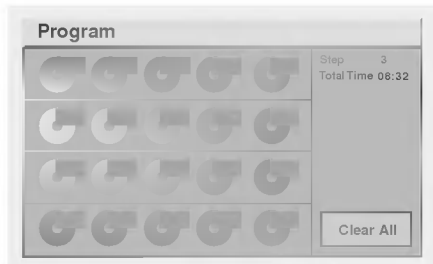

Repeat step 2 to select another track.  
Up to 20 tracks can be programmed.

Press **PLAY** or **SELECT/ENTER** to exit the screen.

The selected track is stored in the memory and play now begins in the programmed sequence.

● If you press **PROGRAM** to exit the screen, the selected tracks are not memorized.

**After playback**

Play is stopped.

**Clearing the program**

● **To clear the program one by one**

Press **▲/▼/◀▶** to select the unwanted No. and then press **CLEAR**.

● **To clear all the programs**

Press **▲/▼/◀▶** to select the "Clear All" and press **SELECT/ENTER**. Press **PLAY** or **SELECT/ENTER** to exit the screen. If you press **PROGRAM** to exit the screen, the programs are not cleared. (The programs are also cleared when the power is turned off or the disc is removed.)

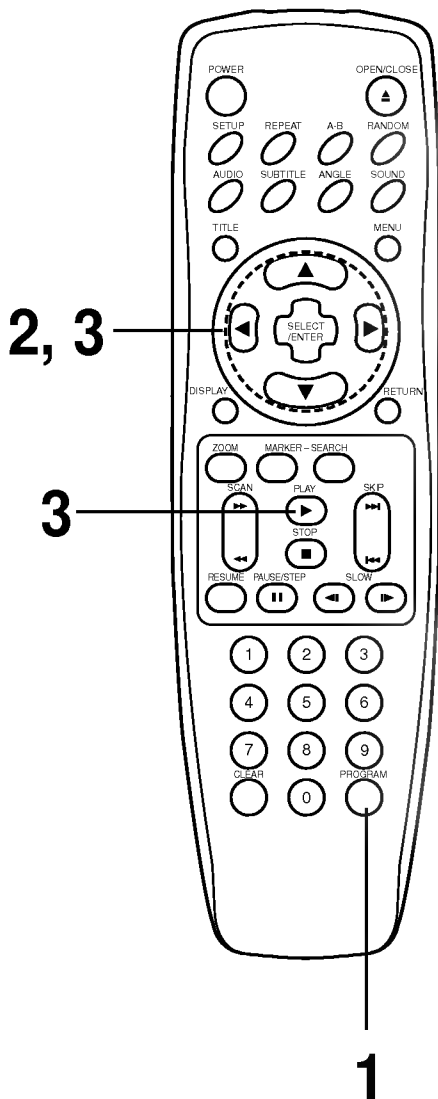



Once the initial settings have been completed, the player can always be operated under the same conditions (especially with DVD discs). The settings will be retained in the memory until they are changed, even if the power is switched off.

### Common procedures of initial settings

- Press **SETUP** in the stop mode. The SETUP menu is displayed.



- Press **▲/▼** to select the desired item. The screen will show the current setting for the selected item, and the alternate setting(s).

- Disc Audio
- Disc Subtitle (see page 31)
- Disc Menu
- Rating (see page 32)
- Password (see page 33)
- TV Aspect (see page 34)
- Menu Language (see page 35)
- Digital Audio Output (see page 36)

- Press **▶** and then **▲/▼** to select the desired setting and press **SELECT/ENTER**.
  - Some items require additional steps. (See the respective page.)

When the alternate setting is selected the screen returns to the Initial Settings display.

#### To exit SETUP menu

Press **SETUP**, **RETURN** or **RESUME**. (The previous screen is displayed.)

#### To clear the initial settings screen

Press **▲/▼/◀/▶** to select **RESUME** and press **SELECT/ENTER**. (Pressing **SETUP**, **RETURN** or **RESUME** also clears the initial settings screen.)

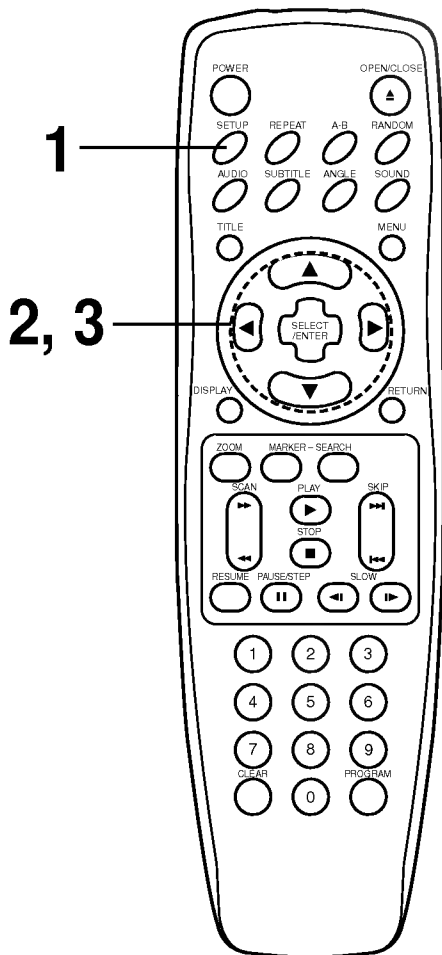



This is to select the audio soundtrack language, subtitle language and the language used in title menus or DVD menus which will always be used for every disc to be played back.

When you play back a DVD video disc, the DVD player automatically displays the pre-selected subtitle language if it is included on the disc.

**At the setup screen**

Press ▲/▼ to select “Disc Audio” and press ▶.



Press ▲/▼ to select the desired language and then press SELECT/ENTER.

- Original** :The original language of each disc will be selected.
- English** : The English will be Selected.
- Other** : Another language can be selected. You can input 4-digit language code. (Refer to the language codes on page 37. Press CLEAR if an incorrect language code is entered.)

The Disc Subtitle and Disc Menus are selected by the same method.

The screen illustrated in step 1 is displayed. Press ▲/▼/◀▶ to select RESUME and press SELECT/ENTER to return to the initial settings screen.

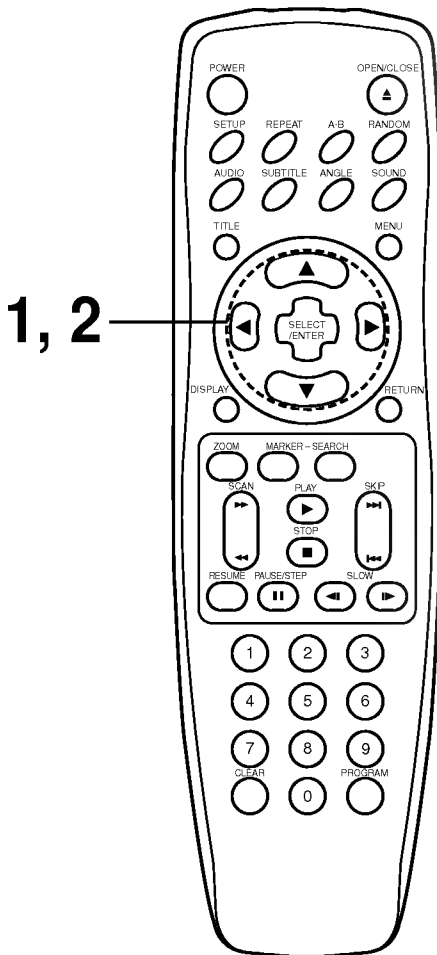

- If the language selected is not available on the disc, the original language designated by each disc will be selected.



**Selecting rating level and password (DVD only)**

This is to prohibit the playing of specified DVDs which are unsuitable for children.

- Some DVD discs contain a restriction level which enables parents to remove scenes or prevent playback of discs by children. DVD players are equipped with a password designed to prevent children changing the level.

**Selecting rating level (DVD only)**

**At the SETUP screen**

Press ▲/▼ to select Rating and press ►.

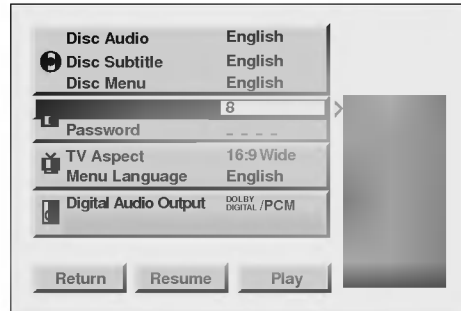

Press ▲/▼ to select the desired level and press SELECT/ENTER.

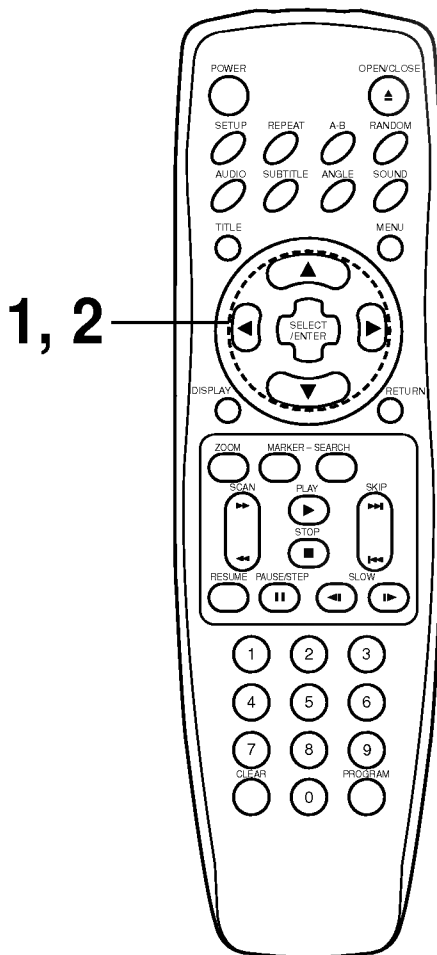
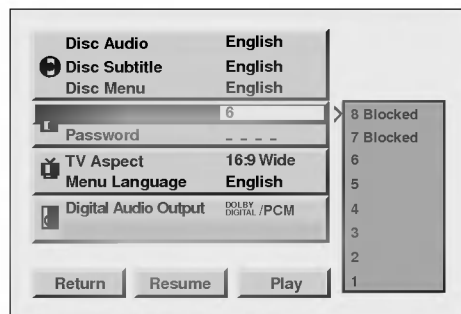

You cannot play DVD video discs rated higher than the level you selected unless you cancel the parental lock function. For example, when you select level 7, discs rated higher than level 7 are blocked and cannot be played.

If you change the level and enter a password, playback of all DVDs with ratings higher than your selection will be blocked, unless the correct password is entered again. For example: if you change the level to "5", the DVD player will not play discs with ratings of "6", "7" or "8" unless the correct password is entered on the remote control.



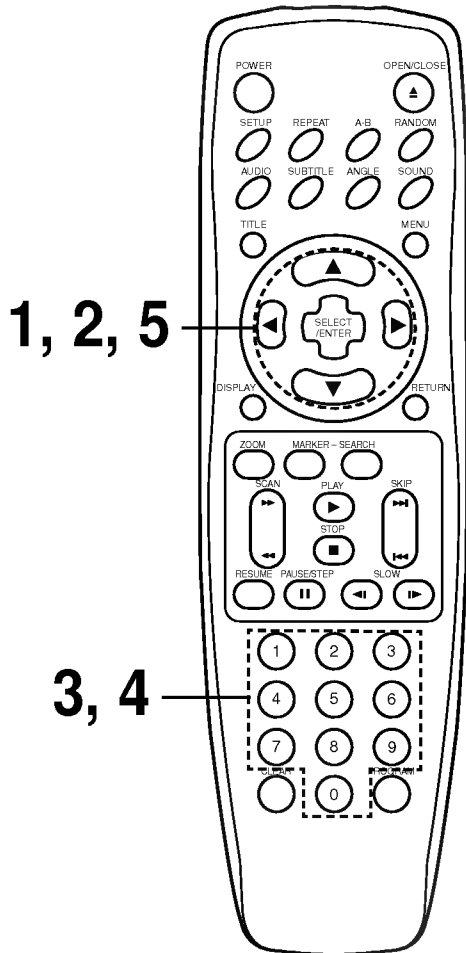

**Setting your password (DVD only)**

If you change the rating level to "7" or lower, you must enter a 4-digit "password" to prevent playback of discs with higher ratings.

**At the SETUP screen**

**Press ▼ to select password.**

Press ► and then ▲/▼ to select the "Change" item.



**Press SELECT/ENTER.**



**Input a 4-digit password.**

Example : 1234

Do not forget your password.

**Input the 4-digit password again to verify.**

**Press SELECT/ENTER.**

Setting is finished and the SETUP screen is displayed.

- When the selected password is already set, "Set" appears. When it is not set, "- - - -" appears
- The rating is locked. Any discs whose rating is higher than the setting cannot be played back unless the correct password is entered.

**To change the settings**

To change the rating level/password, enter your 4-digit password and follow the steps on page 32-33 again.

**To clear your 4-digit password**

If you forget your password, to clear the current password, follow the procedure below.

**At the SETUP screen**

**1 Press ▼ to select "Password" item.**

**2 Enter 6-digit number "210499" and then press SELECT/ENTER.**

The 4-digit password is cleared.

**3 Enter a new password**

Refer to "Setting your password" section on the right.



**Selecting TV Aspect**

Select the appropriate screen type according to your TV set; conventional size screen (4:3) or wide-screen (16:9).

At the SETUP screen.

Press ▲/▼ to select TV Aspect and press ►.

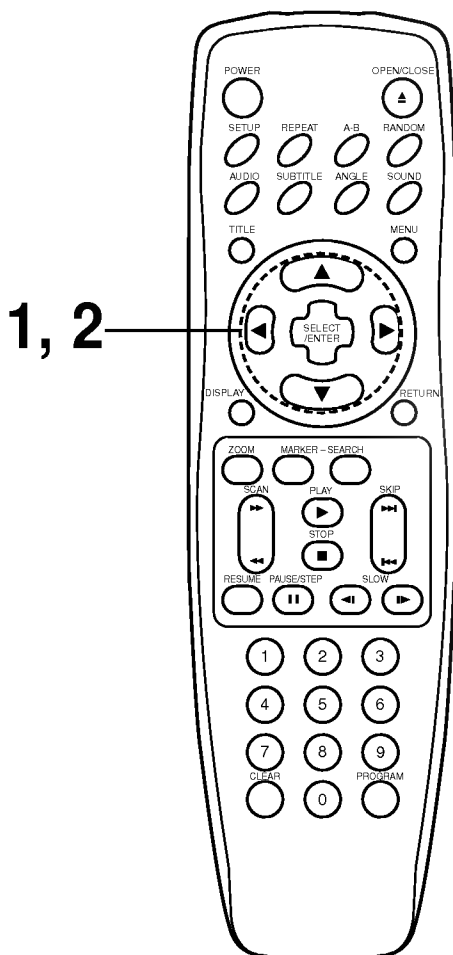

press ▲/▼ to select the desired Aspect and press SELECT/ENTER.

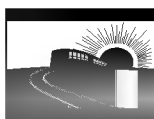
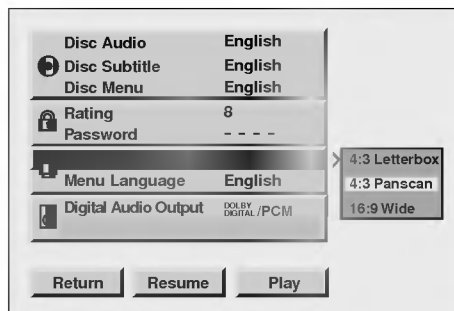

4:3 Letterbox

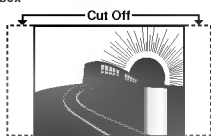

4:3 Panscan

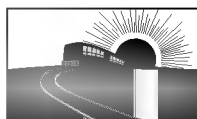

16:9 Wide

**4:3 Letterbox** : The video material not formatted in the Pan & Scan style is played back in the letterbox style (black bands appear at top and bottom of screen).

**4:3 Panscan** : Select when a conventional TV set is connected. The video material formatted in the Pan & Scan style is played back in that style (the left and right edges are cut off).

**16:9 Wide** : Select when a wide-screen TV set is connected. Played in "FULL" size. (Setting the wide-screen TV to "FULL" mode is also necessary.)

\* Each screen shows an example of when the video material for a wide-screen is played. (This setting does not affect the video material for conventional size.)

Setting is finished and the SETUP screen is displayed.



At the SETUP screen.

Press ▲/▼ to select Menu Language and press ►.

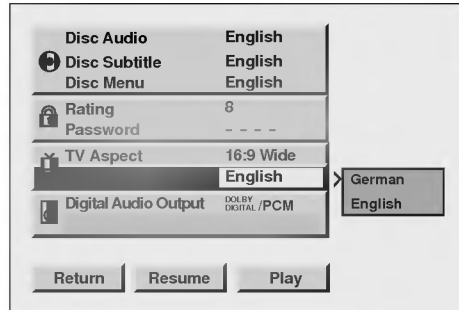

Press ▲/▼ to select the desired Menu Language and press SELECT/ENTER.

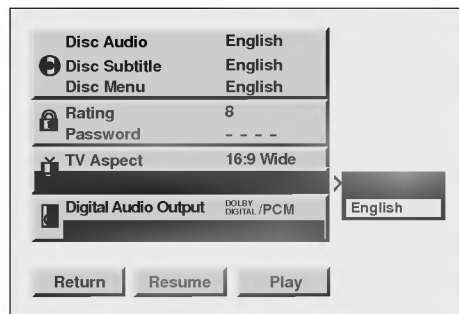

1, 2

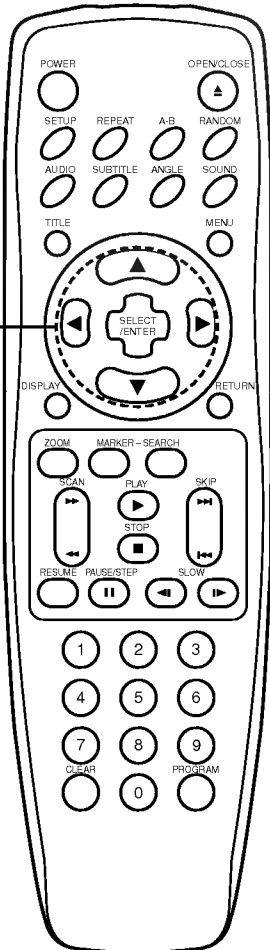



### Selecting Digital Audio Output

Each DVD disc has a variety of audio output options. Set the player's Digital Audio Output according to the type of audio system you use.

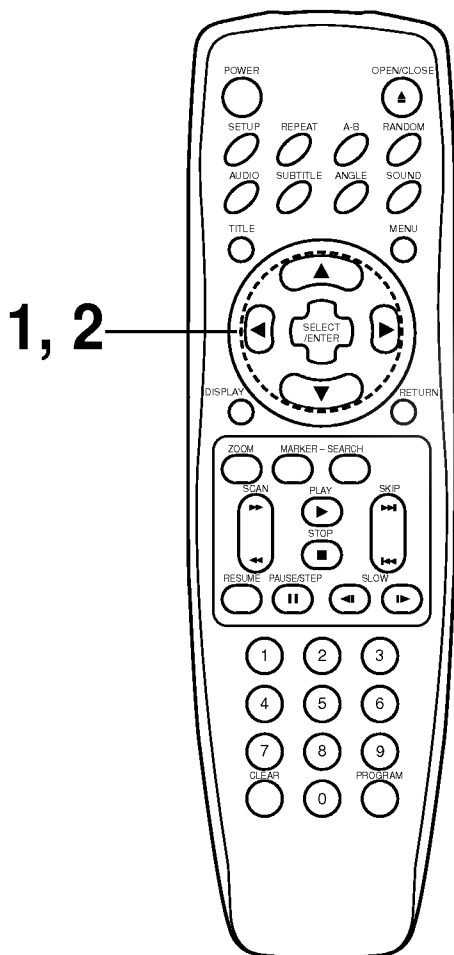

At the SETUP screen.

Press ▲/▼ to select Digital Audio Output and press ►.

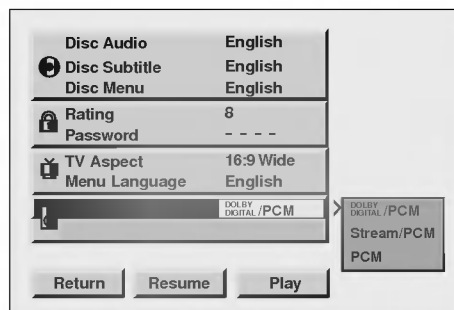

Press ▲/▼ to select the desired output and press SELECT/ENTER.

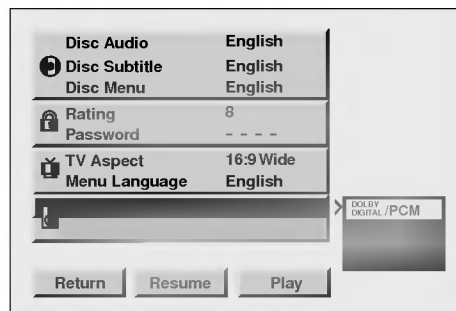

**DOLBY DIGITAL/PCM:** Select "DOLBY DIGITAL/PCM" if an active digital output is supplied to Dolby Digital decoder, (or an amplifier or other equipment with Dolby Digital decoder).

**Stream/PCM:** Select "Stream/PCM" if an active digital output is supplied to an amplifier or other equipment with DTS decoder, Dolby Digital decoder and MPEG decoder.

**PCM:** Select "PCM" if an active digital output is supplied to an amplifier or other equipment with linear PCM only (or MD recorder or DAT deck).

Playback Disc	OUTPUT		
	Stream/PCM	Dolby Digital/PCM	PCM only
96 kHz Linear PCM DVD	PCM	PCM	PCM
DTS DVD	DTS bit Stream	Not Output	Not Output
Dolby Digital DVD	Dolby Digital bit Stream	Dolby Digital bit Stream	PCM
MPEG DVD	MPEG bit Stream	PCM	PCM
Audio CD	PCM	PCM	PCM
DTS Audio CD	DTS bit Stream	DTS bit Stream	DTS bit Stream



- When you are not using the player's digital audio output, don't select any of the options.
- If an active digital audio output signal is supplied to a receiver or other equipment without a corresponding digital decoding capability, a very loud noise may be produced which could permanently damage the speakers.
- The DTS DVD disc sound is played back only when the DVD player is connected with amplifier with a DTS decoder.



Enter the appropriate code number for the initial settings "Audio", "Subtitle" and/or "Menu" (See page 31).

Code	Language	Code	Language	Code	Language	Code	Language
6565	Afar	7079	Faroese	7678	Lingala	8375	Slovak
6566	Abkhazian	7082	French	7679	Laothian	8376	Slovenian
6570	Afrikaans	7089	Frisian	7684	Lithuanian	8377	Samoa
6577	Ameharic	7165	Irish	7686	Latvian, Lettish	8378	Shona
6582	Arabic	7168	Scots Gaelic	7771	Malagasy	8379	Somali
6583	Assamese	7176	Galician	7773	Maori	8381	Albanian
6588	Aymara	7178	Guarani	7775	Macedonian	8382	Serbian
6590	Azerbaijani	7185	Gujarati	7776	Malayalam	8385	Sundanese
6665	Bashkir	7265	Hausa	7778	Mongolian	8386	Swedish
6669	Byelorussian	7273	Hindi	7779	Moldavian	8387	Swahili
6671	Bulgarian	7282	Croatian	7782	Marathi	8465	Tamil
6672	Bihari	7285	Hungarian	7783	Malay	8469	Telugu
6678	Bengali; Bangla	7289	Armenian	7784	Maltese	8471	Tajik
6679	Tibetan	7365	Interlingua	7789	Burmese	8472	Thai
6682	Breton	7378	Indonesian	7865	Nauru	8473	Tigrinya
6765	Catalan	7383	Icelandic	7869	Nepali	8475	Turkmen
6779	Corsican	7384	Italian	7876	Dutch	8476	Tagalog
6783	Czech	7387	Hebrew	7879	Norwegian	8479	Tonga
6789	Welsh	7465	Japanese	7982	Oriya	8482	Turkish
6865	Danish	7473	Yiddish	8065	Panjabi	8484	Tatar
6869	German	7487	Javanese	8076	Polish	8487	Twi
6890	Bhutani	7565	Georgian	8083	Pashto, Pushto	8575	Ukrainian
6976	Greek	7575	Kazakh	8084	Portuguese	8582	Urdu
6978	English	7576	Greenlandic	8185	Quechua	8590	Uzbek
6979	Esperanto	7577	Cambodian	8277	Rhaeto-Romance	8673	Vietnamese
6983	Spanish	7578	Kannada	8279	Rumanian	8679	Volapük
6984	Estonian	7579	Korean	8285	Russian	8779	Wolof
6985	Basque	7583	Kashmiri	8365	Sanskrit	8872	Xhosa
7065	Persian	7585	Kurdish	8368	Sindhi	8979	Yoruba
7073	Finnish	7589	Kirghiz	8372	Serbo-Croatian	9072	Chinese
7074	Fiji	7665	Latin	8373	Singhalese	9085	Zulu

This DVD player can play back the following discs.

	Disc mark	Contents	Disc size	Maximum playback time
DVD video discs		Audio+Video (moving pictures)	12 cm	Approx. 4 hours (single sided disc)
				Approx. 8 hours (double sided disc)
			8 cm	Approx. 80 minutes (single sided disc)
				Approx. 160 minutes (double sided disc)
Audio CDs		Audio	12 cm	74 minutes
			8 cm	20 minutes

You cannot playback discs other than those listed above. (Video CD, CD-ROM, CD-Extra, CD-G, photo CD, and CD-i discs can not be played on this DVD player.)

This DVD player uses the PAL color system.

“Certain audio features of this product manufactured under a license from Desper Products, Inc., Spatializer® 3-D Stereo, Spatializer N-2-2 (TM) and the circle-in-square device are trademarks owned by Desper Products, Inc.,”

Region Management Information: This DVD Player is designed and manufactured to respond to the Region Management Information that is recorded on a DVD disc. If the Region number described on the DVD disc does not correspond to the Region number of this DVD player, this DVD player cannot play that disc.

The Region number of this DVD player is 2.



You may not be able to play back some DVD video discs on this player if they were purchased from outside your geographic area or made for business purposes.

When you try to play back an unauthorized disc, “**Check Regional Code**” appears on the TV screen.

It is forbidden by law to copy, broadcast, show, broadcast on cable, play in public, and rent copyrighted material without permission.

DVD video discs are copy protected, and any recordings made from these discs will be distorted.

This product incorporates copyright protection technology that is protected by method claims of certain U.S. patents and other intellectual property rights owned by Macrovision Corporation and other rights owners. Use of this copyright protection technology must be authorized by Macrovision Corporation, and is intended for home and other limited viewing uses only, unless otherwise authorized by Macrovision Corporation. Reverse engineering or disassembly is prohibited.

## Symptoms and Correction

Check the following guide for the possible cause of a problem before contacting service.

Symptom	Cause	Correction
No power.	<ul style="list-style-type: none"> <li>The power cord is disconnected.</li> </ul>	<ul style="list-style-type: none"> <li>Plug the power cord into the wall outlet securely.</li> </ul>
The power is on, but the DVD player does not work.	<ul style="list-style-type: none"> <li>No disc is inserted.</li> </ul>	<ul style="list-style-type: none"> <li>Insert a disc. (Check that the DVD or, audio CD indicator in the DVD display is lit.)</li> </ul>
No picture.	<ul style="list-style-type: none"> <li>The TV is not set to receive DVD signal output.</li> </ul>	<ul style="list-style-type: none"> <li>Select the appropriate video input mode on the TV so the picture from the DVD player appears on the TV screen.</li> </ul>
	<ul style="list-style-type: none"> <li>The video cable is not connected securely.</li> </ul>	<ul style="list-style-type: none"> <li>Connect the video cable into the jacks securely.</li> </ul>
	<ul style="list-style-type: none"> <li>The connected TV power is turned off.</li> </ul>	<ul style="list-style-type: none"> <li>Turn on the TV.</li> </ul>
No sound.	<ul style="list-style-type: none"> <li>The equipment connected with the audio cable is not set to receive DVD signal output.</li> </ul>	<ul style="list-style-type: none"> <li>Select the correct input mode of the audio receiver so you can listen to the sound from the DVD player.</li> </ul>
	<ul style="list-style-type: none"> <li>The audio cables are not connected securely.</li> </ul>	<ul style="list-style-type: none"> <li>Connect the audio cable into the jacks securely.</li> </ul>
	<ul style="list-style-type: none"> <li>The power of the equipment connected with the audio cable is turned off.</li> </ul>	<ul style="list-style-type: none"> <li>Turn on the equipment connected with the audio cable.</li> </ul>
	<ul style="list-style-type: none"> <li>The Digital Audio Output is set to the wrong position.</li> </ul>	<ul style="list-style-type: none"> <li>Set the AUDIO SELECTOR to the correct position, then turn on the DVD player again by pressing the POWER button.</li> </ul>
The playback picture is poor.	The disc is dirty.	Clean the disc.
The DVD player does not start playback.	<ul style="list-style-type: none"> <li>No disc is inserted.</li> </ul>	<ul style="list-style-type: none"> <li>Insert a disc. (Check that the DVD, or audio CD indicator in the DVD display is lit.)</li> </ul>
	<ul style="list-style-type: none"> <li>An unplayable disc is inserted.</li> </ul>	<ul style="list-style-type: none"> <li>Insert a playable disc. (Check the disc type, color system and Regional code.)</li> </ul>
	<ul style="list-style-type: none"> <li>The disc is placed upside down.</li> </ul>	<ul style="list-style-type: none"> <li>Place the disc with the playback side down.</li> </ul>
	<ul style="list-style-type: none"> <li>The disc is not placed within the guide.</li> </ul>	<ul style="list-style-type: none"> <li>Place the disc on the disc tray correctly inside the guide.</li> </ul>
	<ul style="list-style-type: none"> <li>The disc is dirty.</li> </ul>	<ul style="list-style-type: none"> <li>Clean the disc.</li> </ul>
	<ul style="list-style-type: none"> <li>A menu is on the TV screen.</li> </ul>	<ul style="list-style-type: none"> <li>Press the SETUP button to turn off the menu screen.</li> </ul>
The remote control does not work properly.	<ul style="list-style-type: none"> <li>The remote control is not pointed at the remote sensor of the DVD player.</li> </ul>	<ul style="list-style-type: none"> <li>Point the remote control at the remote sensor of the DVD player.</li> </ul>
	<ul style="list-style-type: none"> <li>The remote control is too far from the DVD player.</li> </ul>	<ul style="list-style-type: none"> <li>Operate the remote control within about 23 ft (7 m).</li> </ul>
	<ul style="list-style-type: none"> <li>There is an obstacle in the path of the remote control and the DVD player.</li> </ul>	<ul style="list-style-type: none"> <li>Remove the obstacle.</li> </ul>
	<ul style="list-style-type: none"> <li>The batteries in the remote control are exhausted.</li> </ul>	<ul style="list-style-type: none"> <li>Replace the batteries with new ones.</li> </ul>

**DVD player/Outputs/Supplied Accessories**

[DVD player]	Power supply	AC 200-240V, 50 Hz
	Power consumption	20 W
	Mass	7.7 lbs (3.5 kg)
	External dimensions (W X H X D)	17" X 3.2" X 11.8" (430 x 80 x 298 mm)
	Signal system	PAL 625/50
	Laser	Semiconductor laser, wavelength 650 nm
	Frequency range (digital audio)	2 Hz to 44 kHz
	Signal-to-noise ratio (digital audio)	More than 105 dB (EIAJ)
	Audio dynamic range (digital audio)	More than 95 dB (EIAJ)
	Harmonic distortion (digital audio)	0.003 %
	Wow and flutter	Below measurable level (less than + 0.001 % (W.PEAK)) (EIAJ)
	Operating conditions	Temperature: 41 °F to 95 °F, Operation status: Horizontal
	[Outputs]	Video output
S-video output		(Y) 1.0 V (p-p), 75 Ω, negative sync., Mini DIN 4-pin x 1 (C) 0.286 V (p-p), 75 Ω,
Audio output (digital audio)		0.5 V (p-p), 75 Ω, RCA jack x 1
Audio output (analog audio)		2.0 Vrms(1 KHz, 0 dB), 330 Ω, RCA jack (L, R) x 1/SCART
[Supplied Accessories]	<ul style="list-style-type: none"> <li>● S-video cable .....1</li> <li>● Coaxial audio cable.....1</li> <li>● Audio/video cable.....1</li> <li>● Remote control.....1</li> <li>● Batteries (AAA) .....2</li> </ul>	

\* Designs and specifications are subject to change without notice.



---

**LG Electronics Deutschland GmbH**

Jakob-Kaiser-Straße 12  
Postfach 244, 47877 Willich  
Telefon: 02154 / 492-0, Telefax: 02154 / 428799  
**[www.lge.de](http://www.lge.de)**

P/NO: 3834RM0007Q