



Washing Machine

OWNER'S MANUAL

**MODEL : WF-T5501PP / WF-T6105TP
WF-T5505PP / WF-T6505TP**

Please read this manual carefully before operating your set.
Retain it for future reference.
Record model number and serial number of the set.
See the label attached on the back cover and quote this
information to your dealer when you require service.

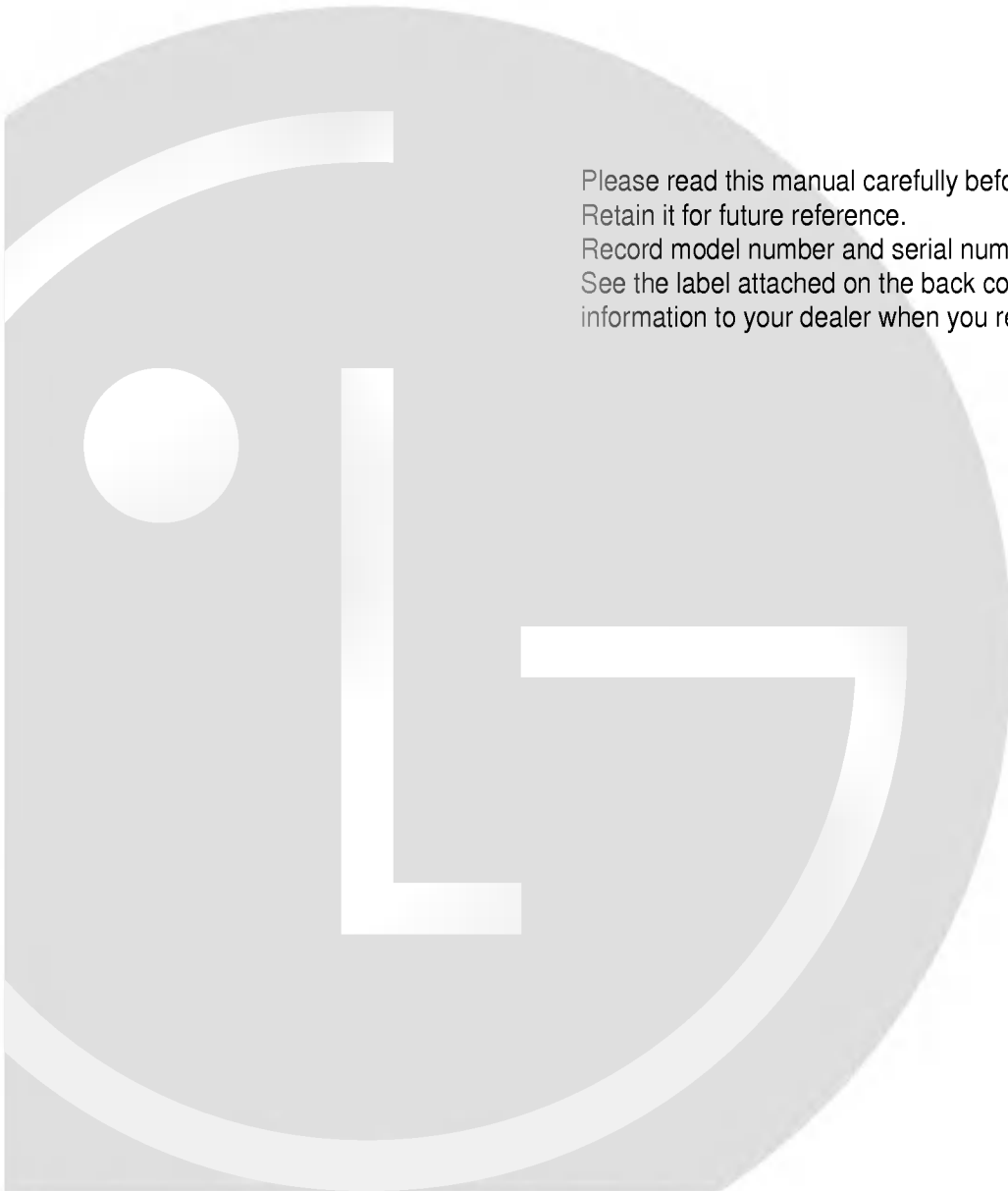



LAVADORA

MANUAL DEL USUARIO

MODELO : WF-T5501PP / WF-T6105TP
WF-T5505PP / WF-T6505TP

Por favor, lea atentamente este manual antes de utilizar el electrodoméstico. Guárdelo para posible consulta.
Anote el número de modelo y el número de serie del aparato.
Observe la etiqueta pegada sobre la cubierta posterior y proporcione esta información a su distribuidor cuando necesite servicio técnico.

Product Features



"Turbo Drum" washer doesn't operate while the lid is open. If the lid is open during the wash, rinse or spin cycles, the operation stops for safety.

Fuzzy logic control

- A built-in load sensor automatically detects the laundry load and a microprocessor optimizes washing conditions such as ideal water level and washing time.



- Advanced technology is built into the Electronic Control System which ensures the best washing result.

Turbo drum washing

- When "Punch + 3" washing wings turn, the washing tub turns in the opposite direction. This makes the both sides current of water which improve wash-performance by rubbing clothes strongly.



3 Step washing

- 3 step washing makes the best washing performance with low tangling.



Rubbing



Rubbing and Shaking



Shaking and Disentangling

Devices for removing nap

- Lint filter catch nap and thread generated during washing to make the laundry cleaner.



READ THIS MANUAL

Inside you will find many helpful hints on how to use and maintain your washer properly. Just a little preventive care on your part can save you a great deal of time and money over the life of your washer. You will find many answers to common problems in the Troubleshooting section. If you review our chart of Troubleshooting Tips first, you may not need to call for service at all.

| | | |
|------------------------------------|--|----|
| Introduction | Safety Information | 4 |
| | Identification of Parts | 5 |
| | Function Information | 6 |
| Before Starting to Wash | Preparation Before Washing | 7 |
| | Use of Water, Detergent, Bleach and Softener | 8 |
| | How to Remove Stains | 11 |
| | Function of each Button | 12 |
| Washing Programs | Fuzzy Wash (Normal Wash) | 14 |
| | Economy Wash | 14 |
| | Jean Wash | 14 |
| | Wool Wash | 14 |
| | Soak Wash | 14 |
| Additional Function Options | Delay Start (Reservation) Wash | 16 |
| | Option Washing | 17 |
| | Other useful Functions | 18 |
| Installation | Placing and Leveling | 19 |
| | Connecting Water Supply Hose | 20 |
| | Connecting Drain Hose | 23 |
| Care and Maintenance | Grounding Method | 24 |
| | Cleaning and Maintenance | 25 |
| Terms of Warranty | Terms of Warranty | 30 |

**WARNING!**

Read and follow this safety information carefully.

For your safety, the information in this manual must be followed to minimize the risk of fire or explosion, electric shock, or to prevent property damage, personal injury, or loss of life.

Save these instructions.

| | |
|------------------------------|---|
| WATER HEATER SAFETY | <ul style="list-style-type: none"> • Under certain conditions hydrogen gas may be produced in a water heater that has not been used for two weeks or more. Hydrogen gas can be explosive under these circumstances. If the hot water has not been used for two weeks or more, prevent the possibility of damage or injury by turning on all hot water faucets and allowing them to run for several minutes. Do this before using any electrical appliance which is connected to the hot water system. This simple procedure will allow any built-up hydrogen gas to escape. Since the gas is flammable, do not smoke or use an open flame or appliance during this process. |
| PROPER INSTALLATION | <ul style="list-style-type: none"> • Install or store where it will not be exposed to temperatures below freezing or exposed to the weather. • Properly ground washer to conform with all governing codes and ordinances. Follow details in Installation Instructions. • The base opening must not be obstructed by carpeting when the washing machine is installed on a carpeted floor. |
| YOUR LAUNDRY AREA | <ul style="list-style-type: none"> • Keep the area underneath and around your appliances free of combustible materials such as lint, paper, rags, chemicals, etc. • Close supervision is necessary if this appliance is used by or near children. Do not allow children to play on, with, or inside this or any other appliance. |
| WHEN USING THE WASHER | <ul style="list-style-type: none"> • Use this appliance only for its intended purpose as described in this Owner's Manual. • Never reach into washer while it is moving. Wait until the machine has completely stopped before opening the lid. • Do not mix chlorine bleach with ammonia or acids such as vinegar and/or rust remover. Mixing different chemicals can produce a toxic gas which may cause death. • Do not wash or dry articles that have been cleaned in, washed in, soaked in, or spotted with combustible or explosive substances (such as wax, oil, paint, gasoline, dry-cleaning solvents, kerosene, etc.) which may ignite or explode. Do not add these substances to the wash water. Do not use or place these substances around your washer or dryer during operation. • The laundry process can reduce the flame retardant of fabrics. To avoid such a result, carefully follow the garment manufacturer's wash and care instructions. • To minimize the possibility of electric shock, unplug this appliance from the power supply or disconnect the washer at the household distribution panel by removing the fuse or switching off the circuit breaker before attempting any maintenance or cleaning. • Do not place any electric appliance with a charging battery, magnetically-driven appliance and magnetic body on the washer. • Never attempt to operate this appliance if it is damaged, malfunctioning, partially disassembled, or has missing or broken parts, including a damaged cord or plug. |
| WHEN NOT IN USE | <ul style="list-style-type: none"> • Turn off water faucets to relieve pressure on hoses and valves and to minimize leakage if a break or rupture should occur. Check the condition of the fill hoses; they may need replacement after 5 years. • Before discarding a washer, or removing it from service, remove the washer lid to prevent children from hiding inside. • Do not attempt to repair or replace any part of this appliance unless specifically recommended in this Owner's Manual, or in published user-repair instructions that you understand and have the skills to carry out. • Do not tamper with controls. |

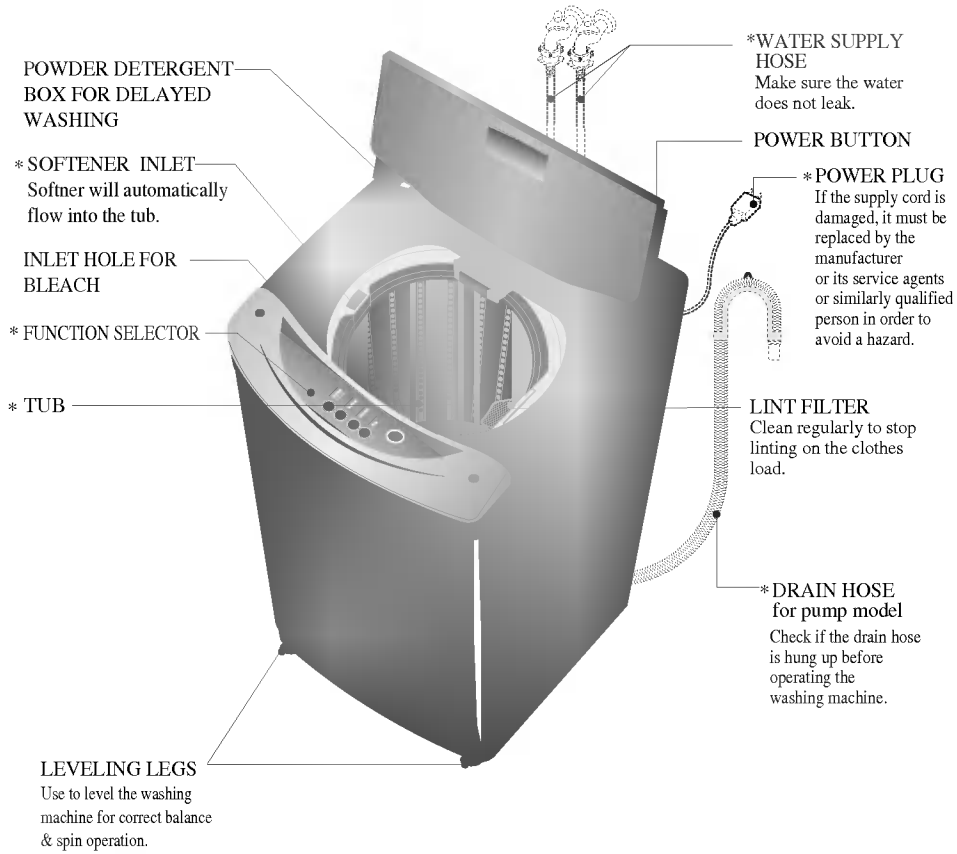

Accessories

Water supply hoses

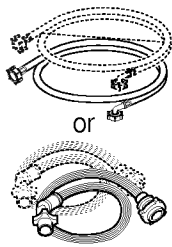

1 Each for cold and hot water

Drain hose

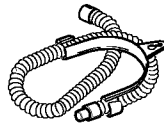

Anti-rat cover (option)



Note

“ ” Part can be different according to the model.

Function Information

Our machine provides various washing methods which suits various conditions and types of laundry.

Different types of laundry washing

Use this Program for everyday washing e.g. sheets, towels, T-shirts. (refer to p14)

Use this Program for heavily soiled durable garments e.g. overalls, jeans. Thick and heavy clothes or those which are excessively dirty like jeans or working uniforms can be washed. (refer to p14)

Delicate clothes (lingerie, wool, etc.) which may be easily damaged can be washed. (refer to p14)

The fibers of machine washable woolens have been specifically modified to prevent felting when they are machine washed. Most handknitted garments are not made of machine washable wool and we recommend that you hand wash them

- Before washing your woolens check the care label for the washing instructions.
- When washing woolens use a mild detergent recommended for washing wool.
- Hand washed woolens may be spun in a washing machine to reduce the time they take to dry.
- To dry woolens lay down them flat on a towel and pat into shape. Dry woolens out of direct sunlight. (The heat and tumble action of a dryer may cause shrinkage or felting of woolen garments.)

Some wool underlays and sheepskin products can be washed in a washing machine but may cause pump blockages. (Ensure that the whole article is suitable for machine washing and not just the backing material.) You may wish to handwash these articles and place them in the machine to spin dry.

Washing according to the condition of laundry

Economy wash can be selected to wash lightly soiled clothes of less than 2.0 kg in a short time. (refer to p14)

Soak Wash can be selected to wash heavily soiled laundry by soaking it in water for sometime to remove dirt and grime. (refer to p14)

Other washing method

Delay start Wash is used to delay the finishing time of the operation. The number of hours to be delayed can be set by the user accordingly. (refer to p16)

When the user needs only Spin, Rinse/Spin, Rinse, Wash/Rinse, Wash, Soak/Wash/Rinse/Spin, Soak/Wash/Rinse, Soak/Wash. (refer to p17)

Preparation Before Washing

* Look for a care label on your clothes. This will tell you about the fabric content of your garment and how it should be washed.



Sort clothes into loads that can be washed with the same wash cycle, water temperature and spin speed.

To get the best results, different fabrics need to be washed in different ways.

- **SOIL** (Heavy, Normal, Light) Separate clothes according to the type and amount of soil.
- **COLOR** (Whites, Lights, Darks) Separate white fabrics from colored fabrics.
- **LINT** (Lint producers, Collectors) Separate lint producers and lint collectors.



Lint Producers
Lint Collectors

Terry cloth, Chenille, Towels, Nappies, Diapers
Synthetics, Corduroy, Permanent Press, Socks

- **Check all pockets to make sure that they are empty.** Things such as nails, hairclips, matches, pens, coins, and keys can damage both your washer and your clothes.
- **Mend any torn garments or loose buttons.** Tears or holes may become larger during washing.
- Remove belts, underwires, etc. to prevent damage to the machine or your clothes.
- **Pretreat any dirt and stains.**
- Make sure the clothes are washable in water.
- Check the washing instructions.



Do not wash fabrics containing flammable materials (waxes, cleaning fluids, etc.).

Load Size

The water level should just cover the clothes. Adjust the load size accordingly. Loosely load clothes no higher than the top row of holes in the washer tub. To add items after washer has started, press Start button and submerge additional items. Close the lid and press Start button again to restart.

Light and Large-sized clothing

Clothes like downs and woollens are light weight, large and float easily. Use a nylon net and wash them in a small amount of water.

If the laundry floats during the wash cycle, it may become damaged. Use dissolved detergent to prevent the detergent from clumping.



Long laundry items

Use nylon nets for long, delicate items. For laundry with long strings or long length, a net will prevent tangling during washing.

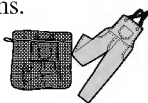

Fasten zippers, hook, and strings to make sure that these items don't snag on other clothes.

※ Nylon net is not supplied by LG.



Fire Hazard

Never place items in the washer that are dampened with gasoline or other flammable fluids. No washer can completely remove oil. Do not dry anything that has ever had any type of oil on it (including cooking oils). Doing so can result in death, explosion, or fire.

Use of Water, Detergent, Bleach and Softener

Using water

- This machine detects the quantity of laundry automatically, then sets the water level and proper amount of detergent.
- When you select a wash program, the water level and amount of detergent (to be used) will be shown on the control panel.
- The following table shows the amount of water.
- When the water level is automatically detected, it may differ depending on the quantity of laundry even though the same water level is indicated on the control panel.
- The amount of a cup in the diagram is about 40g for concentrated detergent.



- The machine sets the appropriate temperature automatically according to the wash program .
- You can change the water temperature by pressing the **WATER TEMP** button. (refer to p12)
- The temperature of the water impacts the effectiveness of all laundry additives and therefore, the cleaning results. We recommend temperatures of:
 - HOT 49~60°C...(120-140°F) White items, diapers, underclothing and heavily soiled, colorfast items.
 - WARM 29~40°C...(85-105°F) Most items
 - COLD* 18~24°C...(65-75°F) Only very bright colors with light soil.

- When washing in cold water additional steps may be needed:
 - Adjust detergent amount and pre-dissolve detergent in warm water
 - Pretreat spots and stains
 - Soak heavily soiled items
 - Use appropriate bleach

* Temperature below 18°C...(65°F) will not activate laundry additives and may cause lint, residue, poor cleaning, etc. In addition, detergent manufactures and care labels define cold water as 26~29°C...(80-85°F). If the temperature of the water in the tub is too cold for your hands, the detergent will not activate and clean effectively.

Using Detergent and Fabric Softener

Follow the detergent package directions. Using too little detergent is a common cause of laundry problems. Use more detergent if you have hard water, large loads, greasy or oily soils or lower water temperature.

We recommend the use of domestic detergent, (powder, liquid or concentrated). Soap flakes or granulated soap powders should not be used in your washing machine. When washing woolens remember to use detergent suitable for washing woolens.

Using Detergent and Fabric Softener

When you select a wash program the water level and the amount of detergent (to be used) will be shown on the control panel. The amount of a cup in the diagram is about 40g for concentrated detergent.

The correct amount of detergent will vary depending on the amount of soil in your clothes (Jeans and work clothes may need more detergent, while bath towels usually need less.).

For liquid and concentrated detergents, follow the recommendations of the detergent manufacturer.

Note: To check you are using the correct amount of detergent, lift the lid of your machine about half-way through the wash. There should be a thin layer of foam over the surface of the water. Lots of foam may look good, but it does not contribute to cleaning your clothes. No foam means not enough detergent has been used; soil and lint can settle back on the clothes or the washing machine.

If excess detergent is used, the rinse will not be as clean and efficient. Also, it could cause environmental pollution, so use it accordingly.

Open the detergent dispenser and deposit the appropriate amount of detergent

Where you deposit the detergent

Powder Detergent dispenser.

Some detergents **MUST** be fully dissolved before adding to your machine to get the best wash results.

Check the instructions on the detergent packet.

If you use powdered detergent it is essential that the required amount be fully dissolved in very hot water before being added to warm or hot water for the actual wash.

Pre-dissolving detergent in warm water when washing in cold water can improve its performance.

Powder Detergent Box

Where you deposit the detergent

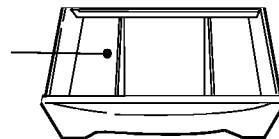

Use of Water, Detergent, Bleach and Softener

- Do not use concentrated fabric softener. This may cause some problems in automatic dispensing.
- For more details refer to the softener products instructions for use.



- Don't use softener with detergent. Use softener in last rinse water
- When using dispenser, dilute softener(30ml) with fresh water(30ml)
- When filling dispenser, do not splash or overfill. It may stain clothes.
- Never pour fabric softener directly on clothes. It may stain them
- If spotting occurs, wet and rub hand dishwashing liquid (or mild bar soap) and rewash.

Softener dispenser

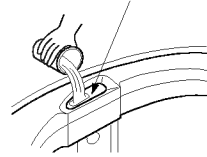

or

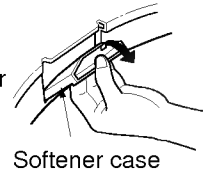

Softener case

Fabric Softener will be dispensed automatically during the final rinse.

Using Bleach

Check fabric care labels for special instructions.

- Use oxygenated bleach.
- Powdered bleach should be mixed with water and then be deposited into the tub.
- For more details refer to the products instruction for use.

- Separate the laundry to be bleached
- Measure liquid bleach carefully, following instructions on the bottle.
- Before starting the washer, pour measured amount of bleach directly into bleach dispenser.
- Avoid splashing or over-filling dispenser. If you prefer to use powdered bleach, add it into the wash basket with your detergent.
- The dispenser dilutes liquid bleach before it reaches into your wash load.

Bleach dispenser

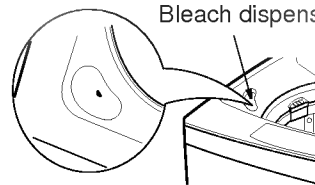

Attention

- Never pour undiluted liquid bleach directly onto clothes or into the wash basket. This may cause change of color or damage the laundry.
- Do not mix chlorine bleach with ammonia or acids such as vinegar and/or rust remover. Mixing can reduce a toxic gas which may cause death.
- Do not pour powdered bleach into bleach dispenser.

How To Remove Stains

Pretreating dirt and stains

Brush a little washing detergent dissolved in water onto stains, collars, and cuffs to help shift dirt. The secret of stain treatment is immediate action. When an accident happens, plunge the stained area into cold water, or sponge it down. This prevents the stain from setting. Wash as soon as possible afterwards.

- Treat stains **AS SOON AS POSSIBLE**. The longer they are left, the harder they are to remove.
- Always consider the type of fabric you are treating to make sure you do not use a water temperature that is too hot or a treatment that will alter the color of the fabric. It pays to pre-wash products and solvents on an inconspicuous part of the garment first.
- Place the garment being treated on an absorbent cloth (e.g. on an old towel). Work from the reverse side of the stain, as this can force the stain off the fabric instead of through it.
- Use cold or warm water on unknown stains as hot water can set some stains.
- Some stains are not easily seen when the fabric is wet. Do air dry the stained garment to be sure the stain has been removed, as heat from a dryer may set the stain.
- Take care with stain removal treatments as they are often flammable and highly poisonous. Do not use them in your washer as they may damage the paint or plastic components.
- Some pretreatment sprays or liquids can damage your washer's control panel.

- Diaper sanitizers are very corrosive to metal surfaces. **DO NOT** soak diapers in sanitizers in your washer or tip the contents of the diaper bucket into your machine. Rinse and wring diapers out thoroughly before placing them in your machine.

- Scrape off any excess baby cream, such as Vaseline from the diapers before washing and handwash to prevent the cream being transferred to other items in the wash.

- Use to select water temperature. Pressing the button allows you to select Cold ► Warm (Hot&Cold) ► Hot ► Cold respectively. Default setting is Cold.

- Use to adjust the water level as required. The appropriate amount of detergent is shown next to the water level in the WATER-DETERGENT diagram
- Water level is automatically selected for fuzzy (normal) and jean programs. The following settings are indicated as the button is pushed LARGE ► EX-LARGE ► SMALL ► MEDIUM ► LARGE

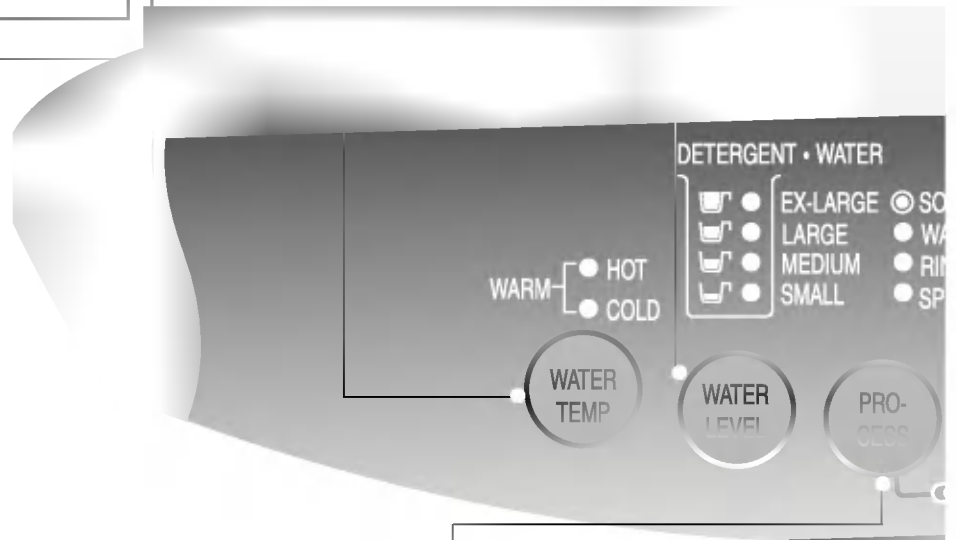

- Use to select SOAK, WASH, RINSE and SPIN functions as desired.

The control panel may differ according to different models

- Use for selecting wash program.
- This button allows you to select 4 different programs for different kinds of laundry and dirtiness.
- program selections light up in sequence as follows: FUZZY (NORMAL) ► ECONOMY ► JEAN ► WOOL ► FUZZY (NORMAL) etc. Select the desired program by pressing the button.



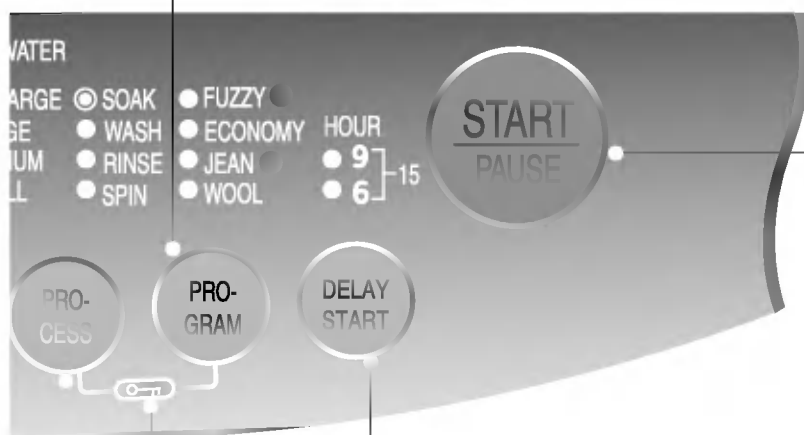























- Use to start or pause the washing process.
- Repeats start and pause by pushing the button.
- The power goes off automatically 10 minutes after stopping.
- ※ This appliance is fitted with a safety function that automatically stops the operation of the washing machine when it is exposed to heavy disturbance on the mains.



















Use to lock or unlock the control buttons to prevent setting from being changed by a child.
To lock, push the PROCESS, and PROGRAM buttons simultaneously and to unlock push them one more time during the washing process.
(refer to p18)

- Use to set a delayed finishing time.
The time changes 6 → 9 → 15(6+9) → 6hr when the button is pushed.
(refer to p16)

※ : 3 step works at large and medium water level of Fuzzy and Jean program.

| Washing Programs |  | Add the laundry |  |  | Add the detergent | |
|--|---|--|--|---|---|---|
| <p>Fuzzy Washing (Normal Wash) Used for normal loads, this mode automatically selects the most appropriate conditions and completes the sequence in one operation. The built-in sensor detects the size of the load and the ideal wash power and wash, rinse and spin times are set accordingly</p> |  |  | | |  <ul style="list-style-type: none"> • Add the appropriate quantity of detergent as indicated by the water level next to WATER-DETERGENT. Or follow the detergent manufacturer's instructions | <ul style="list-style-type: none"> • The p secor laund • Then the ar be us water |
| <p>Economy Wash Use this mode when washing lightly soiled clothes for a short time. The weight should be under 2.0kg.</p> |  |  |  <ul style="list-style-type: none"> • Select the ECONOMY program on the Control panel. | |  |  |
| <p>Jeon Wash Use Jeon program when washing Jeans of different sizes</p> |  |  <ul style="list-style-type: none"> • Spread the jeon evenly in the tub |  <ul style="list-style-type: none"> • Select the Jeon program on the Control panel. | |  |  |
| <p>Wool Wash Use this program for washing delicate fabrics such as lingerie and woolens. (wash only "water washable" clothes) Before washing your woolens check the care label for the washing instructions. (wash only water washable clothes)</p> |  |  |  <ul style="list-style-type: none"> • Select the WOOL program on the Control panel. | |  <ul style="list-style-type: none"> • Use neutral detergent appropriate for the laundry. • When washing woolens use a mild detergent recommended for washing wool. |  |
| <p>Soak Wash Use this mode for washing excessively dirty laundry by soaking in water for some time to remove proteins and fats. 'SOAK' mode can be used with all washing programs simultaneously except for 'WOOL' program.</p> |  |  |  <ul style="list-style-type: none"> • SOAK will not work in WOOL Program. |  |  | <ul style="list-style-type: none"> • The v amol used water  |

• Keep pressing the **PROCESS** button until the **SOAK** light is on and then **WASH**, **RINSE**, **SPIN** lights are on simultaneously.
 • If necessary, select the desired washing process from (**SOAK+WASH+RINSE+SPIN**), (**SOAK+WASH+RINSE**), (**SOAK+WASH**) manually.

|  | Close the lid | Finish | Caution & Note |
|--|--|--|---|
|  <ul style="list-style-type: none"> The pulsator rotates for 8 seconds to detect the laundry load. Then the water level and the amount of detergent to be used will be shown and water will be supplied. |  <ul style="list-style-type: none"> Water will be supplied for 2 minutes after the start of the wash to supplement the water the laundry has absorbed. |  <ul style="list-style-type: none"> When the wash program ends, the buzzer will ring for 10 seconds before the Power goes off automatically. | <ul style="list-style-type: none"> If water is already in the tub, or putting wet laundry into the tub before starting will increase the water level. With lightweight bulky loads, water level can be set low. Changes to water temperature (hot/cold) and wash level are possible during operation. (refer to p12) |
|  |  |  | |
|  |  |  | |
|  |  |  | <ul style="list-style-type: none"> When setting the water level manually, do not set to MEDIUM to prevent damage to laundry. Washing with hot water may damage the laundry (Water is set to cold automatically). Ensure that the load is under 2kg In order to avoid damage to laundry, the spin cycle may appear slow. This also avoids wrinkles and clothing may still contain some water. This is normal. |
|  <ul style="list-style-type: none"> The water level and the amount of detergent to be used will be shown and water will be supplied. |  |  | <ul style="list-style-type: none"> Soak Wash cannot be selected for the Wool Wash program. |

Delay Start (Reservation) Wash

Delay Start (Reservation) Wash is used to delay the finishing time of the operation. The hours to be delayed can be set by the user accordingly. The time on the display is the finishing time, not the start time.

Press the **POWER** button to turn power on.



Press the **PROGRAM** button to select the washing program.



- Select the program for laundry on the Control panel. This program will not work in Wool Program.

Press the **DELAY START (Reservation)** button to set the time when the delayed washing is to be completed.

- The time changes as following order (6→9→15→6Hours).

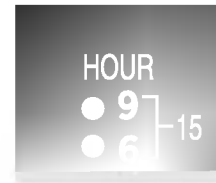

Add the detergent.

- The appropriate quantity of detergent marked next to the water level of WATER-DETERGENT.
- When the lid is open the machine will not operate, and an alarm signal will remind you to close the lid

Add the laundry and press the **START/PAUSE** button.



- When you press the START/PAUSE button the light will blink.

Close the lid.

- Water will be supplied for 2 minutes after the start of the wash to supplement the water the laundry has absorbed.

Finish

The washing will be finished according to the delayed time.

- If the lid is open, the machine will not work, and an alarm signal will alarm to remind you to close the lid.
- To select washing program, spinning time, water level or hot/cold manually, press the DELAY START (RESERVATION) button and select the desired option. Then press the START/PAUSE button.
- When the laundry cannot be taken out immediately after the wash program ends, it is better to omit the spinning program. (The laundry will be wrinkled if left for a long time after spinning.)

When you only need the Wash, Wash/Rinse or Rinse cycles, these can be set manually

Press the **AUTO OFF** (Power) button to turn power on.



Wash , Wash+Rinse , Rinse , Rinse+Spin , Spin only options



- Press the **PROCESS** button until above Option Washing light is on. (refer to p12)
- When you want to only drain, wait until the water in the washing tub drains completely and then, turn off the power.

Press the **WATER LEVEL** button, to control the water level according to the amount of laundry. If you do not choose anything, it is set the **LARGE** water level automatically. (refer to p12)



Add the laundry into the washing tub.

Press the **START/PAUSE** button.



Add the detergent and close the lid.

- When a **Wash, Wash/Rinse** or **Rinse** only option is selected, the water will not be drained off after the wash is completed. If you wish to drain the water, press the **SPIN** button and wait until the water in the tub has drained completely. Then press the **START/PAUSE** button .
- **If you do not specify the water level**, then Medium will be automatically selected.
- If only Rinse is selected, the process will start from Water Supply.

Child Lock Function

If you want to lock all the keys to prevent settings from being changed by a child, you can use the child lock option.

Press the **POWER** button.

- Turn Power on.



Press the **START/PAUSE** button to start washing.

- After all washing conditions are set according to the manual.



Press both the **PROCESS** button and the **PROGRAM** button simultaneously.

- During the wash program, all the buttons are locked until washing is completed or it is child-lock function is deactivated manually.



If you want to unlock during wash, press both the **PROCESS** and the **PROGRAM** button simultaneously again.

Mute Option

If you want to use the washing machine without alarm signal sounds, press both the **WATER LEVEL** and **PROCESS** buttons simultaneously.

To make buzzer work, press both the **WATER LEVEL** and **PROCESS** buttons simultaneously one more time.

Please ensure that transit restraint has been removed before operating your machine.

Place the machine on a flat and firm surface which allows proper clearance.

We suggest a minimum clearance of 2 cm to the right side and left sides of the machine for ease of installation.

At the rear, a minimum clearance of 10 cm is suggested.

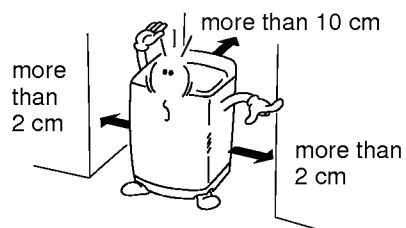

Check that the machine is level

Open the lid and look from above to see if it is same as shown.

Top view of the machine

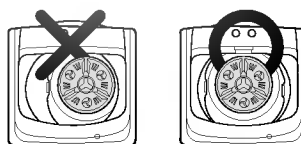

Leveling the machine

Lift the front of the washing machine and twist the Adjustable Leg until the washing machine is placed evenly.

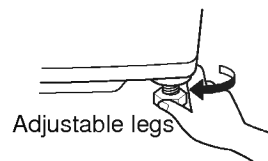

- ※ Installing the Anti-Rat Cover (option)
The anti-rat cover should be affixed firmly from the back of the washer and screw it (1 pcs)

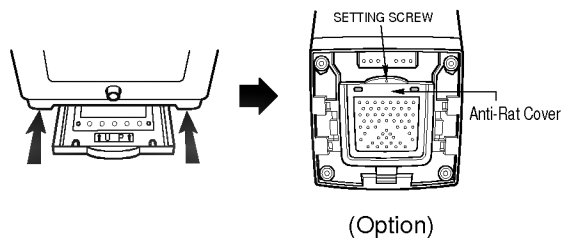

If the power is supplied from a cord extension set or generator, the cord extension set or electrical portable outlet device should be positioned so that it is not exposed to splashing or ingress of moisture.

Connecting Water Supply Hose

- Before connecting the Water Supply Hose to the water tap, check the hose type and then choose the correct instruction here under.
Note that the Water Supply Hose supplied may vary from country to country, Make sure to connect the blue inlet hose to the cold water tap, and the orange inlet hose to the hot water tap.
- Washing machine is to be connected to the water mains using new hose sets and that old hose sets should not be reused.

Connecting Water Supply Hose to water tap

 (Normal tap without thread & screw type inlet hose.)

Untighten the screw

Untighten the screw of the connector so that the tap can be placed in the middle.

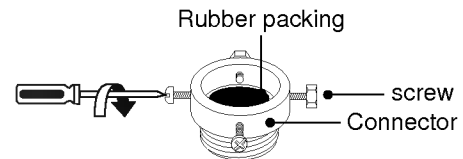

Fixing the connector to the tap

Push the upper connector up till the rubber packing is in tight contact with the tap. Then tighten the 4 screws.

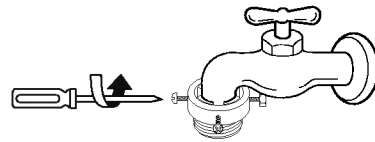

Attach the water supply hose securely to the connector

Push the water supply hose vertically upwards so that the rubber seal within the hose can adhere completely to the tap.

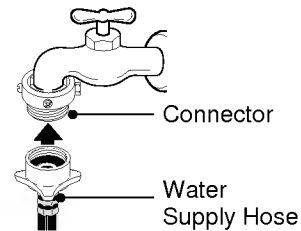

Fixing the connector to the water supply hose

Attach the water supply hose to the connector and then tighten it by screwing it to the right.

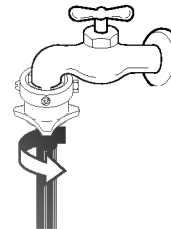

Check the connection of water supply hose and the connector

After connecting the hose, open the tap to check for any water leakage.
If the water leaks, close the tap and start again from step 1

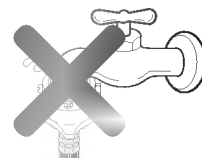

(Normal tap without thread & one touch type inlet hose.)

Separate Middle connector from Water Supply Hose

Separate Middle connector from the Water Supply Hose by pulling the Pressing Rod and the Pressing Handle that is attached to the Water Supply Hose.

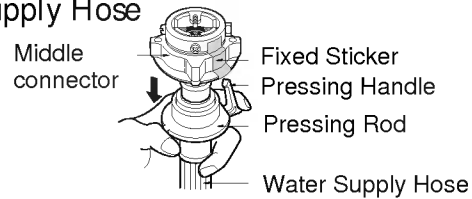

Loosen the fixed nuts to connect the connector to the tap

Untighten the screw of the connector so that the tap can be placed in the middle.

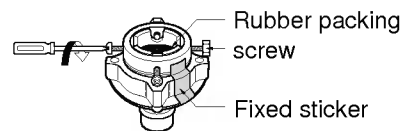

In case tap is too large.

If the tap diameter is too large or is square, untighten the 4 screws and remove the guide plate. Then follow step 1.

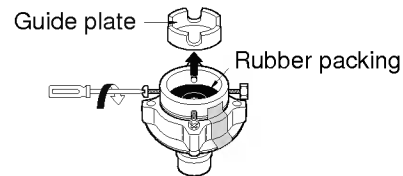

Fixing Connectors to the Tap

Push the upper connector up till the rubber packing is in tight contact with the tap. Then tighten the 4 screws.

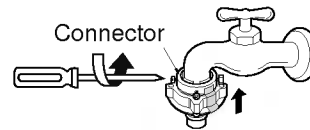

Fixing Upper Connector and Middle Connector

Remove the fixed sticker in between the Upper and Middle Connectors. Tighten the connectors by holding one connector and twist middle connector to the right.

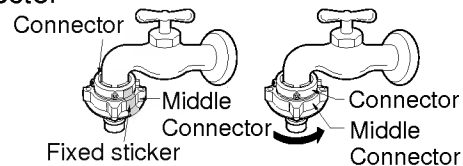

Connecting Middle Connector and Water Supply Hose

Press down the pressing rod of the Water Supply Hose which was separated from middle connector (refer to Step1) and then join it to the middle connector.

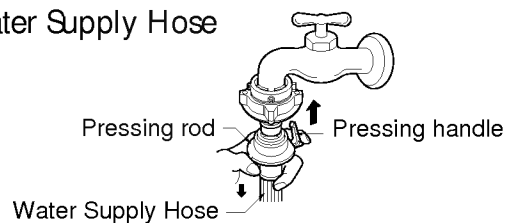

Check for water leakage

After connecting the hose, open the tap to check for any water leakage.

If the connection leaks, close the tap and start again from step 1.

If you skip step 1, water leakage may occur.



Connecting Water Supply Hose

Attach the water supply hose to the tap.

Push the water supply hose up so that the rubber packing within the hose can adhere completely to the tap.

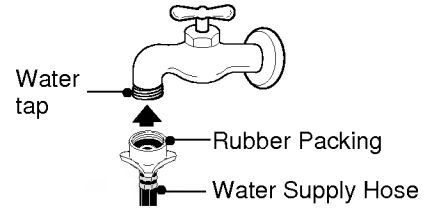

Connect the water supply hose to the tap.

Connect the water supply hose to the tap and then tighten it by screwing it to the right.

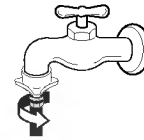

Check water leakage.

After connecting the hose, open the tap to check for any water leakage.

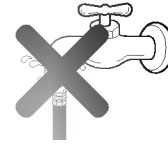

Connecting Water Supply Hose to the machine

- Connect the water supply hose to inlet valve of the washing machine, and then lock it by turning the hose connecting part.
- Check to see if there is a rubber seal inside the connector.

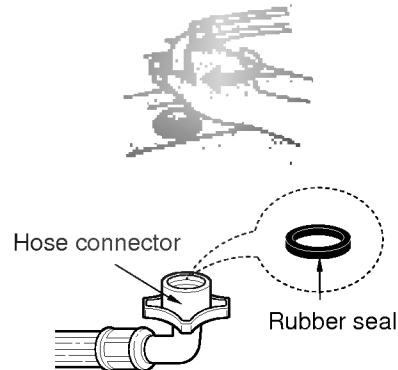

Before connecting Drain Hose, check your Drain Hose model and choose the correct instructions.

Fit the end of the drain hose to the outlet of the drain pump and tighten the clamp.

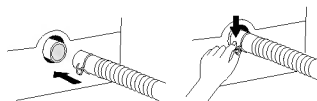

Put the other end of the drain hose over the standpipe or wash tub.

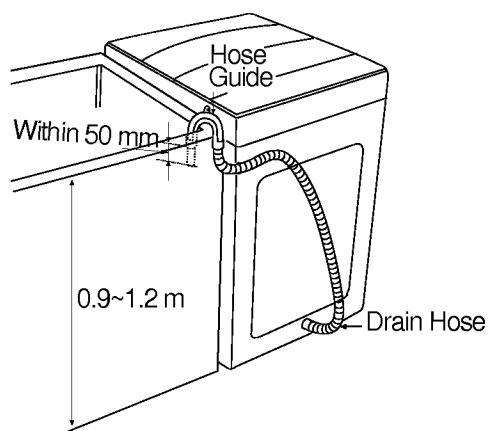

Note

- To prevent siphoning, the drain hose should not extend more than 50 mm from the end of the hose guide.
- The discharge height should be approximately 0.9 ~ 1.2 m from the floor.

Earth wire should be connected.

If the earth wire is not connected, there is possible a danger of electric shock caused by the current leakage .

Grounding Method with Ground insert space Terminal

If the AC current outlet has a ground terminal, then separate grounding is not required. Note that AC power outlet configurations may differ from country to country

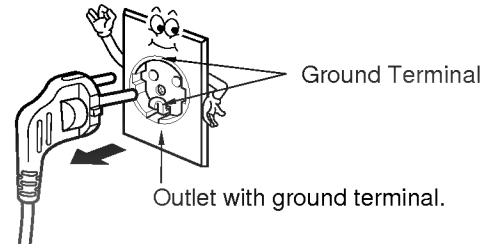

Other Grounding Method

Connect the Ground Wire to a Ground Copper Plate and bury it more than 75cm in the ground.

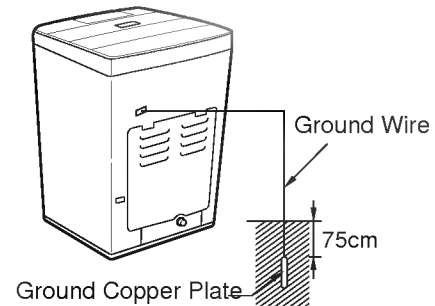

Connect the ground Wire to the socket provided exclusively for Grounding.

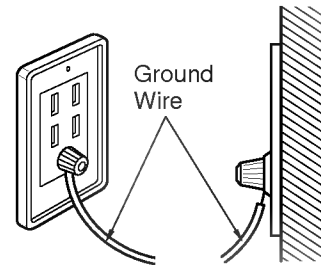

Using a Short Circuit Breaker

If grounding methods described above are not possible, a separate circuit breaker should be employed and installed by a qualified electrician

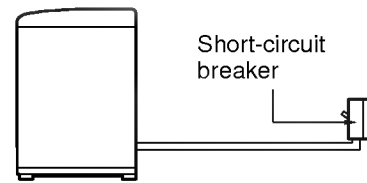

- To prevent a possible explosion, do not connect ground to a gas pipe
- Do not connect ground to telephone wires or lightning rods. This may be dangerous during electrical storms
- Connecting ground to plastic has no effect
- Ground wires should be connected when an extension cord is used.

Cleaning and maintenance

- If you always use cold water, we recommend that a warm or hot wash be used at a regular intervals e.g. every 5th wash should be at least a warm one

When you have finished

- Turn off taps to prevent the chance of flooding should a hose burst.
- Always unplug the power cord after use.

When water supply into the tub is not clean or the filter is clogged with particles (such as sand), clean the filter in the inlet valve occasionally.

(The figure of power cord and water tap may vary according to the country)

To Clean the Filter in the Inlet Valve

Close the tap before turning off the power. Select both hot/cold and then press the [START/PAUSE] button to remove water from the machine completely.



Turn off the power before pulling out the cord.

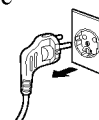

After removing the water supply hose pull out the filter. Then use a brush to clean the filter.

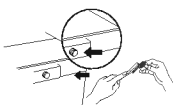

Replace the filter after cleaning it.

To Clean the Lint Filter

Pull out the lint filter from the tub in the direction shown below.



Turn the net inside out to clean the filter and rinse it with water.



Replace- the filter to the original location. Push the lip of the filter until a pop sound is heard.



Note

- If the lint filter is torn or damaged, purchase a new one from LG service center.

To Clean the Pump casing (for pump model)

Unfasten 2 screws of the back cover.

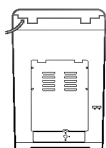

Turn the cap as shown in diagram and unfasten it. Remove foreign objects such as pin, button, coin, etc

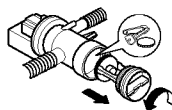

(Bottom view)

Reassemble the cap to the arrow direction and fasten it.

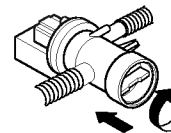

(Bottom view)

- Check if water leaks after reassembling. (The Rubber ring is in the cap)

Cleaning and Maintenance

When there is a fear of freezing

- Close the water taps and remove the Water Supply Hose.
- Remove the water which remains in the water supply.
- Lower the drain hose and drain the water in the bowl and the drain hose by spinning.

- Remove the water supply hose, and immerse it in hot water at approx.. 40°C.
- Pour approx.. 2 liters of hot water at approx.. 40°C, into the bowl and let it stand for 10 minutes.
- Connect the water supply hose to the water tap and confirm that the washing machine performs the supply and drainage of water.

Wash Inner-tub Leave the lid open after washing to allow moisture to evaporate. If you want to clean the inner-tub use a clean soft cloth dampened with liquid detergent, then rinse. (Do not use harsh or gritty cleaners.)

Inlet Hoses Hoses connecting washer to faucet should be replaced every 5 years.
Exterior Immediately wipe off any spills. Wipe with damp cloth. Try not to hit surface with sharp objects.

Long Vacations Be sure water supply is shut off at faucets. Drain all water from hoses if weather will be below freezing.

Scrud is the name given to the waxy build-up that can occur within any washer when the fabric softener comes into contact with detergent. This build-up is not brought about by a fault in the machine. If scrud is allowed to build-up in the machine it can result in stains on your clothes or an unpleasant smell in your washer. **If you wish to use fabric softener we recommend.**

If you wish to use fabric softener we recommend:

- Clean your machine regularly
- Cold water washing increases the chance of this build-up occurring. We recommend a warm or hot wash at regular intervals e.g. approx. every 5th wash.
- Fabric softener of thinner consistency is less likely to leave residue on the dispenser and contribute to a build-up.

Cleaning the inside of your washing machine

- If you use fabric softener or do regular cold water washing, it is important that you occasionally clean the inside of your machine.
- Fill your machine with hot water. Add about two cups of a powder detergent that contains phosphate.
- Select Wash cycle and operate. Repeat it 2 or 3 times.
- Stop the machine, open the lid, and leave it to soak overnight.
- After soaking, drain the machine and run the machine through a regular cycle.
- We do not recommend that you wash clothes during this procedure.

Products that might damage your washing machine





- Concentrated bleaches and diaper sanitizer will cause damage to the paintwork and components of your washer.
- Hydrocarbon solvents i.e. petrol, paint thinners and lacquer thinners, etc. can dissolve plastic and blister paint (Be careful when washing garments stained with these solvents as they are flammable DO NOT put them in washer or dryer.)
- Some pretreatment sprays or liquids can damage your washer's control panel.
- Use of dyes in your washer may cause staining of the plastic components. The dye will not damage the machine but we suggest you thoroughly clean your washer afterwards. We do not recommend the use of dye strippers in your washer.
- Do not use your washer lid as a work surface.

Look for your problem below, then check the things we suggest. More often than not, this will give you the answer to your problem. And you'll be able to carry on without having to telephone your service center.

WASH PROBLEM

| Symptom | Error Message | Check up |
|---|---|---|
| Lint or residue on clothes | <p>Incorrect sorting</p> <p>Washing too long</p> <p>Natural By-product When Washing Certain Items</p> | <ul style="list-style-type: none"> • Separate lint producers from lint collectors. • Wash small loads for a shorter time than larger loads. • Some lint is normal. Using the dryer should remove any lint not removed by the washer. |
| Detergent on clothes | Detergent not dissolving | <p>Use warmer water temperature.</p> <p>Try pre-dissolving the detergent in warm water</p> <p>Try a liquid detergent.</p> |
| Black spots on clothes | <p>Incorrect use of fabric softener</p> <p>Dye transfer</p> <p>Not enough detergent used</p> <p>A build-up caused by the interaction of fabric softener and detergent can flake off and marks on clothes.</p> | <ul style="list-style-type: none"> • When filling dispenser, do not splash or overfill. • Never pour fabric softener directly on clothes. • Pre-treat stain and rewash. • Sort whites or lightly colored items from dark colors. - Wash and dry non-colorfast clothes separately • Insufficient detergent, for the amount of soil on the clothes, can result in black marks on clothes • Cleaning the inside of your washing machine (refer to p25, p26) |
| Fabric damage (Snags, holes, tears, rips or excessive wear) | <p>Pins, snaps, hooks, sharp buttons, belt buckles, zippers, and sharp objects left in pockets</p> <p>Chemical Damage a. Chlorine Bleach b. Battery Acid c. Hydrogen Peroxide</p> | <ul style="list-style-type: none"> • Fasten snaps, hooks, buttons, and zippers. • Remove any loose brassiere wires. • Remove objects in pockets and sharp buttons. • Turn knits (which snag easily) inside out. • Dilute bleach or use the dispenser (See User's Guide) • Use caution around battery acids, skin and hair care products - these can remove color and cause holes or tears in fabrics. |

| Symptom | Error Message | Check up |
|-----------------------------|---|---|
| | <p>Non-chemical Damage</p> <p>a. Age & Normal Use</p> <p>b. Poor Construction</p> <p>c. Overloading</p> <p>d. Mice & Inserts</p> <p>e. Sunlight</p> | <ul style="list-style-type: none"> • Check construction carefully when purchasing • Mend any damage before laundering |
| The laundry comes out dirty | Water temperature is too cold. | <ul style="list-style-type: none"> • Use warmer water temperature |
| | Water temperature is not correct | <ul style="list-style-type: none"> • Select the wash temperature according to soil type. • For example, blood and mud are better washed in cold water, while oily soils wash better in warmer water. |
| | Stain is not pre-treated | <ul style="list-style-type: none"> • Brush a little detergent dissolved in water onto stains like collars and cuffs to help shift dirt. • Wash stains as soon as possible. The longer they are left the harder they are to remove. |
| | Washer is overloaded Incorrect sorting | <ul style="list-style-type: none"> • Did you load too much into the machine? • White clothes are better washed separately. Separate light and heavily soiled items, as clothes can pick up soil from dirty wash water. • Loads made up of articles of varying sizes will wash better (e.g. full loads of sheets may not wash that well). |
| | Insufficient detergent | <ul style="list-style-type: none"> • Not enough detergent for load size or amount of soil. Hard water requires more detergent than soft water. |
| Pilling | Result of normal wear on poly-cotton blends and fuzzy fabrics | <ul style="list-style-type: none"> • While this is not caused by the washer, you can slow the pilling process by washing garments inside out. |
| Grayed or yellowed clothes | Not enough detergent | Use more detergent (especially with larger loads). |
| | Water is not hot enough | Make sure water heater is delivering water at 120F~40F. (48°C ~ 60°C.). |
| | Washer is overloaded | Select load size to match clothes load. |
| | Dye transfer | Sort clothes by color. If fabric label states wash separately, unstable dyes may be indicated. |

| Symptom | Error Message | Check up |
|--------------------------|---|---|
| Water Supply Failure |  | <ul style="list-style-type: none"> • Is the water tap shut off? • Is the water supply cut off ? • Is the tap or water supply hose frozen ? • Is the water pressure low or is the filter of the inlet valve clogged with impurities? • Is Hot/Cold selected to Hot when the hose connected is Cold? • Is the Cold hose connected to Hot? |
| Drainage Failure |  | <ul style="list-style-type: none"> • Is the drain hose positioned correctly? • Is the drain hose bent or placed too high? • Is the internal part of the hose or drain pump (only pump model) clogged with impurities? • Check if electric power has gone off. |
| Spin Failure |  | <ul style="list-style-type: none"> • Is the laundry evenly balanced? • Is the washing machine placed on a flat surface? |
| Door(Lid) Open |  | <ul style="list-style-type: none"> • Is the lid closed? |
| Internal sensing failure | | <ul style="list-style-type: none"> • Ask for help at the LG Electronic branch of the Service Center |
| Power failure | | |
| Overflow failure | | |

Terms of Warranty

What Is Not Covered:

- If the product is connected to any voltage other than that shown on the rating plate.
- If the fault is caused by accident, neglect, misuse or Act of God.
- If the fault is caused by factors other than normal domestic use or use in accordance with the owner's manual.
- Provide instruction on use of product or change the set-up of the product.
- If the fault is caused by pests for example, rats or cockroaches etc..
- Noise or vibration that is considered normal for example water drain sound, spin sound, or warming beeps.
- Correcting the installation for example, levelling the product, adjustment of drain.
- Normal maintenance which recommended by the owner's manual.
- Removal of foreign objects / substances from the machine, including the pump and inlet hose filter for example, grit, nails, bra wires, buttons etc.
- Replace fuses in or correct house wiring or correct house plumbing.
- Correction of unauthorized repairs.
- Incidental or consequential damage to personal property caused by possible defects with this appliance.

If the product is installed outside the normal service area, any cost of transportation involved in the repair of the product, or the replacement of a defective part, shall be borne by the owner.

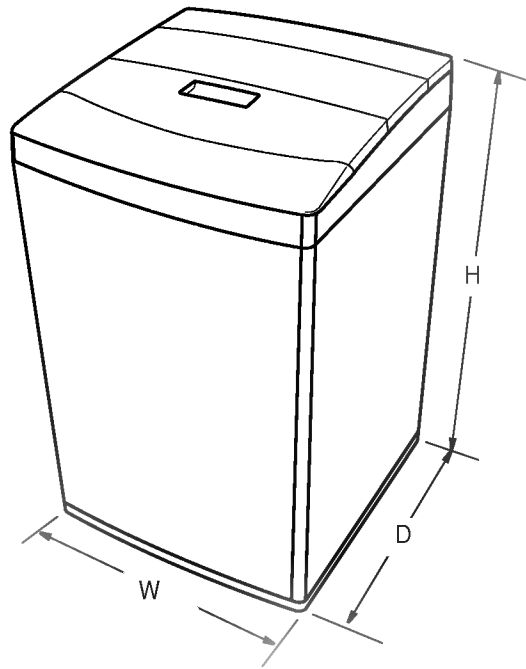

| | |
|--------------------|--|
| Model | WF-T5501PP / WF-T5505PP WF-T6105TP / WF-T6505TP |
| Size | 540(W) x 540(D) x 850(H) |
| Water tap pressure | 30 - 800 kPa (0.3 - 8 kgf /cm ²) |

※ In our continuing effort to improve the quality of our appliances, it may be necessary to make changes to the appliance without revising this manual.