

## Table of Contents

### Introduction

Introduction ..... A1

Important Precautions ..... A2

### Installation

Connecting the Monitor ..... A4

### Operation

Location and Function of Controls ..... A6

Control Panel Function ..... A7

On Screen Display (OSD) Control Adjustment ..... A8

On Screen Display(OSD) Selection and Adjustment ..... A9

### Technical Information

Energy Saving Design ..... A12

Low Radiation Compliance (MPRII) and DDC (Display Data Channel) ..... A13

Video Memory Modes ..... A14

Troubleshooting ..... A15

Service ..... A16

Specifications ..... A17

### Appendix

Communications Regulation Information ..... See back of manual

Environmental Labelling of Personal Computers ..... See back of manual

ENGLISH

## Introduction

**Thank you for purchasing a high resolution monitor. It will give you high resolution performance and convenient reliable operation in a variety of video operating modes.**

### Features

- The monitor is a 17 inches (15.9 inches viewable ) intelligent, microprocessor based monitor compatible with most analog RGB (Red, Green, Blue) display standards, including IBM PC®, PS/2®, Apple®, Macintosh®, Centris®, Quadra®, and Macintosh II family.
- The monitor provides crisp text and vivid color graphics with VGA, SVGA, XGA, and VESA Ergonomic modes (non-interlaced), and most Macintosh compatible color video cards when used with the appropriate adaptor. The monitor's wide compatibility makes it possible to upgrade video cards or software without purchasing a new monitor.
- Digitally controlled auto-scanning is done with the micro-processor for horizontal scan frequencies between 30 and 70kHz, and vertical scan frequencies between 50-160Hz. The microprocessor-based intelligence allows the monitor to operate in each frequency mode with the precision of a fixed frequency monitor.
- The microprocessor-based digital controls allow you to conveniently adjust a variety of image controls by using the OSD (On Screen Display).
- This monitor is capable of producing a maximum horizontal resolution of 1280 dots and a maximum vertical resolution of 1024 lines. It is well suited for CAD work and sophisticated windowing environments.
- For greater user health and safety, this monitor complies with the stringent swedish TCO'99 requirements for low radiation emissions.\*
- For low cost of monitor operation, this monitor is certified as meeting the EPA Energy Star requirements, and utilizes the VESA Display Power Management Signalling (DPMS) protocol for power saving during non-use periods.

\* Applies to 775E only

### Monitor Registration

The model and serial numbers are found on the rear of this unit. These numbers are unique to this unit and not available to others. You should record requested information here and retain this guide as a permanent record of your purchase. Staple your receipt here.

Date of Purchase : \_\_\_\_\_  
Dealer Purchased From : \_\_\_\_\_  
Dealer Address : \_\_\_\_\_  
Dealer Phone No. : \_\_\_\_\_  
Model No. : \_\_\_\_\_  
Serial No. : \_\_\_\_\_

## Important Precautions

**This unit has been engineered and manufactured to assure your personal safety, but improper use can result in potential electrical shock or fire hazard. In order not to defeat the safeguards incorporated in this monitor, observe the following basic rules for its installation, use, and servicing. Also follow all warnings and instructions marked directly on your monitor.**

### On Safety

Use only the power cord supplied with the unit. In case you use another power cord, make sure that it is certified by the applicable national standards if not being provided by the supplier. If the power cable is faulty in any way, please contact the manufacturer or the nearest authorized repair service provider for a replacement.

Operate the monitor only from a power source indicated in the specifications of this manual or listed on the monitor. If you are not sure what type of power supply you have in your home, consult with your dealer.

Overloaded AC outlets and extension cords are dangerous. So are frayed power cords and broken plugs. They may result in a shock or fire hazard. Call your service technician for replacement.

Do not Open the Monitor

- There are no user serviceable components inside.
- There are Dangerous High Voltages inside, even when the power is OFF.
- Contact your dealer if the monitor is not operating properly.

To Avoid Personal Injury :

- Do not place the monitor on a sloping shelf unless properly secured.
- Use only a stand recommended by the manufacturer.
- Do not try to roll a stand with small casters across thresholds or deep pile carpets.

To Prevent Fire or Hazards:

- Always turn the monitor OFF if you leave the room for more than a short period of time. Never leave the monitor ON when leaving the house.
- Keep children from dropping or pushing objects into the monitor's cabinet openings. Some internal parts carry hazardous voltages.

### Important Precautions

- Do not add accessories that have not been designed for this monitor.
- During a lightning storm or when the monitor is to be left unattended for an extended period of time, unplug it from the wall outlet.
- Do not bring magnetic devices such as magnets or motors near the picture tube.

#### On Installation

Do not allow anything to rest upon or roll over the power cord, and do not place the monitor where the power cord is subject to damage.

Do not use this monitor near water such as near a bathtub, washbowl, kitchen sink, laundry tub, in a wet basement, or near a swimming pool.

Monitors are provided with ventilation openings in the cabinet to allow the release of heat generated during operation. If these openings are blocked, built-up heat can cause failures which may result in a fire hazard.

Therefore, NEVER:

- Block the bottom ventilation slots by placing the monitor on a bed, sofa, rug, etc.
- Place the monitor in a built-in enclosure unless proper ventilation is provided.
- Cover the openings with cloth or other material.
- Place the monitor near or over a radiator or heat source.

#### On Cleaning

- Unplug the monitor before cleaning the face of the picture tube.
- Use a slightly damp (not wet) cloth. Do not use an aerosol directly on the picture tube because overspray may cause electrical shock.

#### On Repacking

- Do not throw away the carton and packing materials. They make an ideal container in which to transport the unit. When shipping the unit to another location, repack it in its original material.

**Connection to any IBM  
VGA PC compatible  
system**

## Connecting the Monitor

Figure 1 shows the signal cable connections from the monitor to the Video Graphics Array (VGA) port typical in an IBM PC or PC compatible. This also applies to any graphics video card for PC-CAD or workstation that has a 15 pin high density (3 row) d-Sub connector.

1. Power off both the monitor and PC.
2. Connect the 15 pin VGA connector of the supplied signal cable to the output VGA video connector on the PC and the matching input connector on the rear of the monitor. The connectors will mate only one way. If you cannot attach the cable easily, turn the connector upside down and try again. When mated, tighten the thumbscrews to secure the connection.
3. Power ON the PC, then the monitor.
4. If you see the SELF DIAGNOSTICS message, check the signal cable and connectors.
5. After using the system, power OFF the monitor, then the PC.

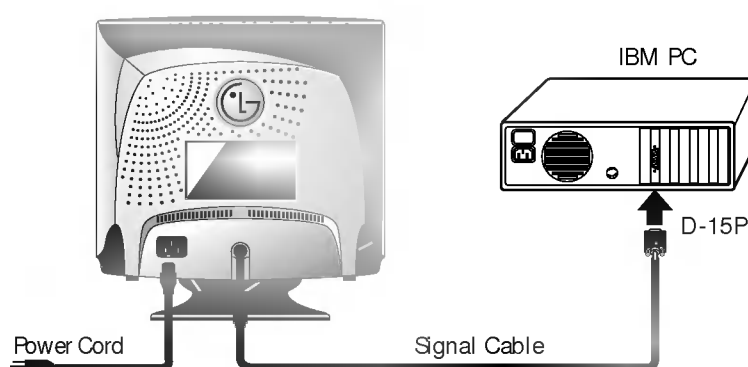

Figure 1.

## Connecting to an Apple Macintosh PC

### Connecting the Monitor

Figure 2 shows the connection to an Apple Macintosh, using a separately purchased adapter.

1. Power OFF both the monitor and the PC.
2. Locate the appropriate MAC to VGA adapter block at your local computer store. This adapter changes the high density 3 row 15 pin VGA connector to the correct 15 pin 2 row connection to mate with your MAC. Attach the other end of the signal cable to the side of the adapter block with 3 rows.
3. Connect the attached adapter block/signal cable to the video output on your MAC.
4. Power ON the PC, then the monitor.
5. If you see the SELF DIAGNOSTICS message, check the signal cable and connectors.
6. After using the system, power OFF the monitor, then the PC.

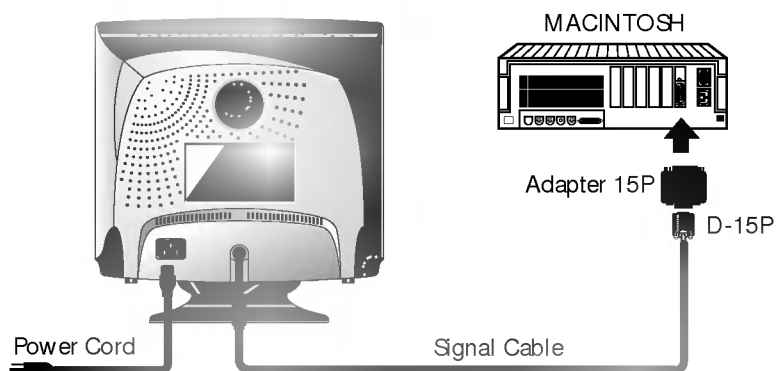
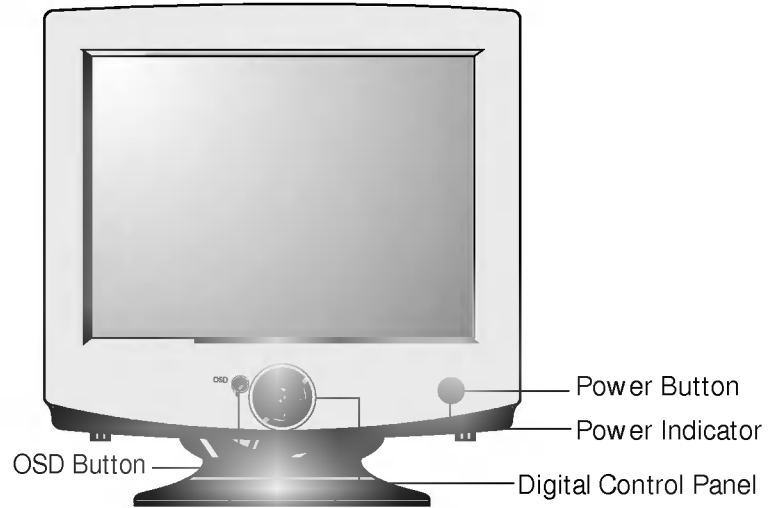

Figure 2.

## Location and Function of Controls

Front View



Rear View

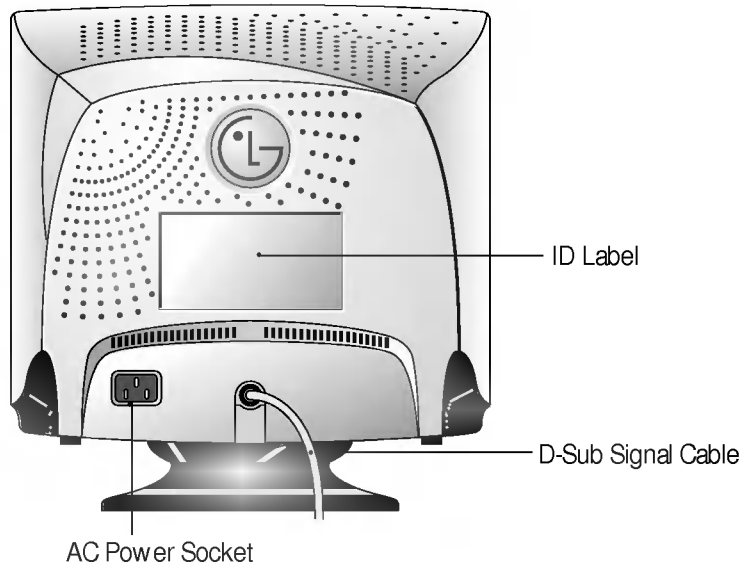

## Front Panel Controls

### Control Panel Function

Use this button to enter or exit the on screen display. If you don't use OSD menu for 15 seconds after OSD Window is displayed, OSD Window will be automatically closed.

The power indicator light is shown in the power button. This indicator lights up green when the monitor operates normally. If the monitor is in DPM (Energy Saving) mode (stand-by/ suspend/power off), this indicator color changes to amber.

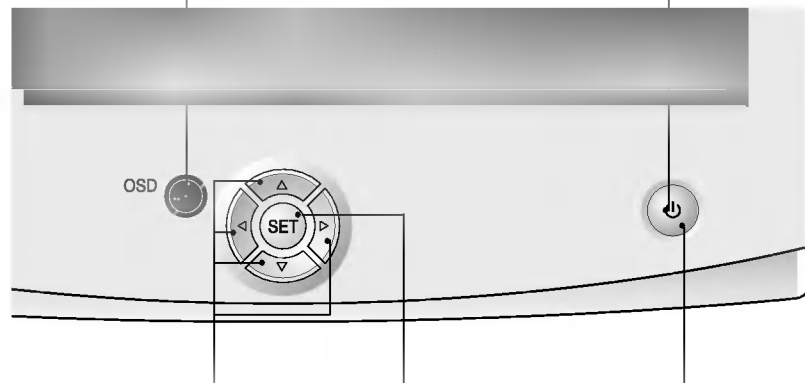

Use these buttons to choose or adjust items in the on screen display.

Use this button to enter a selection in the on screen display.

Use this button to turn the monitor on or off.



## On Screen Display (OSD) Control Adjustment

Making adjustments to the image size, position and operating parameters of the monitor are quick and easy with the On Screen Display Control system. A quick example is given below to familiarize you with the use of the controls. Following section is an outline of the available adjustments and selections you can make using the OSD.

### NOTE

- Allow the monitor to stabilize for at least 30 minutes before making image adjustment.

To make adjustments in the On Screen Display, follow these steps:

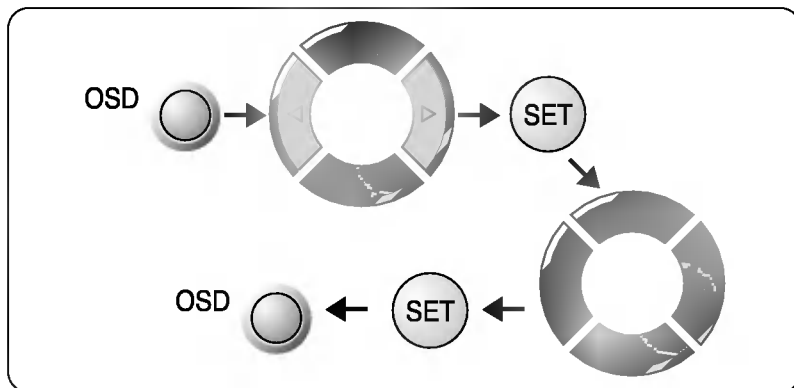

- 1** Press the OSD Button, then the main menu of the OSD appears.
- 2** To access a control, use the  $\Delta$  or  $\nabla$  Buttons. When the icon you want becomes highlighted, press the SET Button.
- 3** Use the  $\Delta/\nabla/\leftarrow/\rightarrow$  Buttons to adjust the item to the desired level.
- 4** Accept the changes by pressing the SET Button.
- 5** Exit the OSD by Pressing the OSD Button.

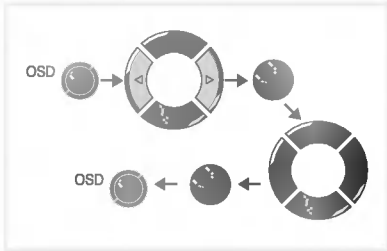

## On Screen Display(OSD) Selection and Adjustment



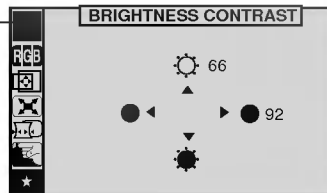

You were introduced to the procedure of selection and adjusting an item using the OSD system.

Listed below are the icons, icon names, and icon descriptions of the items that are shown on the Menu.



  **Brightness**  
Used to adjust the brightness of the screen.

  **Contrast**  
Adjust the display to the contrast desired.



**PRESET 6500K/ 9300K**  
To appear the displays color temperature.  
•6500K:Slightly reddish white.  
•9300K:Slightly bluish white.



**TEMP** User easily color set without adjustment Red, Green and Blue (R/G/B).

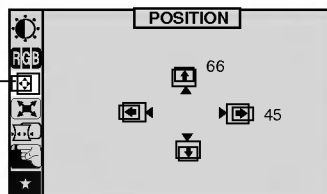

**RED** To set your own color levels.

**GREEN** To set your own color levels.

**BLUE** To set your own color levels.



  **Vertical Position**  
To move image up and down.

  **Horizontal Position**  
To move picture image left and right.

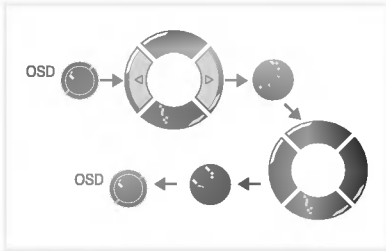

## On Screen Display(OSD) Selection and Adjustment

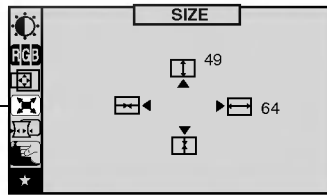

**Vertical Size**  
To adjust image height.



**Horizontal Size**  
To adjust image width.

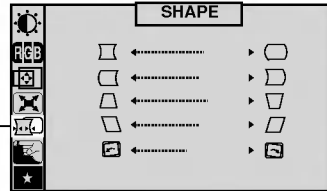

**Side Pincushion**  
To correct the bowing in and out of the image.



**Side pincushion balance**  
To correct the balance of both sides bowing.



**Trapezoid**  
To correct geometric distortion.



**Parallelogram**  
This control adjusts for a skewing of the screen image.



**Tilt**  
To correct image rotation.

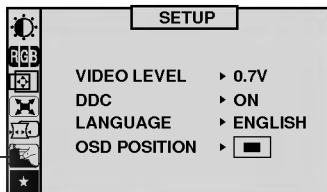

**VIDEO LEVEL** This item is used to select the monitor's input signal level. The normal level used for most PC's is 0.7V. When the screen suddenly gets brightened or blurry, please select 1.0V and try again.

**DDC** To select the DDC function(ON/OFF).

**LANGUAGE** To choose the language in which the control names are displayed.

**OSD POSITION** To adjust position of the OSD window on the screen.

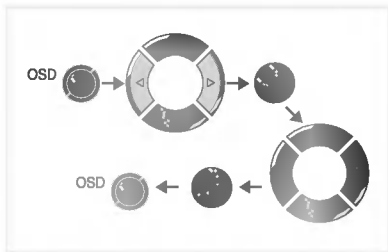

## On Screen Display(OSD) Selection and Adjustment

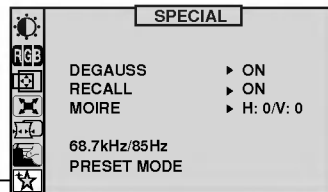

**DEGAUSS** To manually demagnetize the screen which may show some image or color incorrectly.

**RECALL** You can use this function when you want to go back to the screen display of the time you purchased the product after adjusting to modify it in the Preset Mode.  
When you are in the User mode, you can recall only □, □, △, □ items. After using Recall, adjust the screen display again if necessary. If you want more information on the Preset Mode, refer to A14 page.

**MOIRE** This item allows you to reduce the moire (Moire is caused by interference Horizontal Scan Line with the periodical dot screen). It is normally OFF(H:0/V:0). The moire adjustments may affect the focus of the screen. The screen image may shake slightly while the moire reduction function is on.

## Energy Saving Design

This monitor complies with the EPA's Energy Star program, which is a program designed to have manufacturers of computer equipment build circuitry into their products to reduce power consumption during time of non-use.

This monitor also goes into its energy saving mode if you exceed the monitor's operating limits, such as the maximum resolution of 1280x1024 or the frequency refresh rates of 30-70kHz horizontal or 50-160Hz vertical. When this monitor is used with a Green or EPA Energy Star PC, or a PC with a screen blanking software following the VESA Display Power Management Signalling (DPMS) protocol, this monitor can conserve significant energy by reducing power consumption during periods of non-use. When the PC goes into the energy saving mode, the monitor will go into a suspended operation state, indicated by the Power LED light changing from a green color to an amber color. After an extended period in the suspended mode, the monitor will then enter a semi-OFF mode to conserve more energy. In the semi-OFF mode or DPMS OFF mode as we call it in our specifications, the Power LED will still show an amber color. When you awaken your PC by hitting a key or moving the mouse, the monitor will also awaken to its normal operating mode, indicated by the green Power LED light. By following these conventions, the power consumption can be reduced to the following levels:

### Power Consumption

| Mode         | Hori. Sync | Verti. Sync | Video  | Power Consumption | LED Color |
|--------------|------------|-------------|--------|-------------------|-----------|
| Normal(Max.) | On         | On          | Normal | ≤105W             | Green     |
| Stand-by     | Off        | On          | Off    | ≤ 15W             | Amber     |
| Suspend      | On         | Off         | Off    | ≤ 15W             | Amber     |
| Off          | Off        | Off         | Off    | < 5W              | Amber     |



---

## Low Radiation Compliance (MPR II)

## Low Radiation Compliance (MPR II) and DDC (Display Data Channel)

This monitor meets one of the strictest guidelines available today for low radiation emissions, offering the user extra shielding and an antistatic screen coating. These guidelines, set forth by a government agency in Sweden, limit the amount of emission allowed in the Extremely Low Frequency (ELF) and Very Low Frequency (VLF) electromagnetic range.

## DDC (Display Data Channel)

DDC is a communication channel over which the monitor automatically informs the host system (PC) about its capabilities. This monitor has DDC function; DDC2B. DDC2B carry out uni-directional communication between the PC and the monitor. Under these situations, the PC sends display data to the monitor but not commands to control the monitor settings.

### NOTE

- PC must support DDC functions to do this.
- If your monitor is displaying a mono chrome image or the wrong resolution, select the DDC OFF function.



## Video Memory Modes

The monitor has 36 memory locations for display modes, 11 of which are factory preset to popular video modes.

### Display Modes (Resolution)

|    | Display Modes(Resolution) | Horizontal Freq.(kHz) | Vertical Freq.(Hz) |
|----|---------------------------|-----------------------|--------------------|
| 1  | VGA 640 x 400             | 31.47                 | 70                 |
| 2  | VESA 640 x 480            | 31.47                 | 60                 |
| 3  | VESA 640 x 480            | 37.50                 | 75                 |
| 4  | VESA 640 x 480            | 43.27                 | 85                 |
| 5  | MAC 832 x 624             | 49.75                 | 75                 |
| 6  | VESA 800 x 600            | 37.88                 | 60                 |
| 7  | VESA 800 x 600            | 46.88                 | 75                 |
| 8  | VESA 800 x 600            | 53.68                 | 85                 |
| 9  | VESA 1024 x 768           | 60.02                 | 75                 |
| 10 | VESA 1024 x 768           | 68.677                | 85                 |
| 11 | VESA 1280 x 1024          | 63.98                 | 60                 |

### User Modes

- Modes 12-36 are empty and can accept new video data. If the monitor detects a new video mode that has not been present before or is not one of the preset modes, it stores the new mode automatically in one of the empty modes starting with mode 12.

If you use up the 25 blank modes and still have more new video modes, the monitor replaces the information in the user modes starting with mode 12.

### Recalling Display Modes

- When your monitor detects a mode it has seen before, it automatically recalls the image settings you may have made the last time you used that mode.

You may, however, manually force a recall of each of the 11 preset modes by pressing the Recall button. All preset modes are automatically recalled as the monitor senses the incoming signal.

The ability to recall the preset modes is dependent on the signal coming from your PC's video card or system. If this signal does not match any of the factory modes, the monitor automatically sets itself to display the image.

## Troubleshooting

Check the following before calling for service.

### SELF DIAGNOSTICS message.

- The signal cable is not connected, or is loose. Check and secure the connection.

### OUT OF FREQUENCY message appears.

- The frequency of the signal from the video card is outside the operating range of the monitor.

\* Horizontal Frequency : 30-70kHz

\* Vertical Frequency : 50-160Hz

Use the graphics board's utility software to change the frequency setting (Refer to the manual for graphics board).

### The power LED is illuminated amber.

- Display power management mode.
- There is no active signal coming from the PC.
- The signal cable is not fastened securely.
- Check the computer power and graphics adapter configuration.

### The image on the SCREEN is not centered, or too small, or not a rectangle shape.

- Image adjustment not been done yet in the current operating mode. Use the OSD, SET and  $\Delta$ / $\nabla$ / $\leftarrow$ / $\rightarrow$  buttons to set the image to your liking.

### The monitor doesn't enter the power saving off mode (Amber).

- Computer video signal is not VESA DPMS standard. Either the PC or the video controller card is not using the VESA DPMS power management function.

### An abnormal picture is displayed on the screen. For example, the upper part of the picture may be missing or dark.

- If using certain non-VESA Standard video card, an abnormal picture may be displayed. Try setting it to one of the factory preset modes, or selecting to a resolution and refresh rate within the specification limits of the monitor.

#### NOTE

- If the power indicator(LED) light is blinking amber, may result in abnormal condition of the monitor.
- Then press a power ON/OFF button on the front panel control and call your service technician for more information.



### Service

Unplug the monitor from the wall outlet and refer servicing to qualified service personnel when :

- The power cord or plug is damaged or frayed.
- Liquid has been spilled into the monitor.
- The monitor has been exposed to rain or water.
- The monitor does not operate normally following the operating instructions. Adjust only those controls that are covered in the operating instructions. An improper adjustment of other controls may result in damage and often requires extensive work by a qualified technician to restore the monitor to normal operation.
- The monitor has been dropped or the cabinet has been damaged.
- The monitor exhibits a distinct change in performance.
- Snapping or popping from the monitor is continuous or frequent while the monitor is operating. It is normal for some monitors to make occasional sounds when being turned on or off, or when changing video modes.

Do not attempt to service the monitor yourself, as opening or removing covers may expose you to dangerous voltage or other hazards. Refer all servicing to qualified service personnel.

## Sync Signal Types

## Specifications

| 1 | Separate Sync. | H. Sync. | V. Sync. |
|---|----------------|----------|----------|
|---|----------------|----------|----------|

(N.C : No Connection)

## Signal Connector Pin Assignment

15pin VGA Connector

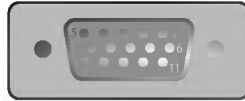

|   |              |    |          |
|---|--------------|----|----------|
| 1 | Red          | 9  | N.C.     |
| 2 | Green        | 10 | Ground   |
| 3 | Blue         | 11 | Ground   |
| 4 | Ground       | 12 | SDA      |
| 5 | Self-Test    | 13 | H. Sync. |
| 6 | Red Ground   | 14 | V. Sync. |
| 7 | Green Ground | 15 | SCL      |
| 8 | Blue Ground  |    |          |



## Specifications

|  |   |
|--|---|
| <b>Picture Tube</b>                              | 17 inch (15.9 inches viewable) FST                        |
|  | 90 degree deflection                                      |
|  | 0.27mm dot pitch  |
|  | AGARAS(Anti-Glare Anti-Reflective Anti-Static) coating    |
| <b>Sync Input</b>                                | Horizontal Freq. 30 - 70kHz (Automatic)                   |
|  | Vertical Freq. 50 - 160Hz (Automatic)                     |
|  | Input Form Separate TTL, Positive/Negative                |
|  | Signal Input 15 pin D-Sub Connector                       |
| <b>Video Input</b>                               | Input Form Separate, RGB Analog, 0.7Vp-p/75 ohm, Positive |
|  | Resolution(max) 1280 x 1024 @60Hz                         |
| <b>Dimensions<br/>(with tilt/swivel stand)</b>   | Width 41.0 cm / 16.1 inches                               |
|  | Height 43.2 cm / 17.3 inches                              |
|  | Depth 44.0 cm / 17.0 inches                               |
| <b>Power Input</b>                               | AC 100-240V 50/60Hz 2.0A                                  |
|  | Net 15.5 kg (34.2 lbs)                                    |
| <b>Weight</b><br><b>Environmental Conditions</b> | Operating Condition                                       |
|  | Temperature 10 °C to 35 °C                                |
|  | Humidity 10 % to 90 % non-Condensing                      |
|  | Storage Condition   |
|  | Temperature 0 °C to 60 °C                                 |
| Humidity 5 % to 90 % non-Condensing              |   |

### NOTE

- Information in this document is subject to change without notice.