



MICROWAVE OVEN

OWNER'S MANUAL

**MODEL : MB-314XF
MB-314XB**

Please read this manual carefully before using this product.
Retain this manual for future reference.

PRECAUTIONS TO AVOID POSSIBLE EXPOSURE TO EXCESSIVE MICROWAVE ENERGY

Do not attempt to operate the oven with the door open since open door operation can result in harmful exposure to microwave energy. It is important not to tamper with the safety interlocks.

Do not place any object between the oven front face and the door or allow soil or cleaner residue to accumulate on sealing surfaces.

Do not operate the oven if it is damaged. It is particularly important that the oven door closes properly and that there is no damage to the (1) door, bent, (2) hinges and latches (broken or loosened), (3) door seals and sealing surfaces.

The oven should not be adjusted or repaired by anyone except properly qualified service personnel.

WARNING

Please ensure cooking times are correctly set as over cooking may result in FIRE and subsequent damage to the oven.

WARNING

When heating liquids, e.g. soups, sauces and beverages in your microwave oven, overheating the liquid beyond boiling point can occur without evidence of bubbling. This could result in a sudden boil over of the hot liquid. To prevent this possibility the following steps should be taken :

1. Avoid using straight sided containers with narrow necks.
2. Do not overheat.
3. Stir the liquid before placing the container in the oven and again halfway through the heating time.
4. After heating, allow to stand in the oven for a short time, stir or shake them again carefully and check the temperature of them before consumption to avoid burns (especially, contents of feeding bottles and baby food jars).

IMPORTANT SAFETY INSTRUCTIONS

WARNING - To reduce the risk of burns, electric shock, fire, injury to persons or exposure to excessive microwave energy:

1. Read all instructions before using the appliance.

2. Read and follow the specific **“PRECAUTIONS TO AVOID POSSIBLE EXPOSURE TO EXCESSIVE MICROWAVE ENERGY”** found on page 2 of this manual.

3. This appliance must be grounded. Connect only to properly grounded outlet.

See **“GROUNDING INSTRUCTIONS”** found on page 5 of this manual.

4. Install or locate this appliance only in accordance with the provided installation instructions.

5. Some products such as whole eggs and sealed containers-for example, closed glass jars-may explode and should not be heated in this oven.

6. Use this appliance only for its intended use as described in the manual. Do not use corrosive chemicals or vapors in this appliance. This type of oven is specifically designed to heat, cook, or dry food. It is not designed for industrial or laboratory use.

7. As with any appliance, close supervision is necessary when used by children.

8. Do not operate this appliance if it has a damaged cord or plug, if it is not working properly, or if it has been damaged or dropped.

9. This appliance should be serviced only by qualified service personnel. Contact nearest authorized service facility for examination, repair or adjustment.

10. Do not cover or block any openings on the appliance.

11. Do not store this appliance outdoors. Do not use this product near water-for example, near a kitchen sink, in a wet basement, or near a swimming pool, and the like.

12. Do not immerse cord or plug in water.

13. Keep cord away from heated surfaces.

14. Do not let cord hang over edge of table or counter.

15. Either-(a) When cleaning surfaces of door and oven that comes together on closing the door, use only mild, nonabrasive soaps or detergents applied with a sponge or soft cloth; or when separate cleaning instructions apply, (b) See door surface cleaning instruction on (specific page or section to be included).

16. To reduce the risk of fire in the oven cavity:

a. Do not overcook food. Carefully attend appliance if paper, plastic, or other combustible materials are placed inside the oven to facilitate cooking.

b. Remove wire twist-ties from paper or plastic bags before placing bag in oven.

c. If materials inside the oven should ignite, **KEEP OVEN DOOR CLOSED**, turn oven off, and disconnect the power cord, or shut off power at the fuse or circuit breaker panel.

d. Do not use the cavity for storage purposes. Do not leave paper products, cooking utensils, or food in the cavity when not in use.

17. Do not heat any type of baby bottles or baby food. Uneven heating may occur and could cause personal injury.

18. Avoid heating small-necked containers such as syrup bottles.

19. Avoid using corrosive and vapors, such as sulfide and chloride.

20. Liquids heated in certain shaped containers (especially cylindrical-shaped containers) may become overheated. The liquid may splash out with a loud noise during or after heating or when adding ingredients (instant coffee, etc.) resulting in harm to the oven and possible injury. In all containers, for best results, stir the liquid several times before heating. Always stir liquid several times between reheatings.

SAVE THESE INSTRUCTIONS

4	TECHNICAL SPECIFICATIONS
5	INSTALLATION
7	INTRODUCTION
10	FEATURE DIAGRAM / CONTROL PANEL
11	OPERATING INSTRUCTIONS
23	GENERAL PROCEDURE FOR COOKING MEAT
23	GENERAL PROCEDURE FOR COOKING POULTRY
24	GENERAL PROCEDURE FOR COOKING FISH
25	FRESH VEGETABLE CHART
26	COOKING & BROWNING
28	COMBINATION COOKING
31	OTHER HELPFUL INSTRUCTIONS
32	SAFETY PRECAUTIONS
33	QUESTIONS AND ANSWERS

	MB-314XF	MB-314XB
Power Input	120V AC / 60Hz	120V AC / 60Hz
Output	1000W (IEC60705 RATING STANDARD)	1000W (IEC60705 RATING STANDARD)
Microwave Frequency	2450MHz	2450MHz
Outside Dimensions	530mm(W) X 315mm(H) X 394mm (D)	530mm(W) X 315mm(H) X 394mm (D)
Cavity Dimensions	348mm(W) X 242mm(H) X 373mm (D)	348mm(W) X 242mm(H) X 373mm (D)
Power Consumption	1,400W (Microwave) 1,000W (Grill)	1,400W (Microwave) 1,000W (Grill)

A. GROUNDING INSTRUCTIONS

For personal safety, this appliance must be properly grounded.

In the event of an electrical short circuit, grounding reduces the risk of electric shock by providing an escape route for the electric current.

The power cord of this appliance is equipped with plug to minimize the possibility of electric shock hazard from this appliance.

The plug must be plugged into an outlet that is properly installed and grounded.

WARNING – Improper use of the grounding plug can result in a risk of electric shock.

The consumer should have it checked by a qualified electrician or serviceman if the grounding instructions are not completely understood, or if doubt exists as to whether the appliance is properly grounded.

Caution: Attaching the adapter ground terminal to the wall receptacle cover screw does not ground the appliance unless the cover screw is metal, and not insulated, and the wall receptacle is grounded through the house wiring.

- Usage situations where the appliance power cord will be disconnected frequently: Do not use an adapter plug in these situations because disconnecting of the power cord causes undue strain on the adapter and leads to eventual failure of the adapter ground terminal.

NOTE:

1. Short power-supply cord is provided to reduce the risks resulting from becoming entangled in or tripping over a longer cord.
2. Longer cord sets or extension cords are available and may be used if care is exercised in their use.
3. If a long cord or extension cord is used, (1) the marked electrical rating of the cord set or extension cord should be at least as great as the electrical rating of the appliance, (2) the longer cord should be arranged so that it will not drape over the countertop or tabletop where it can be pulled on by children or tripped over accidentally.

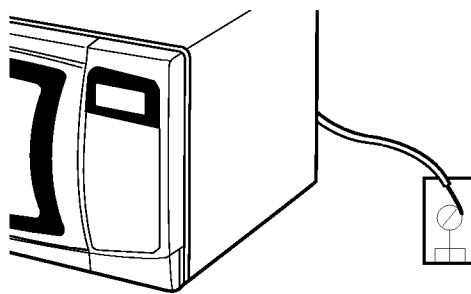
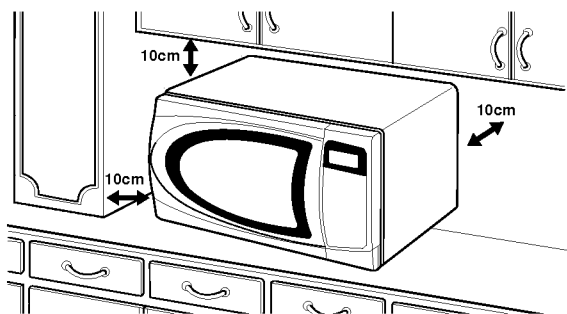

B. CIRCUITS

For safety purposes this oven must be plugged into above 15 Amp for 120V, 60Hz and above 10 Amp for 220V, 60Hz circuit. No other electrical appliances or lighting circuits should be on this line. If in doubt, consult a licensed electrician.

C. VOLTAGE WARNING

The voltage used at the wall receptacle must be the same as specified on the oven serial plate located on the back or on the side of the control panel of the oven. Use of a higher voltage is dangerous and may result in a fire or other type of accident causing oven damage.

Low voltage will cause slow cooking. In case your microwave oven does not perform normal operation in accordance with AC power source and voltage, remove the power cord and then insert it again.

D. DO NOT BLOCK AIR VENTS

All air vents should be kept clear during cooking. If air vents are covered during oven operation the oven may overheat. In this case a sensitive thermal safety device automatically turns the oven off. The oven will be inoperable until it has cooled sufficiently.

E. PLACEMENT OF THE OVEN

Your microwave oven can be placed easily in your kitchen, family room, or anywhere else in your home. Place the oven on a flat surface such as a kitchen countertop or a specially designed microwave oven cart. Do not place oven above a gas or electric range. Free air flow around the oven is important.

F. RADIO INTERFERENCE

1. Operation of the microwave oven may cause interference to your radio, TV or similar equipment.
2. When there is interference, it may be reduced or eliminated by taking the following measures:
 - a. Clean door and sealing surfaces of the oven
 - b. Reorient the receiving antenna of radio or television.
 - c. Relocate the microwave oven with respect to the receiver.
 - d. Move the microwave oven away from the receiver.
 - e. Plug the microwave oven into a different outlet so that microwave oven and receiver are on different branch circuits.

How the Microwave Oven Works

Microwaves are a form of energy similar to radio and television waves and ordinary daylight. Ordinarily, microwaves spread outwards as they travel through the atmosphere and disappear without effect.

Microwave ovens, however, have a magnetron which is designed to make use of the energy in microwaves. Electricity, supplied to the magnetron tube, is used to create microwave energy. These microwaves enter the cooking area through openings inside the oven. A turntable or tray is located at the bottom of the oven. Microwaves cannot pass through metal walls of the oven, but they can penetrate such materials as glass, porcelain and paper, the materials out of which microwave-safe cooking dishes are constructed. Microwaves do not heat the cookware, though cooking vessels will eventually get hot from the heat generated by the food.

A very safe appliance. Your microwave oven is one of the safest of all home appliances. When the door is opened, the oven automatically stops producing microwaves. Microwave energy is converted completely to heat when it enters food, leaving no “left over” energy to harm you when you cook your food.

Getting The Best Results From Your Microwave Oven

Keeping an eye on things. The recipes in this book have been formulated with great care, but your success in preparing them depends, of course, on how much attention you pay to the food as it cooks. Always watch your food while it cooks. Your microwave oven is equipped with a light that turns on automatically when the oven is in operation so that you can see inside and check the progress of your recipe. Directions given in recipes to ‘elevate’, ‘stir’, and the like should be thought of as the minimum steps recommended. If the food seems to be cooking unevenly, simply make the necessary adjustments you think appropriate to correct the problem.

Factors affecting cooking times. To check the wattage of your oven, refer to the specifications at the beginning of this book. Many factors affect cooking times. The temperature of ingredients used in a recipe makes a big difference in cooking times.

For example, a cake made with ice-cold butter, milk, and eggs will take considerably longer to bake than one made with ingredients that are at room temperature. All of the recipes in this book give a range of cooking times. In general, you will find that the food remains under-cooked at the lower end of the time range, and you may sometimes want to cook your food beyond the maximum time given, according to personal preference. The governing philosophy of this book is that it is best for a recipe to be conservative in giving cooking times. While undercooked food is ruined for good. Some of the recipes, particularly those for bread, cakes, and custards, recommend that food be removed from the oven when they are slightly undercooked. This is not a mistake. When allowed to stand, usually covered, these foods will continue to cook outside of the oven as the heat trapped within the outer portions of the foods gradually travels inward. If the foods are left in the oven until they are cooked all the way through, the outer portions will become overcooked or even burnt. As you gain experience in using your microwave oven, you will become increasingly skillful in estimating both cooking and standing times for various foods.

How Food Characteristics Affect Microwave Cooking

Density of foods: Light, porous food such as cakes and breads cook more quickly than heavy, dense foods such as roasts and casseroles. You must take care when microwaving porous foods that the outer edges do not become dry and brittle.

Height of foods: The upper portion of tall foods, particularly roasts, will cook more quickly than the lower portion. Therefore, it is wise to turn tall foods during cooking, sometimes several times.

Moisture content of foods: Since the heat generated from microwaves tends to evaporate moisture, relatively dry foods such as roasts and some vegetables should either be sprinkled with water prior to cooking or covered to moisture.

Bone and fat content of foods: Bones conduct heat and fat cooks more quickly than meat. Therefore, care must be taken when cooking bony or fatty cuts of meat that the meats do not cook unevenly and do not become overcooked.

Quantity of foods: The number of microwaves in your oven remains constant regardless of how much food is being cooked. Therefore, the more food you place in the oven, the longer the cooking time. Remember to decrease cooking times by at least one third when halving a recipe.

Shape of foods: Microwaves penetrate only about 1 inch (2.5cm) into foods the interior portion of thick foods are cooked as the heat generated on the outside travels inward. In other words, only the outer edge of any foods is actually cooked by microwave energy; the rest is cooked by convection. It follows then that the worst possible shape for a food that is to be microwaved is a thick square. The corners will burn long before the centre is even warm. Round thin foods and ring shaped foods cook successfully in the microwave.

Special Techniques In Microwave Cooking

Browning: Meats and poultry that are cooked fifteen minutes or longer will brown lightly in their own fat. Foods that are cooked for a shorter period of time may be brushed with a browning sauce to achieve an appetizing colour. The most commonly used browning sauces are Worcestershire sauce, soya sauce and barbecue sauce. Since relatively small amounts of browning sauces are added to foods, the original flavour of recipes are not altered.

Covering: A cover traps heat and steam which causes food to cook more quickly. You may either use a lid or microwave clingfilm with a corner folded back to prevent splitting.

Covering with greaseproof paper: Greaseproofing effectively prevents spattering and helps food retain some heat. But because it makes a looser cover than a lid or clingfilm, it allows the food to dry out slightly.

Wrapping in greaseproof or paper towel: Sandwiches and many other foods containing prebaked bread should be wrapped prior to microwaving to prevent drying out.

Arranging and spacing: Individual foods such as baked potatoes, small cakes and hors d'oeuvres will heat more evenly if placed in the oven an equal distance apart, preferably in a circular pattern. Never stack foods on top of one another.

Stirring: Stirring is one of the most important of all microwaving techniques. In conventional cooking, foods are stirred for the purpose of blending. Microwaved foods, however, are stirred in order to spread and redistribute heat. Always stir from the outside towards the centre as the outside of the food heats first.

Turning over: Large, tall foods such as roasts and whole chickens should be turned so that the top and bottom will cook evenly. It is also a good idea to turn cut up chicken and chops.

Placing thicker portions facing outwards: Since microwaves are attracted to the outside portion of foods, it makes sense to place thicker portions of meat, poultry and fish to the outer edge of the baking dish. This way, thicker portions will receive the most microwave energy and the foods will cook evenly.

Shielding: Strips of aluminium foil, which block microwaves, are sometimes placed over the corners or edges of square and rectangular foods to prevent those portions from overcooking. Never use too much foil and make sure the foil is tightly secured to the dish or it may cause 'arcing' in the oven.

Elevating: Thick or dense foods are often elevated so that microwaves can be absorbed by the underside and centre of the foods.

Piercing: Foods enclosed in a shell, skin or membrane are likely to burst in the oven unless they are pierced prior to cooking. Such foods include both yolks and whites of eggs, clams and oysters and many whole vegetables and fruits.

Testing if cooked: Because foods cook so quickly in a microwave oven, it is necessary to test food frequently. Some foods are left in the microwave until completely cooked, but most foods, including meats and poultry, are removed from the oven while still slightly undercooked and allowed to finish cooking during standing time. The internal temperature of foods will rise between 5 °F(3 °C) and 15 °F (8 °C) during standing time.

Standing time: Foods are often allowed to stand for 3 to 10 minutes after being removed from the microwave oven. Usually the foods are covered during standing time to retain heat unless they are supposed to be dry in texture (some cakes and biscuits, for example). Standing allows foods to finish cooking and also helps flavour blend and develop.

Microwave-Safe Utensils

Never use metal or metal trimmed utensils in your microwave oven. Microwaves cannot penetrate metal. They will bounce off any metal object in the oven and cause arcing, an alarming phenomenon that resembles lightning.

Most heat resistant non metallic cooking utensils are safe for use in your microwave oven. However, some may contain materials that render them unsuitable as microwave cookware. If you have any doubts about a particular utensil, there's a simple way to find out if it can be used in your microwave oven.

Testing utensils for microwave use: Place the utensil in question next to a glass bowl filled with water in the microwave oven.

Microwave at power HIGH for 1 minute. If the water heats up but the utensil remains cool to the touch, the utensil is microwave-safe. However, if the water does not change temperature but the utensil becomes warm, microwaves are being absorbed by the utensil and it is not safe for use in the microwave oven. You probably have many items on hand in your kitchen right now that can be used as cooking equipment in your microwave oven. Just read through the following checklist.

1. Dinner plates: Many kinds of dinner-ware are microwave-safe. If in doubt consult the manufacturer's literature or perform the microwave test.

2. Glassware: Glassware that is heat-resistant is microwave-safe. This would include all brands of oven tempered glass cookware. However, do not use delicate glassware, such as tumblers or wine glasses, as these might shatter as the food warms.

3. Paper: Paper plates and containers are convenient and safe to use in your microwave oven, provided that the cooking time is short and foods to be cooked are low in fat and moisture. Paper towels are also very useful for wrapping foods and for lining baking trays in which greasy foods such as bacon are cooked. In general, avoid coloured paper products as the colour may run.

4. Plastic storage containers: These can be used to hold foods that are to be quickly reheated. However, they should not be used to hold foods that will need considerable time in the oven as hot foods will eventually warp or melt plastic containers.

5. Plastic cooking bags: These are microwave-safe, provided they are specially made for cooking. However, be sure to make a slit in the bag so that steam can escape. Never use ordinary plastic bags for cooking in your microwave oven, as they will melt and rupture.

6. Plastic microwave cookware: A variety of shapes and sizes of microwave cookware is available. For the most part, you can probably microwave items you already have on hand rather than investing in new kitchen equipment.

7. Pottery, stoneware and ceramic: Containers made of these materials are usually fine for use in your microwave oven, but they should be tested to be sure.

CAUTION: HIGH IRON CONTENT, HIGH LEAD CONTENT, SOME ITEMS NOT FOR COOKING.

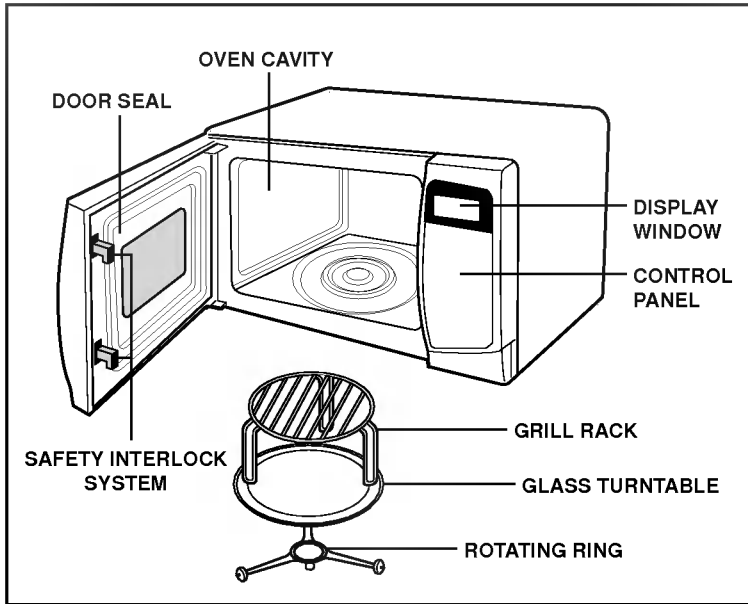

Your oven will be packed with the following materials:

- Grill Rack 1 each
- Glass Turntable 1 each
- Owner's Manual 1 each
- Rotating Ring 1 each

This microwave oven is designed for household use only. It is not recommended for commercial purposes.

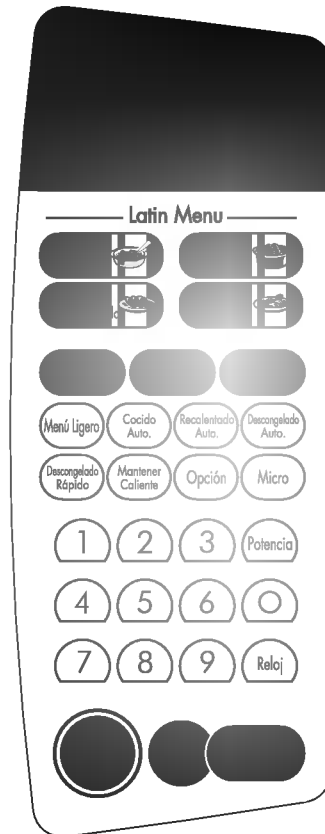





NOTE: A beep sounds when a pad on the control panel is touched, to indicate a setting has been entered.

SETTING CLOCK

You can set either 12 hour clock or 24 hour clock. If the clock (or display) shows any strange looking symbols, unplug your oven from the electrical socket and plug it back in and reset the clock.

Example: To set 11:11 by using the 12 clock.

1. Touch **Parar/Borrar**.

2. Touch **Reloj** twice. **12H** will show in the display.

3. Touch **Inicio**. **12:00** will show in the display.

4. Enter the time by touching. **[1], [1], [1], and [1]**. **11:11** will show in the display.

5. Touch **Inicio**. The clock starts counting.



NOTE:

If you want to set clock by using the 24 clock, Touch Reloj once, then 24H will show in the display.

+ 30 MÁS

A time-saving pad, this simplified control lets you quickly set and start microwave cooking without the need to touch Inicio.

Example: To set cooking time for 2 minutes by using +30 Más

1. Touch **Parar/Borrar**.

2. Touch **+30 Más** 4 times. The oven begins cooking and display shows time counting down.







NOTE:

If you touch +30 Más, it will add 30 seconds, up to 10 minutes.

TIMED COOKING

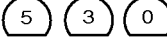
This function allows you to cook for a desired time. And in order to give you the best results, there are 10 power level settings in addition to HI-POWER because many food need slower cooking (at less than HI-POWER).

Example : To cook food on 80% Power (Power8) for 5 minutes 30 seconds

1. Touch **Parar/Borrar**.

2. Touch **Micro**. **INDIQUE EL TIEMPO DE COCCION** will show in the display.

3. Enter 5 minutes 30 seconds by touching **[5], [3], and [0]**. **5:30** will show in the display.

4. Touch **Potencia**.

5. Touch **8**. To select power level 80%. **P-80** will show in the display.

6. Touch **Inicio**.

NOTE:

If you do not select power level, the oven will operate at power HIGH. To set HI-POWER cooking, skip steps 4 & 5 above.

2 STAGE TIMED COOKING

For Two Stage cooking, repeat timed cooking steps 2 through 5 on the previous page before touching the +30 Más pad for additional Time and Power program you want to add.

Auto Weight Defrost can be programmed before the first stage to defrost first and then cook.

MICROWAVE POWER LEVELS

Your microwave oven is equipped with tenth power levels to give you maximum flexibility and control over cooking. The table below will give you some idea of which foods are prepared at each of the various power levels.

- The chart below shows the power level settings for your oven.

MICROWAVE POWER LEVEL CHART

Power Level	Use
(High)	<ul style="list-style-type: none"> • Boiling water. • Browning ground beef. • Making candy. • Cooking poultry pieces, fish, & vegetables. • Cooking tender cuts of meat.
9	<ul style="list-style-type: none"> • Reheating rice, pasta, & vegetables.
8	<ul style="list-style-type: none"> • Reheating prepared foods quickly. • Reheating sandwiches.
7	<ul style="list-style-type: none"> • Cooking egg, milk and cheese dishes. • Cooking cakes, breads. • Melting chocolate.
6	<ul style="list-style-type: none"> • Cooking veal. • Cooking whole fish. • Cooking puddings and custard.
5	<ul style="list-style-type: none"> • Cooking ham, whole poultry, lamb. • Cooking rib roast, sirloin tip.
4	<ul style="list-style-type: none"> • Thawing meat, poultry and seafood.
3	<ul style="list-style-type: none"> • Cooking less tender cuts of meat. • Cooking pork chops, roast.
2	<ul style="list-style-type: none"> • Taking chill out of fruit. • Softening butter.
1	<ul style="list-style-type: none"> • Keeping casseroles and main dishes warm. • Softening butter and cream cheese.

CHILD LOCK

This is a unique safety feature that prevents unwanted oven operation such as used by children. Once the child lock is set, no cooking can take place.

Example : To set the child lock



Touch and hold **Parar/Borrar** until **BLOQUEADO** appears in the display and a single beep is heard.

When CHILD LOCK was already set, if you touch other cooking pad, the window shows **BLOQUEADO** in the display. Then you can cancel the child lock according to below procedure.

Example : To cancel the child lock



Touch and hold **Parar/Borrar** until **DESBLOQUEADO** disappears in the display.

LATIN MENU

Latin menu made easy! Your oven's menu has been preprogrammed to cook food automatically. Tell the oven what you want. Then let your microwave oven cook your selections.

Example: To cook 2 tazas of Frijoles simply follow the step below



1. Touch **Parar/Borrar**.



2. Touch **Frijoles**. **PRESIONE TECLAS 1-3** will show in the display.



3. Touch **[3]**. **2 TAZAS** will show in the display.



4. Touch **Inicio**.

LATIN MENU CHART

Menu	Quantity	Ingredients	Instructions
Carne guisada	4 porciones	1/2 kilo de carne suave sazonada 1 taza de papas cortadas en cuadros 2 cdas de aceite 1/2 taza de habichuelas 1/2 taza de zanahorias 1/2 taza de maiz 2 cdas de cebolla en cuadros 1 cda de sal 1/2 cdita de pimienta 1 taza de salsa de tomate preparada o sofrito	Mezcle todos los ingredientes en un envase profundo y tapelo. Cuando suene el timbre, revuelva la comida. Cuando termine de cocinar, espere 5 minutos de tiempo de reposo, luego sirva.
Sopa de pollo	4 porciones	1 libra de pechuga de pollo sazonada, cortada en piezas 1/2 cdita de oregano 2 cdas de cebolla en rebanadas 3 cdas de culantro 1 taza de papas en cuadros 1/2 taza de zanahorias en cuadros 2 sobre de caldo de pollo con achiote 1/2 cdita de pimienta 7 tazas de agua 1 cda de sal	Mezcle todos los ingredientes en un envase profundo y tapelo. Cuando suene el timbre, revuelva la comida. Cuando termine de cocinar, espere 5 minutos de tiempo de reposo, luego sirva.
Frijoles	1 a 2 tazas	1 a 2 tazas 1 taza 1 taza (té) de porotos 6 tazas (té) de agua (hirviendo) 1 1/2 taza 1 1/2 taza (té) de porotos 7 tazas (té) de agua (hirviendo) 2 tazas 2 tazas (té) de porotos 8 tazas (té) de agua (hirviendo)	En un recipiente hondo, coloque el agua y los porotos, mezcle. No es necesario cubrir. En la pausa, mezclar. Al final de la preparación retire y mezcle. Para la salsa: agregue la salsa y llevar al horno 10 minutos en potencia 100%. Salsa: <ul style="list-style-type: none"> • 1 cuchara (sopa) de aceite de oliva • 1 cuchara (sopa) de perejil picado • 2 cuchara (sopa) de cebolla picada • 2 dientes de ajo picados • Sal a gusto
Platanos	Platanos en aimbar -2 porciones Platanos asados - 2 porciones	2 platanos maduros cortados en rebanadas 1/2 barra de mantequilla 1/2 taza de azucar morena 1 cdita de vainillacanela al gusto 1/2 taza de agua 2 platanos maduros	Ponga todos los ingredientes juntos en un pyrex sin tapa. Cuando suene el timbre, revuelva. Cuando se haya cocido el alimento espere 2 minutos de tiempo de reposo, antes de servir. Retire la cascara de los platanos y cortelos a la mitad, luego metalos en una bolsa plastica, y amarrela. Con un tenedor hagale de tres a cuatro hoyos a la bolsa plastica. Luego proceda a cocinar. Luego de cocidos espere 2 minutos de tiempo de reposo y luego sirva.

AUTO COOK

Your oven's menu has been preprogrammed to automatically cook food. Tell the oven what you want and how many items there are. Then let your microwave cook your selections.

Be sure to close the door before selecting categories.

Example: To cook 500g of fresh vegetable, simply follow the step below.

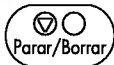

1. Touch **Parar/Borrar**.



2. Touch **Cocido Auto** two times. **VERDURA FRESCA** will show in the display.



3. Touch **Inicio**. **PRESIONE TECLAS 1-3** will show in the display.



4. Touch **3**. **500 G** will show in the display.



5. Touch **Inicio**. If you don't press Liga key for 8 seconds it will start cooking automatically.

NOTE:

If you don't touch Parar/Borrar pad when the cooking is over, the oven provides you with the tone message that finished the cooking at intervals of long time.

AUTO COOK CHART

MENU	QUANTITY	TEMPERATURE	PROCEDURE	INSTRUCTION
Fresh Veggies	200g a 500g 200g e 300g 3 cucharadas (soperas) de agua 500g 4 cucharadas (soperas) de agua	Ambiente y Refrigerado	En un recipiente redondo, coloque las legumbres o verduras. Tape y lleve al horno. En la pausa, mezclar y revolver. Al final de la preparación dejar en reposo 5 minutos, cubierto.	<ul style="list-style-type: none"> Las legumbres y verduras preparados en el horno microondas mantiene mayor cantidad de vitaminas y sales minerales, porque al cocinar no es eliminada. El sabor y el color realzados. Agregue después los condimentos.
Frozen Veggies	200g a 500g	Congelado (18° C)	En un recipiente redondo, coloque las legumbres o verduras. Tape y lleve al horno. En la pausa, mezclar y revolver. Al final de la preparación dejar en reposo 5 minutos, cubierto.	<ul style="list-style-type: none"> No es necesario agregar agua.
Baked Potato	1 a 4 unidades (cerca de 250g c/u)	Mediano	Lave y pele la cáscara de las papas. Seque y perforo al tamaño de un dedo. Cubra el plato giratorio con papel absorbente y coloque las papas en el borde del plato giratorio. Lleve al horno microondas, al final dejelo reposar 5 minutos envuelto en papel de aluminio.	<ul style="list-style-type: none"> Si el peso de la papa fuera mayor o menor que lo indicado influenciará directamente en el resultado

AUTO COOK CHART





MENU	QUANTITY	TEMPERATURE	PROCEDURE	INSTRUCTION
Cake	1 receta (cerca de 500g)	Mediano	<p>Ingredientes:</p> <ul style="list-style-type: none"> • 3 huevos • 1 1/2 taza (té) de azúcar (270g) • 1 1/2 taza (té) de harina de trigo (180g) • 3 cucharadas (sopa) de margarina (60g) • 1 taza (té) de leche o jugo de frutas • 1 cuchara (sopa) de levadura de cerveza <p>Modo de Preparación:</p> <p>Bata las claras a nieve, separar de bater agregar las gemas, a la margarina y alterne los ingredientes secos con la leche. Por último, agregue la levadura de cerveza. Deje reposar la masa en un lugar con calor. Lleve al horno microondas. Al final de preparación dejar reposar 5 minutos.</p>	<ul style="list-style-type: none"> • Desenforme o bolo ainda morno para que no grude na fôrma. • Siempre que adapte una receta del horno convencional para microondas aumente la cantidad de grasa • La leche puede ser sustituido por yogurt natural o jugo de frutas. • Varie el sabor agregando uno de estos ingredientes: <ul style="list-style-type: none"> * 1 taza (té) de damascos picados * 1 taza (té) de almendras o nueces picadas * 1 taza (té) de chocolate en polvo
Puding	1 receta	Mediano	<p>Ingredientes:</p> <p>Caramelo:</p> <ul style="list-style-type: none"> • 6 cucharadas (sopa) de azúcar • 6 cucharadas (sopa) de agua <p>Budín:</p> <ul style="list-style-type: none"> • 4 huevos • 1 lata de leche condensada • 1 lata de leche común • 1/2 pote de crema de leche • 1 cucharada (té) de esencia de vainilla <p>Modo de Preparación:</p> <p>Caramelo: Mezcle el azúcar y el agua numa fôrma de anel. Lleve al horno microondas. por 6 a 9 minutos en potencia alta, mezclando en la mitad de tiempo. Expande el caramelo por el interior del recipiente.</p> <p>Budín: Bata todos los ingredientes con los líquidos cubra y lleve al horno microondas. Al finalizar dejar enfriar.</p>	<ul style="list-style-type: none"> • Retire al caramelo ainda em tom claro, pero debido a la alta temperatura após ser retirado do o mesmo termina o preparo. • Utilice o auxílio de luvas térmicas, pois a calda de caramelo atinge uma temperatura de aproximadamente 180°C. • Desenformar somente gelado. • Varie el sabor agregando uno de estos ingredientes: <ul style="list-style-type: none"> * 1 lata de jugo de naranja * 1 vidro de leite de coco e 50g de coco seco rallado * 5 cucharadas (sopa) de cappuccino * 4 cucharadas (sopa) de chocolate en polvo.
Jam	400g ou 600g 400g • 450g de goiaba • 150g de açúcar 600g • 650g de masa ou mamão papaya • 150g de açúcar	Ambiente e Refrigerado	<p>Ingredientes:</p> <ul style="list-style-type: none"> • 450g de goiaba • 150g de açúcar <p>Modo de Preparación:</p> <p>En un recipiente hondo, mezcle ahora con el azúcar. No es necesario cubrir. Lleve al horno microondas, una pausa bata la mezcla y lleve al horno. Si prefiere puede dejar algunos pedazos de frutas sin bater. Al finalizar la preparación, retire, deje enfriar y sirva.</p> <p>* Al terminar la preparación a geleia possui aspecto líquido, después enfriar para obtener el punto deseado.</p>	<p>Para 400g</p> <ul style="list-style-type: none"> • Variedad o sabor sustituido por la mismas cantidades de las siguientes frutas: <ul style="list-style-type: none"> * Frutilla, Manzana y Ananá * Mamão aumente la cantidad para 500g y disminuya el azúcar para 100g. <p>Para 600g</p> <ul style="list-style-type: none"> • Variedad o sabor sustituido por las siguientes frutas: <ul style="list-style-type: none"> * Ananá disminuya la cantidad para 600g y aumente el azúcar para 200g * Goiaba aumente la cantidad para 750g y mantenga la cantidad de azúcar.
Chocolate	1 receta (40 docinhos)	mediano	<p>Ingredientes:</p> <ul style="list-style-type: none"> • 1 lata de leche condensada • 2 cucharada (sopa) de chocolate en polvo • 1 cuchara (sobremesa) de margarina • chocolate granulado para envolver los docinhos <p>Modo de Preparación:</p> <p>En un recipiente hondo, mezcle todos los ingredientes con excepción de chocolate granulado. En la pausa mezcle y regreselo al horno. No final de la preparación, retire, mezcle y aguarde hasta enfriar. Haga moldecitos y envuelva con el chocolate granulado y coloque en moldes de papel</p>	<ul style="list-style-type: none"> • Al terminar la preparación o brigadeiro posee una textura aireada, mezcle bien hasta de obtener una masa bien lisa. • Utilice siempre un recipiente hondo para que no desborde.
Peanuts	1taza (175g) o 2 tazas (350g)	Mediano	<p>En un recipiente redondo, coloque el maní y lleve al horno microondas. En la pausa, mezcle y vuelva al horno para terminar la preparación. Aguarde a que enfrie y utilice.</p>	<ul style="list-style-type: none"> • Agregue al maní todavía tibio 1 cuchara (sopa) de margarina y sal a gusto.
Popcorn	1 receta	Ambients	<p>Siga las instrucciones del envase del fabricante.</p>	<ul style="list-style-type: none"> • No intente volver a reventar las semillas que no reventaron.

LIGHT MENU

Your oven's menu has been preprogrammed to automatically cook food. Tell the oven what you want and how many items there are. Then let your microwave cook your selections.

Be sure to close the door before selecting categories.

Example: To cook 500g of Pescado, simply follow the step below.





	1. Touch Parar/Borrar .
	2. Touch Menú Ligero three times. PESCADO will show in the display.
	3. Touch Inicio . PRESIONE TECLAS 1-2 will show in the display.
	4. Touch 2 . 500G will show in the display.
	5. Touch Inicio .

AUTO REHEAT

Your oven's menu has been preprogrammed to automatically reheat food. Tell the oven what you want and how many items there are. Then let your microwave oven reheat your selections.

Be sure to close the door before selecting categories.

Example: To reheat two pieces of pizza, simply follow the step below.

	1. Touch Parar/Borrar .
	2. Touch Recalentado Auto three times. PIZZA will show in the display.
	3. Touch Inicio . PRESIONE TECLAS 1-3 will show in the display.
	4. Touch 2 . 2 UN will show in the display.
	5. Touch Inicio .

NOTE:

If you don't touch Parar/Borrar pad when the cooking is over, the oven provides you with the tone message that finished the cooking at intervals of long time.

LIGHT MENU CHART

MENU	QUANTITY	TEMPERATURE	PROCEDURE	INSTRUCTION
Cutlets	300g o 500g	Refrigerado	<p>Ingredientes:</p> <ul style="list-style-type: none"> • 5 cucharadas (soperas) de pan rayado • 50g de queso parmesano rayado • 2 cucharadas (soperas) de aceite de oliva • 1 cucharada (sopera) de orégano • 1 cucharada (sopera) de margarina light <p>Modo de Preparo: Coloque el pan rallado en un recipiente y llévelo al horno microondas para dorar por 4 a 6 minutos en potencia alta. Mezcle a cada minuto para que no se queme. Retire y deje enfriar. Mezcle el pan rallado con el queso rallado y reserve. Pincele los filetes condimentados a gusto con aceite y pase la mezcla de pan. Coloque los filetes en un recipiente y distribuya la margarina sobre los mismos. Llévelo al horno microondas, en el final de la preparación, retire y sirva.</p>	<ul style="list-style-type: none"> • Para poder agregar pan rallado con la salsa deshidratada, tomillo, estragón o páprika. • Para 500g aumente las cantidades: • 7 cucharadas (soperas) de pan rallado • 70g de queso parmesano rallado • 3 cucharadas (soperas) de aceite de maíz • Utilice esta opción solamente para el de filete de milanesa.
Fruits	200g o 400g	Ambiente y Refrigerado	<p>En un recipiente redondo, coloque la fruta y llévelo al horno microondas. Cubierto. En la pausa, revuelva y llévelo al horno para terminar la preparación. En el final de la preparación deje reposar 5 minutos cubierto.</p>	<ul style="list-style-type: none"> • Ideal para la preparación de manzanas, ananás y bananas • Sirva las frutas acompañadas de canela.
Fish	250g o 500g	Refrigerado	<p>Ingredientes:</p> <ul style="list-style-type: none"> • 500g de filete de pescados • 2 tallos de salsa picados • 2 zanahorias cortadas en cubitos • 2 cucharadas (soperas) de alcaparras • 3 cucharadas (soperas) de salsa de soja para pincelar <p>Modo de Preparación: Condimente los filetes a gusto, distribúyalos en un recipiente, pincéelos con la salsa de soja y agréguelos, los demás ingredientes, encima. Llévelos al horno microondas. Al finalizar la preparación, aguarde 5 minutos antes de retirarlos.</p>	<ul style="list-style-type: none"> • Para preparar 250g reduzca todos los ingredientes por mitades. • Varie la receta sustituyendo la zanahoria por: • 1 tomate en rodajas, 1/2 cebolla picada y 2 cucharadas (soperas) de cheiro verde picado • 50g de champignons fileteados, 1 cucharada (sopera) de hierbas aromáticas y 1/4 de taza de té de vino blanco seco. • 100g de camarones frescos, 2 cucharadas (soperas) de salsa lista e 2 o 3 ramos de manjeriço. • La salsa de soja podrá ser sustituida por mostaza • El pescado puede ser sustituido por cazón abadejo, salmón o atún.

AUTO REHEAT CHART

MENU	QUANTITY	TEMPERATURE	PROCEDURE	INSTRUCTION
Beverage	1 taza (té) 250ml o 2 tazas (té) 500ml Indicado para calentar café, té y leche.	Ambiente o Refrigerado	Coloque en una jarra o taza indicado para uso en microondas Revuelva los líquidos y colóquelos al borde del plato giratorio. Llévelo al horno microondas En el final de la preparación déjelo reposar 3 a 5 minutos y sirva enseguida.	<ul style="list-style-type: none"> • Pruebe si la temperatura es adecuada antes de ingerir. • Evite que el vapor formado, entre en contacto con sus manos y rostro.
Bread	1 a 3 unidades	Congelado (-18°C)	Coloque los panes sobre el plato giratorio forrado con papel o toalla. Llévelos al microondas. Al finalizar, déjelos reposar 3 minutos antes de retirar.	<ul style="list-style-type: none"> • Al hacer pan utilice siempre papel-absorbente.
Pizza	1 a 3 porciones	Ambiente o Refrigerado	En un recipiente para microondas, distribuya las porciones de pizza. Llévelo al microondas. Al finalizar, retire y sirva enseguida.	<ul style="list-style-type: none"> • Las pizzas de queso alcanzan temperaturas más altas.
Frozen pie	2 a 6 unidades	Congelado (-18°C)	En un recipiente para microondas forrado con papel absorbente, distribuya los calentitos. Llévelo al horno microondas. Al final de la cocción, retire y sirva enseguida.	<ul style="list-style-type: none"> • Utilice para agregar: esfihas, coxinhas, empadas, risoles e croquetes.
Quick Defrost	250g o 500g	Congelado (-18°C)	Lleve el plato a microondas y siga las orientaciones del fabricante des-criptas en el embalaje. En el final de la preparación déjelo reposar 5 minutos y sirva.	<ul style="list-style-type: none"> • Mezcle y pruebe si la temperatura es la adecuada antes de ingerir.

AUTO WEIGHT DEFROST

The Auto Defrost by Weight feature is an accurate defrosting method for frozen meat, poultry and fish up to kg. The oven will beep during the DEFROST cycle. At this time, open the door, and turn over, separate, or rearrange the food. Remove any portions that have thawed. Return frozen portions to the oven and touch Liga to resume the defrost cycle. The oven will not STOP during the "BEEP" unless the door is opened.

Example : To defrost 1.2 kg of beef, select Meat menu, enter the weight, and press Liga.



1. Touch **Parar/Borrar**.



2. Touch **Descongelado Auto** three times. **BIFE** will show in the display.



3. Enter the weight by touching **[1]** and **[2]**. **1200G** will show in the display.



4. Touch **Inicio**.

NOTE:

- The benefit of this Auto Defrost feature is automatic setting and control of defrosting, but just like conventional defrosting you must check the foods during the defrosting time.
- For best results, remove fish, shellfish, meat and poultry from its original paper or plastic closed package (wrapper). Otherwise, the wrap will hold steam and juice closed to the foods which can cause the outer surface of the foods to cook.
- Place foods in shallow glass baking dish or microwave roasting rack to catch drippings
- Food should still be somewhat icy in the center when removed from the oven.
- When it is difficult to remove the wrap from the food, defrost the wrapped food for about a quarter of the total defrost time, which is displayed at the beginning of the defrost cycle. Then remove the food from oven, and remove the wrap from food.

QUICK DEFROST

The QUICK DEFROST feature provides you with the quick defrosting method for 0.5 kg of carnes. The oven automatically sets the defrosting time for the food. (Carnes 0.5 kg only)

Example : To defrost 500 g of Carnes.



1. Touch **Parar/Borrar**.



2. Touch **Descongelado Rápido**.

AUTO DEFROST CHART

MENU	QUANTITY	TEMPERATURE	PROCEDURE	INSTRUCTION
Meat	0,5 a 2,0k	Congelado (- 18°C)	Coloque la carne en un recipiente bajo en el horno microondas. Haga una pausa y gire el alimento para terminar de descongelar. Al término espere 30 minutos envolviendo la carne en papel de aluminio	<ul style="list-style-type: none"> • Lo indicado es para carnes crudas enteras, bifes en trozos • Si hay partes ya descongeladas protéjalas con tiras de papel aluminio especial para microondas.
Poultry	0,5 a 2,3k	Congelado (- 18°C)	Coloque el pollo en un recipiente bajo en el horno microondas. Haga una pausa y gire el alimento para terminar de descongelar. Al término espere 30 minutos envolviendo la carne en papel de aluminio	<ul style="list-style-type: none"> • Lo indicado es para pollos enteros y en trozos • Si hay partes ya descongeladas protéjalas con tiras de papel aluminio especial para microondas.
Fish	0,5 a 2,0k	Congelado (- 18°C)	Coloque el pescado en un recipiente bajo en el horno microondas. Haga una pausa y gire el alimento para terminar de descongelar. Al término espere 20 minutos envolviendo la carne en papel de aluminio	<ul style="list-style-type: none"> • Lo indicado es para pescados enteros, filetes y en trozos • Si hay partes ya descongeladas protéjalas con tiras de papel aluminio especial para microondas.

AUTO GRILL

Auto grill allows you to prepare most of your favorite food by selecting the food type, and entering the weight of food by the number key.

Example : To cook 500 g of chicken portion



1. Touch **Parar/Borrar**.



2. Touch **Parrilla Auto** five times. **PEDAZOS DE POLLO** will show in the display.



3. Touch **Inicio**. **PRESIONE TECLAS 1-3** will show in the display.



4. Touch [1]. **500 G** will show in the display.



5. Touch **Inicio**.

NOTE:

If you don't press Liga key for 8 seconds. It will start cooking automatically.

AUTO GRILL CHART

MENU	QUANTITY	TEMPERATURE	PROCEDURE	INSTRUCTION
Whole chicken	1,5kg a 2,2kg	Refrigerado	Condimente el pollo a gusto. Déjelo en la heladera para que tome gusto por 2 horas. En un recipiente redondo, coloque el pollo con el pecho para arriba y pincele por encima con 1 cucharada (sopera) de margarina derretida. No es necesario cubrir. Llévelo al horno microondas. En la pausa, gire y retire el líquido acumulado en el recipiente y llévelo al horno. En la segunda pausa, gire y retire el líquido acumulado nuevamente. Al finalizar la preparación déjelo reposar 5 minutos.	<ul style="list-style-type: none"> • Es imprescindible estar retirando el líquido acumulado en el recipiente durante la cocción para mantenerlo crocante. • Si prefiere un dorado más intenso, en las pausas pincele con margarina derretida nuevamente. • No es necesario el uso de la parrilla en ésta opción.
Meat	0,5kg a 1,5kg	Refrigerado	Condimente la carne a gusto. Déjela en la heladera para que tome gusto por 2 hs. En un recipiente redondo, coloque la carne y pincele con 1 cucharada (sopera) de margarina derretida. No es necesario cubrir. Llévela al horno microondas. En la pausa, gire y retire el líquido acumulado y llévela otra vez al horno. En la segunda pausa, gire y retire el líquido acumulado nuevamente. de aluminio.	<ul style="list-style-type: none"> • Es imprescindible estar retirando el líquido acumulado en el recipiente durante la cocción para mantenerlo crocante. • Si prefiere un dorado más intenso, en las pausas pincele con margarina derretida nuevamente. • No se olvide de colocar el recipiente sobre la parrilla.
Sausage	300g a 700g	Refrigerado	Coloque la parrilla sobre un plato redondo, para recoger el líquido que se formará durante la cocción. Distribuya las salchichas directamente sobre la parrilla y pincharlas. En la pausa, darlas vuelta y regréselo al horno para terminar la preparación. En el final de la preparación retire con la ayuda de un guante térmico y sirva enseguida.	<ul style="list-style-type: none"> • El dorado varía en función del tipo de salchicha utilizada, si fuera del tipo curada el dorado es más acentuado, si fuese tipo fresca, el dorado será menos acentuado.
Kebab	700g a 1kg	Refrigerado	Condimente la carne a gusto. Intercale con el palito para brochette carne, panceta, cebolla y pimienta. Coloque la parrilla sobre un plato redondo, para recoger el líquido que se formará durante la cocción. Distribuya las brochettes sobre la parrilla y lleve al horno microondas. En la pausa, delo vuelta y regréselo al horno para terminar la cocción. En el final de la preparación retire con la ayuda de un guante térmico y sirva enseguida.	<ul style="list-style-type: none"> • Puede variar sustituyendo la carne por salchichas o además intercalar carne con salchichas. • Sustituya la carne por cubos de pollo pincelados con margarina derretida.
Chicken pieces	500g a 1kg	Refrigerado	Condimente el pollo a gusto. Déjelo en la heladera para que tome gusto por 2 hs. Coloque la parrilla sobre un plato redondo, para recoger el líquido que se formará durante la cocción. Distribuya las brochettes sobre la parrilla y lleve al horno microondas. En la pausa, delo vuelta y regréselo al horno para terminar la cocción. En el final de la preparación retire con la ayuda de un guante térmico y sirva enseguida.	<ul style="list-style-type: none"> • Si prefiere un dorado intenso, en las pausas pinte con margarina derretida nuevamente.

GRILL COOK

This model is fitted with a SHEATH GRILL, so preheating is not needed. This feature will allow you to brown and crisp food quickly. The grill rack must be used during grill cooking.

Example : To grill cook for 12 minutes and 30 seconds.

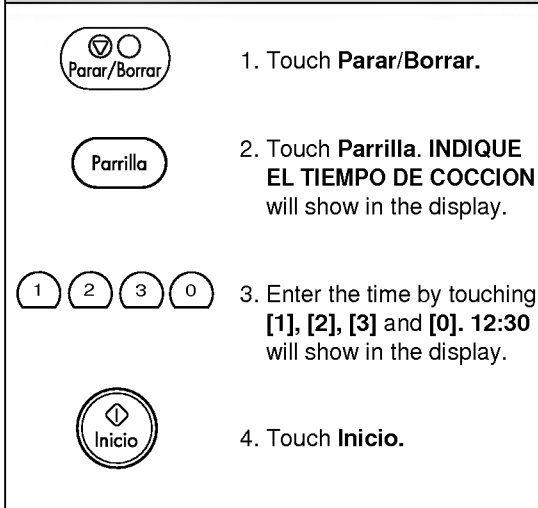

1. Touch **Parar/Borrar**.
2. Touch **Parrilla**. **INDIQUE EL TIEMPO DE COCCION** will show in the display.
3. Enter the time by touching **[1], [2], [3]** and **[0]**. **12:30** will show in the display.
4. Touch **Inicio**.

COMBINATION COOKING

This oven has a combination cooking mode which allows you to cook food with heater or microwave at the same time. Because heater cooking grills the surface of the meat while microwave cooking reaches inside, the total cooking time in the combination mode is generally shorter than the two stages separately. Moreover, preheating of the oven is not necessary.

Example : To combi cook with combination mode COMBI-3 for 25 minutes.

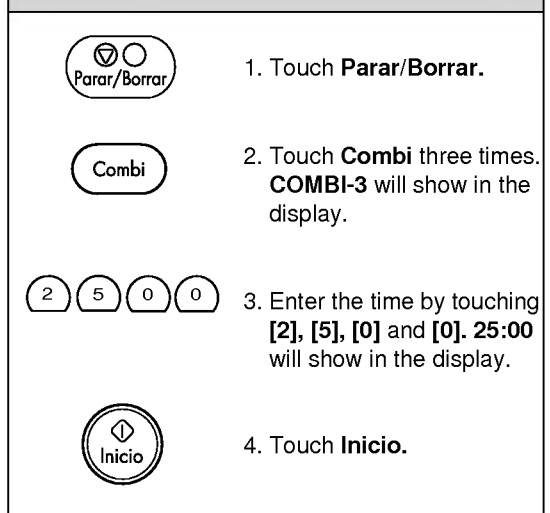

1. Touch **Parar/Borrar**.
2. Touch **Combi** three times. **COMBI-3** will show in the display.
3. Enter the time by touching **[2], [5], [0]** and **[0]**. **25:00** will show in the display.
4. Touch **Inicio**.

COMBINATION COOKING MODE

CATEGORY	MICRO POWER (%)	HEATER POWER (%)
COMBI-1	20	80
COMBI-2	40	60
COMBI-3	60	40

OPCIÓN

You can select on/off of beeper, scroll speed control and on/off of Demo.

Example: To turn off sound beeper.



1. Touch **Parar/Borrar**.



2. Touch **Opción**.
PRESIONE INICIO PARA DESACTIVAR SONIDO will show in the display.



3. Touch **Inicio**.

NOTE: To turn of beep back on, repeat step 1~3.

Example: To change speed scroll display



1. Touch **Parar/Borrar**.



2. Touch **Opción** twice.
VELOCIDAD DE SKROLL show in the display.



3. Touch **Inicio**.
1-RAPIDO
2-NORMAL
3-LENTO will show in the display.



4. Touch **1**.
RAPIDO will show in the display.



5. Touch **Inicio**.

NOTE: To change speed of scroll display back to another speed repeat step 1~5.

Example: To turn on DEMO.



1. Touch **Parar/Borrar**.



2. Touch **Opción** three times. **PRESIONE INICIO PARA ACTIVAR DEMO** will show in the display.



3. Touch **Inicio**.

HOLD WARM

HOLD WARM will continue for up to 99 minutes until the door has been opened or Desliga/Cancela has been touched.



1. Touch **Parar/Borrar**.



2. Touch **Mantener Caliente**.
MANTENER CALIENTE will show in the display.



3. Touch **Inicio**.
MANTENER CALIENTE will show in the display.

When the cooking cycle is over, the oven will switch into MANTENER CALIENTE to keep the food warm. Your oven has a "MANTENER CALIENTE" feature that keeps the food warm after cooking is complete.

GENERAL PROCEDURE FOR COOKING MEAT

"WARNING: Do not use aluminium foil during cooking cycle."

1. No special techniques are required. The roast should be prepared and seasoned (if desired) as for any other conventional method. Meat should be thoroughly defrosted before cooking.
2. Place the meat on a microwave roasting rack or ovenproof plate and place on the turntable.
3. Cook according to the cooking chart using the longer time for small joints and the shorter time for large joints. Use the longer time for thicker chops.
4. Turn the meat once halfway through the cooking time.
5. STAND for 5-10 minutes wrapped in foil after cooking. The standing time is very important as it 'finishes off' the cooking time.
6. Ensure meat, especially pork, is thoroughly cooked before eating.

MEAT COOKING CHART-MICROWAVE COOKING

Cut	Cooking Time per 454g (1 lb)	Microwave power
Beef		
Topside/Silverside-Rare	8 1/2-9 minutes	M-HIGH (80%)
-Medium	9-10 minutes	M-HIGH(80%)
-Well done	11-12 1/2 minutes	M-HIGH(80%)
Beefburgers	7-9 minutes	MEDIUM(60%)
Minced meat (to brown for casserole)	6-8 minutes	M-HIGH(80%)
Sausages 2	2-3 minutes	HIGH
4	4-5 minutes	HIGH
8	5-7 minutes	HIGH
Lamb		
Leg, fillet, shoulder.	13-16 minutes	M-HIGH(80%)
Pork		
Loin, leg	12-15 minutes	M-HIGH(80%)
Bacon	Approx. 1/2 minute per slice	HIGH

N.B. The above timings should be regarded as a guide only to allow for individual tastes and preferences. The timings may vary due to the shape, cut and composition of the meat.

GENERAL PROCEDURE FOR COOKING POULTRY

"WARNING: Do not use aluminium foil during cooking cycle."

1. No special techniques are required. The poultry should be prepared as for any other conventional method. Season if desired.
2. Poultry should be thoroughly defrosted, ensuring giblets and any metal clamps are removed.
3. Prick the skin and lightly brush with vegetable oil unless self basting.
4. All poultry should be placed on a microwave roasting rack or an ovenproof plate and placed on the turntable.
5. Cook according to the instructions, in the cooking chart turning the bird over halfway through the cooking time.
Poultry items, because of their shape have a tendency to cook unevenly, especially in very bony parts. Turning the bird during roasting helps to cook these areas evenly.
- N.B.** If whole birds are stuffed, the weight of the stuffed bird should be used when calculating the cooking time.
6. STAND for 5-10 minutes wrapped in foil after cooking before carving. The standing time is very important as it 'finishes off' the cooking time.

GENERAL PROCEDURE FOR COOKING POULTRY

7. Ensure poultry is thoroughly cooked before eating. Whole poultry is cooked when the juices run clear from the inside thigh when it is pierced with a sharp knife. Poultry portions should be pierced with a sharp knife through the thickest part to ensure that the juices are clear and the flesh is firm.

POULTRY COOKING CHART-MICROWAVE COOKING

Bird	Cooking Time per 454g (1 lb)	Microwave Power
CHICKEN Whole Breast (boned) Portions	9 1/2-12 minutes 8-10 minutes 9-11 minutes	M-HIGH(80%) M-HIGH(80%) M-HIGH(80%)
Turkey Whole	8 1/2-11 1/2 minutes	M-HIGH(80%)

N.B. The above timings should be regarded as a guide only to allow for individual tastes and preferences .

Timings may vary due to shape and composition of the food.

GENERAL PROCEDURE FOR COOKING FISH

"WARNING: Do not use aluminium foil during cooking cycle."

1. Arrange fish in a large shallow non metallic dish or casserole.
2. Cover with pierced microwave plastic film or casserole lid.
3. Place the dish on the turntable.
4. Cook according to the instructions in the cooking chart. Flakes of butter can be added to the fish if desired.
5. STAND as directed in the cooking chart before serving.
6. After standing time ensure the fish is thoroughly cooked. The fish should be opaque and flake easily.

FRESH FISH COOKING CHART

Fish	Cooking time per 454g (1 lb)	Microwave setting	Method	Standing time
Fish fillets	4-6 minutes	HIGH	Add 1-2x15 ml(1-2 tbsp) lemon juice	2-3 minutes
Cod/Haddock steaks	5-7 minutes	HIGH	Add 1-2x15 ml(1-2 tbsp) lemon juice	3-4 minutes
Lemon Sole fillets	2 1/2-4 minutes	HIGH	Add 1-2x15 ml(1-2 tbsp) lemon juice	2-3 minutes
Dover Sole	4-6 minutes	HIGH	Add 1-2x15 ml(1-2 tbsp) lemon juice	2-3 minutes
Whole Mackerel cleaned and prepared	4-6 minutes	HIGH	—	3-4 minutes
Whole Trout, cleaned and prepared	5-7 minutes	HIGH	—	3-4 minutes
Salmon steaks	5-6 minutes	HIGH	Add 1-2x15 ml(1-2 tbsp) lemon juice	3-4 minutes

Vegetable	Amount	Cook Time at HIGH	Instruptions	Standing time
Artichokes (8 oz. each)	2 medium 4 medium	6-8 11-13	Trim. Add 2 tsp. Water and 2 tsp. juice. Cover.	2-3 minutes
Asparagus, Fresh, spears	1lb.	7-9	Add 2 tbsp. water in 1-qt. covered casserole.	2-3 minutes
Beens, green & wax	1lb.	10-11	Add 2 tbsp. water in 1-qt. casserole. Stir halfway through cooking.	2-3 minutes
Beets, Fresh,	1lb.	17-20	Add 1/4 cup water in 1-qt. covered casserole. Rearrange halfway through cooking.	2-3 minutes
Broccoli, Fresh, spears	1lb.	6-8	Place broccoli in baking dish. Add 2 tbsp. water	2-3 minutes
Cabbage, Fresh, Chopped	1lb.	7-9	Add 1/4 cup water in 1-qt. covered casserole. Stir halfway through cooking.	2-3 minutes
Carrtos, Fresh, sliced	2 cups	6-8	Add 2 tbsp. water in 1 1/2 1-qt. covered casserole. Stir halfway through cooking.	2-3 minutes
Cauliflower, Fresh, whole	1lb.	7-9	Trim. Add 2 tbsp. water in 1-qt. covered casserole. Stir halfway through cooking.	2-3 minutes
Fresh, flowerets Celery, Fresh, sliced	2 cups 4 cups	5-6	Slice. Add 2 tbsp. water in 1-qt. covered casserole. Stir halfway through cooking.	2-3 minutes
Corn, Fresh	2 ears	9-12	Husk. Add 2 tbsp. water in 1-qt. baking dish. Cover.	2-3 minutes
Mushrooms, Fresh, sliced	1/2 lb.	4-5	Place mushrooms in 1-qt. covered casserole. Stir halfway through cooking.	2-3 minutes
Parsnips, Fresh, sliced	1lb.	6-8	Add 2 tbsp. water in 1-qt. covered casserole. Stir halfway through cooking.	2-3 minutes
Peas, Green, Fresh	4 cups	6-8	Add 2 tbsp. water in 1-qt. covered casserole. Stir halfway through cooking.	2-3 minutes
Potatoes, sweet, whole (6-8 oz. each)	2 medium 4 medium	6-8 8-10	Pierce potatoes several times with fork. Place on 2 paper towels. Turn over halfway through cooking.	2-3 minutes
Potatoes, white whole baking (6-8 oz. each)	2 potatoes 4 potatoes	5-8 8-11	Pierce potatoes several times with fork. Place on 2 paper towels. Trun over halfway through cooking.	2-3 minutes 2-3 minutes
Spinach, Fresh, leaf	1 lb.	6-8	Add 2 tbsp. water in 1-qt. covered casserole.	2-3 minutes
Squash, Acorn or buttemut. Fresh	1 medium	8-10	Cut squash in half. Remove seeds. Place in 8x8-inch bacing dish. Cover.	2-3 minutes
Zucchini Fresh, sliced	1 lb.	7-10	Add 2 tbsp. water in 1-qt. covered casserole. Stir halfway through cooking.	2-3 minutes
Zucchini Fresh,whole	1 lb.	8-9	Pierce. Place on 2 paper towels. Trun zucchini over and rearrange halfway through cooking.	2-3 minutes

General Guidelines

1. Trim excess fat from meat. Slash fat, making sure you do not cut into the lean. (This will stop the fat curling.)
2. Use only microwave and heat-safe cooking utensils.
3. Cover food with wax paper, plastic wrap or lids during microwave time.
4. After microwaving, remove the cover and drain the juice.
5. To get better and quick browning, arrange on the rack that comes with your oven.

Food	Quantity	Cooking time and microwave setting	Browning time	Method
Beef Hamburger patties, 4 oz. each, 1/2-inch thick	2 patties 4 patties	21/2-31/2min., HIGH 3-4 min., HIGH	5-7 minutes 7-9 minutes	Turn over halfway through microwaving. Drain after microwaving. Place directly on grill rack. Turn over halfway through browning.
Meat loaf	500-900g	18-23min., 80%	8-11 minutes	
Sirloin steak, 8 oz, 3/4 to 1-inch thick	1 to 2	31/2-41/2 min., 80%	13-15minutes	Turn over halfway through microwaving. Drain after microwaving and brush with melted butter before browning. Place directly on grill rack. Turn over halfway through browning.
Tenderloin steak, 8 oz, 1-inch thick	2, Rare 2, Med 2, Well	2-3 min., 80% 3-5 min., 80% 5-7 min., 80%	13-15 minutes 13-15 minutes 13-15 minutes	Same as above.
Lamb Lamb chops, 1-inch thick	450-700g	5-7 min., 80%	13-15 minutes	Same as above.
Veal Veal cutlets or loin chop 8oz, 1/2 to 3/4-inch thick	1 to 2	4-6 min., 80%	13-15 minutes	Same as above.
Pork Pork chops, 8 oz, 1/2 to 3/4-inch thick	1 to 2	41/2-61/2 min., 80%	13-15 minutes	Same as above.
Center cut ham slice, precooked	450-700g	41/2-61/2 min., 80%	12-14 minutes	Brush with honey or brown sugar glaze before microwaving. Turn over halfway through microwaving. Drain after microwaving and brush with honey or brown sugar glaze before browning. Place directly on grill rack to brown. Turn over halfway though browning.

Food	Quantity	Cooking time and microwave setting	Browning time	Method
Pork Sausage patties, fresh	2 to 4 pieces	3-5 min., HIGH	5-8 minutes	Add 2 tablespoons water to sausage and cover with plastic wrap.
Links, fresh	4 to 6 pieces	5-7 min., HIGH	5-8 minutes	Turn over halfway through microwaving. Drain. Place directly on grill rack to brown. Turn over halfway through browning.
Precooked Links	2 to 4 pieces 4 to 6 pieces 6 to 8 pieces	1-1 1/2 min., HIGH 1 1/2-3 min., HIGH 3-5 min., HIGH	5-8 minutes 5-8 minutes 5-8 minutes	Use glass dish and no cover. Turn over halfway through microwaving. Place directly on rack to brown. Turn over halfway through browning.
Poultry Chicken pieces	1/2 kg	5-6 1/2 min., HIGH	10-14 minutes	Arrange chicken, skin side up in 9-inch low plate. Cover with wax paper. Turn over halfway through microwaving. Drain after microwaving and brush with melted butter. Place directly on grill rack to brown. No cover. Turn over halfway through browning.
Whole chicken	1.3-2.0 kg	6-9 min., 80%	24-30 minutes	Arrange chicken breast down, cover with wax paper. Turn breast up halfway through microwaving. Drain and brush with melted butter before browning. Do not use rack. Turn over halfway through browning.
Fish Fish fillet, 1/2-inch thick	1/2 kg 1 kg	3-4 min., HIGH 5-7 min., HIGH	10-14 minutes 10-14 minutes	Arrange fish in low plate and cover with wax paper. Drain after microwaving and brush with melted butter. Place directly on grill rack to brown.
Fresh steaks, 1-inch thick	1 kg	3-5 min., HIGH	10-14 minutes	Arrange fish in low plate and cover with wax paper. Turn over halfway through microwaving. Drain after microwaving and brush with melted butter. Place directly on grill rack to brown. Turn over halfway through browning.
Whole fish	250-300g 675-900g	5-7 min., 80% 7-9 min., 80%	10-14 minutes 10-14 minutes	Same as above.

General Guidelines

1. The combination method allows you to take advantage of the speed and moisture retention on microwave cooking and crisping and browning effect of hot, dry all.
2. Use only microwave and heat-safe cooking utensils.
3. To get better and quick browning, arrange on the rack that comes with your oven.

Food	Quantity	Cooking Mode	Combination Cooking time	Method
Beef Hamburger patties, 4 oz. each, 1/2-inch thick Rump roast, rolled	2 patties 4 patties 0.5 to 1.3kg	Co-1 Co-3	14-18 minutes 19-23 minutes 25-30 minutes per Kg RARE(135 °F) 31-35 minutes per Kg MEDIUM(145 °F) 36-40 minutes per Kg WELL(155 °F)	Arrange patties on microwave and heat-safe plate. Place on grill rack. Drain and turn over halfway through cooking. Place roast fat side down on a heat-safe pie plate. Add desired seasonings and place on turntable. Shield if necessary. Drain and turn over halfway through cooking. When done, remove from oven and let stand covered with foil for 15 minutes. (Temperature may rise about 10°F)
Lamb Lamb roast, rolled, boneless	0.5 to 1.3kg	Co-3	25-30 minutes per Kg RARE(135 °F) 31-35 minutes per Kg MEDIUM(145 °F) 36-40 minutes per kg WELL(155 °F)	Place roast fat side down on a heat-safe pie plate. Brush lamb with marinade and desired seasonings such as rosemary, thyme or marjoram. Drain and turn over halfway through cooking. After cooking, remove from oven and let stand covered with foil for 15 minutes. (Temperature may rise about 10°F)
Pork Chops	2 chops (230g x 2) 4 chops (230g x 4)	Co-1 Co-1	22-28 minutes 32-40 minutes	Brush chops with desired seasonings and place directly on grill rack on turntable. Cook until no longer pink or until internal temperature reaches 170 °F. Turn over halfway through cooking. Remove from oven and let stand, covered for 5 minutes. (Temperature may rise about 10 °F)

Food	Quantity	Cooking Mode	Combination Cooking time	Method
Pork Loin roast, rolled, boneless	0.5 to 1.3kg	Co-3	40~45 minutes per Kg. (170°F)	Place roast fat side down on a heat-safe pie plate. Add desired seasonings and place on turntable. Shield if necessary. Drain and turn over halfway through cooking. When done remove from oven and let stand covered with foil for 15 minutes. (Temperature may rise about 10°F)
Chicken Breasts, boneless	half breast (200g) whole breast (300~400g)	Co-1	16~20 minutes 20~24 minutes	Wash and dry poultry. Remove skin and place breasts thickest portion to outside on grill rack. Place on grill rack on turntable. Brush with butter and seasonings if desired. Rearrange halfway through cooking. Cook until no longer pink and juices run clear. Remove from oven and let stand covered for 3 to 5 minutes.
Cut up fryer	1.0 to 1.3kg	Co-1	35~45 minutes	Wash and dry poultry. Arrange pieces on grill rack with thickest section to the outside. Brush with butter and seasonings if desired. Place on grill rack on turntable. Rearrange halfway through cooking. Cook until no longer pink and juices run clear. Remove from oven and let stand covered for 3 to 5 minutes.
Whole chicken	0.8 to 1.3kg	Co-3	50~60 minutes	Wash and dry poultry. Place breast down on microwave and heat-safe pie plate. Brush with butter and seasonings if desired. Do not use rack. Place on turntable. Drain and turn chicken over halfway through cooking. Cook until no longer pink and juices run clear. Remove from oven and let stand covered with foil for 10 minutes. (Temperature may rise about 10°F) Temperature in thigh should be about 185°F when done.
Cornish Hens Whole cornish hen. (500 to 700g)	whole	Co-3	40~50 minutes	Wash and dry poultry. Tie wings to body of hen and the legs to tail. Place hens breast side up on microwave and heat-safe pie plate. Brush with butter and seasonings if desired. Place on turntable. Turn over, discard drippings and shield bone ends of drumsticks with foil halfway through cooking if needed. Cook until no longer pink and juices run clear. Remove from oven and let stand covered with foil for 5 minutes. (Temperature may rise about 10°F) Temperature in breast should be about 185°F before serving.

Food	Quantity	Cooking Mode	Combination Cooking time	Method
Turkey Breasts, boneless	1.0 to 1.3kg	Co-1	30~40 minutes per Kg	Place turkey breast on grill rack. Brush with butter and seasonings if desired. Place on turntable. Drain and turn over halfway through cooking. Cook until no longer pink and juices run clear. Remove from oven and let stand covered with foil for 10 minutes. (Temperature may rise about 10°F) Temperature in breast should be about 185°F before serving.
Drumsticks	0.5 to 1.0kg	Co-1	35~40 minutes	Wash and dry poultry. Place pieces with thickest portion to outside on grill rack. Brush with butter and seasonings if desired. Place on turntable. Turn over halfway through cooking. Cook until no longer pink and juices run clear. Remove from oven and let stand covered with foil for 5 minutes.
Sausages (thick)	230g	Co-1	13~18 minutes	Place on grill rack. Turn over frequently through cooking.

For Best Results:

1. When determining the time for a particular food, begin by using minimum time and checking occasionally for doneness. It is easy to overcook food because microwaves cook very quickly.
2. Small quantities of food or foods with low water content may dry out and become hard if cooked too long.
3. Do not use the oven for drying kitchen towels or paper products. They may burn.
4. Break eggs before cooking them in the microwave.
5. For food items such as apples, potatoes, egg yolks, chicken livers, etc., be sure to pierce the skin or membrane to prevent bursting of the food while cooking in the oven.

Defrosting Frozen Foods:

1. Foods that have been frozen can be placed directly in the oven for thawing. (Be certain to remove any metallic ties or wraps.)
2. Defrost according to the Defrost Guide found in this Manual.
3. For areas of the food thawing faster than others, shield if necessary.
This helps slow down or stop the defrosting process.
4. Some foods should not be completely thawed before cooking. For example, fish cooks so quickly that it is sometimes better to begin cooking while still slightly frozen.
5. It may be necessary to increase or decrease the cooking time in some recipes, depending on the starting temperature of the foods.

NOTE:

Air from the vent may become warm during cooking. This is normal.

Browning:

There are a few foods which are not cooked long enough in the microwave oven to brown and may need additional colour.

Coatings such as SHAKE & BAKE®, paprika, and browning agents such kitchen bouquet® or Worcestershire sauce may be used on chops, meat patties or chicken parts.

Roasts, poultry or ham, cooked for 10-15 minutes or longer, will brown nicely without extra additives.

Cooking Utensils:

1. Most glass, ceramic glass and heat resistant glassware utensils are excellent.
2. Most paper napkins, towels, plates, cups, cartons, and cardboard are convenient utensils. Some recycled paper products may contain impurities which could cause arcing or fires when used in the microwave oven.
3. Some plastic dishes, cups, containers, and wraps may be used in the microwave oven. Follow the manufacturer's instructions or information given in the cooking guide when using plastics in the microwave oven.
4. Metal utensils and utensils with metallic trim should not be used in the microwave oven.

To Clean Your Oven:

1. Keep the inside of the oven clean.
Food spatters or spilled liquids stick to oven walls and between seal and door surface. It is best to wipe up spillovers with a damp cloth right away. Crumbs and spillovers will absorb microwave energy and lengthen cooking times. Use a damp cloth to wipe out crumbs that fall between the door and the frame. It is important to keep this area clean to assure a tight seal. Remove greasy spatters with a sudsy cloth then rinse and dry. Do not use harsh detergent or abrasive cleaners. The glass tray can be washed by hand or in the dishwasher.
2. Keep the outside of the oven clean.
Clean the outside of your oven with soap and water then with clean water and dry with a soft cloth or paper towel. To prevent damage to the operating parts inside the oven, the water should not be allowed to seep into the ventilation openings.
To clean control panel, open the door to prevent oven from accidentally starting, and wipe with a damp cloth followed immediately by a dry cloth. Press Deslige/Cancela after cleaning.
3. If steam accumulates inside or around the outside of the oven door, wipe the panels with a soft cloth. This may occur when the microwave oven is operated under high humidity conditions and in no way indicates a malfunction of the unit.
4. The door and door seals should be kept clean.
Use only warm, soapy water, rinse then dry thoroughly. **DO NOT USE ABRASIVE MATERIALS, SUCH AS CLEANING POWDERS OR STEEL AND PLASTIC PADS.**
Metal parts will be easier to maintain if wiped frequently with a damp cloth.

1. Do not attempt to tamper with, or make any adjustments or repairs to the door, control panel, safety interlock switches or any other part of the oven. Repairs should only be undertaken by a qualified service technician.
2. Do not operate the oven when empty. It is best to leave a glass of water in the oven when not in use. The water will safely absorb all microwave energy, if the oven is accidentally started.
3. Do not dry clothes in the microwave oven, which may become carbonized or burned if heated too long.
4. Do not cook food wrapped in paper towels, unless your cook book contains instructions, for the food you are cooking.
5. Do not use newspaper in place of paper towels for cooking.
6. Do not use wooden containers. They may heat-up and char.
Do not use metal containers or crockery containers which have metallic (e.g. gold or silver) inlays. Always remove metal twist ties.
Metal objects in the oven may arc, which can cause serious damage.
7. Do not operate the oven with a kitchen towel, a napkin or any other obstruction between the door and the front edges of the oven, which may cause microwave energy leakage.
8. Do not use recycled paper products since they may contain impurities which may cause sparks and/or fires when used in cooking.
9. Do not rinse the turntable by placing it in water just after cooking. This may cause breakage or damage.
10. Small amounts of food require shorter cooking or heating time. If normal times are allowed they may overheat and burn.
11. Be certain to place the oven so the front of the door is 8cm or more behind the edge of the surface on which it is placed, to avoid accidental tipping of the appliance.
12. Before cooking, pierce the skin of potatoes, apples or any such fruit or vegetable.
13. Do not cook eggs in their shell. Pressure will build up inside the egg which will burst.
14. Do not attempt deep fat frying in your oven.
15. Remove the plastic wrapping from food before cooking or defrosting. Note though that in some cases food should be covered with plastic film, for heating or cooking, as detailed in microwave cook books.
16. The oven must never be used if the door sealing is not in good working order.
17. When liquids are cooked in microwave units, they may be overheated above their boiling point without visible bubbling. When the container is removed, the shock may cause the sudden formation of steam bubbles. A fountain of hot liquid can spring up out of the container explosively.
18. If smoke is observed keep the oven door closed and switch off or disconnect the oven from the power supply.
19. When food is heated or cooked in disposable containers of plastic, paper or other combustible materials look at the oven frequently to check if the food container is deteriorating.

WARNING—Please ensure cooking times are correctly set as over cooking may result in FIRE and subsequent DAMAGE to the OVEN.

Q. What's wrong when the oven light will not glow?

A. There may be several reasons why the oven light will not glow.

- Light bulb has blown.
- Door is not closed.

Q. Does microwave energy pass through the viewing screen in the door?

A. No. The holes, or ports, are made to allow light to pass; they do not let microwave energy through.

Q. Why does the beep tone sound when a pad on the Control Panel is touched?

A. The beep tone sounds to assure that the setting is being properly entered.

Q. Will the microwave oven be damaged if it operates while empty?

A. Yes. Never run it empty or without the glass tray.

Q. Why do eggs sometimes pop?

A. When baking, frying, or poaching eggs, the yolk may pop due to steam build up inside the yolk membrane. To prevent this, simply pierce the yolk before cooking. Never microwave eggs in the shell.

Q. Why is standing time recommended after microwave cooking is over?

A. After microwave cooking is finished, food keeps on cooking during standing time. This standing time finishes cooking evenly throughout the food. The amount of standing time depends on the density of the food.

Q. Is it possible to pop popcorn in a microwave oven?

A. Yes, if using one of the two methods described below:

(1) Popcorn-popping utensils designed specifically for microwave cooking.

(2) Prepackaged commercial microwave popcorn that contains specific times and power outputs needed for an acceptable final product.

FOLLOW EXACT DIRECTIONS GIVEN BY EACH MANUFACTURER FOR THEIR POPCORN PRODUCT. DO NOT LEAVE THE OVEN UNATTENDED WHILE THE CORN IS BEING POPPED. IF CORN FAILS TO POP AFTER THE SUGGESTED TIMES, DISCONTINUE COOKING. OVERCOOKING COULD RESULT IN AN OVEN FIRE.

CAUTION: NEVER USE A BROWN PAPER BAG FOR POPPING CORN. NEVER ATTEMPT TO POP LEFTOVER KERNELS.

Q. Why doesn't my oven always cook as fast as the cooking guide says?

A. Check your cooking guide again to make sure you've followed directions correctly, and to see what might cause variations in cooking time. Cooking guide times and heat settings are suggestions, chosen to help prevent over-cooking, the most common problem in getting used to a microwave oven. Variations in the size, shape, weight and dimensions of the food require longer cooking time. Use your own judgement along with the cooking guide suggestions to test for doneness, just as you would do with a conventional cooking.