



DVD PLAYER

OWNER'S MANUAL

MODEL : DVD-4351N



MP3



Before connecting, operating or adjusting this product,
please read this instruction booklet carefully and completely.



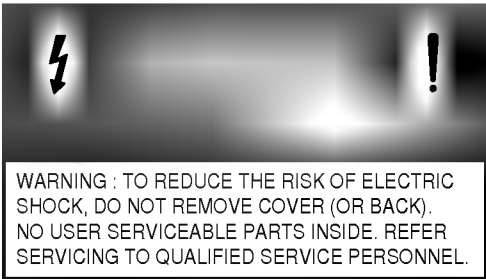

The lightning flash with arrowhead symbol, within an equilateral triangle, is intended to alert the user to the presence of uninsulated 'dangerous voltage' within the product's enclosure that may be of sufficient magnitude to constitute a risk of electric shock to persons.



The exclamation point within an equilateral triangle is intended to alert the user to the presence of important operating and maintenance (servicing) instructions in the literature accompanying the appliance.

WARNING: TO REDUCE THE RISK OF FIRE OR ELECTRIC SHOCK, DO NOT EXPOSE THIS PRODUCT TO RAIN OR MOISTURE.

CAUTION: TO PREVENT ELECTRIC SHOCK, MATCH WIDE BLADE OF PLUG TO WIDE SLOT, FULLY INSERT.

ATTENTION: POUR EVITER LES CHOCS ELECTRIQUE, INTRODUIRE LA LAME LA PLUS LARGE DE LA FICHE DANS LA BORNE CORRESPONDANTE DE LA PRISE ET POUSSER JUSQU'AU FOND.

CAUTION: This Digital Video Disc Player employs a Laser System. To ensure proper use of this product, please read this owner's manual carefully and retain for future reference, should the unit require maintenance, contact an authorized service location-see service procedure.

Use of controls, adjustments or the performance of procedures other than those specified may result herein hazardous radiation exposure.

To prevent direct exposure to laser beam, do not try to open the enclosure. Visible laser radiation when open the enclosure. DO NOT STARE INTO BEAM.

FCC NOTICE: This equipment has been tested and found to comply with the limits for a Class B digital device, pursuant to part 15 of the FCC Rules. These limits are designed to provide reasonable protection against harmful interference in a residential installation. This equipment generates, uses, and can radiate radio frequency energy and, if not installed and used in accordance with the instructions, may cause harmful interference to radio communications. However, there is no guarantee that interference will not occur in a particular installation. If this equipment does cause harmful interference to radio or television reception, which can be determined by turning the equipment off and on, the user is encouraged to try to correct the interference by one or more of the following measures:

- Reorient or relocate the receiving antenna.
- Increase the separation between the equipment and receiver.
- Connect the equipment into an outlet on a circuit different from that to which the receiver is connected.
- Consult the dealer or an experienced radio/TV technician for help.

FCC WARNING: Changes or modifications not expressly approved by the party responsible for compliance could void the user's authority to operate the equipment.

INDUSTRY CANADA REQUIREMENT :

This Class B digital apparatus meets all requirements of the Canadian Interference-Causing Equipment Regulations.

Cet appareil numéruque de la classe B respecte toutes les exigences du Règlement sur le matériel brouilleur du Canada.

RECORD YOUR MODEL NUMBER (Now, while you can see it)

The model and serial number of your new DVD player are located on the back of the DVD player cabinet. For your future convenience, we suggest that you record these numbers here:

MODEL NO. _____

SERIAL NO. _____

Introduction

- ❑ Safety Precautions 2
- ❑ Table of Contents 3
- ❑ IMPORTANT SAFETY INSTRUCTIONS 4-5
- ❑ Precautions 6
- ❑ Notes on Discs 7
- ❑ Identification of Controls 8-12
 - Front Panel/Display window 8
 - Rear Panel 9
 - Remote Control 10
 - Controlling the TVs 11
 - Preparing the Remote Control 12
 - Operating with the Remote Control 12

Connections

- ❑ Connecting to a TV 13
- ❑ Connecting to an Audio System 14
- ❑ Connecting to Optional Audio System 15-18
 - Enjoying Dolby Digital Sound 15
 - Enjoying Dolby Digital (5.1CH) Sound 16
 - Enjoying Dolby Pro Logic Surround Sound 17
 - Enjoying 2 Channel Digital Stereo Sound 18
 - Enjoying DTS Sound 18

Basic Operations

- ❑ Basic Playback 19-20
- ❑ Special Playback 21-22
 - Still Picture 21
 - Frame Advance 21
 - Skipping chapters and tracks forward or back 21
 - Scanning at High Speed 22
- ❑ Various speed playback with Shuttle Ring 23

Operation Using GUI Menu Icons

- ❑ General Information about GUI menu icons 24
- ❑ Detailed description of each GUI menu icon 25

Advanced Operation

- ❑ Using a title menu 26
- ❑ Using a DVD menu 26
- ❑ Memorizing Settings for Viewed DVDs (Last Condition Memory) 27
- ❑ Changing subtitle language 28
- ❑ Changing audio soundtrack language 28
- ❑ Viewing from another angle 29
- ❑ Producing a 3D Surround effect 29
- ❑ Repeat Play 30
- ❑ Storing markers in memory to be viewed (listened to) again 31
- ❑ Zoom Feature 32
- ❑ Random Play 32
- ❑ Program Play 33
- ❑ Playback with MP3 34-35

Initial Settings

- ❑ Selection of initial settings 36
- ❑ Selecting disc Languages 37
- ❑ Selecting rating level and password 38-39
- ❑ Selecting TV Aspect 40
- ❑ Selecting Menu Language 41
- ❑ Selecting Digital Audio Output 42
- ❑ Setting the Speaker Setup 43
- ❑ Others (DRC/Vocal) 44
- ❑ Table of Languages and Their Abbreviations 45

Reference

- ❑ Disc Requirements/Copyright Information 46
- ❑ Before Calling Service Personnel 47
- ❑ Specifications 48

CAUTION: PLEASE READ AND OBSERVE ALL WARNINGS AND INSTRUCTIONS IN THIS OWNER'S MANUAL AND THOSE MARKED ON THE UNIT. RETAIN THIS BOOKLET FOR FUTURE REFERENCE.

This set has been designed and manufactured to assure personal safety. Improper use can result in electric shock or fire hazard. The safeguards incorporated in this unit will protect you if you observe the following procedures for installation, use and servicing.

This unit is fully transistorized and does not contain any parts that can be repaired by the user.

DO NOT REMOVE THE CABINET COVER, OR YOU MAY BE EXPOSED TO DANGEROUS VOLTAGE. REFER SERVICING TO QUALIFIED SERVICE PERSONNEL ONLY.

1. Read owner's manual

After unpacking this product, read the owner's manual carefully, and follow all the operating and other instructions.

2. Power Sources

This product should be operated only from the type of power source indicated on the marking label. If you are not sure of the type of power supply in your home, consult your product dealer or local power company. For products intended to operate from battery power, or other sources, refer to the operating instructions.

3. Grounding or Polarization

This product is equipped with a polarized alternating current line plug (a plug having one blade wider than the other). This plug will fit into the power outlet only one way. This is a safety feature. If you are unable to insert the plug fully into the outlet, try reversing the plug. If the plug should still fail to fit, contact your electrician to replace your obsolete outlet. Do not defeat the safety purpose of the polarized plug.

4. Ventilation

Slots and openings in the cabinet are provided for ventilation and to ensure reliable operation of the product and to protect it from overheating. These openings must not be blocked or covered. The openings should never be blocked by placing the product on a bed, sofa, rug or other similar surface. This product should not be placed in a built-in installation such as a bookcase or rack unless proper ventilation is provided or the manufacturer's instructions have been adhered to.

5. Heat

The product should be situated away from heat sources such as radiators, heat registers, stoves, or other products (including amplifiers) that produce heat.

6. Water and Moisture

Do not use this product near water-for example, near a bath tub, wash bowl, kitchen sink, or laundry tub; in a wet basement; or near a swimming pool and the like.

7. Cleaning

Unplug this product from the wall outlet before cleaning. Do not use liquid cleaners or aerosol cleaners. Use a damp cloth for cleaning.

8. Power-Cord Protection

Power-supply cords should be routed so that they are not likely to be walked on or pinched by items placed upon or against them, paying particular attention to cords at plugs, convenience receptacles, and the point where they exit from the product.

9. Overloading

Do not overload wall outlets, extension cords, or integral convenience receptacles as this can result in a risk of fire or electric shock.

10. Lightning

For added protection of this product during storms, or when it is left unattended and unused for long periods of time, unplug it from the wall outlet. This will prevent damage to the product due to lightning and power-line surges.

11. Object and Liquid Entry

Never push objects of any kind into this product through openings as they may touch dangerous voltage points or short-out parts that could result in a fire or electric shock. Never spill liquid of any kind on the product.

12. Attachments

Do not use attachments not recommended by the product manufacturer as they may cause hazards.

(Cont'd)

13. Accessories

Do not place this product on an unstable cart, stand, tripod, bracket, or table. The product may fall, causing serious injury to a child or adult, and serious damage to the product. Use only with a cart, stand, tripod, bracket, or table recommended by the manufacturer, or sold with the product. Any mounting of the product should follow the manufacturer's instructions, and should use a mounting accessory recommended by the manufacturer. A product and cart combination should be moved with care. Quick stops, excessive force, and uneven surfaces may cause the product and cart combination to overturn.

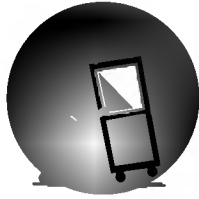
**14. Disc Tray**

Keep your fingers well clear of the disc tray as it is closing. It may cause serious personal injury.

15. Burden

Do not place a heavy object on or step on the product. The object may fall, causing serious personal injury and serious damage to the product.

16. Connecting

When you connect the product to other equipment, turn off the power and unplug all of the equipment from the wall outlet. Failure to do so may cause an electric shock and serious personal injury. Read the owner's manual of the other equipment carefully and follow the instructions when making any connections.

17. Sound Volume

Reduce the volume to the minimum level before you turn on the product. Otherwise, sudden high volume sound may cause hearing or speaker damage.

18. Sound Distortion

Do not allow the product to output distorted sound for a longtime. It may cause speaker overheating and fire.

19. Headphones

When you use the headphones, keep the volume at a moderate level. If you use the headphones continuously with high volume sound, it may cause hearing damage.

20. Laser Beam

Do not look into the opening of the disc tray or ventilation opening of the product to see the source of the laser beam. It may cause sight damage.

21. Disc

Do not use a cracked, deformed, or repaired disc. These discs are easily broken and may cause serious personal injury and product malfunction.

22. Damage Requiring Service

Unplug this product from the wall outlet and refer servicing to qualified service personnel under the following conditions:

- a) When the power-supply cord or plug is damaged.
- b) If liquid has been spilled, or objects have fallen into the product.
- c) If the product has been exposed to rain or water.
- d) If the product does not operate normally by following the operating instructions. Adjust only those controls that are covered by the operating instructions as an improper adjustment of other controls may result in damage and will often require extensive work by a qualified technician to restore the product to its normal operation.
- e) If the product has been dropped or damaged in any way.
- f) When the product exhibits a distinct change in performance-this indicates a need for service.

23. Servicing

Do not attempt to service this product yourself as opening or removing covers may expose you to dangerous voltage or other hazards. Refer all servicing to qualified service personnel.

24. Replacement parts

When replacement parts are required, be sure the service technician has used replacement parts specified by the manufacturer or have the same characteristics as the original part. Unauthorized substitutions may result in fire, electric shock, or other hazards.

25. Safety Check

Upon completion of any service or repairs to this product, ask the service technician to perform safety checks to determine that the product is in proper operating condition.

Notes on handling

- ❑ When shipping the DVD player, always use the original shipping carton and packing materials. For maximum protection, repack the unit as it was originally packed at the factory.
- ❑ Do not use volatile liquids, such as insect spray, near the DVD player. Do not leave rubber or plastic products in contact with the DVD player for a long time. They will leave marks on the finish.
- ❑ The top and rear panels of the DVD player may become warm after a long period of use. This is normal and not a malfunction.
- ❑ When the DVD player is not in use, be sure to remove the disc and turn off the power.
- ❑ If you do not use the DVD player for a long period, the unit may not function properly in the future. Turn on and use the DVD player occasionally.

Notes on Locating

- ❑ When you place this DVD player near a TV, radio, or VCR, the playback picture may become poor and the sound may be distorted. In this case, move the DVD player away from the TV, radio, or VCR.

Notes on Cleaning

Use a soft, dry cloth for cleaning.

- ❑ For stubborn dirt, soak the cloth in a weak detergent solution, wring well and wipe. Use a dry cloth to wipe it dry. Do not use any type of solvent, such as thinner and benzene, as they may damage the surface of the DVD player.
- ❑ If you use a chemical saturated cloth to clean the unit, follow that product's instructions.

Warning: Cleaning and adjustment of lenses and/or other components of playback mechanism should be performed by a qualified service technician.

To Obtain a Clear Picture

The DVD player is a high technology, precision device. If the optical pick-up lens and disc drive parts are dirty or worn down, the picture quality becomes poor. To obtain a clear picture, we recommend regular inspection and maintenance (cleaning or parts replacement) every 1,000 hours of use depending on the operating environment. For details, contact your nearest dealer.

Notes on Moisture Condensation

Moisture condensation damages the DVD player. Please read the following carefully.

Moisture condensation occurs, for example, when you pour a cold drink into a glass on a warm day. Drops of water form on the outside of the glass. In the same way, moisture may condense on the optical pick-up lens inside this unit, one of the most crucial internal parts of the DVD player.

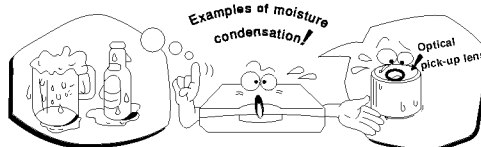

Moisture condensation occurs during the following cases.

- ❑ When you bring the DVD player directly from a cold place to a warm place.
- ❑ When you use the DVD player in a room where you just turned on the heater, or a place where the cold wind from the air conditioner directly hits the unit.
- ❑ In summer, when you use the DVD player in a hot and humid place just after you move the unit from an air conditioned room.
- ❑ When you use the DVD player in a humid place.

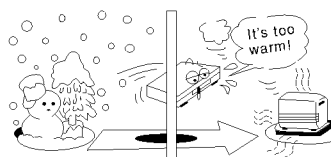

- ❑ **Do not use the DVD player when moisture condensation may occur.**

If you use the DVD player in such a situation, it may damage discs and internal parts. Remove the disc, connect the power cord of the DVD player to the wall outlet, turn on the DVD player and leave it "ON" for two or three hours. After two or three hours, the DVD player will have warmed up and evaporated any moisture. Keep the DVD player connected to the wall outlet and moisture condensation will seldom occur.

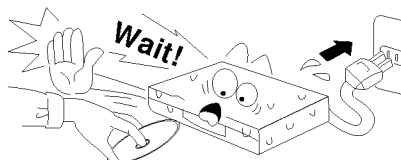

This section shows you how to handle, clean, and store discs.

On Handling Discs

- Do not touch the playback side of the disc.

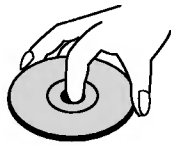

- Do not attach paper or tape to discs.



On Storing Discs

- Do not store discs in a place subject to direct sunlight or near heat sources.
- Do not store discs in places subject to moisture and dust such as a bathroom or near a humidifier.
- Store discs vertically in a case. Stacking or placing objects on discs outside of their case may cause warping.

On Cleaning Discs

- Fingerprints and dust on the disc cause picture and sound deterioration. Wipe the disc from the centre outward with a soft cloth. Always keep the disc clean.
- If you cannot wipe off the dust with a soft cloth, wipe the disc lightly with a slightly moistened soft cloth and finish with a dry cloth.
- Do not use any type of solvents such as thinner, benzene, commercially available cleaners or anti-static spray for vinyl LPs. They may damage the disc.



About This Owner's Manual

- This owner's manual explains the basic instructions of this DVD player.
- Some DVD video discs have functions that may not be explained in this owner's manual. Therefore, some instructions may differ from this owner's manual, and there may be extra instructions. In this case, follow the instructions displayed on the TV screen or package.
- "⊗" may appear on the TV screen during operation. This icon means the function explained in this owner's manual is not available on that specific DVD video disc.

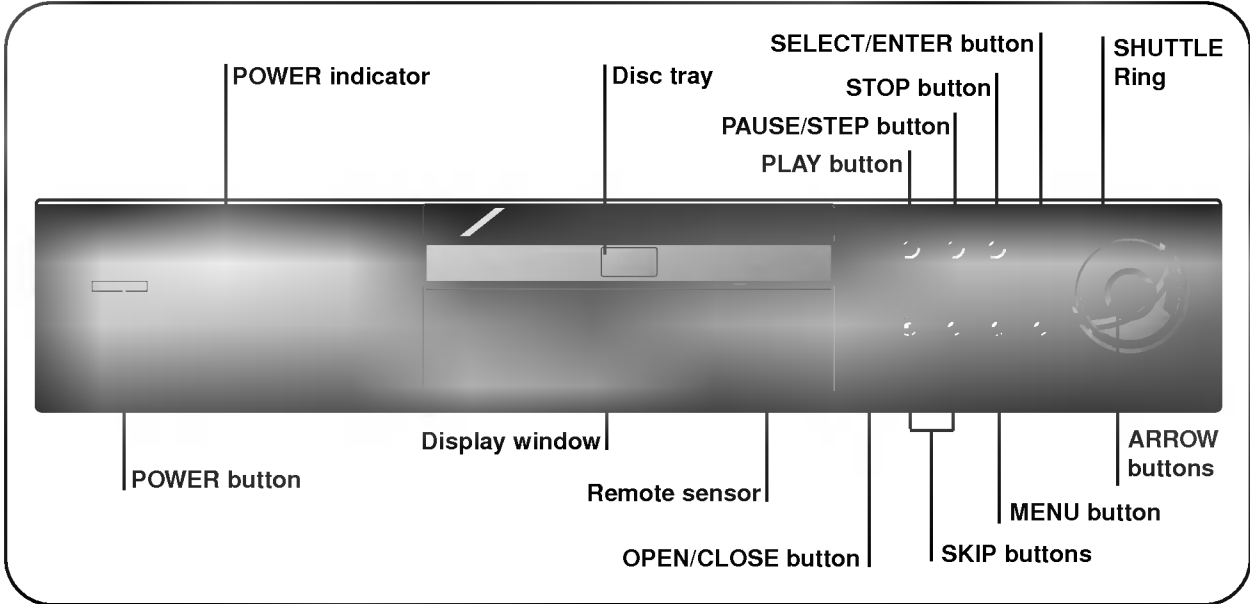

Display Window

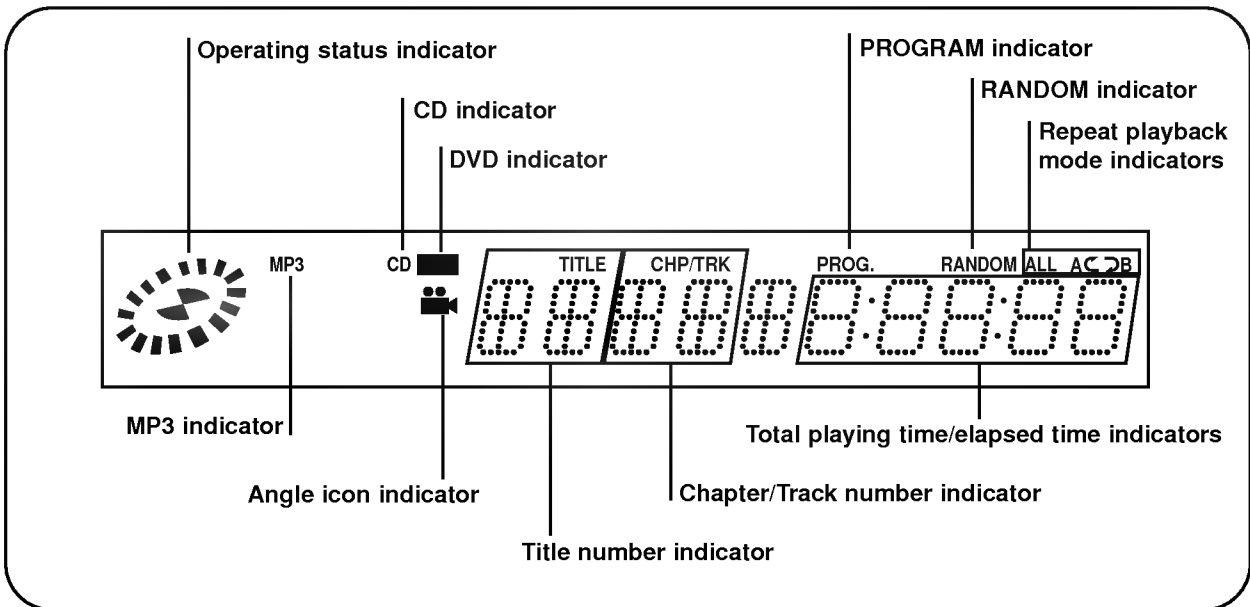

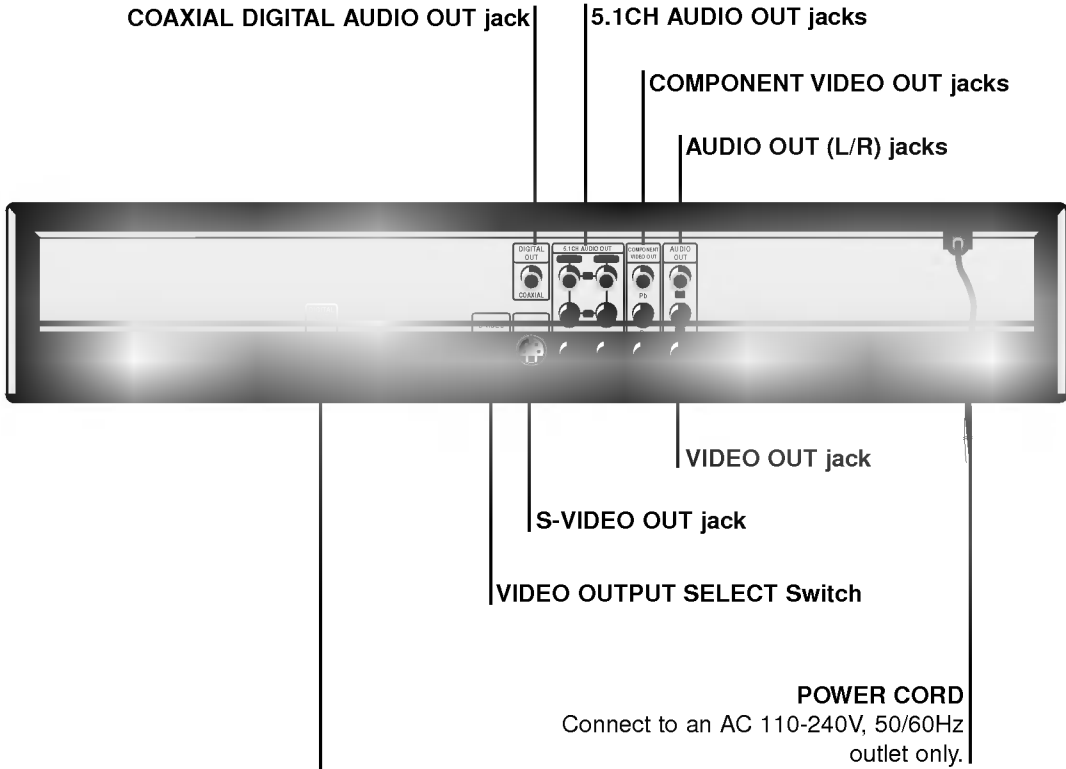

OPTICAL DIGITAL AUDIO OUT jack
Remove the dust protection cap from the connector and connect the optical digital cable (not supplied) firmly so that the configurations of both the cable and the connector match. Keep the dust protection cap and always reattach the cap when not using the connector to protect against dust.

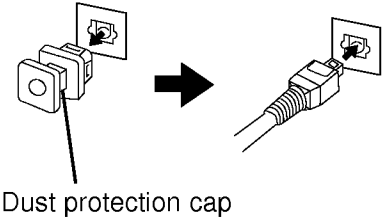

REMOTE CONTROL

You will find instructions for each of the remote control functions in the appropriate sections of this instruction manual.

POWER button

***TITLE button**

DISPLAY button

SELECT/ENTER button

***** ARROW (Volume/Channel) buttons**

MARKER button

SEARCH button

SKIP (*SEARCH) button

NUMBER buttons

SETUP button

SUBTITLE button

REPEAT button

CLEAR button

A-B button

DVD/TV Selector Switch

OPEN/CLOSE button

RETURN (TV INPUT) button

****MENU button**

SOUND (MUTE) button

ZOOM button

PAUSE/STEP button

SKIP (*SEARCH) button

PLAY button

STOP button

PROGRAM button

ANGLE button

AUDIO button

RANDOM button

SLOW/SCAN Shuttle Ring

***TITLE button**
Use the TITLE button to display the title screen included on DVD video discs. To operate a menu screen, follow the instructions in "Using a Title Menu" (page 26).

****MENU button**
Use the MENU button to display the menu screen included on DVD video discs. To operate a menu screen, follow the instructions in "Using a DVD Menu" (page 26).

*****Directional arrow buttons** (up, down, left, right) for use in highlighting a selection on a GUI menu screen, TITLE and MENU screen.

* Press and hold button for about two seconds for search function.

Your remote control operates the common features of most, but not all, models and brands of IR (infrared) controlled TVs.

Set the DVD/TV selector to TV.

While holding PROGRAM button, press the number buttons to set the code number referring to the table on the below.

Some manufactures have more than one code number. If the remote control does not operate with the TV after setting the code number, try another number.

To control the TV

POWER, Number (0 - 9), SELECT (ENTER), RETURN (Input select), CH (Channel) ▼/▲ and VOL (Volume) ▼/▲ buttons on the remote control are activated.

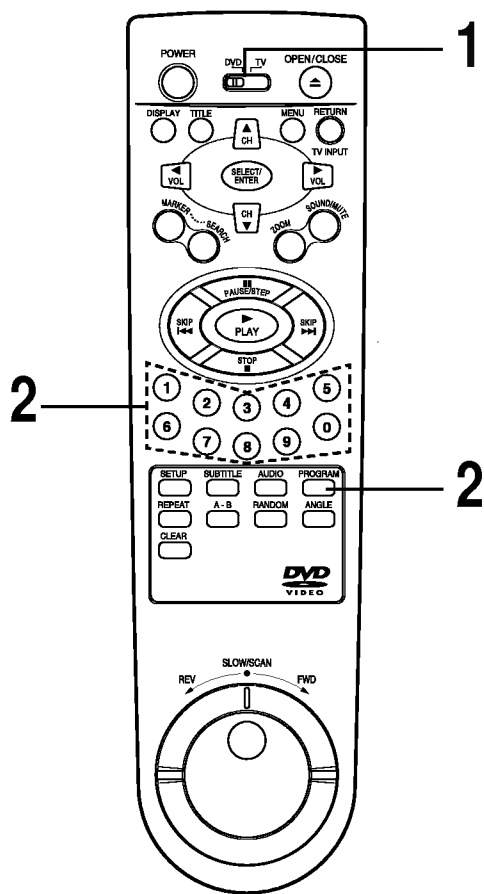

○ Due to the variety of codes used by manufactures, our company cannot guarantee that the MBR remote control will operate with every model of the brands listed.

TV Brand Name	Codes	TV Brand Name	Codes
ADMIRAL	16,33,37,44,45	MGA/MITSUBISHI	01,08,32,34
AIWA	70	MONTGOMERY WARD	01,06,08,09,23,24,32,33,34
AKAI	01	NEC	01,08
AMARK	09	NOBLEX	07
AOC	01	PACKARD BELL	43
BELL & HOWELL	33	PANASONIC	07,11,13,25,35,36
BROKSONIC	18,19	PHILCO	01,06,07,08,09,15,38,43,58
CANDLE	51	PHILIPS	06,07,43,61,62,65
CCE	07	PIONEER	30
CENTURION	08	PORTLAND	09
CINERAL	43	PROSCAN	03,37,44
CITIZEN	49,50,51,52,53,54,55	QUASAR	11,13
CORONADO	09	RADIO SHACK	16,17,23
CROWN	09	RCA	01,03,37,44,69
CURTIS MATHES	01,03,08,33,35,37,44	REALISTIC	16,17,23
DAEWOO	16,38,39,40,41,42,43	SAMPO	08
DAYTRON	01,08	SAMSUNG	01,08,09,25,68
EMERSON	01,09,16,17,18,19	SANYO	28,29
FISHER	28,29	SCOTT	01,08
FUNAI	46,47	SEARS	09,25,26,27,28,29
GENERAL ELECTRIC	03,10,11,13,37,44	SEMP	64
GRADIENTE	01,56,57,63,67	SHARP	09,22,23,24,60,66
HITACHI	09,14,15,43	SIGNATURE 2000	01,06,08,09,10,23,24,33,34
JC PENNEY	01,08,10,27,35	SONY	12,62
JVC	20,21,63,67	SOUNDESIGN	51
KIOTE	43	SYLVANIA	01,04,05,06,07,08,35,51
KMC	09	SYMPHONIC	46,47
KTV	01,08,09,31	TATUNG	11
LG (GOLDSTAR)	01,07,08,09,35,39,40	TEKNIKA	07,09,16,33,51
LODGENET	33	TELERENT	09,33
LOGIK	33	THOMSON	69
LXI	09,24,25,26,27,28,29	YORX	08
MAGNAVOX	01,02,04,05,06,07,08,09,20,34,35,43,51,61,62,65	TOSHIBA	01,25,26,27,64
MAJESTIC	33	WARDS	01,06,08,09,10,33,34
MARANTZ	01,32	XR1000	48
MEMOREX	33	ZENITH	02,33,59

Preparing the Remote Control

Insert the batteries into the remote control so you can use it to operate the DVD player.

Open the battery cover.

Insert batteries (AAA size).

- Make sure to match the + and - on the batteries to the marks inside the battery compartment.

Close the cover.

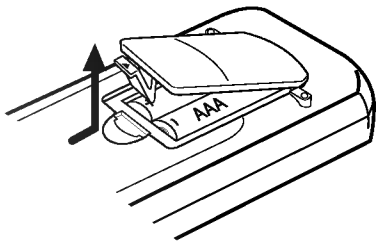

Operating with the Remote Control

This section shows you how to use the remote control.

Point the remote control at the remote sensor and press the buttons.

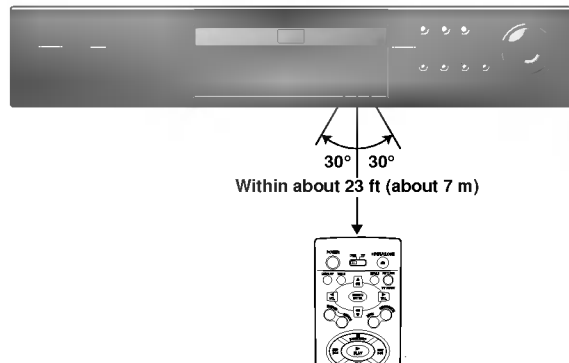

Distance: About 23 ft (7 m) from the front of the remote sensor

Angle: About 30° in each direction of the front of the remote sensor

- * Do not expose the remote sensor of the DVD player to a strong light source such as direct sunlight or illumination. If you do so, you may not be able to operate the DVD player with the remote control.

- Improper use of batteries may cause battery leakage and corrosion.
- To operate the remote control correctly, follow the instructions.
- Do not insert the batteries into the remote control in the wrong direction.
- Do not charge, heat, open, or short-circuit the batteries. Do not throw the batteries into fire.
- Do not leave dead or exhausted batteries in the remote control.
- Do not use different types of batteries together, or mix old and new batteries.
- If you do not use the remote control for a long period of time, remove the batteries to avoid possible damage from battery corrosion.
- If the remote control does not function correctly or if the operating range becomes reduced, replace all batteries with new ones.
- If battery leakage occurs, wipe the battery liquid from the battery compartment, then insert new batteries.
- The batteries should last about one year with normal use.

- Point the remote control at the remote sensor on the DVD player.
- Do not drop or give the remote control a shock.
- Do not leave the remote control near an extremely hot or humid place.
- Do not spill water or put anything wet on the remote control.
- Do not disassemble the remote control.

Connect the DVD player to your TV.

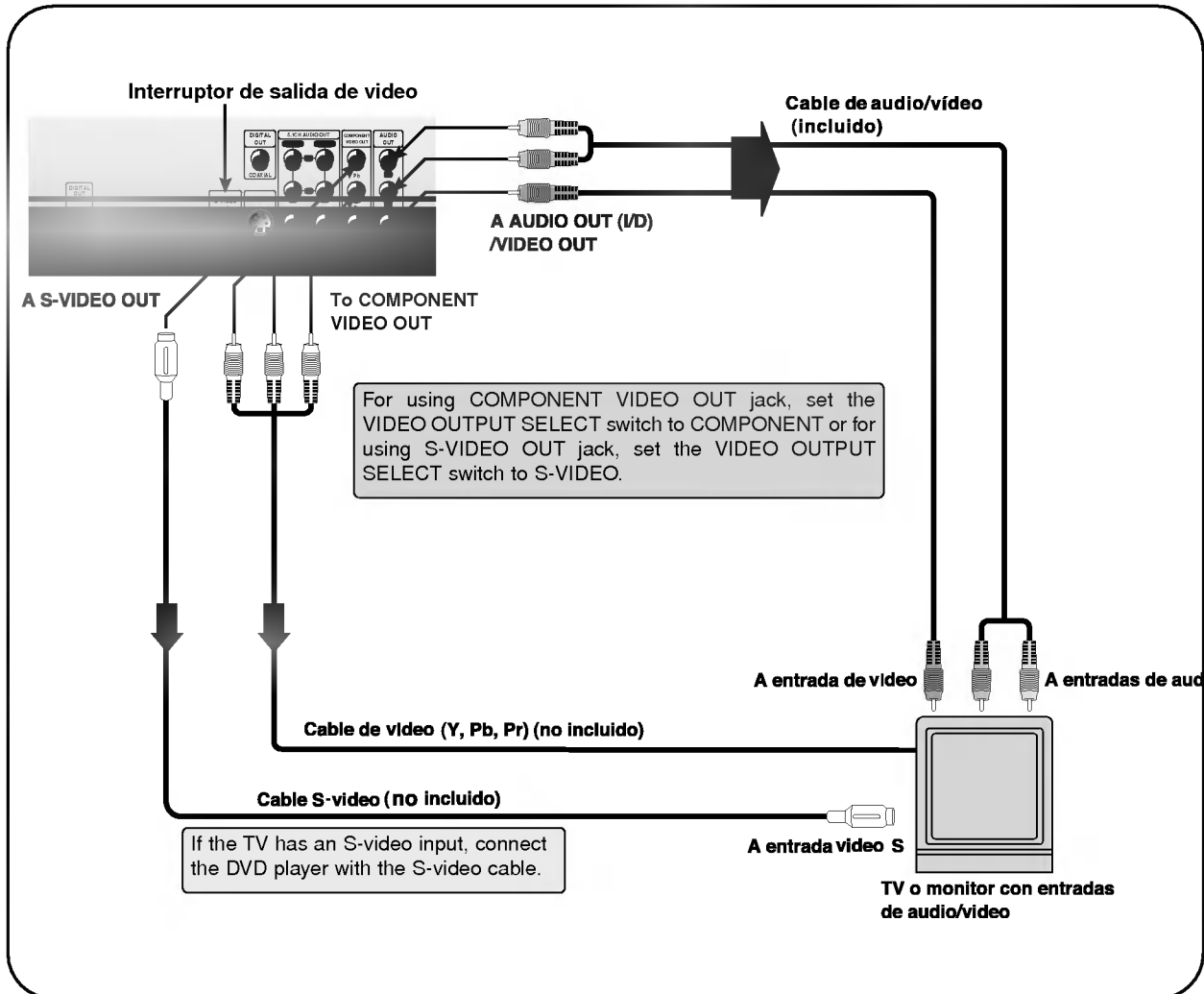

- Refer to the owner's manual of your TV as well.
- Before you connect the DVD player to your TV, be sure to turn off the power and unplug both units from the wall outlet before making any connections.
- Connect the DVD player to your TV directly. If you connect the DVD player to a VCR, the playback picture will be distorted because DVD video discs are copy protected.

Warning

Do not set the Digital Audio Output of this DVD player to "Dolby Digital" unless you are connecting the DIGITAL OUT jack of this DVD player to an AV decoder that has the Dolby Digital decoding function. High volume sound may damage your hearing as well as the speakers (Refer to "Selecting Digital Audio Output" on page 42).

You can listen to the sound of audio CDs and DVD video discs in stereo.

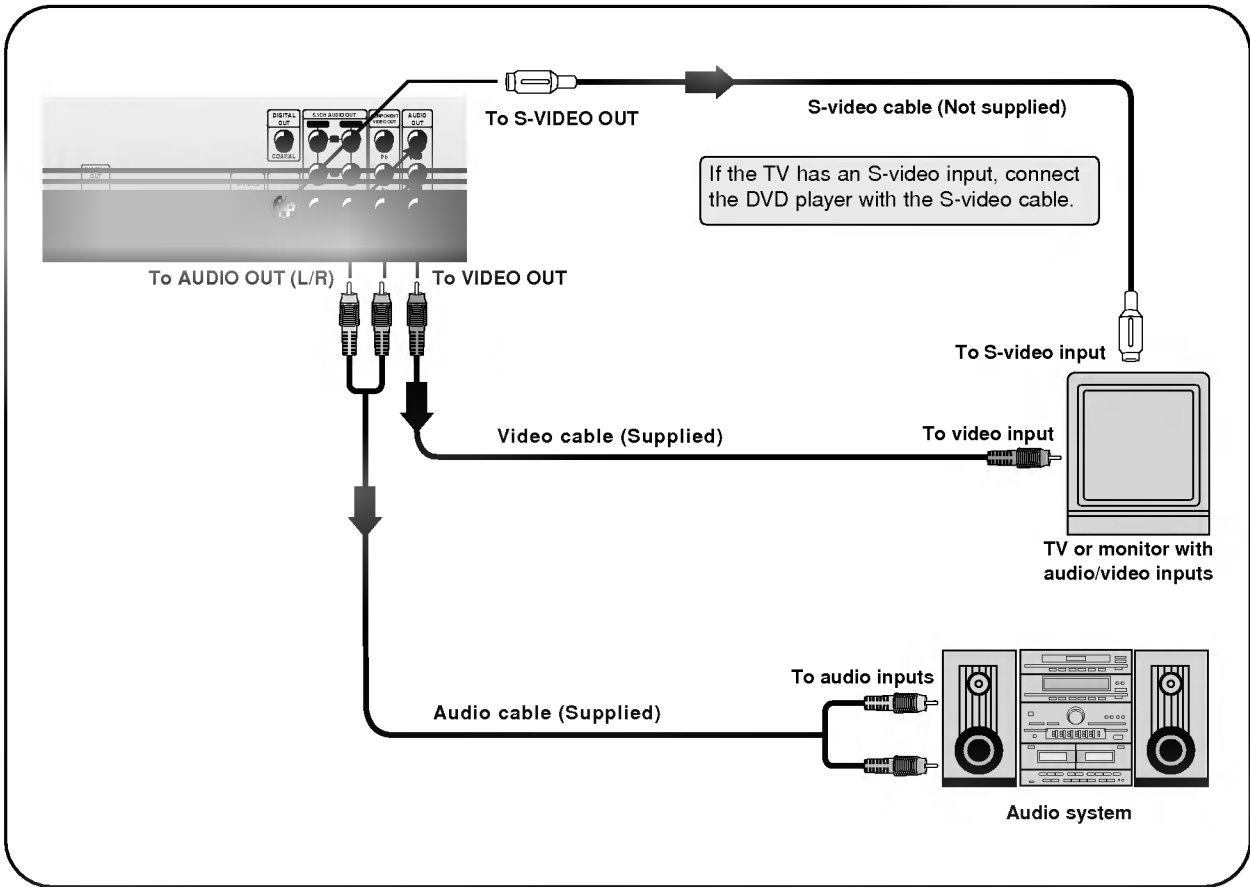

- Refer to the owner's manual of your audio system as well.
- Before you connect the DVD player to other equipment, be sure to turn off the power and unplug all of the equipment from the wall outlet before making any connections.
- If you place the DVD player near a tuner or radio, the radio broadcast sound might be distorted. In this case, move the DVD player away from the tuner and radio.
- The output sound of the DVD player has a wide dynamic range. Be sure to adjust the receiver's volume to a moderate listening level. Otherwise, the speakers may be damaged by a sudden high volume sound.
- Turn off the receiver before you connect or disconnect the DVD player's power cord. If you leave the receiver power on, the speakers may be damaged.

Warning

Do not set the Digital Audio Output of this DVD player to "Dolby Digital" unless you are connecting the DIGITAL OUT jack of this DVD player to an AV decoder that has the Dolby Digital decoding function. High volume sound may damage your hearing as well as the speakers (Refer to "Selecting Digital Audio Output" on page 42).

Enjoying Dolby Digital Sound

You can enjoy the high quality dynamic sound of Dolby Digital, Dolby Pro Logic, and 2 Channel Digital Stereo.

Dolby Digital

Dolby Digital is the surround sound technology used in theatres showing the latest movies, and is now available to reproduce this realistic effect in the home. You can enjoy motion picture and live concert DVD video discs with this dynamic realistic sound by connecting the DVD player to a 6 channel receiver equipped with a Dolby Digital decoder or Dolby Digital processor.

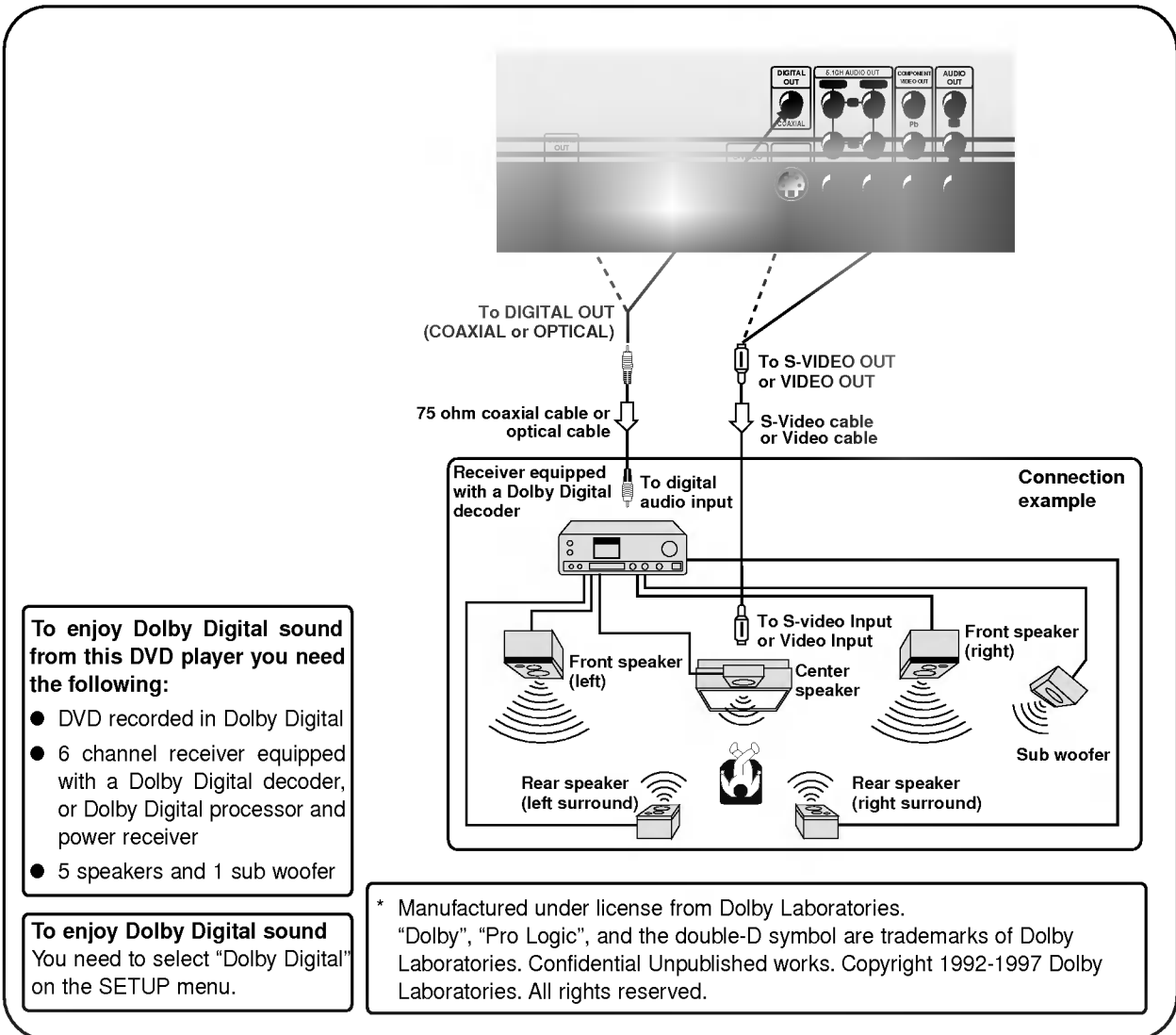

- Refer to the owner's manual of your audio equipment as well.
- When you connect the DVD player to other equipment, be sure to turn off the power and unplug all of the equipment from the wall outlet before making any connections.
- The output sound of the DVD player has a wide dynamic range. Be sure to adjust the receiver's volume to a moderate listening level. Otherwise, the speakers may be damaged by a sudden high volume sound.
- Turn off the receiver before you connect or disconnect the DVD player's power cord. If you leave the receiver power on, the speakers may be damaged.

Enjoying Dolby Digital (5.1 CH) Sound

Dolby Digital Surround (5.1 CH)

Dolby Digital is a six-channel digital surround sound technology developed by Dolby Laboratories for theater-like surround sound reproduction. DVDs supporting Dolby Digital technology feature the  logo. You can enjoy realistic, theater-like surround sound from DVD movie or music disc featuring this logo. Two front, one center and two rear speakers plus a subwoofer make up the "5.1-channel" audio system that Dolby Digital uses.

Hookups

Connect a receiver with 5.1 channel inputs to the player and to the speakers. See the figure below.

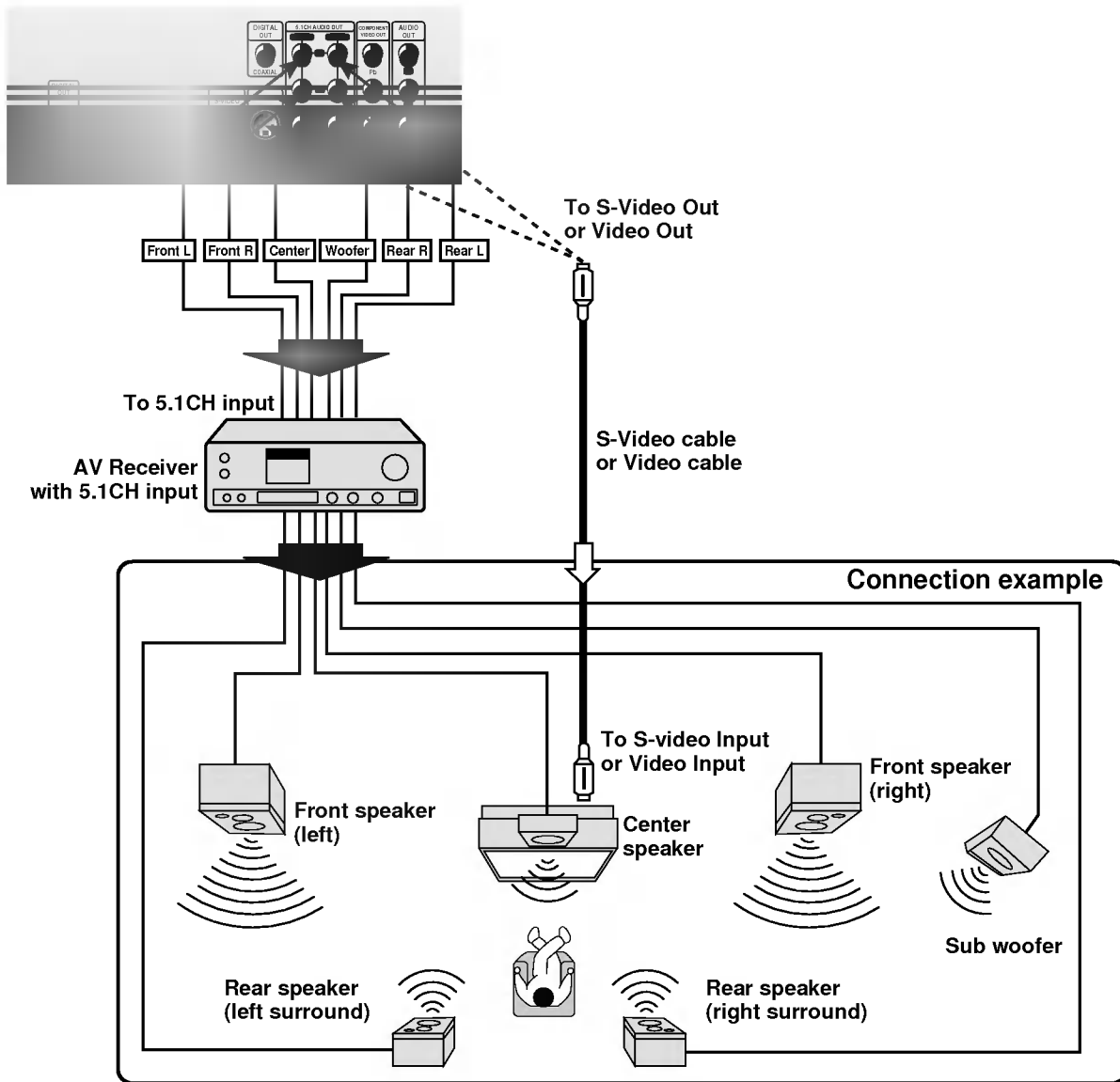

Enjoying Dolby Pro Logic Surround Sound

Dolby Pro Logic Surround

You can still enjoy the excitement of Surround Sound even if your A/V receiver does not offer Dolby Digital decoding. If your A/V receiver has a Dolby Pro Logic decoder, refer to the following connection diagram.

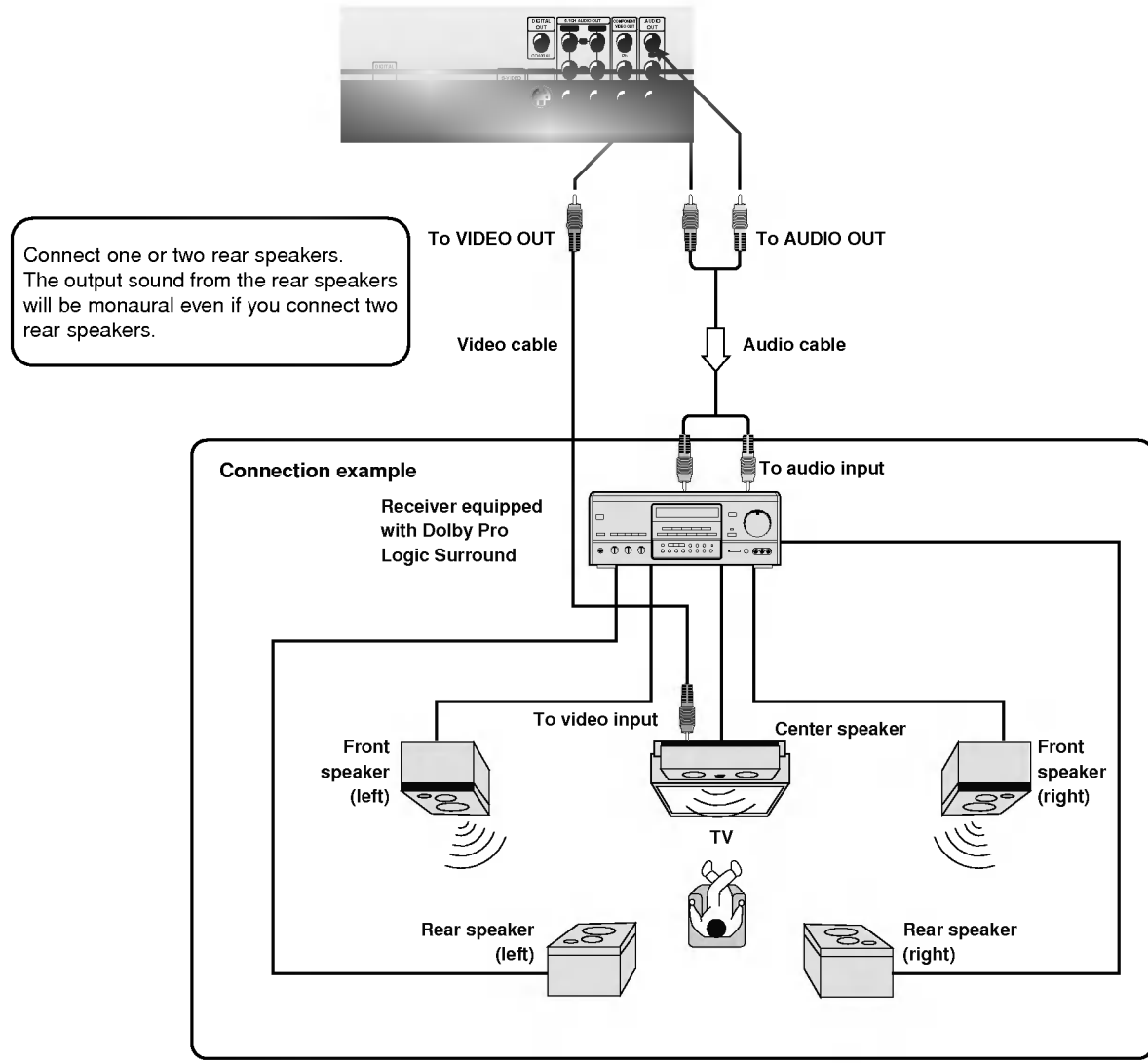

- **With a receiver equipped with Dolby Digital**
Connect the equipment the same way as described in "Enjoying Dolby Digital Sound" on the previous page. Refer to that receiver's owner's manual and set the receiver so you can enjoy Dolby Pro Logic Surround sound.

Warning

Do not set the Digital Audio Output of this DVD player to "Dolby Digital" unless you are connecting the DIGITAL OUT jack of this DVD player to an AV decoder that has the Dolby Digital decoding function. High volume sound may damage your hearing as well as the speakers (Refer to "Selecting Digital Audio Output" on page 42).

Enjoying 2 Channel Digital Stereo Sound

2 Channel Digital Stereo

You can enjoy the dynamic sound of 2 Channel Digital Stereo by connecting this DVD player to a receiver equipped with a digital audio input and speaker system (right and left front speakers).

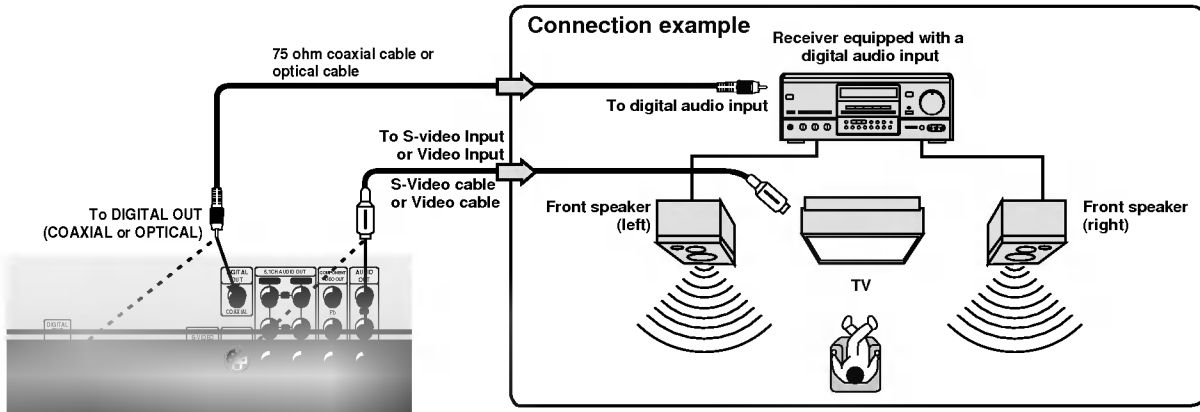

Enjoying DTS Sound

Introducing DTS Digital Surround™...the finest technology ever invented to transform existing "home theatre" systems into six discrete channels of exceptionally clear, better-than-compact disc, digital audio performance. And DTS Digital Surround is the only 5.1 surround sound format that can deliver this revolutionary 3-dimensional experience through new music recordings on compact discs, original 5.1 soundtracks on motion picture laserdiscs, and soon, a wide variety of products on DVD.

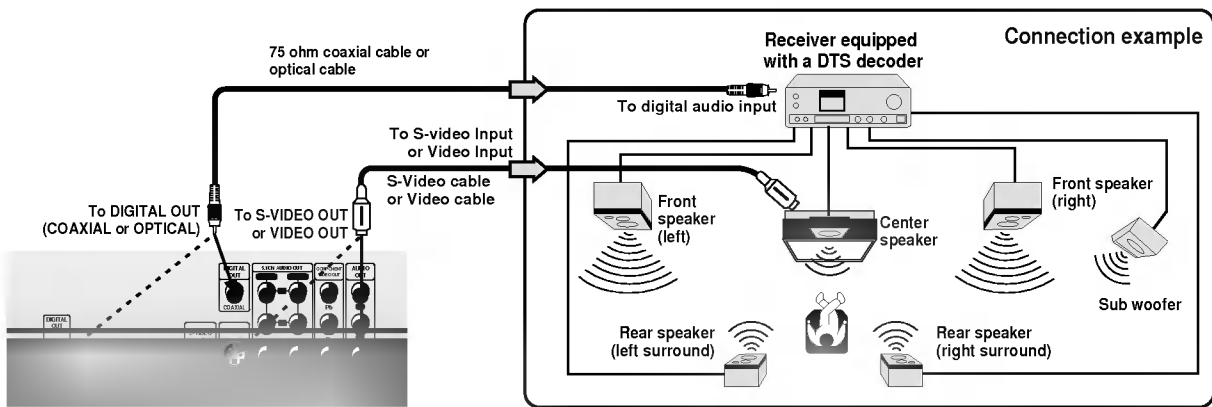

"DTS" and "DTS Digital Out" are trademarks of Digital Theater Systems, Inc.

- Refer to the owner's manual of your receiver as well.
- Before you connect the DVD player to other equipment, be sure to turn off the power and unplug all of the equipment from the wall outlet before making any connections.
- The output sound of the DVD player has a wide dynamic range. Be sure to adjust the receiver's volume to a moderate listening level. Otherwise, the speakers may be damaged by a sudden high volume sound.
- Turn off the receiver before you connect or disconnect the DVD player's power cord. If you leave the receiver power on, the speakers may be damaged.



This section shows you the basics on how to play back a DVD video disc.



Preparations

- When you want to play back DVD video discs, turn on the TV and select the video input source connected to the DVD player.
- When you want to enjoy the sound of DVD video discs or audio CDs from the audio system, turn on the audio system and select the input source connected to the DVD player.
- For connection details, see pages 13 through 18.
- Set the playback picture size according to the aspect ratio of the connected TV at the SETUP menu (TV Aspect).
- If you do not have the necessary equipment to enjoy Dolby Digital sound, set the Digital Audio Output at the SETUP menu to "PCM".

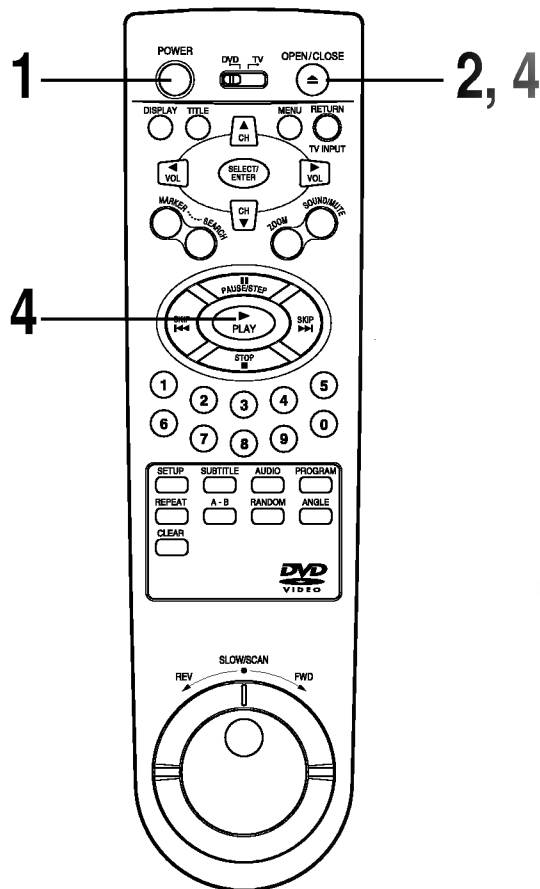

Press POWER.
The DVD player turns on and the power indicator lights.

Press OPEN/CLOSE.
The disc tray opens.
● You can open the disc tray by pressing this button even if the DVD player is in standby mode.

Place a disc on the disc tray with the playback side down.
● There are two different disc sizes. Place the disc in the correct guide on the disc tray. If the disc is out of the guide, it may damage the disc and cause the DVD player to malfunction.
● Do not place anything except 3" discs or 5" discs on the disc tray.

Press PLAY.
The disc tray is automatically closed and playback begins.
● If the disc is placed in upside down (and it is a single sided disc), "NO DISC" or "DISC ERROR" appears on the TV screen.

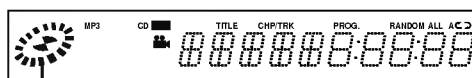

Operating status indicator

- If you insert an audio CD, the CD indicator lights up in the DVD display. The title number does not appear.
- After playing back all of the chapters in the title, the DVD player automatically stops and returns to the menu screen.

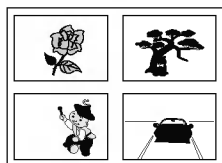

Example of interactive DVD On-Screen Menu

When a menu screen appears on the TV screen.
In case of interactive DVDs with control, a menu screen appears on the TV screen. Perform step 5 on page 20 to start play.



Press ▲/▼/◀▶ and press SELECT/ENTER, or press the numeric button(s), to select the desired item.

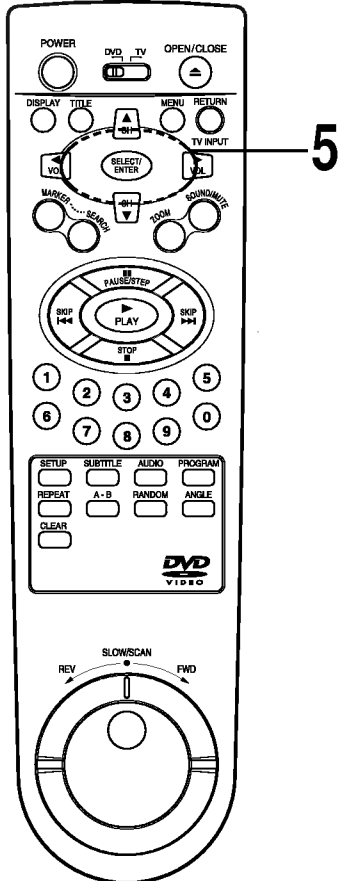

OR

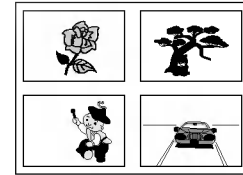

Play of the selected item now begins.

- For further information, also refer to the jacket or case of the disc you are playing.

After operation

When the unit is not in use, remove the disc and press POWER to turn off the power.

- Do not move the DVD player during playback. Doing so may damage the disc and the DVD player.
- Use the OPEN/CLOSE button on the remote control or DVD player to open and close the disc tray. Do not push the disc tray while it is moving. Doing so may cause the DVD player to malfunction.
- Do not push up the disc tray or put any objects other than discs on the disc tray. Doing so may cause the DVD video player to malfunction.
- Keep your fingers well clear of the disc tray as it is closing. Be especially careful with children's fingers around the closing disc tray as there is a risk of personal injury.
- When "⊘" appears on the TV screen while a button is pressed, it means that this function is not available on the disc you are playing.
- Depending on the DVD disc, some operations may be different or restricted. Refer to the jacket or case of the disc you are playing.

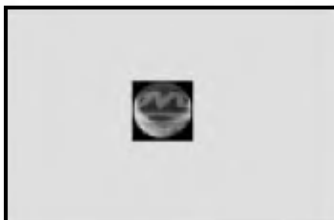

Screen Saver

The screen saver is useful to prevent your display from becoming damaged.

The screen saver picture appears when you leave the DVD player in stop mode for about 5 minutes.

Automatic power off function

After the Screen Saver has been engaged for about 5 minutes, the DVD player will automatically turn itself off.

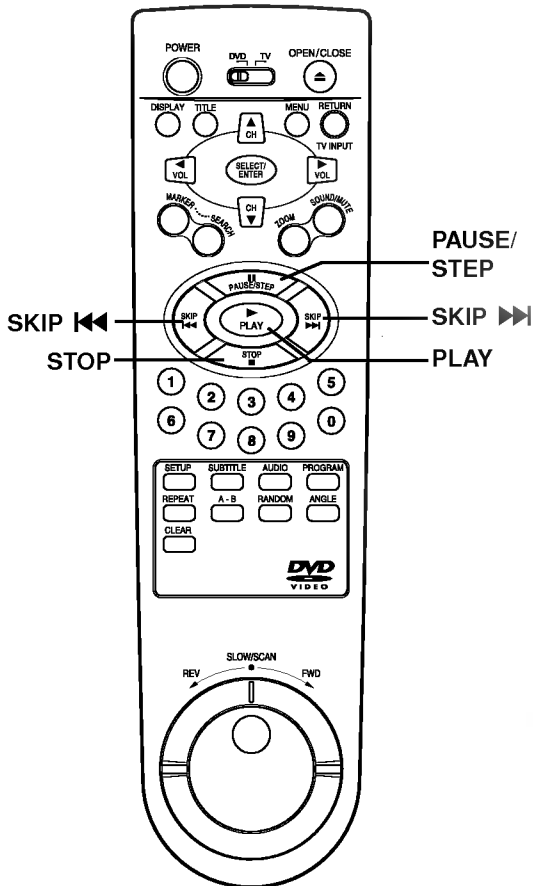

Press STOP during playback.

- When play is stopped, the unit records the point where STOP was pressed (RESUME function). Press PLAY and play will resume from this point.

- Resume function will be cleared when the STOP is pressed on the STOP mode.
- Resume function will be cleared when the power is turned off and then on.
- Opening the disc tray cancels Resume function.
- The Resume function may not be available on some DVD discs.

Press PAUSE/STEP during playback.

- DVD
The player will be placed in the still picture mode.
- CD
The player will be placed in the pause mode.

Press PAUSE/STEP during still playback.

(Each time you press PAUSE/STEP, the picture advances one frame)

To resume normal playback, press PLAY.

Skipping chapters and tracks forward or back

Skipping forward

Press SKIP >>> during playback.

A chapter (DVD) or a track (CD) is skipped each time the button is pressed.

Skipping back

Press SKIP <<< during playback.

- When the button is pressed once midway through a chapter/track, the player returns to the start of that chapter/track. When it is pressed again, a chapter/track is skipped each time the button is pressed.



You can play back discs at various speeds.

To Scan at fast forward or fast reverse playback.

Press and hold SKIP ◀◀ or ▶▶ button for about two seconds during playback.

[TV screen]

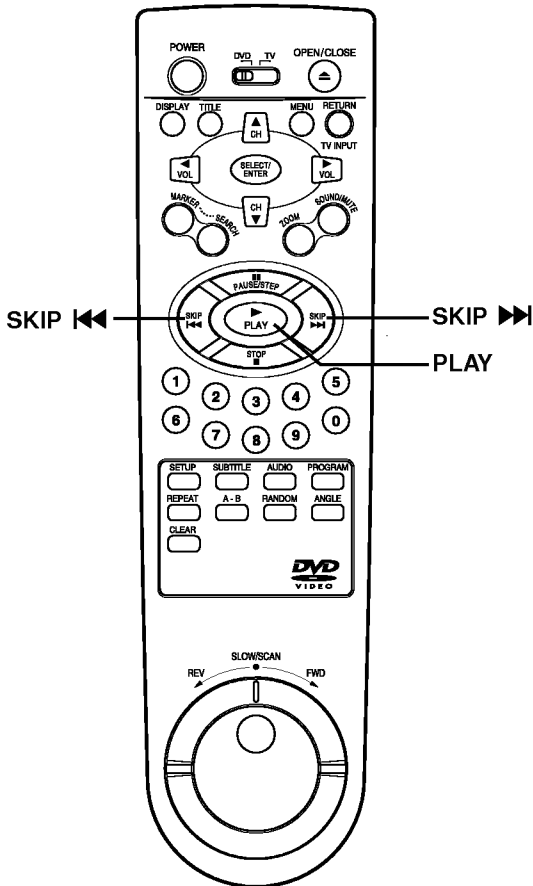
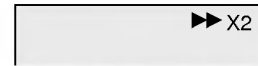
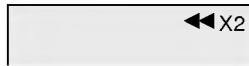

- The speed of advance (reverse) is relatively slow at first. When the button is pressed again, the speed becomes faster. (Each time the button is pressed, the speed increases up to 4 steps (DVD) or 1 step (CD).)
- The speed will be retained even after the button is released.

To return to normal playback, press PLAY.

- The DVD player does not play back sound during the high speed reverse and forward playback of DVD video discs. However, the DVD player plays back sound during fast forward or fast reverse playback of audio CDs.



You can play back discs at various speeds, and resume normal playback.

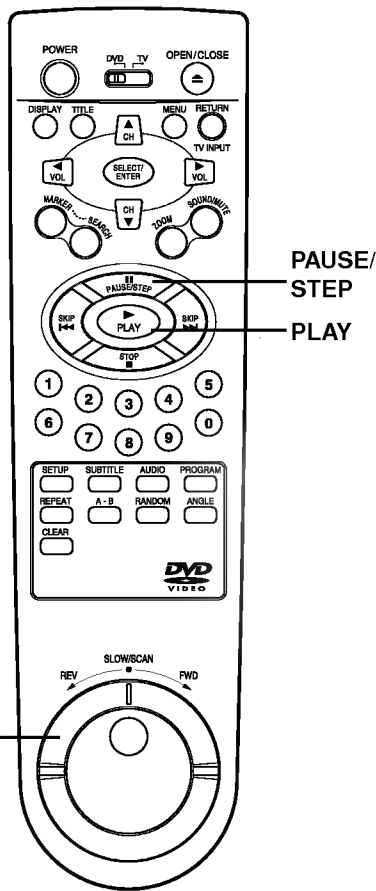

SLOW/SCAN Shuttle ring

During still picture mode, rotating and holding the SHUTTLE ring to the positions indicated gives those slow modes.

- The variable-speed slow picture will appear on the TV screen.

Release the SHUTTLE ring to resume the still picture mode.

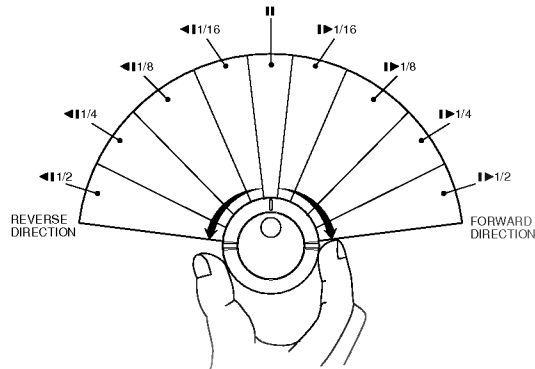

During playback mode, rotating and holding the SHUTTLE ring to the positions indicated gives those fast search modes.

- The variable-speed search picture will appear on the TV screen.

Release the SHUTTLE ring to resume normal playback.

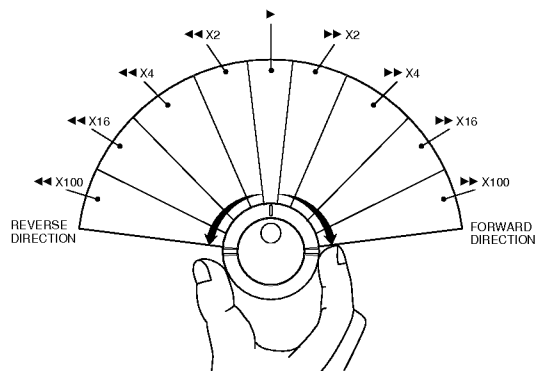

- The DVD player does not play back sound during slow-motion playback, the high speed reverse and forward playback of DVD video discs. However, the DVD player plays back sound during fast forward or fast reverse playback of audio CDs.
- Subtitles do not appear on the screen during slow motion and scan playback.
- The DVD player provides four (4) scan speeds (DVD) and one (1) scan speeds (Audio CD).
- The DVD player does not play back in slow-motion in case of audio CD.



This unit features GUI Menu Icons showing disc information (title/chapter/track number, elapsed playing time, audio/subtitle language, angle, and sound) and player information (repeat play, play mode, marker, etc.). Some icons only show the indicated information. Other icons allow the settings to be changed.

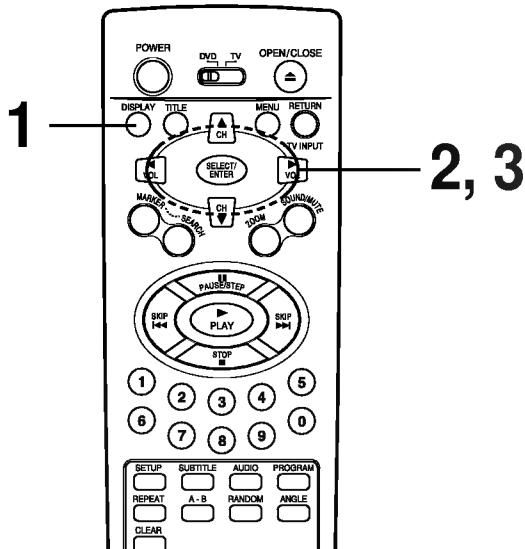

Common procedures

Press DISPLAY during playback.

- Title function can be accessed from the stop mode.

Press ▲/▼ to select the desired item.

- The current selected item is indicated by a yellow frame on its GUI menu icons.

Press ◀▶ to select the desired setting.

- When numbers are displayed (e.g. title number), the numeric buttons can also be used for setting instead of ◀▶.
- For some functions, the setting will be registered immediately; for others, SELECT/ENTER must be pressed.

To clear the GUI Menu Icons, press DISPLAY again.

Examples of GUI Menu Icons.

(The screens may differ depending on the disc contents.)



(DVD GUI)



(CD GUI)

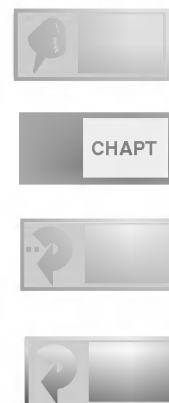

(DVD and CD GUI)



You can view information about a disc and its operational status on the TV screen.

Press DISPLAY during playback.

[TV screen] DVD GUI



FUNCTION (Press ▲/▼ to select desired item)	SELECTION METHOD
To show the current title number and to jump to the desired title number	◀▶, or Numeric SELECT/ENTER
To show the current chapter number and to jump to the desired chapter number	◀▶, or Numeric SELECT/ENTER SKIP
To show the elapsed time and directly select scenes by the desired time.	Numeric SELECT/ENTER
To show the current audio soundtrack language, encoding method, channel number and to change the settings.	◀▶, AUDIO
To show the current subtitles language and to change the setting.	◀▶, SUBTITLE
To show the current angle number and to change the angle.	◀▶, ANGLE
To show the current sound (NORMAL, 3D SURROUND, Dolby Pro Logic or Dolby 3 Stereo) and to change the setting.	◀▶, SOUND

Press DISPLAY during playback.

[TV screen] CD GUI



FUNCTION (Press ▲/▼ to select desired item)	SELECTION METHOD
To show the current track number and to jump to the desired track number	◀▶, or Numeric SELECT/ENTER SKIP
To show the elapsed time. (Display only)	—
To show the current audio (STEREO, LEFT, RIGHT) and to select to the desired audio channel.	◀▶, AUDIO
To show the current sound (NORMAL, 3D SURROUND, Dolby Pro Logic or Dolby 3 Stereo) and to change the setting.	◀▶, SOUND

○ Some DVD discs may not provide all of the above GUI menu icons.



Some movie discs may contain two or more titles. If the disc has a title menu recorded on it, the TITLE button can be used to select the movie title. (The details of operation differ depending on the disc used.)

- Selecting a title may not be possible on certain DVD discs.

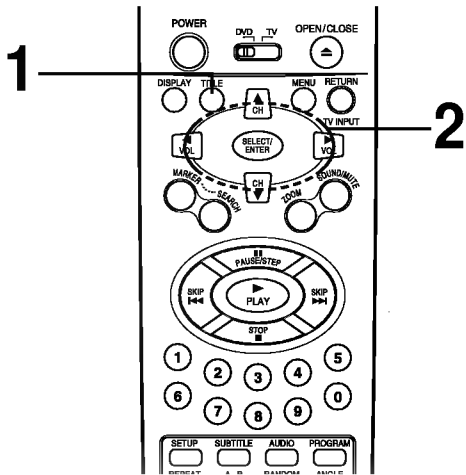

Press TITLE.

A list of the titles on the disc is displayed.

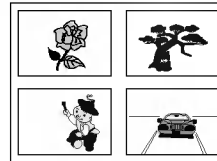

Pressing TITLE again to resume play from the scene when TITLE was first pressed.

- Resume play may not be possible on certain discs.

Press ▲/▼/◀▶ and press SELECT/ENTER or PLAY, or press the numeric button(s), to select desired title.

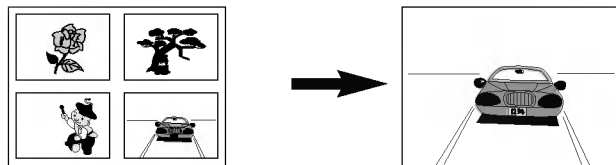

The selected title now starts playing.



Some DVDs have unique menu structures called DVD menus. For example, DVDs programmed with complex contents provide guide menus, and those recorded with various languages provide menus for audio and subtitle language. Although the DVD menu's contents and operation differ from disc to disc, the following explains the basic operation when this feature is used.

Press MENU during play.

The DVD menu available on the disc is now displayed.

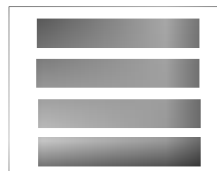

Pressing MENU again resumes play from the scene when MENU was first pressed.

- Resume play may not be possible on certain discs.

Press ▲/▼/◀▶ and press SELECT/ENTER, or press the numeric button(s), to select desired item.

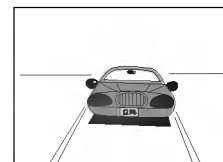
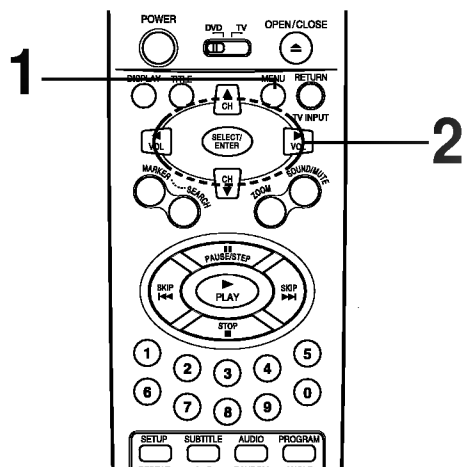

The selected item is now executed.



This unit stores, in memory, settings for the last DVD you have watched. Settings remain in memory even if you remove the disc from the player, or switch power to OFF. If you load a disc that has its settings memorized, the "Resume disc from last position?" message will appear on the TV screen. When you start playing the disc, the memorized settings are automatically recalled.

You can memorize details for the following six settings.

- Last Stop Position (Page 21)**
- TV Aspect (Page 40)**
- Disc Subtitle Language (Page 28, 37)**
- Disc Audio Language (Page 28, 37)**
- Disc Menu Language (Page 37)**
- Angle (Page 29)**

Load the DVD that was memorized.

It will appear on the TV screen as below

- If the screen is left for more than 10 seconds, playback will start from the beginning of the title automatically.

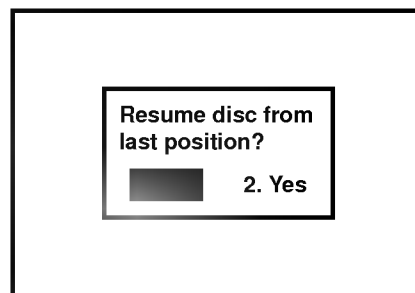
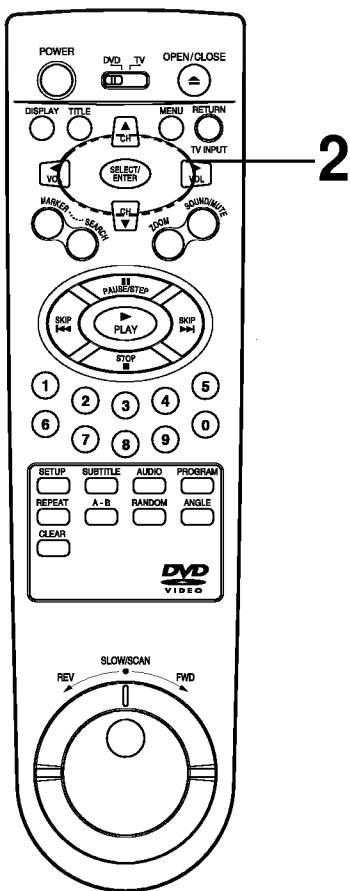

Press ◀▶ to select "Yes" and press SELECT/ENTER.

The memorized settings are automatically recalled.

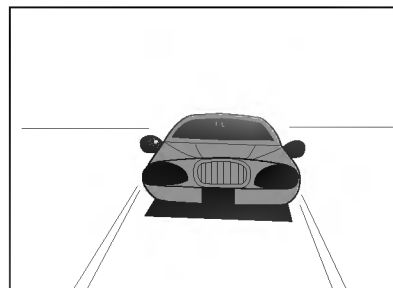

- Settings are stored in memory for use any time.
- You can store settings for up to 1 DVD in memory. If you memorize settings for more than 1 DVD previously memorized settings are erased in order from the last recently memorized settings. Subsequently, if you try to call up these previously memorized settings, you will get the latest settings that have taken their place.
- Switching of the audio mode etc., is automatic on some discs.
- This unit does not store settings in memory, if you remove the disc from the player or switch power to the player OFF when DVD or title menu is displayed on the TV screen.



It is possible to change the subtitle language to a different language from the one selected at the initial settings. (See page 37 for further info.)

This operation works only with discs on which multiple subtitle languages are recorded.

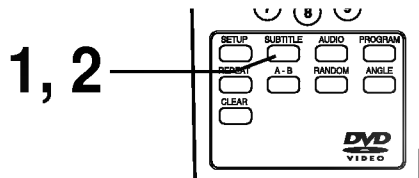

- In some cases, the subtitle language is not changed to the selected one immediately.
- When a disc supporting the closed caption is played, the subtitle and the closed caption may overlap each other on the TV screen. In this case, turn the subtitle off.
- When the desired language is not selected even after pressing the button several times, it means that the language is not available on the disc.
- When the power is turned on or the disc is removed, subtitles appears in the language selected at the initial settings. If this language is not recorded on the disc, the disc's priority language appears.

Press SUBTITLE during playback.

When no subtitles are recorded, "OFF" will be displayed instead of the language number.



Press SUBTITLE repeatedly until the desired language is selected.

Number of the subtitle language being played back is shown.



To eliminate the On Screen Subtitles.

Press SUBTITLE repeatedly to select OFF at step 2.

It is possible to change the audio soundtrack language (or encoding method, channel number) to a different language from the one selected at the initial settings in case of DVD disc. (See page 37 for further info.) This operation works only with discs on which multiple audio soundtrack languages are recorded.

And it is possible to change the audio channel in case of audio CD.

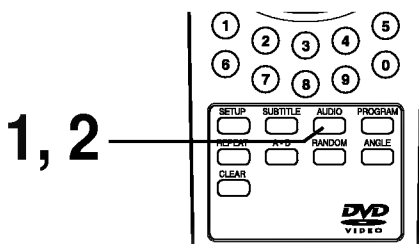

- When the desired language is not selected even after pressing the button several times, it means that the language is not available on the disc.
- When the power is turned on or the disc is removed, the language heard is the one selected at the initial settings. If this language is not recorded on the disc, only the available language on the disc will be heard.
- Some discs may not respond to Audio feature.

• DVD

Press AUDIO during play.

Number of the audio soundtrack language being played back.



Press AUDIO repeatedly until the desired language (or encoding method, channel number) is selected.



• CD

Press AUDIO during play.



Press AUDIO repeatedly until the desired sound is selected.





Some DVDs may contain scenes which have been shot simultaneously from a number of different angles. For these discs, the same scene can be viewed from each of these different angles using the ANGLE button. (The recorded angles differ depending on the disc used.)

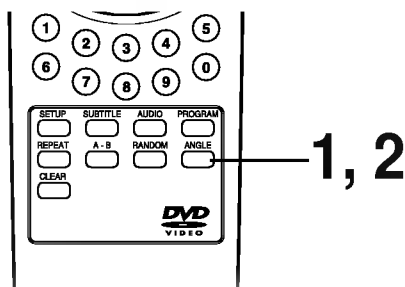
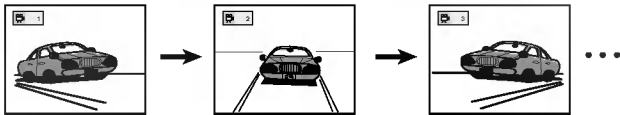

Press ANGLE during playback.

Number of angle being played back.



Press ANGLE repeatedly until the desired angle is selected.



For your reference

- The ANGLE indicator will blink in the DVD display window at scenes recorded at different angles to indicate that angle switching is possible.
- The angle number can be programmed beforehand; the angle will be switched to the selected number when the ANGLE indicator blinks.

- This function only works for discs having scenes recorded at different angles.



This unit can produce a 3D Surround effect, using 3D Surround Sound technology, which simulates multi-channel audio playback from two conventional stereo speakers instead of the five or more speakers normally required to listen to multi-channel audio from a home theatre. This feature works with DVD discs encoded with Dolby Pro Logic and Dolby Digital audio tracks.

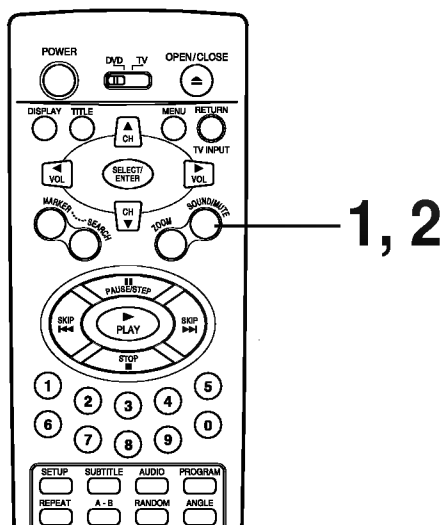

Press SOUND during playback.

Each time this button is pressed, the TV screen display changes.



Press SOUND repeatedly until the desired sound is selected.

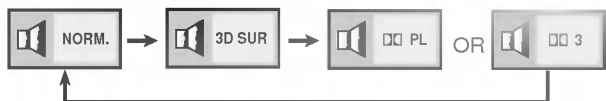

- This 3D Surround effect may not be available on some DVD discs, such as those recorded with a mono audio soundtrack.
- Turn off the TV surround sound and other surround effects when using this 3D surround effect.
- For best 3D Surround effect using only two speakers it is recommended that the two speakers be positioned approximately 8' to 10' apart, and the listening position should be 8' to 10' away from the speakers.
- Dolby Pro Logic or Dolby 3 Stereo will only display during playback a disc with 2 channel audio format.
- Dolby 3 Stereo will display when you select the rear speaker to None mode in the 5.1 Speaker Setup menu.



Repeating viewing (listening)

Press **REPEAT** during playback.

Each time this button is pressed, the TV screen changes as shown below and the disc will repeat a chapter or title (DVD) or a track (CD).

• DVD

Repeat of chapter being played



Repeat of title being played



Cancel repeat mode (normal play)



• CD

Repeat of track being played



Repeat of entire disc contents



Cancel repeat mode (normal play)



To enjoy program repeat play (CD only)

If **REPEAT** is pressed during program play, repeat play is operated as below.

Repeat of the current programmed track



Repeat of all programs



Cancel repeat mode (Program play)



To return to normal play

Press **REPEAT** several times until "OFF" is displayed.

Repeating sections between two specific points (A-B repeat)

Press **A-B** during play at the point where repeat play is to start (A).



- You can select "OFF" at this step by pressing **CLEAR**.

Press **A-B** during play at the point where repeat play is to be concluded (B).



Repeat play of the selection between points A and B starts.

To return to normal play

Press **A-B** once "OFF" is displayed.



- Repeat play works only with discs for which the elapsed playing time appears in the DVD display window during playback.
- Repeat play may not work correctly with some DVDs.
- A-B repeat play works only within a title DVD or a track CD.
- Some subtitles recorded around point A or B may fail to appear (DVD).



Storing a MARKER in the DVD memory is similar to marking your page in a book. It allows you to quickly return to any point on the disc.

Storing a marker in the memory

- Press **MARKER** during play at the starting point to be viewed (listened to) again.



Indicates "1/5" is stored in the memory. Up to 5 markers can be stored in the memory.

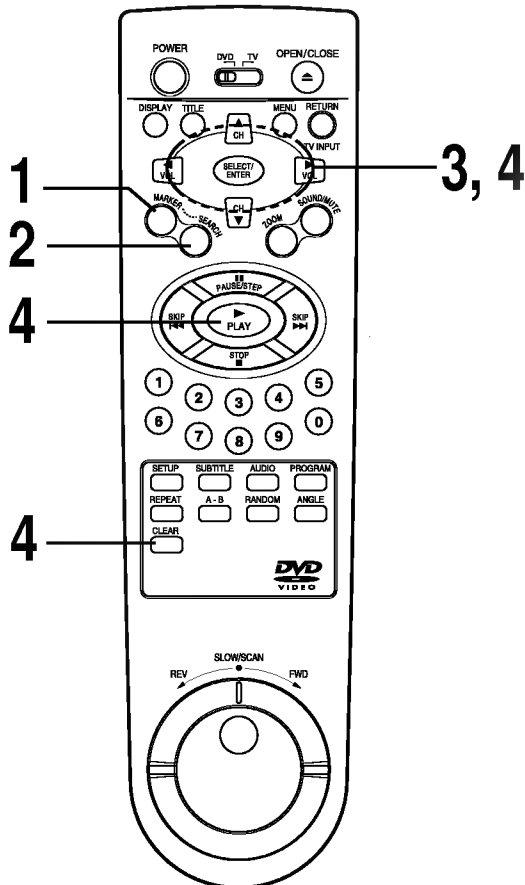

Recalling/Clearing a marker

- Press **SEARCH** during playback.

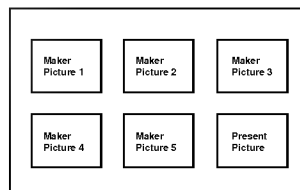

- Press **▲/▼/◀/▶** to select the marker to be recalled/cleared.
- Press **PLAY** or **SELECT/ENTER** to recall a marker. Or press **CLEAR** to clear a marker.

Play resumes from the point corresponding to the selected marker, or the selected marker is cleared.

- The "Present Picture" is not cleared.

- These operations work only with discs for which the elapsed playing time appears in the DVD display window during playback or stop.
- Some subtitles recorded around the marker may fail to appear (DVD).
- All the markers are cleared when the power is turned off or the disc is removed and when TV Aspect mode is changed on the SETUP menu.
- The marker is not stored when the DVD or title menu is displayed on the TV screen.



The Zoom feature allows you to “ZOOM-IN” and enlarge the picture on the screen to either 4 times (X4) or 16 times (X16) its normal size.

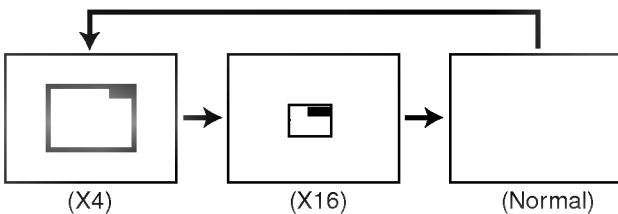
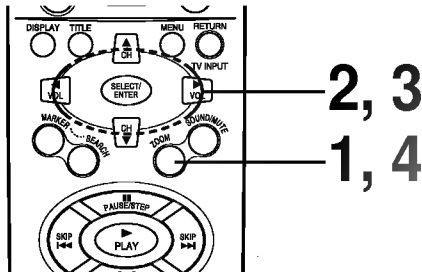

Press ZOOM during normal playback or still playback.

- The square frame will be displayed in the centre of the picture. If no button is pressed for more than 10 seconds, the square frame will disappear.
- Each press of the ZOOM button changes the TV screen in the left sequence.
- The magnification level will be displayed in the upper right corner of the zoom area.

If you press ▲/▼/◀/▶ buttons, the zoom point shifts.

Press SELECT/ENTER.

The selected frame is displayed in full size on the TV screen.

To resume normal playback.

Press ZOOM repeatedly until the normal picture appears.

- Some discs may not respond to the Zoom feature.
- Zoom does not work on subtitles or menus included on DVD video discs.



Note: This function only works with karaoke DVD and with audio CD discs. Random does not work with DVD movies.

You can playback titles or tracks in random order. (Random playback)

The DVD player automatically selects the titles on a DVD video karaoke disc only and plays them back randomly.

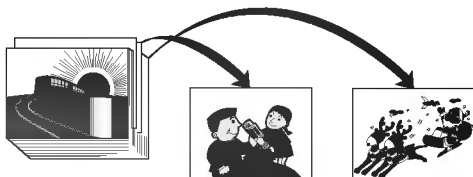
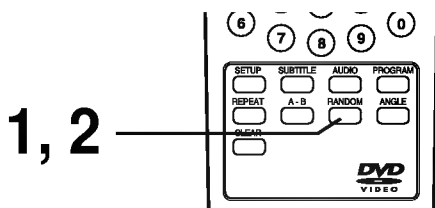

Random play (Karaoke DVD or CD)

Press RANDOM during normal playback or stop mode.

The DVD player automatically starts random playback and the RANDOM indicator in the DVD display window appears.

To resume normal playback, press RANDOM.

The RANDOM indicator in the DVD display window disappears.

- Random playback may not be possible on certain discs.
- If you press the SKIP ◀◀ or ▶▶ button during random playback, the DVD player goes to another track randomly and starts playback.



The player plays the tracks on the disc in the order you specify.

Note: Program play function is possible only with audio CDs. It does not work with DVD movie discs.

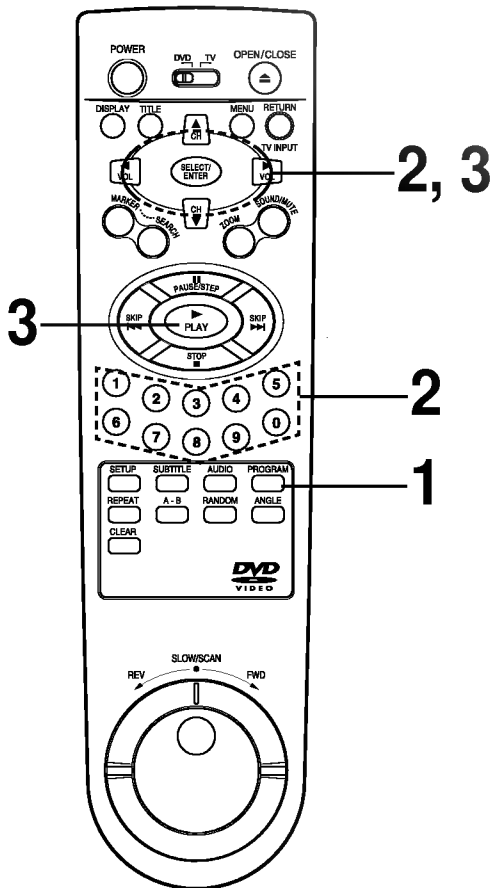

Press PROGRAM during playback or stop mode.

The program playback screen appears on the TV screen.

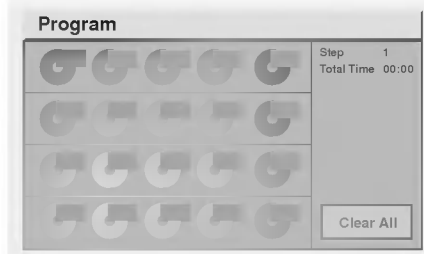

• To exit the screen, press PLAY or PROGRAM.

Press ▲/▼/◀/▶ and press the numeric button(s), to select the desired track number.

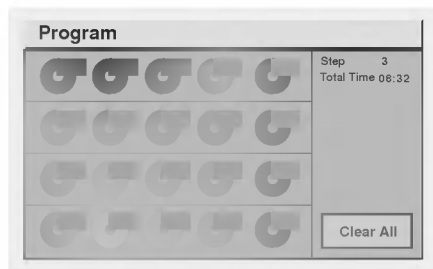

- Repeat step 2 to select another track.
- Up to 20 tracks can be programmed.

Press PLAY or SELECT/ENTER to exit the screen.

The selected track is stored in the memory and play now begins in the programmed sequence.

- If you press PROGRAM to exit the screen, the selected tracks are not memorized.

After playback of all tracks programmed

Play is stopped.

Clearing the program

● To clear the programmed tracks one by one

Press ▲/▼/◀/▶ to select the unwanted number and then press CLEAR.

● To clear all the programmed tracks

Press ▲/▼/◀/▶ to select "Clear All" and then press SELECT/ENTER. Press PLAY or SELECT/ENTER to exit the screen. If you press PROGRAM to exit the screen, the programs are not cleared. (The programs are also cleared when the power is turned off or the disc is removed.)

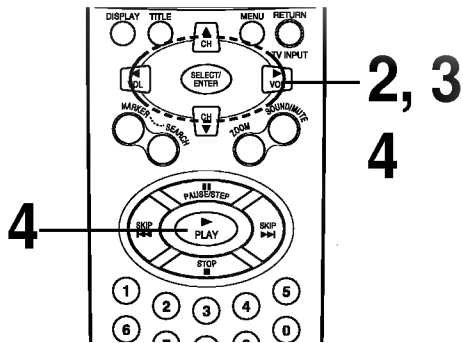

To play an MP3 file

- Load an MP3 disc.
The MP3 menu is displayed.

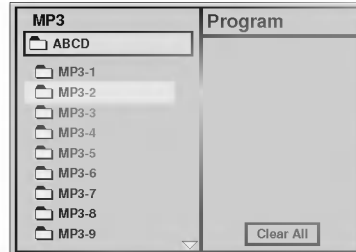

- Press ▲/▼ buttons to select the directory where MP3 files that you want to play are located and then press SELECT/ENTER.

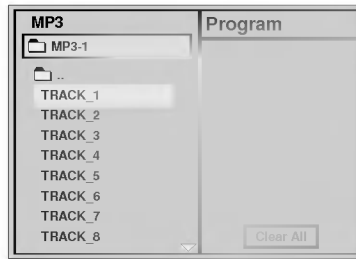

- Press ▲/▼ button to select the desired MP3 file of the selected directory on your disc.

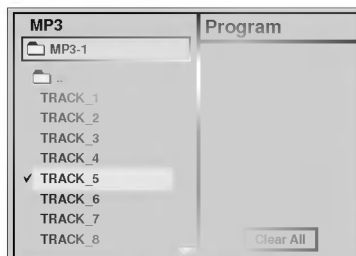

If you want to return to the previous menu, press the RETURN button.

- Press SELECT/ENTER or PLAY to start playback of the file.

For your reference

- Press SKIP ►► or SKIP ◀◀ to play the next file or previous file during playback.
- Press TITLE to move to 1st page of current directory during playback and press TITLE again to move to the next page within 5 seconds.
- Press MENU to move to the Root Directory during playback.

To play an MP3 file repeatedly

- If you press REPEAT button once during play, the current MP3 file will play repeatedly.
- If you press REPEAT button twice during play, the directory will play repeatedly.
- If you press REPEAT button three times, the repeat play will be cancelled.

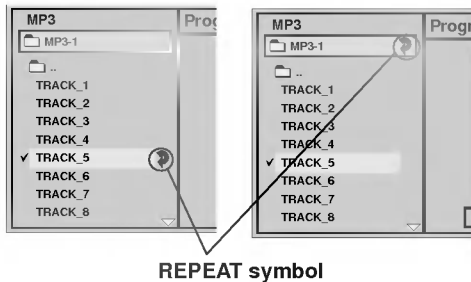

REPEAT symbol

- The directory and file name is only displayed in English.
- If there is an impossible code to display, it will be displayed underlined () instead of English.
- If a directory has no MP3 file, the "⊘" is displayed with the directory name.
- This unit can play up to 256 files per disc. A disc recorded with more than 256 files cannot be played.
- The maximum allowable depth of nested directory is 50.
- Disc format is compatible with ISO9660 only.
- If you record mp3 files using the software which cannot create a FILE SYSTEM, for example "Direct-CD" etc., it is impossible to playback mp3 files. We therefore recommend that you use "Easy-CD Creator", which creates an ISO9660 file system.
- A single session disc requires mp3 files in the first track. If there is no mp3 file in the 1st track, it cannot playback mp3 files. If you wish to playback mp3 files, format all the data in the disc or use a new one.
- If there are already data files which are not mp3 files on the CD-R disc, please, do not use that disc; use a new one instead. However, if the disc is a CD-RW disc, this does not apply.
- If you select another file by pressing ▲/▼ during playback, the file is played after 5 seconds automatically.
- If you select a directory by pressing ▲/▼ during playback, the playback is stopped after 5 seconds.

MP3

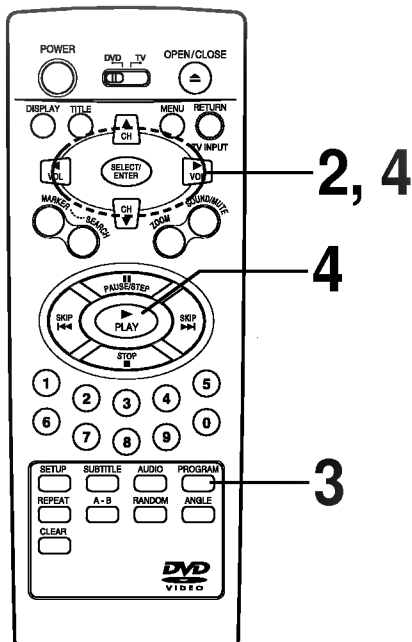

To program play an MP3 file

- Follow steps 1 to 2 on previous page.
- Select an MP3 file to program with ▲/▼.

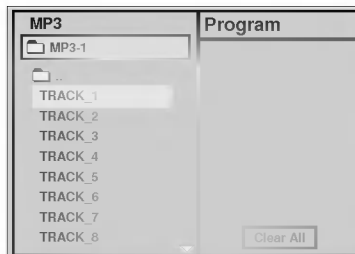

- Press PROGRAM button to add an MP3 file to the program list.

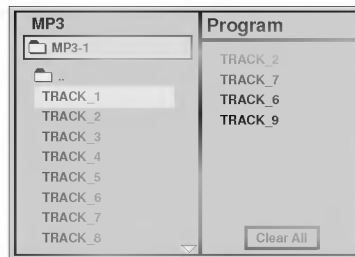

- Repeat steps 2 - 3 to select another track.
- Up to 60 files can be programmed.

- Press ► button and select the desired MP3 file and press SELECT/ENTER or PLAY button to play.

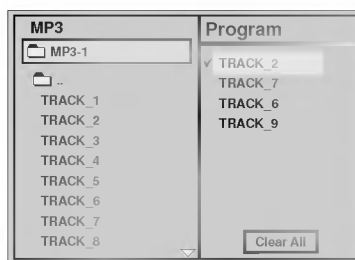

To play an MP3 file repeatedly

- If you press REPEAT button once during play, the current MP3 file will play repeatedly.
- If you press REPEAT button twice during play, the all MP3 files on the program list will play repeatedly.
- If you press REPEAT button three times, the repeat play will be cancelled.

REPEAT symbol

Clearing the program

- To clear the program one by one**
Press ▲/▼/◀/▶ to select the unwanted MP3 file on the program list and then press CLEAR.
- To clear all the programs**
Press ▲/▼/◀/▶ to select the "Clear All" and press SELECT/ENTER.

If you want to enter the main menu, press ◀ button.

After playback all tracks programmed

Play is stopped.



Once the initial settings have been completed, the player can always be operated under the same conditions (especially with DVD discs). The settings will be retained in the memory until they are changed, even if the power is switched off.

Selection of initial settings

Press SETUP in the stop or playback mode.
The SETUP menu is displayed.



Press ▲/▼ to select the desired item.
The screen will show the current setting for the selected item, and the alternate setting(s).

- Disc Audio (see page 37.)
- Disc Subtitle (see page 37.)
- Disc Menu (see page 37.)
- Rating (see page 38.)
- Password (see page 39.)
- TV Aspect (see page 40.)
- Menu Language (see page 41.)
- Digital Audio Output (see page 42.)
- 5.1 Speaker Setup (see page 43)
- Others (DRC/Vocal) (see page 44.)

Press ► and then ▲/▼ to select the desired setting and press SELECT/ENTER.
• Some items require additional steps. (See the respective page.)

When the alternate setting is selected the screen returns to the Initial Settings display.

To exit SETUP menu
Press SETUP, RETURN or PLAY.

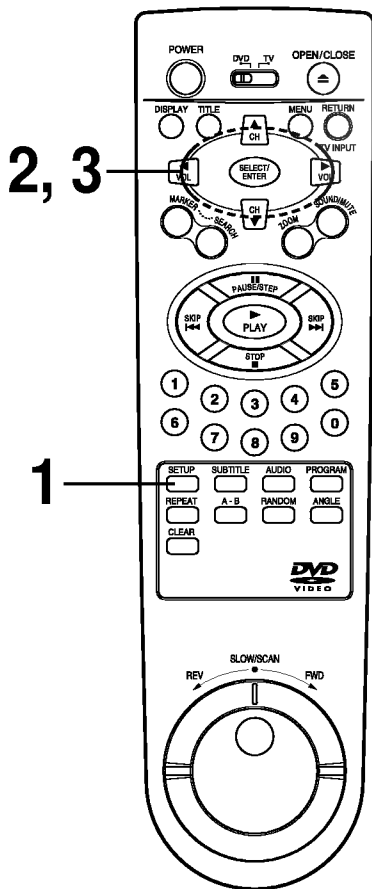



This is to select the audio soundtrack language, subtitle language and the language used in title menus or DVD menus which will always be used for every disc to be played back.

When you play back a DVD video disc, the DVD player automatically displays the pre-selected subtitle language if it is included on the disc.

At the setup screen, press ▲/▼ to select “Disc Audio” and press ►.



Press ▲/▼ to select the desired language and then press SELECT/ENTER.



- Original** :The original language of each disc will be selected.
- English** :The English will be Selected.
- Other** : Another language can be selected. You can input 4-digit language code. (Refer to the language codes on page 45. Press CLEAR if an incorrect language code is entered.)

The “Disc Subtitle” and “Disc Menu” are selected by the same method.

- If the language selected is not available on the disc, the original language designated by each disc will be selected.



This is to prohibit the playing of specified DVDs which are unsuitable for children.

- Some DVD discs contain a restriction level which enables parents to remove scenes or prevent playback of discs by children. DVD players are equipped with a password designed to prevent children from changing the level.

Selecting rating level (DVD only)

At the SETUP screen, press ▲/▼ to select “Rating” and press ►.

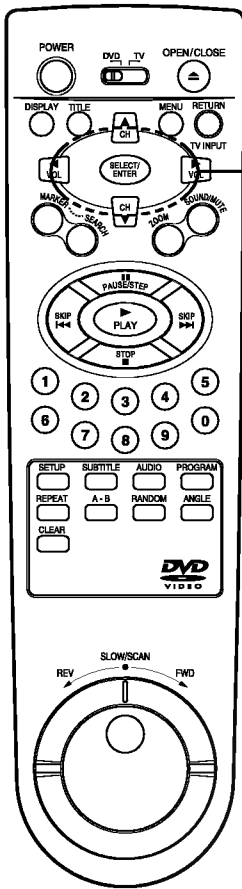
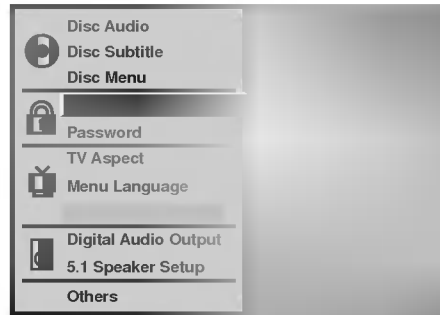

1, 2

Press ▲/▼ to select the desired level and press SELECT/ENTER.



You cannot play DVD video discs rated higher than the level you selected unless you cancel the parental lock function. For example, when you select level 7, discs rated higher than level 7 are blocked and cannot be played.

If you change the level and enter a password, playback of all DVDs with ratings higher than your selection will be blocked, unless the correct password is entered again. For example: if you change the level to “5”, the DVD player will not play discs with ratings of “6”, “7” or “8” unless the correct password is entered on the remote control.

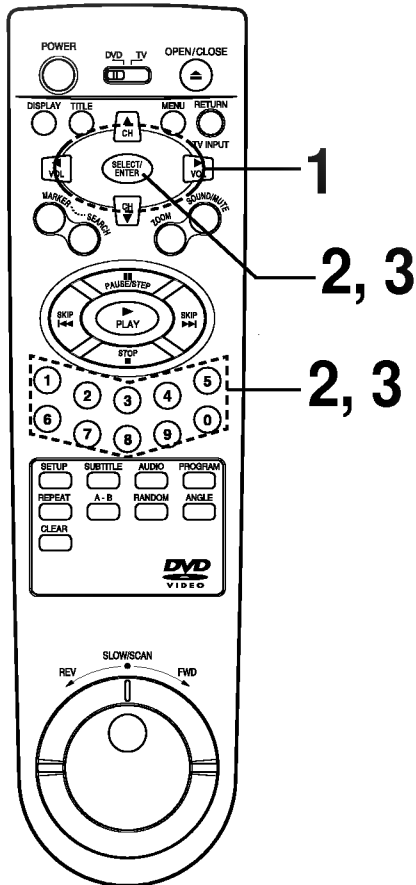

Setting your password (DVD only)

If you change the rating level to "7" or lower, you must enter a 4-digit "password" to prevent playback of discs with higher ratings.

At the **SETUP** screen, press **▼** to select "Password" and press **▶**.



Input a 4-digit password and press **SELECT/ENTER**.

Example : 1234

Do not forget your password.

Input the 4-digit password again and press **SELECT/ENTER** to verify.

Setting is finished.

- The rating is locked. Any disc whose rating is higher than the setting, cannot be played back unless the correct password is entered.

To change/clear memorized password

At the **SETUP** screen, press **▼** to select "Password" and press **▶**.

Input your password and press **SELECT/ENTER**.

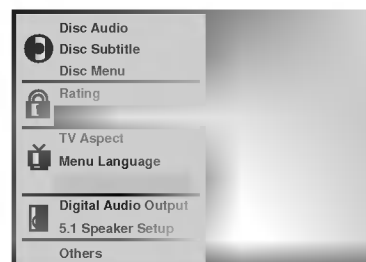

To change or clear your password, press **▲/▼** to select the "Change" or "Clear" and press **SELECT/ENTER**.

To change the rating level/password, follow the steps on page 38-39 again.

To clear your 4-digit password

If you forget your password, to clear the current password, follow the procedure below.

At the **SETUP** screen

1 Press **▼** to select "Password" item.

2 Enter 6-digit number "210499" and then press **SELECT/ENTER**.

The 4-digit password is cleared.

3 Enter a new password

Refer to "Setting your password" section on the right.



Select the appropriate screen type according to your TV set; conventional size screen (4:3) or wide-screen (16:9).

At the **SETUP** screen, press ▲/▼ to select “**TV Aspect**” and press ►.

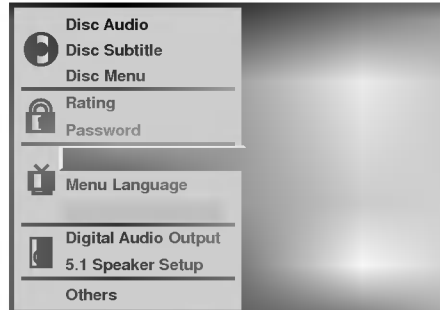
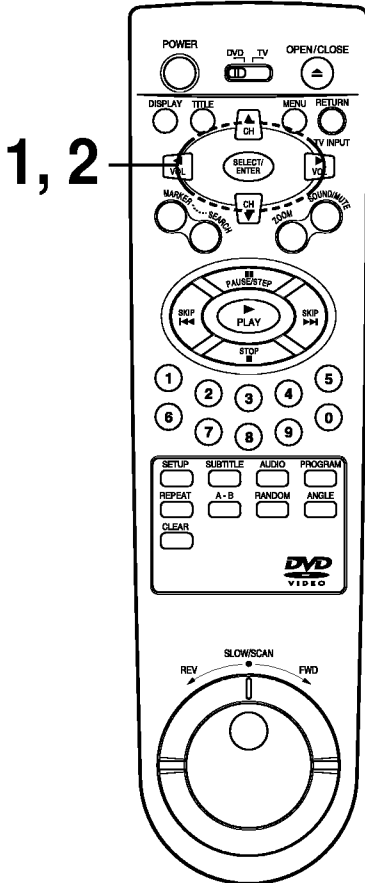

Press ▲/▼ to select the desired **Aspect** and press **SELECT/ENTER**.

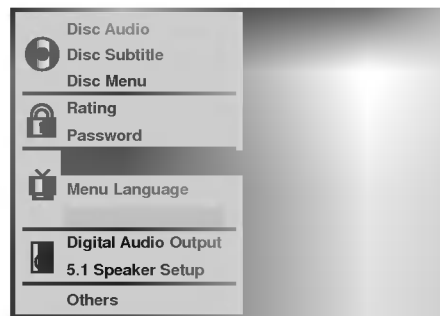

4:3 Letterbox : The video material not formatted in the Pan & Scan style is played back in the letterbox style (black bands appear at top and bottom of screen).

4:3 Panscan : Select when a conventional TV set is connected. The video material formatted in the Pan & Scan style is played back in that style (the left and right edges are cut off).

16:9 Wide : Select when a wide-screen TV set is connected. Played in “FULL” size. (Setting the wide-screen TV to “FULL” mode is also necessary.)

* Each screen shows an example when the video material for a wide-screen is played. (This setting does not affect the video material for conventional size.)



4:3 Letterbox

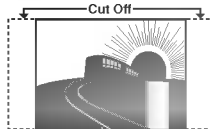

4:3 Panscan

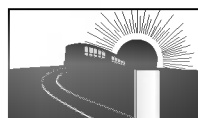

16:9 Wide



Selects language for SETUP menus and displays on the TV.

At the SETUP screen, press ▲/▼ to select “Menu Language” and press ►.

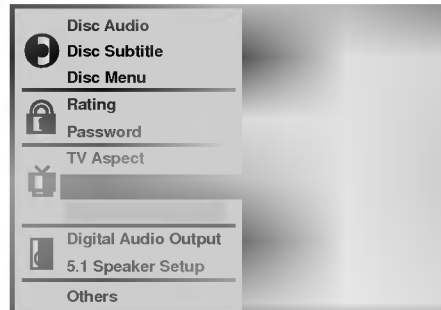
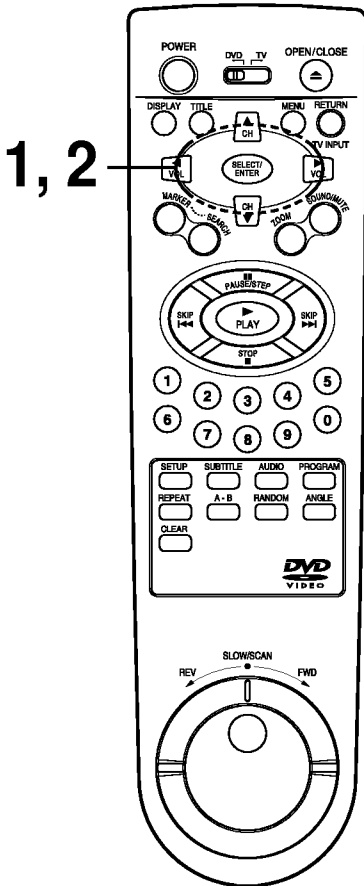

Press ▲/▼ to select the desired Language and press SELECT/ENTER.





Each DVD disc has a variety of audio output options. Set the player's Digital Audio Output according to the type of audio system you use.

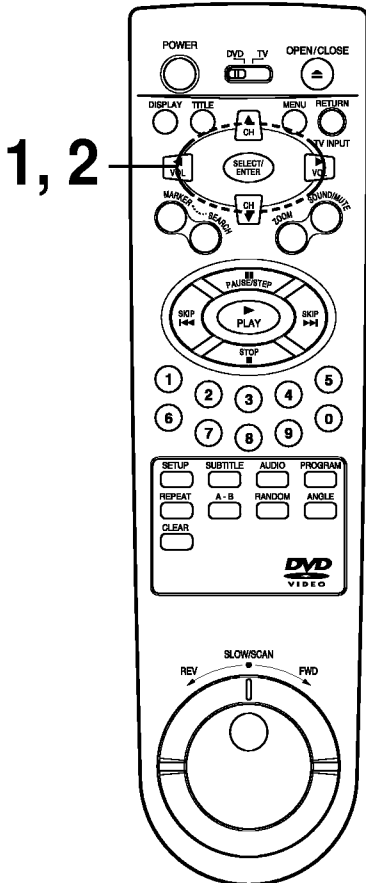

At the SETUP screen, press ▲/▼ to select Digital Audio Output and press ►.



Press ▲/▼ to select the desired output and press SELECT/ENTER.



DOLBY DIGITAL/PCM: Select "DOLBY DIGITAL/PCM" if an active digital output is supplied to a Dolby Digital decoder, (or an amplifier or other equipment with Dolby Digital decoder).

Stream/PCM: Select "Stream/PCM" if an active digital output is supplied to an amplifier or other equipment with DTS decoder, Dolby Digital decoder and MPEG decoder.

PCM: Select "PCM" if an active digital output is supplied to an amplifier or other equipment with linear PCM only (or MD recorder or DAT deck).

Playback Disc	OUTPUT		
	Stream/PCM	Dolby Digital/PCM	PCM only
96 kHz Linear PCM DVD	PCM	PCM	PCM
DTS DVD	DTS bit Stream	Not Output	Not Output
Dolby Digital DVD	Dolby Digital bit Stream	Dolby Digital bit Stream	PCM
MPEG DVD	MPEG bit Stream	PCM	PCM
Audio CD	PCM	PCM	PCM
DTS Audio CD	DTS bit Stream	DTS bit Stream	DTS bit Stream

- When you are not using the player's digital audio output, don't select any of the options.
- If an active digital audio output signal is supplied to a receiver or other equipment without a corresponding digital decoding capability, a very loud noise may be produced which could permanently damage the speakers.
- The DTS DVD disc sound is played back only when the DVD player is connected to a receiver with a DTS decoder.



Select the speaker to adjust the audio output mode of the speaker.

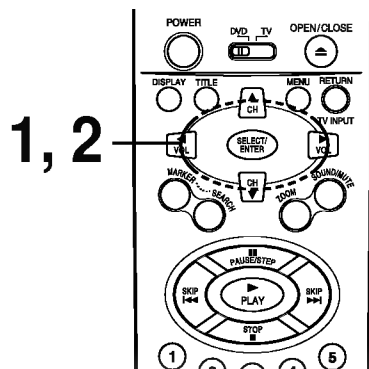

At the SETUP screen, press ▲/▼ to select “5.1 Speaker Setup” and press ►.

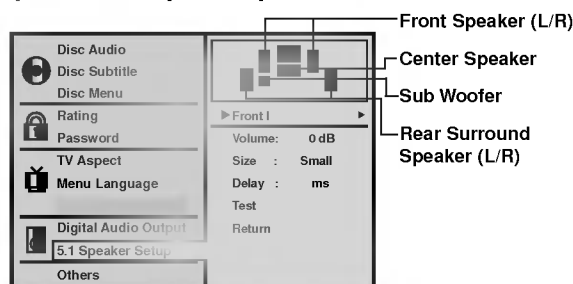

Press ◀/▶ to select the desired speaker and press ▲/▼/◀/▶ to adjust options.

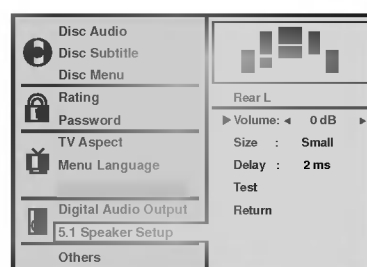

- Do not place the center or rear speakers farther away from the listening position than the front speakers.
- The test tone does not output from the subwoofer.

Volume: Press ◀/▶ to adjust the output level of selected speaker. (-6dB ~ 0dB)

Size: Press ◀/▶ to set a mode. (Large, Small, None)

- If you have connected the system to a speaker with low frequency of 100Hz or below, select “Large”
- If you have connected the system to a speaker without low frequency of 100Hz or below, select “Small” But if you haven’t connected to sub woofer, always select “Large” of Front Speaker (L/R).
- When you don’t connect to speaker, select “None”.
- Front L/R speaker’s size can be selected to Large” or “Small”.
- If Front L/R speaker’s size is selected to “Small”, Rear and Center speaker’s size can be selected to “Small” or “None”, and Sub woofer speaker’s size can be selected only to “Large”.

Delay: Press ◀/▶ to customize the sound to conform to the acoustics of your room by adding a delay effect to the sound of the Center Speaker and Surround Speaker.

- When 5.1CH Surround is played, you can enjoy the best sound if the distance between you and each speaker is same. You can set Delay time in the Center/Surround Speaker to customize the sound to the acoustic of your room.

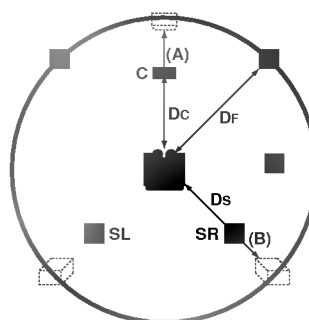

- **Setting Center Speaker**
If the distance of Dc is equal to or longer than the Df in the left figure, set the mode as 0ms. Otherwise, change the setting according to the table below.

(A) = $Df - Dc$

Distance of (A)(cm)	Setting(ms)
34	1
68	2
102	3
136	4
170	5

- **Setting Rear Surround Speaker**
If the distance of Df is equal to the distance of Ds in the above, set the mode as 0ms. Otherwise, change the setting according to the table below.

(B) = $Df - Ds$

Distance of (B)(cm)	Setting(ms)
170	5
340	10
510	15

Test : Press SELECT/ENTER to test signals of each speaker. Adjust Volume to match to the volume of test signals memorized in the system.

- Front (L) → Front (R) → Center → Rear (L) → Rear (R)

Return: Press SELECT/ENTER to return to the previous menu screen.



The DRC and Vocal settings can be changed.

At the SETUP screen, press ▲/▼ to select “Others” and press ►.

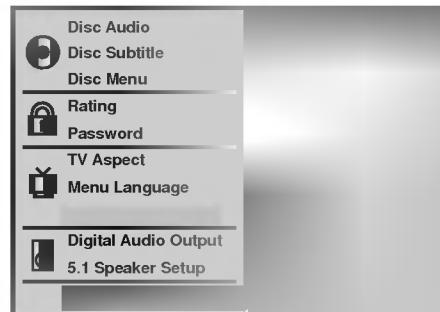
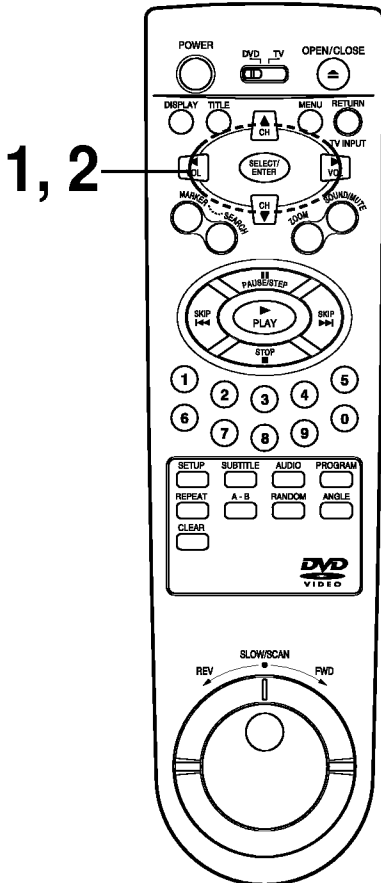

Press ▲/▼ to select the desired items and press SELECT/ENTER.

The setting of the selected item are changed between On and Off.

■ **DRC (Dynamic Range Compression) On/Off**

On: Select this option to turn on the Dynamic Range Compression circuitry so that the dialogue remains clear even at low volume levels.

Off: Select this option to turn off the Dynamic Range Compression and have the soundtrack presented exactly as it was created.

■ **Vocal On/Off**

Set to On only when a multi-channel karaoke DVD is being played. The karaoke channels on the disc will then be mixed into a normal stereo sound.

- The DRC function works only during playback of Dolby Digital recorded discs.
- The level of Dynamic Range Compression may differ depending on the DVD disc.
- When playing karaoke, connect appropriate audio equipment (such as an amplifier) to the DVD video player.

About DRC (Dynamic Range Compression)



With the DVD format you have the opportunity to hear a program’s soundtrack in the most accurate and realistic presentation possible, thanks to the use of digital audio technology. However, in certain instances you may wish to slightly compress the dynamic range of the audio output (the difference between the loudest sounds and the quietest ones) so that you may listen to a movie at a lower volume without losing dialogue intelligibility.



Enter the appropriate code number for the initial settings "Audio", "Subtitle" and/or "Menu" (See page 37).

Code	Language	Code	Language	Code	Language	Code	Language
6565	Afar	7079	Faroese	7678	Lingala	8375	Slovak
6566	Abkhazian	7082	French	7679	Laothian	8376	Slovenian
6570	Afrikaans	7089	Frisian	7684	Lithuanian	8377	Samoa
6577	Ameharic	7165	Irish	7686	Latvian, Lettish	8378	Shona
6582	Arabic	7168	Scots Gaelic	7771	Malagasy	8379	Somali
6583	Assamese	7176	Galician	7773	Maori	8381	Albanian
6588	Aymara	7178	Guarani	7775	Macedonian	8382	Serbian
6590	Azerbaijani	7185	Gujarati	7776	Malayalam	8385	Sundanese
6665	Bashkir	7265	Hausa	7778	Mongolian	8386	Swedish
6669	Byelorussian	7273	Hindi	7779	Moldavian	8387	Swahili
6671	Bulgarian	7282	Croatian	7782	Marathi	8465	Tamil
6672	Bihari	7285	Hungarian	7783	Malay	8469	Telugu
6678	Bengali; Bangla	7289	Armenian	7784	Maltese	8471	Tajik
6679	Tibetan	7365	Interlingua	7789	Burmese	8472	Thai
6682	Breton	7378	Indonesian	7865	Nauru	8473	Tigrinya
6765	Catalan	7383	Icelandic	7869	Nepali	8475	Turkmen
6779	Corsican	7384	Italian	7876	Dutch	8476	Tagalog
6783	Czech	7387	Hebrew	7879	Norwegian	8479	Tonga
6789	Welsh	7465	Japanese	7982	Oriya	8482	Turkish
6865	Danish	7473	Yiddish	8065	Panjabi	8484	Tatar
6869	German	7487	Javanese	8076	Polish	8487	Twi
6890	Bhutani	7565	Georgian	8083	Pashto, Pushto	8575	Ukrainian
6976	Greek	7575	Kazakh	8084	Portuguese	8582	Urdu
6978	English	7576	Greenlandic	8185	Quechua	8590	Uzbek
6979	Esperanto	7577	Cambodian	8277	Rhaeto-Romance	8673	Vietnamese
6983	Spanish	7578	Kannada	8279	Rumanian	8679	Volapük
6984	Estonian	7579	Korean	8285	Russian	8779	Wolof
6985	Basque	7583	Kashmiri	8365	Sanskrit	8872	Xhosa
7065	Persian	7585	Kurdish	8368	Sindhi	8979	Yoruba
7073	Finnish	7589	Kirghiz	8372	Serbo-Croatian	9072	Chinese
7074	Fiji	7665	Latin	8373	Singhalese	9085	Zulu

This DVD player can play back the following discs.

	Disc mark	Contents	Disc size	Maximum playback time
DVD video discs		Audio+Video (moving pictures)	12 cm	Approx. 4 hours (single sided disc)
				Approx. 8 hours (double sided disc)
			8 cm	Approx. 80 minutes (single sided disc)
				Approx. 160 minutes (double sided disc)
Audio CDs		Audio	12 cm	74 minutes
			8 cm	20 minutes

In addition, this unit can play back a CD-R or CD-RW that contains audio titles or MP3 files.

You cannot playback discs other than those listed above. (Video CD, CD-ROM, CD-Extra, CD-G, photo CD, and CD-i discs can not be played on this DVD player.)

This DVD player uses the NTSC color system, and cannot play back DVD video discs recorded in any other color system (PAL, SECAM, etc.)

Region Management Information: This DVD Player is designed and manufactured to respond to the Region Management Information that is recorded on a DVD disc. If the Region number described on the DVD disc does not correspond to the Region number of this DVD player, this DVD player cannot play that disc.

The Region number of this DVD player is 4.



You may not be able to play back some DVD video discs on this player if they were purchased from outside your geographic area or made for business purposes.

When you try to play back an unauthorized disc, "**Check Regional Code**" appears on the TV screen.

It is forbidden by law to copy, broadcast, show, broadcast on cable, play in public, and rent copyrighted material without permission.

DVD video discs are copy protected, and any recordings made from these discs will be distorted.

This product incorporates copyright protection technology that is protected by method claims of certain U.S. patents and other intellectual property rights owned by Macrovision Corporation and other rights owners. Use of this copyright protection technology must be authorized by Macrovision Corporation, and is intended for home and other limited viewing uses only, unless otherwise authorized by Macrovision Corporation. Reverse engineering or disassembly is prohibited.

Symptoms and Correction

Check the following guide for the possible cause of a problem before contacting service.

Symptom	Cause	Correction
No power.	<ul style="list-style-type: none"> • The power cord is disconnected. 	<ul style="list-style-type: none"> • Plug the power cord into the wall outlet securely.
The power is on, but the DVD player does not work.	<ul style="list-style-type: none"> • No disc is inserted. 	<ul style="list-style-type: none"> • Insert a disc. (Check that the DVD or, audio CD indicator in the DVD display is lit.)
No picture.	<ul style="list-style-type: none"> • The TV is not set to receive DVD signal output. 	<ul style="list-style-type: none"> • Select the appropriate video input mode on the TV so the picture from the DVD player appears on the TV screen.
	<ul style="list-style-type: none"> • The video cable is not connected securely. 	<ul style="list-style-type: none"> • Connect the video cable into the jacks securely.
	<ul style="list-style-type: none"> • The connected TV power is turned off. 	<ul style="list-style-type: none"> • Turn on the TV.
No sound.	<ul style="list-style-type: none"> • The equipment connected with the audio cable is not set to receive DVD signal output. 	<ul style="list-style-type: none"> • Select the correct input mode of the audio receiver so you can listen to the sound from the DVD player.
	<ul style="list-style-type: none"> • The audio cables are not connected securely. 	<ul style="list-style-type: none"> • Connect the audio cable into the jacks securely.
	<ul style="list-style-type: none"> • The power of the equipment connected with the audio cable is turned off. 	<ul style="list-style-type: none"> • Turn on the equipment connected with the audio cable.
	<ul style="list-style-type: none"> • The Digital Audio Output is set to the wrong position. 	<ul style="list-style-type: none"> • Set the Digital Audio Output to the correct position, then turn on the DVD player again by pressing the POWER button.
The playback picture is poor.	<ul style="list-style-type: none"> • The disc is dirty. 	<ul style="list-style-type: none"> • Clean the disc.
The DVD player does not start playback.	<ul style="list-style-type: none"> • No disc is inserted. 	<ul style="list-style-type: none"> • Insert a disc. (Check that the DVD, or audio CD indicator in the DVD display is lit.)
	<ul style="list-style-type: none"> • An unplayable disc is inserted. 	<ul style="list-style-type: none"> • Insert a playable disc. (Check the disc type, color system and Regional code.)
	<ul style="list-style-type: none"> • The disc is placed upside down. 	<ul style="list-style-type: none"> • Place the disc with the playback side down.
	<ul style="list-style-type: none"> • The disc is not placed within the guide. 	<ul style="list-style-type: none"> • Place the disc on the disc tray correctly inside the guide.
	<ul style="list-style-type: none"> • The disc is dirty. 	<ul style="list-style-type: none"> • Clean the disc.
	<ul style="list-style-type: none"> • A menu is on the TV screen. 	<ul style="list-style-type: none"> • Press the SETUP button to turn off the menu screen.
The remote control does not work properly.	<ul style="list-style-type: none"> • The remote control is not pointed at the remote sensor of the DVD player. 	<ul style="list-style-type: none"> • Point the remote control at the remote sensor of the DVD player.
	<ul style="list-style-type: none"> • The remote control is too far from the DVD player. 	<ul style="list-style-type: none"> • Operate the remote control within about 23 ft (7 m).
	<ul style="list-style-type: none"> • There is an obstacle in the path of the remote control and the DVD player. 	<ul style="list-style-type: none"> • Remove the obstacle.
	<ul style="list-style-type: none"> • The batteries in the remote control are exhausted. 	<ul style="list-style-type: none"> • Replace the batteries with new ones.

DVD player/Outputs/Supplied Accessories

[DVD player]	Power supply	AC 110-240V, 50/60Hz
	Power consumption	16 W
	Weight	6.6 lbs (3.0 kg)
	External dimensions (W X H X D)	17" X 3.5" X 9.7" (430 x 88 x 247 mm)
	Signal system	NTSC
	Laser	Semiconductor laser, wavelength 650 nm
	Frequency range (audio)	4 Hz to 20 kHz
	Signal-to-noise ratio (audio)	More than 100 dB (EIAJ)
	Dynamic range (audio)	More than 95 dB (EIAJ)
	Harmonic distortion (audio)	0.008 %
	Wow and flutter	Below measurable level (less than + 0.001 % (W.PEAK)) (EIAJ)
	Operating conditions	Temperature: 5°C to 35°C, Operation status: Horizontal
	[Outputs]	Video output
S-video output		(Y) 1.0 V (p-p), 75 Ω, negative sync., Mini DIN 4-pin x 1 (C) 0.286 V (p-p), 75 Ω
Component video output		(Y) 1.0 V (p-p), 75 Ω, negative sync., RCA jack x 1 (Pb)/(Pr) 0.7 V (p-p), 75 Ω
Audio output (digital audio)		0.5 V (p-p), 75 Ω, RCA jack x 1
Audio output (optical audio)		Optical connector x 1
Audio output (analog audio)		2.0 Vrms(1 KHz, 0 dB), 330 Ω, RCA jack (L, R) x 1
[Supplied Accessories]	● Video cable	1
	● Audio cable	1
	● Remote control.....	1
	● Batteries	2

* Designs and specifications are subject to change without notice.