





DVD Micro Home Cinema System OWNER'S MANUAL

MODEL : FFH-DV25AD
FE-DV25VE/FE-DV25TE



Before connecting, operating, or adjusting this unit,
please read this instruction booklet carefully and completely.

Precautions

	CAUTION RISK OF ELECTRIC SHOCK DO NOT OPEN	
CAUTION: TO REDUCE THE RISK OF ELECTRIC SHOCK DO NOT REMOVE COVER (OR BACK) NO USER SERVICEABLE PARTS INSIDE. REFER SERVICING TO QUALIFIED SERVICE PERSONNEL.		

Explanation Graphical Symbols:



The lightning flash with arrowhead symbol, within an equilateral triangle is intended to alert the user to the presence of uninsulated dangerous voltage within the product's enclosure that may be of sufficient magnitude to constitute a risk of electric shock to persons.



The exclamation point within an equilateral triangle is intended to alert the user to the presence of important operating and maintenance (servicing) instructions in the literature accompanying the appliance.

WARNING:

TO REDUCE THE RISK OF FIRE OF ELECTRIC SHOCK, DO NOT EXPOSE THIS APPLIANCE TO RAIN OR MOISTURE.

To avoid electrical shock, do not open the cabinet, Refer servicing to qualified personnel only.

The apparatus shall not be exposed to dripping or splashing and that no objects filled with liquids, such as vases, shall be placed on the apparatus.

<p>CAUTION Use of controls or adjustments or performance of procedures other than those specified herein may result in hazardous radiation exposure.</p>

<p>Laser component in this product is capable of emitting radiation exceeding the limit for Class 1.</p>
--

<p>CAUTION: INVISIBLE LASER RADIATION WHEN OPEN AND INTERLOCKS DEFEATED. AVOID EXPOSURE TO BEAM.</p>
<p>WARNING: OSYNLIG LASERSTRÅLNING NÄR DENNA DEL ÄR ÖPPNAD STRÅLEN ÄR FARLIG.</p>
<p>Attention: Quand l'appareil est ouvert, ne pas s'exposer aux radiations invisibles du faisceau laser.</p>

This label is located on the interior.

<p>CLASS 1 LASER PRODUCT KLASSE 1 LASER PRODUKT LUOKAN 1 LASER LAITE KLASS 1 LASER APPARAT CLASSE 1 PRODUIT LASER</p>
--

This Compact Disc player is classified as a CLASS 1 LASER product. The CLASS 1 LASER PRODUCT label is located on the exterior.

Table of Contents

Introduction

- Precautions 2
- Table of Contents. 3
- Notes on Discs 4
- Identification of Controls 5-8
 - Front Panel 5
 - Remote Control 6
 - Preparing the Remote Control 7
 - Operating with the Remote Control 7
 - Rear Panel/Display Window 8

Connections

- Antenna(Aerial) Connections 9
- Speaker System Connection 10
- Connecting to a TV/Monitor 11

Before Operation

- Setting the Clock 12
- Sleep Function. 12
- Timer Function. 13
- Audio Adjustment. 14
- Auxiliary Function. 14

Sound Operation

- Selecting a Sound mode 15
- Enjoying the Surround Effect 16
 - Constituent Elements. 16
 - Speaker Positioning 16

Radio Operation

- Presetting the radio stations. 17
- Listening to the radio 18
- Reception of RDS (Radio Data System) Stations 18

Cassette Deck Operation

- Tape Play. 19
- Recording 20

CD/DVD Operations

- Basic Playback 21-23
 - Stopping Play 23
 - Resume Play. 23
 - Still Picture 23
 - Frame Advance 23
 - Skipping chapters and tracks forward or back. . 23
- Special Playback 24
 - To Scan at fast forward or fast reverse playback 24
 - Playing in Slow-Motion. 24

Operation Using GUI Menu Icons

- General Information about GUI menu icons 25
- Detailed description of each GUI menu icon . . . 26

Advanced Operation

- Using a title menu/Using a DVD menu 27
- Memorizing Settings for Viewed DVDs (Last Condition Memory) 28
- Changing subtitle language 29
- Changing audio soundtrack language. 29
- Viewing from another angle 30
- Producing 3D SURROUND effect. 30
- Repeat Play. 31
- Storing markers in memory to be viewed (listened to) again 32
- Zoom Feature/Random Play 33
- Programme Play 34
- Playback with MP3 35-36

DVD Initial Settings

- Selection of initial settings 37
- Selecting disc Languages 38
- Selecting rating level and password 39-40
- Selecting TV Aspect. 41
- Selecting Menu Language 42
- Selecting Digital Audio Output 43
- Selecting Speaker 44
- Others (DRC/Pseudo PAL/Vocal) 45
- Table of Languages and Their Abbreviations . . . 46

Reference

- Disc Requirements/Copyright Information. 47
- Before Calling Service Personnel 48-49
- Specifications. 50

This section shows you how to handle, clean, and store discs.

On Handling Discs

- Do not touch the playback side of the disc.

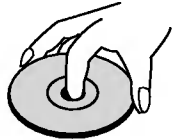

- Do not attach paper or tape to discs.



On Storing Discs

- Do not store discs in a place subject to direct sunlight or near heat sources.
- Do not store discs in places subject to moisture and dust such as a bathroom or near a humidifier.
- Store discs vertically in a case. Stacking or placing objects on discs outside of their case may cause may damage the discs.

On Cleaning Discs

- Fingerprints and dust on the disc cause picture and sound deterioration. Wipe the disc from the center outward with a soft cloth. Always keep the disc clean.
- If you cannot wipe off the dust with a soft cloth, wipe the disc lightly with a slightly moistened soft cloth and finish with a dry cloth.
- Do not use any type of solvents such as thinner, benzine, commercially available cleaners or anti-static spray for vinyl LPs. They may damage the disc.

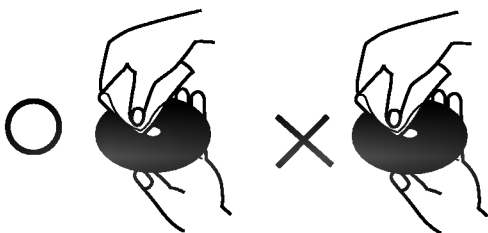

About This Owner's Manual

- This owner's manual explains the basic instructions of this unit.
- Some DVD video discs have functions that may not be explained in this owner's manual. Therefore, some instructions may differ from this owner's manual, and there may be extra instructions. In this case, follow the instructions displayed on the TV screen or package.
- "⊘" may appear on the TV screen during operation. This icon means the function explained in this owner's manual is not available on that specific DVD video disc.

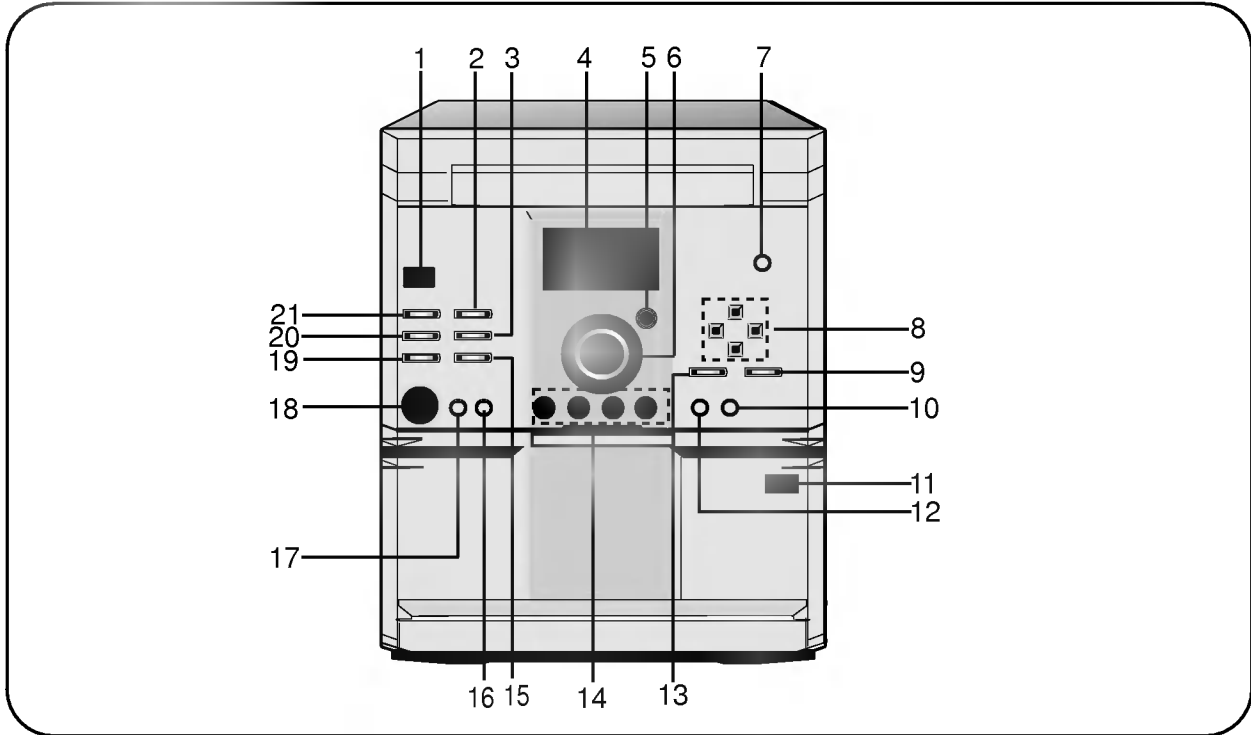

- | | |
|---|--|
| <ol style="list-style-type: none"> 1. STANDBY/ON BUTTON 2. SET/PAUSE/STEP/TAPE COUNTER/RDS BUTTON (OPTIONAL) 3. PLAY MODE BUTTON
EQ PATTERN BUTTON (OPTIONAL) 4. DISPLAY 5. REMOTE SENSOR 6. VOLUME 7. CD DOOR OPEN/CLOSE (▲) BUTTON 8. • TUNING (+)/(-) BUTTONS (RADIO) <ul style="list-style-type: none"> • SKIP/SEARCH(▶▶▶▶/◀◀◀◀) BUTTONS(CD/DVD) • REWIND/FAST FORWARD BUTTONS (TAPE) • ◀/▶=TAPE PLAY DIRECTION BUTTONS (◀: OPTIONAL) • PRESET (-)/(+) BUTTONS (RADIO) • CD PLAY BUTTON (▶) | <ol style="list-style-type: none"> 9. ENTER/SELECT BUTTON (DVD) 10. SET UP BUTTON 11. ▲ PUSH EJECT POSITION 12. STOP/RESET BUTTON 13. MENU BUTTON 14. FUNCTION SELECT BUTTON (TUNER/BAND, DVD/CD, TAPE, AUX) 15. PROG./MEMO. BUTTON 16. MDSS BUTTON 17. RECORD/RECORD PAUSE BUTTON (TAPE) 18. HEADPHONE SOCKET (3.5mm) 19. CD SYNCHRO/MODE/RIF BUTTON 20. TIMER BUTTON 21. CLOCK BUTTON |
|---|--|

You will find instructions for each of the remote control functions in the appropriate sections of this instruction manual.

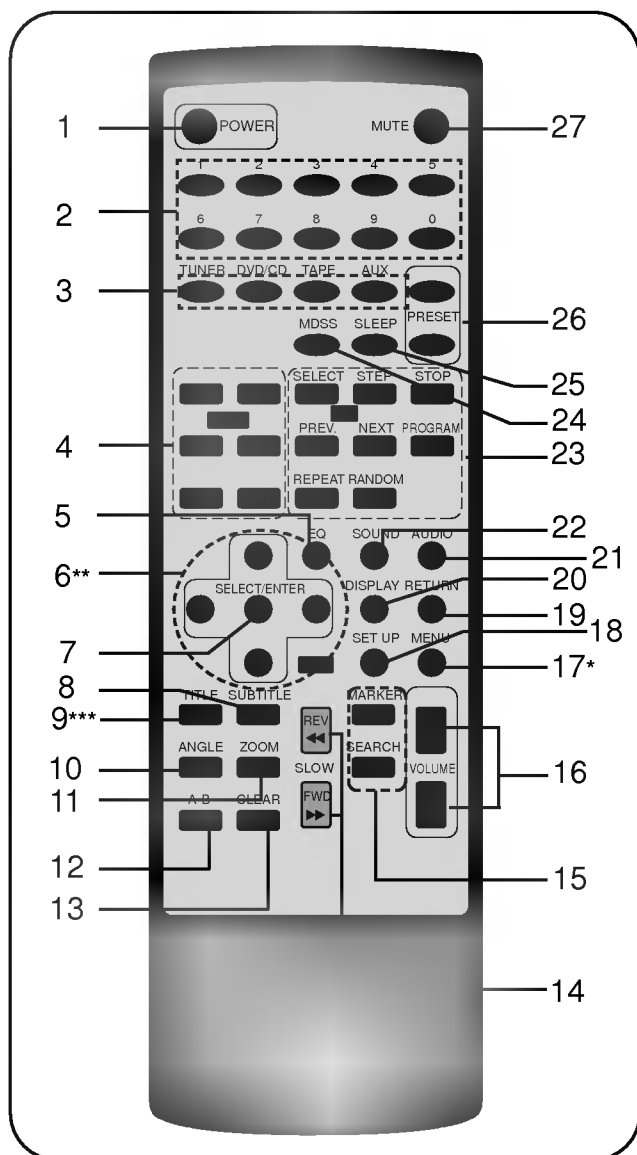

- 1. POWER button
- 2. NUMBER buttons
- 3. FUNCTION SELECT buttons
- 4. TAPE FUNCTION button
 - REWIND/FAST FORWARD PLAY
 - FORWARD PLAY
 - BACKWARD PLAY(OPTIONAL)
 - STOP
 - RECORD/RECORD PAUSE

- 5. EQ PATTERN button
- 6. ARROW buttons
- 7. SELECT/ENTER button
- 8. SUBTITLE button
- 9. TITLE button
- 10. ANGLE button
- 11. ZOOM button
- 12. REPEAT A-B button
- 13. CLEAR button
- 14. SLOW buttons
- 15. MARKER/SEARCH buttons
- 16. VOLUME +/- buttons
- 17. MENU button
- 18. SET UP button
- 19. RETURN button
- 20. DISPLAY button
- 21. AUDIO button
- 22. SOUND button
- 23. DVD/CD CONTROL buttons
 - PLAY/SELECT
 - PAUSE/STEP
 - STOP
 - SKIP/PREV.
 - SKIP/NEXT
 - PROGRAM
 - REPEAT
 - RANDOM
- SKIP** ◀▶▶▶
Press and hold button for about two seconds for search function.
- 24. MDSS button
- 25. SLEEP button
- 26. PRESET (▲/▼) buttons
- 27. MUTE button

*** MENU button**
Use the MENU button to display the menu screen included on DVD video discs. To operate a menu screen, follow the instructions in "Using a DVD Menu" (page 27).

**** Directional arrow buttons**
(up, down, left, right) for use in highlighting a selection on a GUI menu screen, TITLE and MENU screen.

*****TITLE button**
Use the TITLE button to display the title screen included on DVD video discs. To operate a menu screen, follow the instructions in "Using a Title Menu" (page 27).

Preparing the Remote Control

Insert the batteries into the remote control so you can use it to operate the unit.

Open the battery cover.

Insert batteries (AAA size).

- Make sure to match the + and - on the batteries to the marks inside the battery compartment.

Close the cover.

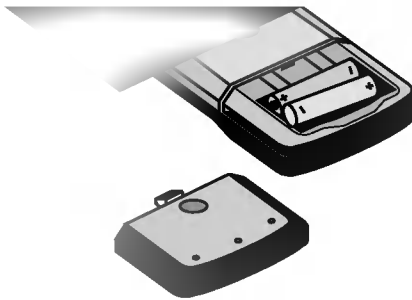

- Improper use of batteries may cause battery leakage and corrosion.
- To operate the remote control correctly, follow the instructions.
- Do not insert the batteries into the remote control in the wrong direction.
- Do not charge, heat, open, or short-circuit the batteries. Do not throw the batteries into fire.
- Do not leave dead or exhausted batteries in the remote control.
- Do not use different types of batteries together, or mix old and new batteries.
- If you do not use the remote control for a long period of time, remove the batteries to avoid possible damage from battery corrosion.
- If the remote control does not function correctly or if the operating range becomes reduced, replace all batteries with new ones.
- If battery leakage occurs, wipe the battery liquid from the battery compartment, then insert new batteries.
- The batteries should last about one year with normal use.

Operating with the Remote Control

This section shows you how to use the remote control.

Point the remote control at the remote sensor and press the buttons.

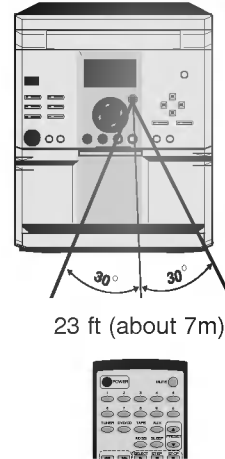

Distance: About 23 ft (7 m) from the front of the remote sensor

Angle: About 30° in each direction of the front of the remote sensor

- * Do not expose the remote sensor of the unit to a strong light source such as direct sunlight or illumination. If you do so, you may not be able to operate the unit with the remote control.

- Direct the remote control at the remote sensor of the unit.
- Do not drop the remote control.
- Do not leave the remote control near an extremely hot or humid place.
- Do not spill water or put anything wet on the remote control.
- Do not open the remote control.

Rear Panel

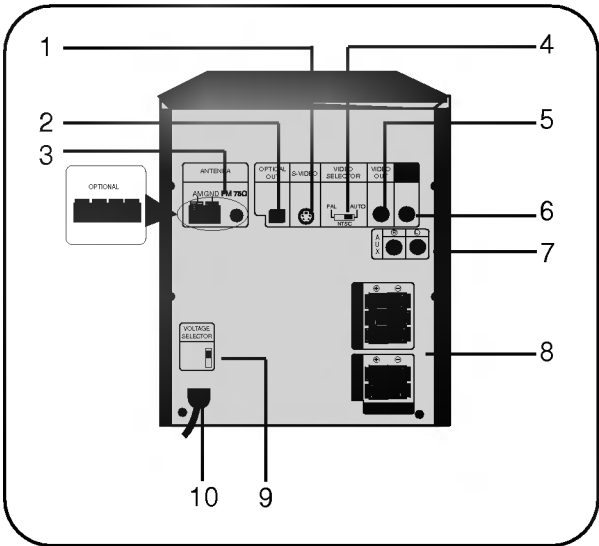

1. S-VIDEO OUT JACK
2. OPTICAL OUT JACK *
3. ANTENNA TERMINAL
4. VIDEO SELECTOR SWITCH **
5. VIDEO OUT JACK
6. SUB WOOFER OUT CONNECTOR
7. AUXILIARY INPUT SOCKETS
8. SPEAKER CONNECTORS
9. VOLTAGE SELECTOR(OPTIONAL)
10. POWER CORD

*** OPTICAL DIGITAL AUDIO OUT jack**
 Remove the dust protection cap from the connector and connect the optical digital cable (not supplied) firmly so that the configurations of both the cable and the connector match. Keep the dust protection cap and always reattach the cap when not using the connector to protect against dust.

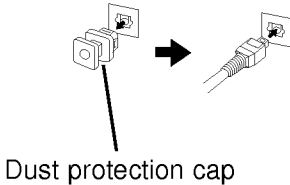

**** VIDEO SELECTOR SWITCH**
 You can enjoy NTSC or PAL discs by using your VIDEO SELECTOR switch to choose the appropriate system.

- If you try to play back PAL disc with NTSC-TV. The unit will not playback the disc.
- When the selected VIDEO SELECTOR switch does not coincide with the system of your TV, normal color picture may not be displayed.
- Adjust the VIDEO SELECTOR switch when the power is turned off.
- When you playback NTSC disc with PAL-TV, some discs may produce black bands at the top and bottom of the screen.

Position of VIDEO SELECTOR switch	Connected TV	Available disc
PAL	PAL	PAL DVD disc
NTSC	NTSC	NTSC DVD disc
AUTO	MULTI system TV	NTSC/PAL DVD disc

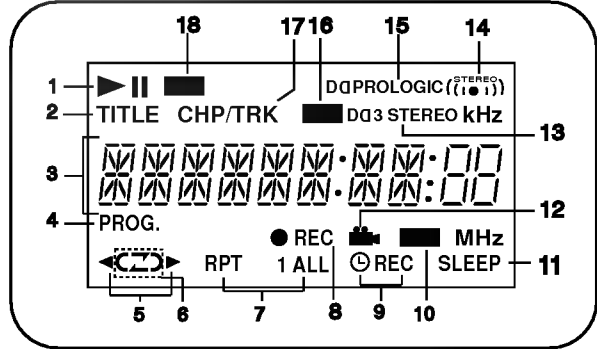

1. PLAY/PAUSE indicator
2. TITLE NUMBER indicator
3. FUNCTION, VOLUME LEVEL, CLOCK, FREQUENCY, TAPE COUNTER, CD PLAYING TIME, MDSS, EQ PATTERN display
4. PROGRAM indicator
5. PLAY DIRECTION indicator
6. PLAY MODE indicator (OPTIONAL)
7. CD REPEAT indicator
8. RECORD indicator
9. TIMER indicator
10. RDS indicator (OPTIONAL)
11. SLEEP indicator
12. ANGLE icon indicator
13. DOLBY 3 STEREO indicator
14. FM STEREO indicator
15. DOLBY PROLOGIC SURROUND indicator
16. MP3 indicator
17. CHAPTER/TRACK indicator
18. DVD indicator

Connect the supplied FM/AM antennas for listening to the radio.

- Connect the AM loop antenna to the AM antenna connector.
- Connect the FM wire antenna (or FM "T" antenna) to the FM 75Ω coaxial connector.

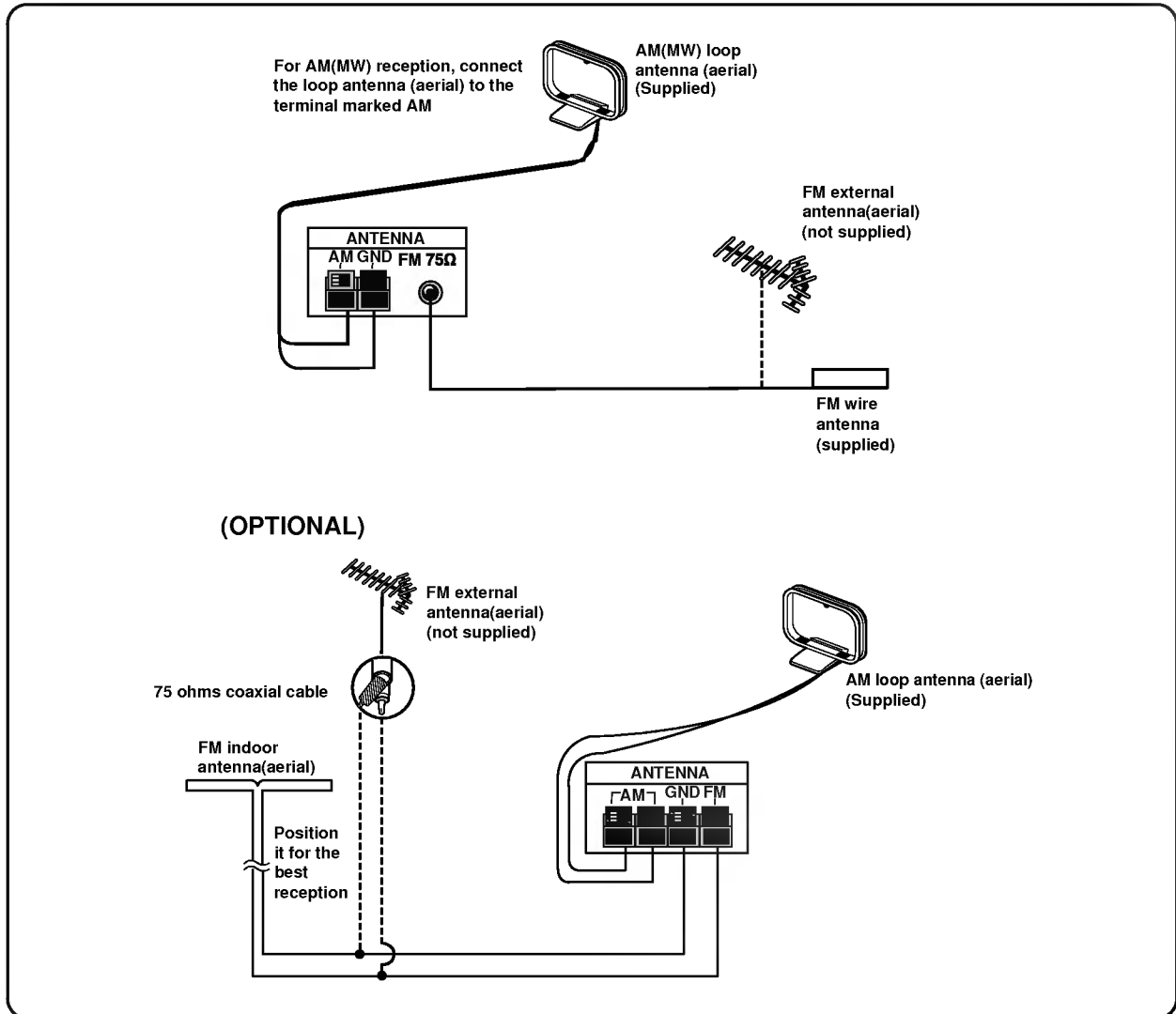

- To prevent noise pickup, keep the AM loop antenna away from the unit and other components.
- Be sure to fully extend the FM wire antenna.
- After connecting the FM wire antenna, keep it as horizontal as possible.

Connect the speakers using the supplied speaker cords by matching the colors of the terminals and those of the cords. To obtain the best possible surround sound, adjust the speaker parameters (distance, level, etc.).

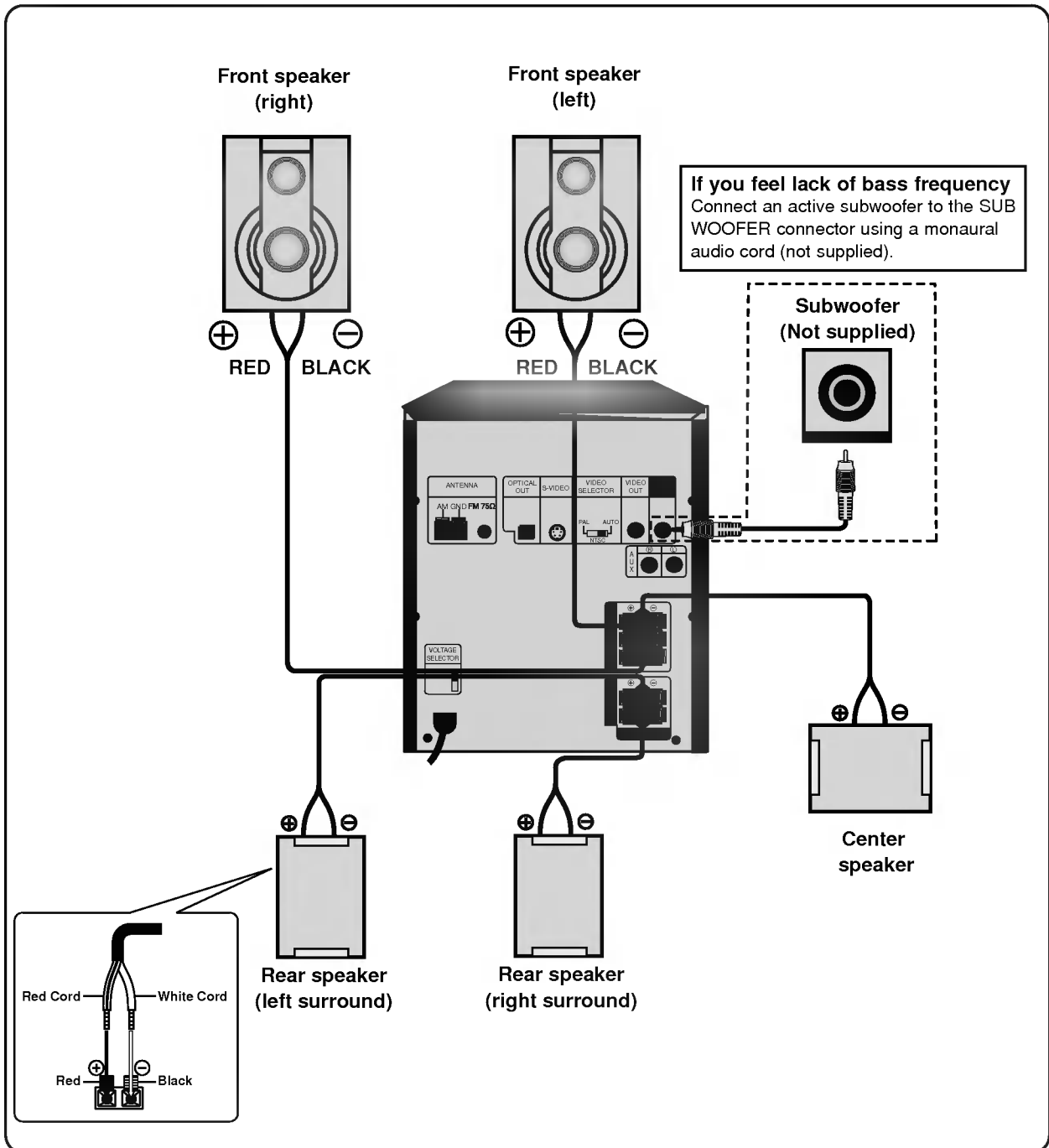

- Be sure to match the speaker cord to the appropriate terminal on the components: + to + and – to –. If the cords are reversed, the sound will be distorted and will lack base.
- If you use front speakers with low maximum input rating, adjust the volume carefully to avoid excessive output on the speakers.
- Do not disassemble the front cover of supplied speaker.

Connect the unit to your TV.

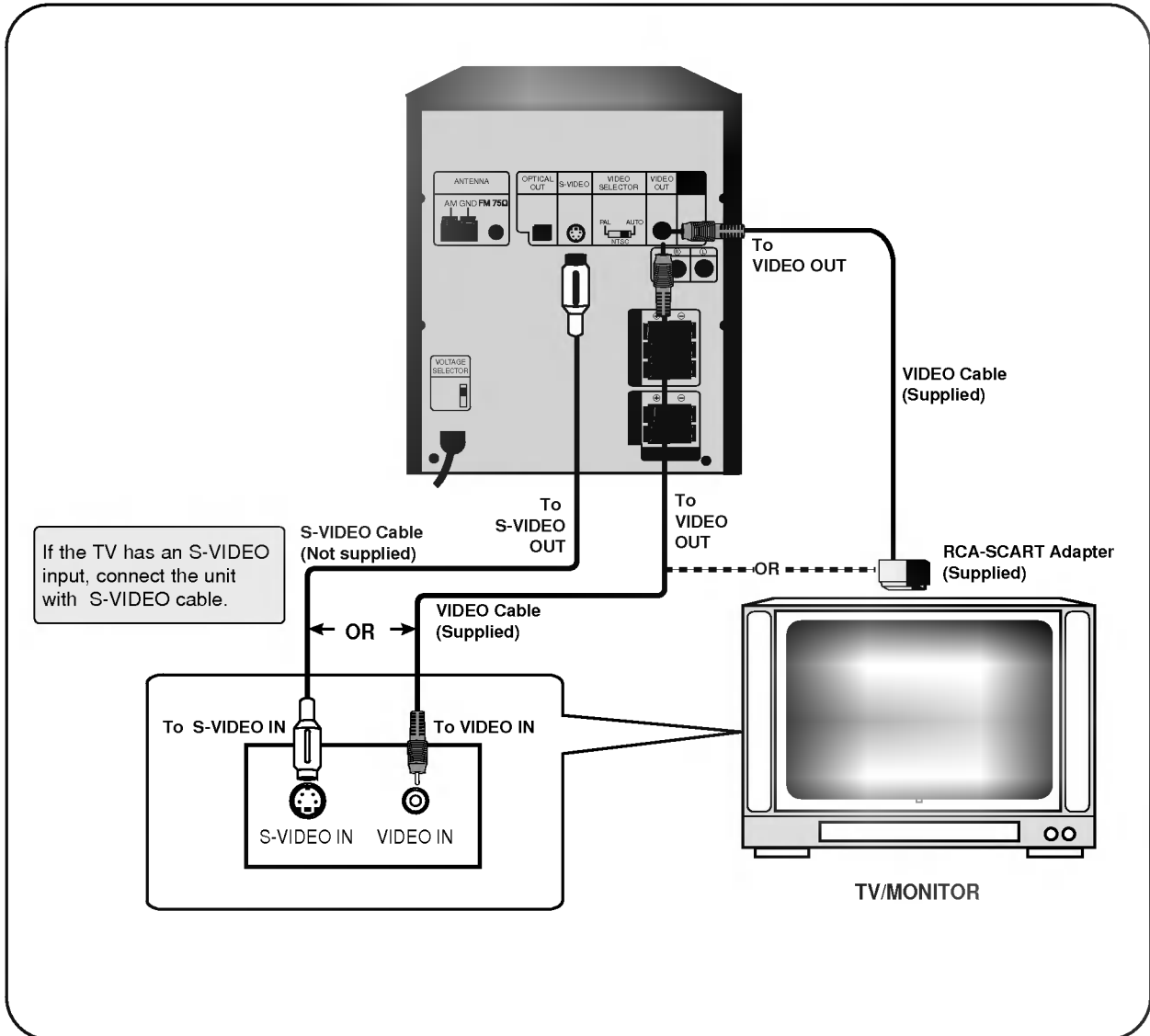

- Refer to the owner's manual of your TV as well.
- When you connect the unit to your TV, be sure to turn off the power and unplug both units from the wall outlet before making any connections.
- Connect the unit to your TV directly. If you connect the unit to a VCR, the playback picture will be distorted because DVD video discs are copy protected.
- The signal of S-VIDEO jack will output only when the function mode is selected to CD/DVD.

You must set the time for the Sleep and Timer function.

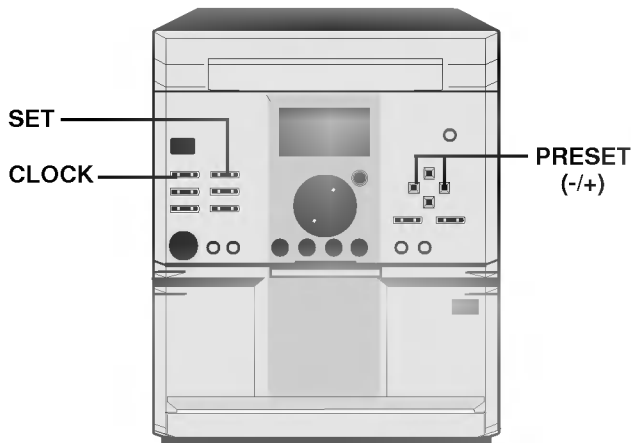

- Press the **CLOCK** button. (If the clock is already set, press and hold the **CLOCK** button for more than 2 seconds.) - The hours begin to flash.
- Select a 24 hour cycle or 12 hour cycle by using the **PRESET (-/+)** buttons.

 (12HR) or (24HR)
- Press the **SET** button to confirm the selected hour cycle.
- Use the **PRESET (-/+)** buttons to set the correct hours.
- Press the **SET** button.
- Use the **PRESET (-/+)** buttons to set the correct minutes.
- Press the **SET** and the correct time is shown on the display.
- Press the **CLOCK** button at any time to display the time for about 3 seconds.

When the sleep timer is used, the power is automatically turned off after the specified time has elapsed.

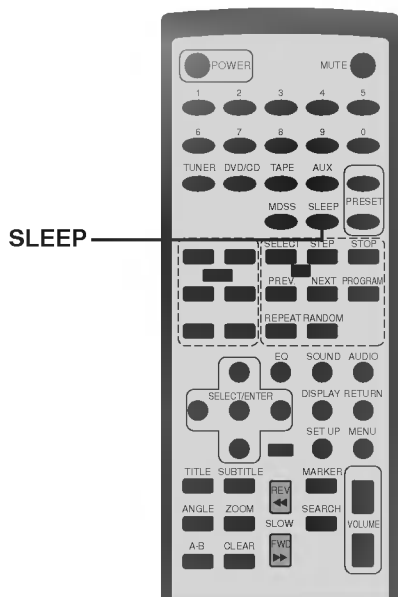

- To specify the time until the power is turned off, press the SLEEP button.**

In the display you can see *SLEEP 90* for about 5 seconds. This means that the system turns off automatically after 90 minutes. Each time the button is pressed the time interval before it turns off is reduced by 10 minutes. i.e. 80...70... etc. Select the desired time to turn off.
- To check the remaining time until the power is turned off.**

While the sleep function is active press the **SLEEP** button briefly. The time remaining until it turns off is displayed for about 5 seconds.

If you press the **SLEEP** button while the sleep time is displayed, the SLEEP time is reset.

- To cancel the sleep timer mode:**

If you wish to stop the function press the **SLEEP** button repeatedly until 10 appears, and then press the **SLEEP** button once again while 10 is displayed.

With the **TIMER** function you can have the radio reception and recording, CD play, tape play and recording turned on and off at the time desired.

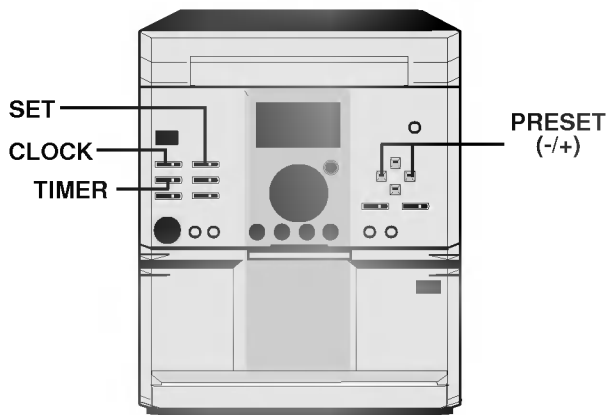

Press the **CLOCK** button to check the current time.

Press the **TIMER** button to enter the timer setting mode. (If you want to correct the previous memorized **TIMER**, press and hold the **TIMER** button more than 2 seconds.)
The previous memorized timer on time and the "⊙" appears in the display. Each function :
TUNER-CD/DVD-TAPE flashes in the display in turn.

Press the **SET** button when the desired function is flashing.

If you select the **TUNER**:
REC and PLAY flash in the display alternately for about 3 seconds. Press the **SET** button to confirm the desired operating mode.
REC: TUNER recording and play
PLAY: TUNER play only

- If you have selected the CD/DVD or TAPE, ignore step 4.

When you have selected the **TUNER**;
Select the previous memorized preset number with the **PRESET (-/+)** buttons and press the **SET** button. The hour with ON display flashes.

- If you have selected the CD/DVD ,TAPE ignore step 5.

Set the hour to switch on by pressing the **PRESET (-/+)** buttons.

Press the **SET** button to confirm the hour to switch on. The minute with ON display flashes.

Set the minute to switch on by pressing the **PRESET (-/+)** buttons.

Press the **SET** button to confirm the minute to switch on. The hour with OFF now flashes in the display.

Set the hour to switch off by pressing the **PRESET (-/+)** buttons.

Press the **SET** button.

Set the minute to switch off by pressing the **PRESET (-/+)** buttons.

Press the **SET** button.

Adjust the volume level by pressing the **PRESET (-/+)** buttons.

Press the **SET** button. ⊙ appears and the timer setting has been completed.

Switch the system off.

The selected function is automatically switched on and off at the time set.

To cancel or check the timer.
Each time the **TIMER** button is pressed you can select the timer set or cancel. You can also check the timer setting status.
To activate or check the timer, press the **TIMER** button so that ⊙ lights up in the display.
To cancel the **TIMER**, press the **TIMER** button so that ⊙ in the display window disappears.

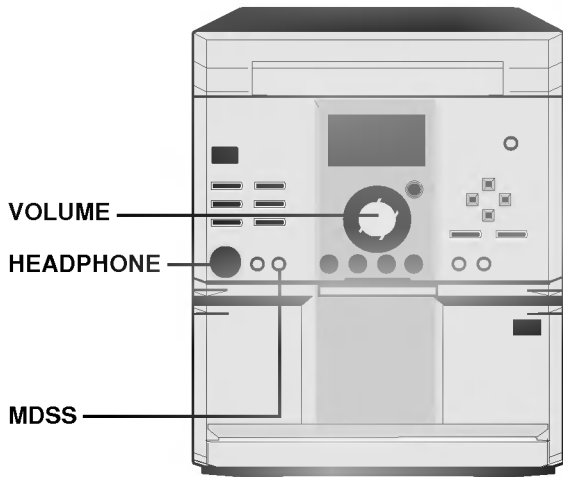

- Turn the **VOLUME** clockwise to increase the sound level, or counterclockwise to decrease it.
- Press the **VOLUME +** button to increase the sound level, or press the **VOLUME -** button to decrease it on the remote control.

► **To activate stereo sound**

You can choose between 4 fixed sound impressions: select a desired sound mode by using the **EQ PATT.** button on the remote control.

- FLAT : linear frequency response
- ROCK : more bass, more treble
- POP : less bass, less treble
- CLASSIC : for orchestral music

► **Headphone Socket**

Connect a stereo headphone plug (3.5mm) into the headphone socket.

The speakers are automatically disconnected when you plug in the headphones (not supplied).

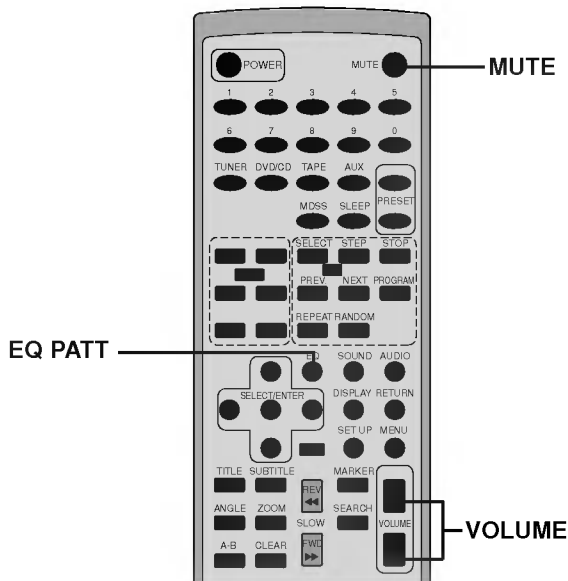

Press this button to mute your unit.

You can mute your unit in order, for example, to answer the telephone, the **MUTE** indicator flashes on the display window.

MDSS (Multi Dynamic Sound System)

Press the **MDSS** button to reinforce treble(Hi-Tone), bass(UBB: Ultra Bass Booster) and surround effect. The “MDSS ON” or “MDSS OFF” indicator lights up. To cancel it press the **MDSS** button again.

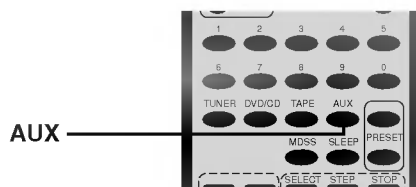

Connect an auxiliary device i.e. TV or VCR, via the rear mounted AUX phono sockets.

Press the “**AUX**” function button.

You can also record from the auxiliary input source, see Cassette Deck Operation Section.



You can enjoy surround sound simply by selecting one of the pre-programmed sound fields according to the program you want to listen to.

This operation works only with CD/DVD discs.

Press the SOUND repeatedly until the sound mode you want appears in the display window.

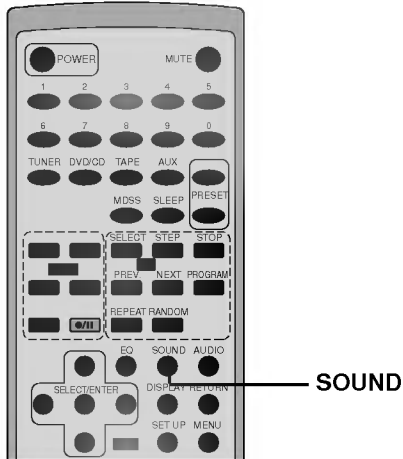
See the table below for information on each sound mode.



Sound Mode	Effect
DIGITAL	The Dolby Digital surround format lets you enjoy up to 5.1 channels of digital surround sound from a Dolby Digital program source. If you play DVD of laser discs with "  " mark, you can enjoy even better sound quality, greater spatial accuracy, and improved dynamic range. This is because Dolby Digital delivers up to 5 totally discrete, audio channels (front left and right, center, and rear left and right), plus 0.1 channel called LFE*(bass-only effects channel) *LFE=Low Frequency Effects. This channel delivers separate non-directional bass signals to the subwoofer for more dynamic deep bass sound effects.
PRO LOGIC	Use this mode when playing movie or Dolby Digital 2 channel which carries the "  " mark. This mode provides the effect of being in a movie theater or live concert house-an effect with an intensity which can only be obtained through DOLBY PRO LOGIC SURROUND. The effect of the front/back/left/right movement of the sound image, as well as the sense of fixed position in the sound image, is much clearer and more dynamic than before.
3D SURROUND	This unit can produce a 3D Surround effect, using 3D Surround Sound technology, which simulates multi-channel audio playback from two conventional stereo speakers instead of the five or more speakers normally required to listen to multi-channel audio from a home theatre. This feature works with DVD discs encoded with Dolby Pro Logic and Dolby Digital audio tracks.
3 STEREO	Dolby 3 Stereo surround sound uses analog or digital audio signals to playback three speakers. You do not require rear speakers. This allows you to enjoy a home theater surround sound experience without connecting rear channel speakers. 3 Stereo can be used with Dolby Digital or Dolby Pro Logic audio sources.

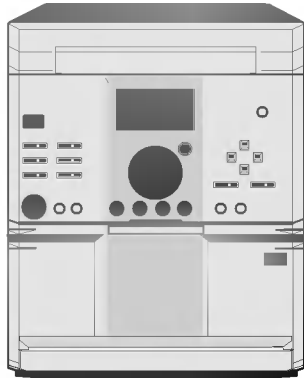

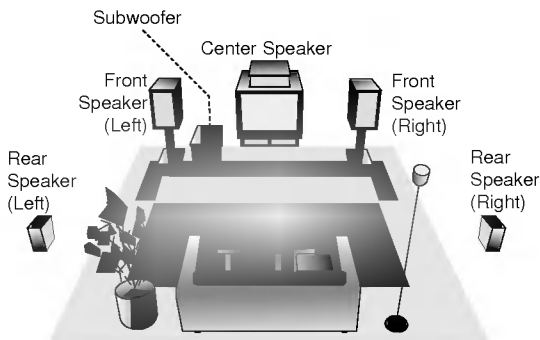

Manufactured under license from Dolby Laboratories. "Dolby", "Pro Logic", and the double-D symbol are trademarks of Dolby Laboratories. Confidential Unpublished works. Copyright 1992-1997 Dolby Laboratories. All rights reserved.



Speaker Positioning Example

Dolby Digital and Dolby Pro Logic are used to enjoy the 3-dimensional sound effect with video image, you need to use the devices as follows.

- Use the program sources (e.g. DVD) marked with Dolby Surround ( or ).

In the case of normal position use the 6 speakers (2 front speakers, center speaker, 2 rear speakers and subwoofer). If you want to play the excellent bass sound or Dolby Digital surround, you should connect a subwoofer.

• **Front speakers**

We recommend that the height of the tweeter of the front speakers and listener's ears are same height. And positioned at an angle of 45 degrees.

• **Center speaker**

It is ideal that the center speakers and front speakers are same height. But normally place it above or below the television.

• **Rear speakers**

Place left and right behind the listening area. These speakers recreate sound motion and atmosphere required for surround playback. For best results, do not install the rear speakers too far behind the listening position and install them at or above the level of the listener's ears. It is also effective to direct the rear speakers towards a wall or ceiling to further disperse the sound.

In case of the small sizes from the front to rear of the room, if the listener is near the rear wall set the rear speakers opposite each other, and set the rear speakers above 60 - 90 cm above the listener's ears in a downward direction.

• **Subwoofer**

Without notice for the setting position place it an appropriate position.

- We recommend that you use the magnetic shielded speakers for the front left/right speakers and center speakers to protect from the video noise of the nearby television.
- Use the speakers that have a similarity in the sound character of all speakers.

You can preset 30 stations for FM and AM. Before tuning, make sure that you have turned down the volume to the minimum.

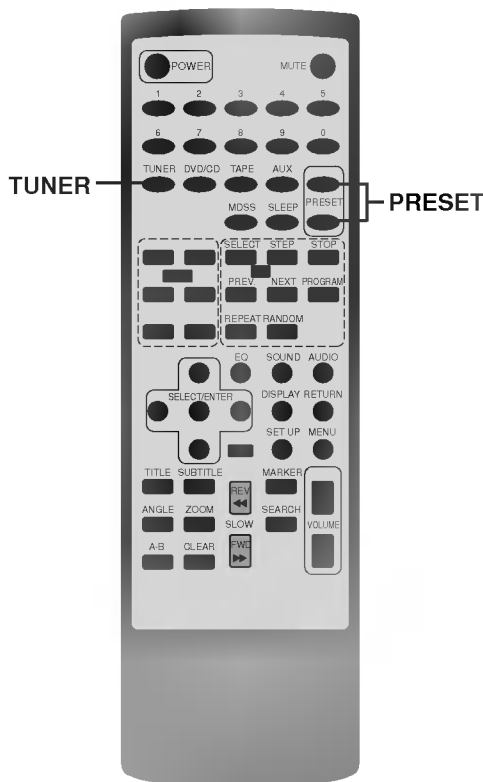
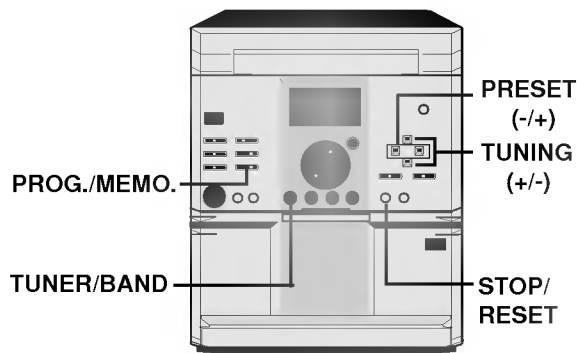

Press the **TUNER/BAND** on the front panel repeatedly or **TUNER** on the Remote control until the **FM** or **AM** appears in the display window.

And then every time you press the **TUNER/BAND** (**TUNER** : on the remote control), **FM** and **AM** changes alternately.

Press and hold the **TUNING (+/-)** on the front panel for about two seconds until the frequency indication starts to change, then release.

Scanning stops when the unit tunes in a station.

Press the **PROG./MEMO.**

A preset number will flash in the display window.

Press the **PRESET (-/+)** on the front panel to select the preset number you want.

Press the **PROG./MEMO.** again.

The station is stored.

Repeat steps 3 to 6 to store other stations.

To tune in a station with a weak signal

Press the **PRESET (-/+)** repeatedly in step 3 to tune in the station manually.

To clear all the memorized stations

Press and hold the **PROG./MEMO.** for about two seconds, "RESET" appears in the display window and then press **PROG./MEMO.** again, the stations are cleared.

For your reference

If all stations have already been entered, **FULL** message will appear in the display window for a moment and then a preset number will flash. To change the preset number, follow the steps 5-6 as above.

To recall presets

Press and hold the **PRESET (-/+)** or **PRESET ▲/▼** (on the remote control) until the desired preset number appears or press it repeatedly.

Preset radio stations in the unit's memory first (see "Presetting radio stations" on the previous page).

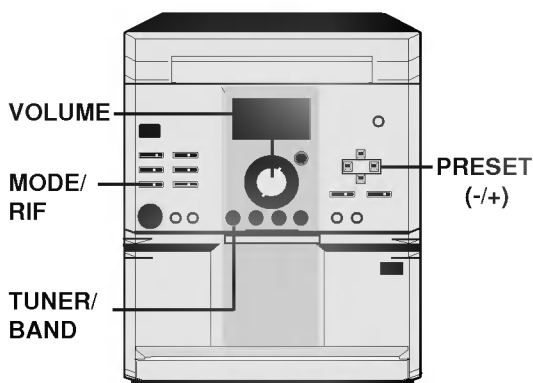

For your reference

- **If an FM program is noisy**
Press the **MODE/RIF** on the front panel so that "STEREO" disappears in the display window. There will be no stereo effect, but the reception will improve. Press the **MODE/RIF** again to restore the stereo effect.
- **To improve reception**
Reposition the supplied antennas.

- Use **MODE/RIF** (Radio Interference Filter) to switch the mono reception if stereo reception is distorted by noise.
- When recording the **MW(AM)** or **LW** broadcast, beat noises occur. If it does, press the **MODE/RIF** once.

Press the TUNER/BAND until AM or FM appears in the display window.

The last received station is tuned in.

Press the PRESET (-/+) repeatedly to select the preset station you want.

Each time you press the button, the unit tunes in one preset station at a time.

Adjust the volume by rotating VOLUME on the front panel or pressing VOLUME (+/-) repeatedly on the Remote control.

To turn off the radio

Press the **POWER** to turn the unit off or select another function mode (CD/DVD, TAPE or AUX).

To listen to non-preset radio stations

- Use manual or automatic tuning in step 2.
- For manual tuning, press the **TUNING (+/-)** on the front panel repeatedly.
- For automatic tuning, press and hold the **TUNING (+/-)** for about two seconds on the front panel.

What is RDS?

RDS (Radio Data System) is a system gradually being introduced on FM in many countries, where by an inaudible stream of data is transmitted in addition to the normal radio signal. This data contains various information including station/ transmitter identification, traffic information and a list of alternative frequencies for the radio station being received.

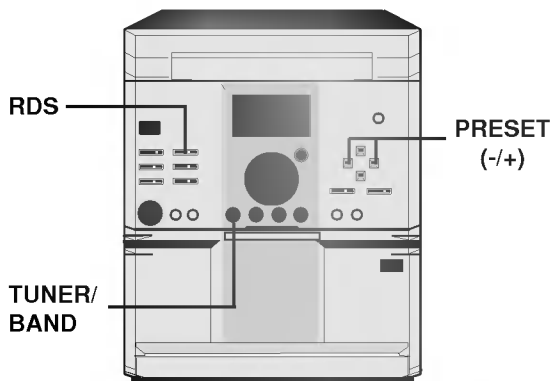

Press the TUNER/BAND to select FM.

Select a desired station by pressing the PRESET (-/+) or Preset ▲/▼ (on the remote control).

When the RDS transmission is received, the display shows the program service name (PS) after RDS indicator appears.

Press the RDS to recall the frequency.

- RDS is only available for FM reception.
- The PS (PROGRAM SERVICE) NAME is displayed automatically when a RDS station is received.

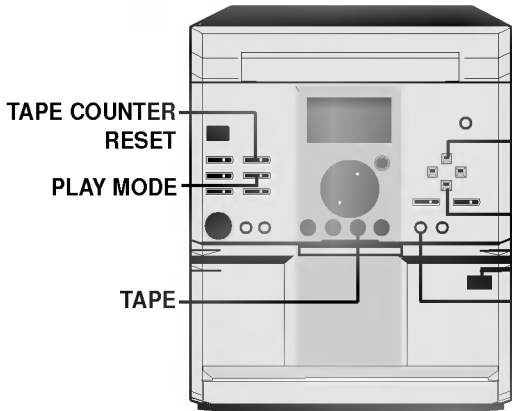

- Press the **TAPE** button. "NO TAPE" appears on the display window.
- Press the **▲ PUSH/EJECT**, position to open the cassette door.
- Insert a recorded cassette with the exposed tape side down.
- Press the **PLAY ▶** (or **PLAY◀**: OPTIONAL) button to begin tape playback.
- To manually change the tape play directions, press the **BACKWARD PLAY** button from the direction the tape is currently playing (optional).
- To stop playback at any time, press the **■ STOP/RESET** button.

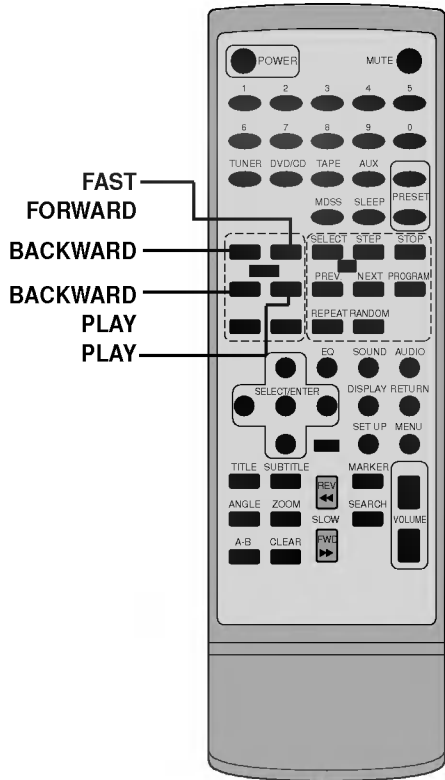

To select a play mode (reverse mode)

Press the **PLAY MODE(TAPE)** button during tape function or recording from another function: (OPTIONAL)

- ▶ = forward or backward play once only
- ◀▶ = forward and backward play once only
- ◀▶▶ = forward and backward play for six times.

During tape stop or play press the **TAPE COUNTER RESET** button.

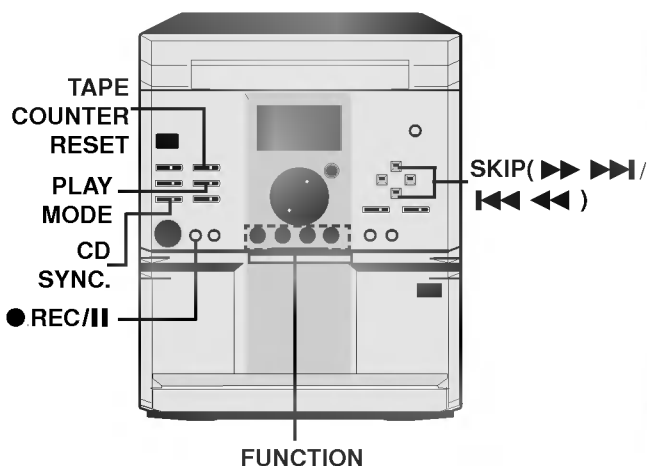

CD to tape synchronized recording.

NOTE : Use only normal tapes.

- Load a disc.
- Insert a blank tape into deck.
- Select a play mode by pressing the **PLAY MODE (TAPE)** button repeatedly.
In \curvearrowright mode you can record forward (▶) only and in \curvearrowleft or \curvearrowright mode you can record from forward (▶) to backward (◀) (OPTIONAL).
- Press the **DVD/CD** function button.
Stop the CD if the CD is playing.
- Press the **CD SYNC.** button to start recording.
The CD synchronized recording begins and stops automatically at the end.
When the tape is set to auto reverse backward (◀), the CD will restart the current track from the beginning.

Recording from Radio, CD or auxiliary source.

NOTE : Use only normal tapes.

- Insert a blank tape into deck.
- Set to tape function by pressing the **FUNCTION** button. (And press the **TAPE COUNTER RESET** button to reset the tape counter)
- Select a play mode by pressing the **PLAY MODE (TAPE)** button. (OPTIONAL)
 - If you want to record forward (▶) or backward (◀) only set to \curvearrowright .
 - If you want to record from forward (▶) to backward (◀) set to \curvearrowleft or \curvearrowright .
- Select a function that you want to record and play.
- Press the **REC/II** button. "●REC" flashes on the display.
- Press the **REC/II** button again to begin recording to the direction of **PLAY** (▶ or ◀ : OPTIONAL) indicator or press the ▶ or ◀ (OPTIONAL) button to begin recording to the selected play direction.

- If you want to record certain titles only, program these before commencing CD synchronized recording.
- If you want to record from the desired track, select the desired track with the $\blacktriangleright\blacktriangleright\blacktriangleright$ or $\blacktriangleleft\blacktriangleleft\blacktriangleleft$ button before commencing CD synchronized recording.



This section shows you the basics on how to play back a DVD video disc.

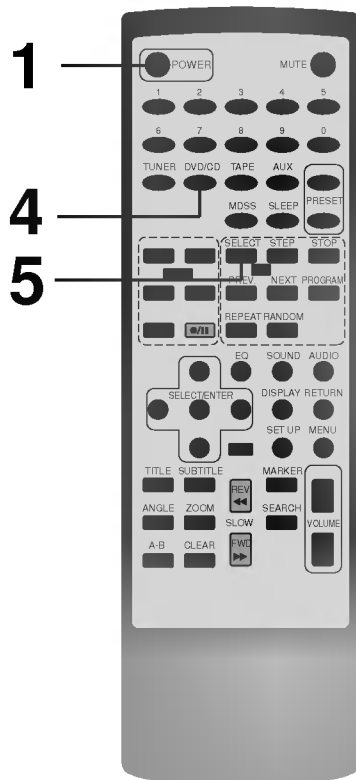
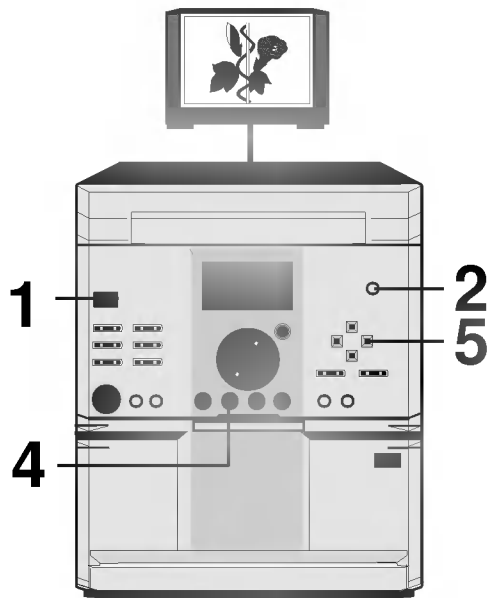

Preparations

- When you want to play back DVD video discs, turn on the TV and select the video input source connected to the unit.
- When you want to enjoy the sound of DVD video discs or audio CDs from the audio system, turn on the audio system and select the input source connected to the unit.
- For connection details, see pages 9 through 11.
- Set the playback picture size according to the aspect ratio of the connected TV at the SETUP menu (TV Aspect).
- If you do not have the necessary equipment to enjoy Dolby Digital sound, set the Digital Audio Output at the SETUP menu to "PCM".

Press POWER.
The unit turns on.

Press OPEN/CLOSE.
The disc tray opens.

- You can open the disc tray by pressing this button even if the unit is in standby mode.

Place a disc on the disc tray with the playback side down.

- There are two different disc sizes. Place the disc in the correct guide on the disc tray. If the disc is out of the guide, it may damage the disc and cause the unit to malfunction.

Press DVD/CD to select CD or DVD mode.

Press PLAY.

The disc tray is automatically closed and playback begins.

- If the disc is placed in upside down (and it is a single sided disc), "NO DISC" or "DISC ERROR" appears on the TV screen.
- If you insert an audio CD, the CHP/TRK indicator lights up in the display window. The title number does not appear.
- After playing back all of the chapters in the title, the unit automatically stops and returns to the menu screen.

When a menu screen appears on the TV screen.

In case of interactive DVDs with control, a menu screen appears on the TV screen. Perform step 6 on page 22 to start play.

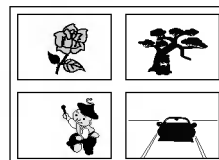

Example of interactive DVD On-Screen Menu

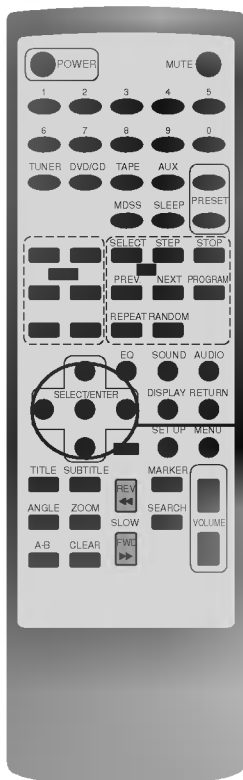

Press ▲/▼/◀▶ and press **SELECT/ENTER**, or press the numeric button(s), to select the desired item.

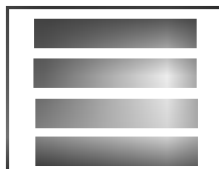

OR

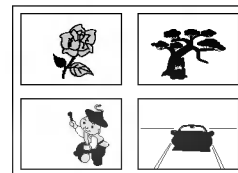

Play of the selected item now begins.

- For further information, also refer to the jacket or case of the disc you are playing.

After operation

When the unit is not in use, remove the disc and press the **POWER** to turn off the power.

- Do not move the unit during playback. Doing so may damage the disc and the unit.
- Use the **OPEN/CLOSE** button on the unit to open and close the disc tray. Do not push the disc tray while it is moving. Doing so may cause the unit to malfunction.
- Do not push up the disc tray or put any objects other than discs on the disc tray. Doing so may cause the unit to malfunction.
- Keep your fingers well clear of the disc tray as it is closing. Be especially careful with children's fingers around the closing disc tray as there is a risk of personal injury.
- When "⊘" appears on the TV screen while a button is pressed, it means that this function is not available on the disc you are playing.
- Depending on the DVD disc, some operations may be different or restricted. Refer to the jacket or case of the disc you are playing.
- The sound is muted during playback an audio CD recorded in dts.
- The sound is muted during playback a DVD disc recorded in dts. To enjoy sound, select the Dolby Digital audio track by pressing the **DISPLAY** and ▲/▼/◀▶ in GUI Menu Icons (see page 26).

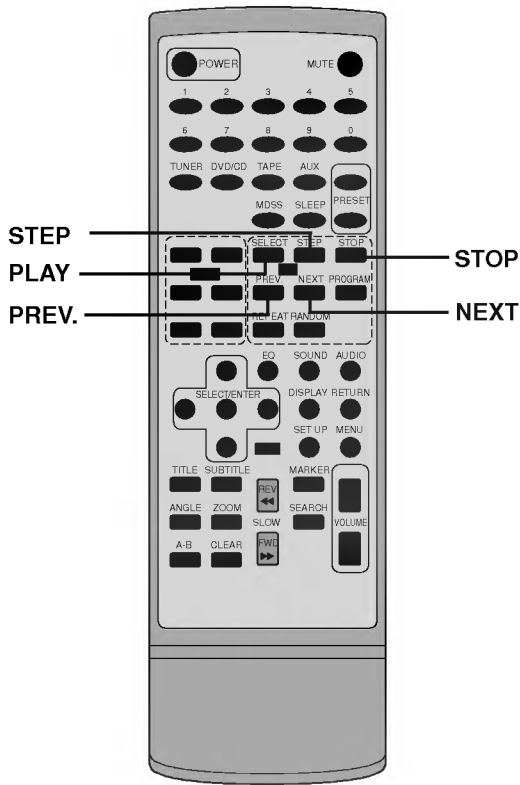

Press the STOP during playback.

- When play is stopped, the unit records the point where STOP was pressed (RESUME function). Press the **PLAY** and play will resume from this point.

- Resume function will be cleared when the STOP is pressed on the STOP mode.
- Resume function will be cleared when the power is turned off and then on.
- Opening the disc tray cancels Resume function.
- The Resume function may not be available on some DVD discs.

Press the STEP during playback.

- DVD
The unit will be placed in the still picture mode.
- CD
The unit will be placed in the pause mode.

Press the STEP during still playback.

(Each time you press the **STEP**, the picture advances one frame)

To resume normal playback, press the PLAY.

Skipping chapters and tracks forward or back

Skipping forward

Press the NEXT ►► during playback.

A chapter (DVD) or a track (CD) is skipped each time the button is pressed.

Skipping back

Press the PREV. ◀◀ during playback.

- When the button is pressed once midway through a chapter/track, the player returns to the start of that chapter/track. When it is pressed again, a chapter/track is skipped each time the button is pressed.



You can play back discs at various speeds.



To Scan at fast forward or fast reverse playback.

Press and hold the PREV. ◀◀ or NEXT ▶▶ button during playback.

[TV screen]



- The speed of advance (reverse) is relatively slow at first. When the button is pressed again, the speed becomes faster. (Each time the button is pressed, the speed increases up to 4 steps.)
- The speed will be retained even after the button is released.

To return to normal playback, press PLAY.



- The unit does not play back sound during the high speed reverse and forward playback of DVD video discs. However, the unit plays back sound during fast forward or fast reverse playback of audio CDs.



Press the SLOW ◀◀ or ▶▶ during playback.

The playback speed becomes 1/16 (DVD) of the normal speed.

[TV screen]



- The speed of slow-motion is slow at first. When the button is pressed again, the speed becomes faster. (Each time the button is pressed, the speed increase up to 4 steps.)
- The speed will be retained even after the button is released.

To return to normal playback, press the PLAY.



- The sound is muted during slow-motion playback.
- Subtitles do not appear on the screen during slow motion playback.
- This function does not work in case of Audio CDs.



This unit features GUI Menu Icons showing disc information (title/chapter/track number, elapsed playing time, audio/subtitle language, angle, and sound) and player information (repeat play, play mode, marker, etc.). Some icons only show the indicated information. Other icons allow the settings to be changed.

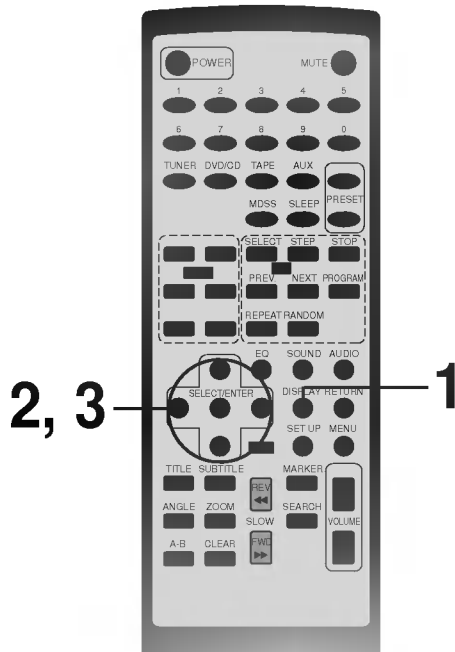

Common procedures

Press the DISPLAY during playback.

- Title function can be accessed from the stop mode.

Press the ▲/▼ to select the desired item.

- The current selected item is indicated by a yellow frame on its GUI menu icons.

Press the ◀/▶ to select the desired setting.

- When numbers are displayed (e.g. title No.), the numeric buttons can also be used for setting instead of ◀/▶.
- For some functions, the setting will be registered immediately; for others, SELECT/ENTER must be pressed.

To clear the GUI Menu Icons, press the DISPLAY.

Examples of GUI Menu Icons.

(The screens may differ depending on the disc contents.)



(DVD GUI)



(CD GUI)

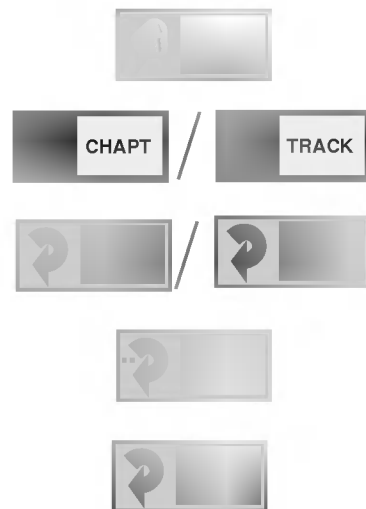

(DVD and CD Function GUI)



You can view information about a disc and its operational status on the TV screen.

Press the DISPLAY during playback.

[TV screen] DVD GUI



FUNCTION (Press ▲/▼ to select desired item)	SELECTION METHOD
To show the current title No. and to jump to the desired title No.	◀▶, or Numeric SELECT/ENTER
To show the current chapter No. and to jump to the desired chapter No.	◀▶, or Numeric SELECT/ENTER
To show the elapsed time and directly select scenes by the desired time.	Numeric SELECT/ENTER
To show the current audio soundtrack language, encoding method, channel No. and to change the settings.	◀▶, AUDIO
To show the current subtitles language and to change the setting.	◀▶, SUBTITLE
To show the current angle No. and to change the angle.	◀▶, ANGLE
To show the current sound (NORMAL, 3D SURROUND, Dolby Pro Logic or Dolby 3 Stereo) and to change the setting.	◀▶

Press DISPLAY during playback.

[TV screen] CD GUI

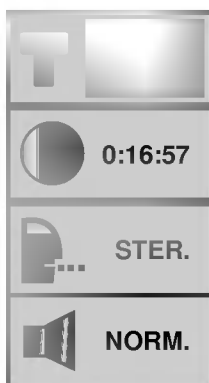

FUNCTION (Press ▲/▼ to select desired item)	SELECTION METHOD
To show the current track No. and to jump to the desired track No.	◀▶, or Numeric SELECT/ENTER
To show the elapsed time. (Display only)	—
To show the current audio (STEREO, LEFT, RIGHT) and to select to the desired audio channel.	◀▶, AUDIO
To show the current sound (NORMAL, 3D SURROUND, Dolby Pro Logic or Dolby 3 Stereo) and to change the setting.	◀▶

○ Some DVD discs may not provide all of the above GUI menu icons.



Some movie discs may contain two or more titles. If the disc has a title menu recorded on it, the TITLE button can be used to select the movie title. (The details of operation differ depending on the disc used.)

- Selecting a title may not be possible on certain DVD discs.

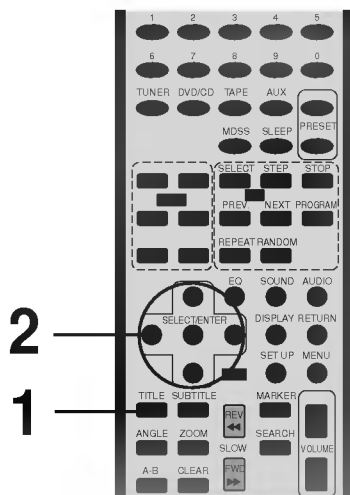

Press the TITLE.

A list of the titles on the disc is displayed.

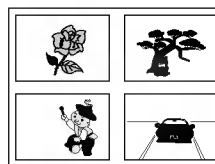

Press the TITLE again to resume play from the scene when TITLE was first pressed.

- Resume play may not be possible on certain discs.

Press the ▲/▼/◀▶ and press the SELECT/ENTER or PLAY, or press the numeric button(s), to select desired title.

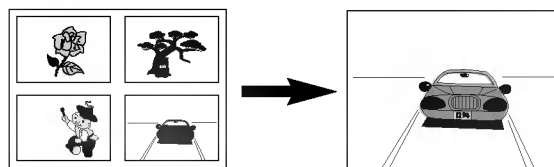

The selected title now starts playing.



Some DVDs have unique menu structures called DVD menus. For example, DVDs programmed with complex contents provide guide menus, and those recorded with various languages provide menus for audio and subtitle language. Although the DVD menu's contents and operation differ from disc to disc, the following explains the basic operation when this feature is used.

Press the MENU during play.

The DVD menu available on the disc is now displayed.

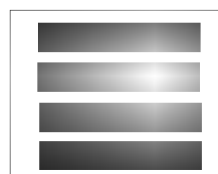

Press the MENU again resumes play from the scene when MENU was first pressed.

- Resume play may not be possible on certain discs.

Press the ▲/▼/◀▶ and press the SELECT/ENTER, or press the numeric button(s), to select desired item.

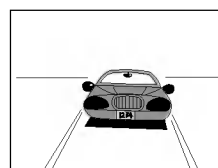
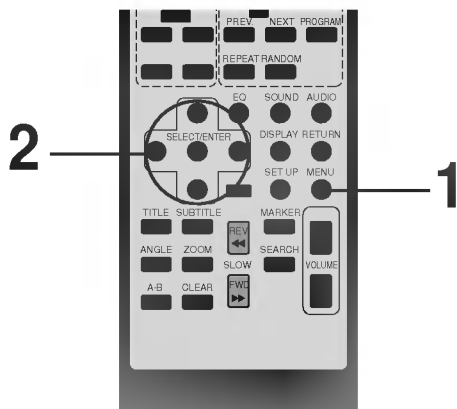

The selected item is now executed.



This unit stores, in memory, settings for DVDs you have watched. Settings remain in memory even if you remove the disc from the unit, or switch power to OFF. If you load a disc that has its settings memorized, the “Resume disc from last position?” message will appear on the TV screen. When you start playing the disc, the memorized settings are automatically recalled.

You can memorize details for the following six settings.
Latest Stop Position (Page 23)
TV Aspect (Page 41)
Disc Subtitle Language (Page 29)
Disc Audio Language (Page 29)
Disc Menu Language (Page 38)
Angle (Page 30)

Load the DVD that was memorized.

It will appear on the TV screen as below

- If the screen is left for more than 10 seconds, playback will start from the beginning of the title automatically.

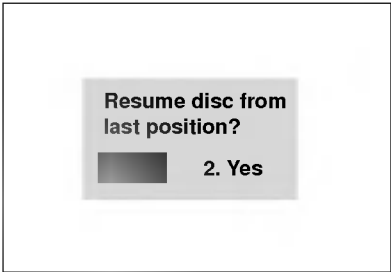
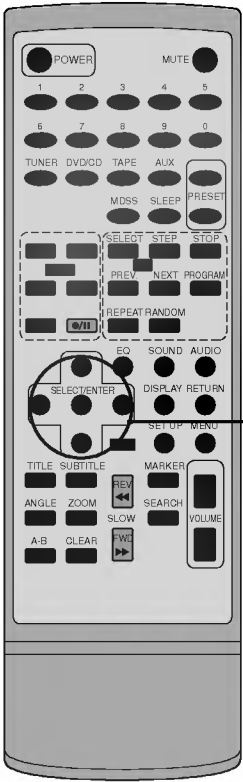

Press the ◀▶ to select “Yes” and press the SELECT/ENTER.

The memorized settings are automatically recalled.

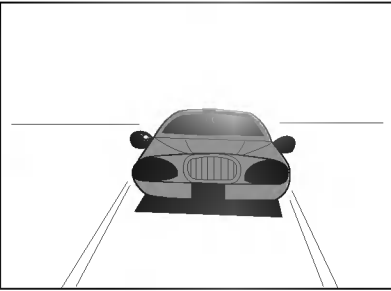

- Settings are stored in memory for use any time.
- You can store settings for up to 1 DVD in memory. If you memorize settings for more than 1 DVD previously memorized settings are erased in order from the least recently memorized settings. Subsequently, if you try to call up these previously memorized settings, you will get the latest settings that have taken their place.
- Switching of the audio mode etc., is automatic on some discs.
- This unit does not store settings in memory, if you remove the disc from the unit or switch power to the unit OFF when DVD or title menu is displayed on the TV screen.



It is possible to change the subtitle language to a different language from the one selected at the initial settings. (See page 38 for further info.)

This operation works only with discs on which multiple subtitle languages are recorded.

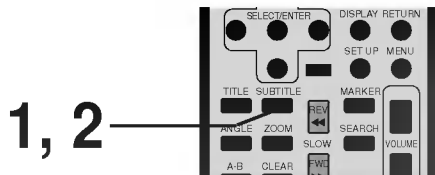

Press the **SUBTITLE** during playback.



Press the **SUBTITLE** repeatedly until the desired language is selected.

Number of the subtitle language being played back.



- In some cases, the subtitle language is not changed to the selected one immediately.
- When a disc supporting the closed caption is played, the subtitle and the closed caption may overlap each other on the TV screen. In this case, turn the subtitle off.
- When the desired language is not selected even after pressing the button several times, it means that the language is not available on the disc.
- When the power is turned on or the disc is removed, subtitles appears in the language selected at the initial settings. If this language is not recorded on the disc, the disc's priority language appears.

To eliminate the On Screen Subtitles.

Press the **SUBTITLE** repeatedly to select OFF at step 2.



It is possible to change the audio soundtrack language to a different language from the one selected at the initial settings in case of DVD disc. (See page 38 for further info.) This operation works only with discs on which multiple audio soundtrack languages are recorded.

It is not possible to change the audio channel in case of audio CD.

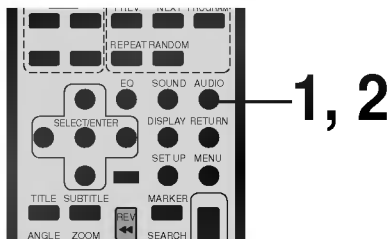

• DVD

Press the **AUDIO** during play.

Number of the audio soundtrack language being played back.



Press the **AUDIO** repeatedly until the desired language is selected.



• CD

Press the **AUDIO** during play.



Press the **AUDIO** repeatedly until the desired sound is selected.



- When the desired language is not selected even after pressing the button several times, it means that the language is not available on the disc.
- When the power is turned on or the disc is removed, the language heard is the one selected at the initial settings. If this language is not recorded on the disc, only the available language on the disc will be heard.
- Some discs may not respond to Audio feature.



Some DVDs may contain scenes which have been shot simultaneously from a number of different angles. For these discs, the same scene can be viewed from each of these different angles using the **ANGLE** button. (The recorded angles differ depending on the disc used.)

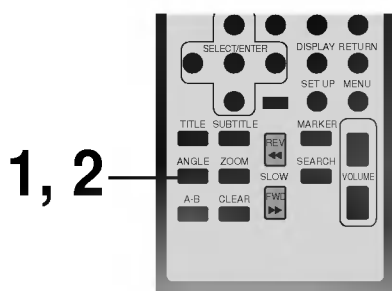
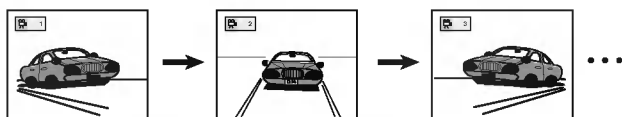

Press the **ANGLE** during playback.

Number of angle being played back.



Press the **ANGLE** repeatedly until the desired angle is selected.



For your reference

- The ANGLE indicator will blink in the display window at scenes recorded at different angles to indicate that angle switching is possible.
- The angle number can be programmed beforehand; the angle will be switched to the selected number when the ANGLE indicator blinks.

- This function only works for discs having scenes recorded at different angles.



This unit can produce a 3D Surround effect, using 3D Surround Sound technology, which simulates multi-channel audio playback from two conventional stereo speakers instead of the five or more speakers normally required to listen to multi-channel audio from a home theatre. This feature works with DVD discs encoded with Dolby Surround and Dolby Digital audio tracks.

Press the **DISPLAY** during playback.

Press the **▲/▼** to select **NORM.**



Press the **◀▶** repeatedly until the desired sound is selected.

Each time this button is pressed, the TV screen display changes:

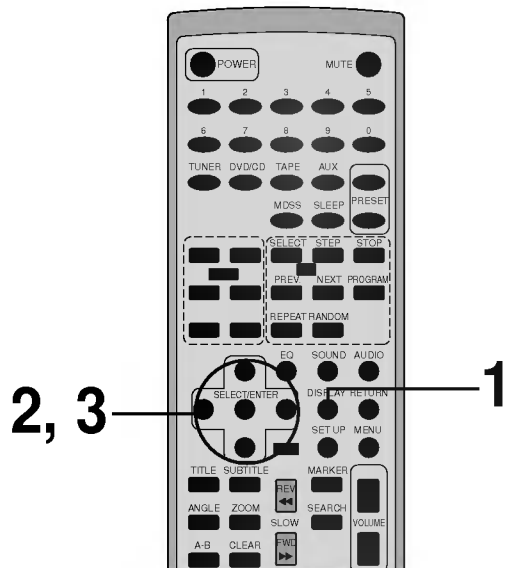

- This 3D Surround effect may not be available on some DVD discs, such as those recorded with a mono audio soundtrack.
- Turn off the TV surround sound and other surround effects when using this 3D surround effect.
- For best 3D Surround effect using only two speakers it is recommended that the two speakers be positioned approximately 2m to 2.5m apart, and the listening position should be 2m to 2.5m away from the speakers.
- Dolby Pro Logic will only display during playback a disc with 2 channel audio format.
- Dolby 3 Stereo will display when you select the rear speaker to None mode in the 5.1 Speaker Setup menu.



Repeating viewing (listening)

Press REPEAT during playback.

Each time this button is pressed, the TV screen changes as shown below and the disc will repeat a chapter or title (DVD) or a track (CD).

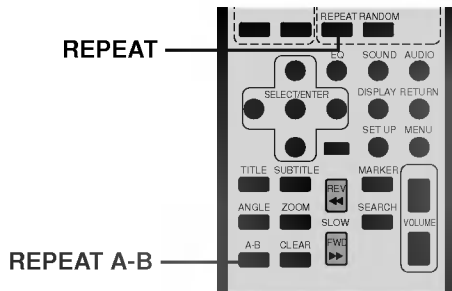

• DVD

Repeat of chapter being played

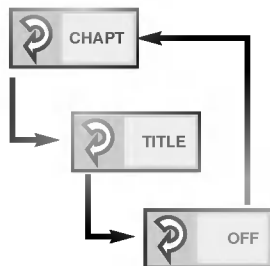

Repeat of title being played

Cancel repeat mode (normal play)

• CD

Repeat of track being played

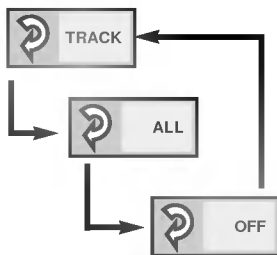

Repeat of entire disc contents

Cancel repeat mode (normal play)

To enjoy program repeat play (CD)

If REPEAT is pressed during program play, repeat play is operated as below.

Repeat of the current programmed track

Repeat of all programs

Cancel repeat mode (Program play)

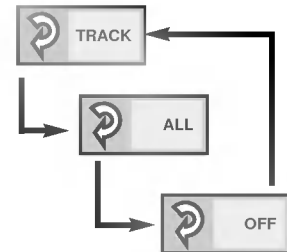

To return to normal play

Press the REPEAT several times until "OFF" is displayed.

Repeating sections between two specific points (A-B repeat)

Press the A-B during play at the point where repeat play is to start (A).



- You can select "OFF" at this step by pressing the CLEAR.

Press the A-B during play at the point where repeat play is to be concluded (B).



- Repeat play of the selection between points A and B starts.

To return to normal play

Press the A-B once "OFF" is displayed.



- Repeat play works only with discs for which the elapsed playing time appears in the DVD display window during playback.
- Repeat play may not work correctly with some DVDs.
- A-B repeat play works only within a title DVD or a track CD.
- Some subtitles recorded around point A or B may fail to appear (DVD).



Storing a MARKER in the DVD memory is similar to marking your page in a book. It allows you to quickly return to any point on the disc.

Storing a marker in the memory

Press the **MARKER** during play at the starting point to be viewed (listened to) again.



Indicates "1/5" is stored in the memory. Up to 5 markers can be stored in the memory.

Recalling/Clearing a marker

Press the **SEARCH** during playback.

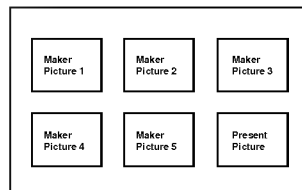

Press the **▲/▼/◀/▶** to select the marker to be recalled/cleared.

Press the **PLAY** or **SELECT/ENTER** to recall a marker. or Press the **CLEAR** to clear a marker.

Play resumes from the point corresponding to the selected marker, or the selected marker is cleared.

● The "Present Picture" is not cleared.

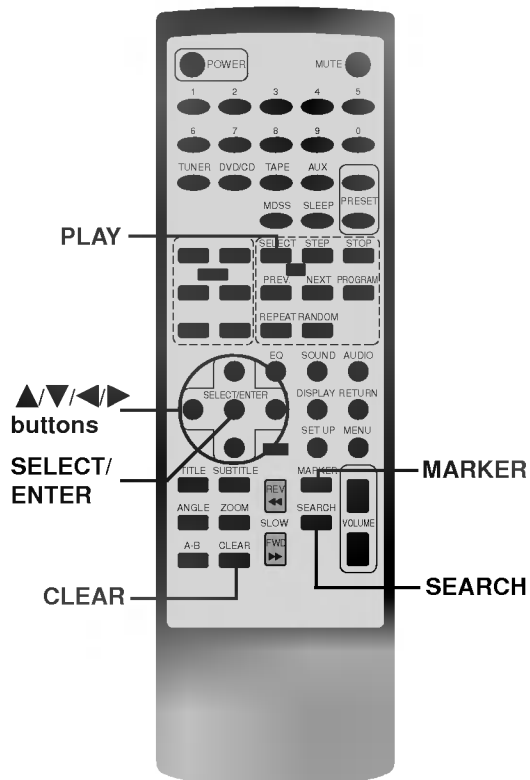

- These operations work only with discs for which the elapsed playing time appears in the display window during playback or stop.
- Some subtitles recorded around the marker may fail to appear (DVD).
- All the markers are cleared when the power is turned off or the disc is removed and when TV Aspect mode is changed at the SETUP menu.
- The marker is not stored when the DVD or title menu is displayed on the TV screen.



The Zoom feature allows you to "ZOOM-IN" and enlarge the picture on the screen to either 4 times (X4) or 16 times (X16) its normal size.

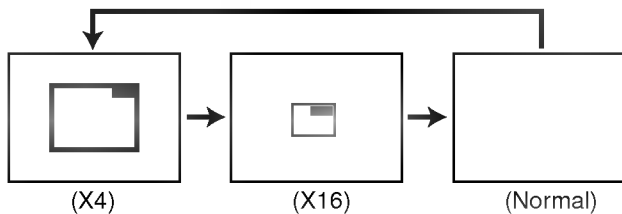
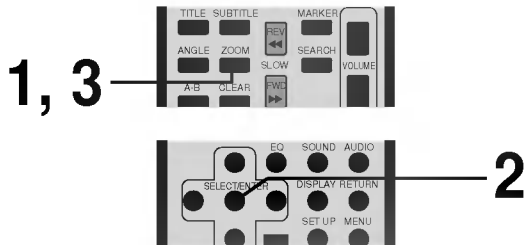

Press the ZOOM during normal playback or still playback.

- The square frame will be displayed in the centre of the picture. If no button is pressed for more than 10 seconds, the square frame will disappear.
- Each press of the **ZOOM** button changes the TV screen in the left sequence.
- The magnification level will be displayed in the upper right corner of the zoom area.

If you press the **▲/▼/◀▶** buttons the zoom point shifts.

Press the SELECT/ENTER.

The selected frame is displayed in full size on the TV screen.

To resume normal playback

Press the **ZOOM** again to cancel Zoom feature and resume normal playback or still playback.

- Some discs may not respond to the Zoom feature.
- Zoom does not work on subtitles or menus included on DVD video discs.



Note: This function only works with karaoke DVD and with audio CD discs. Random does not work with DVD movies.

You can playback titles, or tracks in random order. (Random playback)

This unit automatically selects the titles in a DVD video karaoke disc only and plays them back randomly.

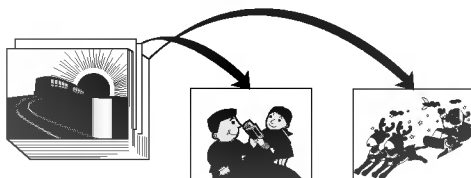
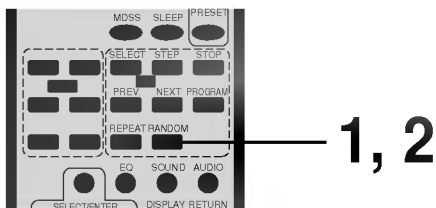

Random play (Karaoke CD/DVD)

Press the RANDOM during stop.

This unit starts random playback.

- If you press the **RANDOM** during normal playback, the unit will randomly select another title and begin random playback immediately.

To resume normal playback, press the RANDOM.

The **RANDOM** indicator in the display window disappears.

Random play (CD)

This unit plays the tracks on the disc in random order.

Press the RANDOM during stop.

The random playback screen appears on the TV screen.

- If you press the **RANDOM** button during normal playback, the unit immediately selects another track and begins random playback.

To resume normal playback, press the RANDOM during random playback.

The **RANDOM** indicator in the display window disappears.

- Random playback may not be possible on certain discs.
- If you press the **NEXT ▶▶** button during random playback, the unit goes to another track randomly and starts playback.



This unit plays the tracks on the disc in an order you specify.

Note: Programme play function is possible only with audio CDs. It does not work with DVD movie discs.

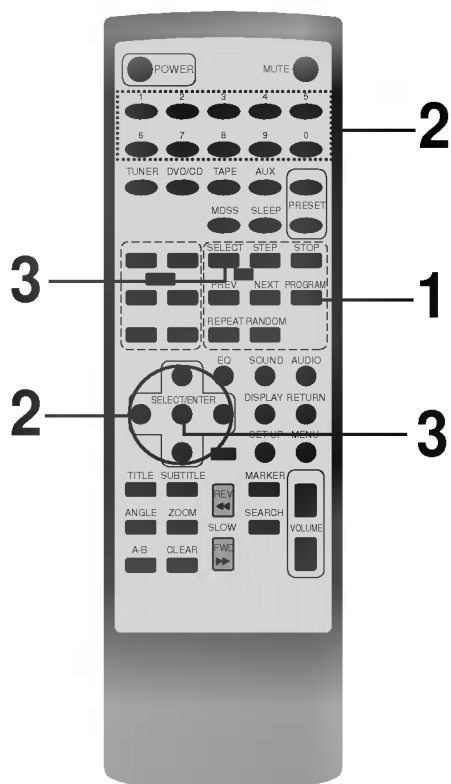

Press the PROGRAM during playback or stop mode.

The programme playback screen appears on the TV screen.

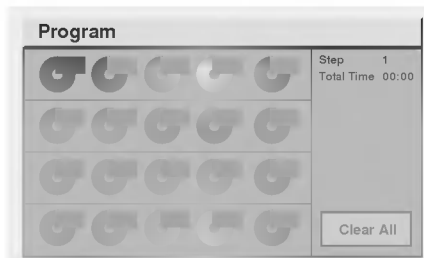

• To exit the screen, press the **PLAY** or **PROGRAM**.

Press the ▲/▼/◀/▶ and press the numeric button(s), to select the desired track number.

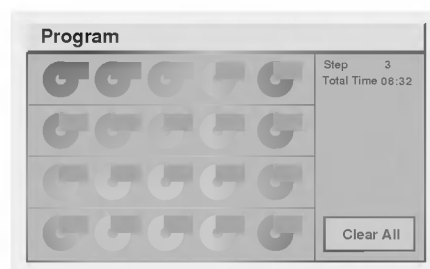

- Repeat step 2 to select another track.
- Up to 20 tracks can be programmed.

Press the PLAY or SELECT/ENTER to exit the screen.

The selected track is stored in the memory and play now begins in the programmed sequence.

- If you press the **PROGRAM** to exit the screen, the selected tracks are not memorized.

After playback of all tracks programmed

Play is stopped.

Clearing the programme

● **To clear the programme one by one**

Press the ▲/▼/◀/▶ to select the unwanted No. and then press the **CLEAR**.

● **To clear all the programmes**

Press the ▲/▼/◀/▶ to select the "Clear All" and press the **SELECT/ENTER**. Press the **PLAY** or **SELECT/ENTER** to exit the screen. If you press the **PROGRAM** to exit the screen, the programmes are not cleared. (The programmes are also cleared when the power is turned off or the disc is removed.)

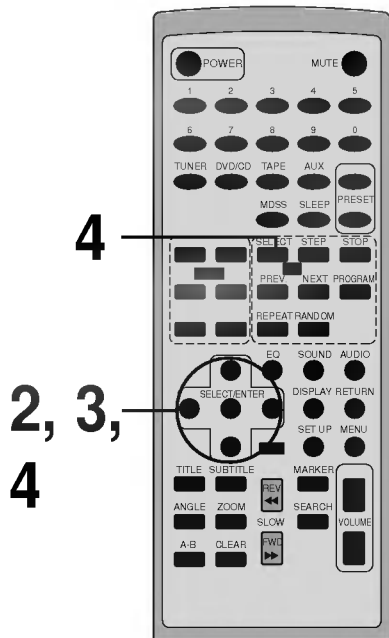

To play an MP3 file

Load an MP3 disc.
The MP3 menu is displayed.

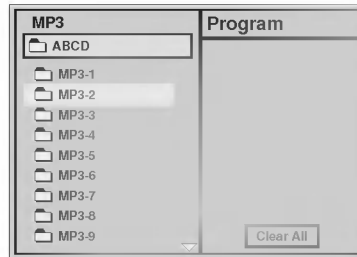

Press the ▲/▼ buttons to select the directory where MP3 files that you want to play are located and then press the SELECT/ENTER.

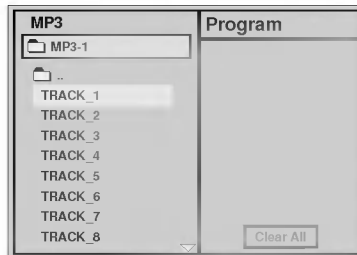

Press the ▲/▼ button to select the desired MP3 file of the selected directory on your disc.

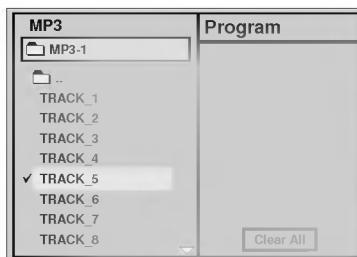

If you want to return to the previous menu, press the **RETURN** button.

Press the SELECT/ENTER or PLAY to start playback of a file.

For your reference

- Press the **NEXT** ►► or **PREV.** ◀◀ to play the next file or previous file during playback.
- Press the **TITLE** to move to 1st page of current directory during playback and press the **TITLE** again to move to the next page within 5 seconds.
- Press the **MENU** to move to the Root Directory during playback.

- The directory and file name is only displayed in English.
- If there is an impossible code to display, it will be displayed underlined () instead of English.
- If a directory has no MP3 file, the "⊘" is displayed with the directory name.
- This unit can play up to 256 files per disc. A disc recorded with more than 256 files cannot be played.
- The maximum allowable depth of nested folder is 50.
- Disc format is compatible with ISO9660 only.
- If you record MP3 files using the software which cannot create a FILE SYSTEM, for example "Direct -CD" etc., it is impossible to playback MP3 files. We therefore recommend that you use "Easy-CD Creator", which creates an ISO9660 file system.
- A single session disc requires MP3 files in the first track. If there is no MP3 file in the 1st track, it cannot playback MP3 files. If you wish to playback MP3 files, format all the data in the disc or use a new one.
- If there are already data files which are not MP3 files on the CD-R disc, please, do not use that disc; use a new one instead. However, if the disc is a CD-RW disc, this does not apply.
- If you select another file by pressing ▲/▼ during playback, the file is played after 5 seconds automatically.
- If you select a directory by pressing ▲/▼ during playback, the playback is stopped after 5 seconds.

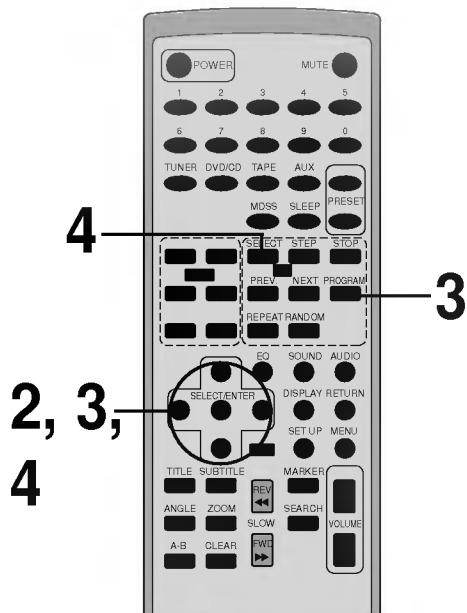

To programme play an MP3 file

- Follow steps 1 to 2 on previous page.
- Select an MP3 file to programme with ▲/▼.

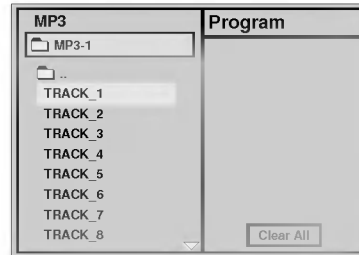

- Press the **PROGRAM** button to add an MP3 file on the programme list.



- Repeat steps 2 - 3 to select another track.
- Up to 60 files can be programmed.

- Press the ► button and select the desired MP3 file and press the **SELECT/ENTER** or **PLAY** button to play.

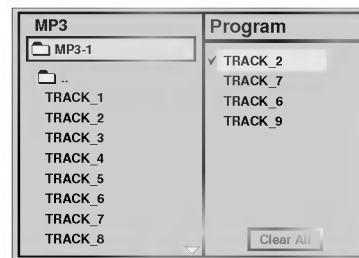

To play an MP3 file repeatedly

- If you press the **REPEAT** button once during play, the current MP3 file will play repeatedly.
- If you press the **REPEAT** button twice during play, the all MP3 files on the programme list will play repeatedly.
- If you press the **REPEAT** button three times, the repeat play will be cancelled.

REPEAT symbol

Clearing the programme

- To clear the programme one by one**
Press the ▲/▼/◀/▶ to select the unwanted MP3 file on the programme list and then press the **CLEAR**.
- To clear all the programmes**
Press the ▲/▼/◀/▶ to select the "Clear All" and press the **SELECT/ENTER**.

If you want to enter the main menu, press the ◀ button.

After playback all tracks programmed
Play is stopped.



Once the initial settings have been completed, the unit can always be operated under the same conditions (especially with DVD discs). The settings will be retained in the memory until they are changed, even if the power is switched off.

Selection of initial settings

Press the **SETUP** in the stop or playback mode. The SETUP menu is displayed.



Press the **▲/▼** to select the desired item. The screen will show the current setting for the selected item, and the alternate setting(s).

- Disc Audio
- Disc Subtitle (see page 38)
- Disc Menu
- Rating (see page 39)
- Password (see page 40)
- TV Aspect (see page 41)
- Menu Language (see page 42)
- Digital Audio Output (see page 43)
- 5.1 Speaker Setup (see page 44)
- Others (DRC/Pseudo PAL/Vocal) (see page 45)

Press the **▶** and then **▲/▼** to select the desired setting and press the **SELECT/ENTER**.

- Some items require additional steps. (See the respective page.)

When the alternate setting is selected the screen returns to the Initial Settings display.

To exit SETUP menu

Press the **SETUP**, **RETURN** or **PLAY**.

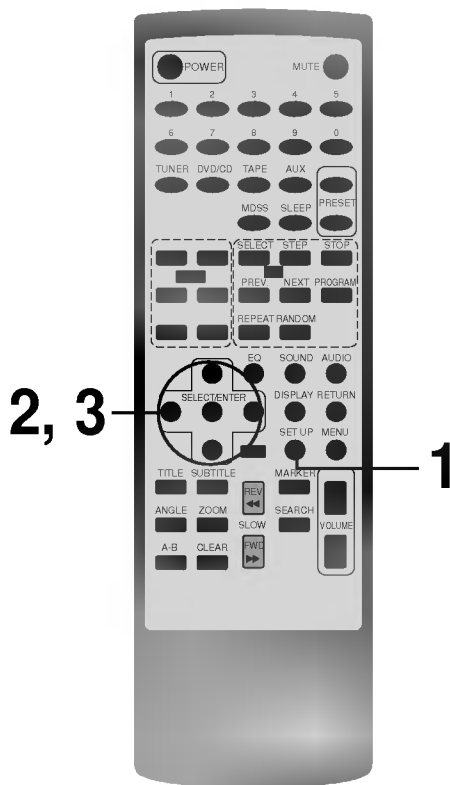



This is to select the audio soundtrack language, subtitle language and the language used in title menus or DVD menus which will always be used for every disc to be played back.

When you play back a DVD video disc, the unit automatically displays the pre-selected subtitle language if it is included on the disc.

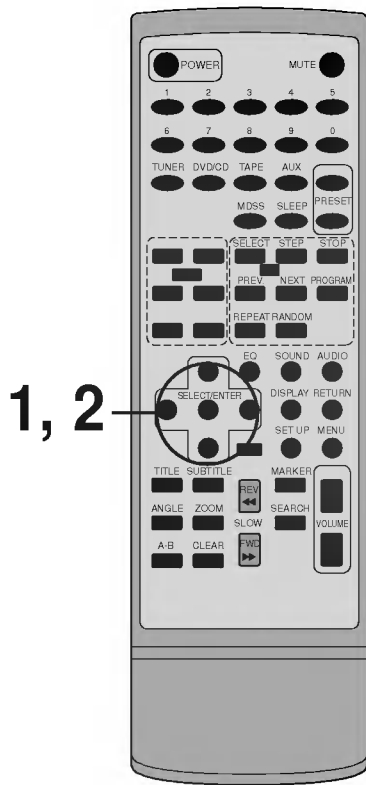

At the setup screen, press the ▲/▼ to select “Disc Audio” and press ►.



Press the ▲/▼ to select the desired language and then press the SELECT/ENTER.



Original :The original language of each disc will be selected.

English : The English will be Selected.

Other : Another language can be selected. You can input 4-digit language code. (Refer to the language codes on page 46. Press the **CLEAR** if an incorrect language code is entered.)

The “Disc Subtitle” and “Disc Menu” are selected by the same method.

- If the language selected is not available on the disc, the original language designated by each disc will be selected.



This is to prohibit the playing of specified DVDs which are unsuitable for children.

- Some DVD discs contain a restriction level which enables parents to remove scenes or prevent playback of discs by children. This units are equipped with a password designed to prevent children changing the level.

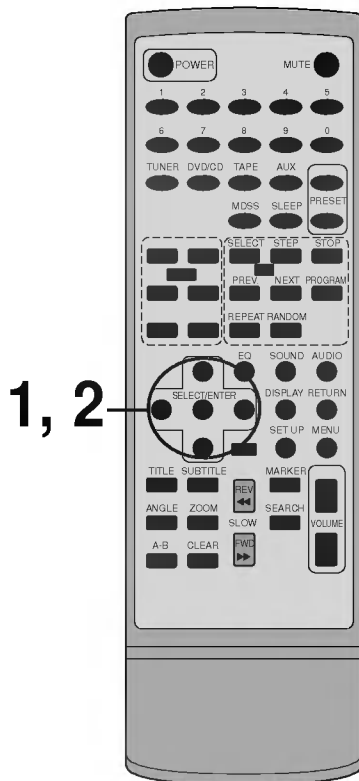

Selecting rating level (DVD only)

- ▶ At the **SETUP** screen, press the **▲/▼** to select “Rating” and press the **▶**.

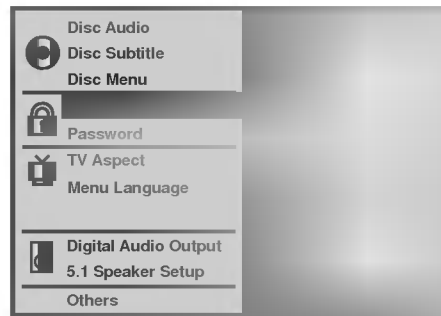

- ▶ Press the **▲/▼** to select the desired level and press the **SELECT/ENTER**.

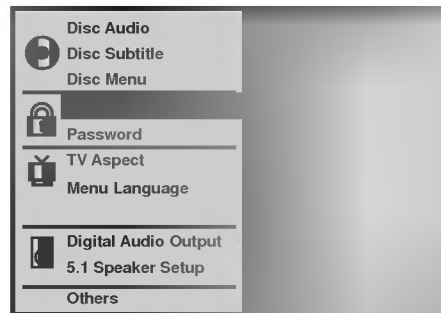

You cannot play DVD video discs rated higher than the level you selected unless you cancel the parental lock function. For example, when you select level 7, discs rated higher than level 7 are blocked and cannot be played.

If you change the level and enter a password, playback of all DVDs with ratings higher than your selection will be blocked, unless the correct password is entered again. For example: if you change the level to “5”, the unit will not play discs with ratings of “6”, “7” or “8” unless the correct password is entered on the remote control.

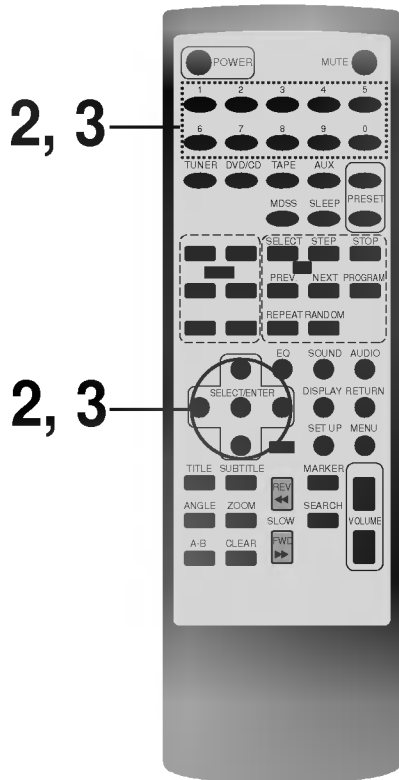

Setting your password (DVD only)

If you change the rating level to “7” or lower, you must enter a 4-digit “password” to prevent playback of discs with higher ratings.

- At the **SETUP** screen, press the **▼** to select “Password” and press the **▶**.

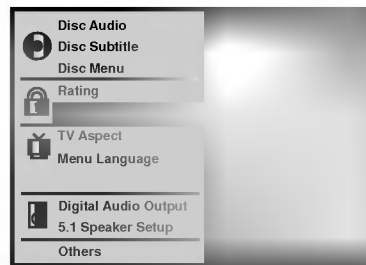

- Input a 4-digit password and press the **SELECT/ENTER**.

Example : 1234

Do not forget your password.

- Input the 4-digit password again and press the **SELECT/ENTER** to verify.

Setting is finished.

- The rating is locked. Any discs whose rating is higher than the setting cannot be played back unless the correct password is entered.

To change/clear memorized password

- At the **SETUP** screen, press the **▼** to select “Password” and press the **▶**.

- Input your password and press the **SELECT/ENTER**.



- To change or clear your password, press the **▲/▼** to select the “Change” or “Clear” and press the **SELECT/ENTER**.

To change the rating level/password, follow the steps on page 39-40 again.

To clear your 4-digit password

If you forget your password, to clear the current password, follow the procedure below.

At the **SETUP** screen

- Press the **▼** to select “Password” item.
- Enter 6-digit number “210499” and then press the **SELECT/ENTER**.
The 4-digit password is cleared.
- Enter a new password
Refer to “Setting your password” section on the right.



Select the appropriate screen type according to your TV set; conventional size screen (4:3) or wide-screen (16:9).

At the SETUP screen, press the ▲/▼ to select "TV Aspect" and press the ►.

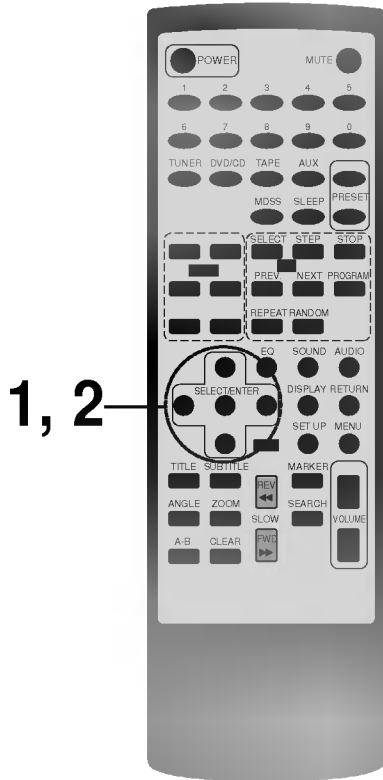

Press the ▲/▼ to select the desired Aspect and press the SELECT/ENTER.

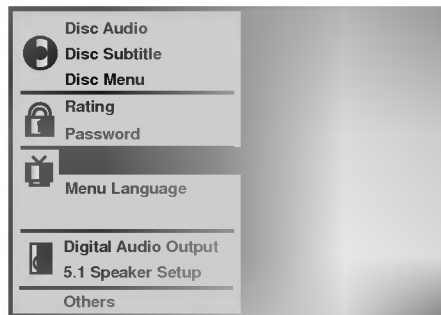

4:3 Letterbox : The video material not formatted in the Pan & Scan style is played back in the letterbox style (black bands appear at top and bottom of screen).

4:3 Panscan : Select when a conventional TV set is connected. The video material formatted in the Pan & Scan style is played back in that style (the left and right edges are cut off).

16:9 Wide : Select when a wide-screen TV set is connected. Played in "FULL" size. (Setting the wide-screen TV to "FULL" mode is also necessary.)

* Each screen shows an example when the video material for a wide-screen is played. (This setting does not affect the video material for conventional size.)



4:3 Letterbox

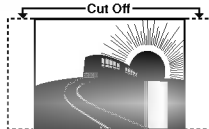

4:3 Panscan

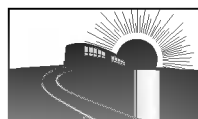

16:9 Wide



Selects language for DVD menus and displays on the TV.

At the SETUP screen, press the ▲/▼ to select “Menu Language” and press the ►.

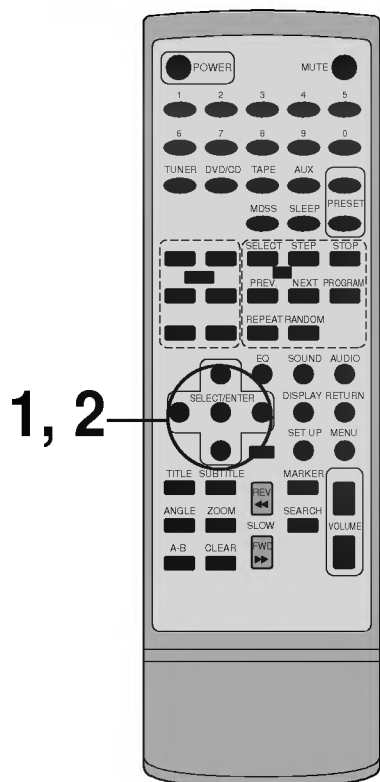

Press the ▲/▼ to select the desired Language and press the SELECT/ENTER.





Each DVD disc has a variety of audio output options. Set the unit's Digital Audio Output according to the type of audio system you use.

At the SETUP screen, press the ▲/▼ to select Digital Audio Output and press the ►.

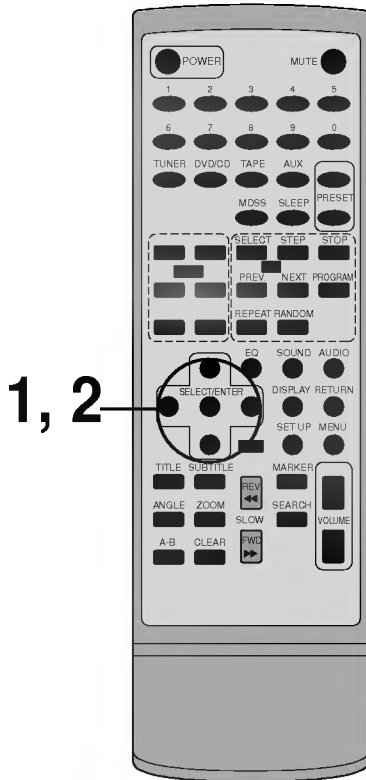

Press the ▲/▼ to select the desired output and press the SELECT/ENTER.



DOLBY DIGITAL/PCM: Select "DOLBY DIGITAL/PCM" if an active digital output is supplied to a Dolby Digital decoder, (or an amplifier or other equipment with Dolby Digital decoder).

Stream/PCM: Select "Stream/PCM" if an active digital output is supplied to an amplifier or other equipment with Dolby Digital decoder and MPEG decoder.

PCM: Select "PCM" if an active digital output is supplied to an amplifier or other equipment with linear PCM only (or MD recorder or DAT deck).

Playback Disc	OUTPUT		
	Stream/PCM	Dolby Digital/PCM	PCM only
96 kHz Linear PCM DVD	PCM	PCM	PCM
Dolby Digital DVD	Dolby Digital bit Stream	Dolby Digital bit Stream	PCM
MPEG DVD	MPEG bit Stream	PCM	PCM
Audio CD	PCM	PCM	PCM

- When you are not using the unit's digital audio output, don't select any of the options.
- If an active digital audio output signal is supplied to a unit or other equipment without a corresponding digital decoding capability, a very loud noise may be produced which could permanently damage the speakers.



Select the speaker to adjust the audio output mode of the speaker.

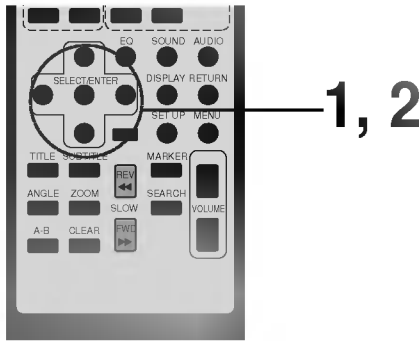

At the SETUP screen, press the ▲/▼ to select "5.1 Speaker Setup" and press the ►.

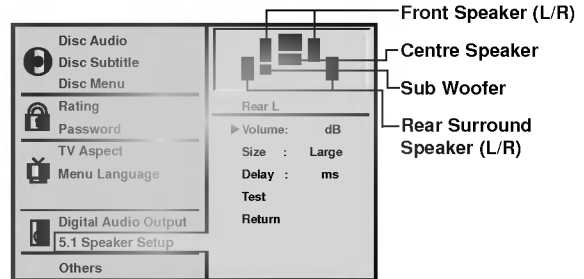

Press the ◀/▶ to select the desired speaker and press the ▲/▼/◀/▶ to adjust options.



- Do not place the centre or rear speakers further away from the listening position than the front speakers.
- The test tone does not output from the subwoofer.

Volume: Press the ◀/▶ to adjust the output level of selected speaker. (-6dB ~ 0dB)

Size: Press the ◀/▶ to set a mode. (Large, Small, None)

- If you have connected the system to a speaker with low frequency of 100Hz or below, select "Large"
- If you have connected the system to a speaker without low frequency of 100Hz or below, select "Small" But if you haven't connected to sub woofer, always select "Large" of Front Speaker (L/R).
- When you don't connect to speaker, select "None".
- Front L/R speaker's size can be selected to Large" or "Small".
- If Front L/R speaker's size is selected to "Small", Rear and Centre speaker's size can be selected to "Small" or "None", and Sub woofer speaker's size can be selected only to "Large".

Delay: Press the ◀/▶ to customize the sound to conform to the acoustics of your room by adding a delay effect to the sound of the Centre Speaker and Surround Speaker.

- When 5.1CH Surround is played, you can enjoy the best sound if the distance between you and each speaker is same. You can set Delay time in the Centre/Surround Speaker to customize the sound to to the acoustic of your room. (Centre: 0 ~ 5ms, Rear: 0 ~ 15ms).

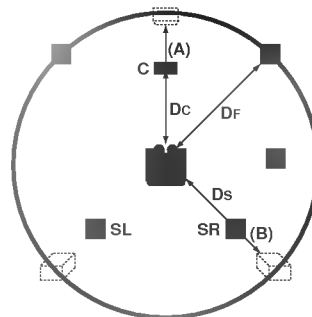

• **Setting Centre Speaker**
If the distance of DC is equal to or longer than the DF in the left figure, set the mode as 0ms. Otherwise, change the setting according to the table below.

(A) = DF - DC

Distance of (A)(cm)	Setting(ms)
34	1
68	2
102	3
136	4
170	5

• **Setting Rear Surround Speaker**

If the distance of DF is equal to the distance of Ds in the above, set the mode as 0ms. Otherwise, change the setting according to the table below.

(B) = DF - Ds

Distance of (B)(cm)	Setting(ms)
170	5
340	10
510	15

Test : Press the SELECT/ENTER to test signals of each speaker. Adjust Volume to match to the volume of test signals memorized in the system.

- Front (L) → Front (R) → Centre → Rear (L) → Rear (R)

Return: Press the SELECT/ENTER to return to the previous menu screen.



The DRC, Pseudo PAL and Vocal settings can be changed.

At the SETUP screen, press the ▲/▼ to select "Others" and press the ►.

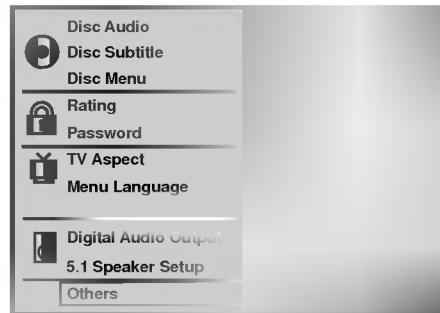
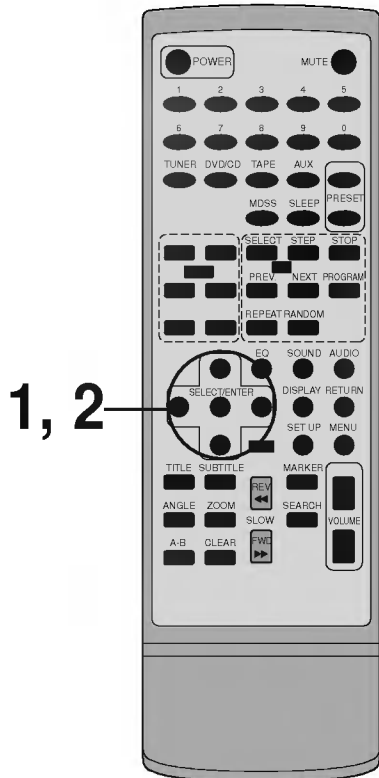

Press the ▲/▼ to select the desired items and press the SELECT/ENTER.

■ **DRC (Dynamic Range Compression) On/Off**

On: Select this option to turn on the Dynamic Range Compression circuitry so that the dialogue remains clear even at low volume levels.

Off: Select this option to turn off the Dynamic Range Compression and have the soundtrack presented exactly as it was created.

■ **Pseudo PAL On/Off**

On: A NTSC DVD disc can be played back with the PAL colour system TV set, depending on the disc.

Off: A NTSC DVD disc cannot be played back with the PAL colour system TV set.

■ **Vocal On/Off**

Set to On only when a multi-channel karaoke DVD is being played. The karaoke channels on the disc will then be mixed into a normal stereo sound.

About DRC (Dynamic Range Compression)

With the DVD format you have the opportunity to hear a programme's soundtrack in the most accurate and realistic presentation possible, thanks to the use of digital audio technology. However, in certain instances you may wish to slightly compress the dynamic range of the audio output (the difference between the loudest sounds and the quietest ones) so that you may listen to a movie at a lower volume without losing dialogue intelligibility.

- The DRC function works only during playback of Dolby Digital recorded discs.
- The level of Dynamic Range Compression may differ depending on the DVD disc.
- When playing karaoke, connect appropriate audio equipment such (such as an amplifier) to the unit.
- The Pseudo PAL can be displayed when the SYSTEM selector on the rear panel is switched to PAL mode.
- If there are any problems during playback of a NTSC disc, select the "Pseudo PAL" to "On" mode.
- The picture can be streamed according to TV type when the "Pseudo PAL" is in "On" mode.





Enter the appropriate code number for the initial settings "Audio", "Subtitle" and/or "Menu" (See page 38).

Code	Language	Code	Language	Code	Language	Code	Language
6565	Afar	7079	Faroese	7678	Lingala	8375	Slovak
6566	Abkhazian	7082	French	7679	Laothian	8376	Slovenian
6570	Afrikaans	7089	Frisian	7684	Lithuanian	8377	Samoan
6577	Ameharic	7165	Irish	7686	Latvian, Lettish	8378	Shona
6582	Arabic	7168	Scots Gaelic	7771	Malagasy	8379	Somali
6583	Assamese	7176	Galician	7773	Maori	8381	Albanian
6588	Aymara	7178	Guarani	7775	Macedonian	8382	Serbian
6590	Azerbaijani	7185	Gujarati	7776	Malayalam	8385	Sundanese
6665	Bashkir	7265	Hausa	7778	Mongolian	8386	Swedish
6669	Byelorussian	7273	Hindi	7779	Moldavian	8387	Swahili
6671	Bulgarian	7282	Croatian	7782	Marathi	8465	Tamil
6672	Bihari	7285	Hungarian	7783	Malay	8469	Telugu
6678	Bengali; Bangla	7289	Armenian	7784	Maltese	8471	Tajik
6679	Tibetan	7365	Interlingua	7789	Burmese	8472	Thai
6682	Breton	7378	Indonesian	7865	Nauru	8473	Tigrinya
6765	Catalan	7383	Icelandic	7869	Nepali	8475	Turkmen
6779	Corsican	7384	Italian	7876	Dutch	8476	Tagalog
6783	Czech	7387	Hebrew	7879	Norwegian	8479	Tonga
6789	Welsh	7465	Japanese	7982	Oriya	8482	Turkish
6865	Danish	7473	Yiddish	8065	Panjabi	8484	Tatar
6869	German	7487	Javanese	8076	Polish	8487	Twi
6890	Bhutani	7565	Georgian	8083	Pashto, Pushto	8575	Ukrainian
6976	Greek	7575	Kazakh	8084	Portuguese	8582	Urdu
6978	English	7576	Greenlandic	8185	Quechua	8590	Uzbek
6979	Esperanto	7577	Cambodian	8277	Rhaeto-Romance	8673	Vietnamese
6983	Spanish	7578	Kannada	8279	Rumanian	8679	Volapük
6984	Estonian	7579	Korean	8285	Russian	8779	Wolof
6985	Basque	7583	Kashmiri	8365	Sanskrit	8872	Xhosa
7065	Persian	7585	Kurdish	8368	Sindhi	8979	Yoruba
7073	Finnish	7589	Kirghiz	8372	Serbo-Croatian	9072	Chinese
7074	Fiji	7665	Latin	8373	Singhalese	9085	Zulu

Disc Requirements/Copyright Information

This unit can play back the following discs.

	Disc mark	Contents	Disc size	Maximum playback time
DVD video discs		Audio+Video (moving pictures)	12 cm	Approx. 4 hours (single sided disc)
				Approx. 8 hours (double sided disc)
			8 cm	Approx. 80 minutes (single sided disc)
				Approx. 160 minutes (double sided disc)
Audio CDs		Audio	12 cm	74 minutes
			8 cm	20 minutes

In addition, this unit can play back a CD-R or CD-RW that contains audio titles or MP3 files.

You cannot playback discs other than those listed above. (Video CD, CD-ROM, CD-Extra, CD-G, photo CD, and CD-i discs can not be played on this unit.)

Region Management Information

Region Management Information: This unit is designed and manufactured to respond to the Region Management Information that is recorded on a DVD disc. If the Region number described on the DVD disc does not correspond to the Region number of this unit, this unit cannot play that disc.

The Region number of this unit is 2.



Notes on Unauthorized Discs

You may not be able to play back some DVD video discs on this unit if they were purchased from outside your geographic area or made for business purposes.

When you try to play back an unauthorized disc, "**Check Regional Code**" appears on the TV screen.

Notes on Copyright

It is forbidden by law to copy, broadcast, show, broadcast on cable, play in public, and rent copyrighted material without permission.

DVD video discs are copy protected, and any recordings made from these discs will be distorted.

This unit incorporates copyright protection technology that is protected by method claims of certain U.S. patents and other intellectual property rights owned by Macrovision Corporation and other rights owners. Use of this copyright protection technology must be authorized by Macrovision Corporation, and is intended for home and other limited viewing uses only, unless otherwise authorized by Macrovision Corporation. Reverse engineering or disassembly is prohibited.

Before Calling Service Personnel

Symptoms and Correction

Check the following guide for the possible cause of a problem before contacting service.

Symptom	Cause	Correction
No power.	<ul style="list-style-type: none"> The power cord is disconnected. 	<ul style="list-style-type: none"> Plug the power cord into the wall outlet securely.
The power is on, but the unit does not work.	<ul style="list-style-type: none"> No disc is inserted. 	<ul style="list-style-type: none"> Insert a disc. (Check that the DVD or, CHP/TRK indicator in the display window is lit.)
No picture.	<ul style="list-style-type: none"> The TV is not set to receive DVD signal output. 	<ul style="list-style-type: none"> Select the appropriate video input mode on the TV so the picture from the unit appears on the TV screen.
	<ul style="list-style-type: none"> The video cable is not connected securely. 	<ul style="list-style-type: none"> Connect the video cable into the jacks securely.
	<ul style="list-style-type: none"> The connected TV power is turned off. 	<ul style="list-style-type: none"> Turn on the TV.
There is no sound or only a very low-level sound is heard.	<ul style="list-style-type: none"> The equipment connected with the audio cable is not set to receive DVD signal output. 	<ul style="list-style-type: none"> Select the correct input mode of the audio receiver so you can listen to the sound from the receiver.
	<ul style="list-style-type: none"> The audio cables are not connected securely. 	<ul style="list-style-type: none"> Connect the audio cable into the jacks securely.
	<ul style="list-style-type: none"> The power of the equipment connected with the audio cable is turned off. 	<ul style="list-style-type: none"> Turn on the equipment connected with the audio cable.
	<ul style="list-style-type: none"> The audio connecting cord is damaged. 	<ul style="list-style-type: none"> Replace it with new one.
The playback picture is poor.	<ul style="list-style-type: none"> The disc is dirty. 	<ul style="list-style-type: none"> Clean the disc.
The unit does not start playback.	<ul style="list-style-type: none"> No disc is inserted. 	<ul style="list-style-type: none"> Insert a disc. (Check that the DVD, or CHP/TRK indicator in the display window is lit.)
	<ul style="list-style-type: none"> An unplayable disc is inserted. 	<ul style="list-style-type: none"> Insert a playable disc. (Check the disc type, color system and Regional code.)
	<ul style="list-style-type: none"> The disc is placed upside down. 	<ul style="list-style-type: none"> Place the disc with the playback side down.
	<ul style="list-style-type: none"> The disc is not placed within the guide. 	<ul style="list-style-type: none"> Place the disc on the disc tray correctly inside the guide.
	<ul style="list-style-type: none"> The disc is dirty. 	<ul style="list-style-type: none"> Clean the disc.
	<ul style="list-style-type: none"> A menu is on the TV screen. 	<ul style="list-style-type: none"> Press the SET UP button to turn off the menu screen.
	<ul style="list-style-type: none"> The Rating level is set. 	<ul style="list-style-type: none"> Cancel the Rating function or change the rating level.
Severe hum or noise is heard.	<ul style="list-style-type: none"> The plugs and jacks are dirty. 	<ul style="list-style-type: none"> Wipe them with a cloth slightly moistened with alcohol.
	<ul style="list-style-type: none"> The disc is dirty. 	<ul style="list-style-type: none"> Clean the disc.
	<ul style="list-style-type: none"> The speakers and components are connected poorly. 	<ul style="list-style-type: none"> Connect the speakers and components securely.
	<ul style="list-style-type: none"> The unit is located with TV nearby. 	<ul style="list-style-type: none"> Move your TV away from the audio components.

Before Calling Service Personnel (Cont'd)

Symptoms and Correction

Symptom	Cause	Correction
Recording cannot be done.	• The components are connected incorrectly.	• Connect the components correctly.
	• The source is selected in correctly.	• Select the source with the FUNCTION SELECT button (CD/DVD, TAPE, AUX or Tuner).
Radio stations cannot be tuned in.	• The antennas are connected poorly.	• Connect the antenna securely.
		• Adjust the antennas and connect an external antenna if necessary.
	• The signal strength of the stations is too weak (when tuning in with automatic tuning).	• Tune in the station manually.
	• No stations have been preset or preset stations have been cleared (when tuning by scanning preset stations).	• Preset the stations (receiver 17).
The remote control does not work properly.	• The remote control is not pointed at the remote sensor of the unit.	• Point the remote control at the remote sensor of the unit.
	• The remote control is too far from the unit.	• Operate the remote control within about 23 ft (7 m).
	• There is an obstacle in the path of the remote control and the unit.	• Remove the obstacle.
	• The batteries in the remote control are exhausted.	• Replace the batteries with new ones.

Specifications

[General]	Power supply	Refer to the back panel		
	Power consumption	95W		
	Mass	5.5kg		
	External dimensions (W x H x D)	180 x 248 x 287.3 mm		
[CD/DVD]	Laser	Semiconductor laser, wavelength 650 nm		
	Signal system	PAL 625/50, NTSC 525/60		
	Frequency response (audio)	40 - 18,000 Hz		
	Signal-to-noise ratio (audio)	More than 70 dB (1 kHz)		
	Signal-to-noise ratio (video)	More than 60 dB (1 kHz)		
	Dynamic range (audio)	More than 70 dB		
	Harmonic distortion (audio)	0.2 % (1 kHz)		
[Video]	Video output	1.0 V (p-p), 75 Ω, negative sync., RCA jack		
	S-video output	(Y) 1.0 V (p-p), 75 Ω, negative sync., Mini DIN 4-pin x 1 (C) 0.3 V (p-p), 75 Ω		
[Tuner]	FM	Tuning Range	87.5 - 108.0 MHz or 65 -74 MHz, 87.5 -108.0 MHz	
		Intermediate Frequency	10.7 MHz	
		Signal to Noise Ratio	60 dB	
		Frequency Response	60 - 10,000 Hz	
	AM (MW)	Tuning Range	522 - 1,611 kHz or 530 - 1,610 kHz	
		Intermediate Frequency	450 kHz	
		Signal to Noise Ratio	40 dB	
		Frequency Response	100 - 2,000 Hz	
[Amplifier]	output Power	STEREO: 20W X 2 (6 Ω 2CH THD10%) SURROUND MODE: 16W X 5 (6Ω 5CH THD 10%)		
	T.H.D	0.2%		
	Frequency Response	30 - 30,000 Hz		
	Signal-to-noise ratio	80 dB		
[Speakers]	Model name	Front Speaker (FE-DV25VE)	Satellite Speaker (FE-DV25TE)	
	Type	2 Way 2 Speaker	1 Way 1 Speaker	
	Impedance	6 Ω	6 Ω	
	Frequency Response	70 - 20,000 Hz	120 - 20,000 Hz	
	Sound Pressure Level	86 dB/W (1m)	84 dB/W (1m)	
	Rated Input Power	25 W	16 W	
	Max. Input Power	50 W	30 W	
	Net Dimensions (W x H x D)	160 x 248 x 175 mm	90 x 125 x 106 mm	
	Net Weight	2.35 kg	0.61 kg	
Tape	Tape Speed	3 kHz ± 50Hz		
	Wow Flutter	0.25% (MTT -111, JIS-WTD)		
	F.F/REW Time	120sec (C-60)		
	Frequency Response	125 - 8,000Hz		
	Signal to Noise Ratio	43dB		
	Channel Separation	45dB(P/B)/42dB(R/P)		
	Erase Ratio	52dB (MTT-5511)		
[Supplied Accessories]	<ul style="list-style-type: none"> • Audio cable1 • Speakers5 • Remote control1 • AM loop antenna1 • RCA-SCART Adapter1 	<ul style="list-style-type: none"> • Video cable1 • Speaker cables3 • Batteries (AAA)2 • FM antenna1 		

* Designs and specifications are subject to change without notice.

P/NO: 3828R-A007G