



Please read this manual carefully before operating your set.
Retain it for future reference.
Record model number and serial number of the set.
See the label attached on the bottom of the set and quote this information to your dealer when you require service.

Model number :
Serial number :

LG LCD PROJECTOR



LCD PROJECTOR



CONTENTS

INDEX

Before operating the unit, please read this manual carefully.

1	Safety Instructions	3	INTRO- DUCTION
	Names of parts	7	
2	Installation Instructions	13	INSTALLATION AND COMPOSITION
	Composition	15	
	Turning on the Projector	17	
	Turning off the Projector	18	
	Operating the Projector	19	
3	Selecting source mode	20	CONNECTION
	Connecting to a Desktop PC	21	
	Connecting to a Notebook PC	22	
	Connecting to a Macintosh Desktop PC	23	
	Connecting to a Macintosh PowerBook	26	
	Connecting to a Video Source	27	
4	Connecting to a D-TV Settop Box	28	BASIC FUN- CTIONS
	Function checking	29	
5	Using Still function	30	SPECIAL FUNCTIONS
	Selecting language	31	
	Checking lamp time	32	
	Using Blank function	33	
	Using Flip Horizontal / Vertical function	35	
6	Selecting PC screen size input signal	37	POS- TIONING
	Using Resize function	38	
7	Adjusting screen display	39	TRACK- ING
	Using Tracking function	41	
8	Adjusting Video	43	VIDEO
9	Supported Monitor Display	44	INFORMATION
	Maintenance	45	
	Specifications	46	

▶ Always keep the safety instructions to prevent any potential accident or misuse of the projector.

▶ Safety Instructions have two kinds of information, and each meaning of it is as below.

 **WARNING** The violation of this instruction may cause serious injuries and even death.

 **NOTES** The violation of this instruction may cause light injuries or damage of the projector.

* The meanings of symbols in the manual and the unit are as below.

▶  Take care of danger that may happen under specific condition.

▶  Take care of electric shock that may happen under specific condition.

▶ After reading this manual, keep it in the place that the user always can contact easily.

Do not attempt to repair or adjust this equipment. Contact your dealer or Service center. High risk of electric shock!

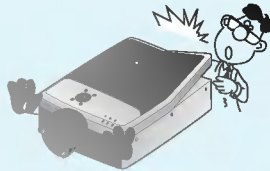

Do not place anything containing liquid on top of the projector. High risk of Electric Shock or damage to the projector.

This may cause a fire or could give an electric shock.

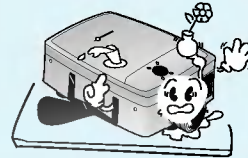

Don't insert any object into the exhaust vent .

This may cause a fire or could give an electric shock.

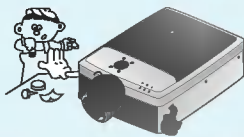

Earth wire should be connected.

- If the earth wire is not connected, there is possible a danger of electric shock caused by the current leakage.
- If grounding methods are not possible, a separate circuit breaker should be employed and installed by a qualified electrician.
- Do not connect ground to telephone wires, lightning rods or gas pipe.

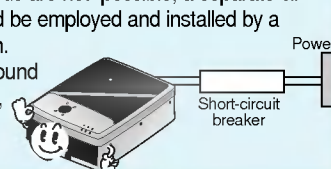

Don't remove any covers (except lens cover). High risk of Electric Shock!

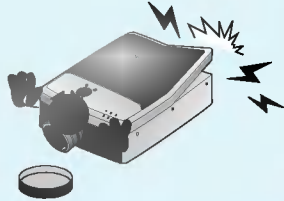

Use an air spray or soft cloth that is wet with a neutral detergent and water for removing dust or stains on the projection lens.

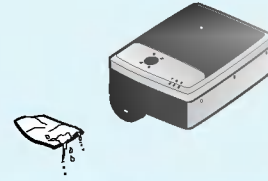

Only use the correct type of batteries for the remote control. Dispose of used batteries carefully.

This may cause a fire or could give an electric shock.

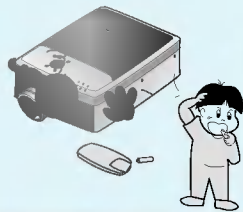

Don't look directly onto the lens when the projector is in use. Eye damage may occur!

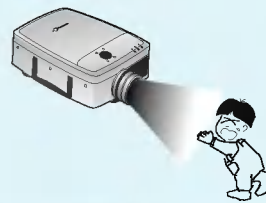

Don't use the projector in damp place such as a bathroom or any place where it is likely to get wet. Serious damage could occur or risk of Electric Shock!

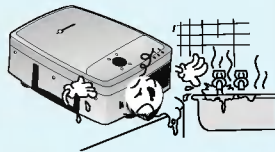

Don't use the projector if there is smoke or unusual smell from the projector. Disconnect from the mains and contact the service center. Risk of fire!

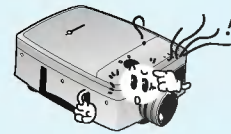

Don't look at laser beam directly as it may cause eye damage.

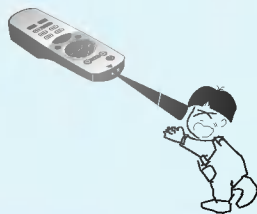

Don't clog the opening(absorption tube/exhaust pipe) of the projector.

It makes internal temperature increase and causes a fire.

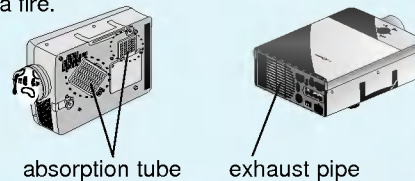

No impact on the lens while moved.

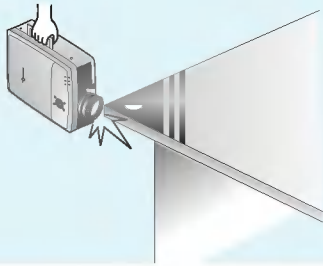

No contact while working, or right after the lamp is off since the exhaust port and the lamp lid generate heat.

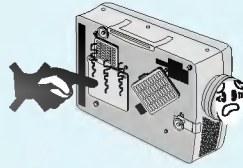

Only use the projector on a level and stable surface.

It may fall down or be upset.



Be sure to unplug when you don't use the projector for a long period or you are absent.

Accumulated dust may cause a fire, electric shock from deterioration, or electric leakage.

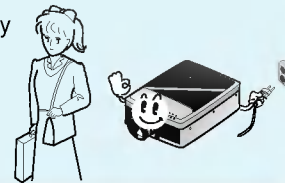

Never touch the power plug with wet hand.

It may cause electric shock.

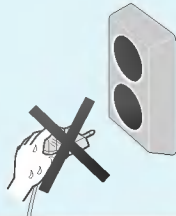

Don't use alcohol, benzene, or thinners to clean any plastic parts of the projector. Never use industrial chemicals or detergents.

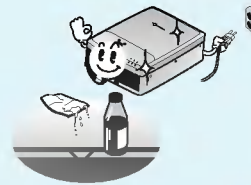

Ensure the power lead doesn't trail across any hot objects like a heater.

It may cause a fire or electric shock.

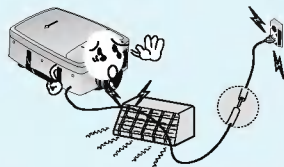

Disconnect from the mains and remove all connections before moving.

Damage of cords may cause a fire or electric shock.

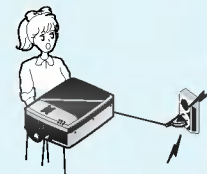

Don't touch the lens of the projector. It may cause damage of it.

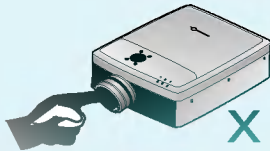

Don't use any sharp tools on the projector as this will damage the casing.

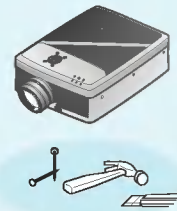

If the projector requires cleaning inside contact the service centre. Accumulated dust can cause mechanical failure.



Place the projector where people will not trip or tread on the power lead.

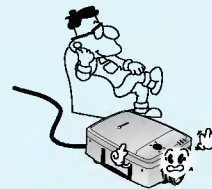

Use the indicated type of power source on the projector. If you are not sure of the type of power available, consult your dealer or customer service center.

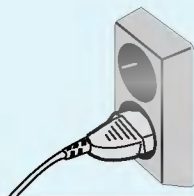

Don't place the projector or the remote control on a heater or use in a heated car.

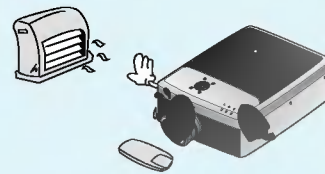

Don't use the projector when the power cord or the plug is damaged or the connecting part of wall socket is loose.

It may cause electric shock or a fire.

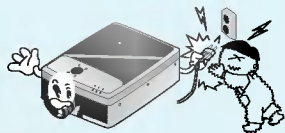

Contact your dealer for replacing a new lamp.

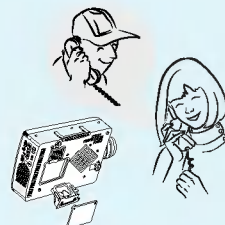

Main Body

* The LCD projector is manufactured using high-precision technology. You may, however, see tiny black points and/or bright points (red, blue, or green) that continuously appear on the LCD projector. This is a normal result of the manufacturing process and does not indicate a malfunction.

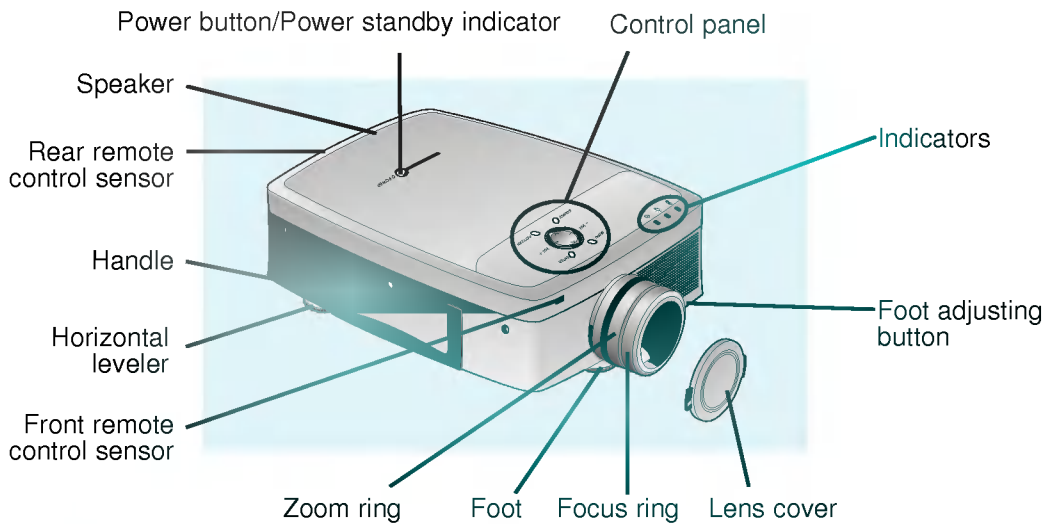

Rear Connecting Part

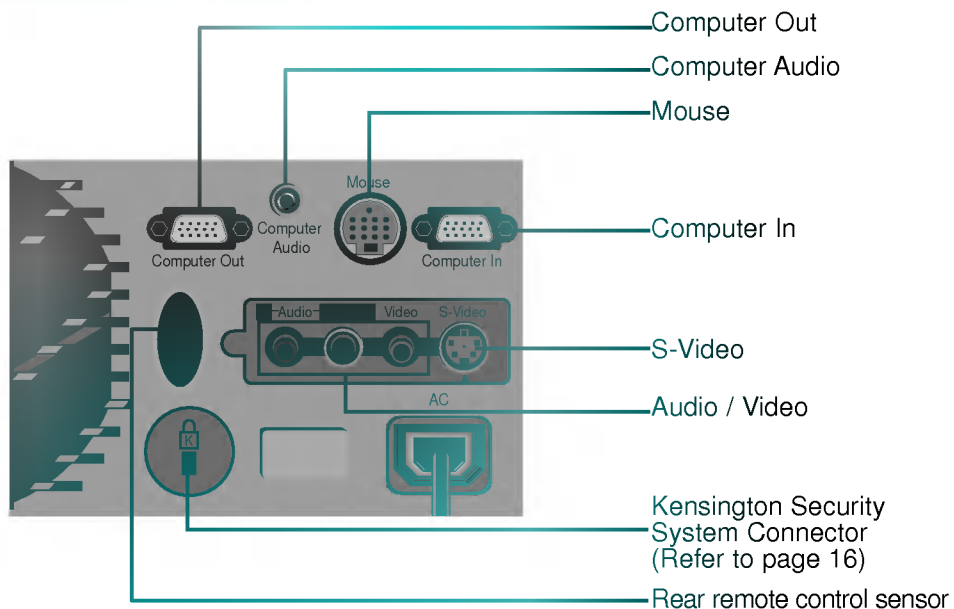

Control Panel

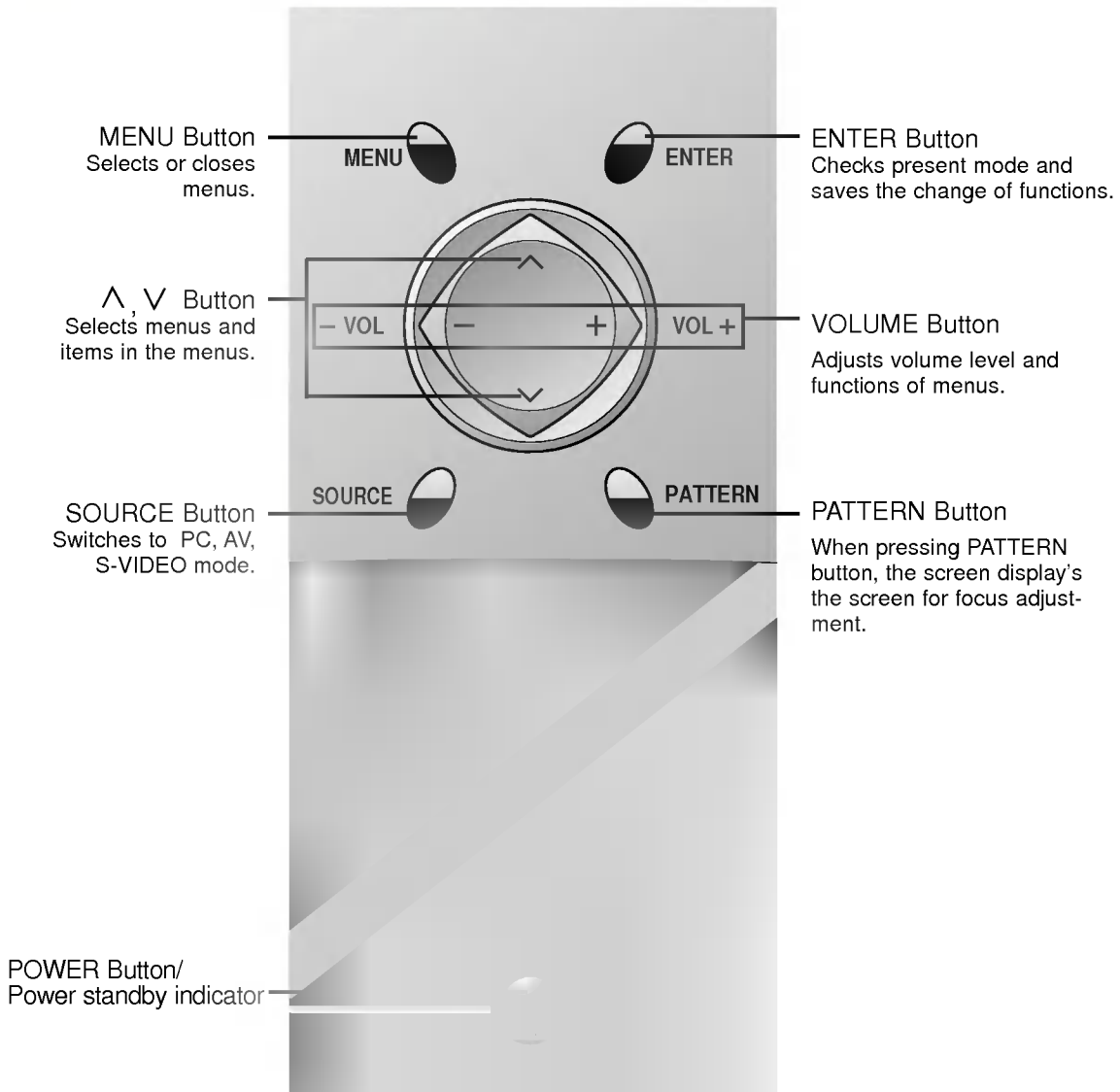

Remote Control

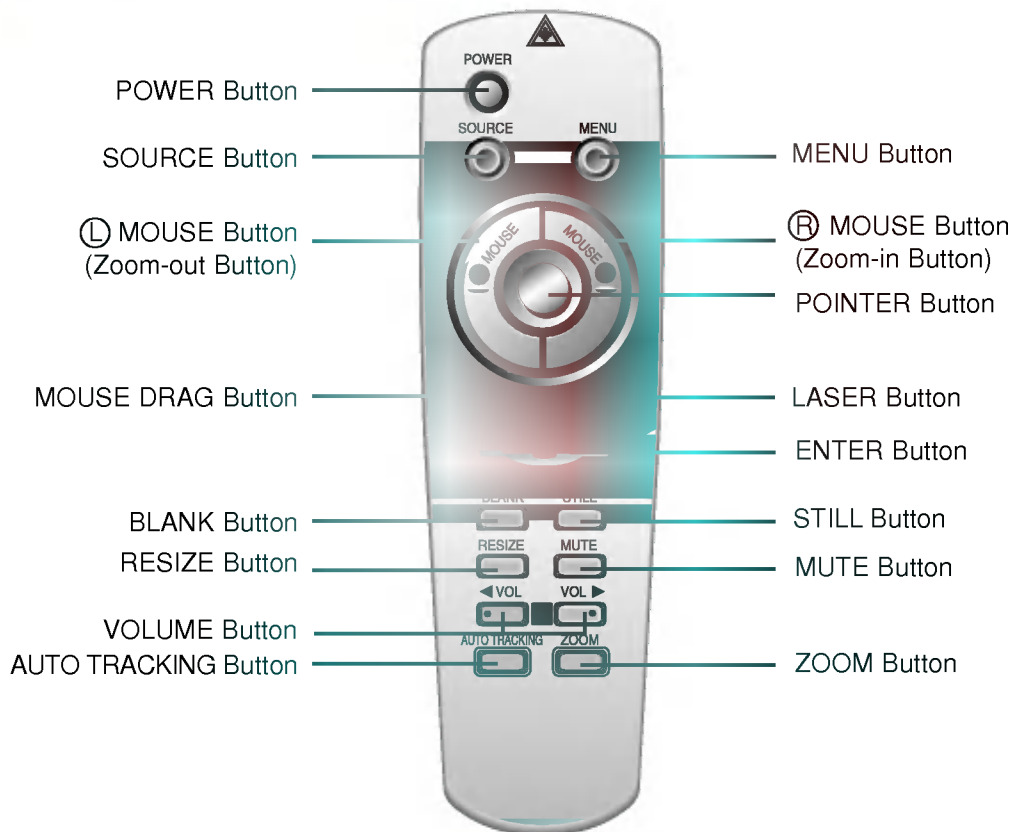

Inserting the batteries

- 1 Slide the battery cover in the direction of the arrow to remove.

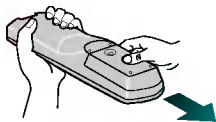

- 2 Insert the batteries with correct polarity.

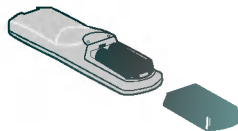

- 3 Replace the battery compartment cover to the arrow direction.

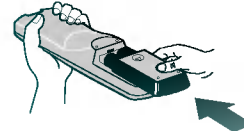

Functions on the Remote Control

Button	Function
POWER Button	Selects ON/OFF of power.
SOURCE Button	Switches to PC, AV, S-VIDEO mode.
MENU Button	Displays or hides the menu.
Ⓛ MOUSE Button (Zoom-out Button)	* Corresponds to the Left - Click of PC Mouse. This button registers a menu selection and selects other custom functions. * Downsizes the screen on the zoom function.
Ⓡ MOUSE Button (Zoom-in Button)	* Corresponds to the Right - Click of PC Mouse. This button registers a menu selection and selects other custom functions. * Enlarges the screen size on zoom function.
POINTER Button	* After selecting menus, controls selecting and adjusting functions with the direction of up, down, left, right. * Moves the screen with the direction of up, down, left, right on zoom function. * Moves and releases the selected icon on PC screen.
MOUSE DRAG Button	Uses to select and drag an icon in PC mode.
ENTER Button	Checks the present mode and saves the change of functions.
ZOOM Button	Refer to page 40.
RESIZE Button	Refer to page 38.
AUTO TRACKING Button	Refer to page 41~42.
BLANK Button	Refer to page 33~34.
STILL Button	Refer to page 30.
MUTE Button	Cuts off audio.
VOLUME Button	Adjusts volume level.
LASER Button	Makes a bright red laser point on the screen for attention. (Don't look at laser beam directly as it causes eye damage.)

Projector Status Indicators

* Power Indicator, lamp Indicator, operation indicator and temperature indicator at the top of the projector show the user the operating status of the projector.



Power Indicator	Orange	Standby.
	Green	On operation.
Operation Indicator	Orange	Standby.
	Green	On operation.(Turn on the lamp)
	Red	Projector lamp is cooling as power out(2 minutes)
	Off	Power off.
Lamp Indicator	Red	Projection lamp is reaching the end of its life and needs to be replaced with a new lamp.(over 1900 hours) "Replace the Lamp"
	Red(flashing)	The projector has trouble in the lamp or around it. Contact the service center.
	Green(flashing)	The lamp cover is not closed.
Temperature Indicator	Orange	This projector is in high temperature. If you don't turn off the projector, it'll be turned off automatically. "Temperature is Too High"
	Red	The projector is turned off as its high temperature.
	Red (flashing)	Power has turned off due to problem with the internal cooling fan. Contact your service center.

" " is the warning message on screen.

Accessories

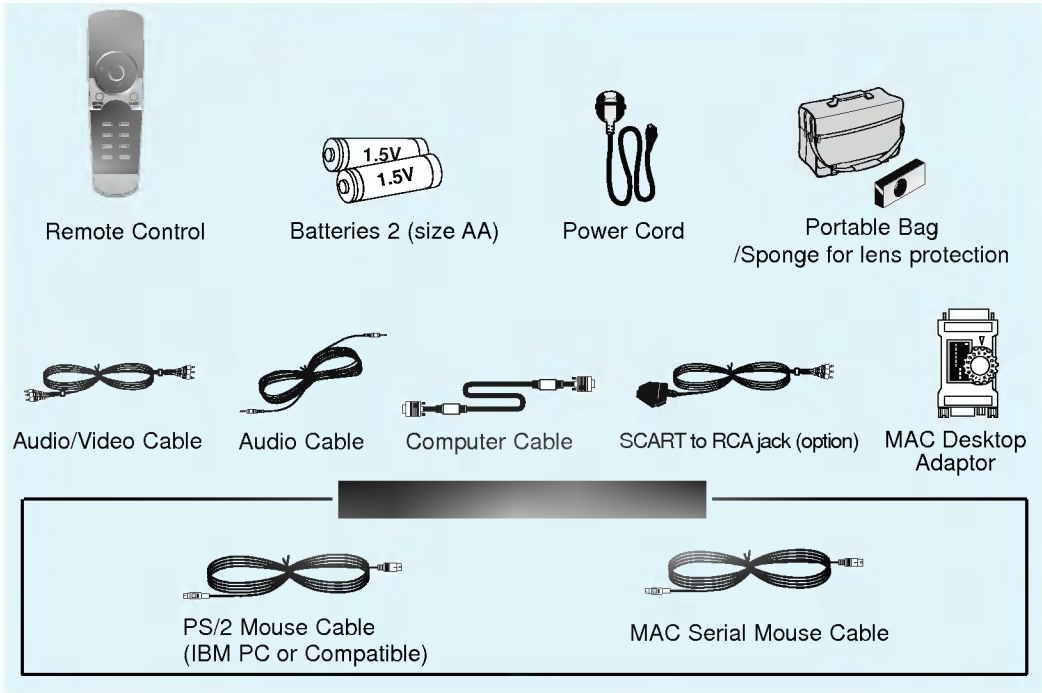

Optional Extras

- * Contact your dealer for buying these items.
- * When applying a ceiling installer, use only the ceiling installer for LCD projector.
- * Contact your dealer for replacing a new lamp.

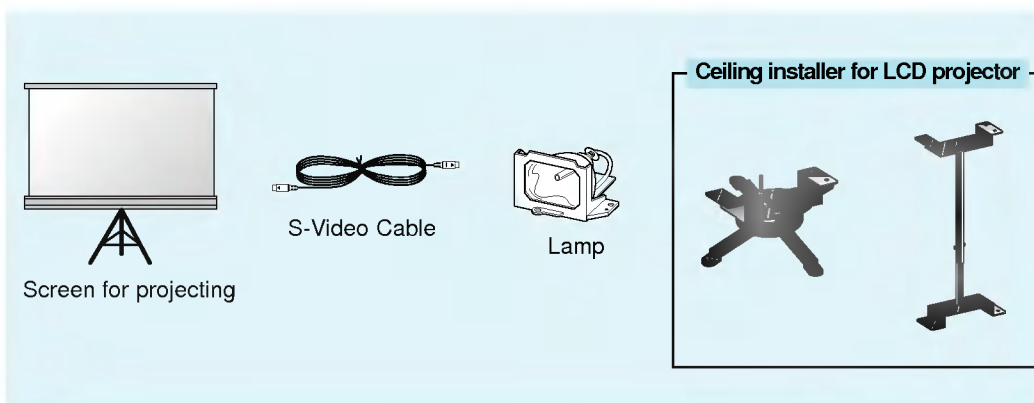

* Don't place the projector in the following conditions. It may cause malfunction or product damage.

Provide proper ventilation for this projector.

- The projector is equipped with ventilation holes(intake) on the bottom and ventilation holes(exhaust) on the front. do not block or place anything near these holes, or internal heat build-up may occur, causing picture degradation or damage to the projector.
- Do not place the projector on a carpet, rug or other similar surface. It may prevent a adequate ventilation of the projector bottom. This product should be mounted to a wall or ceiling only.

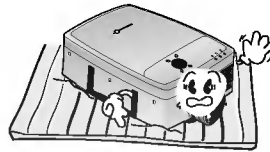
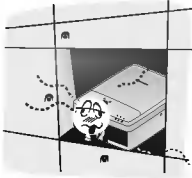

- Never push projector or spill liquid of any kind into the projector.
- Leave an adequate distance(30cm or more) around the projector.

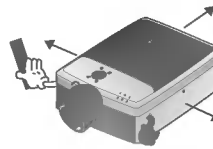
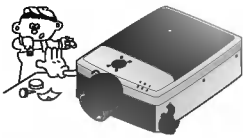

Place this projector in adequate temperature and humidity conditions.

- Install this projector only in a location where adequate temperature and humidity is available. (refer p.46)

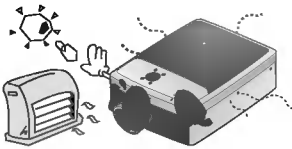

Don't place the projector where it can be covered with dust.

- This may cause overheating of the projector. Clean the Air filter periodically.

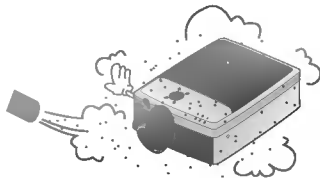

Do not clog the slots and openings of the projector. It may cause overheating.

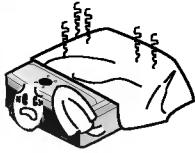

The LCD projector is manufactured using high-precision technology. You may, however, see tiny black points and/or bright points (red, blue, or green) that continuously appear on the LCD projector. This is a normal result of the manufacturing process and does not indicate a malfunction.

This product should be used adequate length bolt (within 5mm) when installing it.

When applying a ceiling installer, use only the fixing bolt and ceiling installer for LCD projector. Contact your dealer for purchase or installation.



To receive the DTV program, it is necessary to purchase DTV receiver (Settop Box) and connect it to the projector.

If there is no input signal, Menu will not display on screen.

Basic Operation of the Projector

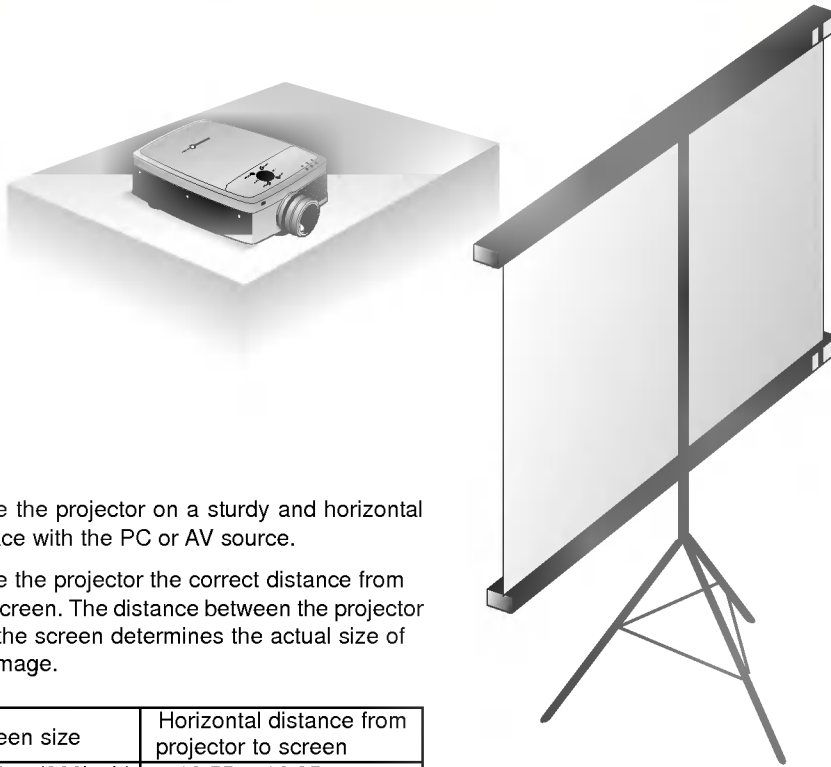

1. Place the projector on a sturdy and horizontal surface with the PC or AV source.
2. Place the projector the correct distance from the screen. The distance between the projector and the screen determines the actual size of the image.

Screen size	Horizontal distance from projector to screen
610x460cm(300inch)	12.55m~16.35m
410x300cm(200inch)	8.35m~10.87m
200x150cm(100inch)	4.16m~5.42m
160x120cm(70inch)	2.90m~3.78m
120x90cm(50inch)	2.06m~2.69m
81x61cm(40inch)	1.64m~2.15m

3. Turn the projector so that the lens can be at a right angle to the screen. If the projector is not at a right angle, the screen image will be crooked. At this time perform keystone function. (Refer to page 39.)
4. Connect the cables of the projector to a wall power socket and other connected sources.

Using Kensington Security System

- The projector has Kensington Security System Connector on the back panel. Connect the Kensington Security system cable as below.
- For the detailed installation and use of the Kensington Security System, refer to the user's guide attached to the Kensington Security System set. And for further information, contact <http://www.kensington.com>, the internet homepage of the Kensington company that deals with expensive electronic equipments such as notebook PCs or LCD projectors.
- Kensington Security System is an optional item.

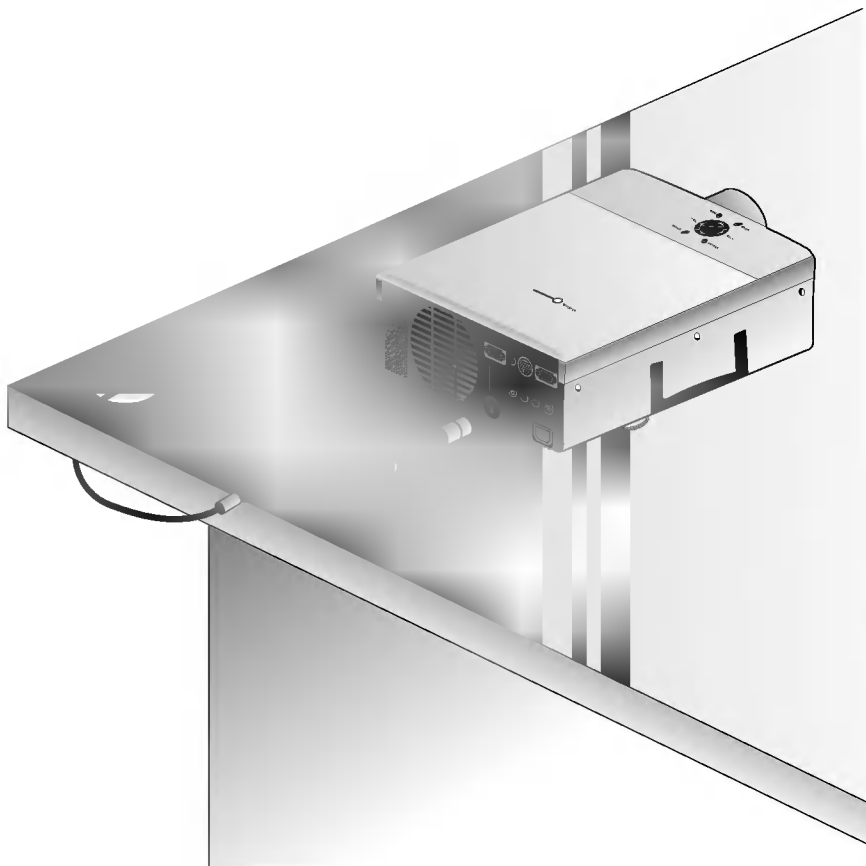

1 Remove the lens cover of the projector.

2 Press the **POWER** button on the remote control or top cover. (Green operation indicator flashes during warming up of the lamp.)

- It will take about 1 minute to display the picture after power on because the lamp of the projector needs cooling.
 - An image will appear after the operation indicator has flashed green for some time.
 - Select the source mode with the **SOURCE** button.
 - Leave the projector plugged in for at least 2 minutes after switching off the projector screen, as this will allow the lamp cooling to continue which will speed up the lamp switch on time if required.
-

3 Adjust volume level.

- If you press **VOLUME** ► button, sound and volume level number are increased.
- If you press **VOLUME** ◀ button, sound and volume level number are decreased.

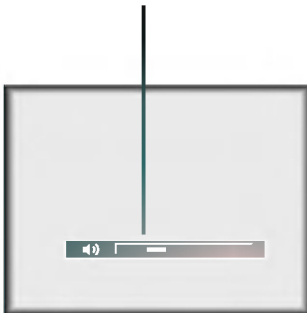

* Don't turn main power off and don't unplug the power cord while the ventilation fan(inlet/outlet) is working.

- 1 Press the **POWER** button on the top cover or remote control.



-
- 2 Press the **POWER** button on the top cover or remote control again to cut off the power.

-
- 3 If operation indicator is flashing(red), leave the power cord plugged into the outlet. Do not pull out from the outlet until operation indicator is flashing(orange).

- If operation indicator is flashing(red), the power button on the top cover or remote control may not operate.

Focusing and Positioning the Screen Image

When an image appears on the screen, check if it is in focus and fits well to the screen.



- To adjust the focus of the image, rotate the focus ring which is the outer ring on the lens.
- To adjust the size of the image, rotate the zoom ring which is the inner ring on the lens.

To raise or lower the image on the screen, extend or retract the foot at the bottom of the projector by pushing foot adjuster button as below.

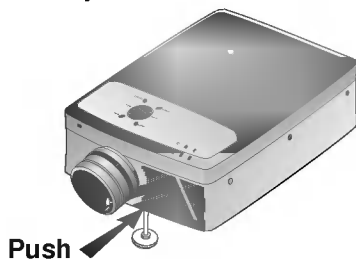

1. Press the foot adjuster button while you support the other side of the projector. This unlocks the foot and can make it move freely. Take care not to drop the projector.
2. While pressing the foot adjuster button, raise or lower the projector to place the screen image in the proper position.
3. Release the button to lock the foot in its new position.
4. To fine-tune the height of the projector, rotate the front foot to raise or lower it. After raising the front foot, do not press down on the projector.

If the projector is installed on a place that is not stable or horizontal, the projected screen shape will be distorted.

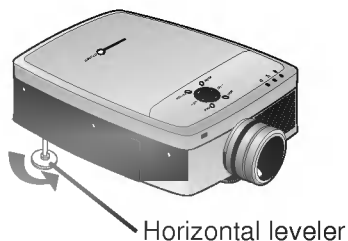

- Adjust the screen shape to be horizontal and rectangular with horizontal leveler as above.

1 Press the **SOURCE** button

2 Each press of the **SOURCE** button changes the display as below.

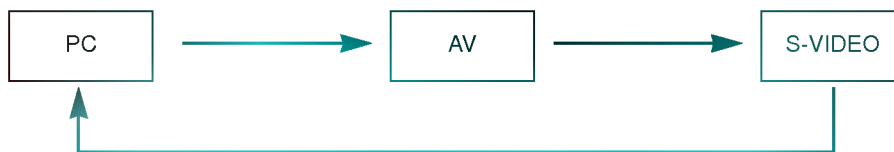

- * You can connect the projector to a computer of VGA, SVGA, XGA and SXGA output.
- * You can use resize function for VGA, SVGA output.
- * Refer to page 44 for the projector supported monitor display.

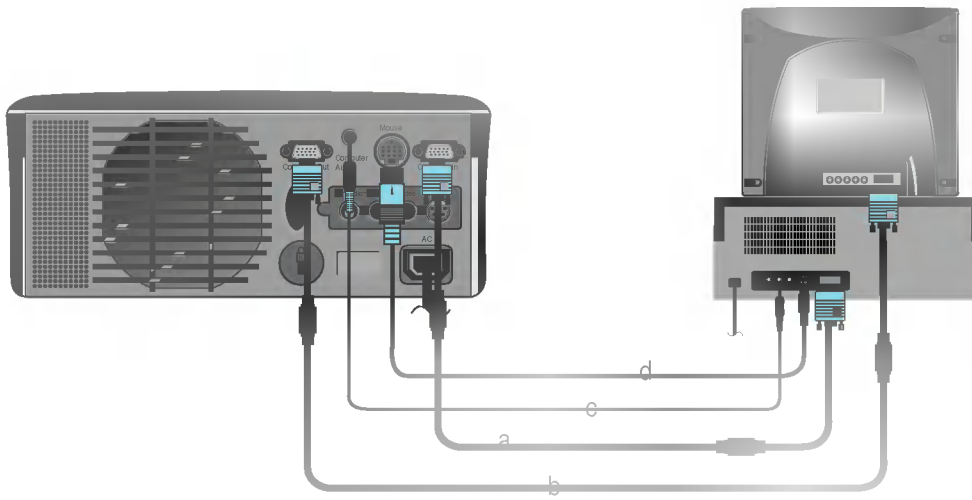

< How to connect >

- a. Connect either end of the computer cable to **Computer In** of the projector.
- b. Connect the monitor cable from the PC monitor to **Computer Out** of the projector if you want to see the projected image on PC monitor.
- c. Connect the audio cable from the PC (LINE OUT sound port) to **Computer Audio** of the projector.
* If the PC has two audio out ports of SPEAKER OUT and LINE OUT, connect the LINE OUT port to get better sound quality.
- d. Connect the PS/2 mouse(for IBM PC or compatible) cable(6 pin) to the **Mouse** of the projector.

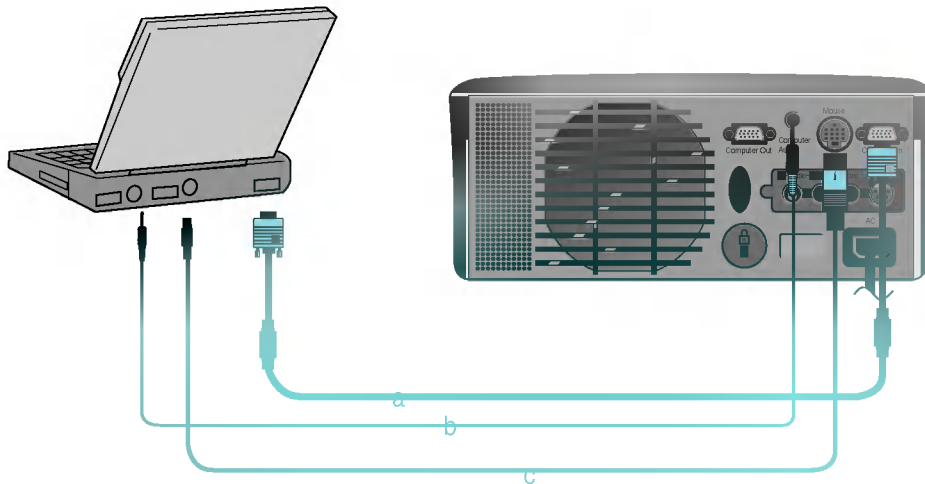

< How to connect >

- a. Connect either end of the computer cable to **Computer In** of the projector.
 * If you set your computer, such as a notebook type IBM PC/AT compatible, to output the signal to both the display of your computer and the external monitor, the picture of the external monitor may not appear properly. IN such cases, set the output mode of your computer to output the signal only to the external monitor. For details, refer to the operating instructions supplied with your computer.
- b. Connect the audio cable from the PC to **Computer Audio** of the projector.
- c. Connect the PS/2 mouse(for IBM PC or compatible) cable(6 pin) to the **Mouse** of the projector.

* You must use the Macintosh desktop adaptor to connect the projector to a Macintosh PC.

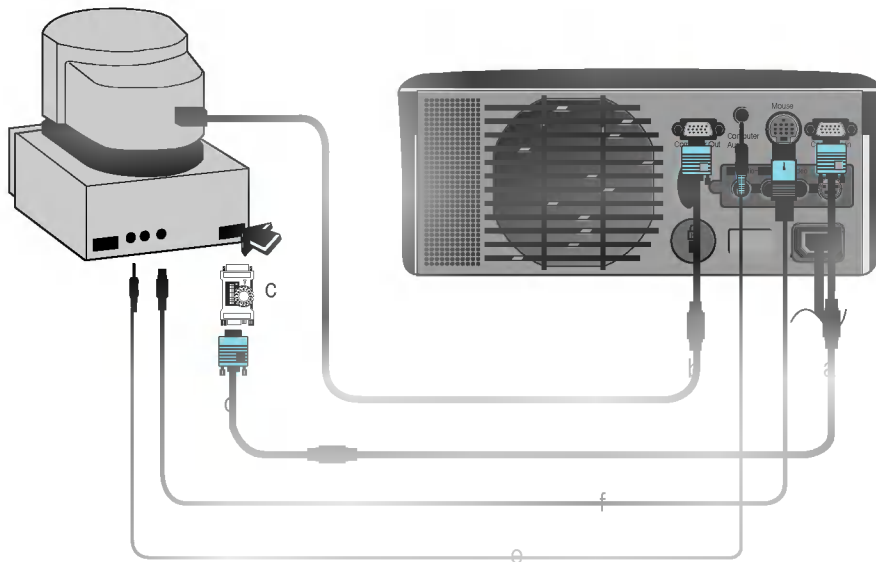

< How to connect >

- a. Connect either end of the computer cable to **Computer In** of the projector.
- b. Connect the monitor cable from the Macintosh monitor to **Computer Out** of the projector if you want to see the projected image on Macintosh monitor.
- c. Set the adjusting number and letter of the Macintosh desktop adaptor in accordance with the resolution you want to use and connect the adaptor to the Macintosh. (Refer to page 24 ~ 25)
- d. Connect the computer cable to the Macintosh desktop adaptor.
- e. Connect the audio cable from the PC to **Computer Audio** of the projector.
- f. Connect the mouse cable(4 pin) from the Macintosh mouse port to the **Mouse** of the projector.

How to use the Macintosh desktop adaptor

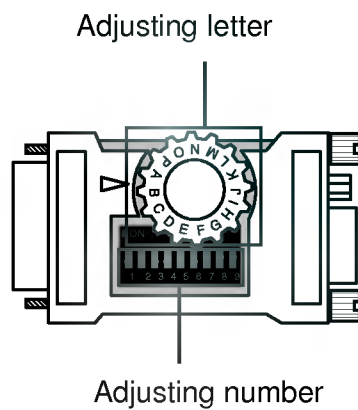

a. How to use

Usually set 1 ~ 6 to OFF status and 7 ~ 9 to ON status of the adjusting numbers. And select the adjusting letter which is correct to the Macintosh and the monitor. (Refer to page 25.)

b. Notes for Connecting to the Macintosh PowerBook

If you get problems when connecting it to the projector, set the adjusting number 9 to OFF status and restart the Macintosh PowerBook.

Adjusting letters of MAC desktop adaptor in accordance with kinds of MAC and output spec.

output spec	output resolution horizontal frequency(KHz) vertical frequency(Hz)	12"RGB	13"14"RGB	15"Flat	VGA	SVGA	SVGA	16"Color	19"Color	19"Color	2"Page Mono	21"Color	NTSC	PAL	PAL
		512x384 24.5 60	640x480 35 60	640x480 68.8 75	640x480 31 60	800x600 35 56	800x600 35 56 or 72	832x624 50 75	1024x768 60 75	1024x768 60 or 70	1152x870 68.7 75	1152x870 68.7 75	15.7 60	16 50	
MAC S	adjusting letter	N	J	O	G	G	G	F	D	G	M	P	L	H	
MAC Iq, Ili		N	J	O											
MAC M, Iix		N	J		G										
LC		N	J		M										
LQII		N	J		G										
LQIII		N	J	O	G			F							
LC 475, LC 560		N	J	O	G	G		F							
LC 575		N	J	O	G	G		F	D		M	P	L	H	
Performa															
400,405,410,430,600,600CD		N	J		G										
450		N	J	O	G			F							
Quadra															
700,900		N	J	O	G	G		F			M	P	L	H	
605,610,650,800,950		N	J	O	G	G		F	D		M	P	L	H	
840AV		N	J	O	G	G	G	F	D	G	M	P	L	H	
Centris															
610,660		N	J	O	G	G		F	D		M	P	L	H	
660AV		N	J	O	G	G	G	F	D	G	M	P	L	H	
PowerBook															
160,165C,180,180C		N	J	O	G	G		F							
DUO DOC, MINI DOC		N	J	O	G	G		F							
8 24 BOARD		N	J	O				F			M	P	L	H	

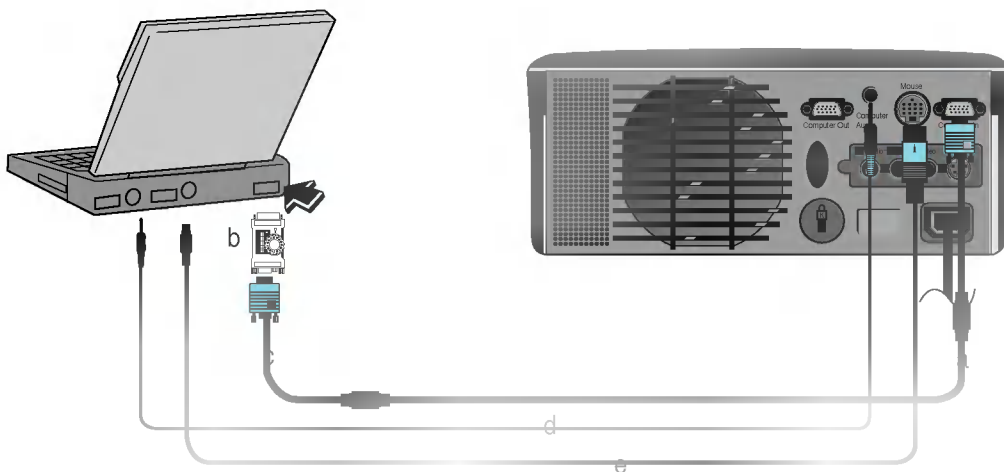

< How to connect >

- a. Connect either end of the computer cable to **Computer In** of the projector.
- b. Set the adjusting number and letter of the Macintosh desktop adaptor in accordance with the resolution you want to use and connect the adaptor to the Macintosh PowerBook.(Refer to page 24 ~ 25)
- c. Connect the other end of the computer cable to the Macintosh desktop adaptor.
- d. Connect the audio cable from the PC to **Computer Audio** of the projector.
- e. Connect the mouse cable from the Macintosh mouse port to the **Mouse** of the projector.

- * In AV input mode, if the auto video system recognition fails to detect a correct video system type, please press the **AUTO TRACKING** button on the remote. Then the projector executes the fine auto video system recognition.
- * You can connect a VTR, a camcorder, a LDP or any other compatible video image source to the projector.

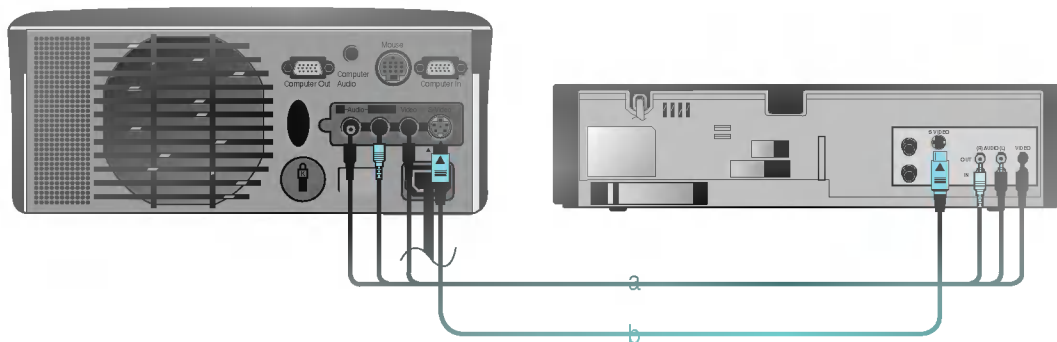

< How to connect 1 >

- When connecting the projector to an A/V source, connect the A/V input ports of the projector to the output ports of the A/V source with A/V cables of the same color. The video cable is yellow and the left audio is white and right audio is red.

< How to connect 2 >

- Connect S-Video input port of the projector to S-Video output port of A/V source with S-Video cable.
* You can get better picture quality when connecting S-Video source to the projector.

- * To receive the DTV program, it is necessary to purchase DTV receiver (Settop Box) and connect it to the projector.
- * Please refer to the owner's manual of the DTV Settop Box for the connection between LCD projector and DTV Settop Box.

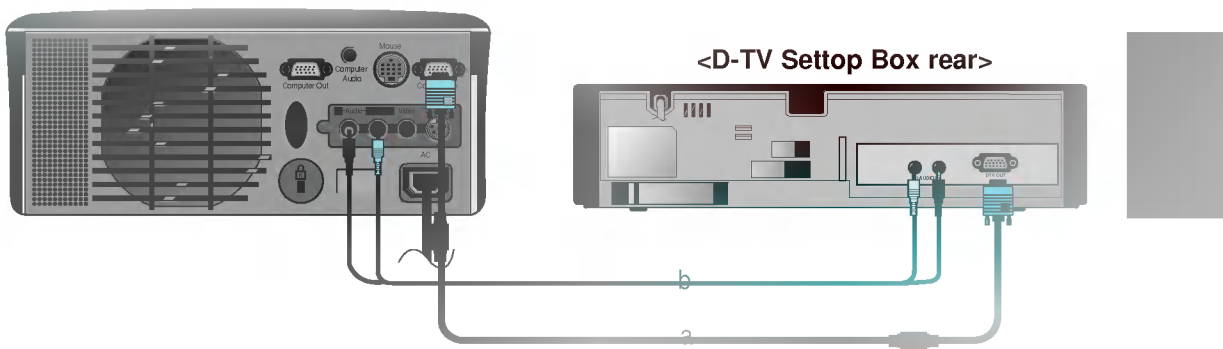

< How to connect >

- Connect the **Computer In** of the projector to **DTV OUT** of the D-TV Settop Box.
- Connect the Audio input ports (**R, L/Mono**) of the projector to the Audio output ports (**R, L**) of the D-TV Settop Box.

* If there is no input signal, Menu will not display on screen.

1 Press the **MENU** button.

2 Move the **POINTER** button up or down to select a menu and press the **ENTER** button. Each time you press the button you can see menus as below.

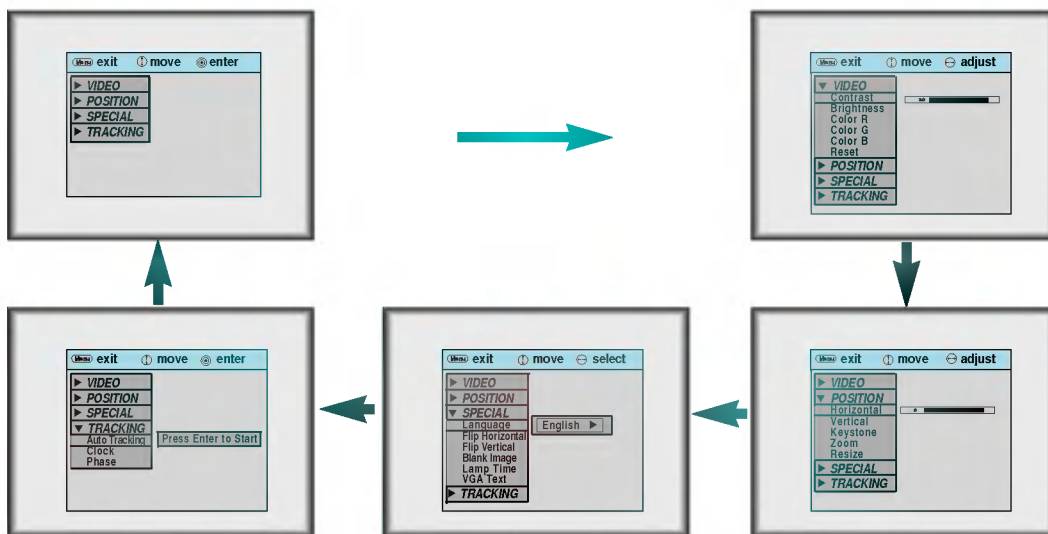

3 Move the **POINTER** button up or down to select a function that you want to use or adjust.

● To finish the menu display, press the **MENU** button.

* In AV and S-VIDEO mode, [**Horizontal**] / [**Vertical**] in POSITION menu, [**VGA Text**] in SPECIAL menu and TRACKING menu are not displayed.

* The sub menus of VIDEO menu in AV and S-VIDEO mode are different from those in the PC mode. (Refer to page 43).

1 Press the **STILL** button.

* You can freeze the input image.

* This function doesn't work in following resolution UXGA(1600X1200, 60Hz).



<Moving Image>



<Still Image>



2 To finish this function, press the **STILL** button again.

- 1** Press the **MENU** button and move the **POINTER** button up or down to select the SPECIAL menu as below.

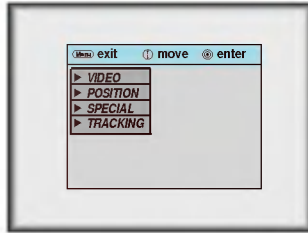

- 2** Press the **ENTER** button and move the **POINTER** button up or down to select [Language] item.

- 3** Move the **POINTER** button left or right to select the language you want to use.
- On-Screen-Display(OSD) is marked in the selected language from this point.
 - To finish menu display, press the **MENU** button.



- 1** Press the **MENU** button and move the **POINTER** button up or down to select the SPECIAL menu as below.



- 2** Press the **ENTER** button and move the **POINTER** button up or down to select the [Lamp Time] item.

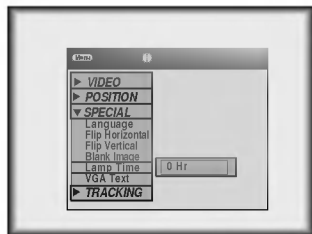

- You can see the used lamp time.
- When projector lamp is reaching the end of its life(over 1900 hours), the lamp indicator will flash(red) and the projector will display "Replace the Lamp" on screen.

* This function may be effective if you need to get attention of the attendants in meetings or briefings.

1 Press the **BLANK** button.

* The screen turns of to a background color and sound turns off.

* You can choose the background color. Refer to page 34.

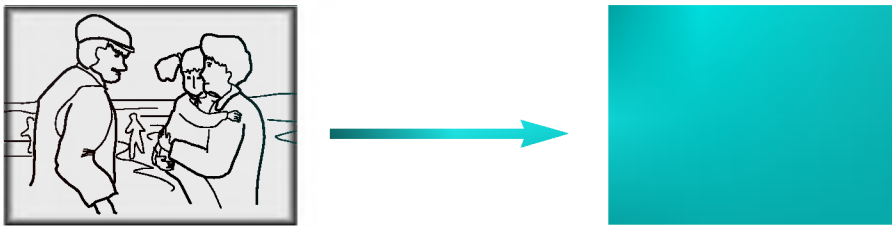

2 To exit the blank status, press any button(Except **POWER** button).

* If exiting the blank status sound also comes on.

Selecting Blank Image color

- 1 Press the **MENU** button and move the **POINTER** button up or down to select the SPECIAL menu.

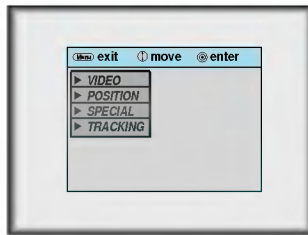

- 2 Press the **ENTER** button and move the **POINTER** button up or down to select the [Blank Image] item.

- 3 Move the **POINTER** button left or right to select the color you want to use.
 - Background color will be changed to the selected color from this point.
 - To exit menu display, press the **MENU** button.



Flip Horizontal Function

* This function reverses the left and the right side of the projected image. Use this function when projecting from behind onto a transparent screen being viewed from the opposite side.

- 1 Press the **MENU** button and move the **POINTER** button up or down to select the SPECIAL menu.

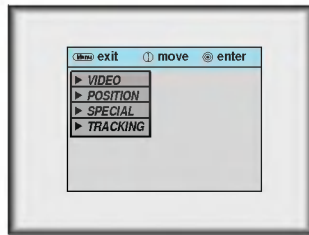

- 2 Press the **ENTER** button and move the **POINTER** button up or down to select [Flip Horizontal] item.

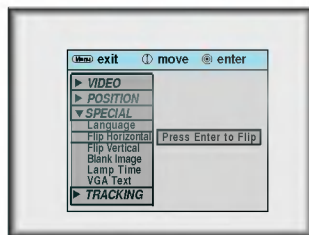

- 3 Press the **ENTER** button to see reversed image.

- Each time you press the button, the image will be reversed.
- To finish menu display, press the **MENU** button.

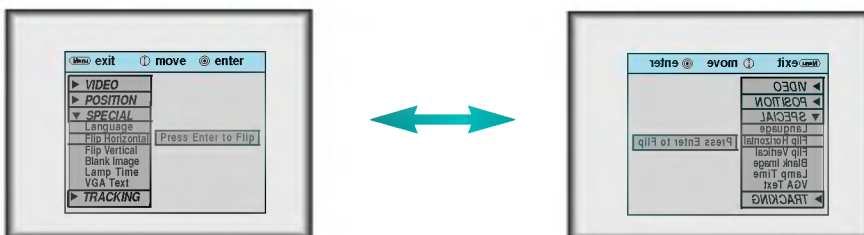

Flip Vertical Function

- * This function reverses the upper and the lower side of the projected image.
- * When you hang the projector upside down from the ceiling for using, you need to reverse all the sides(left, right, upper, lower) of the image.

1 Press the **MENU** button and move the **POINTER** button up or down to select the SPECIAL menu.



2 Press the **ENTER** button and move the **POINTER** button up or down to select [Flip Vertical] item.

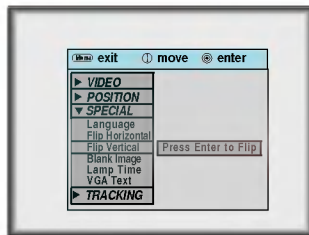

3 Press the **ENTER** button to see reversed image.

- Each time you press the button, the image will be reversed.
- To finish menu display, press the **MENU** button.

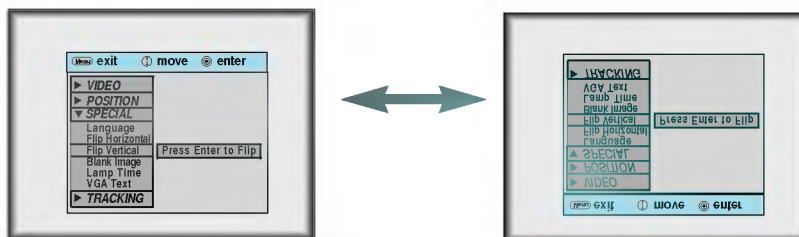

- * When PC input mode, select the appropriate screen size in SPECIAL menu as below before turning on the PC to get the image size of PC on DOS mode to fit on the projected screen.
- * In other screen size signals except 640X400 70Hz and 720X400 70Hz, the projected screen sizes are adjusted automatically.

- 1 Press the **MENU** button and move the **POINTER** button up or down to select the SPECIAL menu as below.

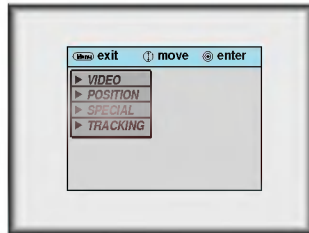

- 2 Press the **ENTER** button and move the **POINTER** button up or down to select the [VGA Text] item.

- 3 Move the **POINTER** button left or right to select the screen size you want to use.

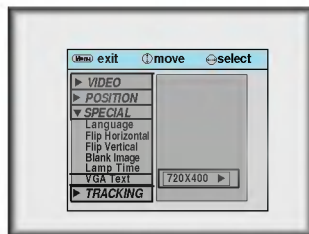

- a. Selecting 720X400
: When input signals are 720X400 70Hz or 640X400 70Hz , the projected screen size is always adjusted to the format of 720X400 70Hz.
- b. Selecting 640X400
: When input signals are 720X400 70Hz or 640X400 70Hz , the projected screen size is always adjusted to the format of 640X400 70Hz.
- To exit menu display, press the **MENU** button.

* You can use this function only under SVGA (800x600) mode in case of LP-XG22/XG24 model.

- 1 Press the **RESIZE** button.
Each press of the button changes the display as below.

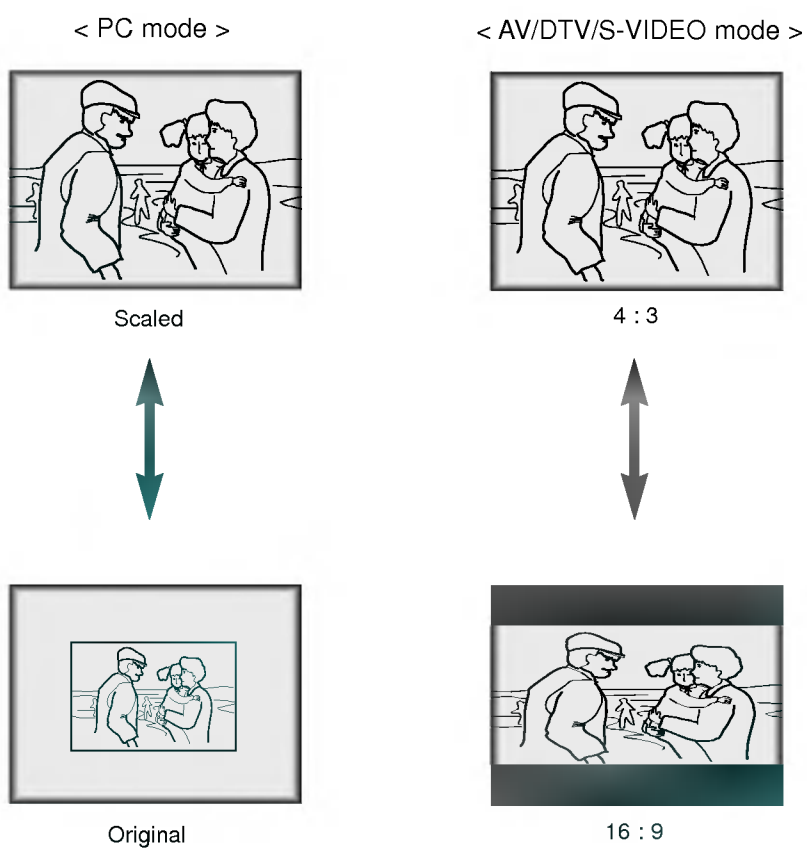

* You can also use this function by using the **MENU** button.

Positioning

- * If the image size does not fit the screen in accordance with the input source, set the position of the image by selecting Horizontal / Vertical position.
- * **Keystone** function adjusts the upper and lower width of the projected image to prevent the image shape from being a trapezoid shape. Use this function when the screen or the projector is slanted and cannot make a rectangular projection angle.

1 Press the **MENU** button and move the **POINTER** button up or down to select the POSITION menu.



2 Press the **ENTER** button and move the **POINTER** button up or down to select (Horizontal), (Vertical) or (Keystone) item.

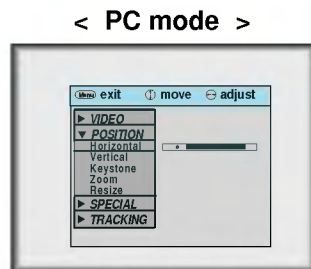

3 Press the **POINTER** button and move the button left or right or press the **VOLUME** (◀▶) button to adjust the screen condition as you want.

- (Horizontal), (Vertical), (Keystone) are adjusted from -50 to +50.
- To exit the menu display, press the **MENU** button.

Zoom Function

- 1 Press the **ZOOM** button.

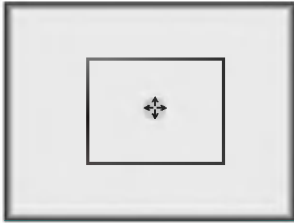

- 2 Move the **POINTER** button to move the rectangular zooming area and press the **ENTER** button to zoom into the target area.

- 3 Press the **L MOUSE** or **R MOUSE** button to adjust the zoom level.

- * **L MOUSE** button makes the image look smaller.
- * **R MOUSE** button makes the image look larger.



- 4 Move to the position you want to see the enlarged display by moving the **POINTER** button left, right, up, or down.

- 5 Press the **ZOOM** button again to finish the zoom function.

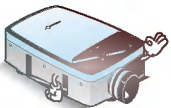

- * You can use this function by using the **MENU** button.
- * In the zoom mode, you can adjust horizontal / vertical position with the **POINTER** button.

Auto Tracking Function

* Auto Tracking Function

This function assures you of getting the best video quality by automatically adjusting the difference of horizontal width and tremor of the image. This difference is caused by disaccord of the internal signal of the projector and diverse graphic signals of PC.

- 1 Press the **AUTO TRACKING** button.



* Image positioning and tremor adjusting are automatically performed.

-
- 2 Adjust [**Clock**] or [**Phase**] in TRACKING menu after operation of [**Auto Tracking**] if you want to get better picture quality in accordance with diverse PC input modes. (Refer to page 42.)



- * You can also use this function by using the **MENU** button.(PC mode)
- * Perform this function while on stopped image because you may not get the best video quality on a moving image of PC graphic signal.

Clock / Phase Function

* Clock Function

This function adjusts the horizontal width of the projected image to get the image to fit on the screen size.

* Phase Function

This function is for the detailed adjustment of the clock function.

- 1 Press the **MENU** button and move the **POINTER** button up or down to select the TRACKING menu.



- 2 Press the **ENTER** button and move the **POINTER** button up or down to select the (Clock) or (Phase) item.

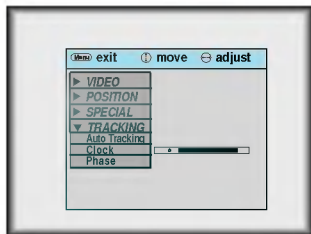

- 3 Move the **POINTER** button left or right or press the **VOLUME** (◀▶) button to adjust the screen condition.

- To exit the menu display, press the **MENU** button.

1 Press the **MENU** button and move the **POINTER** button up or down to select each VIDEO menu.



2 Press the **ENTER** button.



3 Move the **POINTER** button up or down to select a video item you want to adjust.

4 Move the **POINTER** button left or right or press the **VOLUME** (**◀▶**) button to adjust the selected video item as you want.

- To restore the original image condition after changing it, press **ENTER** button after selecting (**Reset**) item.
- To finish menu display, press the **MENU** button.

Supported Monitor Display

* The projector displays images at a resolution of 1024x768 pixels. To display higher resolution images(1152x864mode, 1280x1024mode), the projector compresses it to 1024x768. The following table lists the display formats supported by the projector.

Sources	Format	Vertical Freq. (Hz)	Horizontal Freq. (kHz)
VGAEGA	640X350	70.090Hz	31.468kHz
	640X350	85.080Hz	37.861kHz
PC98 / VGA text	640X400	85.080Hz	37.861kHz
	720X400	70.082Hz	31.469kHz
	720X400	85.039Hz	37.927kHz
VGA	640X480	59.940Hz	31.469kHz
	640X480	66.667Hz	35.00kHz
	640X480	72.800Hz	37.861kHz
	640X480	75.00Hz	37.500kHz
	640X480	85.008Hz	43.269kHz
	640X480	100.040Hz	53.011kHz
	640X480	120.00Hz	64.062kHz
	640X480	120.00Hz	64.062kHz
SVGA	800X600	56.250Hz	35.156kHz
	800X600	60.317Hz	37.879kHz
	800X600	72.188Hz	48.077kHz
	800X600	75.00Hz	46.875kHz
	800X600	85.061Hz	53.674kHz
	800X600	90.00Hz	56.00kHz
	800X600	100.00Hz	64.016kHz
	800X600	100.00Hz	64.016kHz
XGA	1024X768	43.479Hz (interlace)	35.522kHz
	1024X768	60.004Hz	48.363kHz
	1024X768	70.069Hz	56.476kHz
	1024X768	75.029Hz	60.023kHz
	1024X768	84.997Hz	68.677kHz
	1024X768	84.997Hz	68.677kHz
SXGA	1152X864	60.053Hz	54.348kHz
	1152X864	70.016Hz	63.995kHz
	1152X864	75.00Hz	67.500kHz
	1152X864	85.057Hz	77.487kHz
	1280X960	60.00Hz	60.00kHz
	1280X960	75.00Hz	75.00kHz
	1280X960	85.002Hz	85.938kHz
	1280X1024	60.020Hz	63.981kHz
	1280X1024	75.025Hz	79.976kHz
	1280X1024	85.024Hz	91.146kHz
	1280X1024	85.024Hz	91.146kHz
	1280X1024	85.024Hz	91.146kHz
UXGA	1600X1200	60.00Hz	75.00kHz
MAC	16吋	832X624	74.550Hz
	19吋	1024X768	60.004Hz
		1024X768	75.029Hz
	20吋	1152X870	75.062Hz
HD	1920X1080i	60.00Hz	33.750kHz
	1280X720p	60.00Hz	45.00kHz

* If the projector does not support the input signal, "CHECK INPUT SIGNAL" message appears on the screen.

* The projector supports DDC1/2B type as Plug & Play function.(Auto recognition of PC monitor)

Maintenance

* The projector needs little maintenance. You should keep the lens clean because any dirt or stains may appear on the screen. You will also need to clean the air filter attached at the bottom of the projector periodically because a clogged air filter prevents proper ventilation that is necessary to cool the projector and prevents it from overheating. If any parts need to be replaced, contact your dealer. When cleaning any part of the projector, always turn the power off and unplug the projector first.

Cleaning the lens

Clean the lens whenever you notice dirt or dust on the surface of it. Wipe the lens surface gently with an air spray or a soft, dry lint-free cloth.

To remove dirt or stains on the lens, moisten a soft cloth with water and a neutral detergent and wipe the lens surface gently.

Cleaning the Projector Case

To clean the projector case, first unplug the power cable. To remove dirt or dust, wipe the casing with a soft, dry, lint-free cloth. To remove stubborn dirt or stains, moisten a soft cloth with water and a neutral detergent and then wipe the casing.

Do not use alcohol, benzene, thinners or other chemical detergents as these can cause the casing to be warped.

Cleaning the Air Filter

The air filter, which is located at the bottom of the projector, should be cleaned after every 100 hours' use. If it is not cleaned periodically, it can become clogged with dust and prevent the projector from being ventilated properly. This may cause overheating and damage of the projector.

To clean the air filter :

1. Switch the projector off and unplug the power cable from the wall socket.
2. Stand the projector on it's side so that the handle can be at the top, and you can easily access the air filter.
3. Push the opening tip of the air filter cover and remove the cover.

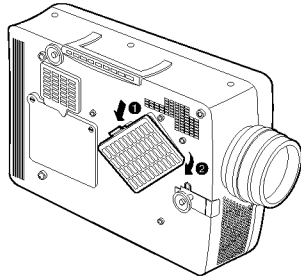

4. The air filter is inside the cover. To clean the filter, use a small vacuum cleaner designed for computers or other office equipment. If not, you may use a dry, lint-free cloth. If it is difficult to remove dirt or the filter is torn, contact your dealer or the service center to replace it.
5. Close the filter cover after cleaning.
6. Plug the power cable back into the wall socket.

LP-XG22/XG24
 22.9mm(0.9 inches)
 1024(Horizontal) x 768(Vertical)pixel
 1.01~7.6m(40~300 inches)
 1.64~16.35m(5.03~54.08 feet)
 12m
 1W
 4:3(horizontal:vertical)
 1:1.3
 NTSC/PAL/SECAM/NTSC4.43/PAL-M/PAL-N
 AC 110 - 240V~50/60Hz
 98.5mm(including front foot)
 238mm
 329.5mm(including lens)
 3.4kg



Warning
 This is a class A product. In a domestic environment this product may cause radio interference, in which case the user may be required to take adequate measures.

Operating Condition



In operation : 32~95°F(0°C~35°C)
 In storage and transit : -4~140°F(-20°C~60°C)



In operation : 20 ~ 80% relative humidity by dry hygrometer
 Not in operation : 10 ~ 90% relative humidity by dry hygrometer

Projection Lamp



AJ-LA20



150W



P/NO : 3828VA0281B(373-026F)

