



English

MINI HI-FI AUDIO SYSTEM

OWNER'S MANUAL

**MODELS : FFH-262A/L/S/AX/AD
FE-262E
FFH-363A/L/S/AX/AD
FE-363E**

Read this manual carefully before operating your set.

Designs and specifications are subject to change without notice.



(for CE region)

P/N:3828RCD012E

**Explanation Graphical Symbols:**

The lightning flash with arrowhead symbol, within an equilateral triangle is intended to alert the user to the presence of uninsulated dangerous voltage within the product's enclosure that may be of sufficient magnitude to constitute a risk of electric shock to persons.



The exclamation point within an equilateral triangle is intended to alert the user to the presence of important operating and maintenance (servicing) instructions in the literature accompanying the appliance.

WARNING:

TO REDUCE THE RISK OF FIRE OF ELECTRIC SHOCK, DO NOT EXPOSE THIS APPLIANCE TO RAIN OR MOISTURE.

To avoid electrical shock, do not open the cabinet. Refer servicing to qualified personnel only.

CAUTION

Use of controls or adjustments or performance of procedures other than those specified herein may result in hazardous radiation exposure.

(FOR THE CUSTOMERS IN EUROPE)

If this product is marked with the CE-symbol, it means which is conformed to EMC regulation 89/336/EEC.

Laser component in this product is capable of emitting radiation exceeding the limit for Class 1.

CAUTION: INVISIBLE LASER RADIATION WHEN OPEN AND INTERLOCKS DEFEATED. AVOID EXPOSURE TO BEAM.

WARNING: OSYNLIG LASERSTRÅLNING NÄR DENNA DEL ÄR ÖPPNAD STRALEN ÄR FARLIG.

ATTENTION: Quand l'appareil est ouvert, ne pas s'exposer aux radiations invisibles du faisceau laser.

This label is located on the interior.

CLASS 1 LASER PRODUCT
KLASSE 1 LASER PRODUKT
LUOKAN 1 LASER LAITE
KLASS 1 LASER APPARAT
CLASSE 1 PRODUIT LASER

This Compact Disc player is classified as a CLASS 1 LASER product.

The CLASS 1 LASER PRODUCT label is located on the exterior.

(FOR CUSTOMERS IN CANADA)

CAUTION: TO PREVENT ELECTRIC SHOCK, DO NOT USE THIS (POLARIZED) PLUG WITH AN EXTENSION CORD, RECEPTACLE, OR OTHER OUTLET UNLESS THE BLADES CAN BE FULLY INSERTED TO PREVENT BLADE EXPOSURE.

This class B digital apparatus meets all requirements of the Canadian Interference-Causing Equipment Regulations.

WARNING:

SHOCK HAZARD - DO NOT OPEN

MISE EN GARDE:

Pour éviter les chocs électriques, n'utilisez pas cette fiche (polarisée) avec une rallonge, un réceptacle ou une autre prise si vous ne pouvez pas y insérer les broches à fond.

MISE EN GARDE

Cet appareil numérique de la classe B respecte toutes les exigences de Règlement sur le matériel brouilleur de Canada.

AVERTISSEMENT

RISQUE DE CHOC ELECTRIQUE-NE-PAS OUVRIR
(FOR CUSTOMERS IN THE UNITED STATES OF AMERICA)

Note to CATV system Installer:

This reminder is provided to call the CATV system installer's attention to Article 820-40 of the NEC that provides guidelines for proper grounding and, in particular, specifies that the cable ground shall be connected to the grounding system of the building, as close to the point of cable entry as practical.

NOTE:**The interference potential to the device.**

This equipment generates and uses radio frequency energy and if not installed and used properly, that is in strict accordance with the manufacturer's instructions, may cause interference to radio and television reception. It has been type tested and found to comply with the limits for a Class B computing device in accordance with the specifications in subparts J of Part 15 of FCC Rules, which are designed to provide reasonable protection against such interference in a residential installation. However, there is no guarantee that interference will not occur in a particular installation. If this equipment does cause interference to radio or television reception, which can be determined by turning the equipment off and on, the user is encouraged to try to correct the interference by one of more of the following measures:

- Reorients or relocate the receiving antenna.
- Increase the separation between the equipment and receiver.
- Connect the equipment into an outlet on a circuit different from that to which the receiver is connected.
- Consult the dealer or an experienced radio/TV technician for help.

(FOR CUSTOMERS IN THE UNITED KINGDOM)**WIRING INSTRUCTIONS**

This appliance is supplied with a BS1363 approved 3 amp fused mains plug. When replacing the fuse always use a 3 amp BS1362 approved type. Never use this plug with the fuse cover omitted. To obtain a replacement fuse cover contact your supplying dealer or "LG ELECTRONICS U.K.LTD".

If the mains sockets in your home differ, or are not suitable for the type of plug supplied, then the plug should be removed and a suitable type fitted. Please refer to the wiring instructions below:

Warning :

The mains plug severed from the mains lead of this appliance must be destroyed. A mains plug with bared wires is hazardous if engaged in a mains output line socket.

IMPORTANT

The wires in this mains lead are coloured in accordance with the following codes:

Blue : Neutral
Brown : Live

As the colour of the wires in the mains lead of this appliance may not correspond with the coloured markings identifying the terminals in your plug, proceed as follows:

The wire which is coloured blue must be connected to the terminal which is marked with the letter N or coloured black.

The wire which is coloured brown must be connected to the terminal which is marked with the letter L or coloured red.

If a 13 amp BS1363 plug or any other type of plug is used, 3 amp BS1362 approved fuse must be fitted either in the plug or at the distribution board.

Warning :

Do not connect either wire to the earth pin, marked with the letter E or with the earth symbol \equiv or coloured green or green and yellow.

IMPORTANT SAFETY INSTRUCTIONS



FOR CUSTOMERS IN THE UNITED STATES

CAUTION:

- Read all of these instructions.
- Save these instructions for later use.
- Follow all warnings and instructions maked on the audio equipment.

- Read instructions - All the safety and operating instructions should be read before the product is operated.
- Retain instructions - The safety and operating instructions should be retained for future reference.
- Heed Warnings - All warnings on the product and in the operating instructions should be followed.
- Follow instructions - All operating and use instructions should be followed.
- Cleaning - Unplug this product from the wall outlet before cleaning. Do not use liquid cleaners or aerosol cleaners. Use a damp cloth for cleaning.
- Attachments - Do not use attachments not recommended by the product manufacturer as they may cause hazards.
- Water and Moisture - Do not use this product near water-for example, near a bath tub, wash bowl, kitchen sink, or laundry tub; in a wet basement; or near a swimming pool; and the like.
- Accessories - Do not place this product on an unstable cart, stand, tripod, bracket, or table. The product may fall, causing serious injury to a child or adult, and serious damage to the product. Use only with a stand, tripod, bracket, or table recommended by the manufacturer or sold with the product. Any mounting of the product should follow the manufacturer's instructions and should use a mounting accessory recommended by the manufacturer.
- A product and cart combination should be moved with care. Quick stops, excessive force, and uneven surfaces may cause the product and cart combination to overturn.
- Ventilation - Slots and openings in the cabinet are provided for ventilation and to ensure reliable operation of the product and to protect it from overheating, and these openings must not be blocked or covered. The openings should never be blocked by placing the product on a bed, sofa, rug, or other similar surface. This product should not be placed in a built-in installation such as a bookcase or rack unless proper ventilation is provided or the manufacturer's instructions have been followed.
- Power Sources - This product should be operated only from the type of power source indicated on the marking label. If you are not sure of the type of power supply to your home, consult your product dealer or local power company. For products intended to operate from battery power, or other sources, refer to the operating instructions.
- Power-Cord Protection - Power supply cords should be routed so that they are not likely to be walked on or pinched by items placed upon or against them, paying particular attention to cords at plugs, convenience receptacles, and the point where they exit from the product.
- Protective Attachment Plug - The product is equipped with an attachment plug having overload protection. This is a safety feature. See Instruction Manual for replacement or resting or protective device. If replacement of the plug is required, be sure the service technician has used a replacement plug specified by the manufacturer that has the same overload protection as the original plug.
- Lightning - For added protection for this product during a lightning storm, or when it is left unattended and unused for long periods of time, unplug it from the wall outlet and disconnect the antenna or cable system. This will prevent damage to the product due to lightning and power-line surges.



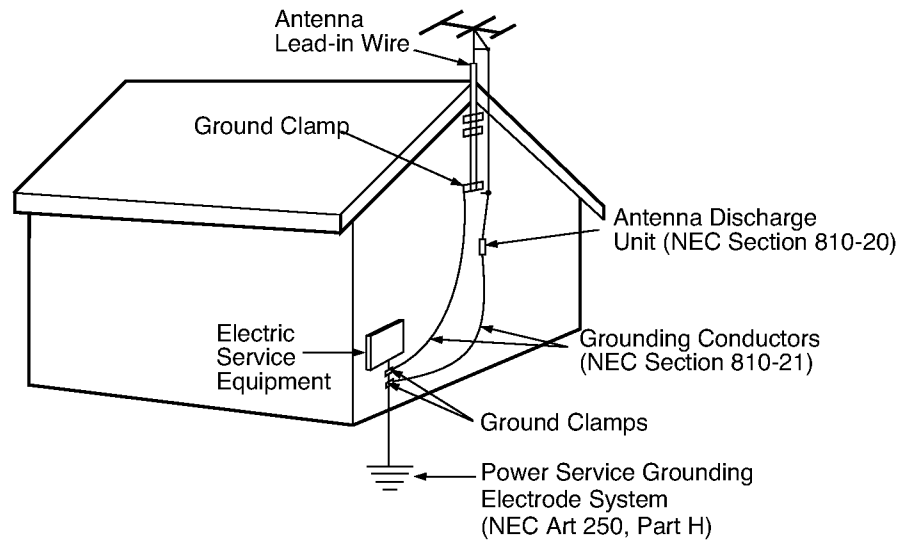

- Outdoor Antenna Grounding - If an outside antenna or cable system is connected to the product, be sure the antenna or cable system is grounded so as to provide some protection against voltage surges and built-up static charges.
- Article 810 of the National Electrical Code, ANSI/NFPA 70 provides information with regard to proper grounding of the mast and supporting structure, grounding of the lead-in wire to an antenna discharge unit, size of grounding conductors, location of antenna discharge unit, connection to grounding electrodes, and requirements for the grounding electrode.
- Power Lines - An outside antenna system should not be located in the vicinity of overhead power lines or other electric light or power circuits, or where it can fall into such power lines or circuits. When installing an outside antenna system, extreme care should be taken to keep from touching such power lines or circuits as contact with them might be fatal.
- Overloading - Do not overload wall outlets, extension cords, or integral convenience receptacles, as this can result in a risk of fire or electric shock.
- Object and Liquid Entry - Never push objects of any kind into this product through openings as they may touch dangerous voltage points or short-out parts that could result in a fire or electric shock. Never spill liquid of any kind on the product.
- Servicing - Do not attempt to service this product yourself as opening or removing covers may expose you to dangerous voltage or other hazards. Refer all servicing to qualified service personnel.
- Damage Requiring Service - Unplug this product from the wall outlet and refer servicing to qualified service personnel under the following conditions:
 - a) When the power-supply cord or plug is damaged.
 - b) If liquid has been spilled, or objects have fallen into the product.
 - c) If the product has been exposed to rain or water.
 - d) If the product does not operate normally by following the operating instructions. Adjust only those controls that are covered by the operating instructions as an improper adjustment of other controls may result in damage and will often require extensive work by a qualified technician to restore the product to its normal operation.
 - e) If the product has been dropped or damaged in any way.
 - f) When the product exhibits a distinct change in performance, this indicates a need for service.
- Replacement Parts - When replacement parts are required, be sure the service technician has used replacement parts specified by the manufacturer or have the same characteristics as the original parts. Unauthorized substitutions may result in fire, electric shock, or other hazards.
- Safety Check - Upon completion of any service or repairs to this product, ask the service technician to perform safety checks to determine that the product is in proper operating condition.
- Wall or Ceiling Mounting - The product should be mounted to a wall or ceiling only as recommended by the manufacturer.
- Heat - The product should be situated away from heat sources such as radiators, heat registers, stoves, or other products (including amplifiers) that produce heat.

OPERATING ELEMENTS

FRONT VIEW

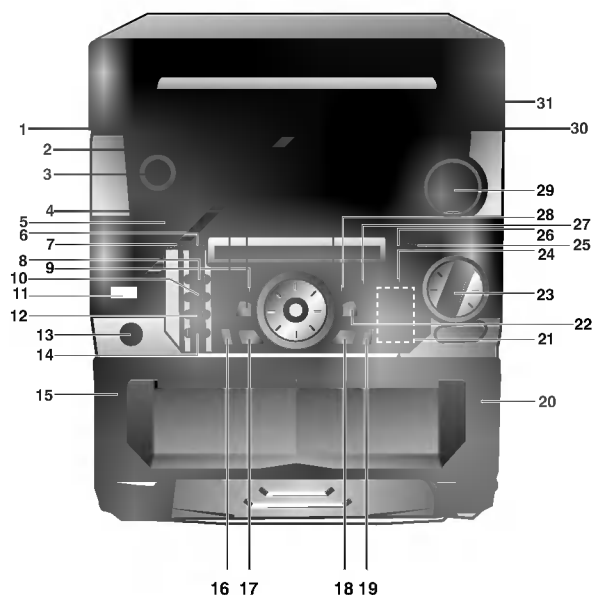

FRONT VIEW

1. RECORD / RECORD PAUSE buttons (●REC/II)
2. REMOTE SENSOR
3. MDSS indicator
4. MEMORY / PROGRAM button
5. DIMMER button
6. MDSS button
7. EQ. PATTERN button
8. CD REPEAT button
TAPE PLAY MODE button (OPTIONAL)
9. MODE / RIF button
10. TAPE 1/2 select button
11. POWER button
12. NORMAL DUBBING / CD SYNCHRO
RECORDING button
13. HEADPHONE socket (PHONES)
14. HI-SPEED DUBBING button
15. TAPE DECK 1 EJECT position (▲ PUSH EJECT)
16. AUTO / MANUAL TUNING DOWN(TUNER),
TAPE REWIND, TRACK BACKWARD(CD) SKIP
/SEARCH button(◀◀◀◀)
17. PRESET DOWN/BACKWARD PLAY
(OPTIONAL) button (PRESET DOWN/ ◀)
18. PRESET UP/FORWARD PLAY button (PRESET
UP / ▶)
19. AUTO / MANUAL TUNING UP (TUNER),
TAPE FAST FORWARD, TRACK FORWARD(CD)
SKIP /SEARCH button(▶▶▶▶)

BACK VIEW

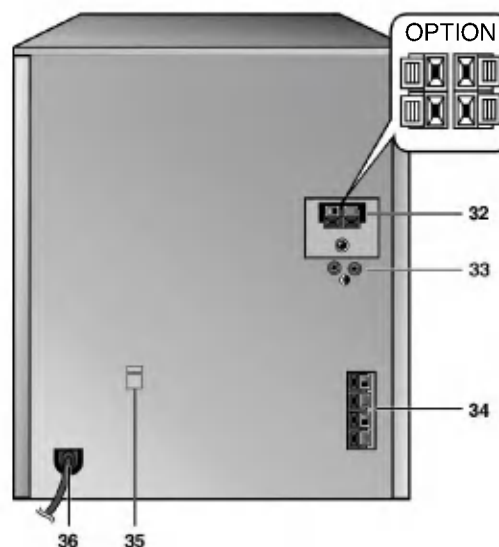

20. TAPE DECK 2 EJECT POSITION (▲ PUSH EJECT)
21. DISC DIRECT PLAY buttons (DISC1, DISC2, DISC3)
22. TAPE STOP / CD STOP / CLEAR button (■ STOP/ CLEAR)
23. FUNCTION SELECT knob [FM, MW(AM), LW/SW(OPTION), CD, TAPE 1/2, AUX]
24. CD OPEN/CLOSE button
25. TIMER button
26. CLOCK button
27. DISC SKIP button
28. CD PAUSE / SET(CLOCK / TIMER) / COUNTER RESET (TAPE) / RDS (TUNER) : OPTIONAL button (CD II/SET/COUNTER RESET/RDS:OPTIONAL)
29. VOLUME knob
30. CD PAUSE / SET indicator
31. CD DOOR

BACK VIEW

32. ANTENNA (AERIAL) terminal
33. AUXILIARY / PHONO (OPTIONAL)INPUT sockets
34. SPEAKER terminal
35. VOLTAGE SELECTOR (OPTIONAL)
36. POWER CORD

FUNCTION DISPLAY

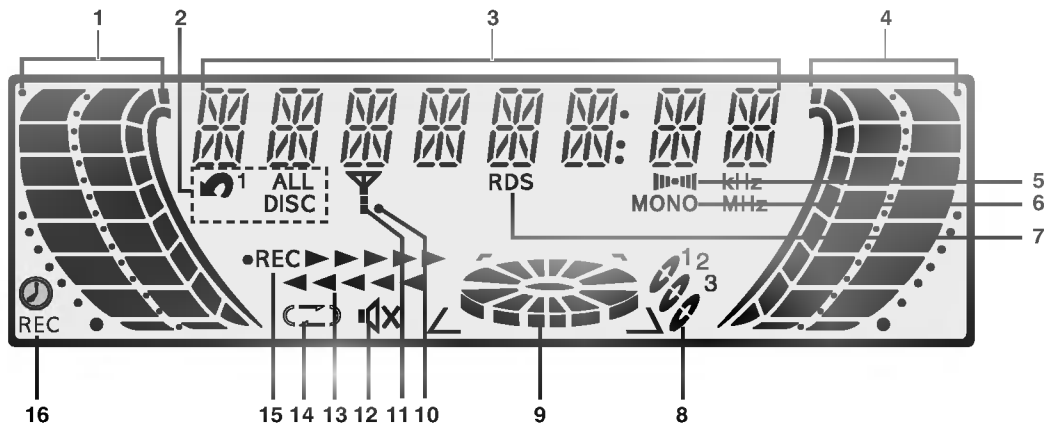

1. LEVEL indicator
2. CD REPEAT indicator
3. FUNCTION, VOLUME LEVEL, CLOCK, FREQUENCY, TAPE COUNTER, CD PLAYING TIME, MDSS, EQ PATTERN display
4. LEVEL indicator
5. FM STEREO RECEIVING indicator
6. FM MONO indicator
7. RDS indicator (OPTIONAL)
8. DISC NO. indicator
9. DISC entered indicator
10. R.I.F. indicator
11. AUTO TUNE RECEIVING indicator
12. MUTE indicator
13. TAPE DIRECTION indicator
14. PLAY MODE indicator
(Use only auto reverse deck)
15. RECORD / RECORD PAUSE indicator
16. TIMER indicator

REMOTE CONTROL

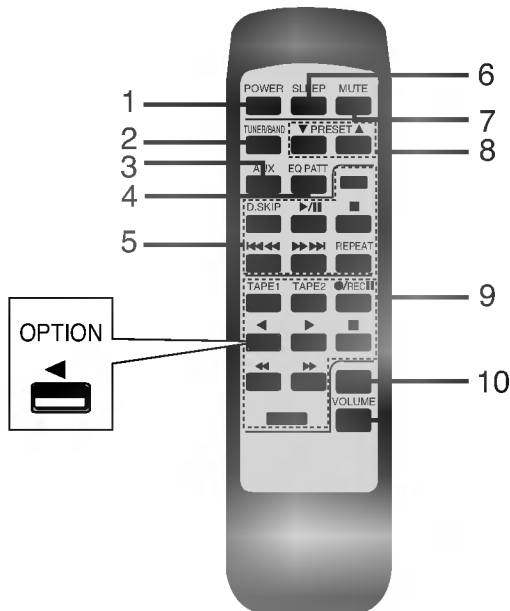

1. POWER button
2. TUNER / BAND button
3. AUX button
4. EQ PATTERN button
5. CD FUNCTIONS
 - DISC SKIP (D.SKIP) button
 - REPEAT button
 - PLAY/PAUSE (▶/||) button
 - STOP/CLEAR (■) button
 - SKIP / SEARCH (◀◀◀/▶▶▶) button
6. SLEEP button
7. MUTE button
8. PRESET DOWN/UP (▼/▲) button
9. TAPE FUNCTIONS
 - TAPE 1 / TAPE 2 button
 - RECORD / RECORD PAUSE button (●/REC II)
 - BACKWARD PLAY button (▶) : OPTIONAL
 - FORWARD PLAY buttons (◀)
 - STOP button (■)
 - REWIND / FAST FORWARD button (◀◀/▶▶)
10. VOLUME CONTROL (^/∨) buttons

REMOTE CONTROL

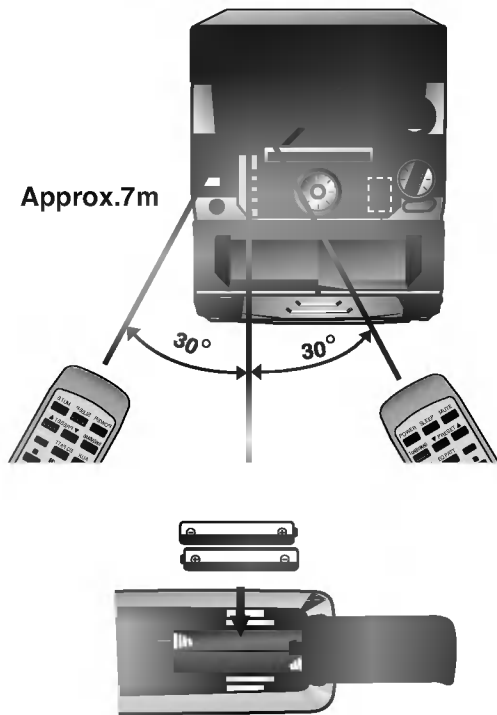

Control Range

The remote control device is designed for the range shown in the illustration.

NOTE

Strong light or obstacles between the remote control device and the stereo system may interfere with the functioning of the remote control.

Notes on Batteries

- Your remote control comes with batteries. Use two “AAA(UM-4. IEC R03)” type high quality batteries.
- When the remote control fails to operate accurately at maximum distance from the unit. Replace the worn out batteries with new ones.
- Install two “AAA” type batteries, observing correct battery polarity(⊕ and ⊖). Reversed battery polarity might damage the unit.
- Do not use different types of batteries together, or an old ones with new one.
- When you are not going to use the unit for a long time, remove the batteries to prevent possible electrolyte leakage.

CONNECTIONS

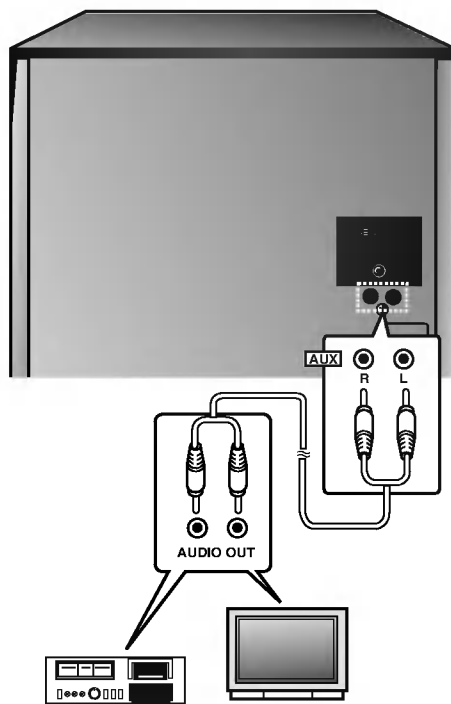

Connection the AUX Sockets

Two phono sockets marked ‘AUX’ are provided on the back of the unit for connecting other units (for example, a record player with a pre amplifier, video recorders or tape recorders.)

Connection the Loud Speakers

Insert the red wire of the right/left hand speaker into the red terminal marked(+) at the back of the unit. Insert the black wire into the black terminal marked(-).

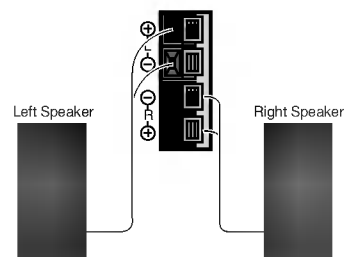

CONNECTIONS

Antenna(aerial) Connection

For the models for other countries figure (1), (3).
 For the European and U.K. model figure (2), (4).

IMPORTANT

FM Antenna (aerial) Connection

Unless radio signals are very weak, no external antenna is necessary, simply connect the supplied FM indoor antenna (aerial) wire to the terminal marked FM on the back of the unit

(1) 2 BAND(FM/AM) AREA

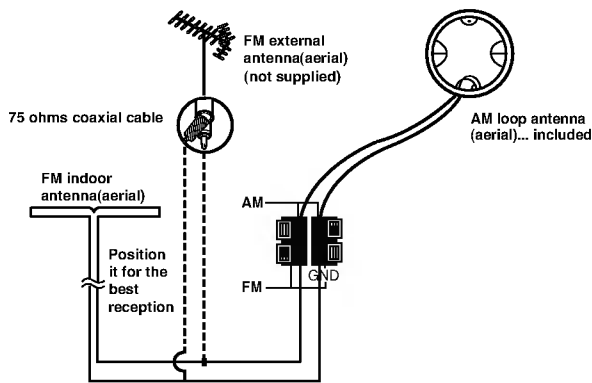

(2) 3 BAND(FM/MW/LW) AREA

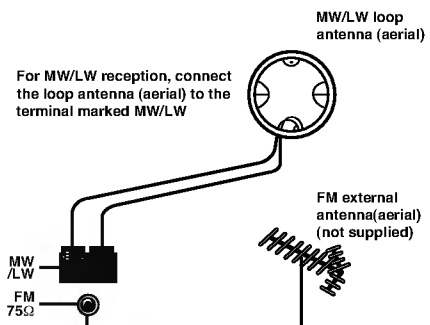

3) 3 BAND(FM/MW/SW) AREA

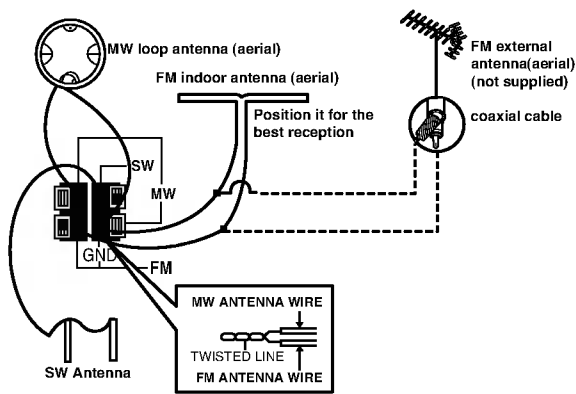

4) 2 BAND[FM/AM(MW)] AREA

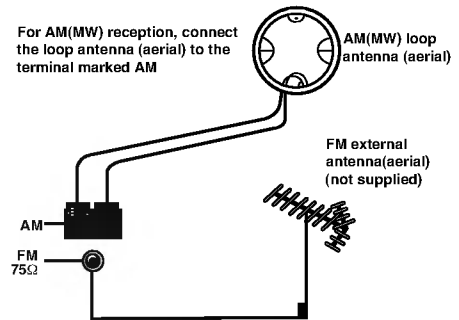

CLOCK SETTING

Example : Set to 9:25 in the morning

1. Press the **CLOCK** button. (If the clock is already set, press and hold the **CLOCK** button for more than 1.5 seconds)
- The hours begin to blink.



5. Press the **CDII/SET/COUNTER RESET** button.

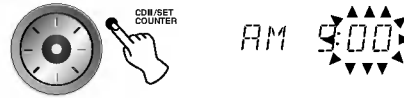

2. Select a 24 hour cycle or 12 hour cycle by pressing **PRESET DOWN / UP** button.

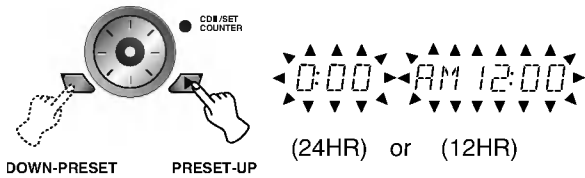

6. Set the minute with **PRESET DOWN / UP** button.

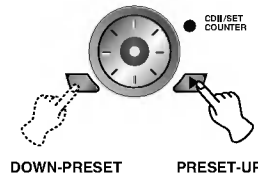

3. Press the **CDII/SET/COUNTER RESET** button.



7. Press the **CDII/SET/COUNTER RESET** button.
The clock starts operating.



4. Set the hour with **PRESET DOWN/UP** button.

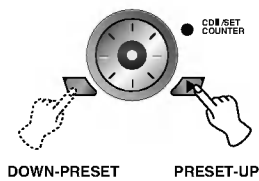

Information on the time

AM 12:00 = midnight

PM 12:00 = noon

NOTE:

When a power interruption has occurred for more than 10 seconds.

The clock setting is erased, and "-- : --" will flash on the display.

BEFORE OPERATING

■ Volume Adjustment

Turn VOLUME clockwise to increase the sound level, or counterclockwise to decrease it.

(Or press VOLUME \wedge or \vee button on the remote commander.)

■ Sound Quality Adjustment

▶ MDSS (Multi Dynamic Sound System)

Press the MDSS button to reinforce treble (HI-Tone), bass (UBB : Ultra Bass Booster), and surround effect.

The MDSS indicator lights up.

To cancel it press the MDSS button again

▶ To activate stereo sound

You can choose between 4 fixed sound impressions : select a desired sound mode by using the EQ PATTERN button.

Press the EQ PATTERN button once to see the current sound mode scrolled on the display.

Press the EQ PATTERN button repeatedly, until the desired sound mode is scrolled on the display.

FLAT : linear frequency response

ROCK : more bass, more treble

POP : less bass, less treble

CLASSIC : for orchestral music

▶ For personal listening

Connect headphone to headphone socket.

No sound comes from the speakers.

■ MUTE button(on remote control)

Press this button to mute your unit.

You can mute your unit in order, for example, to answer the telephone.

The  indicator appears on the display.

■ MODE/RIF

(Radio Interference Filter) button

To switch from mono to stereo reception and vice versa. If the power of transmission is too weak to receive stereo FM without interference, switch the STEREO off.

When a MW(AM), or LW broadcasting is being recorded, the R.I.F.(BEAT-SWITCH) button can be used to reduce unwanted "beat" signals and noise, which were not heard before recording.

■ Dimmer function

This function will be darkened the display by half in power-on status, if you press the DIMMER button once, only the display will be darkened, and if you press it once again the LEDs of the FUNCTION SELECTOR will go out. To cancel it press the button again.

And in SLEEP function setting mode the display will be darkened by half too.

RADIO RECEPTION

Tuning in Automatically

1. Turn on the power.
2. Press TUNER/BAND button repeatedly until the desired band appears.
3. Keep TUNING DOWN/UP (◀◀◀ or ▶▶▶) button depressed for more than 0.5 second. The unit tunes in a station automatically.

Tuning in Manually

1. Turn on the power.
2. Press TUNER/BAND button repeatedly until the desired band appears.
3. Press TUNING DOWN/UP (◀◀◀ or ▶▶▶) button briefly and repeatedly, until the desired station appears.

Storing Stations

1. To clear any program previously stored in any memory.

- (1) Press the PROG./MEMO. button for more than 1.5 seconds in TUNER mode so that **CLEAR** is flashing in the display.
- (2) Press the ■ STOP/CLEAR button while **CLEAR** is flashing in the display.

2. To memorize the stations in order

- (1) Press the TUNER / BAND button to select a desired wave band.
- (2) Press the TUNING DOWN / UP (◀◀◀ or ▶▶▶) button to select a desired station.
- (3) Press the PROG./MEMO. button and preset number flashes.
- (4) Press the PROG./MEMO. button again while preset number is flashing.
- (5) Repeat step (1) to (4) to memorized up to 30 stations.

3. To memorize in selecting or adding channel number.

- (1) Select a desired station.
- (2) Press the PROG./MEMO. button.
- (3) Select a desired channel number by turning pressing the PRESET DOWN / UP button, while the preset number flashes.
- (4) Press the PROG./MEMO. button again before the channel number stop flashing.

4. To recall presets.

Press and hold the PRESET DOWN / UP button until the desired preset number appears or press it repeatedly.

RDS(Radio Data System) Reception (OPTIONAL)

What is RDS ?

RDS (Radio Data System) is a system gradually being introduced on FM in many countries, where by an inaudible stream of data is transmitted in addition to the normal radio signal. This data contains various information including station / transmitter identification, traffic information and a list of alternative frequencies for the radio station being received.

Reception of RDS Stations

1. Press the TUNER / BAND button to select FM.
2. Select a desired station by pressing the TUNING DOWN / UP (◀◀◀/▶▶▶) button.
3. When the RDS transmission is received, the display shows the program service name (PS) after RDS indicator appears

Notes:

- RDS is only available for FM reception.
- The PS (PROGRAM SERVICE) NAME is displayed automatically when a RDS station is received.

To recall the frequency

Press the RDS button.

CD PLAYING

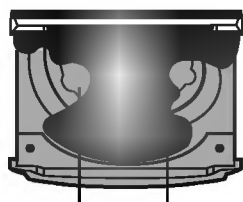

Number 1 disc Number 2 disc

Basic Operation

1. Press the CD FUNCTION button.
2. Press the CD OPEN/CLOSE (CD ▲) button to open the disc compartment.
3. Load disc (s) with the label side up.
 - **Playing one or two discs**
Place discs on trays 1 and 2.
 - **Playing three discs**
After placing two discs, press the DISC SKIP button to rotate the trays. Place the next disc on tray 3.

NOTICE

To load an 8cm(3 in.) disc, put it onto the inner circle of the tray.

4. Press the CD OPEN/CLOSE (CD ▲) button to close the disc compartment.
5. Press the PLAY (▶) (or ▶/|| on remote control) button to start play.
Play begins with the disc on the left hand side tray before closing the disc compartment. All the discs are played once only.

During playback

A tray which has no disc is skipped and play proceeds to the next tray. The indicator of the skipped tray number goes out in the display.

To stop play

Press the ■ STOP/CLEAR button.

To pause

Press the CD||/SET/COUNTER RESET (or ▶/|| on remote control) button.

To resume play, press it again.

To skip discs

During play or in the stop mode, press the DISC SKIP button.

During play

Play begins automatically after skipping.

In the stop mode

The change skips to the next disc, but the player remains stopped. Press the PLAY (▶) (or ▶/|| on remote control) button to play the next disc. Play begins and all the discs are played once.

To play one disc only

Press one of the DISC DIRECT PLAY(DISC 1,2,3) buttons to start play.

To remove discs

Press the CD OPEN/CLOSE button to open the disc compartment. You can remove two discs. To remove the disc on the back tray, press the DISC SKIP button to rotate the disc tray.

Changing Discs During Play

Two discs can be changed while the other remaining disc is played.

This operation is not applicable during programmed play.

1. Press the CD OPEN/CLOSE button to open the disc compartment.
2. Remove the discs and place other discs.
The disc placed on the left side tray will be played next.
3. Press the CD OPEN/CLOSE button to close the disc compartment.

NOTES



- Do not place more than one compact disc on one disc tray at the same time.
- If, during CD play, the video image of a nearby television is distorted, or if static is heard from a nearby radio, move this unit further away from the affected television or radio.

Searching for a Particular Point in a Track

You can locate a particular point in a track during play by monitoring the high-speed cueing sound or observing the CD counter in the display.

To search back:

Keep the ◀◀◀ button pressed and release it at the desired point.

To search forward:

Keep the ▶▶▶ button pressed and release it at the desired point.

CD PLAYING

Skipping to the Beginning of a Track

You can locate the beginning of any track on a disc.

To return to the beginning of the current or previous track.

Press the ►►►► button once to return to the beginning of the current track.

Press the ◀◀◀◀ button repeatedly to skip tracks backward one by one.

To skip tracks

Press the ►►►► button repeatedly to skip track(s) forward one by one.

Repeat Play

To play one track repeatedly.

Press the REPEAT button to display “ 1 ” and press the PLAY/PAUSE ►/|| (► : on unit) button to start play.

To play one disc repeatedly.

Press the REPEAT button twice to display “ 1 DISC ”. and press PLAY/PAUSE ►/|| (► :on unit) button to start play.

To play all tracks on all discs repeatedly.

Press the REPEAT button three times to display “ ALL DISC ”, and press the PLAY/PAUSE ►/|| (► :on unit) button to start play.

To repeat only selected tracks

Program the desired tracks, and press the REPEAT button to display “ 1 ” or “ ALL DISC ”.

To cancel repeat play

Press the REPEAT button so that “ 1 ” in the display goes out.

During playback

You can also operate the repeat play during playback.

NOTICE

- During the programmed play, you can play repeatedly one track (1) or all discs (ALL DISC).
- During the repeat play of an entire disc, if you select the programmed play, it is changed to repeat play of all discs.

Programmed Play

The player has a memory function that allows play of up to 20 tracks over three discs in any order.

1. Press the PROG./MEMO. button in the stop mode.
2. Press one of the DISC SELECTOR buttons or DISC SKIP button to select a disc.
3. Press the ◀◀◀◀ or ►►►► button to select the track.
To select the 6th track, press the ◀◀◀◀ or ►►►► button repeatedly until track number “6” is displayed in the display.
4. Press the PROG./MEMO. button.
5. Repeat steps 2 to 4.
6. Press the PLAY ► (►/|| : on remote control) button to start play.

To check the programmed contents

Each time the PROG./MEMO. button is pressed in the stop mode, a disc number, a track number, and a program number will be displayed.

To clear the programmed contents

- Press the PROG./MEMO. button during stop and then press the ■ STOP/CLEAR button.
- Turn off the power.
- Press the CD OPEN / CLOSE button.

To add tracks to the program

- (1) Press the PROG./MEMO. button to search until 00 appears in the track number.
- (2) Select the desired track on the disc with DISC SKIP button and ◀◀◀◀ or ►►►► button.
- (3) Press the PROG./MEMO. button.

To change the programmed tracks

- (1) Press the PROG./MEMO. button to display the changed program number.
- (2) Select the desired track on the disc with DISC SKIP button and ◀◀◀◀ or ►►►► button.
- (3) Press the PROG./MEMO. button.

NOTICE

- The DISC SKIP button does not operate during programmed play.

AUXILIARY FUNCTION

1. Switch on the auxiliary device i.e. TV or VCR, connected to the rear mounted AUX (PHONO) sockets.
2. Press the "AUX" function button.

NOTE:

You can also record from the auxiliary input source, see RECORDING section.

TAPE PLAYBACK

Playback

Preparation

- You can use only normal tapes.

1. To set the cassette function:

Switch the unit on and press the TAPE 1/2 button. (If necessary press the button again to select the other deck.)

2. To insert cassettes:

Open cassette deck 1 (or 2) of both by pushing the deck ▲PUSH EJECT position. Insert one or two cassettes with the tape side to the bottom and the cassette side that you wish to hear facing the front in cassette deck 1 or 2.

Note:

DECK 1 - Auto stop only (No auto reverse)
DECK 2 - Auto reverse

3. Auto reverse :

Select which side of the cassette is to be played and how often with the PLAY MODE button.

1) 1st Option

In case of non-autoreverse (auto stop) deck 1 and auto reverse deck 2.

In this case the continuous play between deck 1 and 2 can not be performed.



(a) DECK 1

Front side play only.

(b) DECK 2 (Auto Reverse)

One side  : Unit plays the front or reverse side in deck B and stops automatically at the end of the tape.

All side  : Unit plays the front and reverse side in deck 2 and stops automatically at the end of the tape.

Endless loop  : Like  but six times in succession in deck 2.

2) 2nd Option

In case of non-autoreverse (auto stop) deck 1 and 2. (Front side play only)

4. Playback:

Start playback with PLAY button ► (front side) or ► (reverse side). The ◀(reverse side) PLAY button is not operated in the non-autoreverse deck.

5. Fast forward or rewind :

Press button ►►►► on the unit or on the remote control for fast forward and ◀◀◀◀ to rewind.

6. To end playback :

Press the ■ STOP / CLEAR button.

The unit stops automatically at the end of the tape.

Tape Counter Reset

Press the COUNTER RESET button while tape playing or stop.

During play or fast forward, the tape counter increases and during rewind, the tape counter decreases.

RECORDING

Recording from a CD, Radio or Connected Equipment

Preparation

- Wind on the tape to the point recording starts.
- Use only normal tapes.
- You can record from cassette deck 2 only.

1. To select the function :

Switch the unit on and select CD, TUNER, AUX etc.

2. To insert the cassette :

Open the cassette deck 2.
Insert a blank cassette into the cassette compartment.

3. PLAY MODE (OPTIONAL)

Select the play mode with PLAY MODE button, \rightleftharpoons if you wish to record one cassette side only and \rightarrow or \leftarrow for both cassette sides.

4. Recording mode :

Press the **●REC/||** button.
The REC indicator flashes and holds the cassette in pause mode.

5. To start recording :

Press the **●REC/||** button or PLAY button \blacktriangleright if you want to record the front side or \blacktriangleleft for the reverse side (OPTIONAL). The recording begins.

NOTE :

If both cassette sides are to be recorded (PLAY MODE \rightleftharpoons , \rightarrow) always start with the front side PLAY \leftarrow . (Use only auto reverse deck)

6. To interrupt recording :

To interrupt the recording for a short period, press the **●REC/||** button again.
To continue with the recording, press the **●REC/||** button one more time.

7. To end the recording :

Press the **■ STOP / CLEAR** button.
The unit stops automatically at the end of the tape.

CD Synchro Recording

The CD synchro recording function dubs a complete CD and programmed titles automatically into a cassette.

1. Select the CD function.

2. Open the CD compartment with the CD OPEN / CLOSE (CD▲) button, insert discs and close the CD compartment again.

3. To insert cassette :

Open the cassette deck 2.
Insert a blank cassette into the cassette compartment.
Rewind the cassette to the beginning of the tape.

4. Auto reverse (OPTIONAL)

Select the PLAY MODE, \rightleftharpoons if you only wish to record the front side and \rightarrow or \leftarrow for both cassette sides.

NOTE:

If the last track has stopped because the tape is full, the track will be recorded again completely on the reverse side of the cassette tape.

5. To start recording :

Press the CD SYNCHRO RECORDING button.
The recording begins and stops automatically at the end of the CD.

NOTE:

In case of Auto Stop deck (OPTIONAL)

If you want to record in a new tape after one tape continuously, change the new tape prior to pressing the PLAY button.

The tape enters into the recording mute mode for 7 seconds then CD player starts playing and recording.

NOTES :

1. If you only want to record certain titles, program these before the CD synchro recording.
2. If you wish to record from the desired track, select the desired track with the $\blacktriangleleft\blacktriangleleft\blacktriangleleft / \blacktriangleright\blacktriangleright\blacktriangleright$ button before commencing CD synchro recording.
3. The function change is not possible during recording.

RECORDING

Recording from Tape to Tape (Dubbing)

Preparation

- Wind on the tape to the point recording starts.
- Use only normal tapes.
- Dubbing only functions from cassette deck 1 (playback) to cassette deck 2 (recording)

1. Select the TAPE function.

2. To insert cassettes :

- Open cassette deck 1.
- Insert a recorded cassette and the cassette side that you wish to dub to the front.
- Open cassette deck 2.
- Insert a blank cassette in the cassette compartment and the cassette side that you wish to record to the front.

3. To dub(auto dubbing):

- Rewind both cassettes to the beginning of the tape.
- Press NORMAL DUBBING for normal and HIGH DUBBING for double speed dubbing.
- The dubbing starts up automatically.

NOTES :

The pause function does not operate during dubbing.

4. To end dubbing :

- Press the ■ STOP / CLEAR button.
- The unit stops automatically at the end of the tape.

NOTE :

You cannot change the speed of dubbing while dubbing.
The volume has no effect on the record level.

TIMER

Timer Setting

With the TIMER function you can have the radio reception and recording, CD play, tape play or play and recording from auxiliary source turned on and off at the time desired.

1. Check the current time.

2. Press the TIMER button to enter the timer setting mode. (If the timer is already set, press the button for more than 1.5 seconds.)

⌚ indicator appears in the display and each function-TUNER, CD, TAPE, AUX - flashes in the display in turn.

3. If you want to select the TUNER, press the CDII/SET/COUNTER button until the TUNER appears in the display window.

'PLAY' and 'REC' flashes in turn.

(1) Press the CDII/SET/COUNTER RESET button to confirm either PLAY and REC.

PLAY : TUNER play only

REC : TUNER play and recording

(2) Press PRESET DOWN or UP to select a desired radio station of the previous programmed preset numbers.

If the radio stations have nothing in the memory, this step is automatically skipped and you can operate continuously from step (3); in this case, it will play the radio broadcast that was being received before turning off the unit.

(3) Press the CDII/SET/COUNTER button to confirm the selected preset number.

(4) Set the hour to switch on by pressing PRESET DOWN or UP.

(5) Press the CDII/SET/COUNTER button to confirm the hour to switch on.

The minute flashes.

(6) Set the minute to switch on, by pressing PRESET DOWN or UP.

(7) Press the CDII/SET/COUNTER button to confirm the minute to switch on.

Now off appears and the hour flashes in the display.

TIMER

- (8) **Program the time to switch off in the same way as the time to turn on.**
- (9) **Set the volume level by pressing PRESET DOWN or UP.**
- (10) **Press the CD/SET/COUNTER RESET button to confirm the selected volume level.**

⓪ remains in the display and the timer setting has been perfected.

- (11) **Switch the system off.**

The selected function is automatically switched on and off at the time set.

■ **If you select the AUX:**

Follow steps (1)~(11) except steps (2)~(3) of '3. If you want to select the TUNER'.

■ **If you select the CD or TAPE:**

Follow steps (4)~(11) of the '3. If you want to select the TUNER'. explanation section.

4. To cancel or check the timer.

Each time the TIMER button is pressed you can select the timer activating or cancel. You can also check the timer setting status.

To activate or check the timer, press the TIMER button so that "⓪" lights up in the display.

To cancel the TIMER, press the TIMER button so that "⓪" in the display goes out.

NOTES:

1. When the CD or TAPE is selected for playback, if no disc is entered in the disc drawer or no cassette tape is entered in the cassette deck, the TUNER function will be operated.
2. When the CD programmed playback, the REPEAT ALL DISC (⓪^{ALL DISC}) will be selected automatically.

3. When the TAPE is selected for playback, if both cassette decks have cassette tapes in; the cassette tape in deck 2 will be selected first.
4. The timer-off function will be operated only in the case of power-on by the timer on.

Sleep Timer Setting

(Operating with only the remote control)

When the sleep timer is used, the power is automatically turned off after the specified time has elapsed.

1. **To specify the time until the power is turned off, Press the SLEEP button.** In the display you can see *SLEEP 90* for about 5 seconds. This means that the units turns off automatically after 90 minutes.

Each time the button is pressed the time interval before it turns off is reduced by 10 minutes. i.e. 80...70...etc.

Select the desired time to turn off.

2. **To check the remaining time until the power is turned off.**

While the sleep function is active press the SLEEP button briefly. The time remaining until it turns off is displayed for about 5 seconds.

NOTE:

If you press the SLEEP button while the sleep time is displayed, the SLEEP time is set again.

3. **To cancel the sleep timer mode**

If you wish to stop the function press the SLEEP button repeatedly until 10 appears, and then press the SLEEP button once again while 10 is displayed.

AUTO FUNCTION SELECT SYSTEM

This unit has an auto function select system for various functions. i.e. If a function is in operation(e.g. radio reception), and you wish to switch to another(e.g. cassette playback), all you have to do is select the desired function(cassette playback) directly, the unit automatically switches to the new function(cassette recorder).This applies for the following functions:

1. On the remote control

TUNER : PRESET ▼/▲ buttons
 CD : PLAY/PAUSE(▶/||) button
 TAPE : FORWARD(▶) and REVERSE(◀) PLAY buttons (OPTIONAL)

2. On the unit

CD : DISC DIRECT PLAY buttons
 (DISC 1, 2, 3)

SPECIFICATIONS

SECTION	MODEL	FFH - 262	FFH - 363
AMP Output Power Frequency Response Signal-to-Noise Ratio		10W+10W (4Ω , 2ch, T.H.D 10%) 42~25,000 Hz 83 dB	30W+30W (6Ω, 2ch, T.H.D 10%) 42~25,000 Hz 83 dB
TUNER FM Tuning Range(optional) Intermediate Frequency Signal-to-Noise Ratio (Mono/Stereo, 98MHz) Frequency Response AM(MW) Tuning Range(optional) Intermediate Frequency Frequency Response SW(OPTIONAL) Tuning Range Intermediate Frequency Signal-to-Noise Ratio(11MHz) LW(OPTIONAL) Tuning Range Intermediate Frequency Signal-to-Noise Ratio(254kHz)		87.5~108 MHz or 65~74 MHz & 87.5~108 MHz 10.7 MHz 62/58 dB 60~12,500 Hz 522~1,611 kHz, 530~1,720 kHz or 530~1,610 kHz 450 kHz 100~2,000 Hz 5.8~18.0 MHz 450 kHz 35 dB 153~281 kHz 450 kHz 28 dB	87.5~108 MHz or 65~74 MHz & 87.5~108 MHz 10.7 MHz 62/58 dB 60~12,500 Hz 522~1,611 kHz, 530~1,720 kHz or 530~1,610 kHz 450 kHz 100~2,000 Hz 5.8~18.0 MHz 450 kHz 35 dB 153~281 kHz 450 kHz 28 dB
CASSETTE DECK FF, REW Time(C-60) Frequency Response Signal-to-Noise Ratio Channel Separation		120 sec. 125~8,000 Hz 43 dB(P/B), 43dB(R/P) 50 dB(P/B), 45dB(R/P)	120 sec. 125~8,000 Hz 43 dB(P/B), 43dB(R/P) 50 dB(P/B), 45dB(R/P)
CD Frequency Response Signal-to-Noise Ratio		40~18,000 Hz 70 dB	40~18,000 Hz 70 dB
GENERAL Power Requirements Net Dimensions(WxHxD) Net Weight		Refer to the back panel of the unit. 273 x 326 x 360 mm 6.1 kg	Refer to the back panel of the unit. 273 x 326 x 360 mm 6.5 kg
SECTION	MODEL	FE - 262E	FE - 363E
SPEAKER SYSTEM Type Impedance Frequency Response Sound Pressure Level Rated Input Power Max. Input Power Net Dimensions(WxHxD) Net Weight		Bass Reflex 2 Way 2 Speaker System 4 Ω 60~20,000 Hz 86 dB/W(1m) 10W 20W 200 x 325 x 206 mm 2.3kg	Bass Reflex 2 Way 2 Speaker System 6 Ω 60~20,000 Hz 86 dB/W(1m) 30W 60W 200 x 325 x 249 mm 2.3kg

* NOTE : Designs and specifications are subject to change without notice for improvement.



(For the customers in Germany)

LG Electronics Deutschland GmbH

**Jakob-Kaiser-Straße 12
D-47877 Willich
Telefon:+49 -(0)2154-492-0
Telefax:+49 -(0)2154-428-799
Internet:<http://www.lge.de>
P/NO.:3828RCD012E**