



MICROWAVE OVEN

OWNER'S MANUAL

MODEL : MS-7042MK

Please read this owner's manual thoroughly before operating.

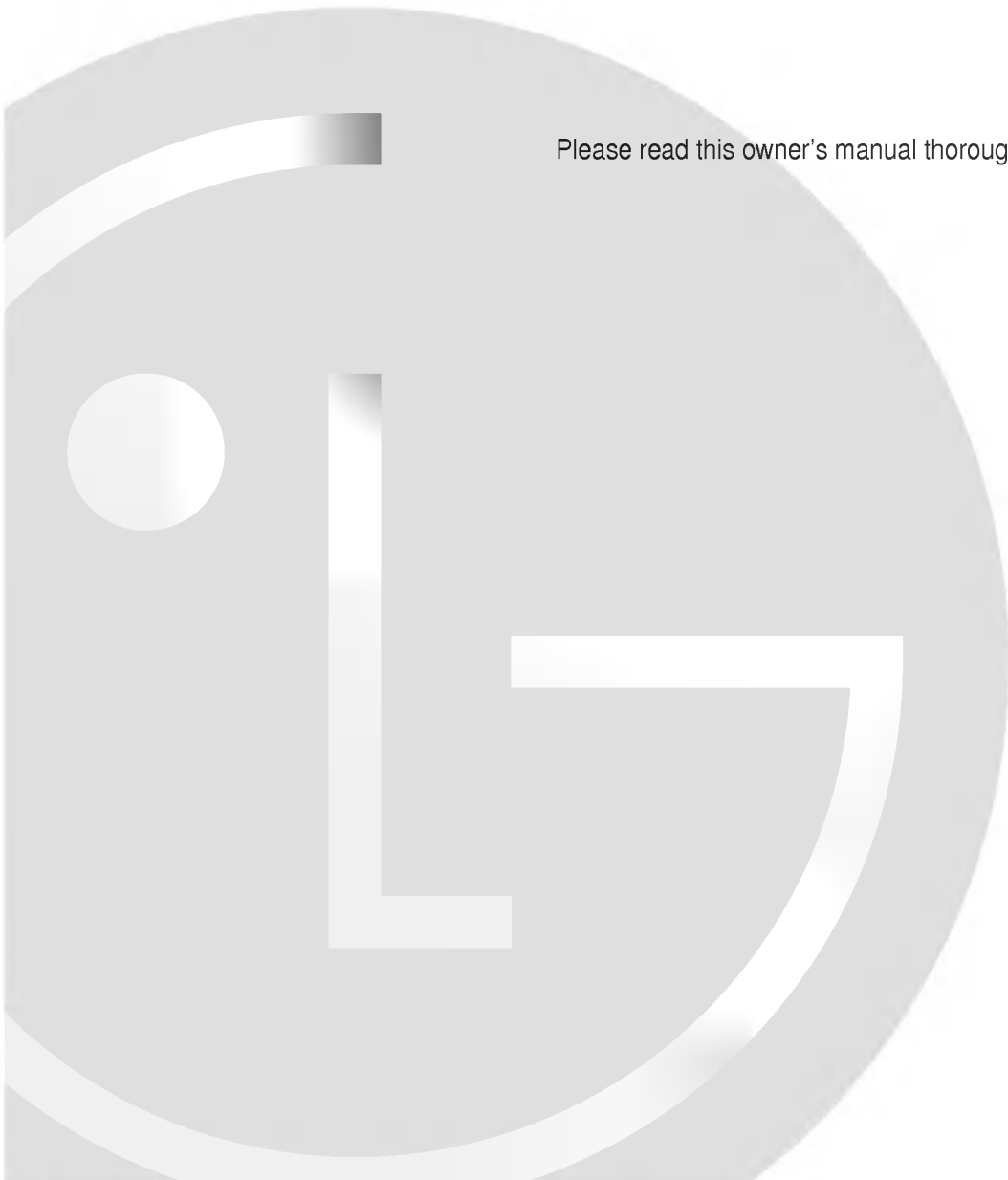

P/NO. 3828W5A2699

PRECAUTIONS TO AVOID POSSIBLE EXPOSURE TO EXCESSIVE MICROWAVE ENERGY

- (a) Do not attempt to operate this oven with the door open since open-door operation can result in harmful exposure to microwave energy. It is important not to defeat or tamper with the safety interlocks.
- (b) Do not place any object between the oven front face and the door or allow soil or cleaner residue to accumulate on sealing surfaces.
- (c) Do not operate the oven if it is damaged. It is particularly important that the oven door close properly and that there is no damage to the:
 - (1) Door (bent),
 - (2) Hinges and latches (broken or loosened),
 - (3) Door seals and sealing surfaces.
- (d) The oven should not be adjusted or repaired by anyone except properly qualified service personnel.
- (e) You should only use the microwave with the GLASS TRAY in place.
Always place the food in a container on the GLASS TRAY.

IMPORTANT SAFETY INSTRUCTIONS	3
INSTALLATION	4
OTHER HELPFUL INFORMATION	5
COOKING UTENSILS	7
FEATURE DIAGRAM	8
CONTROL PANEL	8
TECHNICAL SPECIFICATIONS	8
OPERATING INSTRUCTIONS	9-14
VEGETABLE COOKING CHART	15
REHEATING CHART	16
PRECAUTIONS	17
QUESTIONS AND ANSWERS	18

IMPORTANT SAFETY INSTRUCTIONS

WARNING - To reduce the risk of burns, electric shock, fire, injury to persons, or exposure to excessive microwave energy:

1. Read all instructions before using the appliance.

2. Read and follow the specific **PRECAUTIONS TO AVOID POSSIBLE EXPOSURE TO EXCESSIVE MICROWAVE ENERGY** found on page 2 of this manual.

3. This appliance must be grounded. Connect only to properly grounded outlet. See **GROUNDING INSTRUCTIONS** found on page 4 of this manual .

4. Install or locate this appliance only in accordance with the provided installation instructions.

5. Some products, such as whole eggs and sealed containers – for example, closed glass jars – may explode and should not be heated in this oven.

6. Use this appliance only for its intended use as described in the manual. Do not use corrosive chemicals or vapors in this appliance. This type of oven is specifically designed to heat, cook, or dry food. It is not designed for industrial or laboratory use.

7. As with any appliance, close supervision is necessary when used by children.

8. Do not operate this appliance if it has a damaged cord or plug, if it is not working properly, or if it has been damaged or dropped.

9. This appliance should be serviced only by qualified service personnel. Contact the nearest authorized service facility for examination, repair, or adjustment.

10. Do not cover or block any openings on the appliance.

11. Do not store this appliance outdoors. Do not use this product near water - for example, near a kitchen sink, in a wet basement, or near a swimming pool, and the like.

12. Do not immerse cord or plug in water.

13. Keep cord away from heated surfaces.

14. Do not let cord hang over the edge of a table or counter.

15. When cleaning surfaces of door and oven that comes together on closing the door, use only mild, nonabrasive soaps or detergents applied with a sponge or soft cloth.

16. To reduce the risk of fire in the oven cavity:

a. Do not overcook food. Carefully attend appliance if paper, plastic, or other combustible materials are placed inside the oven to facilitate cooking.

b. Remove wire twist-ties from paper or plastic bags before placing bag in oven.

c. If materials inside the oven should ignite, **KEEP OVEN DOOR CLOSED**, turn oven off, and disconnect the power cord or shut off power at the fuse or circuit breaker panel.

d. Do not use the cavity for storage purposes. Do not leave paper products, cooking utensils, or food in the cavity when not in use.

17. Do not heat any type of baby bottles or baby food. Uneven heating may occur and could cause personal injury.

18. Avoid heating small-necked containers such as syrup bottles.

19. Avoid using corrosive and vapors, such as sulfide and chloride.

20. Liquids heated in certain shaped containers (especially cylindrical-shaped containers) may become overheated. The liquid may splash out with a loud noise during or after heating or when adding ingredients (instant coffee, etc.), resulting in harm to the oven and possible injury. In all containers, for best results, stir the liquid several times before heating. Always stir liquid several times between reheatings.

SAVE THESE INSTRUCTIONS

A. GROUNDING INSTRUCTIONS

This appliance must be grounded. In the event of an electrical short circuit, grounding reduces the risk of electric shock by providing an escape wire for the electric current. This appliance is equipped with a cord having a grounding wire with a grounding plug. The plug must be plugged into an outlet that is properly installed and grounded.

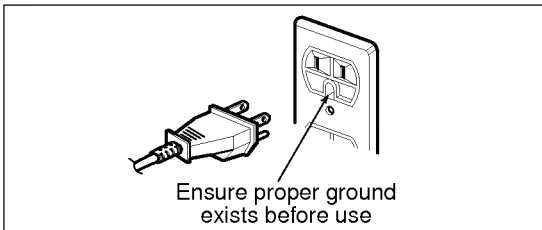

WARNING

Improper grounding can result in a risk of electric shock. Consult a qualified electrician if the grounding instructions are not completely understood, or if doubt exists as to whether the appliance is properly grounded, and either:

1. If it is necessary to use an extension cord, use only a 3-wire extension cord that has a 3-blade grounding plug, and a 3-slot receptacle that will accept the plug on the appliance. The marked rating of the extension cord shall be equal to or greater than the electrical rating of the appliance, or
2. Do not use an extension cord. If the power supply cord is too short, have a qualified electrician or serviceman install an outlet near the appliance.

NOTE:

1. A short power-supply cord is provided to reduce the risks resulting from becoming entangled in or tripping over a longer cord.
2. Longer cord sets or extension cords are available and may be used if care is exercised in their use.
3. If a long cord or extension cord is used, (1) the marked electrical rating of the cord set or extension cord should be at least as great as the electrical rating of the appliance, (2) the extension cord must be a grounding-type 3-wire cord, and (3) the longer cord should be arranged so that it will not drape over the countertop or tabletop where it can be pulled on by children or tripped over accidentally.

B. CIRCUITS

For safety purposes this oven must be plugged into a 15 Amp circuit. No other electrical appliances or lighting circuits should be on this line. If in doubt, consult a licensed electrician.

C. VOLTAGE WARNING

The voltage used at the wall receptacle must be the same as specified on the oven name plate located on the back or on the side of the control panel of the oven. Use of a higher voltage is dangerous and may result in a fire or other type of accident causing oven damage. Low voltage will cause slow cooking. In case your microwave oven does not perform normally in spite of proper voltage, remove and reinsert the plug.

D. PLACEMENT OF THE OVEN

Your microwave oven can be placed easily in your kitchen, family room, or anywhere else in your home. Place the oven on a flat surface such as a kitchen countertop or a specially designed microwave oven cart. Do not place oven above a gas or electric range. Free air flow around the oven is important.

E. DO NOT BLOCK AIR VENTS

All air vents should be kept clear during cooking. If air vents are covered during oven operation the oven may overheat. In this case, a sensitive thermal safety device automatically turns the oven off. The oven will be inoperable until it has cooled sufficiently.

F. RADIO INTERFERENCE

1. Microwave oven operation may interfere with TV or radio reception.
2. When there is interference, it may be reduced or eliminated by taking the following measures:
 - a. Clean the door and the sealing surfaces of the oven.
 - b. Reorient the receiving antenna of radio or television.
 - c. Relocate the microwave oven in relation to the TV or radio.
 - d. Move the microwave oven away from the receiver.
 - e. Plug the microwave oven into a different outlet so that microwave oven and receiver are on different branch circuits.

PRECAUTIONS

- *Be certain to place the front surface of the door three inches away or more from the countertop edge to avoid accidental tipping of the appliance in normal usage.
- *For the most accurate programming of the electronic units, touch the center of each pad securely. Do not touch several pads at one time or touch between pads. A beep sound should be heard with each touch when a pad is touched correctly.
- *Do not hit or strike the control with objects such as silverware, utensils, etc. Breakage may occur.
- *Be careful when taking the cooking utensils out of the oven. Some dishes absorb heat from the cooked food and may be hot.
- *Do not rinse cooking utensils by immediately placing them into water just after cooking. This may cause breakage. Allow the turntable to cool.
- *Use only specific glass utensils. See cooking utensils section in this manual.
- *Do not operate the oven empty. Either food or water should always be in the oven during operation to absorb microwave energy.
- *Do not use your microwave oven to dry newspapers or clothes. They can catch fire.
- *Use only thermometers approved for microwave oven cooking.
- *Be certain the turntable is in place when you operate the oven.
- *Pierce the skin of potatoes, whole squash, apples, or any fruit or vegetable which has a skin covering before cooking.
- *Never use your microwave oven to cook eggs in the shell. Pressure can build up inside the shell, causing it to burst.
- *Do not pop popcorn, except in a microwave-safe container or commercial package designed especially for microwave ovens. Never try to pop popcorn in a paper bag not designed for microwave oven use. Overcooking may result in smoke and fire. Do not repop unpopped kernels. Do not reuse popcorn bags.

GETTING THE BEST RESULTS FROM YOUR MICROWAVE OVEN

Keep an eye on things. The instructions in this book have been formulated with great care, but your success in preparing them depends, of course, on how much attention you pay to the food as it cooks. Always watch your food while it cooks. Your microwave oven is equipped with a light that turns on automatically when the oven is in operation so that you can see inside and check the progress of your recipe. Directions given in recipes to elevate, stir, and the like should be thought of as the minimum steps recommended. If the food seems to be cooking unevenly, simply make the necessary adjustments you think appropriate to correct the problem.

Factors affecting cooking times. Many factors affect cooking times. The temperature of ingredients used in a recipe makes a big difference in cooking times. For example, a cake made with ice-cold butter, milk, and eggs will take considerably longer to bake than one made with ingredients that are at room temperature. All of the recipes in this book give a range of cooking times. In general, you will find that the food remains under-cooked at the lower end of the time range, and you may sometimes want to cook your food beyond the maximum time given, according to personal preference. The governing philosophy of this book is that it is best for a recipe to be conservative in giving cooking times. While undercooked food may always be cooked a bit more, overcooked food is ruined for good. Some of the recipes, particularly those for bread, cakes, and custard, recommend that food be removed from the oven when they are slightly undercooked. This is not a mistake. When allowed to stand, usually covered, these foods will continue to cook outside of the oven as the heat trapped within the outer portions of the foods gradually travels inward. If the foods are left in the oven until they are cooked all the way through, the outer portions will become overcooked or even burnt. As you gain experience in using your microwave oven, you will become increasingly skillful in estimating both cooking and standing times for various foods.

SPECIAL TECHNIQUES IN MICROWAVE COOKING

Browning: Meats and poultry that are cooked fifteen minutes or longer will brown lightly in their own fat. Foods that are cooked for a shorter period of time may be brushed with a browning sauce to achieve an appetizing color. The most commonly used browning sauces are Worcestershire sauce, soy sauce, and barbecue sauce. Since relatively small amounts of browning sauces are added to foods, the original flavor of recipes is not altered.

Covering: A cover traps heat and steam and causes food to cook more quickly. You may either use a lid or microwave cling-film with a corner folded back to prevent splitting.

Covering with waxed paper: Waxed paper effectively prevents spattering and helps food retain some heat. Since it makes a looser cover than a lid or cling-film, it allows the food to dry out slightly.

Wrapping in waxed paper or paper towel: Sandwiches and many other foods containing prebaked bread should be wrapped prior to microwaving to prevent drying out.

Arranging and spacing: Individual foods such as baked potatoes, small cakes, and hors d'oeuvres will heat more evenly if placed in the oven and equal distance apart, preferably in a circular pattern. Never stack foods on top of one another.

Stirring: Stirring is one of the most important of all microwaving techniques. In conventional cooking, foods are stirred for the purpose of blending. Microwaved foods, however, are stirred in order to spread and redistribute heat. Always stir from the outside towards the center as the outside food heats first.

Turning over: Large, tall foods such as roasts and whole chickens should be turned so that the top and bottom will cook evenly. It is also a good idea to turn cut-up chicken and chops.

Placing thicker portions near the edge: Since microwaves are attracted to the outside portion of foods, it makes sense to place thicker portions of meat, poultry and fish to the outer edge of the baking dish. This way, thicker portions will receive the most microwave energy and the foods will cook evenly.

Elevating: Thick or dense foods are often elevated so that microwaves can be absorbed by the underside and center of the foods.

Piercing: Foods enclosed in a shell, skin, or membrane are likely to burst in the oven unless they are pierced prior to cooking. Such foods include both yolks and whites of eggs, clams and oysters, and many whole vegetables and fruits.

Testing if cooked: Because foods cook so quickly in a microwave oven, it is necessary to test food frequently. Some foods are left in the microwave until completely cooked, but most foods, including meats and poultry, are removed from the oven while still slightly undercooked and allowed to finish cooking during standing time. The internal temperature of foods will rise between 5°F (3°C) and 15°F (8°C) during standing time.

Standing time: Foods are often allowed to stand for 3 to 10 minutes after being removed from the microwave oven. Usually the foods are covered during standing time to retain heat unless they are supposed to be dry in texture (some cakes and biscuits, for example). Standing allows foods to finish cooking and also helps flavors to blend and develop.

HOW FOOD CHARACTERISTICS AFFECT MICROWAVE COOKING

Density of foods: Light, porous food like cakes and breads cook more quickly than heavy, dense foods such as roasts and casseroles. You must take care when microwaving porous foods that the outer edges do not become dry and brittle.

Height of foods: The upper portion of tall foods, particularly roasts, will cook more quickly than the lower portion. Therefore, it is wise to turn tall foods during cooking, sometimes several times.

Moisture content of foods: Since the heat generated from microwaves tends to evaporate moisture, relatively dry foods such as roasts and some vegetables should either be sprinkled with water prior to cooking or covered to retain moisture.

Bone and fat content of foods: Bones conduct heat and fat cooks more quickly than meat. Therefore, care must be taken when cooking bony or fatty cuts of meat that the meats do not cook unevenly and do not become overcooked.

Shape of foods: Microwaves penetrate only about 1 inch (2.5cm) into foods; the interior portion of thick foods is cooked as the heat generated on the outside travels inward. In other words, only the outer edge of any food is actually cooked by microwave energy; the rest is cooked by convection. It follows then that the worst possible shape for a food that is to be microwaved is a thick cube. The corners will burn long before the center is even warm. Round, thin, and ring shaped foods cook most successfully in the microwave.

Quantity of foods: The number of microwaves in your oven remains constant regardless of how much food is being cooked. Therefore, the more food you place in the oven, the longer the cooking time. Remember to decrease cooking times by at least one-third when halving a recipe.

MICROWAVE-SAFE UTENSILS

Never use metal or metal-trimmed utensils in your microwave oven: Microwaves cannot penetrate metal. They will bounce off any metal object in the oven and cause arcing, an alarming phenomenon that resembles lightning. Most heat-resistant non-metallic cooking utensils are safe for use in your microwave oven. However, some may contain materials that render them unsuitable as microwave cookware. If you have any doubts about a particular utensil, there is a simple way to find out if it can be used in your microwave oven.

Testing utensils for microwave use: Place the utensil in question next to a glass bowl filled with water in the microwave oven. Microwave at power HIGH for 1 minute. If the water heats up but the utensil remains cool to the touch, the utensil is microwave-safe. However, if the water does not change temperature but the utensil becomes warm, microwaves are being absorbed by the utensil and it is not safe for use in the microwave oven. You probably have many items on hand in your kitchen that can be used as cooking equipment in your microwave oven. Just read through the following checklist.

1. Dinner plates: Many kinds of dinner-ware are microwave-safe. If in doubt consult the manufacturer's literature or perform the microwave test, above.

2. Glassware: Glassware that is heat-resistant is microwave-safe. This includes all brands of oven-tempered glass cookware. However, do not use delicate glassware, such as tumbler or wine glasses, as these might shatter as the food warms.

3. Paper: Paper plates and containers are convenient and safe to use in your microwave oven, provided the cooking time is short and foods to be cooked are low in fat and moisture. Paper towels are also very useful for wrapping foods and for lining baking trays in which greasy foods, such as bacon, are cooked. In general, avoid colored paper products as the color may run.

4. Plastic storage containers: These can be used to hold foods that are to be quickly reheated. However, they should not be used to hold foods that will need considerable time in the oven as hot foods will eventually warp or melt plastic containers.

5. Plastic cooking bags: These are microwave-safe provided they are specially made for cooking. However, be sure to make a slit in the bag so that steam can escape. Never use ordinary plastic bags for cooking in your microwave oven, as they will melt and rupture.

6. Plastic microwave cookware: A variety of shapes and sizes of microwave cookware is available. For the most part, you can probably cook with items you already have on hand rather than investing in new kitchen equipment.

7. Pottery, stoneware, and ceramic: Containers made of these materials are usually fine for use in your microwave oven, but they should be tested to be sure.

CAUTION: SOME ITEMS ARE NOT INTENDED FOR COOKING, INCLUDING SOME STONEWARE AND ITEMS WITH HIGH IRON OR LEAD CONTENTS.

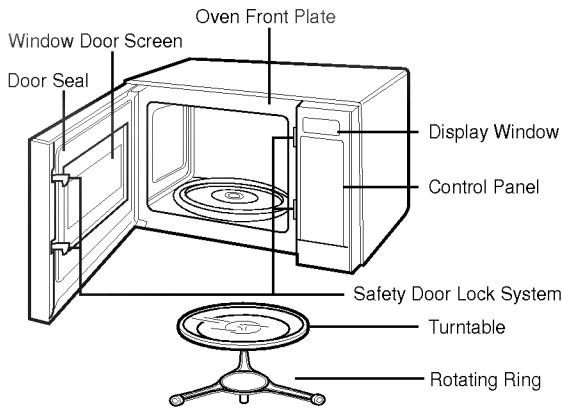

Your oven will be packed with the following materials:

- Glass Turntable 1 each
- Use and Care Instructions 1 each
- Rotating Ring 1 each

This microwave oven is designed for household use only. It is not recommended for commercial purposes.

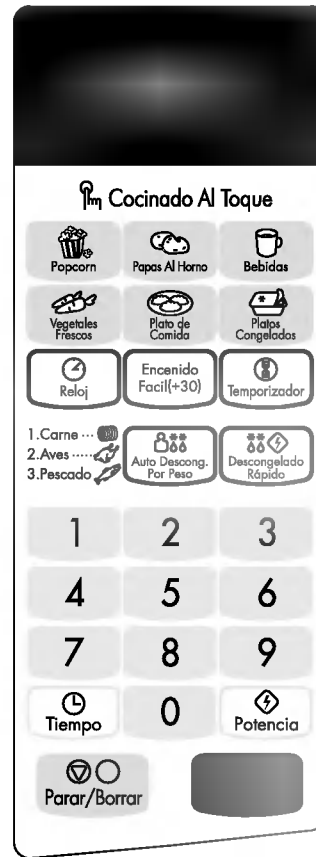

Model No.	MS-7042MK
Specifications	
Power Supply	120 V AC, 60 Hz
Rated Power Consumption	1000 W
Microwave Output	*700 W
Frequency	2450 MHz
Rated Current	8.5 A
Overall Dimensions (W X H X D)	17 ²¹ / ₂₃ X 11 ² / ₁₁ X 12 ³ / ₅
Oven Cavity Dimensions (W X H X D)	12 ³ / ₁₆ X 7 ³¹ / ₃₂ X 11 ⁵ / ₈
Effective Capacity of Oven Cavity	0.7 Cu.ft

*IEC 60705 RATING STANDARD
Specifications subject to change without prior notice.

SETTING CLOCK

When your oven is plugged in for the first time or when power resumes after a power interruption, the numbers in the display reset to 0.

Example: To set 11:11

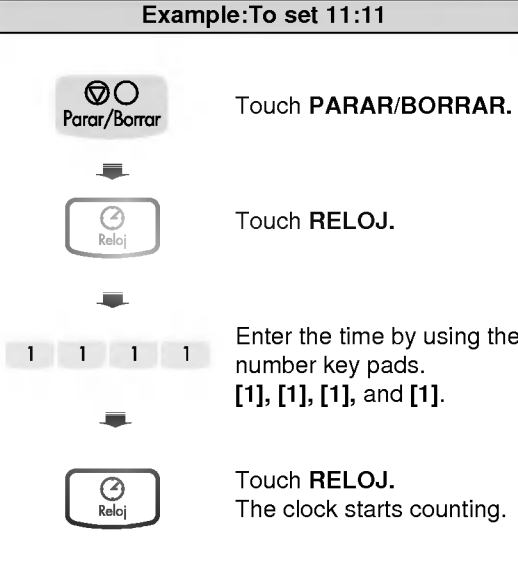

Touch **PARAR/BORRAR**.

Touch **RELOJ**.

Enter the time by using the number key pads. **[1], [1], [1], and [1]**.

Touch **RELOJ**. The clock starts counting.

NOTE:

To erase Err, touch PARAR/BORRAR pad.

ADD 30

Inicio Rápido allows you to cook for 30 seconds at 100% power by simply touching the Inicio Rápido pad. You can also extend cooking time in multiples of 30 seconds by repeatedly touching the Inicio Rápido pad during cooking.

Example: To set cooking for 2 minutes with Inicio Rápido pad.

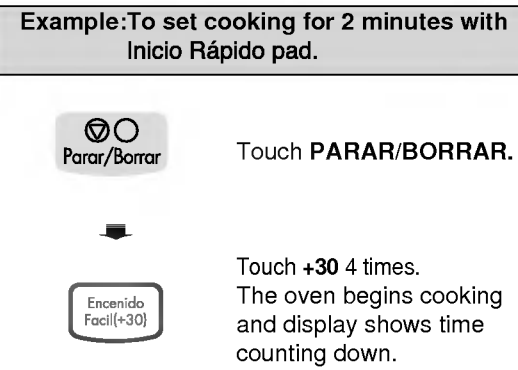

Touch **PARAR/BORRAR**.

Touch **+30** 4 times. The oven begins cooking and display shows time counting down.

TIMED COOKING

This function allows you to cook food for a desired time. And in order to give you the best results, there are 10 power level settings in addition to HI-POWER because many food need slower cooking (at less than HI-POWER).

Example: To cook food on 80% Power(Power8) for 5 minutes 30 seconds

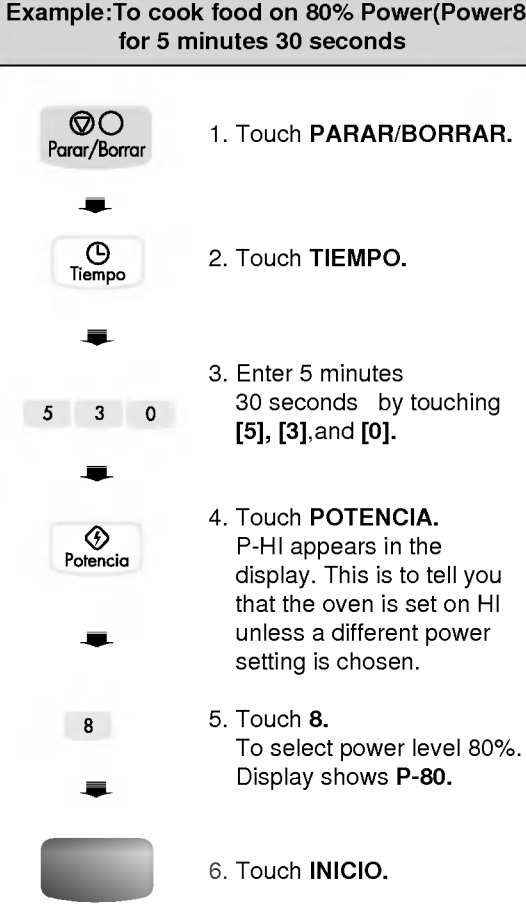

1. Touch **PARAR/BORRAR**.
2. Touch **TIEMPO**.
3. Enter 5 minutes 30 seconds by touching **[5], [3], and [0]**.
4. Touch **POTENCIA**. P-HI appears in the display. This is to tell you that the oven is set on HI unless a different power setting is chosen.
5. Touch **8**. To select power level 80%. Display shows **P-80**.
6. Touch **INICIO**.

When the cooking time is over, two short and one long tone sounds. The word **End** shows in the display window. Then the oven shuts itself off.

NOTE :

If you do not select the power level, the oven will operate at power HIGH. To set HI-POWER cooking, skip steps 4 & 5 above.

2 STAGE TIMED COOKING

For Two Stage cooking, repeat timed cooking steps 2 through 5 on the previous page before touching the INICIO pad for additional Time and Power program you want to add.

MICROWAVE POWER LEVELS

Your microwave oven is equipped with eleven power levels to give you maximum flexibility and control over cooking. The table below will give you some idea of which foods are prepared at each of the various power levels.

*The chart below shows the power level settings for your oven.

MICROWAVE POWER LEVEL CHART

Power Level	Use
High	*Boiling water. *Browning ground beef. *Making candy. *Cooking poultry pieces, fish, & vegetables. *Cooking tender cuts of meat.
9	*Reheating rice, pasta, & vegetables.
8	*Reheating prepared foods quickly. *Reheating sandwiches.
7	*Cooking egg, milk and cheese dishes. *Cooking cakes, breads. *Melting chocolate.
6	*Cooking veal. *Cooking whole fish. *Cooking puddings and custard.
5	*Cooking ham, whole poultry, lamb. *Cooking rib roast, sirloin tip.
4	*Thawing meat, poultry and seafood.
3	*Cooking less tender cuts of meat. *Cooking pork chops, roast.
2	*Taking chill out of fruit. *Softening butter.
1	*Keeping casseroles and main dishes warm. *Softening butter and cream cheese.
0	*Standing time. *Independent timer.

CHILD LOCK

This is a unique safety feature that prevents unwanted oven operation such as used by children. Once the child lock is set, no cooking can take place.

Example: To set the child lock



Touch **PARAR/BORRAR**.



0

Touch and hold 0 until L appears in the display

When child lock was already set, if you touch INICIO or one touch cook pad display shows L. Then you can cancel the child lock according to below procedure.

Example: To cancel the child lock

0

Touch and hold 0 until L disappears in the display. The time of day returns to the display window.

Q-DEFROST

The Q-DEFROST feature provides you with the quick defrosting method for 1.0 lbs frozen foods. when the oven will sound - tone during time counting down, open the door and turn, separate or rearrange food.



Touch **PARAR/BORRAR**.



Touch **DESCONGELADO RÁPIDO**.

TIMER

You can use the Timer of your oven for purposes other than food cooking.

Example: To count 3 minutes for an egg or telephone call

Touch **PARAR/BORRAR**.

Touch **TIEMPO**.

Touch numbers to set
3 0 0

Touch **POTENCIA**.

Touch **[0]** (Power Level 0).

Touch **INICIO**.

ONE TOUCH COOKING

One Touch Cooking made easy! Your oven's menu has been preprogrammed to cook food automatically. Tell the oven what you want. Then let your microwave oven cook your selections.

Example: To cook popcorn, simply follow the step below

Touch **PARAR/BORRAR**.

*Place popcorn in the oven and close the door.

Touch **POPCORN**.
The oven begins the cooking you selected without the need to touch **INICIO**. Be sure to close the door before selecting categories.

ONE TOUCH COOKING CHART

Key	Touch	Serving size	Directions
POPCORN (PALOMITAS)	1 Time 2 Times 3 Times	3.5 oz. 3.0 oz. 1.75 oz.	<ul style="list-style-type: none"> ¥ Follow package instructions. ¥ Use popcorn package which is made especially for microwave cooking. ¥ Do not try to pop unpopped kernels. ¥ Heat only 1 package at a time. ¥ Do not leave the microwave oven unattended while popping popcorn.
POTATO (PAPAS AL HORNO)	1 Time 2 Times 3 Times 4 Times	1 ea (8 oz.) 2 ea (16 oz.) 3 ea (24 oz.) 4 ea (32 oz.)	<ul style="list-style-type: none"> ¥ Place in center of the oven on paper towel. Pierce potato several times with fork. After cooking, let stand for 5 minutes.
BEVERAGE (BEBIDAS)	1 Time 2 Times	1 cup (8 oz.) 2 cups (16 oz.)	<ul style="list-style-type: none"> ¥ Use mug or microwave-safe cup. ¥ Stir after reheating.
FRESH VEGETABLE (VEGETALES FRESCOS)	one Time two Times three Times four Times	1 cup 2 cups 3 cups 4 cups	<ul style="list-style-type: none"> ¥ Prepare vegetable(wash and cut into 1/2-inch pieces). ¥ Cover with plastic wrap and vent.
FOOD PLATE (PLATO DE COMIDA)	one Time two Times	1 serving 2 servings	<ul style="list-style-type: none"> ¥ Arrange food on turntable tray. ¥ Cover with plastic wrap and vent.
FROZEN ENTREE (PLATOS CONGELADOS)	one Time	10 oz.	<ul style="list-style-type: none"> ¥ Follow the package instructions.

AUTO WEIGHT DEFROST

Three defrost sequences are preset in the oven. The defrost feature provides you with the best defrosting method for frozen foods. The cooking guide will show you which defrost sequence is recommended for the food you are defrosting.

With the Auto Weight Defrost feature, the oven automatically sets the defrosting time and power levels for you.

The oven automatically determines required defrosting times for each food item according to the weight you enter.

For added convenience, the Auto Weight Defrost Feature contains a built-in beep mechanism that lets you check, turn over, separate or rearrange as recommended in the Auto Defrosting AUTO WEIGHT DEFROST GUIDE.

Three different defrosting levels are provided.

DEF1 : MEAT(CARNE)

DEF2 : POULTRY(AVES)

DEF3 : FISH(PESCADO)

*You can select the category by touching the key once (CARNE), twice (AVES), or three times (PESCADO).

*Available weight is 0.1~6.0 lbs.

However, when you want to defrost and cook consecutively, you should enter less than 6.0 lbs. If you attempt to defrost and cook 6.1 lbs consecutively, **Err** will show in the display window.

Example: To defrost 1.2 lbs of ground beef, select Meat menu, enter the weight, and press INICIO

Touch **PARAR/BORRAR**.

Touch **AUTO DESCONG. POR PESO**.
dEF 1 appears in the display.

Enter the weight by touching **[1]** and **[2]**.
1.2 appears in the display.

Touch **INICIO**.
Defrosting starts.

NOTE:

When you touch the INICIO pad, the display changes to defrost time count down. The oven will beep twice during the DEFROST cycle. At each beep, open the door and turn, separate or rearrange the food.

Remove any portions that have thawed.

Return frozen portions to the oven and touch INICIO to resume the defrost cycle. **The oven will not STOP during the BEEP unless the door is opened.**

*For best results, remove fish, shellfish, meat, and poultry from its original closed paper or plastic package (wrapper). Otherwise, the wrap will hold steam and juice close to the foods, which can cause the outer surface of the foods to cook.

*Place foods in a shallow glass baking dish or on a microwave roasting rack to catch drippings.

*Food should still be somewhat icy in the center when removed from the oven.

AUTO WEIGHT DEFROST SEQUENCE LIST

Sequence	Food
1 MEAT (CARNE)	BEEF Ground beef, Round steak, Cubes for stew, Tenderloin steak, Pot roast, Rib roast, Rump roast, Chuck roast, Hamburger patty.
	LAMB Chop(1 inch thick), Rolled roast
	PORK Chop(1/2 inch thick), Hot dogs, Spareribs, Country-style ribs. Rolled roast, Sausage.
2 POULTRY (AVES)	VEAL Cutlets(1 lbs, 1/2 inch thick)
	POULTRY Whole(under 4 lbs), Cut up Breasts (boneless)
	CORNISH HENS Whole TURKEY Breast(under 6 lbs)
3 FISH (PESCADO)	FISH Fillets, Whole Steaks
	SHELLFISH Crab meat, Lobster tails, Shrimp, Scallops

WARNING : Do not use aluminum foil during cooking cycle.

MEAT(CARNE)

1. No special techniques are required. The roast should be prepared and seasoned (if desired) as for any other conventional method. Meat should be thoroughly defrosted before cooking.
2. Place the meat on a microwave roasting rack or ovenproof plate and place on the turntable.
3. Cook according to the cooking chart (below), using the longer time for large meats and the shorter time for smaller meats. For thicker chops, use the longer time.
4. Turn the meat once halfway through the cooking time.
5. STAND for 5-10 minutes wrapped in foil after cooking. The standing time is very important as it completes the cooking process.
6. Ensure meat, especially pork, is thoroughly cooked before eating.

MEAT COOKING CHART

Cut	Microwave power	Cooking time per pound
BEEF		
Standing/Rolled Rib		
-Rare	8	9~11 minutes
-Medium	8	10~12 minutes
-Well-done	8	12~14 minutes
Ground Beef (to brown for casserole)	HIGH	7~9 minutes
Hamburgers, Fresh or defrosted (4 oz. each)		
-2 patties	HIGH(100%)	3~5 minutes
-4 patties	HIGH(100%)	4~6 minutes
PORK		
Loin, Leg	8	13~16 minutes
Bacon		
-4 slices	HIGH	3~4 minutes
-6 slices	HIGH	4~6 minutes

NOTE:

The above times should be regarded only as a guide. Allow for difference in individual tastes and preferences. The times may vary due to the shape, cut, and composition of the meat.

POULTRY(AVES)

1. No special techniques are required. The poultry should be prepared as for any other conventional method. Season if desired.
2. Poultry should be thoroughly defrosted, ensuring giblets and any metal clamps are removed.
3. Prick the skin and brush lightly with vegetable oil unless self-basting.
4. All poultry should be placed on a microwave roasting rack or a microwave-proof plate and placed on the turntable.
5. Cook according to the instructions in the cooking chart (below), turning the bird over halfway through the cooking time. Poultry, because of its shape, has a tendency to cook unevenly, especially in very bony parts. Turning the bird during roasting helps to cook these areas evenly.
6. STAND for 5-10 minutes wrapped in foil after cooking before carving. The standing time is very important, as it completes the cooking process.
7. Ensure poultry is thoroughly cooked before eating. Whole poultry is completely cooked when the juices run clear from the inside thigh when it is pierced with a sharp knife. Poultry portions should be pierced with a sharp knife through the thickest part to ensure that the juices are clear and the flesh is firm.

POULTRY COOKING CHART

Poultry	Microwave power	Cooking time per pound
CHICKEN		
Whole	8	12~14 minutes
Breast(boned)	8	10~12 minutes
Portions	8	11~13 minutes
TURKEY		
Whole	8	13~15 minutes

NOTE:

*The above times should be regarded only as a guide. Allow for difference in individual tastes and preferences. The times may vary due to the shape, cut, and composition of the food.

*If whole birds are stuffed, the weight of the stuffed bird should be used when calculating the cooking time.

FISH(PESCADO)

1. Arrange fish in a large shallow non-metallic dish or casserole.
2. Cover with pierced microwave plastic film or casserole lid.
3. Place the dish on the turntable.
4. Cook according to the instructions in the cooking chart (below). Flakes of butter can be added to the fish if desired.
5. Let STAND as directed in the cooking chart before serving.
6. After standing time, check to see that the fish is thoroughly cooked. The fish should be opaque and flake easily.

FRESH FISH COOKING CHART

Fish	Microwave power	Cooking Time per pound	Method	Standing Time
Fish Fillets	HIGH	5~7 minutes	Add 15~30 ml (1~2 tbsp.)	2~3 minutes
Whole Mackerel, Cleaned and Prepared	HIGH	5~7 minutes	—	3~4 minutes
Whole Trout, Cleaned and Prepared	HIGH	6~8 minutes	—	3~4 minutes
Salmon Steaks	HIGH	6~7 minutes	Add 15~30 ml (1~2 tbsp.)	3~4 minutes

Vegetable	Preparation	Quantity	Cooking Time at power Level 10	Standing Time
artichokes, fresh	whole	4 (8-oz. each.)	12-14 minutes	5 minutes
artichoke, frozen	hearts	9-oz. package	10-11 minutes	5 minutes
asparagus, fresh	1½-in. pieces	1 lb.	9-10 minutes	3 minutes
asparagus, frozen	whole spears	10-oz. package	9-11 minutes	3 minutes
beans, green or wax, fresh	1½-in. pieces	1lb.	10-12 minutes	—
beans, green or wax, frozen	cut up	9-oz. package	8-10 minutes	3 minutes
beets, fresh	sliced	1½ - 2 lb.	16-18 minutes	5 minutes
broccoli, fresh	spears	1lb.	9-11 minutes	—
broccoli, frozen	whole or cut	10 oz. package	9-10 minutes	3 minutes
brussels sprouts, fresh	whole	10-oz. tub	8-10 minutes	—
brussels sprouts, frozen	whole	10-oz. package	9-10 minutes	3 minutes
cabbage, fresh	chopped	1 lb.	9-10 minutes	5 minutes
	wedges	1 lb.	9-11 minutes	5 minutes
carrots, fresh	½-in. slices	1 lb.	5-8 minutes	3 minutes
carrots, frozen	sliced	10-oz. package	8-10 minutes	3 minutes
cauliflower, fresh	florets	1 medium head	9-11 minutes	3 minutes
	whole	1 medium head	9-12 minutes	5 minutes
cauliflower, frozen	florets	10-oz. package	8-10 minutes	3 minutes
celery, fresh	½-in. slices	1lb.	9-11 minutes	5 minutes
corn, fresh	on cob, husked	4 ears	11-13 minutes	5 minutes
corn, frozen	on cob, husked	4 ears	13-15 minutes	5 minutes
	whole kernel	10-oz. package	9-10 minutes	3 minutes
eggplant, fresh	cubed	1 lb.	9-11 minutes	3 minutes
	whole, pierced	1-1½ lb.	10-12 minutes	5 minutes
leeks fresh	whole, ends	1 lb.	10-12 minutes	5 minutes
lima beans, frozen	whole	10 oz. package	8-10 minutes	3 minutes
mixed vegetables frozen	—	10 oz. package	8-10 minutes	3 minutes
mushrooms, fresh	sliced	1 lb.	7-9 minutes	3 minutes
okra, frozen	sliced	10 oz. package	8-10 minutes	5 minutes
onions, fresh	whole, peeled	8-10 small	13-17 minutes	5 minutes
peas, fresh	shelled	1 lb.	8-10 minutes	—
peas, frozen	shelled	10-oz. package	8-10 minutes	3 minutes
pea pods(snow peas),frozen	whole	6-oz. package	7-8 minutes	—
peas and carrots	—	10-oz. package	9-11 minutes	3 minutes
parsnips, fresh	cubed	1 lb.	9-10 minutes	5 minutes
potatoes, white or sweet,fresh	whole	4 (6 oz. each)	13-15 minutes	3 minutes
	whole	8 (6 oz. each)	18-20 minutes	5 minutes
rutabaga, fresh	cubed	4 cups	14-16 minutes	5 minutes
spinach, fresh	whole leaf	1 lb.	8-11 minutes	—
spinach, frozen	leaf or chopped	10-oz. package	9-10 minutes	3 minutes
squash, summer, fresh	½-in. slices	1 lb.	9-11 minutes	3 minutes
squash, summer, frozen	sliced	10-oz. package	8-10 minutes	3 minutes
squash, winter, fresh	whole,pierced	1½ lbs.	15-17 minutes	5 minutes
squash, winter, frozen	whipped	12-oz. package	10-12 minutes	3 minutes
succotash, frozen	—	10-oz. package	9-11 minutes	3 minutes
turnips	cubed	4 cups	14-16 minutes	3 minutes

Item	Quantity	Power Level	Heating Time (in minutes)	Special Instructions
Appetizers (bite size)	2 servings	10	4 to 6	Heat 12 at a time on paper towel lined paper plate or microwave oven roasting rack.
Breakfast entree	4 to 5 oz.	10	3 to 5	If container is $\frac{3}{4}$ -inch deep, remove foil cover and replace foil tray in original box. For containers more than $\frac{3}{4}$ inch deep, remove food to similar size glass container; heat, covered. If no top crust stir occasionally.
Entree	8 to 9 oz.	10	8 to 10	
Regular TV-style dinner	21 oz.	10	14 to 17	
Hearty TV-style dinner	11 oz.	10	7 $\frac{1}{2}$ to 9	
Fried chicken	2 pieces	10	5 to 7	Arrange, on paper towel lined paper plate, covered with paper towel.
	4 pieces	10	6 to 8	
	6 pieces	10	7 to 9	
Fried fresh fillets	2 fillets	10	3 to 4	
	4 fillets	10	4 to 6	
Pizzas	1	5	2 to 4	Arrange on microwave oven roasting rack.
	2	5	4 to 5	
	4	5	5 to 7	
Pouch dinners	5 to 6 oz.	10	5 to 6	Pierce pouch. Set on plate. Turn over halfway through cooking.
	10 to 11 oz.	10	9 to 11	
Bagels	2	4	1 $\frac{1}{2}$ to 2	Each individually wrapped in paper toweling (for 1 to 2) or arrange on paper plate, cover with paper toweling.
	4	4	2 to 4	
Danish	1	4	1 to 2	
	2	4	2 to 3	
	4 (6 oz. pkg)	4	3 to 4	
	6 (13 oz. pkg)	4	4 to 5	
Dinner rolls	6	4	2 to 3	
Hard rolls	1 (1 to 1 $\frac{1}{4}$ oz.)	4	1 to 2	
	2	4	1 $\frac{1}{2}$ to 2 $\frac{1}{2}$	
	4	4	2 to 3	
Frozen juice	6 oz.	10	1 to 2	Remove lid. If container is foil lined transfer to a pitcher or open carton. Let stand after defrosting.
Concentrates	12 oz.	10	2 to 5	
Non-Dairy creamer	16 oz.	4	10 to 12	
Pancake	10 oz.	4	5 to 6	
Frozen vegetables	6 oz.	10	3 to 5	Pierce box, set on plate. If box is foil wrapped, remove foil. If vegetables are in pouch, pierce pouch. Let stand 5 minutes.
	10 oz.	10	5 to 6 $\frac{1}{2}$	
Cheese cake	17 oz.	4	4 to 5	Remove from original container. Arrange on a serving plate. Let stand 5 minutes after cooking (to defrost). Add an additional 1 to 2 minutes to serve warm.
Brownies	13 oz.	4	2 to 4	
Pound cake	10 $\frac{3}{4}$ oz.	4	1 $\frac{1}{2}$ to 3	
Coffee cake	11 to 12 oz.	4	3 to 5	

- 
1. Do not attempt to tamper with, or make any adjustments or repairs to door control panel, safety interlock switches or any other part of the oven. Repairs should be done by qualified service personnel only.
 2. Be certain to place the front surface of the door three inches or more away from the countertop edge to avoid accidental tipping of the appliance in normal usage.
 3. For the most accurate programming of the electronic units, touch the center of each pad securely. Do not touch several pads at one time or touch in between pads. A beep sound should be heard with each touch when pad is touched correctly.
 4. Do not hit or strike the control with objects such as silverware, utensils, etc. Breakage may occur.
 5. Be careful when taking the cooking utensils out of the oven. Some dishes absorb heat from the cooked food and may be hot.
 6. Do not rinse cooking utensils by immediately placing them into water just after cooking. This may cause breakage. Allow the turntable to cool down.
 7. Do not use glass utensils. See cooking utensils section in this manual:
 8. Do not operate the oven empty. Either food or water should always be in the oven during operation to absorb microwave energy.
 9. Do not heat unopened food containers in the oven. Pressure build-up can cause the container to burst, resulting in injury.
 10. Do not use your microwave oven dry newspapers or clothes. They can catch fire.
 11. Only use thermometers approved for Microwave Oven Cooking.
 12. Be certain the turntable is in place when you operate the oven.
 13. Pierce the skin of potatoes, whole squash, apples or any fruit or vegetable which has a skin covering, before cooking.
 14. Never use your microwave oven to cook eggs in the shell. Pressure can build up inside the shell causing it to burst.
 15. **Do not** pop popcorn, except in a microwave approved popcorn popper or commercial package designed especially for microwave ovens.
Never try to pop popcorn in a paper bag not designed for microwave oven use. Overcooking may result in smoke and fire.
Do not repop unpopped kernels.
Do not reuse popcorn bags.

Q. What's wrong when the oven light will not glow?

- A. ■ Light bulb is burned out.
■ Door is not closed.

Q. Why is steam coming out of the air exhaust vent?

A. Steam is normally produced during cooking operations. The microwave oven has been made to vent this steam out of the top vent.

Q. Does microwave energy pass through the viewing screen in the door?

A. No. The metal screen reflects the energy to the oven cavity. The holes, or ports are made to allow light to pass; they do not let microwave energy through.

Q. Will the microwave oven be damaged if it operates while empty?

A. Yes. Never run it empty.

Q. Why do eggs sometimes pop?

A. When baking, frying, or poaching eggs, the yolk may pop due to steam build up inside the yolk membrane. To prevent this, simply pierce the yolk with a toothpick before cooking. Never cook eggs without piercing their shells.

Q. Why is standing time recommended after the cooking operation has been completed?

A. Standing time is very important. With microwave cooking, the heat is in the food, not in the oven. Many foods build-up enough internal heat to allow the cooking process to continue, even after the food is removed from the oven. Standing time for joints of meat, large vegetables and cakes is to allow the inside to cook completely, without overcooking the outside.

Q. Why does my oven not always cook as fast as the microwave cooking guide says?

A. Check your cooking guide again, to make sure you've followed directions exactly; and to see what might cause variations in cooking time. Cooking guide times and heat settings are suggestions, to help prevent over-cooking . . . the most common problem in getting used to a microwave oven. Variations in the size, shape and weights and dimensions could require longer cooking time. Use your own judgement along with the cooking guide suggestions to check whether the food has been properly cooked just as you would do with a conventional cooker.

Q. Why do sparks and crackling (arcing) occur in the oven?

- A. There may be several reasons why sparks and crackling within cavity (arcing) happen.
- You are using dishes with metallic trim (silver or gold).
 - You have left a fork or other metal utensil in the oven.
 - You are using a large amount of metal foil.
 - You are using a metal twist-tie.