



Washing Machine

OWNER'S MANUAL

MODEL : WF-T6800TP
WF-T8800TP

Please read this manual carefully before operating your set.
Retain it for future reference.
Record model name and serial number of the set.
Quote this information to your dealer when you require service.

Product Features



Washer doesn't operate while the lid is open. If the lid is open during the wash, rinse or spin cycles, the operation stops for safety.

Fuzzy logic control

- A built-in load sensor automatically detects the laundry load and a microprocessor optimizes washing conditions such as ideal water level and washing time.



- Advanced technology is built into the Electronic Control System which ensures the best washing result.

Turbo drum washing (option)

- When "Punch + 3" washing wings turn, the washing tub turns in the opposite direction. This makes the both sides current of water which improve wash-performance by rubbing clothes strongly.



※ Applied models : WF-T * * * * *

3 Step washing

- 3 step washing makes the best washing performance with low tangling.



Rubbing



Rubbing and Shaking



Shaking and Disentangling

 : Be sure to remove the unit from the carton base, otherwise the machine will not be able to operate properly.

READ THIS MANUAL

Inside you will find many helpful hints on how to use and maintain your washer properly. Just a little preventive care on your part can save you a great deal of time and money over the life of your washer. You will find many answers to common problems in the Troubleshooting section. If you review our chart of Troubleshooting Tips first, you may not need to call for service at all.

Introduction	Safety Information	4
	Identification of Parts	5
	Function Information	6
Before Starting to Wash	Preparation Before Washing	7
	Use of Water, Detergent, Bleach and Softener	8
	Special Guide for Stain Removal	11
	Function of each Button	12
Washing Programs	Fuzzy Wash (Normal Wash)	14
	Jean Wash	14
	Wool Wash	14
	Speedy Soak Wash	14
	Economy Wash	14
Additional Function Options	Delay Start (Reservation) Wash	16
	Option Washing	17
	Other Useful Functions	18
Installation	Placing and Leveling	19
	Connecting Water Supply Hose	20
	Connecting Drain Hose	23
Care and Maintenance	Grounding Method	24
	Cleaning and Maintenance	25
Troubleshooting	Common washing problems	27
	Troubleshooting	28
Terms of Warranty	Terms of Warranty	29
Specification	Specification	30



WARNING!

Read and follow this safety information carefully.

For your safety, the information in this manual must be followed to minimize the risk of fire or explosion, electric shock, or to prevent property damage, personal injury, or loss of life.

Save these instructions.

<p>WATER HEATER SAFETY</p>	<ul style="list-style-type: none"> • Under certain conditions hydrogen gas may be produced in a water heater that has not been used for two weeks or more. Hydrogen gas can be explosive under these circumstances. If the hot water has not been used for two weeks or more, prevent the possibility of damage or injury by turning on all hot water faucets and allowing them to run for several minutes. Do this before using any electrical appliance which is connected to the hot water system. This simple procedure will allow any built-up hydrogen gas to escape. Since the gas is flammable, do not smoke or use an open flame or appliance during this process.
<p>PROPER INSTALLATION</p>	<ul style="list-style-type: none"> • The base opening must not be obstructed by carpeting when the washing machine is installed on a carpeted floor. • Install or store where it will not be exposed to temperatures below freezing or exposed to the weather. • Properly ground washer to conform with all governing codes and ordinances. Follow details in Installation Instructions. • Must be positioned so that the plug is accessible.
<p>YOUR LAUNDRY AREA</p>	<ul style="list-style-type: none"> • Keep the area underneath and around your appliances free of combustible materials such as lint, paper, rags, chemicals, etc. • Close supervision is necessary if this appliance is used by or near children. Do not allow children to play on, with, or inside this or any other appliance.
<p>WHEN USING THE WASHER</p>	<ul style="list-style-type: none"> • Use this appliance only for its intended purpose as described in this Owner's Manual. • Never reach into washer while it is moving. Wait until the machine has completely stopped before opening the lid. • Do not mix chlorine bleach with ammonia or acids such as vinegar and/or rust remover. Mixing different chemicals can produce a toxic gas which may cause death. • Do not wash or dry articles that have been cleaned in, washed in, soaked in, or spotted with combustible or explosive substances (such as wax, oil, paint, gasoline, dry-cleaning solvents, kerosene, etc.) which may ignite or explode. Do not add these substances to the wash water. Do not use or place these substances around your washer or dryer during operation. • The laundry process can reduce the flame retardancy of fabrics. To avoid such a result, carefully follow the garment manufacturer's wash and care instructions. • To minimize the possibility of electric shock, unplug this appliance from the power supply or disconnect the washer at the household distribution panel by removing the fuse or switching off the circuit breaker before attempting any maintenance or cleaning. <p>NOTE: Pressing Power button to turn off does NOT disconnect the appliance from the power supply.</p> <ul style="list-style-type: none"> • Never attempt to operate this appliance if it is damaged, malfunctioning, partially disassembled, or has missing or broken parts, including a damaged cord or plug.
<p>WHEN NOT IN USE</p>	<ul style="list-style-type: none"> • Turn off water faucets to relieve pressure on hoses and valves and to minimize leakage if a break or rupture should occur. Check the condition of the fill hoses; they may need replacement after 5 years. • Before discarding a washer, or removing it from service, remove the washer lid to prevent children from hiding inside. • Do not attempt to repair or replace any part of this appliance unless specifically recommended in this Owner's Manual, or in published user-repair instructions that you understand and have the skills to carry out. • Do not tamper with controls.

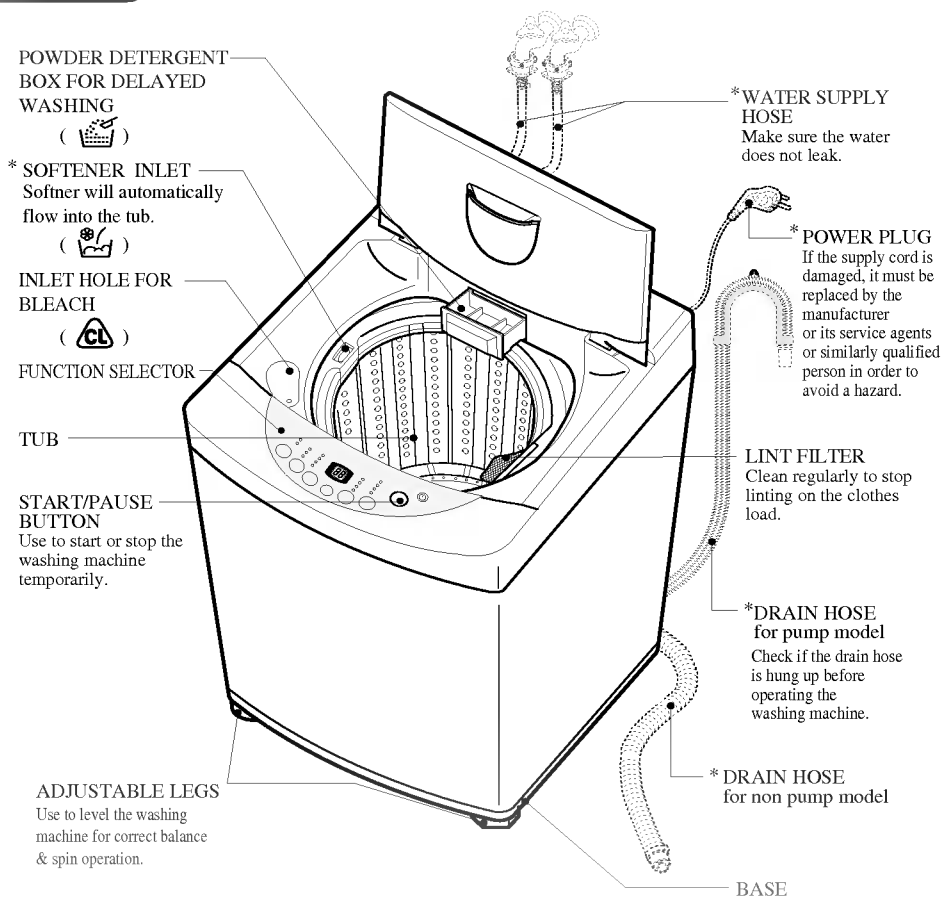

Water supply hoses

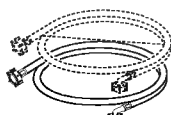

or



1 Each for cold and hot water

Drain hose

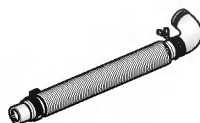

or

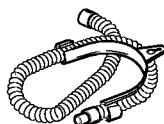

Anti-rat cover (option)

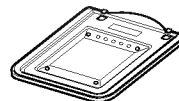

or

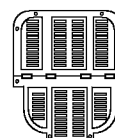

“*” Part can be different according to the model.

Function Information

Our machine provides various washing methods which suits various conditions and types of laundry.

Different types of laundry washing

Use this Program for everyday washing e.g. sheets, towels, T-shirts. *(refer to page14)*

Use this Program for heavily soiled durable garments e.g. overalls, jeans. Thick and heavy clothes or those which are excessively dirty like jeans or working uniforms can be washed. *(refer to page14)*

Delicate clothes (lingerie, wool, etc.) which may be easily damaged can be washed. *(refer to page14)*

The fibers of machine washable woolens have been specifically modified to prevent felting when they are machine washed.

Most handknitted garments are not made of machine washable wool and we recommend that you hand wash them

- Before washing your woolens check the care label for the washing instructions.
- When washing woolens use a mild detergent recommended for washing wool.
- Hand washed woolens may be spun in a washing machine to reduce the time they take to dry.
- To dry woolens lay down them flat on a towel and pat into shape. Dry woolens out of direct sunlight. (The heat and tumble action of a dryer may cause shrinkage or felting of woolen garments.)

Some wool underlays and sheepskin products can be washed in a washing machine but may cause pump blockages. (Ensure that the whole article is suitable for machine washing and not just the backing material.) You may wish to handwash these articles and place them in the machine to spin dry.

Washing according to the condition of laundry

Economy wash can be selected to wash lightly soiled clothes of less than 2.0 kg in a short time. *(refer to page14)*

Speedy Soak Wash is designed to maximize washing performance and can be selected to wash heavily soiled laundry with Fuzzy or Jean Program. *(refer to page14)*

Other washing method

Delay start Wash is used to delay the finishing time of the operation. The number of hours to be delayed can be set by the user accordingly. *(refer to page16)*

One or more wash options can be selected for Fuzzy and Jean washing program. *(refer to page18)*

When the user needs only Spin, Rinse/Spin, Rinse, Wash/Rinse, Wash, Wash/Rinse/Spin, Speedy Soak/Wash/Rinse/Spin. *(refer to page17)*

Preparation Before Washing

* Look for a care label on your clothes. This will tell you about the fabric content of your garment and how it should be washed.

Sort clothes into loads that can be washed with the same wash cycle, water temperature and spin speed.



To get the best results, different fabrics need to be washed in different ways.

- **SOIL** (Heavy, Normal, Light) Separate clothes according to the type and amount of soil.
- **COLOR** (Whites, Lights, Darks) Separate white fabrics from colored fabrics.
- **LINT** (Lint producers, Collectors) Separate lint producers and lint collectors.



Lint Producers
Lint Collectors

Terry cloth, Chenille, Towels, Nappies, Diapers
Synthetics, Corduroy, Permanent Press, Socks

- **Check all pockets to make sure that they are empty.** Things such as nails, hairclips, matches, pens, coins, and keys can damage both your washer and your clothes.
- **Mend any torn garments or loose buttons.** Tears or holes may become larger during washing.
- Remove belts, underwires, etc. to prevent damage to the machine or your clothes.
- **Pretreat any dirt and stains.**
- Make sure the clothes are washable in water.
- Check the washing instructions.
- Remove tissue in pockets.



Pretreatment on stains or heavy soil

- Pretreat shirt collars and cuffs with a pre-wash product or liquid detergent when placing them in the washer. Before washing treat special stains with bar soaps, liquid detergent or a paste of water and granular detergent.
- Use a pretreat soil and stain remover.

Treat stains AS SOON AS POSSIBLE. The longer they are left the harder they are to remove.

(For more detail refer to page 11)

Do not wash fabrics containing flammable materials (waxes, cleaning fluids, etc.).

Load Size

The water level should just cover the clothes. Adjust the load size accordingly. Loosely load clothes no higher than the top row of holes in the washer tub. To add items after washer has started, press Start button and submerge additional items. Close the lid and press Start button again to restart.

Light and Large-sized clothing

Clothes like downs and woollens are light weight, large and float easily. Use a nylon net and wash them in a small amount of water. If the laundry floats during the wash cycle, it may become damaged. Use dissolved detergent to prevent the detergent from clumping.



Long laundry items

Use nylon nets for long, delicate items. For laundry with long strings or long length, a net will prevent tangling during washing. **Fasten zippers, hook, and strings** to make sure that these items don't snag on other clothes.

* Nylon net is not supplied by LG.



Fire Hazard





Never place items in the washer that are dampened with gasoline or other flammable fluids.

No washer can completely remove oil. Do not dry anything that has ever had any type of oil on it (including cooking oils). Doing so can result in death, explosion, or fire.

Use of Water, Detergent, Bleach and Softener

Using Water

- This machine detects the quantity of laundry automatically, then sets the water level and proper amount of detergent.
- When you select a wash program, the water level and amount of detergent (to be used) will be shown on the control panel.
- The following table shows the amount of water.
- When the water level is automatically detected, it may differ depending on the quantity of laundry even though the same water level is indicated on the control panel.
- The amount of a cup in the diagram is about 40g for concentrated detergent.

Water	Detergent
Ex-Large	○ 
Large	○ 
Medium	○ 
Small	○ 

- The machine sets the appropriate temperature automatically according to the wash program .
 - You can change the water temperature by pressing the **WATER TEMP.** button. (*refer to page 12*)
 - The temperature of the water impacts the effectiveness of all laundry additives and therefore, the cleaning results. We recommend temperatures of:
 - HOT 49~60°C...(120-140°F) White items, diapers, underclothing and heavily soiled, colorfast items.
 - WARM 29~40°C...(85-105°F) Most items
 - COLD* 18~24°C...(65-75°F) Only very bright colors with light soil.
 - When washing in cold water additional steps may be needed:
 - Adjust detergent amount and pre-dissolve detergent in warm water
 - Pretreat spots and stains
 - Soak heavily soiled items
 - Use appropriate bleach
- * Temperature below 18°C...(65°F) will not activate laundry additives and may cause lint, residue, poor cleaning, etc. In addition, detergent manufactures and care labels define cold water as 26~29°C...(80-85°F). If the temperature of the water in the tub is too cold for your hands, the detergent will not activate and clean effectively.

If iron is present in the water the clothes may become an all-over yellow or they may be stained with brown or orange spots or streaks. Iron is not always visible. Installation of water softener or an iron filter may be necessary for severe cases.

Using Detergent

Follow the detergent package directions. Using too little detergent is a common cause of laundry problems. Use more detergent if you have hard water, large loads, greasy or oily soils or lower water temperature.

We recommend the use of domestic detergent, (powder, liquid or concentrated). Soap flakes or granulated soap powders should not be used in your washing machine. When washing woolens remember to use detergent suitable for washing woolens.

Using Detergent

When you select a wash program the water level and the amount of detergent (to be used) will be shown on the control panel. The amount of a cup in the diagram is about 40g for concentrated detergent.

The correct amount of detergent will vary depending on the amount of soil in your clothes (Jeans and work clothes may need more detergent, while bath towels usually need less.).

For liquid and concentrated detergents, follow the recommendations of the detergent manufacturer.

Note: To check you are using the correct amount of detergent, lift the lid of your machine about half-way through the wash. There should be a thin layer of foam over the surface of the water. Lots of foam may look good, but it does not contribute to cleaning your clothes. No foam means not enough detergent has been used; soil and lint can settle back on the clothes or the washing machine.

If excess detergent is used, the rinse will not be as clean and efficient. Also, it could cause environmental pollution, so use it accordingly.

Open the detergent dispenser and deposit the appropriate amount of detergent

where you deposit the detergent

Powder Detergent dispenser.

Some detergents **MUST** be fully dissolved before adding to your machine to get the best wash results.

Check the instructions on the detergent packet.

If you use powdered detergent it is essential that the required amount be fully dissolved in very hot water before being added to warm or hot water for the actual wash.

Pre-dissolving detergent in warm water when washing in cold water can improve its performance.

Powder Detergent Box



Where you deposit the detergent

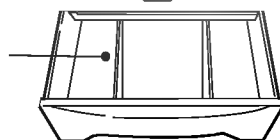

Using Liquid Bleach

- Check clothing care label for special instructions and separate the laundry to be bleached
- Dilute liquid chlorine bleach.
- Measure the recommended amount of liquid bleach carefully following instructions on the bottle.
- Before starting the washer, pour measured amount of bleach directly into bleach dispenser. Avoid splashing or overfilling. Powdered bleach should be mixed with water before pouring.

Bleach dispenser

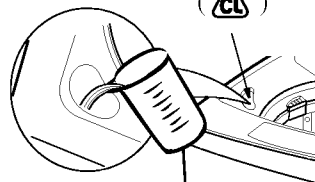

Attention

- Never pour undiluted liquid bleach directly onto clothes or into the wash basket. This may cause change of color or damage the laundry.
- Do not mix chlorine bleach with ammonia or acids such as vinegar and/or rust remover. Mixing can reduce a toxic gas which may cause death.
- Do not pour powdered bleach into bleach dispenser.

Use of Water, Detergent, Bleach and Softener

Using Fabric Softener

- Dilute fabric softener with water.
Undiluted fabric softener may result in spots that look like oil stains.
- Measure and add the recommended amount of fabric softener into the compartment marked with this symbol (☞).
Follow manufacturer's direction.
- ☞ Fabric softener is automatically dispensed in the final rinse with indication beep.
- ☞ If you want extra rinse, **you must add fabric softener manually** when indication beep rings in the final rinse.
This maximize the fabric softener function.
- Do not overfill. The dispenser hold max 35mL.
Never add more than 35mL.
Overfilling can cause early dispensing of the fabric softener which could result in stained clothes. A cup with a pouring spout will help you avoid spilling.
- The effect of adding fabric softener may vary according to its viscosity. The stickier fabric softener makes its effect the lower. For a sticky fabric softener it is recommended that it be diluted with water, then be manually put during the time when the washer beeps several times before the final rinse. This function informing correct time to dispense manually is optionally applied to some models. Please keep it in mind that fabric softener has to be diluted with water before dispensed and never poured directly on clothes.

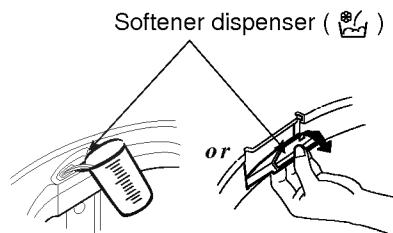

- Do not mix with detergent or bleach.
- Never pour fabric softener directly on clothes. It may stain them.
- Do not stop the washer during the first spin for timely dispensing.
- Option washing is not designed to be used with fabric softener dispenser.

Scrud(Waxy Build up)

Scrud is the name given to the waxy build-up that can occur within any washer when the fabric softener comes into contact with detergent. This build-up is not brought about by a fault in the machine.

If scrud is allowed to build-up in the machine it can result in stains on your clothes or an unpleasant smell in your washer.

If you wish to use fabric softener we recommend

- Using fabric softener sparingly.
- When filling the dispenser, do not splash or overfill.
- Clean dispenser as soon as the cycle is finished.
- Clean your machine regularly. (*refer to page 26*)
- Cold water washing increases the chance of this build-up occurring. We recommend a regular warm or hot wash e.g. every 5th wash should be at least a warm one.
- Fabric softener of thinner consistency is less likely to leave residue on the dispenser and contribute to a build-up.

Special Guide for Stain Removal

- Do not use or mix liquid chlorine bleach with other household chemicals such as toilet cleaners, rust removers, acid or products containing ammonia. These mixtures can produce dangerous fumes which can cause serious injury or death.
- To reduce the risk of fire or serious injury to persons or property, comply with the basic warnings listed below:
 - Read and comply with all instructions on stain removal products.
 - Keep stain removal products in their original labeled containers and out of children's reach.
 - Thoroughly wash any utensil used.
 - Do not combine stain removal products, especially ammonia and chlorine bleach. Dangerous fumes may result.
 - Never wash items which have been previously cleaned in, washed in or spotted with gasoline, dry cleaning solvents or other flammable or explosive substances because they give off vapors that could ignite or explode.
 - Never use highly flammable solvents, such as gasoline, inside the home. Vapors can explode on contact with flames or sparks.

For successful stain removal:

- Remove stains promptly.
- Determine the kind of stain, then follow the recommended treatment in the stain removal chart below.
- To pretreat stains, use a prewash product, liquid detergent, or a paste made from granular detergent and water.
- Use cold water on unknown stains because hot water can set stains.
- Check care label instructions for treatments to avoid on specific fabrics.
- Check for colorfastness by testing stain remover on an inside seam.
- Rinse and wash items after stain removal.



Follow fabric care label instructions

Stain Removal

STAIN	TREATMENT
Adhesive tape, chewing gum, rubber cement	Apply ice. Scrape off excess. Place stain face down on paper towels. Saturate with prewash stain remover or nonflammable dry cleaning fluid.
Baby formula, dairy products, egg	Use product containing enzymes to pretreat or soak stains.
Beverages (coffee, tea, soda, juice, alcoholic beverages)	Pretreat stain. Wash using cold water and bleach safe for fabric.
Blood	Rinse with cold water. Rub with bar soap. Or pretreat or soak with product containing enzymes. Wash using bleach safe for fabric.
Candle wax, crayon	Scrape off surface wax. Place stain face down between paper towels. Press with warm iron until wax is absorbed. Replace paper towels frequently. Treat remaining stain with prewash stain remover or nonflammable dry cleaning fluid. Hand wash to remove solvent. Wash using bleach safe for fabric.
Chocolate	Pretreat or soak in warm water using product containing enzymes. Wash using bleach safe for fabric.
Collar or cuff soil, cosmetics	Pretreat with prewash stain remover or rub with bar soap.
Dye transfer on white fabric	Use packaged color remover. Wash using bleach safe for fabric.
Grass	Pretreat or soak in warm water using product containing enzymes. Wash using bleach safe for fabric.
Grease, oil, tar (butter, fats, salad dressing, cooking oils, car grease, motor oils)	Scrape residue from fabric. Pretreat. Wash using hottest water safe for fabric. For heavy stains and tar, apply nonflammable dry cleaning fluid to back of stain. Replace towels under stain frequently. Rinse thoroughly. Wash using hottest water safe for fabric.
Ink	Some inks may be impossible to remove. Washing may set some inks. Use prewash stain remover, denatured alcohol or nonflammable dry cleaning fluid.
Mildew, scorch	Wash with chlorine bleach if safe for fabric. Or, soak in oxygen bleach and hot water before washing. Badly mildewed fabrics may be permanently damaged.
Mud	Brush off dry mud. Pretreat or soak with product containing enzymes.
Mustard, tomato	Pretreat with prewash stain remover. Wash using bleach safe for fabric.
Nail polish	May be impossible to remove. Place stain face down on paper towels. Apply nail polish remover to back of stain. Repeat, replacing paper towels frequently. Do not use on acetate fabrics.
Paint, varnish	WATER BASED : Rinse fabric in cool water while stain is wet. Wash. Once paint is dry, it cannot be removed, OIL BASED AND VARNISH : Use solvent recommended on can label. Rinse thoroughly before washing.
Rust, brown or yellow discoloration	For spots, use rust remover safe for fabric. For discoloration of an entire load, use phosphate detergent and nonchlorine bleach. Do not use chlorine bleach because it may intensify discoloration.
Shoe polish	LIQUID : Pretreat with a paste of granular detergent and water. PASTE : Scrape residue from fabric. Pretreat with prewash stain remover or nonflammable dry cleaning fluid. Rub detergent into dampened area. Wash using bleach safe for fabric.

Water temperature button (option)

- Use to select water temperature.
Pressing the button allows you to select Cold ► Warm (Hot&Cold) ► Hot ► Cold respectively. Default setting is Cold.

Water level button (indication of detergent amount)

- Use to adjust the water level as required. The appropriate amount of detergent is shown next to the water level in the Water-Detergent diagram
- Water level is automatically selected for fuzzy (normal) program.
The following settings are indicated as the button is pushed Large ► Ex-Large ► Small ► Medium ► Large

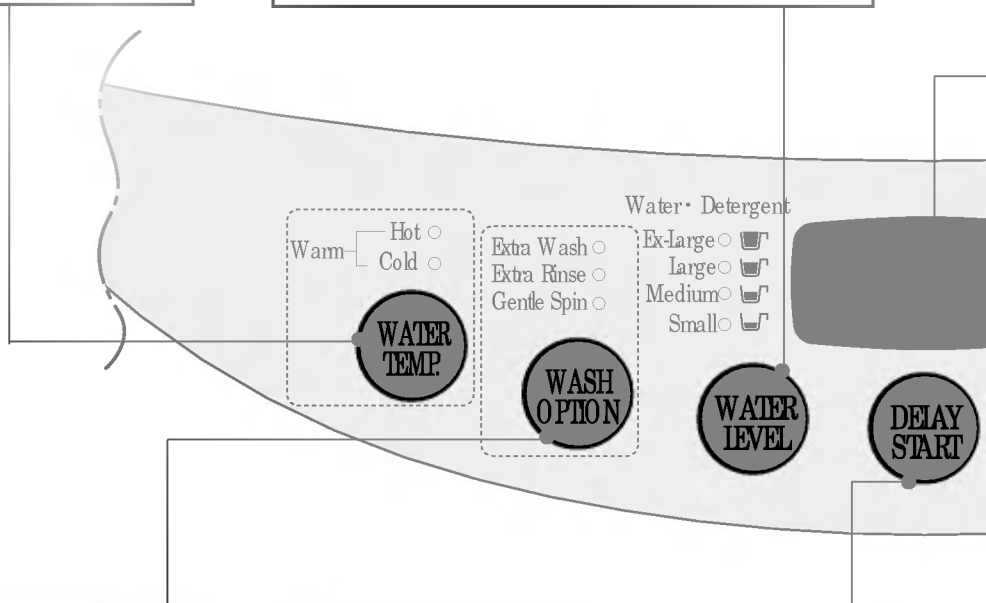

Wash option button(option)

- According to kinds of laundry, soiled extent or washing habit you can select suitable wash option manually.
- By pressing the button wash option is changed.

(refer to page 18)

Delay Start (Reservation) button

- Use to set a delayed finishing time.
- The time increases when the button is pushed.
- The following settings are indicated as the button is pushed 3 ► 4 ► 5 ► ...11 ► 12 ► 14 ► 16 ► ...46 ► 48 ► 3 HOUR.
- To cancel delay time, turn the power switch off.

(refer to page 16)

Time left, Delay Start (Reservation), Alarm indication

- **Time left** - During operation, the remaining time is indicated.
- **Delay Start indication (Reservation)** - When delay start (reservation) program is selected, it indicates the finishing time. (RES.=DELAY)
- **Alarm indication** -When an error occurs, an error message appears to indicate the abnormality. For example, **dE** indicates that the lid is open.

Start/ Pause button

- Use to start or pause the washing process.
- Repeats start and pause by pushing the button.
- The power goes off automatically 10 minutes after stopping.

AUTO OFF (Power) button

- Use to turn the power on or off.
- Push again and power goes on or off
- The power goes off automatically about 10 seconds after the wash is finished.

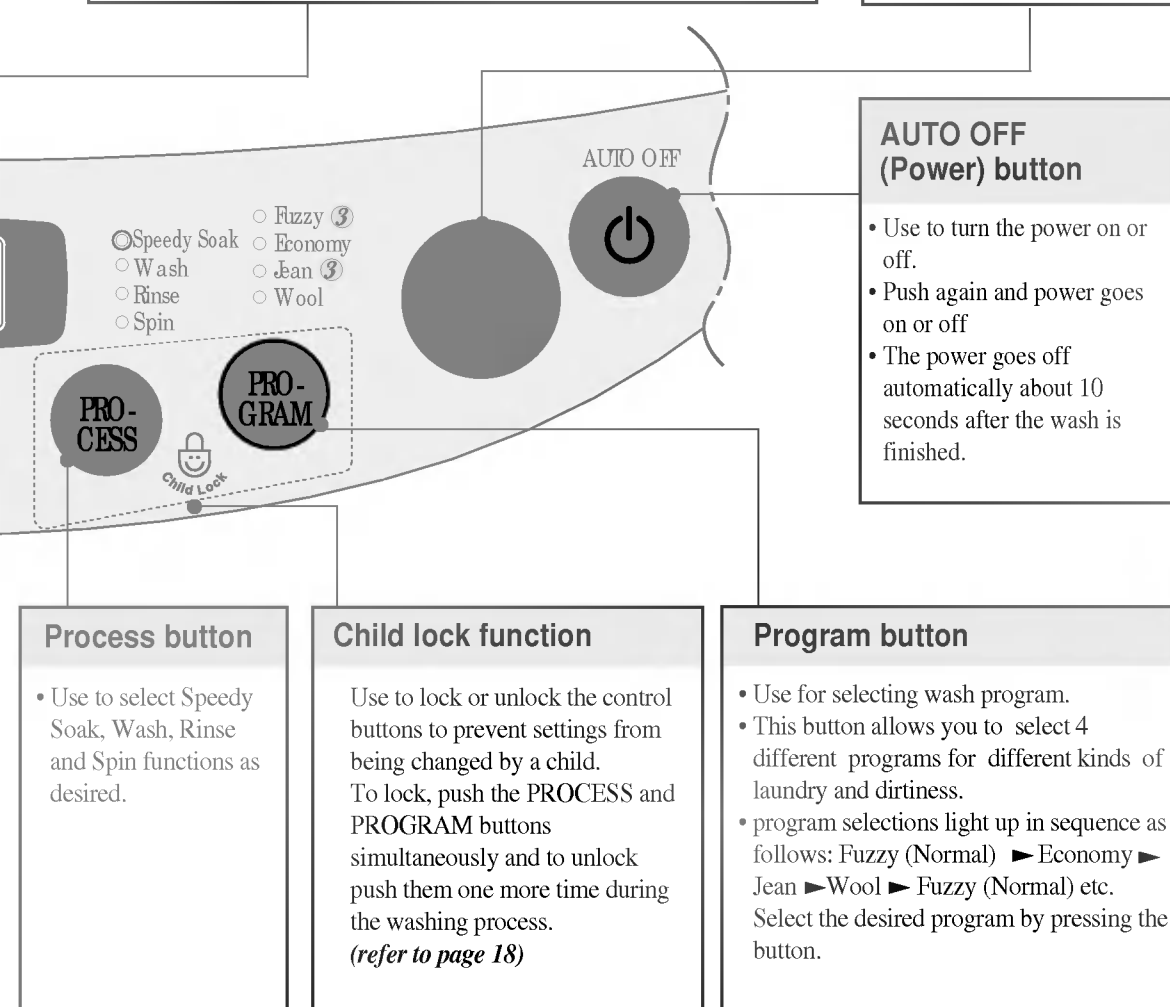

Process button

- Use to select Speedy Soak, Wash, Rinse and Spin functions as desired.



























Child lock function

















Use to lock or unlock the control buttons to prevent settings from being changed by a child. To lock, push the PROCESS and PROGRAM buttons simultaneously and to unlock push them one more time during the washing process.
(refer to page 18)

Program button

- Use for selecting wash program.
- This button allows you to select 4 different programs for different kinds of laundry and dirtiness.
- program selections light up in sequence as follows: Fuzzy (Normal) ► Economy ► Jean ► Wool ► Fuzzy (Normal) etc. Select the desired program by pressing the button.

※ ③ : 3 step works at large and medium water level of Fuzzy and Jean program.

Washing Programs	 <small>AUTO OFF</small>	Add the laundry			Add the detergent
Fuzzy Washing (Normal Wash) Used for normal loads, this mode automatically selects the most appropriate conditions and completes the sequence in one operation. The built-in sensor detects the size of the load and the ideal wash power and wash, rinse and spin times are set accordingly.					 <ul style="list-style-type: none"> Add the appropriate quantity of detergent as indicated by the water level next to Water Detergent. Or follow the detergent manufacturer's instructions
Economy Wash Use this mode when washing lightly soiled clothes for a short time. The highly recommended laundry amount is under 2.0kg.			 <ul style="list-style-type: none"> Select the Economy program on the Control panel. 		 <ul style="list-style-type: none"> Add the appropriate quantity of detergent as indicated by the water level next to Water Detergent. Or follow the detergent manufacturer's instructions
Jeon Wash Use Jeon program when washing Jeans of different sizes		 <ul style="list-style-type: none"> Spread the jeon evenly in the tub 	 <ul style="list-style-type: none"> Select the Jeon program on the Control panel. 		
Wool Wash Use this program for washing delicate fabrics such as lingerie and woollens (wash only "water washable" clothes) Before washing your woollens check the care label for the washing instructions (wash only water washable clothes)			 <ul style="list-style-type: none"> Select the Wool program on the Control panel. 		 <ul style="list-style-type: none"> Use neutral detergent appropriate for the laundry. When washing woollens use a mild detergent recommended for washing wool.
Speedy Soak Wash Use this mode to wash normal clothes or thick and heavy clothes which are excessively dirty. Speedy Soak mode can be used with Fuzzy or Jeon program.			 <ul style="list-style-type: none"> Speedy Soak will not work in Wool & Economy Program. 		
<ul style="list-style-type: none"> Keep pressing the PRO-CESS button until the Speedy Soak light is on and then Wash, Rinse, Spin lights are on simultaneously. Until the washing process is completed, the Speedy Soak light is on. <div style="float: right; border: 1px solid black; padding: 5px;">  Speedy Soak  Wash  Rinse  Spin </div>					

	Close the lid	Finish	Caution & Note
 <ul style="list-style-type: none"> · The pulsator rotates for 8 seconds to detect the laundry load. · Then the water level and the amount of detergent to be used will be shown and water will be supplied. 	 <ul style="list-style-type: none"> · Water will be supplied for 2 minutes after the start of the wash to supplement the water the laundry has absorbed. 	 <ul style="list-style-type: none"> · When the wash program ends, the buzzer will ring for 10 seconds before the Power goes off automatically. 	<ul style="list-style-type: none"> · If water is already in the tub, or putting wet laundry into the tub before starting will increase the water level. · With lightweight bulky loads, water level can be set low. · Changes to water temperature (hot/cold) and wash level are possible during operation. (<i>refer to page 12</i>)
			
			
			<ul style="list-style-type: none"> · When setting the water level manually, do not set to Medium to prevent damage to laundry. · Washing with hot water may damage the laundry (Water is set to cold automatically). Ensure that the load is under 2kg · In order to avoid damage to laundry, the spin cycle may appear slow. This also avoids wrinkles and clothing may still contain some water. This is normal. · Speedy Soak Wash cannot be selected for the Wool Wash program.
 <ul style="list-style-type: none"> · The water level and the amount of detergent to be used will be shown and water will be supplied. 			<ul style="list-style-type: none"> · If wool wash is selected, Gentle Spin will be set automatically.

Delay Start (Reservation) Wash

Delay Start (Reservation) Wash is used to delay the finishing time of the operation. The hours to be delayed can be set by the user accordingly. The time on the display is the finishing time, not the start time.

Press the **POWER** button to turn power on.



Press the **PROGRAM** button to select the washing program.



- Select the program for laundry on the Control panel. This program will not work in Wool Program.

Press the **DELAY START (Reservation)** button to set the time when the delayed washing is to be completed.



• **How to set the delay time.**

Example : It's 7 a.m. now. If you'd like your wash to finish at 9 p.m. set the time as in the figure below.

When you push the button the reservation time changes [3 E 4 E 5 E ...12 E 14 E 16 E ...E 48 E 3] repeatedly.



(RES=DELAY)

Add the detergent.

- The appropriate quantity of detergent marked next to the water level of Water•Detergent.
- When the lid is open the machine will not operate, and an alarm signal will remind you to close the lid

Add the laundry and press the **START/PAUSE** button.



- When you press the START/PAUSE button the light will blink.

Close the lid.

- Water will be supplied for 2 minutes after the start of the wash to supplement the water the laundry has absorbed.

Finish

The washing will be finished according to the delayed time.

Note

- If the lid is open, the machine will not work, and an alarm signal will alarm to remind you to close the lid.
- To select washing program, spinning time, water level or hot/cold manually, press the DELAY START (RESERVATION) button and select the desired option. Then press the START/PAUSE button.
- When the laundry cannot be taken out immediately after the wash program ends, it is better to omit the spinning program. (The laundry will be wrinkled if left for a long time after spinning.)

When you only need the Wash, Wash/Rinse or Rinse cycles, these can be set manually

Press the **AUTO OFF** (Power) button to turn power on.



『Wash』, 『Wash+Rinse』, 『Rinse』, 『Rinse+Spin』, 『Spin』 only options



- Press the **PROCESS** button until above Option Washing light is on. (refer to p13)
- When you want to only drain, wait until the water in the washing tub drains completely and then, turn off the power.

Press the **WATER LEVEL** button, to control the water level according to the amount of laundry. If you do not choose anything, it is set the Large water level automatically. *(refer to page 12)*



Add the laundry into the washing tub.

Press the **START/PAUSE** button.



Add the detergent and close the lid.

- When a **Wash, Wash/Rinse** or **Rinse** only option is selected, the water will not be drained off after the wash is completed.
- **If you do not specify the water level**, then Medium will be automatically selected.
- If only Rinse is selected, the process will start from Water Supply.

Child Lock Function

If you want to lock all the keys to prevent settings from being changed by a child, you can use the child lock option.



Press the **POWER** button.



- Turn Power on.

Press the **START/PAUSE** button to start washing.



- After all washing conditions are set according to the manual.

Press both the **PROCESS** button and the **PROGRAM** button simultaneously.



- During the wash program, all the buttons are locked until washing is completed or until the child-lock function is deactivated manually.
- “**CL**” and the remaining time will be displayed alternately in child-lock mode.



If you want to unlock during wash, press both the **PROCESS** and the **PROGRAM** button simultaneously again.

Wash Option (option)

One or more wash options can be selected for Fuzzy and Jean washing program. Wash program is changed as follows according to selected wash options.

- **Extra Wash**: Gives additional 3 min wash
- **Extra Rinse** : Gives additional one deep rinse
eg.) If you want extra rinse, **you must add fabric softener manually** when indication beep rings in the final rinse. This maximize the fabric softener function.
- **Gentle Spin** : Gives gentle spin instead of normal spin.

Mute Option

If you want to use the washing machine without alarm signal sounds, press both the **WATER LEVEL** and **PROCESS** buttons simultaneously.

To make buzzer work, press both the **WATER LEVEL** and **PROCESS** buttons simultaneously one more time.

Please ensure that transit restraint has been removed before operating your machine.

Place the machine on a flat and firm surface which allows proper clearance.

We suggest a minimum clearance of 2 cm to the right side and left sides of the machine for ease of installation.

At the rear, a minimum clearance of 10 cm is suggested.

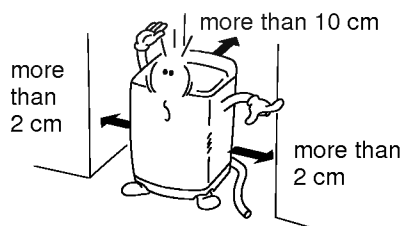

If the washer is installed on a uneven, weak or tilted floor causing excessive vibration, spin failure or “**UE**” error can happen to it. It must be placed on a firm and level floor to prevent spin failure.

Check that the machine is level

Open the lid and look from above to see if it is same as shown.

Top view of the machine

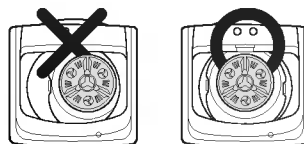

Leveling the machine

Lift the front of the washing machine and twist the Adjustable Leg until the washing machine is placed evenly.

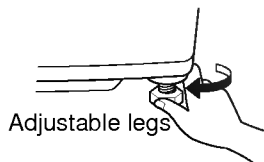

※ Installing the Anti-Rat Cover (option) Insert the anti-rat cover to be firmly fixed from the back or front of washing machine and screw it (1pcs)

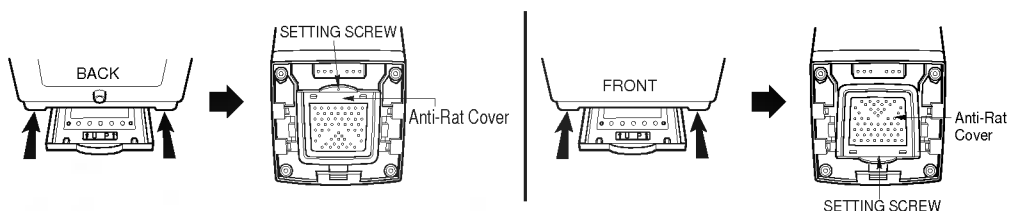

If the power is supplied from a cord extension set or generator, the cord extension set or electrical portable outlet device should be positioned so that it is not exposed to splashing or ingress of moisture.

Connecting Water Supply Hose

Before connecting the Water Supply Hose to the water tap, check the hose type and then choose the correct instruction here under.

Note that the Water Supply Hose supplied may vary from country to country, Make sure to connect the blue inlet hose to the cold water tap, and the orange inlet hose to the hot water tap.

Connecting Water Supply Hose to water tap

 (Normal tap without thread & screw type inlet hose.)

Untighten the screw

Untighten the screw of the connector so that the tap can be placed in the middle.

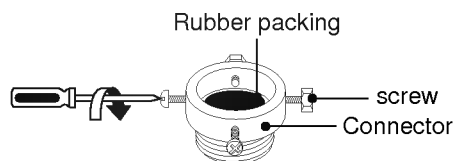

Fixing the connector to the tap

Push the upper connector up till the rubber packing is in tight contact with the tap. Then tighten the 4 screws.

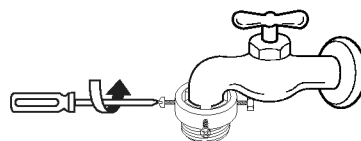

Attach the water supply hose securely to the connector

Push the water supply hose vertically upwards so that the rubber seal within the hose can adhere completely to the tap.

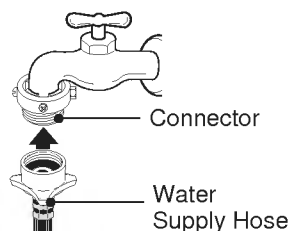

Fixing the connector to the water supply hose

Attach the water supply hose to the connector and then tighten it by screwing it to the right.

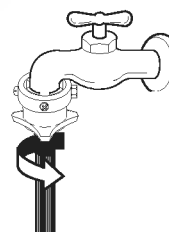

Check the connection of water supply hose and the connector

After connecting the hose, open the tap to check for any water leakage.

If the water leaks, close the tap and start again from step 1

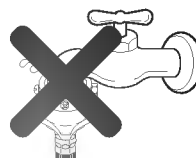

The washing machine is to be connected to the water mains using new hose-sets and old hose-sets should not be reused.

(Normal tap without thread & one touch type inlet hose.)

Separate Middle connector from Water Supply Hose

Separate Middle connector from the Water Supply Hose by pulling the Pressing Rod and the Pressing Handle that is attached to the Water Supply Hose.

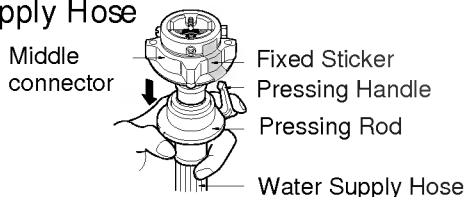

Loosen the fixed nuts to connect the connector to the tap

Untighten the screw of the connector so that the tap can be placed in the middle.

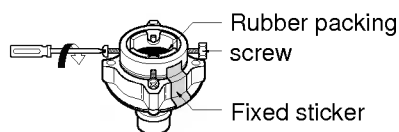

In case tap is too large.

If the tap diameter is too large or is square, untighten the 4 screws and remove the guide plate. Then follow step 1.

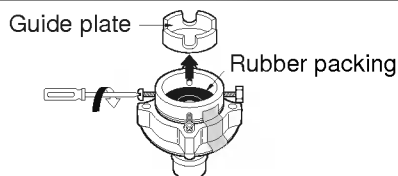

Fixing Connectors to the Tap

Push the upper connector up till the rubber packing is in tight contact with the tap. Then tighten the 4 screws.

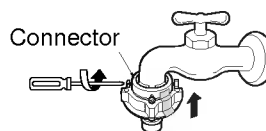

Fixing Upper Connector and Middle Connector

Remove the fixed sticker in between the Upper and Middle Connectors. Tighten the connectors by holding one connector and twist middle connector to the right.

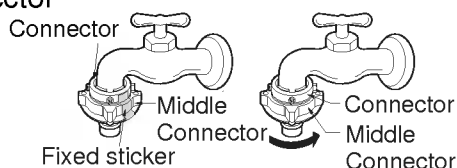

Connecting Middle Connector and Water Supply Hose

Press down the pressing rod of the Water Supply Hose which was separated from middle connector (refer to Step 1) and then join it to the middle connector.

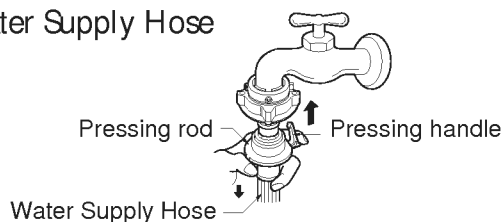

Check for water leakage

After connecting the hose, open the tap to check for any water leakage.

If the connection leaks, close the tap and start again from step 1.

If you skip step 1, water leakage may occur.

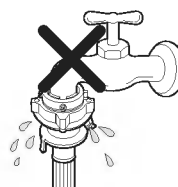

Connecting Water Supply Hose

Attach the water supply hose to the tap.

Push the water supply hose up so that the rubber packing within the hose can adhere completely to the tap.

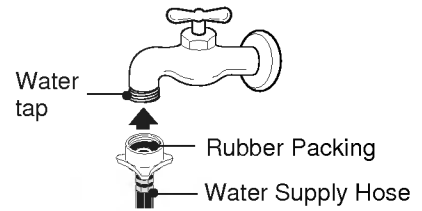

Connect the water supply hose to the tap.

Connect the water supply hose to the tap and then tighten it by screwing it to the right.

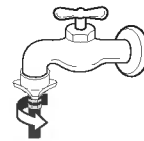

Check water leakage.

After connecting the hose, open the tap to check for any water leakage.

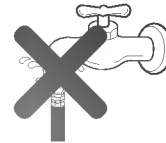

Connecting Water Supply Hose to the machine

- Connect the water supply hose to inlet valve of the washing machine, and then lock it by turning the hose connecting part.
- Check to see if there is a rubber seal inside the connector.

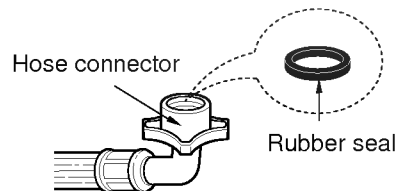
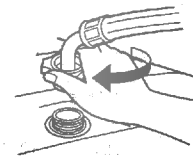

Before connecting Drain Hose, check your Drain Hose model and choose the correct instructions.

Fit the end of the drain hose to the outlet of the drain pump and tighten the clamp.

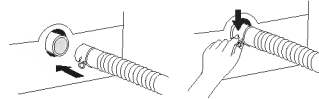

Put the other end of the drain hose over the standpipe or wash tub.

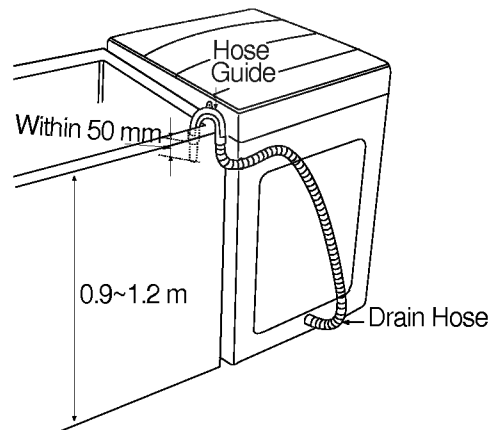

Note

- To prevent siphoning, the drain hose should not extend more than 50 mm from the end of the hose guide.
- The discharge height should be approximately 0.9 ~ 1.2 m from the floor.

Before connecting

Ensure that the hose clip is set as indicated here.

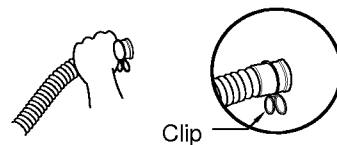

Connect the Elbow Hose

Push the elbow hose toward the body of the washing machine.



Place the Drain Hose

To change the direction of the hose, pull out the elbow hose and change the direction.
Repeat Step 2.

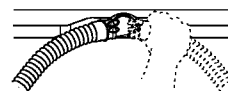

Earth wire should be connected.

If the earth wire is not connected, there is possible a danger of electric shock caused by the current leakage .

Grounding Method with Ground insert space Terminal

If the AC current outlet has a ground terminal, then separate grounding is not required. Note that AC power outlet configurations may differ from country to country

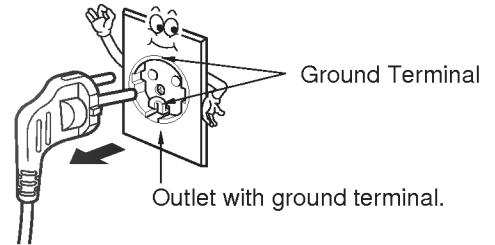

Other Grounding Method

Connect the Ground Wire to a Ground Copper Plate and bury it more than 75cm in the ground.

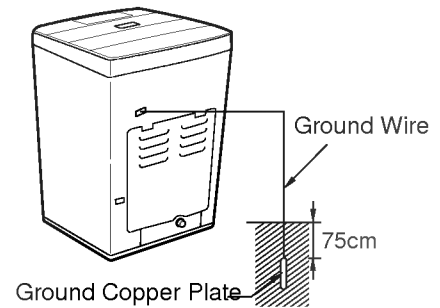

Connect the ground Wire to the socket provided exclusively for Grounding.

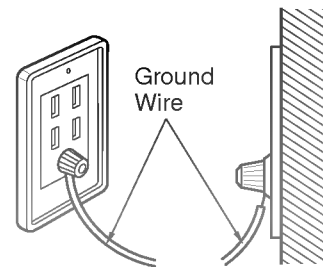

Using a Short Circuit Breaker

If grounding methods described above are not possible, a separate circuit breaker should be employed and installed by a qualified electrician

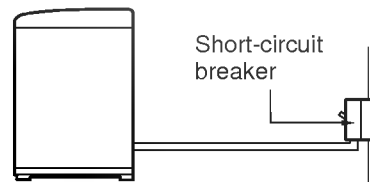

- To prevent a possible explosion, do not connect ground to a gas pipe
- Do not connect ground to telephone wires or lightning rods. This may be dangerous during electrical storms
- Connecting ground to plastic has no effect
- Ground wires should be connected when an extension cord is used.

Cleaning and Maintenance

- If you always use cold water, we recommend that a warm or hot wash be used at a regular intervals e.g. every 5th wash should be at least a warm one

- Turn off taps to prevent the chance of flooding should a hose burst.
- Always unplug the power cord after use.

When water supply into the tub is not clean or the filter is clogged with particles (such as sand), clean the filter in the inlet valve occasionally.

(The figure of power cord and water tap may vary according to the country)

To Clean the Filter in the Inlet Valve

Close the tap before turning off the power. Select both hot/cold and then press the [START/PAUSE] button to remove water from the machine completely.



Turn off the power before pulling out the cord.

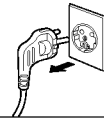

After removing the water supply hose pull out the filter. Then use a brush to clean the filter.

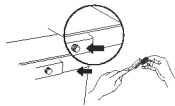

Replace the filter after cleaning it.

- Before cleaning the filter, the impurities in the water supply hose should be removed.

To Clean the Lint Filter

Pull out the lint filter from the tub in the direction shown below.



Turn the net inside out to clean the filter and rinse it with water.



Replace- the filter to the original location. Push the lip of the filter until a pop sound is heard.



Note

- If the lint filter is torn or damaged, purchase a new one from LG service center.

To Clean the Pump casing (for pump model)

Place a towel on the floor under the drain pump cap. Excess water may flow out.

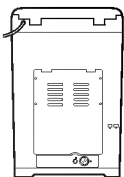

Turn the cap counter-clockwise and pull it out.

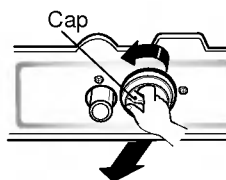

Remove any foreign objects and fluff inside pump casing and from the filter.

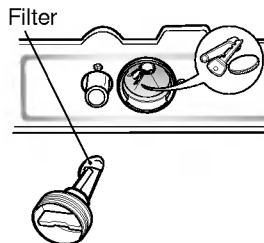

Replace the cap. Insert the filter along the guide ribs inside the pump casing. Filter must face the guide ribs inside pump casing and securely turn the cap clockwise.

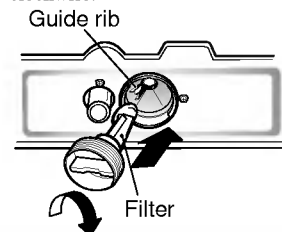

- Check if water leaks after reassembling. (The Rubber ring is in the cap)

Cleaning and Maintenance

When there is a fear of freezing

- Close the water taps and remove the Water Supply Hose.
- Remove the water which remains in the water supply.
- Lower the drain hose and drain the water in the bowl and the drain hose by spinning.

- Remove the water supply hose, and immerse it in hot water at approx.. 40°C.
- Pour approx.. 2 liters of hot water at approx.. 40°C, into the bowl and let it stand for 10 minutes.
- Connect the water supply hose to the water tap and confirm that the washing machine performs the supply and drainage of water.

Wash Inner-tub Leave the lid open after washing to allow moisture to evaporate. If you want to clean the inner-tub use a clean soft cloth dampened with liquid detergent, then rinse. (Do not use harsh or gritty cleaners.)

Inlet Hoses Hoses connecting washer to faucet should be replaced every 5 years.
Exterior Immediately wipe off any spills. Wipe with damp cloth. Try not to hit surface with sharp objects.

Long Vacations Be sure water supply is shut off at faucets. Drain all water from hoses if weather will be below freezing.

Cleaning the Inside of your Washer

If you use fabric softener or do regular cold water washing, it is very important that you occasionally clean the inside of your washer.

- Fill your washer with hot water.
- Add about two cups of a powdered detergent that contains phosphate.
- Let it operate for several minutes.
- Stop the washer, open the lid and leave it to soak overnight.
- After soaking, drain the washer and run it through a normal cycle.

We do not recommend that you wash clothes during this procedure.

Products that might damage your washing machine

- Concentrated bleaches and diaper sanitizer will cause damage to the paintwork and components of your washer.
- Hydrocarbon solvents i.e. petrol, paint thinners and lacquer thinners, etc. can dissolve plastic and blister paint (Be careful when washing garments stained with these solvents as they are flammable DO NOT put them in washer or dryer.)
- Some pretreatment sprays or liquids can damage your washer's control panel.
- Use of dyes in your washer may cause staining of the plastic components. The dye will not damage the machine but we suggest you thoroughly clean your washer afterwards. We do not recommend the use of dye strippers in your washer.
- Do not use your washer lid as a work surface.







Common washing problems

Many washing problems involve poor soil & stain removal, residues of lint and scum, and fabric damage. For satisfactory washing results, follow these instructions.

WASH PROBLEM

Problems	Possible Causes	Solutions & Preventive Measures
Poor soil removal	<ul style="list-style-type: none"> • Not enough detergent • Wash water temperature too low. • Overloading the washer • Incorrect wash cycle • Incorrect sorting • Do not pretreat stain 	<ul style="list-style-type: none"> • Use correct amount of detergent for load size, amount of soil and water hardness. • Use warm or hot water for normal soil. Different water temperature may be required according to soil type. (<i>refer to page 8</i>) • Reduce load size. • Wash with Jean or Speedy Soak & Jean wash cycle for heavy soiled laundry. • Separate heavily soiled items from lightly soiled ones. • Pretreat stain and heavy soil according to directions shown on page 7.
Blue Stains	<ul style="list-style-type: none"> • Undiluted fabric softener dispensed directly onto fabric 	<ul style="list-style-type: none"> • Rub the stain with bar soap. Wash. • Do not overfill fabric softener dispenser and do not pour liquid fabric softener directly onto fabric. See page 10 for more instructions.
Black or gray marks on clothes	<ul style="list-style-type: none"> • A buildup caused by the interaction of fabric softener and detergent can flake off and mark clothes • Not enough detergent 	<ul style="list-style-type: none"> • Keep the recommendations against Scrud(waxy buildup). (<i>refer to scrud page 10.</i>) • Use correct amount of detergent for load size, amount of soil and water hardness.
Yellow or brown rust stains	<ul style="list-style-type: none"> • Iron or manganese in water supply, water pipes, or water heater 	<ul style="list-style-type: none"> • To restore discolored load of whites, use rust remover safe for fabric. • Install nonprecipitating water softener or an iron filter in your water supply system for an ongoing problem. • Before washing, run water for a few minutes to clear lines.
Lint	<ul style="list-style-type: none"> • Incorrect sorting • Tissues left in pocket • Overloading the washer 	<ul style="list-style-type: none"> • Wash lint givers eg towels, flannelette sheets, separately from lint collectors eg synthetic fabrics and remove tissues in pockets before wash. See page 7 for sorting and caring before loading. • Do not overload the washer
Residue or detergent	<ul style="list-style-type: none"> • Overloading the washer • Undissolved detergent • Use too much detergent 	<ul style="list-style-type: none"> • Do not overload the washer. • Some detergents need to be pre-dissolved, check the detergent instructions. Try pre-dissolving the detergent. • Increase water temperature using hot water safe for fabric. • Use proper amount of detergent.
Holes, tears, or snags	<ul style="list-style-type: none"> • Incorrect use of chlorine bleach. • Unfastened zippers, hooks, buckles • Ribs, tears and broken threads • Overloading the washer • Degradation of fabric 	<ul style="list-style-type: none"> • Never pour chlorine bleach directly on fabric. See page 9 for adding liquid bleach. • Fasten zippers, hooks, and buckles. • Remove objects in pockets. See page 7 for caring before loading. • Do not overload the washer.

Before calling for service, check the problem against the list bellows.

Symptom	Error Message	Check up
Water Supply Failure		<ul style="list-style-type: none"> • Is the water tap shut off? • Is the water supply cut off ? • Is the tap or water supply hose frozen ? • Is the water pressure low or is the filter of the inlet valve clogged with impurities? • Is the Hot hose connected to cold? • Is the Cold hose connected to Hot?
Drainage Failure		<ul style="list-style-type: none"> • Is the drain hose positioned correctly? • Is the drain hose bent or placed too high? • Is the internal part of the hose or drain pump (only pump model) clogged with impurities? • Check if electric power has gone off.
Spin Failure		<ul style="list-style-type: none"> • Is the laundry evenly balanced? • Is the washing machine placed on a flat surface?
Door(Lid) Open		<ul style="list-style-type: none"> • Is the lid closed?
Internal sensing failure		<ul style="list-style-type: none"> • Please call your nearest LG Electronics service center for help.
Power failure		
Overflow failure		

Terms of Warranty

What Is Not Covered:

- Service trips to your home to teach you how to use the product.
- If the product is connected to any voltage other than that shown on the rating plate.
- If the fault is caused by accident, neglect, misuse or Act of God.
- If the fault is caused by factors other than normal domestic use or use in accordance with the owner's manual.
- Provide instruction on use of product or change the set-up of the product.
- If the fault is caused by pests for example, rats or cockroaches etc..
- Noise or vibration that is considered normal for example water drain sound, spin sound, or warning beeps.
- Correcting the installation for example, levelling the product, adjustment of drain.
- Normal maintenance which recommended by the owner's manual.
- Removal of foreign objects / substances from the machine, including the pump and inlet hose filter for example, grit, nails, bra wires, buttons etc.
- Replace fuses in or correct house wiring or correct house plumbing.
- Correction of unauthorized repairs.
- Incidental or consequential damage to personal property caused by possible defects with this appliance.
- If this product is used for commercial purpose, it is not warranted.
(Example : Public places such as public bathroom, lodging house, training center, dormitory)

If the product is installed outside the normal service area, any cost of transportation involved in the repair of the product, or the replacement of a defective part, shall be borne by the owner.

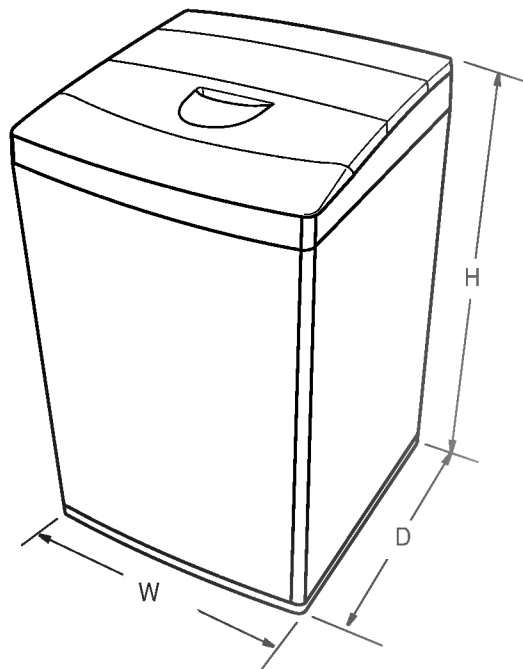

Model	WF-T6800TP
	WF-T8800TP
Size	540(W) x 540(D) x 850(H) WF-T6800TP
	590(W) x 606(D) x 958(H) WF-T8800TP
Water tap pressure	30 - 800 kPa (0.3 - 8.0 kgf/cm ²)

※ In our continuing effort to improve the quality of our appliances, it may be necessary to make changes to the appliance without revising this manual.