



**NICAM/Hi-Fi STEREO
Video Cassette Recorder**

OWNER'S MANUAL

MODEL: LV2775



**Before connecting, operating or adjusting this product,
please read this instruction booklet carefully and completely.**

**Model No. EC971EP
Part No. 3834RP0083B**

Precaution & features Information



Position your VCR so that no bright light or sunlight falls directly onto it.

Care should be taken not to expose your VCR to any unnecessary vibration, moisture, dust or heat.

During electrical storms it is advisable to unplug both the aerial cable and mains plug to prevent accidental damage to your VCR and TV.

Do not operate your VCR if it is damaged. Your VCR should not be repaired by anyone except qualified service personnel.

Never remove the back cover of your VCR as this can expose you to very high voltage and other hazards. If your VCR does not operate properly, please check the Troubleshooting Check List (see p. 32). If your VCR still does not operate properly, unplug it and call your dealer.

The apparatus shall not be exposed to dripping or splashing and that no objects filled with liquids, such as vases, shall be placed on the apparatus.

 This product is manufactured to comply with the radio interference requirements of EEC DIRECTIVE 89/336/EEC, 93/68/EEC and 73/23/EEC.

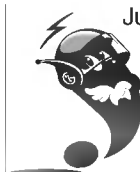

Just to name a few examples of the extraordinary features:

- ez (easy) operations (see p. 29)
- Programmable 88 channel memory with Frequency synthesised tuner
- ACMS (Automatic Channel Memory System)
- 7 event/1 month programmable timer
- Recording and playback for 16:9 Wide-screen format
- LP - Long Play - recording & playback
- Shuttle Controls
- Energy Saving function
- ICON OSD (On Screen Display)
- NTSC playback on PAL TV
- Logic & Picture Search
- Child Lock
- Auto Power on and Play
- Fine still, Frame advance & Fixed Slow functions
- Real Time Counter
- Quick Start function
- Auto Tracking System
- Digital Stereo decoder for reception of NICAM Stereo, Bilingual & Mono sound
- Hi-Fi Audio System
- Simulcast Recording



Welcome to LG

Thank you for buying this LG video cassette recorder Model LV2775.

Description	2 - 5	Advanced Operations	22 - 29
Precaution & Features information	2	Timer Recording Using On Screen Display	22 - 23
Remote Control Location & functions	4	Energy Saving	24
Your VCR's Controls	5	On Screen Display	24
Setting Up	6 - 15	Tape Counter Memory Stop	25
Connecting to your TV & Decoder (or Satellite)	6	Child Lock	25
Connecting to a Hi-Fi & Camcorder	7	Wide Screen Compatibility (16:9)	26
Tuning in a video channel on your TV	8 - 9	Memory Shut-Off	27
How to Using the main menu	10	Self-Diagnosis	27
Tuning in TV Stations Automatically	11	Hi-Fi Stereo Sound System	28
Tuning in TV Stations Manually	12 - 13	ez (easy) operations	29
Changing the order of TV Stations	14	Helpful Hints	30 - 32
Deleting TV Stations	15	Controlling the TV	30
Basic Operations	16 - 21	Tape Copying	31
Playback a tape	16 - 17	Specifications	31
Recording TV programmes	18 - 19	Troubleshooting Check List	32
To set the Colour System	20		
To set the Decoder	20		
Setting the Clock Manually	21		

Table of Contents

Remote Control Location & functions

To install batteries:

Your REMOTE CONTROL HANDSET is powered by two AAA type batteries.

1. To insert them, push the tab backwards and lift off the cover of the handset.
2. Put the two batteries into the compartment making sure the + and - are correctly positioned.
3. Replace the cover.

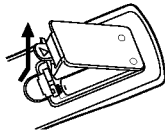

Your video recorder (VCR) is designed so that almost all of its features can be controlled from the REMOTE CONTROL HANDSET. Some features can also be controlled from the FRONT PANEL of the video recorder. The maximum operating distance that you may control your video recorder is about 7.5 metres (25 feet). It must also be within an angle of 30 degrees either side of the REMOTE SENSOR on the front of your video recorder.

To avoid damage from possible battery leakage, remove the batteries if you do not plan to use the remote control handset for an extended period of time. Do not use batteries of differing age or type. Always discard batteries safely.

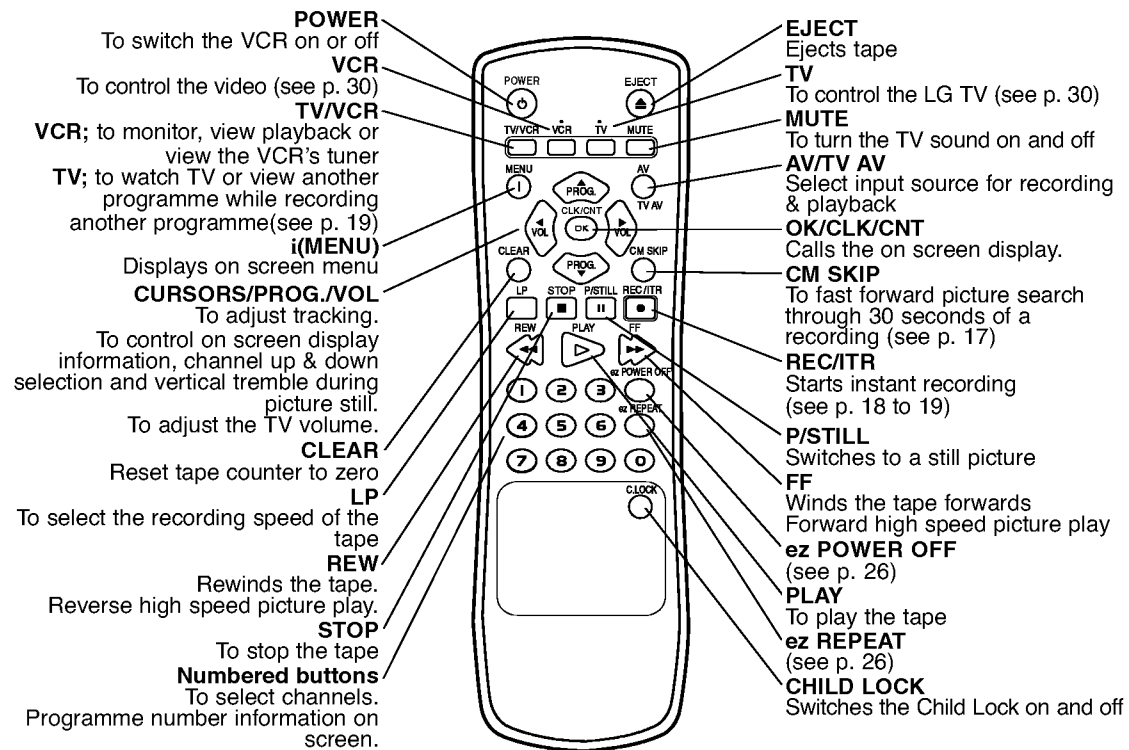



Each button on your VCR has the same function as its corresponding button on the remote control handset.

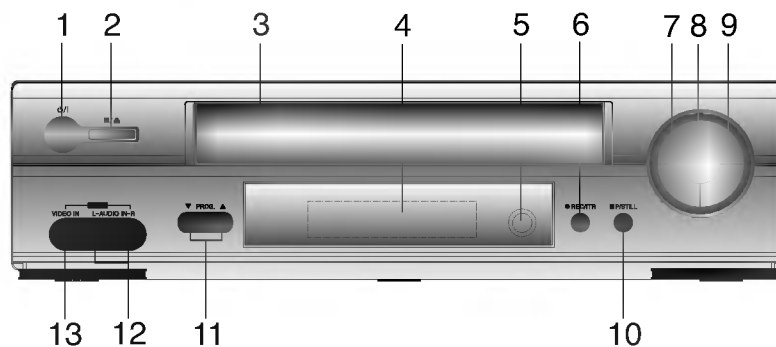

- | | |
|-----------------------------|---------------------------------|
| 1. Power (ON/OFF) | 8. PLAY |
| 2. Stop & Tape Eject | 9. FF |
| 3. Cassette Compartment | 10. Pause/Still |
| 4. VCR Display | 11. Channel Programme Selectors |
| 5. Remote Control Sensor | 12. Audio IN sockets |
| 6. REC/ITR (Instant Record) | 13. Video IN socket |
| 7. REW | |

Your VCR's Controls

Connections To a TV & Decoder (or Satellite)

Using your VCR very first time

Following picture will display on the TV screen when you have just connected your video recorder for the very first time.

To make tuning TV stations, please follow stages 3 to 4 as shown "ACMS" (see p. 11).

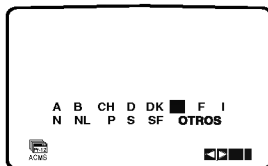

The guidance given on the next two pages is the most common forms of connection. However please check with your manufacturers instruction books for specific information. Make sure all connections are made with both your VCR and additional appliance unplugged from the mains to avoid damaging your equipment.

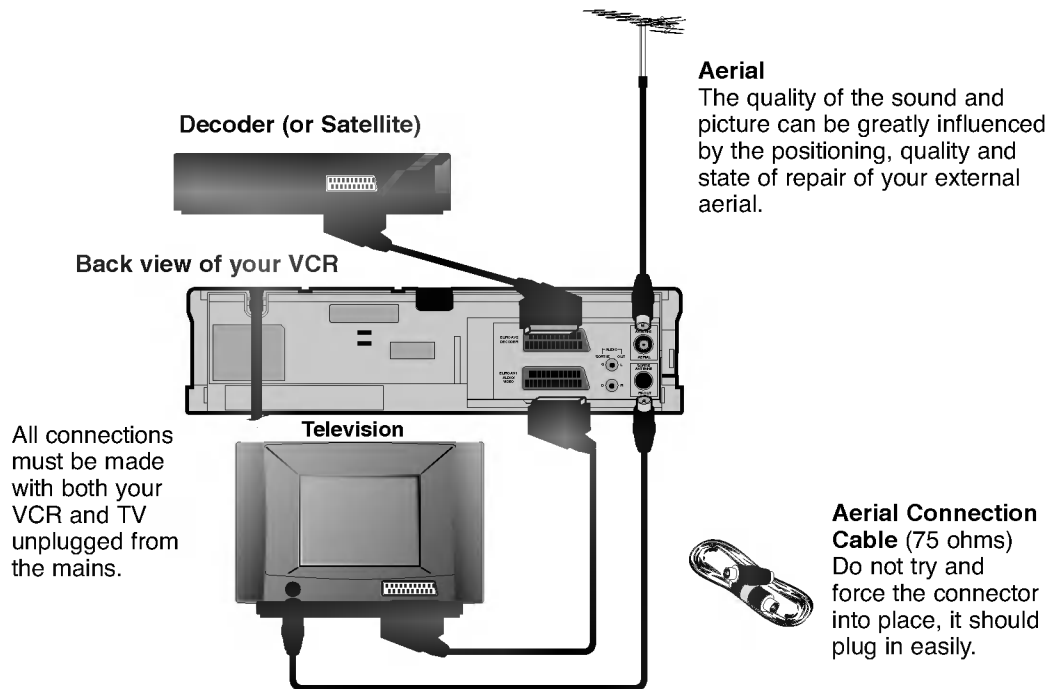

Connections To your Hi-Fi & Camcorder

 An audio system can be connected to the AUDIO OUT sockets on the back of your VCR. Please remember to turn the volume to minimum on your Hi-Fi, then gradually increase the volume; this will prevent damaging your speakers and save you from an extremely noisy shock!

 Make sure all connections are made with both your VCR and camcorder unplugged from the mains to avoid damaging your equipment. To make connecting your camcorder easier we have designed the Audio IN (Left and Right) and Video IN sockets on the front panel of your VCR.



Audio out sockets & Phono Leads

The phono sockets for connecting your VCR to your Hi-Fi are on the back of the set; L = Left sound output, R = Right sound output. You normally have to select the AUX function on your Hi-Fi.

Front view of your VCR

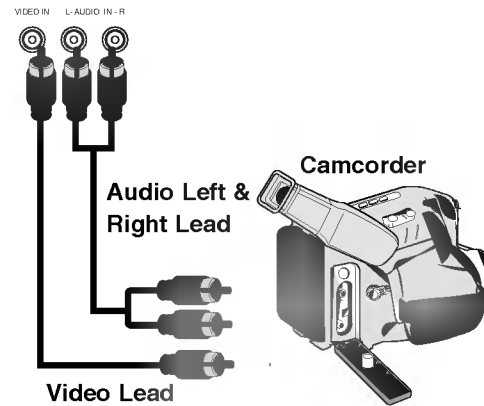

Tuning in a Video channel On your TV

The output frequency of this video recorder (VCR) is set at UHF channel 36. If channel 36 is already used by another TV station, or if the picture is distorted, you can change the transmitter channel of your VCR. Stages 5 ~ 8 will show you how to change the output frequency of your VCR.



Your TV receives signals from the video recorder (VCR) like another TV station. You have to select a channel number on your TV and tune it in so that you may watch video tapes. If you have used a **SCART** or **AUDIO** and **VIDEO** cables then your TV should already have a dedicated video channel built into it, usually called **AV**.

1

Make sure that you have correctly installed your VCR as described earlier in this book.

Press **POWER** to turn on your VCR.

Turn on your TV.

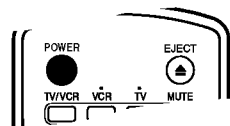

2

Insert a pre-recorded video tape into your VCR and press **PLAY** on the remote control.

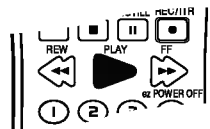

Select a TV channel number on which you wish to watch video's.

Don't worry if you don't have a video-tape to play at this stage! If you switch your VCR on and continue stages **3 ~ 4**, instead of seeing video playback tune your TV until you see a bright blue screen.

3

Tune this channel until the video picture is sharp and the sound is clear.

If you have used a **SCART** or **AUDIO** and **VIDEO** cables you will not have to tune your TV, simply select the **AV** channel. The **AV** channel is already pre-tuned for optimum video playback on your TV.

4

Store this channel on your TV.

You will need to look at the TV instruction book if you do not know how to do this.

5

Only carry out stages 5 ~ 8 if you cannot obtain clear video playback as described in stages 1 ~ 4.

Select a TV channel number on which you wish to watch video's.

Make sure that your VCR is in standby by pressing **POWER** on the remote control. (only the clock will be displayed.)

6

Press **PROG. ▲** or **▼** on the front of your VCR for more than 4 seconds.

RF36 will appear in the VCR display.

The following picture will be displayed on the TV screen.

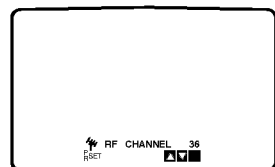

7

Press **PROG. ▲** or **▼** to select another video channel.

You can also set it to "OFF" if there is any interference when your TV is connected to the VCR with a SCART lead.

You may select any channel number between 22 and 68.

8

Select a TV channel number on which you wish to watch video's.

Tune this channel so that a bright blue screen appears.

Store this channel on your TV.

Press **0/1** on the front of your VCR when you have finished.



Make sure that you have correctly installed your VCR and successfully tuned in a dedicated video channel on your TV. If you do not tune in a dedicated video channel on your TV you will be unable to view and record video tapes!

How to Using the main menu

LANGUAGE SELECTION

You can select the language among English, Deutsch, Français, Italiano, Español and Dutch.



This VCR can easily be programmed by using the menus displayed on screen. The menus are controlled from the REMOTE CONTROL HANDSET.

1

Switch on your TV set and video recorder by pressing the **POWER** button.

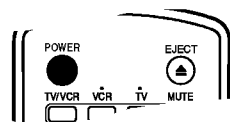

2

Press **i** button. The main menu will appear on the TV screen.

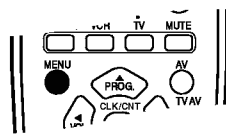

3

Press **◀** and **▶** to select the desired menu. Press **OK** and press **▲** or **▼** to select.

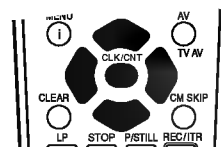

4

Press **i** to remove the menus from the TV screen.

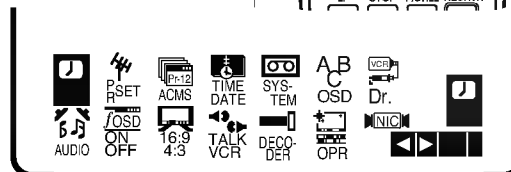
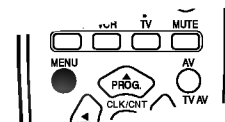

- **REC** - Timer recording setting (see p. 22 to 23).
- **PR SET** - Manual tuning setting (see p. 12 to 13).
- **ACMS** - ACMS (Automatic Channel Memory System) (see p. 11).
- **TIME DATE** - Date & clock setting (see p. 21).
- **SYSTEM** - To set the Colour TV System (see p. 20).
- **ABC OSD** - To change the language setting for OSD (see left).
- **Dr.** - To check a problem with your VCR (see p. 27).
- **AUDIO** - To select the channel for audio output (see p. 28).
- **OSD ON/OFF** - To display the operational mode of your VCR (see p. 24).
- **16:9/4:3** - To select the aspect ratio of your TV (see p. 26).
- **TALK VCR** - A voice tells you how to use the features in the menus if TALK VCR is ON (Español only).
- **DECODER** - To use a pay-TV decoder (or Satellite) with your VCR (see p. 20).
- **OPR** - To improve the playback picture (see p. 17).
- **NIC** - To activate or deactivate the NICAM digital sound (see p. 28).

Tuning in TV stations Automatically

1

Press **POWER** to turn on your VCR.

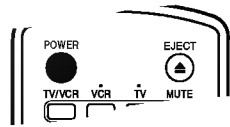

2

Press **i**.

The main menu will appear on the TV screen.

Press **◀** or **▶** to select the **ACMS**.

Press **OK**.

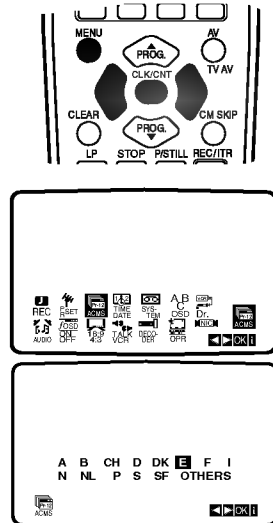

3

Press **◀** or **▶** to select **COUNTRY**.

(**A**: Austria, **B**: Belgium, **CH**: Switzerland, **D**: Germany, **DK**: Denmark, **E**: Spain, **F**: France, **I**: Italy, **N**: Norway, **NL**: Netherlands, **P**: Portugal, **S**: Sweden, **SF**: Finland, Others)

Press **OK** again to start the automatic tuning process.

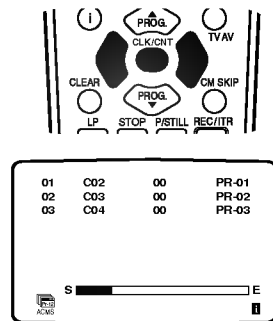

4

The TV station table will appear when tuning is complete.

Press **i** to save your settings.

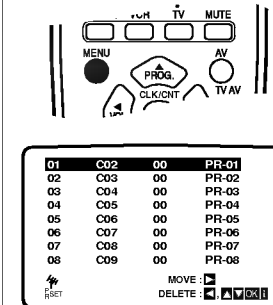

Tuning in TV stations Manually



In certain areas of the country broadcast signals may be too weak for your VCR's automatic tuning process to find or assign TV stations correctly. You must tune in these weaker broadcast stations manually in order for your VCR to store them.

1

Press **i**.

The main menu will appear on the TV screen.

Press **◀** or **▶** to select the **PR SET**.

Press **OK**.

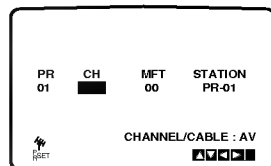
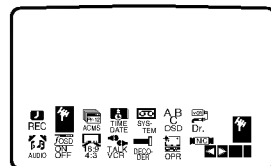
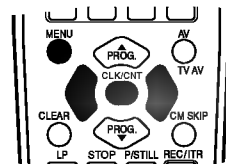

2

Press **i**.

TV station table will appear.

Press **▲** or **▼** to select the programme number you want to tune. (for example, PR 09)

Press **OK**.

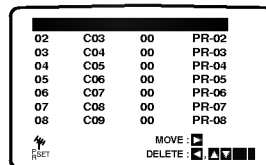
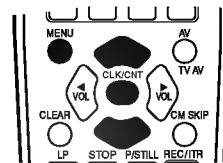

3

Press **AV** to select **C** (Standard stations) or **S** (Cable stations): C02 - C69, S01 - S41.

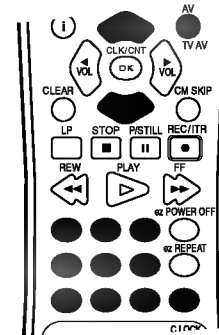

Enter the channel number of station that you want to tune with the **numbered buttons** or use **▲** or **▼** to find the required station.

4

Searching will stop when it locates a station.

Press **▶** to select **MFT**. Press **▲** or **▼** to adjust.

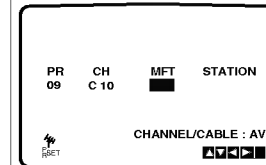
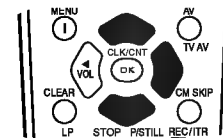

5

Press **▶** to select **STATION** so that you may name your TV station.

Press **OK**.

The TV station name list will appear.

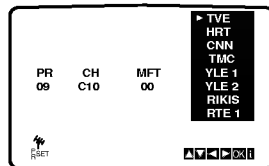
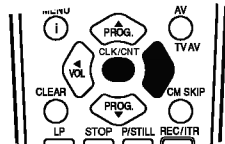

6

Press **▲** or **▼** to select a station name from the list.

Press **OK** to select it.

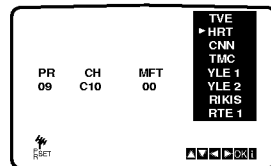
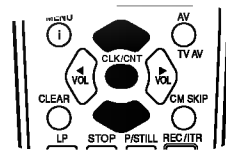

7

You can change a TV station name manually rather than using the "standard" names.

Press **▶**.

Press **▲** or **▼** to select **letters** and **numbers** for the new station name.

Press **◀** or **▶** to move back and forth between characters.

Press **OK**.

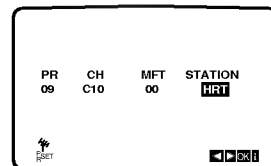
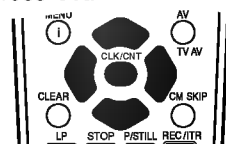

8

Press **i**, confirm the station placement.

Press **i** again.

Your new TV station has now been tuned into your VCR.

If you wish to manually tune other stations repeat stages 1 - 8.

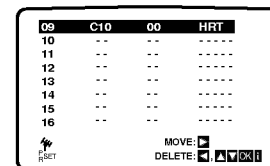
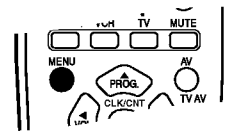

Changing the order of TV stations



After tuning TV stations into your VCR you may wish to **change** the order in which they are stored without having to retune them against! The instructions given on this page will show you how you can simply move them into your desired order.

1

Press **i**.

The main menu will appear on the TV screen.

Press **◀** or **▶** to select the PR SET.

Press **OK**.

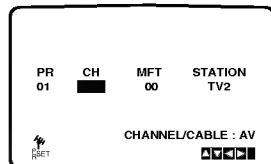
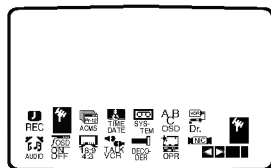
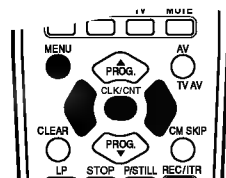

2

Press **i**.

Press **▲** or **▼** to select the **programme number** you want to move (for example, PR 03).

Press **▶**.

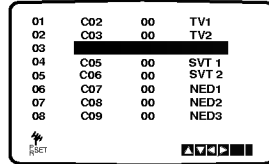
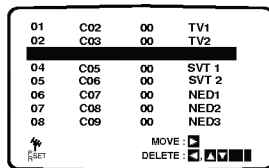
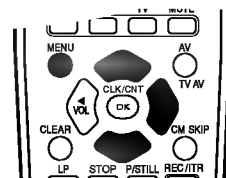

3

Press **▲** or **▼** to select the **programme number** you want to move to (for example, PR 05).

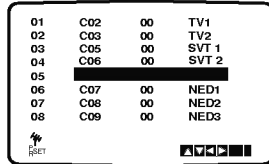
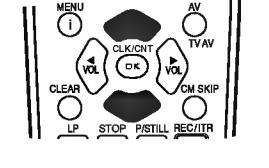
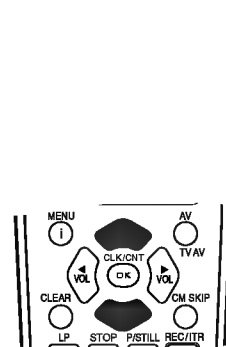

4

Press **OK**.

The selected **programme** will be moved to the **new programme number**.

If you wish to move other TV stations repeat stages 1 - 4.

Press **i** to remove the menus from the TV screen.

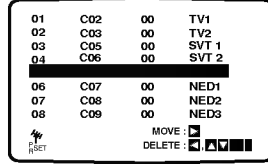
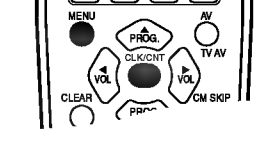
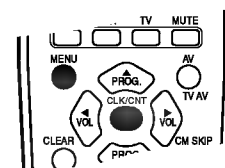



After tuning TV stations into your VCR you may wish to **delete** a station.
The instructions given on this page will show you how easily delete any unwanted TV stations.

1

Press **i**.

The main menu will appear on the TV screen.

Press **◀** or **▶** to select the **PR SET**.

Press **OK**.

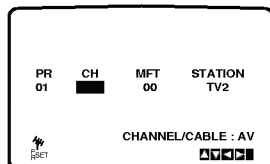
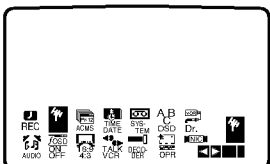
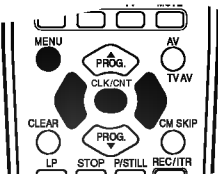

2

Press **i**.

Press **▲** or **▼** to select the **programme number** you want to delete.
(for example, PR 03)

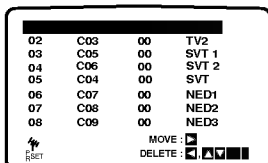
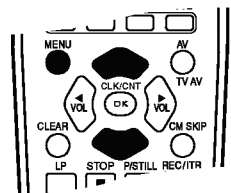

3

Press **◀**.

After a short while, the selected station will be deleted.

The following stations are resorted automatically.

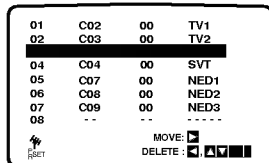
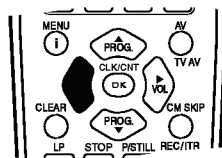

4

Press **i** to remove the menus from the TV screen.

If you wish to delete other TV stations repeat stages **1 - 3**.

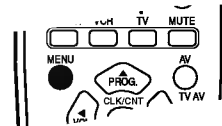

Deleting TV Stations



How to selecting Stored TV stations:

Stored TV stations can be selected in either of two ways.
Press **PROG**, **▲** or **▼** to select different stations that are tuned into your VCR.

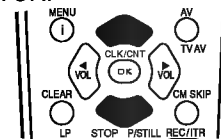

You may also directly select stations using the **numbered buttons** on the remote control.

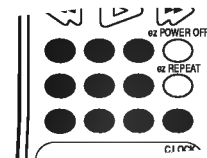

Playback a tape

You will only be able to load and eject video cassettes when your VCR is plugged into the mains. Your VCR may also playback recordings from NTSC tapes (on PAL TV).

Getting a better picture

When a cassette is inserted and playback started, the automatic tracking function works to get the best possible picture automatically. If the quality of the recording is poor, repeatedly press ▼ or ▲ on the remote control to manually adjust the tracking until any distortions have been removed. Press **numbered 0** on the remote control to switch automatic tracking back on again.

1

Make sure that you have correctly connected your VCR as described earlier in this book.

Turn on your TV.

Press **POWER** to turn on your VCR.

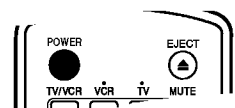

Insert the video cassette into your VCR.

The video cassette should have the window side facing up and the arrow facing away from you.

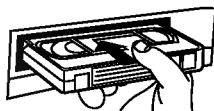

2

Press **PLAY** to start playing your tape.



If you load a video cassette which has had its record protection tab removed playback of the cassette will start automatically.

AUTO TRACKING

Your VCR will automatically adjust the tracking to give the best picture quality.

3

Press **P/STILL** to still a picture.

Press **P/STILL** repeatedly to advance the tape frame by frame.



Tapes can be paused for up to 5 minutes. After 5 minutes your VCR will stop the tape to prevent damaging the tape or your VCR.

Still picture quality can be improved slightly by pressing ▲ or ▼.

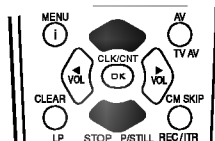

4

Press **PLAY** to continue playing your tape.

Picture search:

During playing back press either **FF** or **REW** to this will enable you to rapidly wind the tape (7 times normal playback) see where you are on the tape.

Logic search:

During fast forwarding or rewinding press and hold **FF** or **REW** the picture will be played back at 7 times normal playback speed.

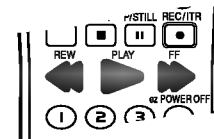



Picture search will only continue for about 3 minutes, after which your VCR will return to normal playback. During picture search, logic search, and CM Skip the sound is muted and there will be some noise streaks on the picture.

5

Slow motion playback, Shuttle:

During playing back or still picture press ◀ or ▶.

You can reach the following playback speeds.

(-7xplay, -3xplay, -play, still, 1/19 slow, play, 2xplay, 7xplay)

To switch off the slow motion and shuttle, press the desired function.

During slow motion and shuttle, the noise bars may appear on the picture according to the status of tape.

If distortions can be seen in the picture, reduce them with ▲ or ▼.

6

Press **STOP** to end playback.

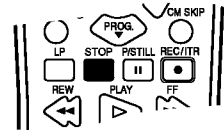

Press **EJECT**.

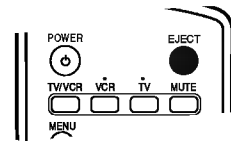

If the end of the tape is reached, your VCR will stop playback automatically, rewind, stop, eject the tape and place itself into power off mode.

CM (Commercial Message) Skip:

This feature enables you during playback of a tape to skip a commercial break in a few seconds, then resume normal playback.

While tape is playing press **CM SKIP** on the remote control to skip commercial (or another programme material).



Repeatedly press **CM SKIP** to skip:

- 1 Press 30 seconds
- 2 Press 60 seconds
- 3 Press 90 seconds
- 4 Press 120 seconds
- 5 Press 150 seconds
- 6 Press 180 seconds

OPR (Optimum Picture Response):

This feature automatically improves playback picture quality by adjusting your VCR to the condition of the tape.

Press **i**.

Press ◀ or ▶ to select **OPR**.

Press **OK**.



Press ▲ or ▼ repeatedly to select: **OFF**, **SOFT** or **SHARP**.

Please note you may only set OPR when playing a tape.

Press **i** to remove menus from the TV screen.

Recording TV programmes

If you do not wish to record on a tape (this can happen quite easily by accident!) remove the protection tab on the back edge of the video cassette.

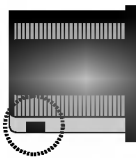

It is possible to record on a video cassette with the record protection tab removed by covering the hole with self adhesive tape.

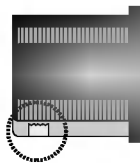

Your VCR allows you to make recordings using a variety of simple methods:
Instant Timer Recording (ITR) start recording immediately for a set period of time or until the video cassette runs out.

1

Make sure that you have correctly connected your VCR as described earlier in this book.

Press **POWER** to turn on your VCR.

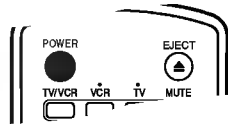

2

Insert a video cassette with protection tab into your VCR.

The video cassette should have the window side facing up and the arrow facing away from you.

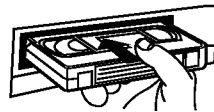

3

Press **PROG.** ▲ or ▼ to select the **programme number** you wish to record.

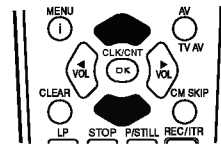

You may also directly select programme number using the **numbered buttons** on the remote control.

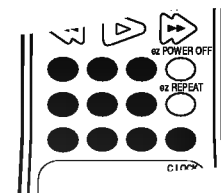

4

If you wish to record directly from the SCART or AUDIO sockets repeatedly press **AV** until the socket you wish to record from is displayed.

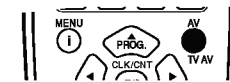

SC01 Hi-Fi Sound only recording using the **AUDIO IN** sockets on the front of your VCR.

AV 1 Sound and Picture recording using the lower SCART socket on the back of your VCR.

AV 2 Sound and Picture recording using the upper SCART socket on the back of your VCR.

AV 3 Recording from **VIDEO IN** and **AUDIO IN** (Left & Right) using the sockets on the front of your VCR.



Your VCR incorporates Long Play (LP) which enables you to record up to twice the amount of time on a video cassette. For example an E-180 will record up to 180 minutes using Standard Play (SP); using LP you will be able to record up to 360 minutes. **Please note** there will be a slight loss in picture and sound quality when using LP.

5

Press **LP** if you wish to record in Long Play or Standard Play.

SP will produce improved picture and sound quality, however LP will provide twice as much recording time as SP. SP or LP will be displayed in your VCR display to let you know which you have selected.

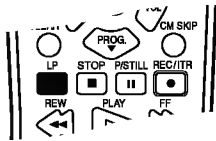

6

Press **REC/ITR** to start recording.

RECORD will appear on the TV screen.

Press **REC/ITR** several times. Each successive press will increase the record time by 30 minutes until you reach a maximum of 9 hours.

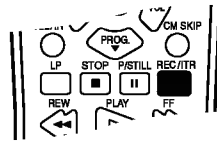

7

Press **P/STILL** to avoid recording unwanted scenes.

Press **P/STILL** to continue recording.

Tapes can be paused for up to 5 minutes; RECP will be displayed when a tape is paused. After 5 minutes your VCR will stop recording to prevent damaging the tape or your VCR.

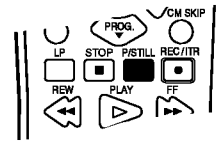

8

Press **STOP** to end recording.

Press **EJECT**.

EJECT will appear on the TV screen for a few seconds.

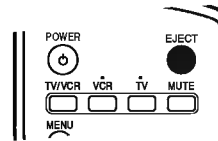
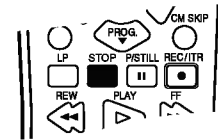

Remember you can record one programme while watching another by starting your instant recording, press **TV/VCR** to select TV mode and then selecting a different channel on your **TV**.

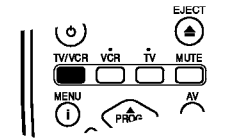

To set the colour system

To set the decoder



Your VCR is equipped with triple colour standard, you can play back a tape in PAL and MESECAM. During playback your VCR detects the colour system automatically. If there are colour problem please select the colour system manually.

1

Press **i**.

The main menu will appear on the TV screen.

Press **◀** or **▶** to select the **SYSTEM**.

Press **OK**.

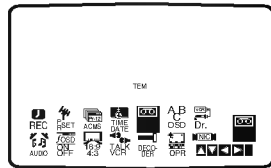
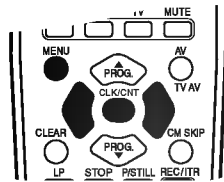

2

Press **▲** or **▼** to select according to the **COLOUR** system used.

AUTO: automatic colour selection,
PAL: PAL recordings
MESECAM: MESECAM recordings.

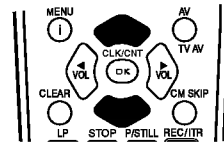

Press **i** remove the menus from the TV screen.

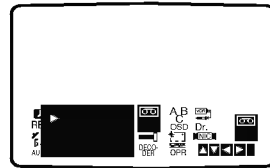

We have already described, how to connect a decoder for pay-TV station as CANAL+ or PREMIERE on page 6. For the recording of an encoded station you do not have to control anything. You just select the station and wait shortly until the decoding will start.

1

Press **i**.

The main menu will appear on the TV screen.

Press **◀** or **▶** to select the **DECODER**.

Press **OK**.

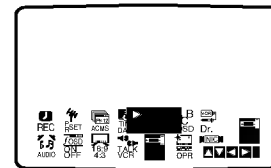
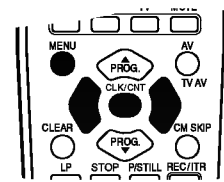

2

Press **▲** or **▼** to select.

ON: When the decoder is connected to the AV2 socket.

OFF: When another VCR is connected to the AV2 socket.

Press **i** to return to a TV picture.

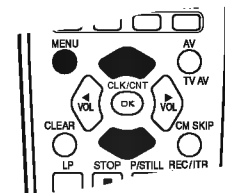

Setting the clock Manually



The clock in your VCR controls time and date settings for your VCR.

1

Press **i**.

Press **◀** or **▶** to select
TIME DATE.

Press **OK**.

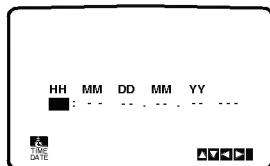
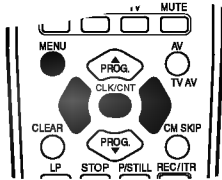

2

Use the **numbered buttons** on the remote control to alter the **HOURS, MINUTES, DAY, MONTH** and **YEAR**.

Please note your VCR uses a 24 hour clock.
e.g. 1pm will be displayed as 13:00.

The day of the week will appear automatically when you enter the year.

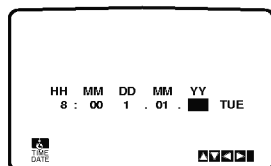
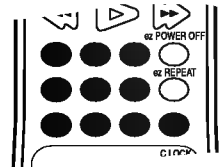

3

If you make a mistake press **◀** or **▶** and enter the correct details.

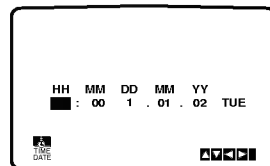
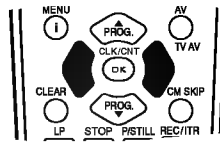

4

Press **i**.

Your new clock settings are stored and will appear on your video recorder's display.

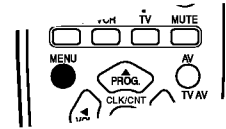



If at a later date you wish to **delete** or **change** any of the settings in timer event memory you may do so without having to enter all the timer event information again. Simply display the timer event screen. Press **▲** or **▼** to select the event that you wish to **delete** or **change**. Press **◀** to delete the event...or Press **OK** to change; then press **◀** or **▶** to select; Station, Date, Start and End times and LP. Press **▲** or **▼** to enter the correct information.

5

Press the **numbered buttons** to enter the date of the programme.

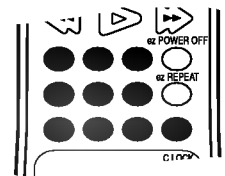

If you press **OK** before entering the date you may select one of the following automated recording features. Press **◀** or **▶** to select, then press **OK** to confirm.

DLY To record every day (except Saturday and Sunday) at the same time.

Weekly To record at the same time every week.

PR	DATE	TIME	SP
SVT 2	■	SP
..	SP
..	SP
..	SP
..	SP
..	SP
..	SP
..	SP
■	SU MO TU WE TH FR SA		

6

Press the **numbered buttons** to enter the recording start and end times of the programme that you wish to record.

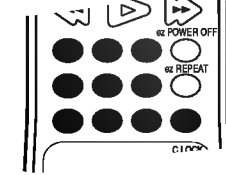

Please note your VCR uses a 24 hour clock. e.g. 1pm will be displayed as 13:00. You may also select the the start and end times by pressing **▲** or **▼**.

PR	DATE	TIME	SP
SVT 2	16	19:00-20:00	SP
..	SP
..	SP
..	SP
..	SP
..	SP
..	SP
..	SP

7

Press **▶** to select the recording speed.

Press **▲** or **▼** to select the desired tape speed (SP, IP, or LP).

IP mode determines how much tape is left and switches speed from SP to LP, if necessary, to complete recording the program.

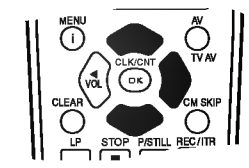

PR	DATE	TIME	SP
SVT 2	16	19:00-20:00	■
..	SP
..	SP
..	SP
..	SP
..	SP
..	SP

8

Check that the timer event details are correct.

Press **i** twice.

If **PLEASE CHECK** is displayed, you have entered incorrect and will need to re-enter the data.

Press **POWER** to switch your VCR Standby.

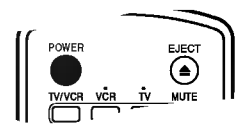

TIMER will appear in the video recorder's display while your VCR waits to make the recording.



If Timer record events Overlap...

Make sure that the preset times of the timer recording events do not overlap. If they do, the earlier programme will always be given priority.

Example: Programme 1 is programmed to start at 16:00 and end at 17:00.

Programme 2 is programmed to start at 16:30 and end at 17:30.

(In this case, Programme 1 will be recorded in its entirety, but only the last 30 minutes of Programme 2 will be recorded.)

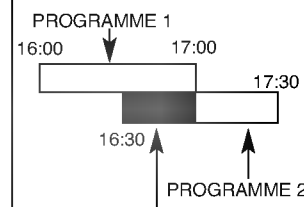

(This portion will not be recorded.)

Energy Saving Advanced On Screen Display



Your VCR has an Energy Save feature which if set will place your VCR into an economic power save where the clock display will disappear. If you have programmed a recording, this feature will not work.

1

Press $\phi/1$ on the VCR.

The VCR and clock will appear on the video recorder's display.

2

Press $\phi/1$ on the VCR again and your VCR will go into **Energy Save**.

All indicators will turn off in the video recorder's display.

Press $\phi/1$ to switch off **Energy Save**.



You may easily display the current time or tape counter, amount of tape left, day, month, year, day of week, programme channel, and operational mode of your VCR will appear on the TV screen.

If a recording is taking place these On Screen Displays will not be recorded onto the tape.

1

Press **OK/CLK/CNT** to display.

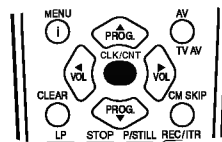

VCR Function Channel Programme

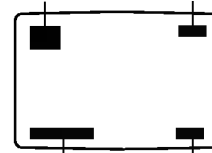

Day/Month/
Year/Day of
Week Clock/Tape
Counter &
Amount of
Tape Left

Press **OK/CLK/CNT** repeatedly to cycle through the display options. The tape counter and amount of tape left will appear if there is a tape loaded.

2

After 3 seconds the majority of the On Screen Displays will clear leaving only the clock or tape counter and the amount of tape left on the screen.

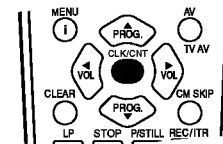

Press **OK/CLK/CNT** again to remove all displays from the TV screen.



The **Digital Tape Counter** can be displayed on your TV screen instead of the time by pressing **OK/CLK/CNT** on the remote control. The Digital Tape Counter indicates the relative positions of recordings on the tape.

1

Press **OK/CLK/CNT**. Press **CLEAR** to set the counter to 0:00:00.

Press **PLAY** or start recording.

The tape counter will display the actual play time in hours, minutes and seconds.

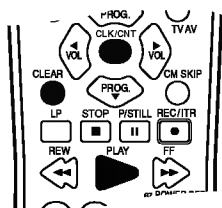

2

Press **STOP** when playback or recording is complete.

Press **REW**.

The tape will rewind and automatically stop when the counter returns to 0:00:00.

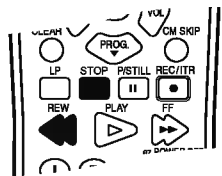

The control buttons on the front of the VCR can be switched off so that your VCR can only be operated using the remote control.

1

Press **C.LOCK**.

SAFE will appear on the TV screen.

SAFE will flicker in your video recorder's display for a few seconds.

None of the buttons on the front of your VCR will work (except **STOP/EJECT**).

If any buttons on the front of your VCR are pressed **SAFE** will appear in your video recorder's display and on the TV screen for a few seconds.

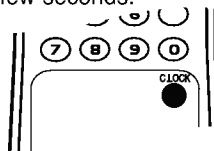

2

Press **C.LOCK** again to switch off the child lock.

OFF will flicker in your video recorder's display for a few seconds.

Tape Counter Memory Stop

Wide Screen Compatibility 16:9



Your VCR can record and play back wide screen aspect ratio programmes (16:9). To record a wide screen format programme successfully the correct type of wide screen signal must be broadcast by the TV station.

1

- Switch on your VCR.
- Press **i**.
- Press **◀** or **▶** to select **16:9/4:3**.
- Press **OK**.

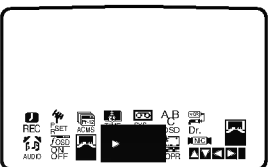
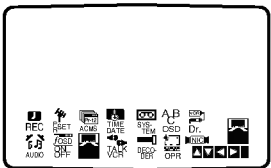
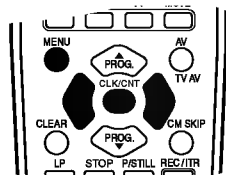

2

- Press **▲** or **▼** repeatedly to select: **AUTO, 4:3** or **16:9**.

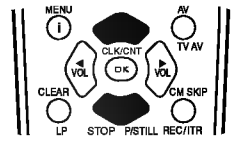

AUTO:
Automatically plays back Wide-Screen programmes as Wide-Screen and Normal programmes as normal.

4:3
Only for playing back and recording Normal format recordings (4:3).

16:9:
Only for playing back and recording Wide-Screen format recordings (16:9).

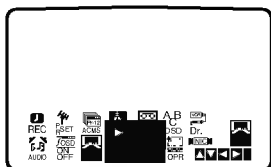

3

- Press **i** to remove the menus from the TV screen.

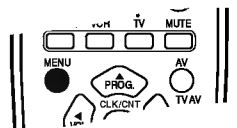

To enjoy Wide-Screen playback you must connect your VCR to the TV using a SCART cable.



Automatic Memory Shut-Off

This feature of your VCR enables you to switch off your VCR automatically after tape rewind has been completed.

1

Press **POWER** during tape rewind.

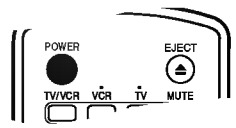

2

The tape will rewind to the beginning and your VCR will automatically switch itself off.



Self-Diagnosis (VIDEO DOCTOR)

This feature informs you that there is a problem with your VCR. These error messages will appear on the TV screen and in your video recorder's display.

1

Switch on your VCR.

Press **i**.

Press **◀** or **▶** to select **Dr.**

Press **OK**.

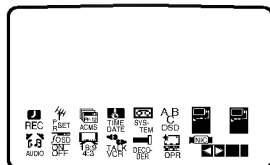
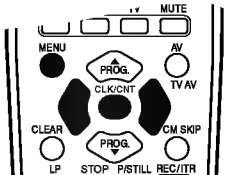

2

Press **▲** or **▼** to check a problem.

HEAD STATUS

- **PLEASE CLEAN:**
Clean your video heads.

TAPE STATUS

- **NOT RECORDABLE:**
Insert a tape with its protection tab in place

NO. OF TIMER PROGRAMME

- **2**
Shows the number of timer recording.

NEXT TIMER PROGRAMME

- **PR-01 26 10:00~11:00 SP**
Shows the current status of timer recording.

Press **i**.

Memory Shut-Off Self-Diagnosis

Hi-Fi Stereo Sound System AVCHD



Your VCR will record and playback Hi-Fi stereo sound. In addition it has a stereo NICAM digital stereo sound decoder. This allows you to record and playback the sound in several different ways. Video cassettes recorded on your VCR will have a normal mono audio track and two VHS Hi-Fi stereo audio tracks. These stereo tracks allow you to make audio recordings in Hi-Fi stereo or bilingual mode from a TV broadcast, stereo audio system, video disc or another Hi-Fi VCR.

1

Your VCR's NICAM digital sound decoder allows you to enjoy broadcasts with NICAM sound, as well as standard stereo, bilingual and mono sound. The particular type of sound received or that recorded will be briefly displayed on the TV screen for a couple of seconds:

STEREO NICAM

Sound is automatically recorded on the Hi-Fi stereo and mono tracks of the video tape.

BIL NICAM

Both audio channels will be recorded on the Hi-Fi stereo tracks. The primary language channel (left) will be recorded on the mono track of the video tape.

MONO

The sound is recorded on the Hi-Fi tracks and the mono track of the video tape without any separation.

2

Switch on your VCR.

Press **i**.

Press **◀** or **▶** to select **AUDIO**.

Press **OK**.

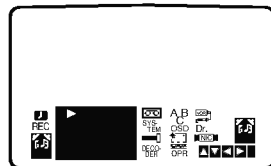
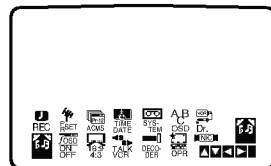
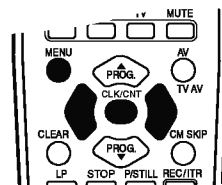

3

Press **▲** or **▼** to select **AUDIO**.

The choice is **STEREO**, **LEFT** (left channel), **RIGHT** (right channel) and **MONO**.

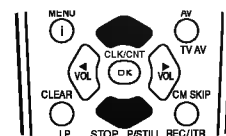

In **BIL NICAM** playback the primary language is output on the left channel and the secondary channel is output simultaneously from the right channel when audio output is set to **STEREO**. The primary language will be output from both channels when the audio setting is **MONO**. Please note that when adjusting the tracking control Hi-Fi stereo sound may revert to **MONO**.

4

Press **i**.

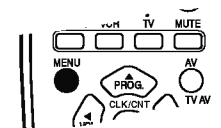



ez (easy) power off

The sequence of "Stop → Rewind → Eject → Power Off" is operated automatically by pressing **ez POWER OFF**.

1

During play back press **ez POWER OFF**.

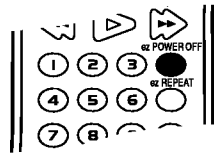

2

Your VCR will be operated as the following ;

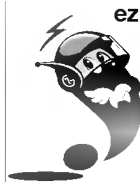
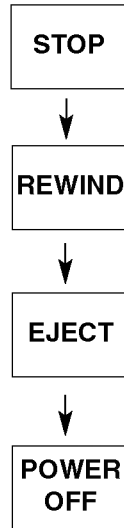

ez (easy) repeat

By pressing & holding **ez REPEAT** during play back, the holding section is replayed twice automatically.

1

During play back, press & hold **ez REPEAT** at the point where repeat play is to be concluded. Then, your VCR will go into reverse search.

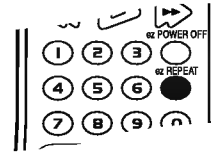

2

Release **ez REPEAT** at the point where repeat play is to start.

The holding section is replayed twice automatically.

Pressing **ez REPEAT** again during repeat play, will return to normal play.

ez (easy)
operations
ADVANCED

Controlling the TV



Your remote control is capable of operating your VCR as well as limited functions of LG TV. Follow the instructions below to operate for your LG TV.

1

Before using the remote control, press the **VCR** or **TV** button to select the device to be operated.

To switch the remote control mode (to operate a different device), be sure to press the **VCR** or **TV** button first.

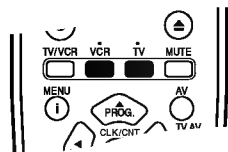

2

The **POWER**, **PROG.(▲/▼)**, **VOL(◀/▶)**, **MUTE** and **TV AV** buttons on remote control are activated for controlling LG TV.

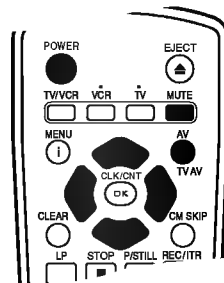

3

Setting Remote Control Codes for LG TV

- This remote control supports two remote control codes for LG TV: Code 1 and Code 2.
- When the unit is shipped from the factory, the remote control is set to Code 1. If your LG TV is not operated, set the remote control to Code 2.
- To set the remote control to Code 2, hold down both the **TV** button and “**2**” number button on the remote control. (If the batteries in the remote control are replaced while the remote control is set to Code 2, the setting will revert Code 1.)
- To set the remote control back to Code 1, hold down both the **TV** button and “**1**” number button on the remote control.



If the remote control does not operate your particular TV, try one of the other code or use the remote control originally supplied with the LG TV.

Due to the variety of codes used by manufacturer, OUR COMPANY cannot guarantee that the remote control will operate every model of the LG TV.



A second VCR (for tape copying) should be connected to the AV sockets on the front of your VCR or one of the SCART sockets on the back of your VCR. Remember to select the appropriate audio/video mode by pressing the **AV** button on the remote control.

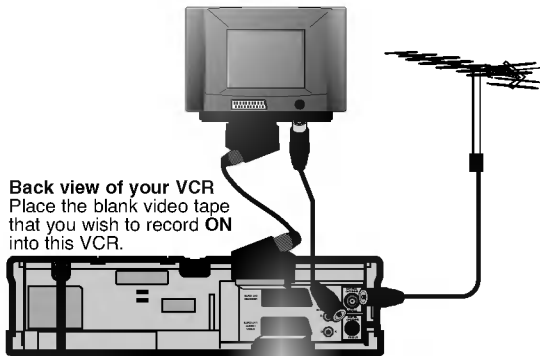

Back view of your VCR
Place the blank video tape that you wish to record **ON** into this VCR.

All connections must be made with both your VCR's and TV unplugged from the mains.

SCART Lead
If you use a SCART lead picture quality will be improved and you will be able to enjoy stereo sound when playing tapes.



Back view of playing VCR
Place the video tape that you wish to record **FROM** into this VCR.

General

Power 200-240V~, 50Hz.
Power consumption Approx. 12 Watts (Energy saving mode: 3 Watts)
Video Head System Double azimuth 4 heads, helical scanning.
Tape speed 23.39 mm/sec (SP mode)/ 11.69 mm/sec (LP mode).
Tape format Tape width 12.7 mm (0.5 inch).
Maximum recording time 4 hours (SP mode, E-240 tape)/ 8 hours (LP mode, E-240 tape).
Rewind time Approx. 65(±10) sec.(E-180 tape).
Dimensions 360 x 94.5 x 270 mm (W x H x D)
Weight 4.0 Kg.
Operating temperature 5°C - 35°C
Operating humidity Less than 80%.
Timer 24 hours display type.

Video

Television system CCIR standard (625 lines, 50 fields)
Recording format PAL/SECAM colour signal
PAL/MESECAM
RF Reception PAL B/G, SECAM B/G
RF Output PAL G
Input level VIDEO IN (SCART, RCA type) 1.0 Vp-p, 75 Ohm, unbalanced
VIDEO OUT (SCART type) 1.0 Vp-p, 75 Ohm, unbalanced
Output level More than 43 dBm.
Signal to noise ratio UHF 22-68 (Adjustable)
RF Modulator

Audio

Input level AUDIO IN (SCART, RCA type)
SCART type: -6.0 dBm, more than 10 kohms
RCA type: -6.0 dBm, more than 47 kohms
Output level AUDIO OUT (SCART, RCA type)
SCART type: -6.0 dBm, less than 1 kohms
RCA type: -6.0 dBm, less than 1 kohms
Track Mono track & Hi-Fi track
Frequency response Normal: 100 Hz-10 kHz (-6/+3 dBm)
Hi-Fi: 20 Hz-20 kHz (-3/+3 dBm)
Signal to noise ratio Normal : More than 43 dB (at SP mode)
Hi-Fi : More than 70 dB (at SP mode)

Specifications

Tape Copying



The design and specifications are subject to change without notice.

Troubleshooting Check List



Video Head Cleaning

Dirt accumulating on the head after a long period of time can cause the playback picture to become blurred or broken up. High quality video cassette tapes will not normally deposit dirt onto the video head, but old or damaged tapes might.

Clean the video heads with a commercially available video heads cleaning tape.

Symptom	Check points	Symptom	Check points
No picture & no sound	<p>Is the mains plug plugged in and switched on?</p> <p>Is the TV switched on?</p> <p>Try another channel, maybe a weak signal.</p> <p>Check aerial is it plugged in? Check aerial, is the lead broken or damaged?</p> <p>Have you tuned in a dedicated channel on your TV to watch video on?</p> <p>If you have a Decoder (or Satellite) connected check Audio/Video sockets and connection cables</p> <p>If you have used a SCART lead to connect your VCR and TV have you selected the AV channel on your TV?</p> <p>Check tuning, carry out Automatic Tuning again</p>	Video cassette cannot be inserted	<p>Is the cassette compartment empty?</p> <p>Are you trying to insert the cassette the right way round?</p>
No playback or poor picture	<p>Are the TV channels tuned in properly?</p> <p>Have you tried using another cassette?</p> <p>Can you minimise the noise bars to an acceptable level with the 0 or ▲ or ▼ buttons?</p>	Remote control does not work	<p>Is the mains plug plugged in and switched on?</p> <p>Is the VCR switched on</p> <p>Check the batteries in remote control.</p>
TV programmes cannot be recorded	<p>Can you get a picture on the TV?</p> <p>Are the aerial leads and special RF connector lead between your VCR and TV connected?</p> <p>Are the TV channels tuned in properly; are they tuned in order?</p> <p>Has the safety tab on the video cassette been removed to prevent recording?</p> <p>Try another station, maybe a weak signal</p> <p>Check aerial is it plugged into TV?</p>	The top of the playback picture is unstable	<p>Is the video cassette damaged, have you tried using another one?</p> <p>Adjust the horizontal control on your TV.</p> <p>Check aerial is it plugged into VCR?</p> <p>Check aerial, is the lead broken or damaged?</p> <p>Check for local interference</p>
		No NICAM sound recording	<p>Make sure NICAM in the menu is set to AUTO for the station to be recorded.</p>
		No Hi-Fi sound	<p>Switch "AUDIO" in the menu to STEREO.</p>
		Auto Play does not work	<p>Has the safety tab been removed from the video cassette?</p>

P/N:3834RP0083B