



HI-FI MICRO CD COMPONENT SYSTEM OWNER'S MANUAL

**MODELS: FFH-163A/AD/AX, FE-163E
FFH-164A/AD/AX, FE-164E
FFH-165A/AD/AX, FE-165E**



Read this manual carefully before operating

for reference.

Specifications are subject to change
without notice.



Precautions

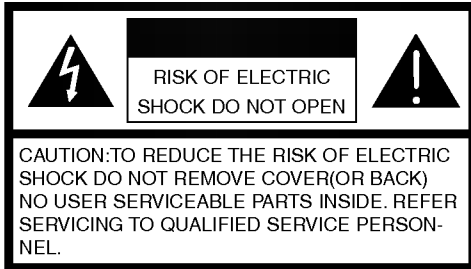

Explanation Graphical Symbols:



The lightning flash with arrowhead symbol, within an equilateral triangle is intended to alert the user to the presence of uninsulated dangerous voltage within the product's enclosure that may be of sufficient magnitude to constitute a risk of electric shock to persons.



The exclamation point within an equilateral triangle is intended to alert the user to the presence of important operating and maintenance (servicing) instructions in the literature accompanying the appliance.

WARNING

TO REDUCE THE RISK OF FIRE OF ELECTRIC SHOCK, DO NOT EXPOSE THIS APPLIANCE TO RAIN OR MOISTURE.

To avoid electrical shock, do not open the cabinet, Refer servicing to qualified personnel only.

The apparatus shall not be exposed to dripping or splashing and that no objects filled with liquids, such as vases, shall be placed on the apparatus.

Warning:

Do not install this equipment in a confined space such a book case or similar unit.

CAUTION

Use of controls or adjustments or performance of procedures other than those specified herein may result in hazardous radiation exposure.

Laser component in this product is capable of emitting radiation exceeding the limit for Class 1.

CAUTION: INVISIBLE LASER RADIATION WHEN OPEN AND INTERLOCKS DEFEATED. AVOID EXPOSURE TO BEAM.

WARNING: OSYNLIG LASERSTRÅLNING NÄR DENNA DEL ÄR ÖPPNAD STRÅLEN ÄR FARLIG.

Attention: Quand l'appareil est ouvert, ne pas s'exposer aux radiations invisibles du faisceau laser.

This label is located on the interior.

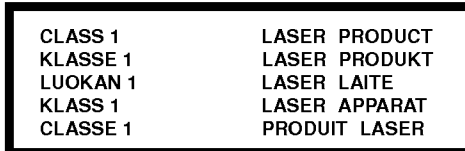

This Compact Disc player is classified as a CLASS 1 LASER product.

The CLASS 1 LASER PRODUCT label is located on the exterior.



This product is manufactured to comply with the radio interference requirements of EEC DIRECTIVE 89/336/EEC, 93/68/EEC and 73/23/EEC.

Table of Contents

INTRODUCTION

Precautions	2
Table of Contents	3
Before Use	4
Safety Precautions	4
Notes on Discs	4
Notes on Remote Control	4
Front Panel/Rear Panel	5
Remote Control	6
Display Window	6
Connections	7
Speaker System Connection	7
Antenna (Aerial) Connections	7

BEFORE OPERATION

Setting the Voltage (OPTIONAL)	8
Setting the CLOCK	8
Sleep Function	8
Timer Function	9
Audio Adjustment	10
Volume Adjustment	10
Sound Quality Adjustment	10
MUTE	10
UBB/HI-TONE	10
Reception of RDS (Radio Data System) Stations - OPTIONAL	10
Auxiliary Function	10



OPERATION

Presetting the radio stations	11
Listening to the radio	11
Tape Playback	12
Basic Playback	12
To Stop Play	12
To Pause Play	12
To Play Fast Rewind or Fast Forward	12
Recording	12
Basic Setting	12
Recording from Radio, CD or Auxiliary source	12
CD to Tape Synchronized Recording	12
CD Playback	13
Basic Playback	13
To Pause Play	13
To Stop Play	13
To Skipping the Track	13
To Play Fast Rewind or Fast Forward	13
To Repeat Play	13
To Program Play	13

REFERENCE

Troubleshooting	14
Specifications	15

About the symbols for instructions

-  Indicates hazards likely to cause harm to the unit itself or other material damage.
-  Indicates special operating features of this unit.
-  Indicates tips and hints for making the task easier.

Before Use

Safety Precautions

Handling the unit

When shipping the unit

The original shipping carton and packing materials come in handy. For maximum protection, re-pack the unit as it was originally packed at the factory.

To keep the surface clean

Do not use volatile liquids, such as insecticide spray, near the unit. Do not leave rubber or plastic products in contact with the unit for a long period of time. They will leave marks on the surface.

Cleaning the unit

To clean the cabinet

Use a soft, dry cloth. If the surfaces are extremely dirty, use a soft cloth lightly moistened with a mild detergent solution. Do not use strong solvents, such as alcohol, benzene, or thinner, as these might damage the surface of the unit.

Notes on Discs

Handling discs

Do not touch the playback side of the disc.
Hold the disc by the edges so that fingerprints will not get on the surface.
Do not stick paper or tape on the disc.

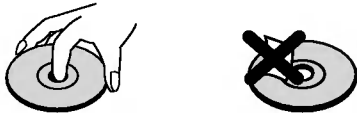

Storing discs

After playing, store the disc in its case.
Do not expose the disc to direct sunlight or sources of heat, or leave it in a parked car exposed to direct sunlight, as there may be a considerable temperature increase inside the car.

Cleaning discs

Fingerprints and dust on the disc can cause poor picture quality and sound distortion. Before playing, clean the disc with a clean cloth. Wipe the disc from the center out.



Do not use strong solvents such as alcohol, benzene, thinner, commercially available cleaners, or anti-static spray intended for analog records.

Notes on Remote Control

Remote Control Operation Range

Point the remote control at the remote sensor and press the buttons.

- **Distance:** About 23 ft (7 m) from the front of the remote sensor.
- **Angle:** About 30° in each direction of the front of the remote sensor.

Remote control battery installation

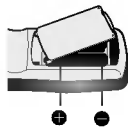

Detach the battery cover on the rear of the remote control, and insert two R03 (size AAA) batteries with + and - aligned correctly.

Caution

Do not mix old and new batteries.
Never mix different types of batteries (standard, alkaline, etc.).

Front Panel/Rear Panel

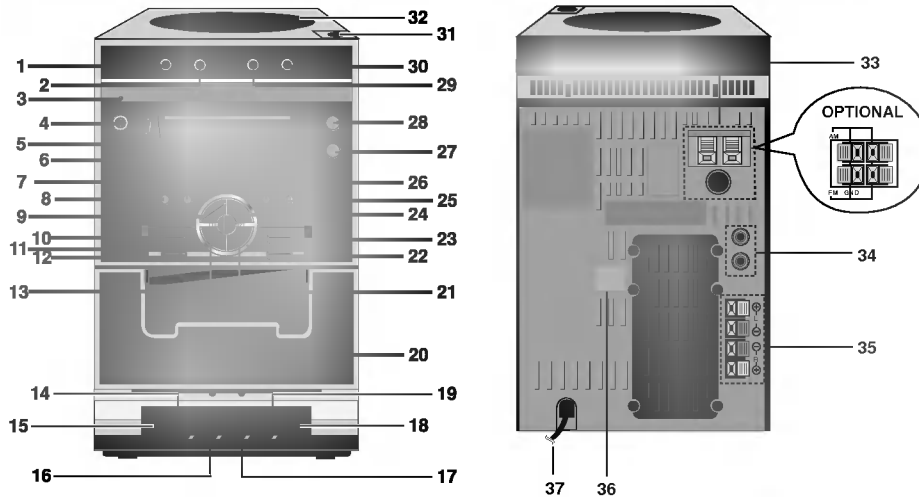

- | | |
|--|---|
| <ol style="list-style-type: none"> 1. FUNCTION SELECT (FUNCTION) button (TUNER/ CD/ TAPE/ AUX) 2. TUNER/BAND button 3. POWER indicator 4. POWER (STANDBY/ON) button 5. Remote Control Sensor 6. DISPLAY 7. REPEAT button 8. PROGRAM/MEMORY button 9. PRESET DOWN button 10. CLOCK button 11. HEADPHONE SOCKET (PHONES): ϕ 3.5mm 12. TIMER button 13. • TUNING DOWN button - TUNER
• CD SKIP/SEARCH (◀◀◀) button 14. PLAY (▶) button - TAPE 15. RECORD (●) button - TAPE 16. REWIND (◀◀) button 17. FAST FORWARD (▶▶) button 18. PAUSE () button 19. STOP/EJECT(■▲) button - TAPE 20. CASSETTE Holder | <ol style="list-style-type: none"> 21. • TUNING UP button - TUNER
• CD SKIP/SEARCH (▶▶▶) button 22. • STOP button
• CLEAR button 23. CD PAUSE (CD) button 24. • CD PLAY (▶) button
• PRESET UP button 25. MODE/RIF button 26. • RDS button : OPTIONAL
• SET (CLOCK/ TIMER) button 27. VOLUME DOWN button 28. VOLUME UP button 29. UBB/Hi-TONE button 30. EQUALIZER PATTERN (EQ PATT.) button 31. CD OPEN (▲) button 32. CD DOOR 33. ANTENNA TERMINAL 34. AUXILIARY INPUT SOCKET (AUX) 35. SPEAKER TERMINAL 36. VOLTAGE SELECT SWITCH : OPTIONAL 37. POWER CORD |
|--|---|

Remote Control

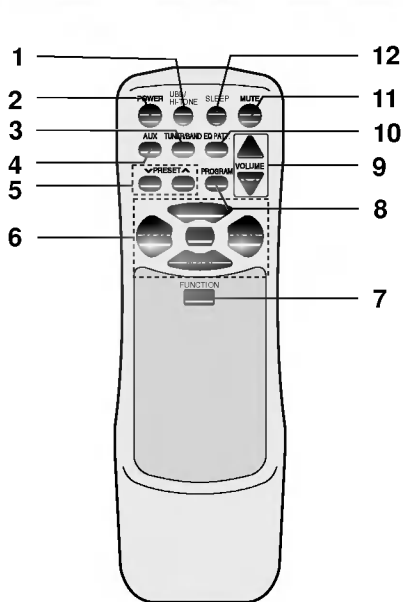

1. UBB/HI-TONE button
2. POWER button
3. TUNER/BAND button
4. AUX button
5. PRESET (∇/∧) button
6. CD FUNCTION buttons
 - CD PLAY/ PAUSE (▶/||) button
 - CD STOP(■) button
 - CD SKIP/SEARCH (◀◀◀/▶▶▶) button
 - REPEAT button
7. FUNCTION button
8. PROGRAM button
9. VOLUME CONTROL (∇/∧) button
10. EQUALIZER PATTERN (EQ PATT.) button
11. MUTE button
12. SLEEP button

Display Window

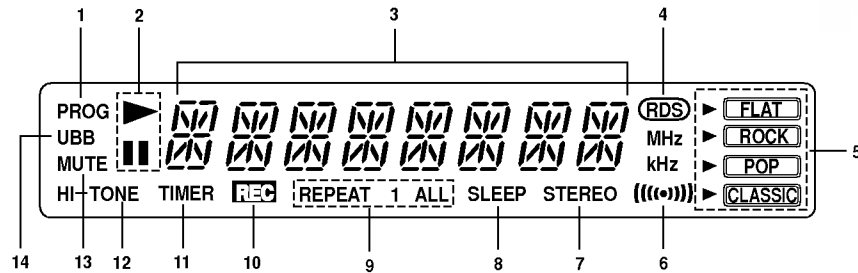

1. PROGRAM indicator
2. PLAY/ PAUSE indicator
3. FUNCTION indicators
4. RDS indicator : OPTIONAL
5. EQUALIZER PATTERN indicator
6. FM STEREO indicator
7. FM STEREO RECEIVING indicator
8. SLEEP indicator
9. CD REPEAT indicator
10. TAPE RECORD indicator
11. TIMER indicator
12. HI-TONE indicator
13. MUTE indicator
14. UBB indicator

Connections

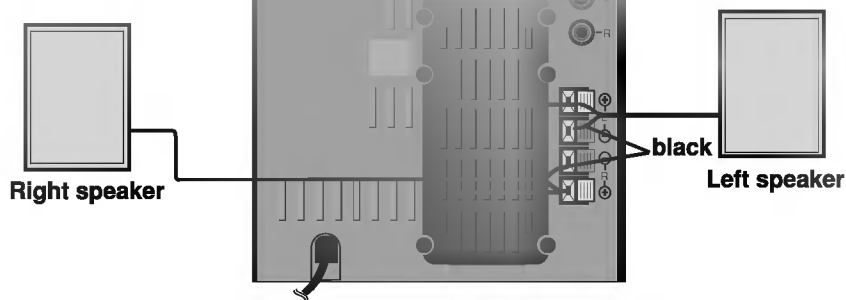

Notes

- Be sure to match the speaker cord to the appropriate terminal on the components: + to + and – to –. If the cords are reversed, the sound will be distorted and will lack base.
- If you use front speakers with low maximum input rating, adjust the volume carefully to avoid excessive output on the speakers.
- Do not disassemble the front cover of supplied speaker.

Antenna (Aerial) Connections

Connect the supplied FM/AM antennas for listening to the radio.

- Connect the AM loop antenna to the AM antenna connector.
- Connect the FM wire antenna (or FM "T" antenna) to the FM 75Ω/300Ω coaxial connector.

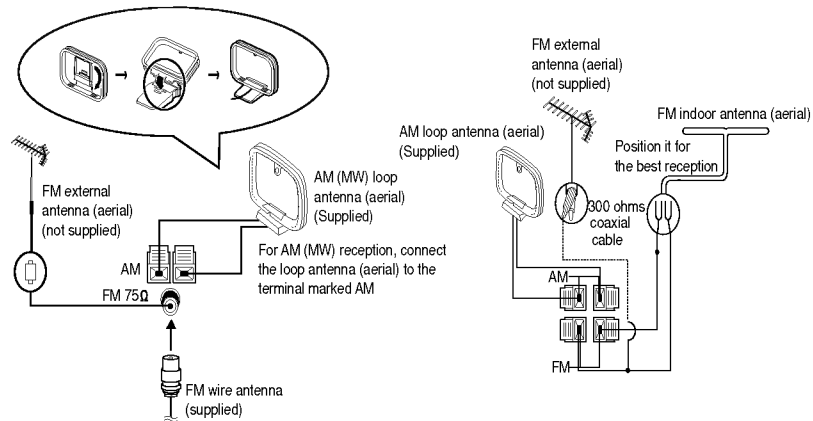

Notes

- To prevent noise pickup, keep the AM loop antenna away from the unit and other components.
- Be sure to fully extend the FM wire antenna.
- After connecting the FM wire antenna, keep it as horizontal as possible.

Setting the Voltage (OPTIONAL)

If your set is equipped with a voltage selector at the back side, be sure to set it to your local power supplied before connecting the AC power cord.

Setting the CLOCK

- 1** Press **CLOCK**.
(If the clock requires setting, press and hold **CLOCK** for more than 2 seconds.)
- The hours begin to flash.
- 2** Select a 12 hour cycle or 24 hour cycle by pressing **PRESET DOWN/UP** on the front panel.



(12HR)

or



(24HR)

- 3** Press **SET** to confirm the selected hour cycle.

- 4** Use **PRESET DOWN/UP** buttons to set the correct hours on the front panel.

- 5** Press **SET**.

- 6** Use **PRESET DOWN/UP** buttons to set the correct minutes on the front panel.

- 7** Press **SET** and the correct time is shown on the display.

- 8** Press **CLOCK** at any time to display the time for about 3 seconds.

Note

The unit can also set the clock function in power off state.

Sleep Function

When the sleep timer is used, the power is automatically turned off after the specified time has elapsed.

- 1** To specify the time delay before the power is turned off, press **SLEEP**.
In the display window you can see *SLEEP 90* for about 5 seconds. This means that the system turns off automatically after 90 minutes.
Each time the button is pressed the time interval before it turns off is reduced by 10 minutes. i.e. 80...70... etc.
Select the desired time to turn off.

Note

If you press **SLEEP** while the sleep time is displayed, the **SLEEP** time is reset.

To cancel the sleep timer mode

If you wish to stop the function, press the **SLEEP** button repeatedly until 10 appears, and then press **SLEEP** once again while 10 is displayed.

- 2** To check the remaining time until the power is turned off.
While the sleep function is active press **SLEEP** briefly. The time remaining until it turns off is displayed for about 5 seconds.

Timer Function

With the TIMER function you can have the radio reception and recording, CD play, tape play or auxiliary source play and recording turned on and off at the time desired.

1 Press **CLOCK** to check the current time.

For your reference

If you don't set clock, timer function doesn't work.

2 Press **TIMER** to enter the timer setting mode.
TUNER-CD flashes in the display window in turn.

For your reference

If you want to correct the previous memorized TIMER setting, press and hold the **TIMER** button more than 2 seconds.

- The previous memorized timer on time and "TIMER" indicators appear in the display.

3 Press **SET** when the desired function is flashing.

4 1. a. When you select the **TUNER** function, 'PLAY' and 'REC' indicator flash in the display window alternately for about 3 seconds.
'PLAY' indicator : TUNER play only
'REC' indicator : TUNER play and recording
b. Select the previous memorized preset number with **PRESET DOWN/UP** buttons on the front panel and press **SET**.
- 'ON TIME' indicator appears for about 0.5 seconds in the display window and then disappears.

2. When you select the **CD** function,
- 'ON TIME' indicator appears for about 0.5 seconds in the display window and then disappears.

5 Set the hour to switch on by pressing **PRESET DOWN/UP** buttons on the front panel.

6 Press **SET** to confirm the hour to switch on.

7 Set the minute to switch on by pressing **PRESET DOWN/UP** buttons on the front panel.

8 Press **SET** to confirm the minute to switch on.
'OFF TIME' indicator appears for about 0.5 seconds in the display window and then disappears .

9 Set the hour to switch off by pressing **PRESET DOWN/UP** buttons on the front panel.

10 Press **SET** to confirm the hour to switch off.

11 Set the minute to switch off by pressing **PRESET DOWN/UP** buttons on the front panel.

12 Press **SET**.

13 Adjust the volume level by pressing **PRESET DOWN/UP** buttons on the front panel.

14 Press **SET**.
"TIMER" appears in the display window and the timer setting has been completed.

15 Switch the system off.
The selected function is automatically switched on and off at the time set.

To cancel or check the timer

Each time the **TIMER** button is pressed you can select the timer set or cancel. You can also check the timer setting status.

To activate or check the timer, press the **TIMER** button so that "TIMER" appears in the display window. To cancel the **TIMER**, press the **TIMER** button so that "TIMER" disappears in the display window.

Note

The unit can also set the clock function in power off state.

Audio Adjustment

Volume Adjustment

- Press **VOLUME DOWN/UP** buttons clockwise to increase the sound level, or counterclockwise to decrease it on the front panel.
- Press **VOLUME CONTROL (^)** to increase the sound level, or press the **VOLUME CONTROL (v)** to decrease it on the remote control.

Sound Quality Adjustment

- **To activate stereo sound**
You can choose between 4 fixed sound impressions. Select a desired sound mode by using the **EQ PATT.** button.
 - FLAT : linear frequency response
 - ROCK : more bass, more treble
 - POP : less bass, less treble
 - CLASSIC : for orchestral music
- **Headphone Socket**
Connect a stereo headphone plug (ø 3.5mm) into the headphone jack.
The speakers are automatically disconnected when you plug in the headphones (not supplied).

MUTE

Press **MUTE** to mute your unit.
You can mute your unit in order, for example, to answer the telephone, "MUTE" indicator flashes in the display window.

UBB/HI-TONE

Press **UBB/HI-TONE** button to select bass or treble.
- Each you press the button "UBB" or "HITONE" appears in the display window.

Reception of RDS (Radio Data System) Stations - OPTIONAL

What is RDS?

RDS (Radio Data System) is a system gradually being introduced on FM in many countries, where by an inaudible stream of data is transmitted in addition to the normal radio signal. This data contains various information including station/ transmitter identification, traffic information and a list of alternative frequencies for the radio station being received.

1 Press **FUNCTION** repeatedly to appear **TUNER indicator** (or **TUNER/BAND** on the remote control) and then press **TUNER/BAND** to select **FM**.

2 Select a desired station by pressing **TUNING DOWN/UP**.
When the RDS transmission is received, the display shows the program service name (PS) after RDS indicator appears.

3 Press the **RDS** to recall the frequency.

N Notes

- RDS is only available for FM reception.
- The PS (PROGRAM SERVICE) NAME is displayed automatically when a RDS station is received .

Auxiliary Function

1 Connect an auxiliary device i.e. TV or VCR, via the rear mounted AUX phone sockets.

2 Press **AUX**.

N Note

You can also record from the auxiliary input source, see Recording Section.

Presetting the radio stations

You can preset 30 stations for FM and AM. Before tuning, make sure that you have turned down the volume to the minimum.

- 1** Press **FUNCTION** repeatedly to appear **TUNER** indicator (or **TUNER/BAND** on the remote control).
- 2** Press **TUNER/BAND** to select the **FM** or **AM** you want in the display window.
Every time you press **TUNER/BAND**, **FM** and **AM** changes alternately.
- 3** Press **TUNING DOWN/UP** on the front panel until the frequency indication starts to change, then release.
Scanning stops when the unit tunes in a station.

Notes

- **Tuning in automatically**
Press **TUNING DOWN/UP** for more than 0.5 seconds.
 - **Tuning in manually**
Press **TUNING DOWN/UP** briefly and repeatedly.
- 4** Press **PROGRAM/MEMORY** on the front panel.
A preset number will flash in the display window.

5 Press **PRESET DOWN/UP** (or **PRESET (∨/∧)** on the remote control) to select the preset number you want.

6 Press **PROGRAM** again on the remote control.
- The station is stored.

7 Repeat steps 3 to 6 to store other stations.

To clear all the memorized stations

Press and hold **PROGRAM/MEMORY** on the front panel for about two seconds, "CLEAR" appears in the display window and then press **CLEAR**, the stations are cleared.

For your reference

If all stations have already been entered, **FULL** message will appear in the display window for a moment and then a preset number will flash. To change the preset number, follow the steps 5-6.

To recall presets

Press and hold **PRESET DOWN/UP** (or **PRESET (∨/∧)** on the remote control) until the desired preset number appears or press it repeatedly.

Listening to the radio

1 Press **FUNCTION** repeatedly to appear **TUNER** indicator (or **TUNER/BAND** on the remote control) and select the **FM** or **AM** you want in the display window.
The last received station is tuned in.

2 Press **PRESET DOWN/UP** (or **PRESET (∨/∧)** on the remote control) repeatedly to select the preset station you want.
- Each time you press the button, the unit tunes in one preset station at a time.

3 Adjust the volume by pressing **VOLUME DOWN/UP** on the front panel or **VOLUME (∨/∧)** on the remote control repeatedly.

To listen to non-preset radio stations

- Use manual or automatic tuning in step 2.
- For automatic tuning, press and hold **TUNING DOWN/UP** on the front panel.

To turn off the radio

Press **POWER** to turn the unit off or select another function mode (**CD**, **TAPE** or **AUX**).

For your reference

- **If an FM program is noisy**
Press **MODE/RIF** so that "STEREO" disappears in the display window. There will be no stereo effect, but the reception will improve. Press **MODE/RIF** again to restore the stereo effect.
- **To improve reception**
Reposition the supplied antennas.

Notes

- Use **MODE/RIF** (Radio Interference Filter) function to switch to mono reception if stereo reception is distorted by noise.
- When recording the **MW(AM)** or **LW** broadcast, beat noises may occur. If it does, press **MODE/RIF** once.

Tape Playback

Basic Playback

- 1** Press FUNCTION repeatedly to appear TAPE indicator.
- 2** Open cassette deck by pushing STOP/EJECT (■▲) button.
- 3** Insert a cassette with the tape side to the bottom and then close deck.
- 4** Press PLAY (▶).

To Stop Play

Press STOP/EJECT (■▲) during playback.

To Pause Play

Press PAUSE (||) during playback.
Press this button again it to resume play.

To Play Fast Rewind or Fast Forward

After pressing REWIND/FAST FORWARD (◀◀/▶▶) on the front panel during playback or stopping.

AUTO STOP DECK

After auto stop deck plays only front side, the unit stops automatically.

Recording

Wind the tape to the point recording starts. (Use only normal tapes.)

Basic Setting

- 1** Press FUNCTION repeatedly to appear the CD or TUNER indicator.
- 2** Open the cassette deck and insert a blank cassette into the cassette compartment.

Recording from Radio, CD or Auxiliary source

- 1** Press FUNCTION button to select desired recording source, and then press RECORD (●) button.
The recording begins.

For your reference

When you press RECORD (●) button, PLAY(▶) button is pressed automatically.

To pause recording

Press PAUSE (||) button during recording.
• Press PAUSE (||) button again to resume recording.

To stop recording

Press STOP (■).

CD to Tape Synchronized Recording

The CD synchro recording function dubs a complete CD and programmed titles automatically into a cassette.

- 1** When you select CD function, press RECORD (●) button.
"REC" appears and "CD SYNC" displays in the display window.

- 2** The synchronized recording is started automatically after about 8 seconds.

Notes

- If you wish to record from the desired track, select the desired track with CD SKIP/SEARCH (◀◀◀◀ / ▶▶▶▶) before commencing CD synchro recording.
- The function change is not possible during recording.

CD Playback

Basic Playback

- 1** Press **FUNCTION** repeatedly to appear CD indicator.
If no disc is loaded then "NO DISC" is displayed.
 - 2** Press **CD OPEN** (▲) and place the disc into the disc tray.
- Note**
To load an 8cm(3 inch) disc, put it onto the inner circle of the tray.
- 3** Press **CD OPEN** (▲) to close the disc compartment.
 - 4** Press **CD PLAY** (▶) or **CD PLAY/ PAUSE** (▶||) on the remote control.

To Pause Play

Press **CD PAUSE** (CD ||) or **CD PLAY/ PAUSE** (▶||) on the remote control during playback.
Press this button again it to resume play.

To Stop Play

Press **CD STOP** (■) during playback.

To Skipping the Track

- Press the **CD SKIP/SEARCH** (▶▶▶▶) button to go to the next track.
- When the **CD SKIP/SEARCH** (◀◀◀◀) button is pressed once midway through a track, the player returns to the start of that track. When it is pressed again, a track is skipped each time the button is pressed.

To Play Fast Rewind or Fast Forward

After pressing **CD SKIP/SEARCH** (◀◀◀◀ / ▶▶▶▶) buttons for more the 2 seconds on the front panel, then release during playback, press **PLAY** (▶) at the point you want.

To Repeat Play

To play one track repeatedly

Press **REPEAT** once during playback.
- "REPEAT 1" appears in the display.

To play all tracks repeatedly

Press **REPEAT** again during playback.
- "REPEAT ALL" appears in the display.

To cancel repeat play

Press **REPEAT** once more during playback.
- "Repeat indicator" disappears.

To Program Play

You can arrange the order of the tracks on the discs and create your own program. The program can contain up to 20 tracks.

- 1** Press **PROGRAM/MEMORY** (or **PROGRAM** on the remote control) on the stop mode.
- 2** Press **CD SKIP/SEARCH** (◀◀◀◀/▶▶▶▶) buttons to select the track you want.
- 3** Press **PROGRAM/MEMORY** (or **PROGRAM** on the remote control).
- 4** Repeat 1~3.
- 5** Press **CD PLAY**(▶) (or **CD PLAY/ PAUSE** (▶||) on the remote control).

To check program contents

Press **PROGRAM/MEMORY** (or **PROGRAM** on the remote control) on the stop mode.
- A track and program number will be displayed.

To clear program contents

Press **PROGRAM/MEMORY** (or **PROGRAM** on the remote control) on the stop mode. And then press **CLEAR** on the front panel or **STOP**(■) on the remote control.

To add program contents

1. Press **PROGRAM/MEMORY** (or **PROGRAM** on the remote control) repeatedly on the program stop mode until "Track Number" blinks.
2. Repeat 2~5.

To modify program contents

1. Press the **PROGRAM/MEMORY** (or **PROGRAM** on the remote control) to display program number you want to modify.
2. Repeat 2~4.

Troubleshooting

Check the following guide for the possible cause of a problem before contacting service.

Symptom	Cause	Correction
No power.	<ul style="list-style-type: none"> The power cord is disconnected. 	<ul style="list-style-type: none"> Plug the power cord into the wall outlet securely.
No sound.	<ul style="list-style-type: none"> The audio cables are not connected securely. 	<ul style="list-style-type: none"> Connect the audio cable into the jacks securely.
	<ul style="list-style-type: none"> The power of the external source equipment is switched off. 	<ul style="list-style-type: none"> Switch on the external source equipment.
The unit does not start playback.	<ul style="list-style-type: none"> No disc or tape is inserted. 	<ul style="list-style-type: none"> Insert a disc or tape.
	<ul style="list-style-type: none"> An unplayable disc or tape is inserted. 	<ul style="list-style-type: none"> Insert a playable disc or tape.
	<ul style="list-style-type: none"> The disc is placed upside down. 	<ul style="list-style-type: none"> Place the disc with the playback side down.
	<ul style="list-style-type: none"> The disc is not placed within the guide. 	<ul style="list-style-type: none"> Place the disc on the disc tray correctly inside the guide.
The remote control does not work properly.	<ul style="list-style-type: none"> The disc is dirty. 	<ul style="list-style-type: none"> Clean the disc.
	<ul style="list-style-type: none"> The remote control is not pointed at the remote sensor of the unit. 	<ul style="list-style-type: none"> Point the remote control at the remote sensor of the unit.
	<ul style="list-style-type: none"> The remote control is too far from the unit. 	<ul style="list-style-type: none"> Operate the remote control within about 23 ft (7 m).
	<ul style="list-style-type: none"> There is an obstacle in the path of the remote control and the unit. 	<ul style="list-style-type: none"> Remove the obstacle.
	<ul style="list-style-type: none"> The batteries in the remote control are exhausted. 	<ul style="list-style-type: none"> Replace the batteries with new ones.

Specifications

SECTION		MODEL	FFH-163A/AD/AX	FFH-164A/AD/AX	FFH-165A/AD/AX
[General]	Power supply	Refer to the back panel of the unit.			
	Power consumption	20W			
	Mass	3.44kg			
	External dimensions (WxHxD)	161 X 255 X 268mm			
[CD]	Frequency response	40 - 18000 Hz			
	Signal-to-noise ratio	60 dB			
	Dynamic range	60 dB			
[Tuner]	FM	Tuning Range	87.5 - 108.0 MHz or 65 - 74 MHz, 87.5 - 108.0 MHz		
		Intermediate Frequency	10.7 MHz		
		Signal to Noise Ratio	55/50 dB		
		Frequency Response	60 - 10000 Hz		
	AM (MW)	Tuning Range	522 - 1611 kHz or 530 - 1610 kHz		
		Intermediate Frequency	450 kHz		
		Signal to Noise Ratio	35 dB		
		Frequency Response	100 - 1800 Hz		
[Amp]	Output Power	5W + 5W			
	T.H.D	0.5%			
	Frequency Response	60 - 20000 Hz			
	Signal-to-noise ratio	60 dB			
[TAPE]	Tape Speed	4.75cm/sec			
	Wow Flutter	0.25% (MTT -111, JIS-WTD)			
	F.F/REW Time	120sec (C-60)			
	Frequency Response	250 - 8000Hz			
	Signal to Noise Ratio	43dB			
	Channel Separation	50dB(P/B)/45dB(R/P)			
	Erase Ratio	55dB (MTT-5511)			
[Speakers]	Model	FE-163E	FE-164E	FE-165E	
	Type	1 Way 1 Speaker			
	Impedance	4 Ω			
	Frequency Response	80 - 20000 Hz			
	Sound Pressure Level	86 dB/W (1m)			
	Rated Input Power	5W			
	Max. Input Power	10W			
	Net Dimensions (WxHxD)	150x255x175mm			
Net Weight (1EA)	1.52kg				

* Designs and specifications are subject to change without notice.



LG Electronics Inc.

P/NO :3828R-A071D