



# MICRO HI-FI SYSTEM OWNER'S MANUAL

**MODELS: LX-220A/D/X, LXS-220  
LX-221A/D/X, LXS-221**



Read this manual carefully before operating

for reference.

Specifications are subject to change  
without notice.



## Precautions

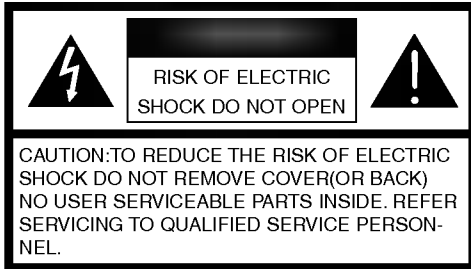

### Explanation Graphical Symbols:



The lightning flash with arrowhead symbol, within an equilateral triangle is intended to alert the user to the presence of uninsulated dangerous voltage within the product's enclosure that may be of sufficient magnitude to constitute a risk of electric shock to persons.



The exclamation point within an equilateral triangle is intended to alert the user to the presence of important operating and maintenance (servicing) instructions in the literature accompanying the appliance.

### WARNING

TO REDUCE THE RISK OF FIRE OF ELECTRIC SHOCK, DO NOT EXPOSE THIS APPLIANCE TO RAIN OR MOISTURE.

To avoid electrical shock, do not open the cabinet, Refer servicing to qualified personnel only.

**The apparatus shall not be exposed to dripping or splashing and that no objects filled with liquids, such as vases, shall be placed on the apparatus.**

### Warning:

Do not install this equipment in a confined space such a book case or similar unit.

### CAUTION

Use of controls or adjustments or performance of procedures other than those specified herein may result in hazardous radiation exposure.

Laser component in this product is capable of emitting radiation exceeding the limit for Class 1.

**CAUTION: INVISIBLE LASER RADIATION WHEN OPEN AND INTERLOCKS DEFEATED. AVOID EXPOSURE TO BEAM.**

**VARNING: OSYNLIG LASERSTRÅLNING NÄR DENNA DEL ÄR ÖPPNAD STRÅLEN ÄR FARLIG.**

**Attention: Quand l'appareil est ouvert, ne pas s'exposer aux radiations invisibles du faisceau laser.**

This label is located on the interior.

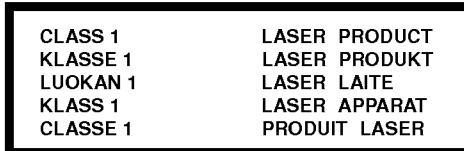

This Compact Disc player is classified as a CLASS 1 LASER product.

The CLASS 1 LASER PRODUCT label is located on the exterior.

This product is manufactured to comply with the radio interference requirements of EEC DIRECTIVE 89/336/EEC, 93/68/EEC and 73/23/EEC.

## Table of Contents

### INTRODUCTION

Precautions	2
Table of Contents	3
Before Use	4
Safety Precautions	4
Notes on Discs	4
Notes on Remote Control	4
Notes on Tapes	4
Front Panel/ Rear Panel	5
Remote Control	6
Display Window	6
Connections	7
Speaker System Connection	7
Antenna (Aerial) Connections	7

### BEFORE OPERATION

Setting the Voltage (OPTIONAL)	8
Setting the CLOCK	8
Sleep Function	8
Timer Function	9
Audio Adjustment	10
Volume Adjustment	10
Sound Quality Adjustment	10
MUTE	10
XDSS (Extreme Dynamic Sound System)	10
Reception of RDS (Radio Data System)	10
Stations - OPTIONAL	10
Auxiliary Function	10



### OPERATION

Presetting the radio stations	11
Listening to the radio	11
Tape Playback	12
Basic Playback	12
To Stop Play	12
Tape Counter Reset	12
To Play Rewind or Fast Forward	12
Recording	12
Basic Setting	12
Recording from Radio, CD or Auxiliary source	12
CD to Tape Synchronized Recording	12
CD Playback	13
Basic Playback	13
To Pause Play	13
To Stop Play	13
To Skipping the Track	13
To Searching the Track	13
To Repeat Play	13
To Program Play	13

### REFERENCE

Troubleshooting	14
Specifications	15

#### About the symbols for instructions

-  Indicates hazards likely to cause harm to the unit itself or other material damage.
-  Indicates special operating features of this unit.
-  Indicates tips and hints for making the task easier.

## Before Use

### Safety Precautions

#### Handling the unit

##### When shipping the unit

The original shipping carton and packing materials come in handy. For maximum protection, re-pack the unit as it was originally packed at the factory.

##### To keep the surface clean

Do not use volatile liquids, such as insecticide spray, near the unit. Do not leave rubber or plastic products in contact with the unit for a long period of time. They will leave marks on the surface.

#### Cleaning the unit

##### To clean the cabinet

Use a soft, dry cloth. If the surfaces are extremely dirty, use a soft cloth lightly moistened with a mild detergent solution. Do not use strong solvents, such as alcohol, benzene, or thinner, as these might damage the surface of the unit.

### Notes on Discs

#### Handling discs

Do not touch the playback side of the disc. Hold the disc by the edges so that fingerprints will not get on the surface. Do not stick paper or tape on the disc.



#### Storing discs

After playing, store the disc in its case. Do not expose the disc to direct sunlight or sources of heat, or leave it in a parked car exposed to direct sunlight, as there may be a considerable temperature increase inside the car.

#### Cleaning discs

Fingerprints and dust on the disc can cause poor picture quality and sound distortion. Before playing, clean the disc with a clean cloth. Wipe the disc from the center out.



Do not use strong solvents such as alcohol, benzene, thinner, commercially available cleaners, or anti-static spray intended for analog records.

### Notes on Remote Control

#### Remote Control Operation Range

Point the remote control at the remote sensor and press the buttons.

- **Distance:** About 23 ft (7 m) from the front of the remote sensor.
- **Angle:** About 30° in each direction of the front of the remote sensor.

#### Remote control battery installation

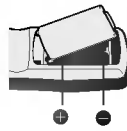

Detach the battery cover on the rear of the remote control, and insert two R03 (size AAA) batteries with + and - aligned correctly.

#### Caution

Do not mix old and new batteries. Never mix different types of batteries (standard, alkaline, etc.).

### Notes on Tapes

#### Preventing record

Removing the tab(s) of the cassette (with a small screwdriver) will prevent accidental erasure.

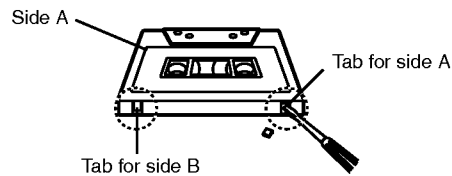

To record again, cover the hole of the tab with adhesive tape.

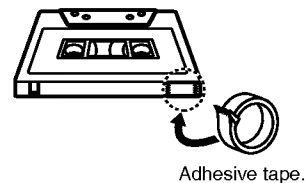

## Front Panel/Rear Panel

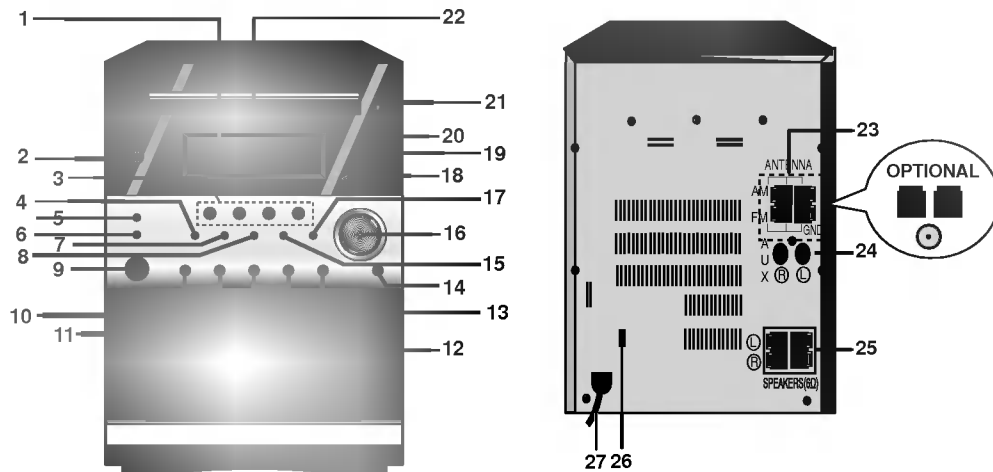

- |   |  |
|---|--|
| <ol style="list-style-type: none"> <li>1. DISPLAY</li> <li>2. POWER (⏻/STANDBY/ON) button</li> <li>3. FUNCTION SELECT button (TUNER/BAND, CD, TAPE, AUX)</li> <li>4. <ul style="list-style-type: none"> <li>• RDS button : OPTIONAL</li> <li>• CD PAUSE (CD   ) button</li> <li>• COUNTER RESET (COUNT.RESET) button: OPTIONAL</li> </ul> </li> <li>5. PROG./MEMO button</li> <li>6. <ul style="list-style-type: none"> <li>• PLAY MODE button : OPTIONAL</li> <li>• COUNTER RESET (COUNT.RESET) button : OPTIONAL</li> </ul> </li> <li>7. CD SYNC. button</li> <li>8. REPEAT button</li> <li>9. HEADPHONE SOCKET (🎧): ∅3.5mm</li> <li>10. <ul style="list-style-type: none"> <li>• PRESET buttons (TUNER)</li> <li>• BACKWARD PLAY (◀) button (TAPE) : OPTIONAL</li> <li>• PLAY (▶) button (TAPE, CD)</li> </ul> </li> <li>11. <ul style="list-style-type: none"> <li>• TUNING buttons (TUNER)</li> <li>• CD SKIP/SEARCH (◀◀◀/▶▶▶) buttons (CD)</li> </ul> </li> </ol> | <ol style="list-style-type: none"> <li>12. STOP (■)/CLEAR button</li> <li>13. TAPE DOOR(▲ PUSH OPEN) position</li> <li>14. RECORD/RECORD PAUSE (●/  ) button</li> <li>15. MODE/RIF button</li> <li>16. VOLUME CONTROL KNOB</li> <li>17. SET button</li> <li>18. XDSS button</li> <li>19. TIMER button</li> <li>20. CLOCK button</li> <li>21. CD OPEN/CLOSE (▲) button</li> <li>22. CD DOOR</li> <li>23. ANTENNA TERMINAL</li> <li>24. AUXILIARY INPUT SOCKET</li> <li>25. SPEAKER TERMINAL</li> <li>26. VOLTAGE SELECTOR : OPTIONAL</li> <li>27. POWER CORD</li> </ol> |
|---|--|

## Remote Control

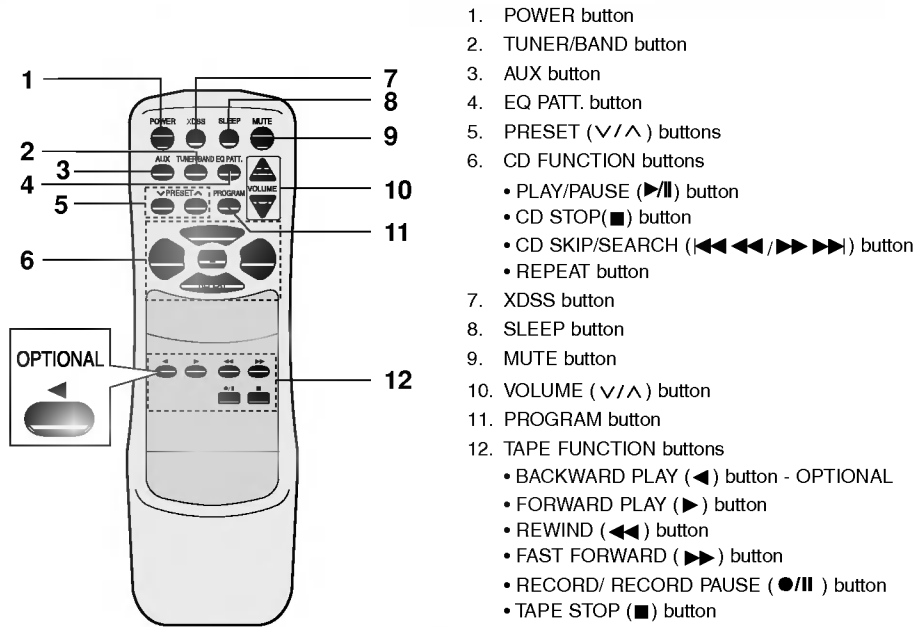

## Display Window

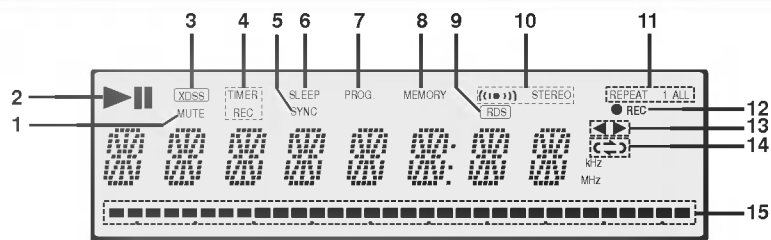

- |  |                                    |
|--|------------------------------------|
| 1. MUTE indicator                                | 10. FM STEREO indicator            |
| 2. CD PLAY/PAUSE indicator                       | 11. CD REPEAT indicator            |
| 3. XDSS (Extreme Dynamic Sound System) indicator | 12. RECORD/RECORD PAUSE indicator  |
| 4. TIMER indicator                               | 13. TAPE PLAY DIRECTION indicator  |
| 5. CD SYNCHRO RECORDING indicator                | 14. PLAY MODE indicator (OPTIONAL) |
| 6. SLEEP indicator                               | 15. VOLUME indicator               |
| 7. PROGRAM indicator                             |                                    |
| 8. MEMORY indicator                              |                                    |
| 9. RDS indicator (OPTIONAL)                      |                                    |

## Connections

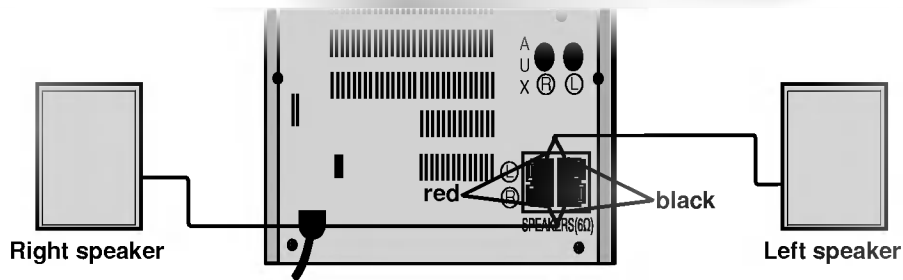

### Notes

- Be sure to match the speaker cord to the appropriate terminal on the components: + to + and – to –. If the cords are reversed, the sound will be distorted and will lack base.
- If you use front speakers with low maximum input rating, adjust the volume carefully to avoid excessive output on the speakers.
- Do not disassemble the front cover of supplied speaker.

### Antenna (Aerial) Connections

Connect the supplied FM/AM antennas for listening to the radio.

- Connect the AM loop antenna to the AM antenna connector.
- Connect the FM wire antenna (or FM "T" antenna) to the FM 75Ω coaxial/300Ω connector.

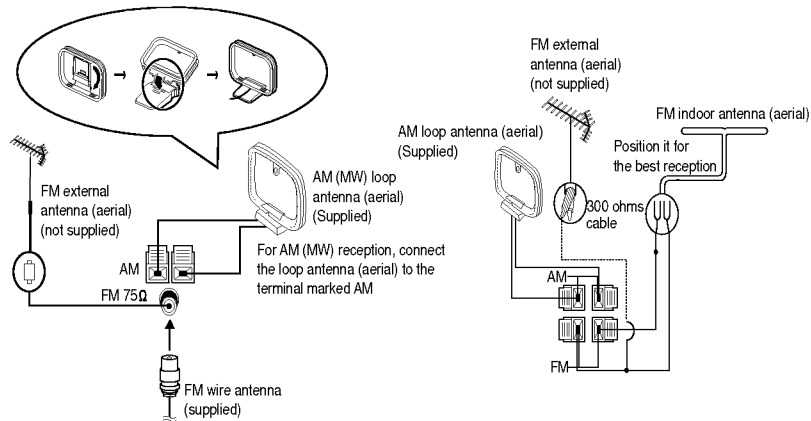

### Notes

- To prevent noise pickup, keep the AM loop antenna away from the unit and other components.
- Be sure to fully extend the FM wire antenna.
- After connecting the FM wire antenna, keep it as horizontal as possible.

## Setting the Voltage (OPTIONAL)

If your set is equipped with a voltage selector at the back side, be sure to set it to your local power supplied before connecting the AC power cord.

## Setting the CLOCK

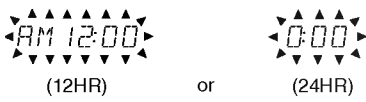
- 1** Press **CLOCK**.  
(If the clock requires setting, press and hold **CLOCK** for more than 2 seconds.)  
- The hours begin to flash.
- 2** Select a 24 hour cycle or 12 hour cycle by pressing **PRESET** buttons.  
  
(12HR) or (24HR)
- 3** Press **SET** to confirm the selected hour cycle.
- 4** Use **PRESET** buttons to set the correct hours.
- 5** Press **SET**.
- 6** Use **PRESET** buttons to set the correct minutes.
- 7** Press **SET** and the correct time is shown on the display.
- 8** Press **CLOCK** at any time to display the time for about 3 seconds.

## Sleep Function

When the sleep timer is used, the power is automatically turned off after the specified time has elapsed.

- 1** To specify the time delay before the power is turned off, press **SLEEP**.  
In the display window you can see **SLEEP 90** for about 5 seconds. This means that the system turns off automatically after 90 minutes.  
Each time the button is pressed the time interval before it turns off is reduced by 10 minutes. i.e. 80...70... etc.  
Select the desired time to turn off.
- 2** To check the remaining time until the power is turned off.  
While the sleep function is active press **SLEEP** briefly. The time remaining until it turns off is displayed for about 5 seconds.

### Note

If you press **SLEEP** while the sleep time is displayed, the **SLEEP** time is reset.

### To cancel the sleep timer mode

If you wish to stop the function, press the **SLEEP** button repeatedly until **SLEEP 10** appears, and then press **SLEEP** once again while **SLEEP 10** is displayed.



## Timer Function

The unit can set the clock function in power on/off state. With the TIMER function you can have the radio reception and recording, CD play, tape play or auxiliary source play and recording turned on and off at the time desired.

**1** Press **CLOCK** to check the current time.

### For your reference

If you don't set clock, timer function doesn't work.

**2** Press **TIMER** to enter the timer setting mode. TUNER-CD-TAPE flashes in the display window in turn.

### For your reference

If you want to correct the previous memorized TIMER setting, press and hold the TIMER button more than 2 seconds.

- The previous memorized timer on time and TIMER indicators appear in the display.

**3** Press **SET** when the desired function is flashing.

**4** 1. a. When you select the TUNER function, 'PLAY' and 'REC' indicator flash in the display window alternately for about 3 seconds.  
'PLAY' indicator : TUNER play only  
'REC' indicator : TUNER play and recording  
b. Select the previous memorized preset number with **PRESET** buttons and press **SET**.

- 'ON TIME' indicator appears for about 0.5 seconds in the display window and then disappears.

2. When you select the CD function,

- 'ON TIME' indicator appears for about 0.5 seconds in the display window and then disappears.

**5** Set the hour to switch on by pressing **PRESET** buttons.

**6** Press **SET** to confirm the hour to switch on.

**7** Set the minute to switch on by pressing **PRESET** buttons.

**8** Press **SET** to confirm the minute to switch on.

'OFF TIME' indicator appears for about 0.5 seconds in the display window and then disappears .

**9** Set the hour to switch off by pressing **PRESET** buttons.

**10** Press **SET** to confirm the hour to switch off.

**11** Set the minute to switch off by pressing **PRESET** buttons.

**12** Press **SET**.

**13** Adjust the volume level by pressing **PRESET** buttons.

**14** Press **SET**.  
'TIMER' appears in the display window and the timer setting has been completed.

**15** Switch the system off.  
The selected function is automatically switched on and off at the time set.

### To cancel or check the timer

Each time the TIMER button is pressed you can select the timer set or cancel. You can also check the timer setting status.

To activate or check the timer, press the **TIMER** button so that "TIMER" appears in the display window. To cancel the TIMER, press the **TIMER** button so that "TIMER" disappears in the display window.

## Audio Adjustment

### Volume Adjustment

- Turn **VOLUME CONTROL KNOB** clockwise to increase the sound level, or counterclockwise to decrease it.
- Press **VOLUME (^)** to increase the sound level, or press the **VOLUME (v)** to decrease it on the remote control.

### Sound Quality Adjustment

- **To activate stereo sound**  
You can choose between 4 fixed sound impressions. Select a desired sound mode by using the **EQ PATT.** button on the remote control.
  - FLAT : linear frequency response
  - ROCK : more bass, more treble
  - POP : less bass, less treble
  - CLASSIC : for orchestral music
- **Headphone Socket**  
Connect a stereo headphone plug (ø 3.5mm) into the headphone jack.  
The speakers are automatically disconnected when you plug in the headphones (not supplied).

### MUTE

Press **MUTE** to mute your unit.  
You can mute your unit in order, for example, to answer the telephone, "MUTE" indicator flashes in the display window.

### XDSS (Extreme Dynamic Sound System)

Press **XDSS** to reinforce treble, bass and surround effect.  
The "XDSS ON" or "XDSS OFF" indicator lights up.  
To cancel it press **XDSS** again.

### Reception of RDS (Radio Data System) Stations - OPTIONAL

#### **What is RDS?**

RDS (Radio Data System) is a system gradually being introduced on FM in many countries, where by an inaudible stream of data is transmitted in addition to the normal radio signal. This data contains various information including station/ transmitter identification, traffic information and a list of alternative frequencies for the radio station being received.

**1** Press **TUNER/BAND** to select **FM**.

**2** Select a desired station by pressing **TUNING** buttons.

When the RDS transmission is received, the display shows the program service name (PS) after RDS indicator appears.

**3** Press the **RDS** to recall the frequency.

#### **N**otes

- RDS is only available for FM reception.
- The PS (PROGRAM SERVICE) NAME is displayed automatically when a RDS station is received .

## Auxiliary Function

**1** Connect an auxiliary device i.e. TV or VCR, via the rear mounted **AUX** phone sockets.

**2** Press **AUX**.

#### **N**ote

You can also record from the auxiliary input source, see Recording Section.

## Presetting the radio stations

You can preset 30 stations for FM and AM. Before tuning, make sure that you have turned down the volume to the minimum.

**1** Press **TUNER/BAND** to select the frequency (AM or FM) you want.  
Every time you press this button, AM and FM changes alternately.

**2** Press **TUNING** buttons on the front panel until the frequency indication starts to change.

### Notes

#### • Tuning in automatically

Press **TUNING** buttons for more than 0.5 seconds.  
- Scanning stops when the unit tunes in a station.

#### • Tuning in manually

Press **TUNING** buttons briefly and repeatedly.

**3** Press **PROG./MEMO** (or **PROGRAM** on the remote control).  
A preset number will flash in the display window.

**4** Press **PRESET** buttons (or **PRESET (∇/∧)** on the remote control) to select the preset number you want.

**5** Press **PROG./MEMO** (or **PROGRAM** on the remote control) again.  
- The station is stored.

**6** Repeat steps 2 to 5 to store other stations.

#### To clear all the memorized stations

Press and hold **PROG./MEMO** on the front panel for about two seconds, "CLEAR" appears in the display window and then press **CLEAR**, the stations are cleared.

#### For your reference

If all stations have already been entered, FULL message will appear in the display window for a moment and then a preset number will flash. To change the preset number, follow the steps 4-5.

#### To recall presets

Press and hold **PRESET** buttons (or **PRESET (∇/∧)** on the remote control) until the desired preset number appears or press it repeatedly.

## Listening to the radio

**1** Press **TUNER/BAND** to select the frequency (AM or FM) you want.  
Every time you press this button, AM and FM changes alternately.  
The last received station is tuned in.

**2** Press **PRESET** buttons (or **PRESET (∇/∧)** on the remote control) repeatedly to select the preset station you want.  
- Each time you press the button, the unit tunes in one preset station at a time.

**3** Adjust the volume by rotating **VOLUME CONTROL KNOB** (or pressing **VOLUME (∇/∧)** on the remote control) repeatedly.

#### To listen to non-preset radio stations

- Use manual or automatic tuning in step 2.
- For automatic tuning, press and hold **TUNING** buttons on the front panel.

#### To turn off the radio

Press **POWER** to turn the unit off or select another function mode (CD, TAPE or AUX).

#### For your reference

- **If an FM program is noisy**  
Press **MODE/RIF** so that "STEREO" disappears in the display window. There will be no stereo effect, but the reception will improve. Press **MODE/RIF** again to restore the stereo effect.
- **To improve reception**  
Reposition the supplied antennas.

### Notes

- Use **MODE/RIF** (Radio Interference Filter) function to switch to mono reception if stereo reception is distorted by noise.
- When recording the MW(AM) or LW broadcast, beat noises may occur. If it does, press **MODE/RIF** once.

## Tape Playback

You can use only normal tape.

### Basic Playback

- 1 Press **TAPE** to select tape function.  
("NO TAPE" appears in the display window.)
- 2 Open cassette deck by pushing **TAPE DOOR** (**▲** PUSH OPEN) position.
- 3 Insert a cassette with the tape side to the bottom and then close deck.
- 4 Press **PLAY** (**▷** or **◁**: OPTIONAL) on the front panel or **PLAY** (**▷** or **◁**: OPTIONAL) on the remote control.

### To Stop Play

Press **STOP** (**■**) during playback.

### Tape Counter Reset

Press **COUNTER RESET**(**COUNT. RESET**) during playback.  
Playing time appears "TP - 0000" in display window.

### To Play Rewind or Fast Forward

After pressing **◀◀◀◀/▶▶▶▶** on the front panel or **◀◀/▶▶** on the remote control during playback, or stop.

### AUTO STOP DECK

After auto stop deck plays only front side, the unit stops automatically.

### AUTO REVERSE DECK:OPTIONAL

You can select direction of the cassette you want by pressing **PLAY MODE**.

Pressing	Display	Function
Once	↔	After the cassette plays front or reverse (backward play) side, stops automatically.
Twice	↔↔	After the cassette plays front and reverse side, stops automatically.
Three times	(↔↔)	After the cassette plays six times repeatedly front and reverse side, stops automatically.

## Recording

Wind the tape to the point recording starts. (Use only normal tapes.)

### Basic Setting

- 1 Select the function (CD, TUNER/BAND or AUX) you want to record.
- 2 Open the cassette deck and insert a blank cassette into the cassette compartment.  
To set the recording direction :OPTIONAL  
Press **PLAY MODE** repeatedly to set the recording direction.

### Recording from Radio, CD or Auxiliary source

- 1 Press **●/||** on the front panel or the remote control and then select the CD, TUNER or AUX function.  
"●REC" flashes and holds the cassette in pause mode.
- 2 Press **●/||** or **PLAY**(**▷**) on the front panel or the remote control.  
The recording begins.

### To pause recording

Press **●/||** during recording.  
- "●REC" flashes in display window.

### To stop recording

Press **TAPE STOP**(**■**).

### CD to Tape Synchronized Recording

The CD synchro recording function dubs a complete CD and programmed titles automatically into a cassette.

- 1 Press **CD SYNC.** in stop mode.  
"●REC" flashes and "CD SYNC" displays in the display window.
- 2 The synchronized recording is started automatically after about 8 seconds.

### Notes

- If you wish to record from the desired track, select the desired track with **CD SKIP/SEARCH** (**◀◀◀◀** / **▶▶▶▶**) before commencing CD synchro recording.
- The function change is not possible during recording.

## CD Playback

### Basic Playback

**1** Press CD to select CD function.  
If no disc is loaded then "NO DISC" is displayed.

**2** Press CD OPEN/CLOSE (▲) and place the disc into the disc tray.

#### **N** Note

To load an 8cm(3 inch) disc, put it onto the inner circle of the tray.

**3** Press CD OPEN/CLOSE (▲) to close the disc compartment.

**4** Press PLAY (▷) (or PLAY/PAUSE (▶||)) on the remote control).

### To Pause Play

Press CD PAUSE (CD ||) or PLAY/ PAUSE (▶||) on the remote control during playback.

Press this button again it to resume play.

### To Stop Play

Press STOP(■) during playback.

### To Skipping the Track

- Press the CD SKIP/SEARCH (|◀◀◀/▶▶▶|) button to go to the next track.
- When the CD SKIP/SEARCH (|◀◀◀/▶▶▶|) button is pressed once midway through a track, the player returns to the start of that track. When it is pressed again, a track is skipped each time the button is pressed.

### To Searching the Track

After pressing |◀◀◀/▶▶▶| on the front panel or the remote control during playback, press PLAY (▷) at the point you want.

### To Repeat Play

#### **To play one track repeatedly**

Press REPEAT once during playback.  
- "REPEAT 1" appears in the display.

#### **To play all tracks repeatedly**

Press REPEAT again during playback.  
- "REPEAT ALL" appears in the display.

#### **To cancel repeat play**

Press REPEAT once more during playback.  
- "Repeat indicator" disappears.

### To Program Play

You can arrange the order of the tracks on the discs and create your own program. The program can contain up to 20 tracks.

**1** Press PROG./MEMO (or PROGRAM on the remote control) on the stop mode.

**2** Press |◀◀◀/▶▶▶| to select the track.

**3** Press PROG./MEMO (or PROGRAM on the remote control).

**4** Repeat 1~3.

**5** Press PLAY(▷) (or PLAY/ PAUSE (▶||)) on the remote control).

### To check program contents

Press PROG./MEMO (or PROGRAM on the remote control) on the stop mode.

- A track and program number will be displayed.

### To clear program contents

Press PROG./MEMO (or PROGRAM on the remote control) on the stop mode. And then press CLEAR on the front panel or STOP(■) on the remote control.

### To add program contents

1. Press PROG./MEMO (or PROGRAM on the remote control) repeatedly on the program stop mode until "Track Number" blinks.
2. Repeat 2~5.

### To modify program contents

1. Press the PROG./MEMO (or PROGRAM on the remote control) to display program number you want to modify.
2. Repeat 2~4.

#### **N**ote

In addition, this unit can play a CD-R or CD-RW that contains audio titles.

## Troubleshooting

Check the following guide for the possible cause of a problem before contacting service.

Symptom	Cause	Correction
No power.	<ul style="list-style-type: none"> <li>The power cord is disconnected.</li> </ul>	<ul style="list-style-type: none"> <li>Plug the power cord into the wall outlet securely.</li> </ul>
No sound.	<ul style="list-style-type: none"> <li>The audio cables are not connected securely.</li> </ul>	<ul style="list-style-type: none"> <li>Connect the audio cable into the jacks securely.</li> </ul>
	<ul style="list-style-type: none"> <li>The power of the external source equipment is switched off.</li> </ul>	<ul style="list-style-type: none"> <li>Switch on the external source equipment.</li> </ul>
	<ul style="list-style-type: none"> <li>The speaker cable is set to the wrong position.</li> </ul>	<ul style="list-style-type: none"> <li>Set the speaker cable to the correct position, then turn on the unit again by pressing POWER.</li> </ul>
The unit does not start playback.	<ul style="list-style-type: none"> <li>No disc is inserted.</li> </ul>	<ul style="list-style-type: none"> <li>Insert a disc.</li> </ul>
	<ul style="list-style-type: none"> <li>An unplayable disc is inserted.</li> </ul>	<ul style="list-style-type: none"> <li>Insert a playable disc.</li> </ul>
	<ul style="list-style-type: none"> <li>The disc is placed upside down.</li> </ul>	<ul style="list-style-type: none"> <li>Place the disc with the playback side down.</li> </ul>
	<ul style="list-style-type: none"> <li>The disc is not placed within the guide.</li> </ul>	<ul style="list-style-type: none"> <li>Place the disc on the disc tray correctly inside the guide.</li> </ul>
	<ul style="list-style-type: none"> <li>The disc is dirty.</li> </ul>	<ul style="list-style-type: none"> <li>Clean the disc.</li> </ul>
The remote control does not work properly.	<ul style="list-style-type: none"> <li>The remote control is not pointed at the remote sensor of the unit.</li> </ul>	<ul style="list-style-type: none"> <li>Point the remote control at the remote sensor of the unit.</li> </ul>
	<ul style="list-style-type: none"> <li>The remote control is too far from the unit.</li> </ul>	<ul style="list-style-type: none"> <li>Operate the remote control within about 23 ft (7 m).</li> </ul>
	<ul style="list-style-type: none"> <li>There is an obstacle in the path of the remote control and the unit.</li> </ul>	<ul style="list-style-type: none"> <li>Remove the obstacle.</li> </ul>
	<ul style="list-style-type: none"> <li>The batteries in the remote control are exhausted.</li> </ul>	<ul style="list-style-type: none"> <li>Replace the batteries with new ones.</li> </ul>

## Specifications

SECTION		MODEL	LX-220A/D/X	LX-221A/D/X
[General]	Power supply	Refer to the back panel of the unit.		
	Power consumption	60W		
	Mass	4.8kg		
	External dimensions (WxHxD)	180 X 248 X 247mm		
[CD]	Frequency response	40 - 18000 Hz		
	Signal-to-noise ratio	70 dB		
	Dynamic range	70 dB		
[Tuner]	FM	Tuning Range	87.5 - 108.0 MHz or 65 - 74 MHz, 87.5 - 108.0 MHz	
		Intermediate Frequency	10.7 MHz	
		Signal to Noise Ratio	60/55 dB	
		Frequency Response	60 - 10000 Hz	
	AM (MW)	Tuning Range	522 - 1611 kHz or 530 - 1610 kHz	
		Intermediate Frequency	450 kHz	
		Signal to Noise Ratio	35 dB	
		Frequency Response	100 - 1800 Hz	
[Amp]	Output Power	10W + 10W		
	T.H.D	0.15%		
	Frequency Response	42 - 25000 Hz		
	Signal-to-noise ratio	80 dB		
[TAPE]	Tape Speed	4.75cm/sec		
	Wow Flutter	0.25% (MTT -111, JIS-WTD)		
	F.F/REW Time	120sec (C-60)		
	Frequency Response	250 - 8000Hz		
	Signal to Noise Ratio	43dB		
	Channel Separation	50dB(P/B)/45dB(R/P)		
	Erase Ratio	55dB (MTT-5511)		
[Speakers]		<b>LXS-220</b>	<b>LXS-221</b>	
	Impedance	6 Ω	6 Ω	
	Frequency Response	70 - 20000 Hz	70 - 18000 Hz	
	Sound Pressure Level	86 dB/W (1m)	86 dB/W (1m)	
	Rated Input Power	20 W	20 W	
	Max. Input Power	40 W	40 W	
	Net Dimensions (WxHxD)	170 x 286 x 226.5 mm	160 x 248 x 175 mm	
	Net Weight (1EA)	2.85 kg	2.35 kg	

\* Designs and specifications are subject to change without notice.



P/NO :3828R-A027G