



LCD Colour Television **OWNER'S MANUAL**

Please read this manual carefully before operating your set.
Retain it for future reference.
Record model number and serial number of the set.
See the label attached on the back cover and quote this
information to your dealer when you require service.

Model number :
Serial number :



Contents

Installation	3
Location and function of controls	4
Remote control handset	
Battery installation / Front panel / Back panel	
Basic operation	8
On and off / Programme selection	
Volume adjustment	
Quick view / Mute function	
On screen language selection (option)	
On Screen Menus	9
Menu selection	
CHANNEL Menu	10
Auto programme tuning	
Manual programme tuning	
Fine tuning / Programme edit	
Calling the programme table	
PICTURE Menu	15
PSM (Picture Status Memory)	
CSM (Colour Status Memory)	
Manual Colour Temperature Control	
Picture adjustment	
SOUND Menu	17
SSM (Sound Status Memory)	
AVL (Auto Volume Leveler) / Sound adjustment	
Stereo/Dual reception / NICAM reception	
Sound output selection	
TIME menu	19
Clock / On/Off Time / Auto sleep / Sleep timer	
SPECIAL Menu	21
Child lock / Orbiter	
SCREEN Menu	22
Auto adjustment (RGB [PC] mode only) / Picture format	
Picture Size Zoom / Screen Position (RGB [PC] mode only)	
Manual Configure (RGB [PC] mode only)	
Screen adjustments	
Initializing (Reset to original factory value)	
Selecting Wide XGA mode (RGB, [PC] mode only)	
YNR (Y-signal Noise Reduction) / Split Zoom	
PIP/DW operation	26
Main Picture Source Selection / Auto AV switching	
Main Picture Size Adjustment / On and Off	
Input mode selection for sub picture	
Sub Picture Size / Moving the Sub Picture	
PIP Aspect Ratio	
Swapping between main and sub pictures	
Program selection for sub picture	
Teletext (option)	29
Switch on/off / SIMPLE text / TOP text (option)	
FASTEXT / Special teletext functions	
Connection of external equipment	32
Aerial socket / Euro scart sockets	
S-Video/Audio in sockets (S-Video)	
PC in socket	
Mounting speakers on the Set	
Displayable Monitor Specification	35
RGB Mode / DVI Mode	
External Control Device Setup	37
RS-232C input socket / D-Sub 9-pin male	
Set ID / Communication Parameters	
Command Reference List	
Transmission/Receiving Protocol	
Troubleshooting check list	43

Installation

Power

This set operates on an AC mains supply, the voltage is as indicated on the label on the back cover. Never apply DC power to the set. In the event of thunderstorms or powercuts, please pull out the aerial and mains plugs.

Warning

To prevent fire or shock hazard, do not expose the set to rain or moisture. Do not rub or strike the Active Matrix LCD with anything hard as this may scratch, mar, or damage the Active Matrix LCD permanently.

Service

Never remove the back cover of the set as this can expose you to high voltage and other hazards. If the set does not operate properly, unplug it and call your dealer.

Aerial

Connect the aerial cable to the socket marked 1175 Ω on the back. For the best reception an outdoor aerial should be used.

Location

Position your set so that no bright light or sunlight falls directly onto the screen. Care should be taken not to expose the set to any unnecessary vibration, moisture, dust or heat. Also ensure that the set is placed in a position to allow a free flow of air. Do not cover the ventilation openings on the back cover.

When you install the set to use the wall mounting bracket (optional parts), fix it carefully so as not to drop.

Cleaning

Unplug the set before cleaning the face of the LCD Screen. Dust the set by wiping the screen and the cabinet with a soft, clean cloth. If the screen requires additional cleaning, use a clean, damp cloth. Do not use liquid cleaners or aerosol cleaners.

Location and function of controls

All the functions can be controlled with the remote control handset. Some functions can also be adjusted with the buttons on the front panel of the set.

Remote control handset

Before you use the remote control handset, please install the batteries. See the next page.

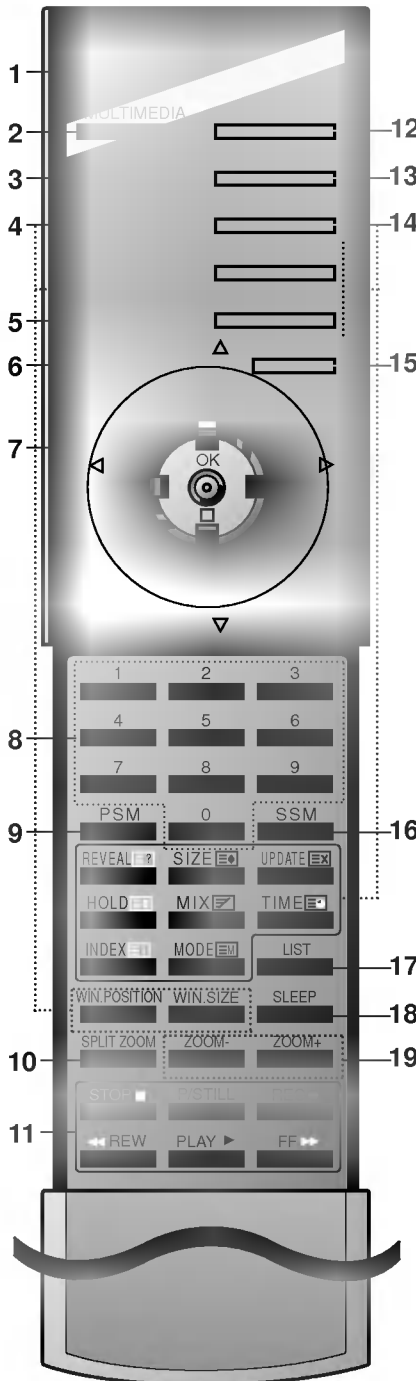

1. **POWER**
switches the set on from standby or off to standby.
2. **MULTIMEDIA**
selects **RGB** or **DVI** modes.
3. **ARC (Aspect Ratio Control)**
changes the picture format.
4. **PIP BUTTONS**
PIP/DW
switches the sub picture on or off.
PR +/-
selects a programme for the sub picture.
SWAP
alternates between main and sub picture.
PIP INPUT
selects the input mode for the sub picture.
WIN.SIZE
adjusts the sub picture size.
WIN POSITION
moves the sub picture to ▲ / ▼ or ◀ / ▶ direction.
5. **SWAP**
returns to the previously viewed programme.
6. **MENU**
selects a menu.
7. **▲ / ▼ (Programme Up/Down)**
selects a programme or a menu item.
switches the set on from standby.
◀ / ▶ (Volume Up/Down)
adjusts the volume.
adjusts menu settings.
- OK**
accepts your selection or displays the current mode.
8. **NUMBER BUTTONS**
switches the set on from standby or directly select a number.
9. **PSM (Picture Status Memory)**
recalls your preferred picture setting.
10. **SPLIT ZOOM**
Enlarge the screen with regular ration.
11. **VCR BUTTONS**
control a LG video cassette recorder.

Location and function of controls

12. INPUT SELECT

selects the remote operating mode.
switches the set on from standby.

13. I/II

selects the language during dual language broadcast.
selects the sound output.

14. TELETEXT BUTTONS

These buttons are used for teletext.
For further details, see the 'Teletext' section.

15. MUTE

switches the sound on or off.

16. SSM (Sound Status Memory)

recalls your preferred sound setting.

17. LIST

displays the programme table.

18. SLEEP

sets the sleep timer.

19. ZOOM+ / ZOOM-

Enlarges or reduces the main picture size.

Note : In teletext mode, the **PR +/-**, **SWAP** and **PIP INPUT** buttons are used for teletext function.

Battery installation

The remote control handset is powered by two AAA type batteries. To load the batteries, turn the remote control handset over and open the battery compartment. Install two batteries as indicated by the polarity symbols (⊕ and ⊖) marked inside the compartment.

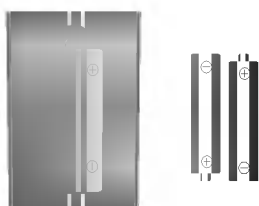

Note : To avoid damage from possible battery leakage, remove the batteries if you do not plan to use the remote control handset for an extended period of time.

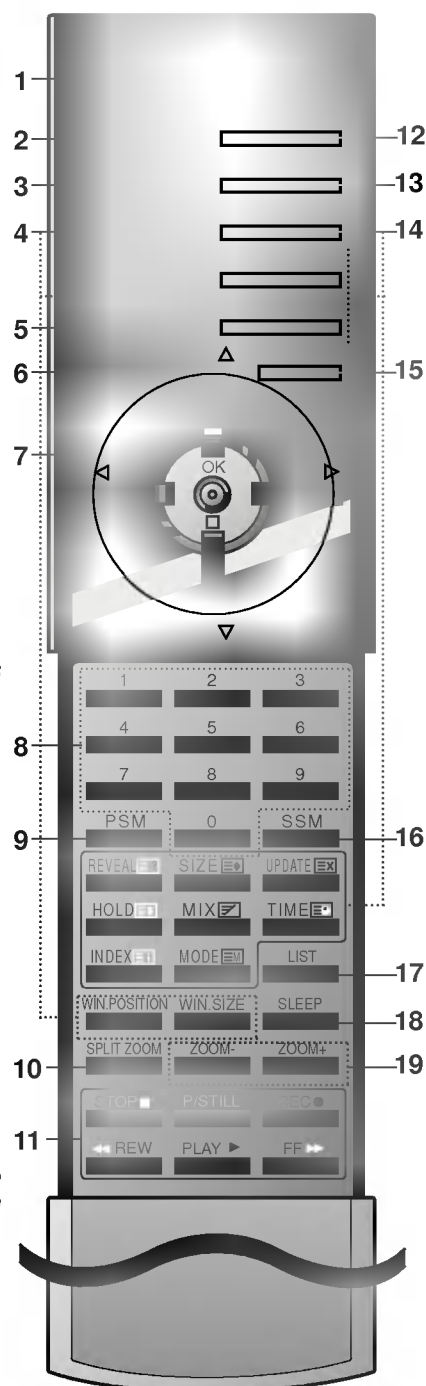

Location and function of controls

Front panel

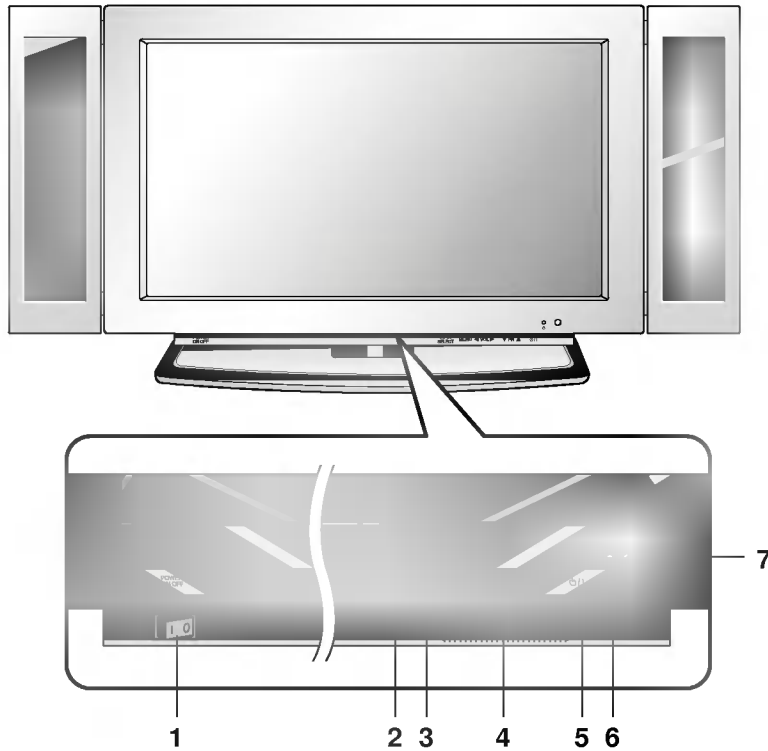

- | | |
|---|---|
| 1. MAIN POWER (ON OFF)
switches the set on or off. | 5. POWER (⏻/⏻)
switches the set on from standby or off to standby. |
| 2. INPUT SELECT
selects TV, AV1, AV2, AV3, S-Video, RGB or DVI mode.
switches the set on from standby. | 6. POWER/STANDBY INDICATOR (⦿)
illuminates red in standby mode.
illuminates green when the set is switched on. |
| 3. MENU
selects a menu. | 7. REMOTE CONTROL SENSOR |
| 4. ◀ / ▶ (Volume Down/Up)
adjusts the volume.
adjusts menu settings.
▲ / ▼ (Program Up/Down)
selects a program or a menu item.
switches the set on from standby. | |

Location and function of controls

Back panel

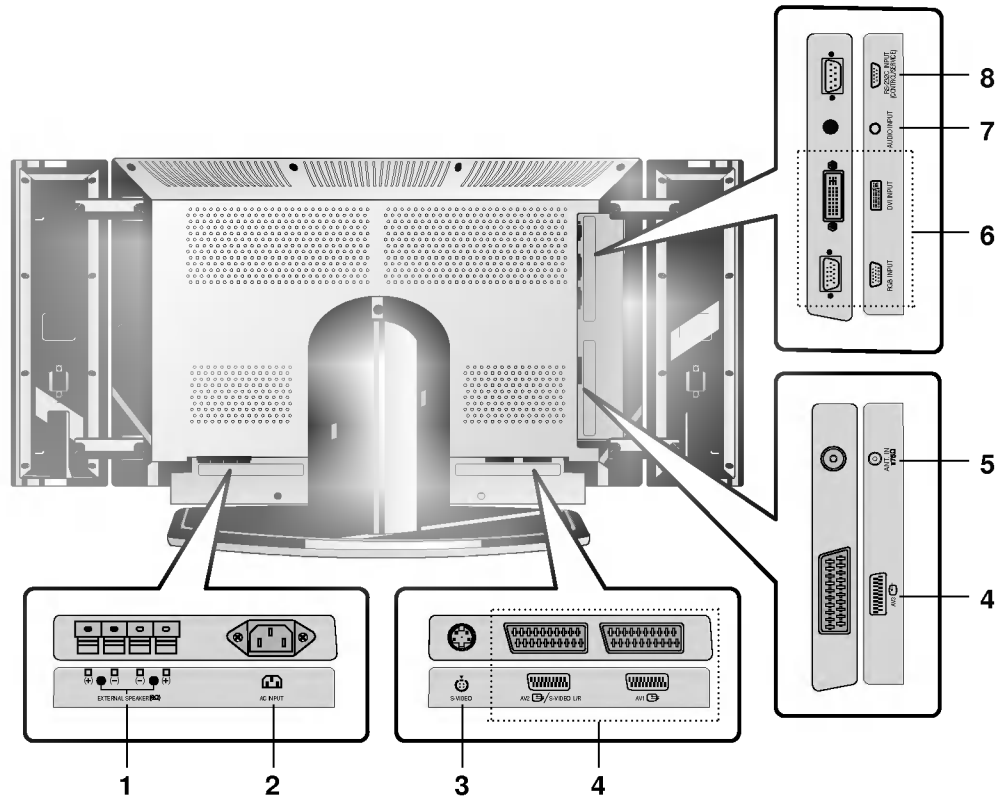

- 1. EXTERNAL SPEAKER (6 ohm output)**
connect to optional external speaker(s).
- 2. POWER CORD SOCKET**
- 3. S-VIDEO INPUT**
connect video out from an S-VIDEO VCR to the S-VIDEO input.
- 4. EURO SCART SOCKET**
connect the euro scart socket of the VCR to these sockets.
- 5. AERIAL SOCKET**
connect the RF socket of the VCR to the aerial socket.
- 6. RGB INPUT / DVI (Digital Visual Interface) INPUT**
connect the set output socket of the PERSONAL COMPUTER to this socket.
Note : This set is only provided the DVI-D function although DVI jack drawing is DVI-I jack for connection convenience.
- 7. AUDIO INPUT**
connect audio out from external equipment to these jack.
- 8. RS-232C INPUT (CONTROL/SERVICE) PORT**
connect to the RS-232C port on a PC.

Basic Operation

On and off

1. Press the main power button to switch the set on.
2. If the set is in standby mode, press the **POWER**, **▲ / ▼**, **MULTIMEDIA**, **INPUT SELECT** or **NUMBER** buttons on the remote control handset to switch it on fully.
3. Press the **POWER** button on the remote control handset. The set reverts to standby mode.
4. Press the main power button again to switch the set off.

Note : If, while the set is switched on, the mains plug is disconnected the set will switch to standby or power on when the mains plug is replaced in the mains power socket.

Programme selection

You can select a programme number with the **▲ / ▼** or **NUMBER** buttons.

Volume adjustment

Press the **◀ / ▶** button to adjust the volume.

Quick view

Press the **SWAP** button to view the last programme you were watching.

Mute function

Press the **MUTE** button. The sound is switched off and the display  appears.

You can cancel it by pressing the **MUTE**, **◀ / ▶**, **I/II** or **SSM** button.

On screen language selection (option)

The menu can be displayed on the screen in your desired language. First select your language.

1. Press the **MENU** button and then **▲ / ▼** button to select the **SPECIAL** menu.
2. Press the **▶** button and then **▲ / ▼** button to select **Language**.
3. Press the **▶** button and then the **▲ / ▼** button to select your desired language. All the on screen displays will appear in the selected language.
4. Press the **MENU** button to save.

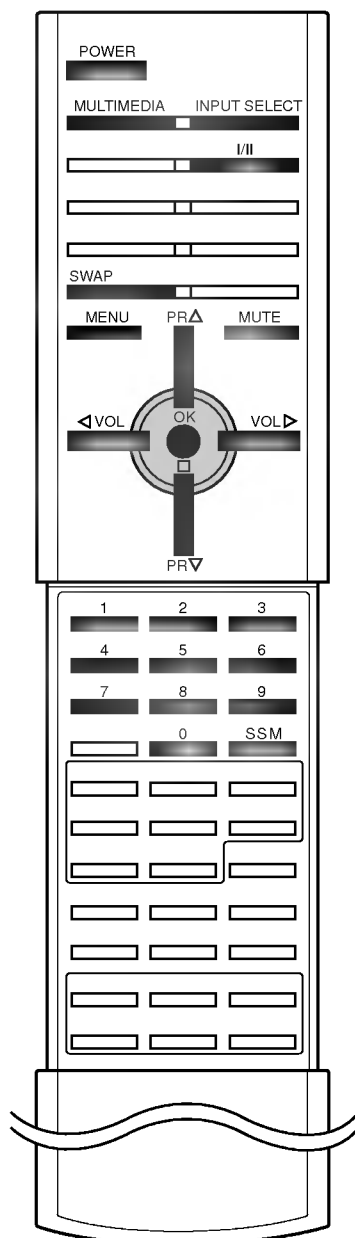

On Screen Menus

The dialogue between you and your set takes place on screen with an operator menu.

Menu selection

1. Press the **MENU** button and then ▲ / ▼ button to display each menu.
2. Press the ► button and then the ▲ / ▼ button to select a menu item.
3. Repeatedly press the **MENU** button to return to normal TV viewing.

Note :

- a. In the AV or RGB mode, the **CHANNEL** menu is not displayed.
- b. In the teletext mode, menus are not displayed.
- c. On some models, the **Language** will not be displayed.

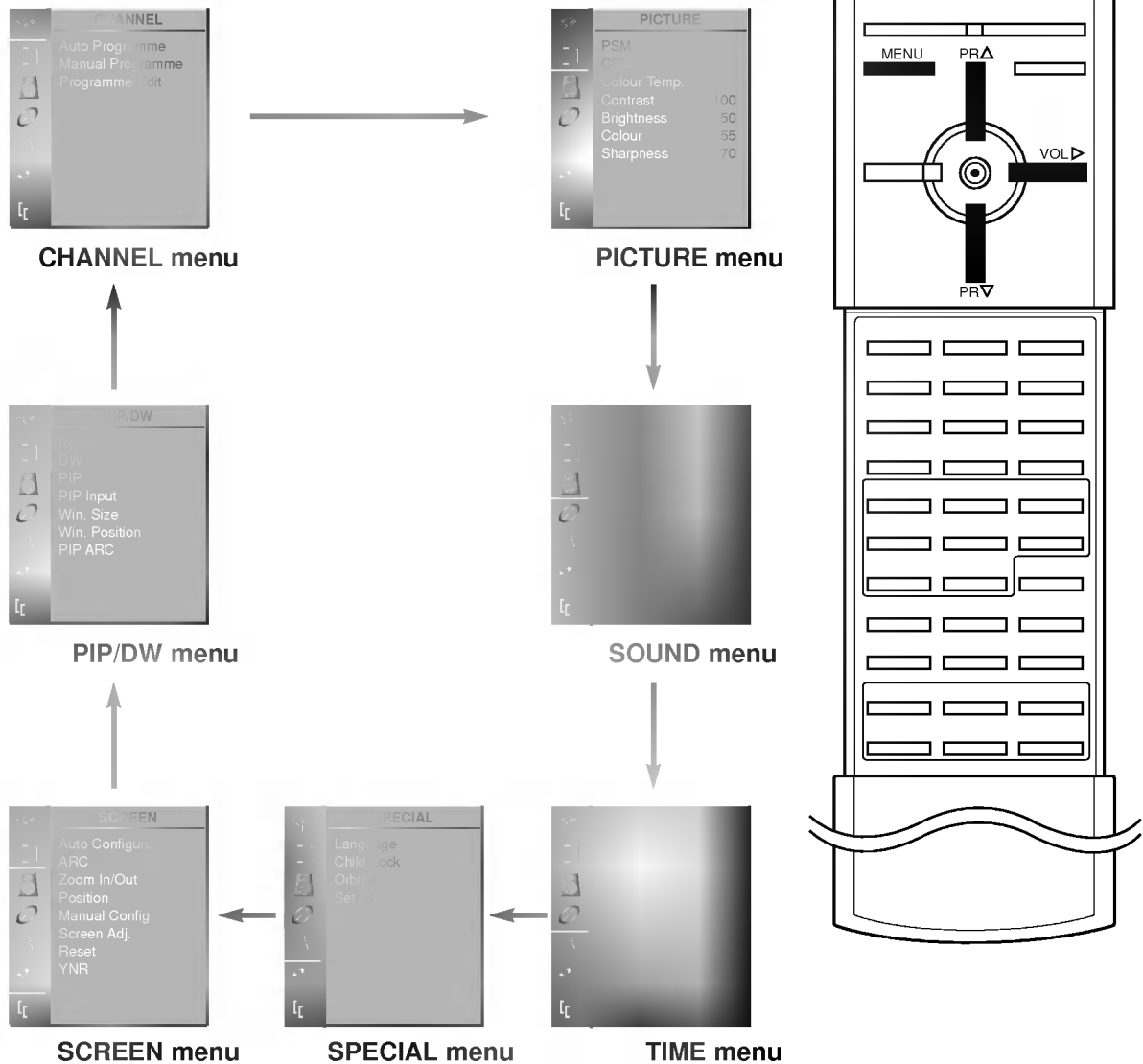

CHANNEL Menu



CHANNEL menu

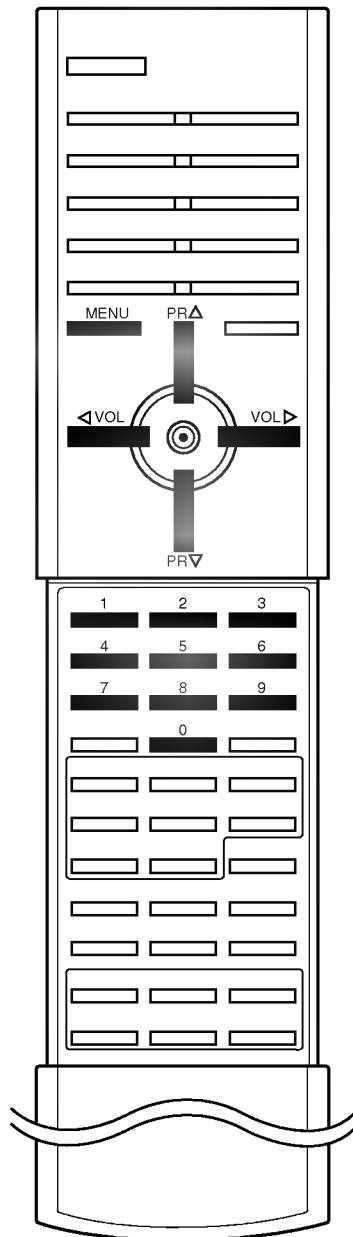

Up to 100 TV stations can be stored in this set by programme numbers (0 to 99). Once you have preset the stations, you will be able to use the ▲ / ▼ or NUMBER buttons to scan the stations you programmed.

Stations can be tuned using automatic or manual modes.

Auto programme tuning

All stations that can be received are stored by this method. It is recommended that you use auto program during installation of this set.

1. Press the **MENU** button and then ▲ / ▼ button to select the CHANNEL menu.
2. Press the ► button and then ▲ / ▼ button to select **Auto Programme**.

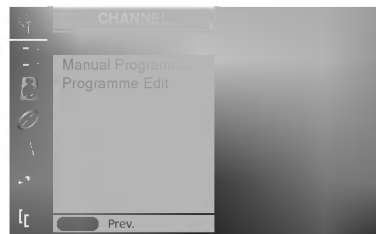

3. Press the ► button to select **System**. Select a TV system with the ◀ / ▶ button;
 - L** : SECAM L/L' (France)
 - BG** : PAL B/G, SECAM B/G (Europe/East Europe)
 - I** : PAL I/II (U.K./Ireland)
 - DK** : PAL D/K, SECAM D/K (East Europe)
4. Press the ▼ button to select **Storage**. Select the beginning programme number with the ◀ / ▶ button or NUMBER buttons on the **Storage** menu.
5. Press the ▼ button to select **Start**.
6. Press the ► button to begin auto programming.

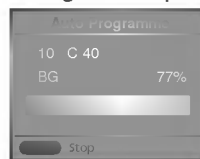

All receivable stations are stored. The station name is stored for stations which broadcast VPS (Video Programme Service), PDC (Programme Delivery Control) or TELETEXT data. If no station name can be assigned to a station, the channel number is assigned and stored as **C** (V/UHF 01-69) or **S** (Cable 01-47), followed by a number.

To stop auto programming, press the **MENU** button.

When auto programming is completed, the **Programme edit** menu appears on the screen. See the 'Programme edit' section to edit the stored programme.

7. Repeatedly press the **MENU** button to return to normal TV viewing.

CHANNEL Menu

Manual programme tuning

Manual programme lets you manually tune and arrange the stations in whatever order you desire. Also you can assign a station name with five characters to each programme number.

1. Press the **MENU** button and then **▲ / ▼** button to select the CHANNEL menu.
2. Press the **▶** button and then **▲ / ▼** button to select **Manual Programme**.

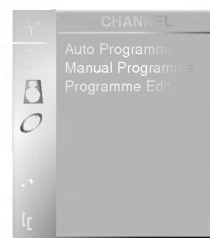

CHANNEL menu



3. Press the **▶** button to display the **Storage**. Select the beginning programme number with the **◀ / ▶** button or NUMBER buttons on the **Storage** menu. Any number under 10 is entered with a numeric '0' in front of it, i.e. '05' for 5.
4. Press the **▼** button to select **System**.
5. Select a TV system with the **◀ / ▶** button;
 - L** : SECAM L/L' (France)
 - BG** : PAL B/G, SECAM B/G (Europe/East Europe)
 - I** : PAL I/II (U.K./Ireland)
 - DK** : PAL D/K, SECAM D/K (East Europe)
6. Press the **▼** button to select **CH.**
7. Press the **◀ / ▶** button to select **V/UHF** or **Cable** as required. You can select the desired channel number with the NUMBER buttons. If possible, select the channel number(1 to 69) directly with the number buttons.
8. Press the **▼** button to select **Search**.
9. Press the **◀ / ▶** button to commence searching. If a station is found the search will stop.
10. Press the **OK** button to store it.
11. To store another station, repeat steps 3 to 10.
12. Repeatedly press the **MENU** button to return to normal TV viewing.

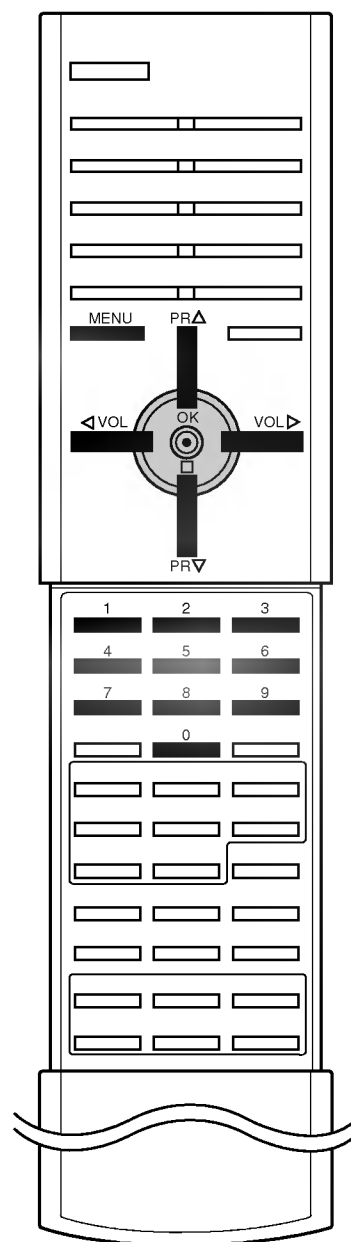

CHANNEL Menu



CHANNEL menu

Assigning a station name

1. Repeat the 'Manual programme tuning' steps 1 to 2.
2. Press the ► button and then ▲ / ▼ button to select **Name**.
3. Press the ▲ button. You can use a blank, +, -, the alphabet **A** to **Z** and the numeric **0** to **9**.
With the ▼ button you can select in the opposite direction.
4. Select the next position by pressing the ► button and then take your choice of the second character, and so on.
5. Press the **OK** button.
6. Repeatedly press the **MENU** button to return to normal TV viewing.

Fine tuning

Normally fine tuning is only necessary if reception is poor.

1. Repeat the 'Manual programme tuning' steps 1 to 2.
2. Press the ► button and then ▲ / ▼ button to select **Fine**.
3. Press the ◀ / ▶ button to fine tune for the best picture and sound.



4. Press the **OK** button.
5. Repeatedly press the **MENU** button to return to normal TV viewing.
The finely tuned programme will be indicated by yellow number during programme selection.

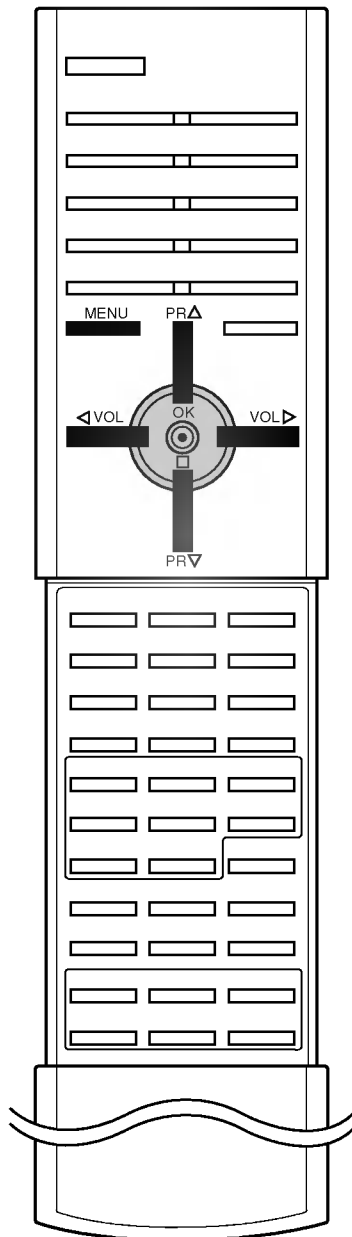

CHANNEL Menu

Programme edit

This function enables you to delete or skip the stored programmes. Also you can move some stations to other programme numbers or copy a blank station data into the selected programme number.

1. Press the **MENU** button and then use **▲ / ▼** button to select the CHANNEL menu.
2. Press the **▶** button and then **▲ / ▼** button to select **Programme Edit**.
3. Press the **▶** button to display the **Programme Edit** menu.

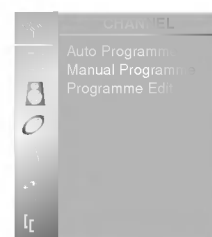

CHANNEL menu

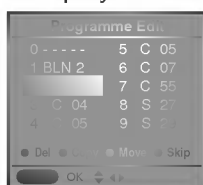

Deleting a programme

1. Select a programme to be deleted with the **▲ / ▼** or **◀ / ▶** button.
2. Press the **RED** button twice.
The selected programme is deleted, all the following programmes are shifted up one position.

Copying a programme

1. Select a programme to be copied with the **▲ / ▼** or **◀ / ▶** button.
2. Press the **GREEN** button.
All the following programmes are shifted down one position.

Moving a programme

1. Select a programme to be moved with the **▲ / ▼** or **◀ / ▶** button.
2. Press the **YELLOW** button.
3. Move the programme to the desired programme number with the **▲ / ▼** or **◀ / ▶** button.
4. Press the **YELLOW** button again to release this function.

Skipping a programme number

1. Select a programme number to be skipped with the **▲ / ▼** or **◀ / ▶** button.
2. Press the **BLUE** button. The skipped programme turns to blue.
3. Press the **BLUE** button again to release the skipped programme.

When a programme number is skipped it means that you will be unable to select it using the **▲ / ▼** button during normal TV viewing. If you want to select the skipped programme, directly enter the programme number with the NUMBER buttons or select it in the programme edit or table menu.

Repeatedly press the **MENU** button to return to normal TV viewing.

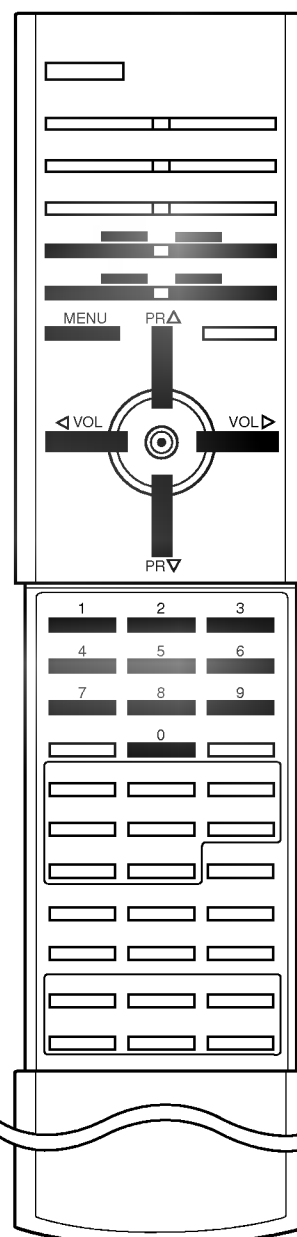

CHANNEL Menu

Calling the programme table

You can check the programmes stored in the memory by displaying the program table.

Displaying program table

Press the **LIST** button to display the Programme table menu. The programme table appears on the screen.

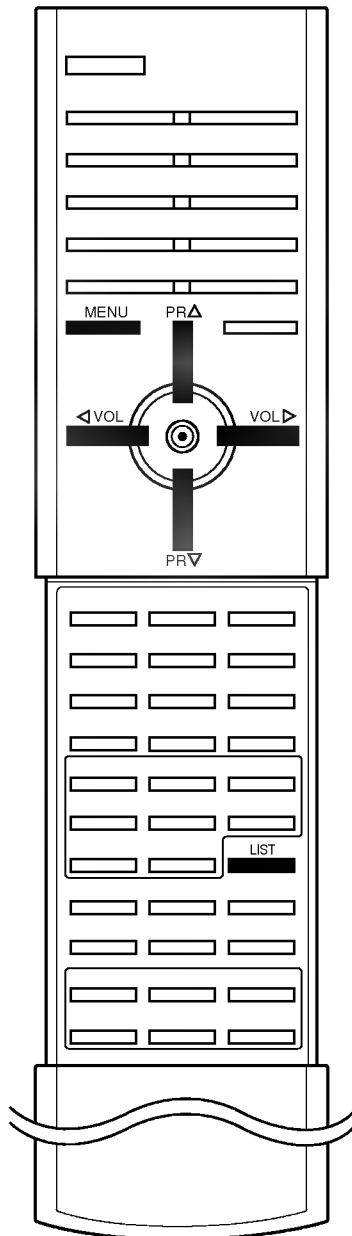

Note :

- You may find some blue highlighted programmes shown. They have been set up in the program edit mode.
- Some programmes with the channel number shown in the program table indicate there is no station name assigned.

Selecting a programme in the programme table

Select a programme with the ▲ / ▼ or ◀ / ▶ button. Then press the **OK** button.

The set switches to the chosen programme number.

Paging through a programme table

There are 10 programme table pages in which contain 100 programmes.

Pressing the ▲ / ▼ or ◀ / ▶ button repeatedly turns the pages.

Repeatedly press the **MENU** button to return to normal TV viewing.

PICTURE Menu

PSM (Picture Status Memory)

1. Press the **MENU** button and then **▲** / **▼** button to select the **PICTURE** menu.
2. Press the **▶** button and then **▲** / **▼** button to select **PSM**.



PICTURE menu

3. Press the **▶** button and then **▲** / **▼** button to select a picture setting on the **PSM** menu.
4. Press the **MENU** button to save.

You can also recall a desired picture (**Dynamic**, **Standard**, **Mild** or **User**) with **PSM** button on the remote control. The picture **Dynamic**, **Standard** and **Mild** are programmed for optimum picture reproduction at the factory and cannot be changed.

CSM (Colour Status Memory)

To initialize values (reset to default settings), select the **Normal** option. When adjusting color temperature options (red, green or blue) manually, CSM is automatically changed to **User**.

1. Press the **MENU** button and then **▲** / **▼** button to select the **PICTURE** menu.
2. Press the **▶** button and then **▲** / **▼** button to select **CSM**.



3. Press the **▶** button and then **▲** / **▼** button to select the desired colour temperature.
4. Press the **MENU** button to save.

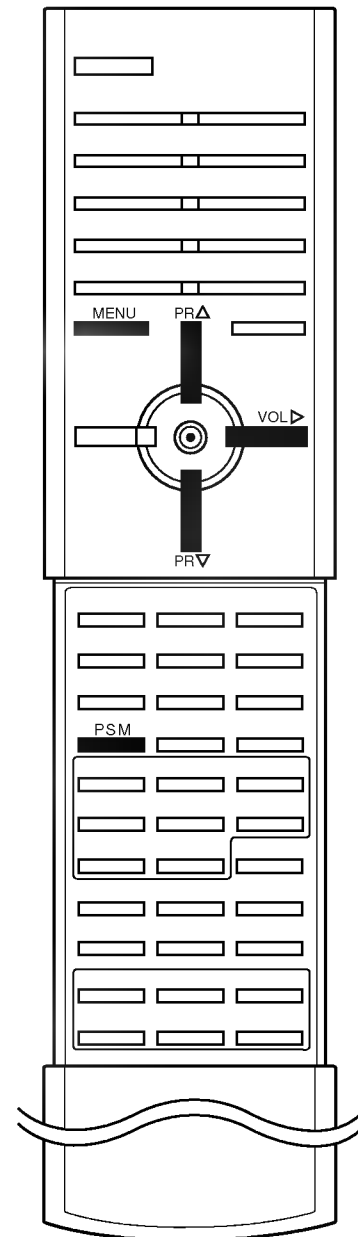

PICTURE Menu



PICTURE menu

Manual Colour Temperature Control

You can adjust red, green, or blue to any colour temperature you prefer.

1. Press the **MENU** button and then **▲ / ▼** button to select the PICTURE menu.
2. Press the **▶** button and then **▲ / ▼** button to select **Colour Temp.**



3. Press the **▶** button and then **▲ / ▼** button to select a colour.
4. Use the **◀ / ▶** button to make appropriate adjustments.
5. Press the **MENU** button to save.

Note : The adjustment range of **Red, Green and Blue** is 0~100.

Picture adjustment

You can adjust picture contrast, brightness, colour intensity, sharpness and tint (NTSC AV only) to the levels you prefer.

1. Press the **MENU** button and then **▲ / ▼** button to select the PICTURE menu.
2. Press the **▶** button and then **▲ / ▼** button to select the desired picture option.
3. Press the **▶** button and then **◀ / ▶** button to make appropriate adjustments.



4. Press the **MENU** button to save.

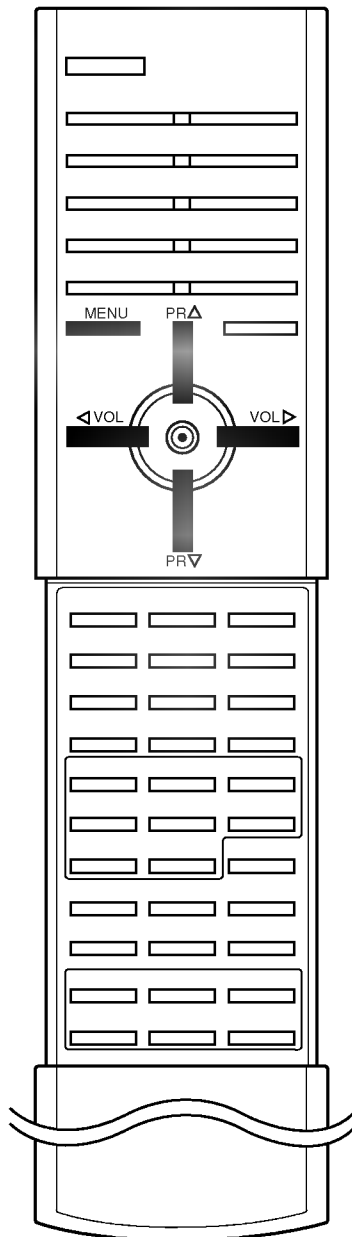

SOUND Menu

SSM (Sound Status Memory)

You can select your preferred sound setting; Flat, Speech, Movie or Music and you can also adjust the sound frequency of equalizer.

1. Press the **MENU** button and then **▲ / ▼** button to select the **SOUND** menu.
2. Press the **▶** button and then **▲ / ▼** button to select **SSM**.



3. Press the **▶** button and then **▲ / ▼** button to select a sound setting on the **SSM** menu.
4. Press the **MENU** button to save.

You can also recall a desired sound setting (**Flat, Speech, Movie, Music** or **User**) with **SSM** button on the remote control. The sound settings **Flat, Speech, Movie** and **Music** are programmed for optimum sound reproduction at the factory and cannot be changed.

Note : If you press the **SSM** button after making appropriate adjustment on the **User** sub menu, the display **User** automatically appears even though you have already set a factory preset setting; **Flat, Speech, Movie** or **Music**.

AVL (Auto Volume Leveler)

If you select **AVL On**, the set automatically keeps on an equal volume level even if you change programmes.

1. Press the **MENU** button and then **▲ / ▼** button to select the **SOUND** menu.
2. Press the **▶** button and then **▲ / ▼** button to select **AVL**.
3. Press the **▶** button and then **▲ / ▼** button to select **On** or **Off**.
4. Press the **MENU** button to save.

Sound adjustment

You can adjust the sound treble, bass and balance to the levels you prefer.

1. Press the **MENU** button and then **▲ / ▼** button to select the **SOUND** menu.
2. Press the **▶** button and then **▲ / ▼** button to select the desired sound item.
3. Press the **▶** button and then **◀ / ▶** button to make appropriate adjustments.
4. Press the **MENU** button to save.

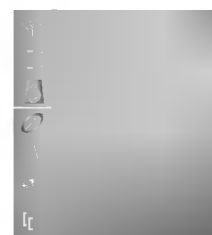

SOUND menu

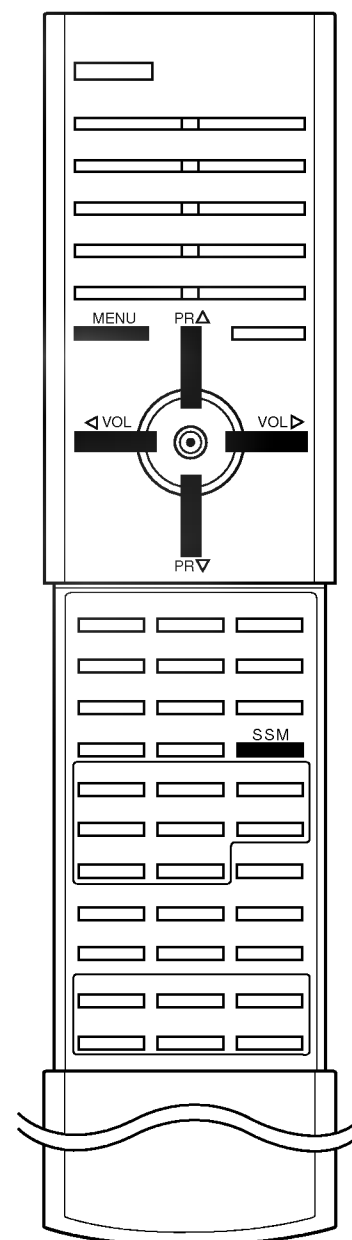

SOUND Menu

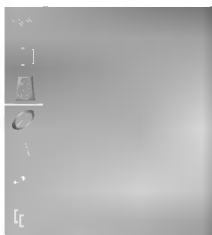

SOUND menu

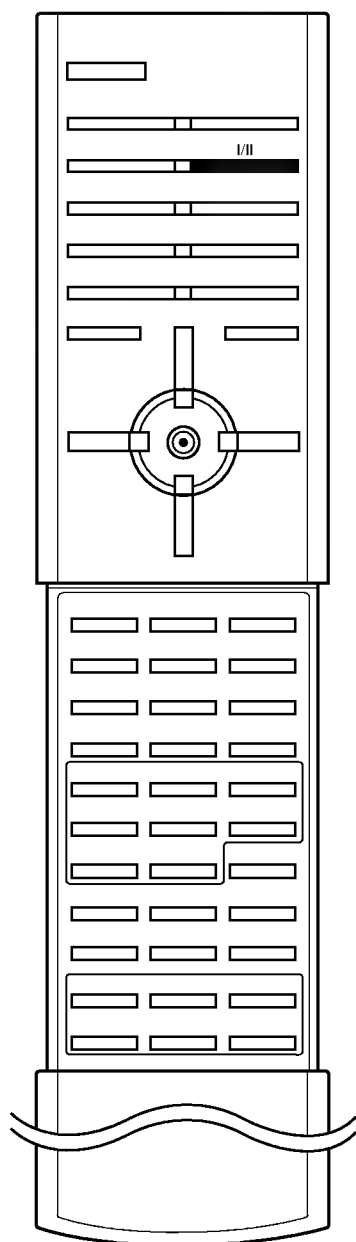

Stereo/Dual reception

When a program is selected, the sound information for the station appears after the program number and station name disappear.

Broadcast	On Screen Display
Mono	MONO
Stereo	STEREO
Dual	DUAL I

Mono sound selection

In stereo reception if the stereo signal is weak, you can switch to mono by pressing the **I/II** button twice. In mono reception the depth of sound is improved. To switch back to stereo, press the **I/II** button twice again.

Language selection for dual language broadcast

If a program received in two languages (dual language), you can switch to **DUAL I**, **DUAL II** or **DUAL I+II** by pressing the **I/II** button repeatedly.

DUAL I sends the primary broadcast language to the loudspeakers.
DUAL II sends the secondary broadcast language to the loudspeakers.

DUAL I+II sends a separate language to each loudspeaker.

NICAM reception

If your set is equipped with the receiver for NICAM reception, the high quality NICAM (Near Instantaneous Companding Audio Multiplex) digital sound can be received.

Sound output can be selected according to the type of received broadcast as follows by pressing the **I/II** button repeatedly.

1. When NICAM mono is received, you can select **NICAM MONO** or FM MONO.
2. When NICAM stereo is received, you can select **NICAM STEREO** or FM MONO. If the stereo signal is weak, switch to FM mono.
3. When NICAM dual is received, you can select **NICAM DUAL I**, **NICAM DUAL II** or **NICAM DUAL I+II** or **MONO**.

Sound output selection

In AV, RGB, DVI mode, you can select output sound for the left and right loudspeakers.

Repeatedly press the **I/II** button to select the sound output.

L+R : Audio signal from audio L input is sent to the left loud speaker and audio signal from audio R input is sent to the right loud speaker.

L+L : Audio signal from audio L input is sent to left and right loudspeakers.

R+R : Audio signal from audio R input is sent to left and right loudspeakers.

TIME Menu

Clock

You must set the time correctly before using on/off time function.

1. Press the **MENU** button and then ▲ / ▼ button to select the TIME menu.
2. Press the ► button and then ▲ / ▼ button to select **Clock**.

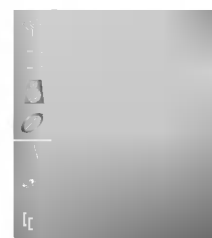
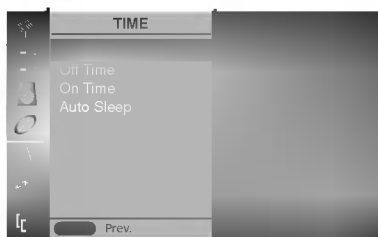

TIME menu

3. Press the ► button and then ▲ / ▼ button to adjust the hour.
4. Press the ► button and then ▲ / ▼ button to adjust the minute.
5. Press the **MENU** button to save.

On/Off Time

The off timer automatically switches the set to standby at the pre-set time.

1. Press the **MENU** button and then ▲ / ▼ button to select the TIME menu.
2. Press the ► button and then ▲ / ▼ button to select **Off Time** or **On Time**.

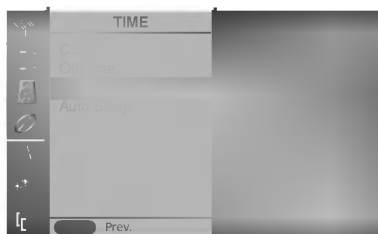

3. Press the ► button and then ▲ / ▼ button to select **On**.
To cancel **Off/On Time** function, press the ▲ / ▼ button to select **Off**.
4. Press the ► button and then ▲ / ▼ button to adjust the hour.
5. Press the ► button and then ▲ / ▼ button to adjust the minute.
6. **Only On Time function**; Press the ► button and then ▲ / ▼ button to adjust volume level.
7. Press the **MENU** button to save.

Note :

- a. In the event of power interruption (disconnection or power failure), the clock must be reset.
- b. Two hours after the set is switched on by the on time function it will automatically switch back to standby mode unless a button has been pressed.
- c. Once the on or off time is set, these functions operate daily at the preset time.
- d. Off Timer function overrides On Timer function if they are set to the same time.
- e. The set must be in standby mode for the On Timer to work.

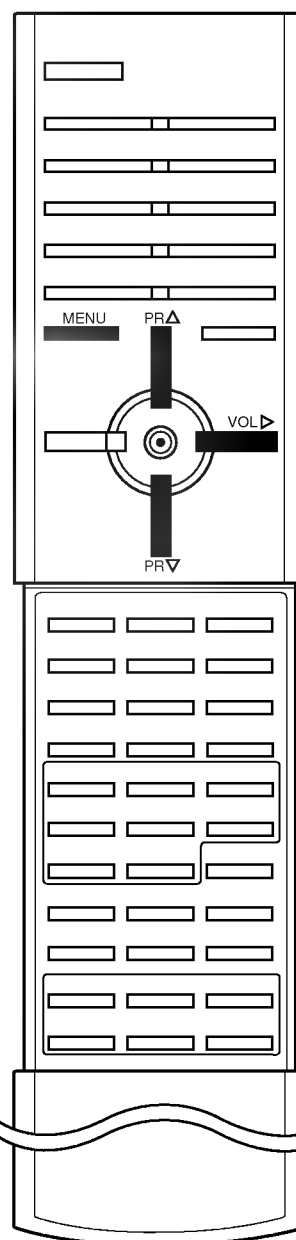

TIME Menu



TIME menu

Auto sleep

If you select **On** on the **Auto Sleep** menu, the set will automatically switch itself to standby mode approximately ten minutes after a TV station stops broadcasting.

1. Press the **MENU** button and then **▲** / **▼** button to select the TIME menu.
2. Press the **▶** button and then **▲** / **▼** button to select **Auto Sleep**.

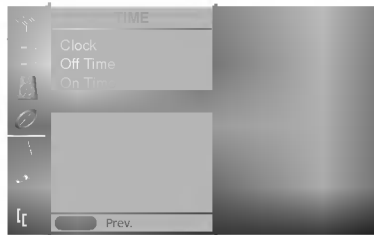

3. Press the **▶** button and then **▲** / **▼** button to select **On** or **Off**.
4. Press the **MENU** button to save.

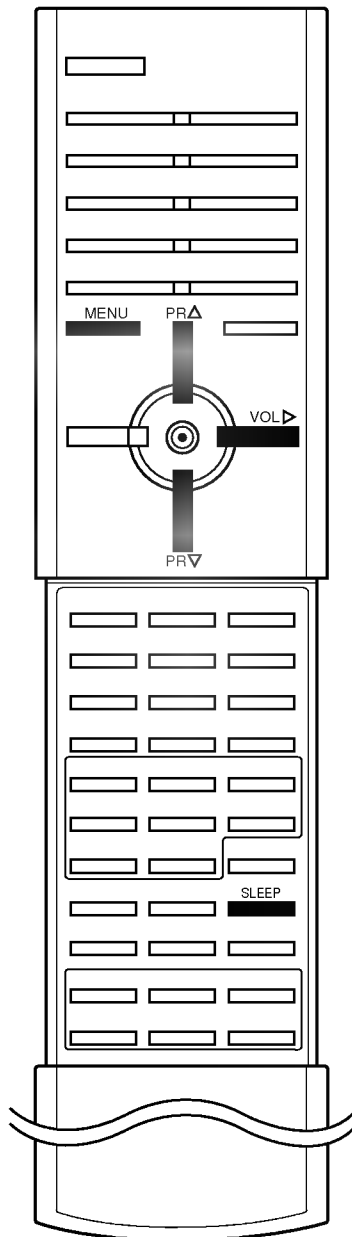

Sleep timer

You don't have to remember to switch the set off before you go to sleep. The sleep timer automatically switches the set to standby after the preset time has elapsed.

Press the **SLEEP** button to select the number of minutes. The display '**L^{zz}--- Min**' will appear on the screen, followed by **10, 20, 30, 60, 90, 120, 180** and **240**. The timer begins to count down from the number of minutes selected.

Note :

- a. To view the remaining sleep time, press the **SLEEP** button once.
- b. To cancel the sleep time, repeatedly press the **SLEEP** button until the display '**L^{zz}--- Min**' appears.
- c. When you switch the set off, the set releases the preset sleep time.

SPECIAL Menu

Child lock

The TV can be set so that the remote control handset is needed to control it. This feature can be used to prevent unauthorized viewing.

1. Press the **MENU** button and then **▲ / ▼** button to select the SPECIAL menu.
2. Press the **▶** button and then **▲ / ▼** button to select **Child Lock**.



SPECIAL menu

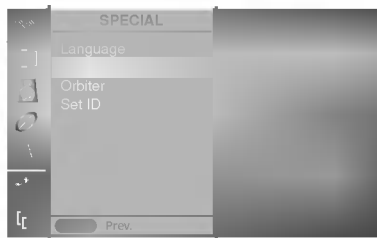

3. Press the **▶** button and then **▲ / ▼** button to select **On** or **Off**.
4. Press the **MENU** button to save.

With the lock on, the display **▲ Child Lock** appears on the screen if any button on the front panel is pressed while viewing the TV.

Note : The display **▲ Child Lock** will not appear on the screen if any button on the front panel is pressed while displaying the menus.

Orbiter

Orbiter may help prevent ghost images (image sticking). However, it is best not to allow any fixed image to remain on the screen. To avoid a prolonged image on the screen, the screen will move every 10 minutes.

1. Press the **MENU** button and then **▲ / ▼** button to select the SPECIAL menu.
2. Press the **▶** button and then **▲ / ▼** button to select **Orbiter**.

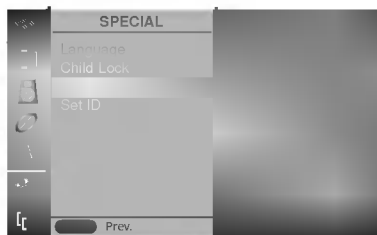

3. Press the **▶** button and then **▲ / ▼** button to select **On** or **Off**.
4. Press the **MENU** button to save.

Note : The white line sometimes displays at the top or left of the screen because entire screen moves by orbiter function.

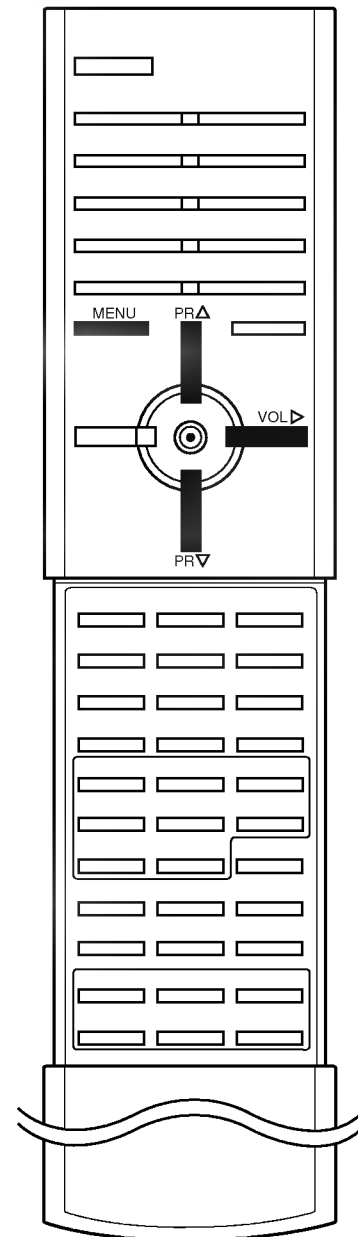

SCREEN Menu

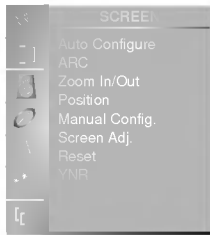

SCREEN menu

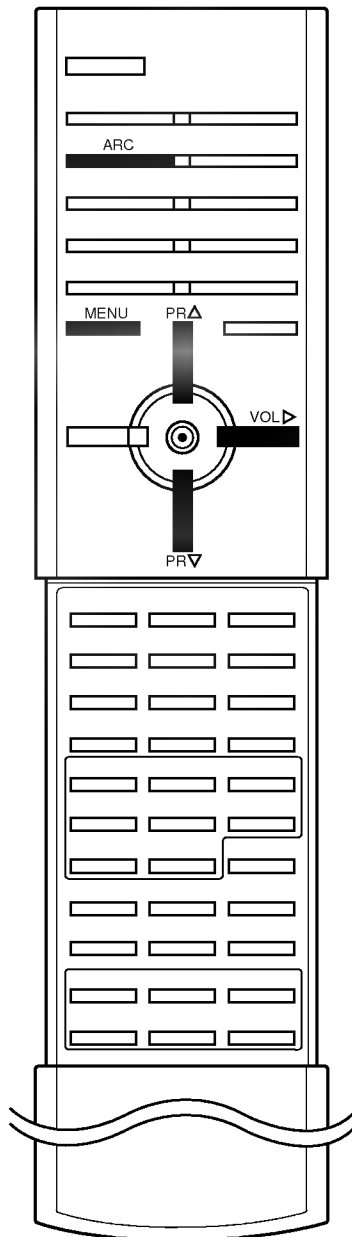

Auto adjustment (RGB [PC] mode only)

Automatically adjusts picture position and minimizes image shaking.

1. Press the **MENU** button and then **▲ / ▼** button to select the **SCREEN** menu.
2. Press the **▶** button and then **▲ / ▼** button to select **Auto Configure**.
3. Press the **▶** button to start **Auto Configure**. The display **OK** will appear.

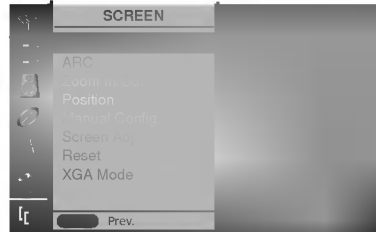

If the position of the image is still not correct, try Auto adjustment again.

4. Repeatedly press the **MENU** button to return to normal TV viewing.

Note :

- a. If picture needs to be adjusted more after Auto adjustment in RGB (PC), you can adjust the **Manual Config.**
- b. Although the image is still not correct, your TV is functioning properly but needs further adjustment.
- c. The **Auto Configure** and the **Manual Config.** functions don't need to be run for DVI mode.

Picture format

You can watch TV in various picture formats; Auto, 4:3, Wide, 14:9 and Zoom.

1. Press the **MENU** button and then **▲ / ▼** button to select the **SCREEN** menu.
2. Press the **▶** button and then **▲ / ▼** button to select **ARC**.
3. Press the **▶** button to select your desired picture format.
4. Press the **MENU** button to save.

You can also select **Auto, 4:3, Wide, 14:9** or **Zoom** with the **ARC** button on the remote control.

Auto

When your set receives the wide screen signal, it will be automatically changed to the picture format to be sent.

4:3

This picture format is 4 to 3 of general TV.

Wide

You can enjoy the cinema (the picture format of 16:9) or general TV programme through the 16:9 mode.

The screen 16:9 is viewed just like that but the screen 4:3 is magnified to the left and right so that the screen 16:9 is full.

14:9

You can enjoy the picture format of 14:9 or general TV programme through the 14:9 mode. The screen 14:9 is viewed just like that the screen 4:3 is magnified to the upper / lower and left / right.

Zoom

You can enjoy the cinema in a vast screen through the Zoom mode. The screen 4:3 is magnified to the upper / lower and left / right sides so that the screen 16:9 is full. The bottom and top of the picture may be lost.

Note :

- a. In the double window and PIP/DW mode, ARC function isn't available.
- b. Set **4:3** and **Wide** screen format for RGB, DVI mode.

SCREEN Menu

Picture Size Zoom

When enlarging or reducing the picture, the screen may display unnatural picture.

1. Press the **MENU** button and then **▲ / ▼** button to select the **SCREEN** menu.
2. Press the **▶** button and then **▲ / ▼** button to select **Zoom In/Out**.

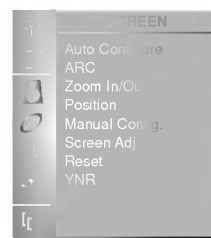
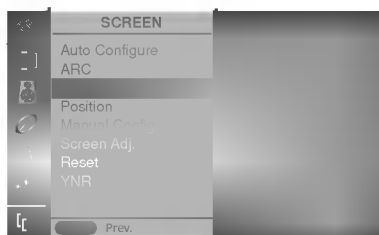

SCREEN menu

3. Press the **▶** button and then **◀ / ▶** button to enlarge or reduce the picture size.
4. Press the **MENU** button to save.

You can also enlarge or reduce the picture size with **Zoom+/Zoom-** on the remote control and then adjust the main picture position with the **▲ / ▼ / ◀ / ▶** buttons in enlarged picture mode.

Note : The adjustment range of zoom is 100~300.

Screen Position (RGB [PC] mode only)

1. Press the **MENU** button and then **▲ / ▼** button to select the **SCREEN** menu.
2. Press the **▶** button and then **▲ / ▼** button to select **Position**.

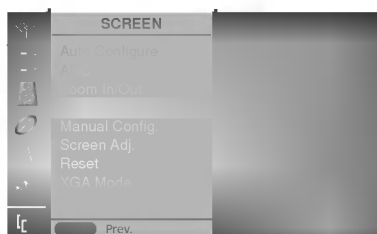

3. Press the **▶** button and then **▲ / ▼** or **◀ / ▶** button to adjust the position.
4. Press the **MENU** button to save.

Manual Configure (RGB [PC] mode only)

If the picture isn't clear after auto adjustment and especially that characters are still trembling, adjust the picture phase manually. To correct the screen size, adjust **Clock**.

1. Press the **MENU** button and then **▲ / ▼** button to select the **SCREEN** menu.
2. Press the **▶** button and then **▲ / ▼** button to select **Manual Config.**
3. Press the **▶** button and then **▲ / ▼** button to select **Phase** or **Clock**.
4. Press the **◀ / ▶** button to make appropriate adjustments.
5. Press the **MENU** button to save.

Note :

- a. The adjustment range of **Phase** is 0~31.
- b. The adjustment range of **Clock** is -50~+50.

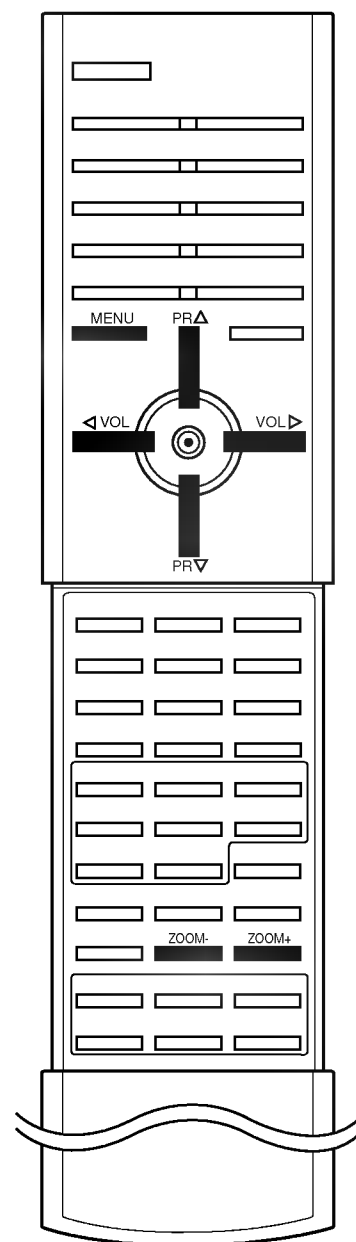

SCREEN Menu

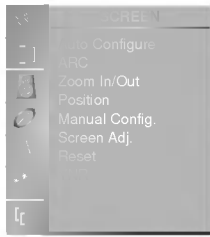

SCREEN menu

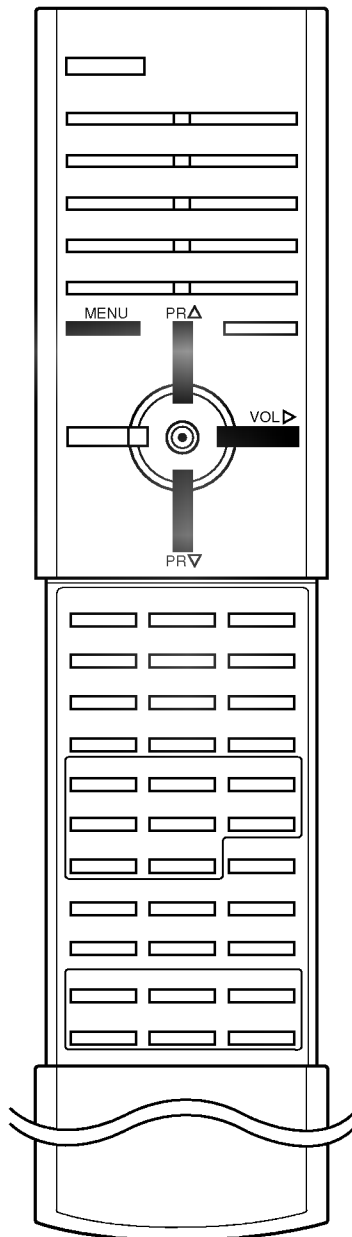

Screen adjustments

You are available to Screen Adj. in AV1, AV2, AV3 and S-Video mode. Use this function to correct jittering or picture instability while viewing a video tape.

1. Press the **MENU** button and then ▲ / ▼ button to select the SCREEN menu.
2. Press the ► button and then ▲ / ▼ button to select **Screen Adj.**

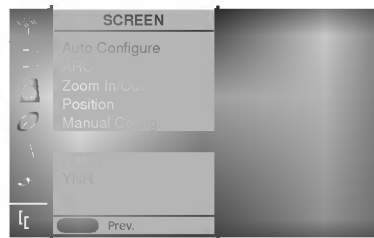

3. Press the ► button and then ▲ / ▼ button to select **TV** or **VCR**.
4. Press the **MENU** button to save.

Note :

- a. Select the **VCR** option if watching a VCR.
- b. Select the **TV** option for other equipment. (Except VCR)

Initializing (Reset to original factory value)

You can initialize Zoom In/Out, Position, Manual Config., Split zoom, PIP size, PIP position and sub picture size for twin picture.

1. Press the **MENU** button and then ▲ / ▼ button to select the SCREEN menu.
2. Press the ► button and then ▲ / ▼ button to select **Reset**.

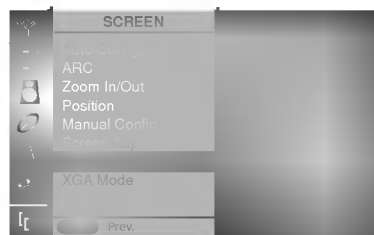

3. Press the ► button to start **Reset**. The display **OK** will appear.
4. Repeatedly press the **MENU** button to return to normal TV viewing.

Note : This function operates in every mode. To initialize the adjusted value.

SCREEN Menu

Selecting Wide XGA mode (RGB, [PC] mode only)

To see a normal picture, match the resolution of RGB mode and selection of XGA mode.

1. Press the **MENU** button and then **▲ / ▼** button to select the **SCREEN** menu.
2. Press the **▶** button and then **▲ / ▼** button to select **XGA Mode**.

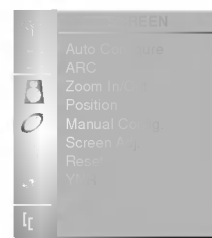
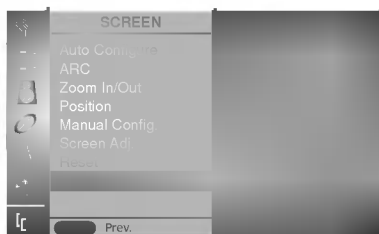

SCREEN menu

3. Press the **▶** button and then **▲ / ▼** button to select the desired XGA resolution.
4. Press the **MENU** button to save.

Note : XGA resolution can be select automatically for DVI mode.

YNR (Y-signal Noise Reduction)

To reduce the picture noise which may appear on the screen during watching the TV in a weak signal area.

You are available to **YNR** in TV, AV1, AV2, AV3 and S-Video mode.

1. Press the **MENU** button and then use **▲ / ▼** button to select the **SCREEN** menu.
2. Press the **▶** button and then **▲ / ▼** button to select **YNR**.
3. Press the **▶** button and then **▲ / ▼** button to select **On** or **Off**.
4. Press the **MENU** button to save.

Split Zoom

This is the function to enlarge the screen with regular ration.

Press the **SPLIT ZOOM** button. Each press of **SPLIT ZOOM** button changes the screen display as shown below.

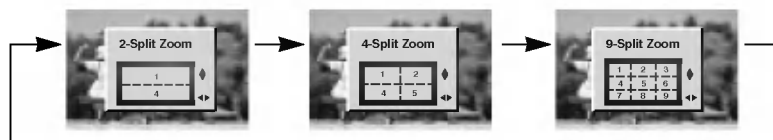

In case of 9-Split Zoom :

- a. Press the number button to select the section you enlarge. If you choose No.5, the 5 section is enlarged and also can move the enlarged screen with using the **▲ / ▼** or **◀ / ▶** button.
- b. To return to normal viewing, press the **SPLIT ZOOM** button again.



Note :

- a. It's available to use this function in every input source.
- b. With **2-Split Zoom**, you can only move the screen into upside or downside.
- c. If a screen is enlarged, a screen can move without selecting a section of screen.

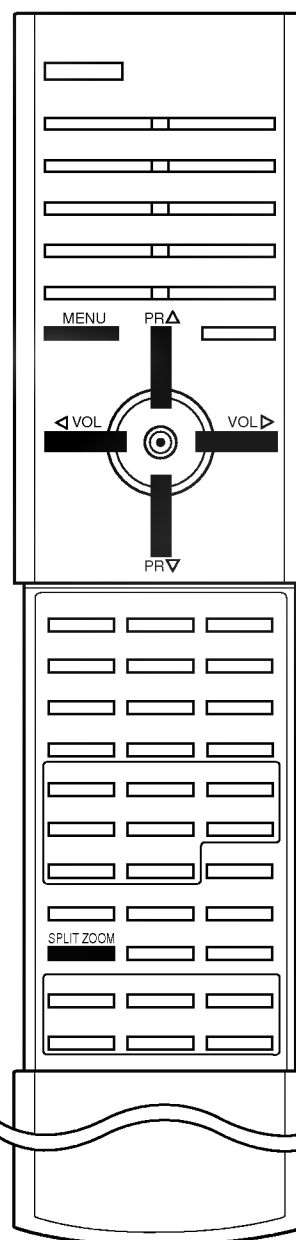

PIP/DW operation



PIP/DW menu

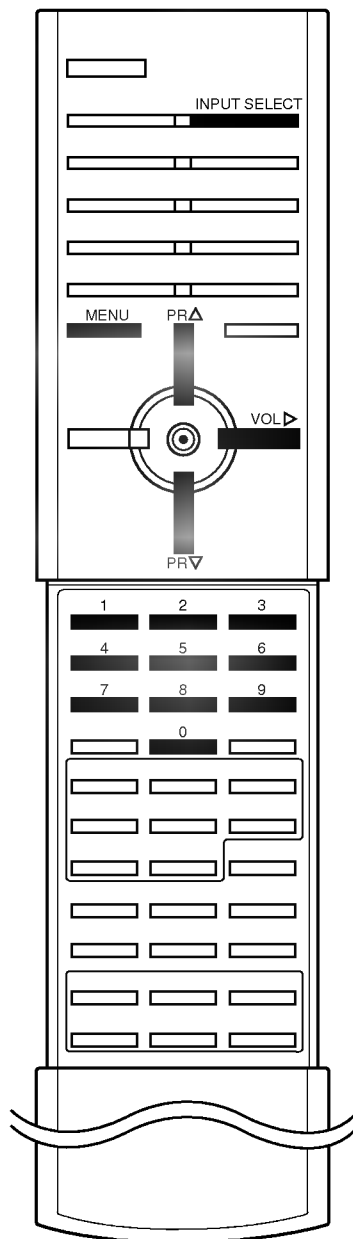

PIP (Picture in Picture) displays a picture within a picture.

Main Picture Source Selection

Inputs can be set for TV, AV1, AV2, AV3, S-Video, RGB or DVI mode. AV mode is used when a video cassette recorder (VCR), or other equipment is connected to the set.

Note : When a VCR is connected via the aerial socket the set is used in TV mode. See the 'Connection of external equipment' section.

1. Press the **MENU** button and then **▲ / ▼** button to select the PIP/DW menu.
2. Press the **▶** button and then **▲ / ▼** button to select **Input**.
3. Press the **▶** button and then **▲ / ▼** button to select **TV, AV1, AV2, AV3, S-Video, RGB** or **DVI**.

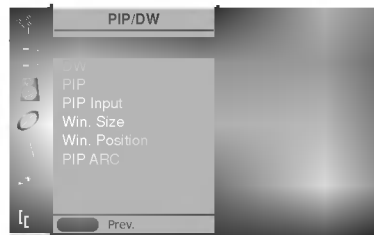

- AV1 : VCR connected to the Euro scart socket 1 on the set
- AV2 : VCR connected to the Euro scart socket 2 on the set
- AV3 : VCR connected to the Euro scart socket 3 on the set
- S-Video : S-VIDEO VCR connected to the **S-VIDEO** sockets on the set
- RGB : PC connected to the RGB socket on the set
- DVI : Digital PC connected to the DVI socket on the set

4. Press the **MENU** button to save.

You can select the TV, AV1, AV2, AV3, S-Video, RGB or DVI mode by pressing the **INPUT SELECT** button.

In AV1, AV2, AV3, S-Video, RGB or DVI mode, press the **▲ / ▼** or **NUMBER** buttons to return to TV mode.

Auto AV switching

If your VCR outputs an AV switching signal via the Scart lead the set will auto switch to **AV1, AV2, AV3** mode on start of playback, but if you want to keep on watching in TV mode, press the **▲ / ▼** or **NUMBER** buttons. Press the **INPUT SELECT** button to return to AV modes.

PIP/DW operation

Main Picture Size Adjustment

1. Press the **MENU** button and then **▲ / ▼** button to select the PIP/DW menu.
2. Press the **▶** button and then **▲ / ▼** button to select **DW**.

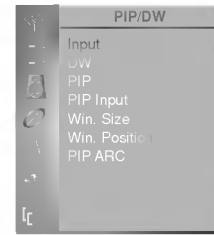
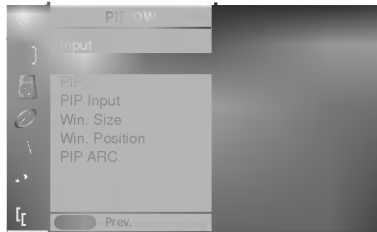

PIP/DW menu

3. Press the **▶** button and then **▲ / ▼** button to select **DW1**, **DW2** or **Off**.
4. Press the **MENU** button to save.

Note : When the DW (Double Window) function is switched on, **Win. Position**, **PIP ARC** function isn't available.

On and Off

1. Press the **MENU** button and then **▲ / ▼** button to select the PIP/DW menu.
2. Press the **▶** button and then **▲ / ▼** button to select **PIP**.
3. Press the **▶** button and then **▲ / ▼** button to select **On** or **Off**.
4. Press the **MENU** button to save.

You can also select **PIP**, **DW1**, **DW2** or **Off** with the **PIP/DW** button on the remote control.

Input mode selection for sub picture

Press the **PIP INPUT** button to select the input mode for the sub picture.



You can also adjust this function in PIP/DW menu.

Sub Picture Size

1. Press the **MENU** button and then **▲ / ▼** button to select the PIP/DW menu.
2. Press the **▶** button and then **▲ / ▼** button to select **Win. Size**.
3. Press the **▶** button and then **◀ / ▶** button to adjust the sub picture size.
4. Press the **MENU** button to save.

You can also adjust this function with the **WIN.SIZE** button on the remote control.

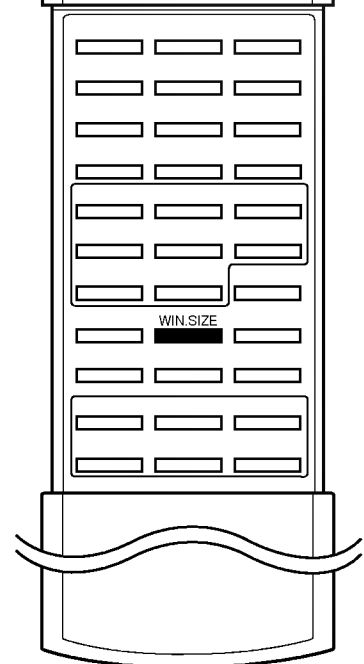
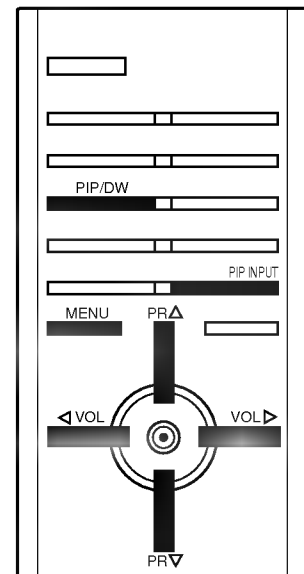

PIP/DW operation



PIP/DW menu

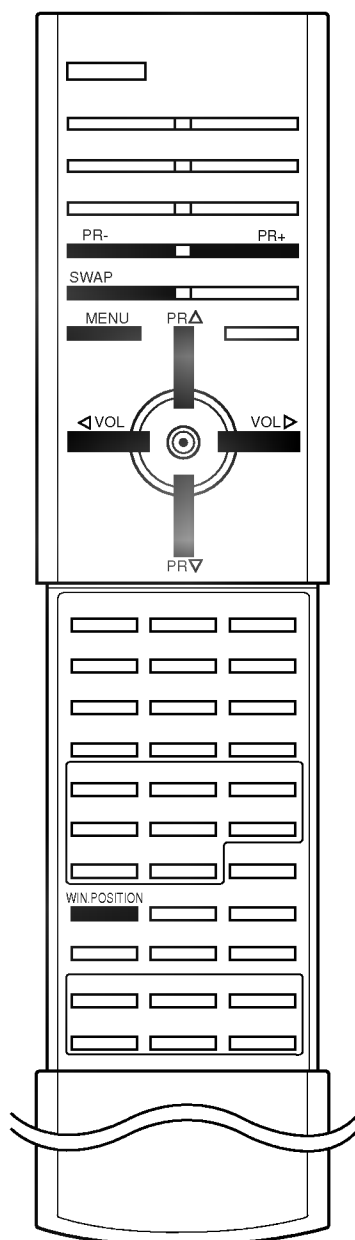

Moving the Sub Picture

1. Press the **MENU** button and then **▲ / ▼** button to select the PIP/DW menu.
2. Press the **▶** button and then **▲ / ▼** button to select **Win. Position**.



3. Press the **▶** button and then **▲ / ▼** or **◀ / ▶** button until desired position is achieved. The sub picture moves up/down or left/right.
4. Press the **MENU** button to save.

You can also adjust this function with **WIN.POSITION** button on the remote control.

PIP Aspect Ratio

1. Press the **MENU** button and then **▲ / ▼** button to select the PIP/DW menu.
2. Press the **▶** button and then **▲ / ▼** button to select **PIP ARC**.

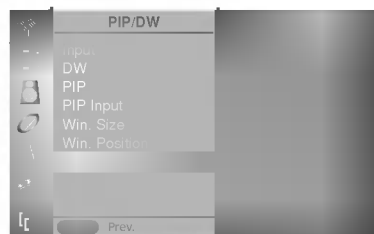

3. Press the **▶** button and then **▲ / ▼** button to select **4:3** or **16:9**.
4. Press the **MENU** button to save.

Swapping between main and sub pictures

Press the **SWAP** button to exchange the main and sub pictures.

Program selection for sub picture

The sub picture program selection is available when the sub picture is TV mode. Press the **PR +/-** buttons to select a program for the sub picture.

Teletext (option)

Teletext (or TOP text) is an optional function, therefore only a set with the teletext system can receive the teletext broadcast.

Teletext is a free service broadcast by most TV stations which gives up-to-the-minute information on news, weather, television programmes, share prices and many other topics.

The teletext decoder of this TV can support the SIMPLE, TOP and FASTEXT systems. SIMPLE (standard teletext) consists of a number of pages which are selected by directly entering the corresponding page number. TOP and FASTEXT are more modern methods allowing quick and easy selection of teletext information.

Switch on/off

Press the **TEXT** button to switch to teletext.

The initial page or last page appears on the screen.

Two page numbers, TV station name, date and time are displayed on the screen headline. The first page number indicates your selection, while the second shows the current page displayed.

Press the **TEXT** button to switch off teletext. The previous mode reappears.

SIMPLE text

Page selection

1. Enter the desired page number as a three digit number with the **NUMBER** buttons. If during selection you press a wrong number, you must complete the three digit number and then re-enter the correct page number.
2. The **▲ / ▼** button can be used to select the preceding or following page.

Programming a colour button in LIST mode

If the TV is in SIMPLE text, TOP text or FASTEXT mode, press the **EM** button to switch to LIST mode.

Four teletext page numbers of your choice can be colour coded and easily selected by pressing the corresponding coloured button on the remote control handset.

1. Press a coloured button.
2. Using the **NUMBER** buttons, select the page you wish to programme.
3. Press the **OK** button. The selected page is stored as the selected page number, blinking once to confirm this. From now on, you can select this page with the same coloured button.
4. The three other coloured buttons are programmed in this way.

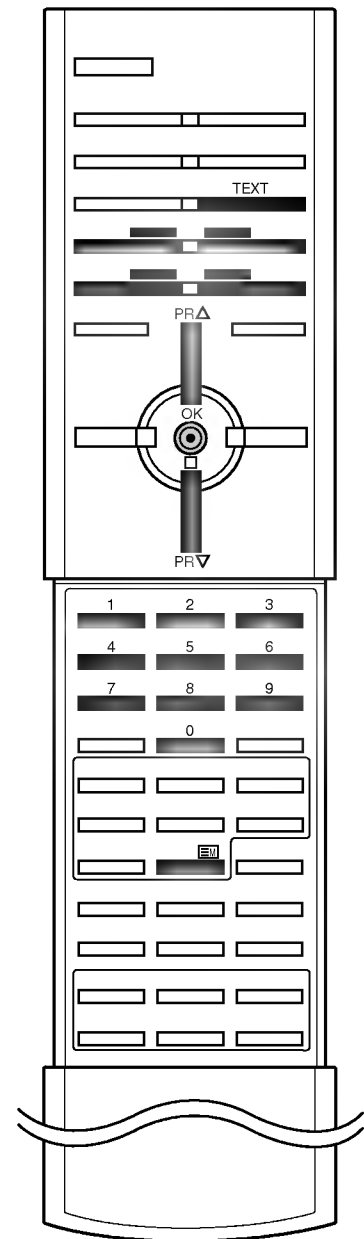

Teletext (option)

TOP text (option)

The user guide displays four fields-red, green, yellow and blue at the bottom of the screen. The yellow field denotes the next group and the blue field indicates the next block.

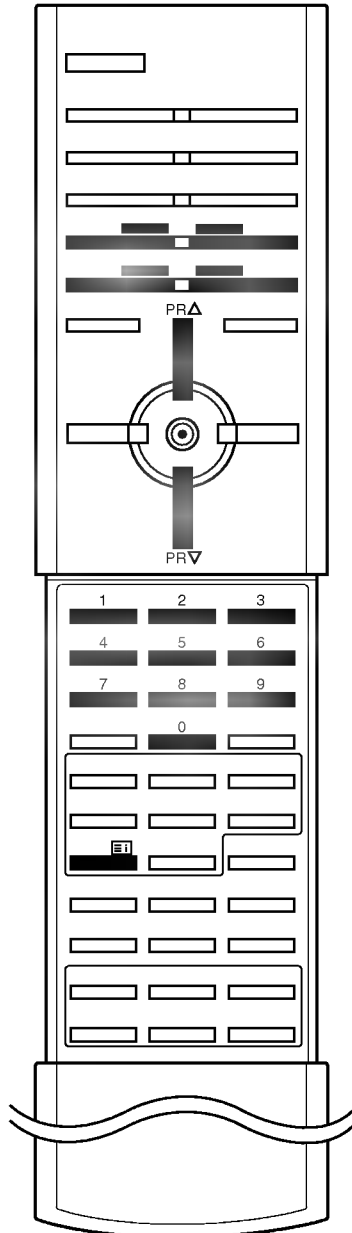

Block / group / page selection

1. With the blue button you can progress from block to block.
2. Use the yellow button to proceed to the next group with automatic overflow to the next block.
3. With the green button you can proceed to the next existing page with automatic overflow to the next group.
Alternatively the ▲ button can be used.
4. The red button permits to return to previous selection.
Alternatively the ▼ button can be used.

Direct page selection

Corresponding to the SIMPLE teletext mode, you can select a page by entering it as a three digit number using the NUMBER buttons in TOP mode.

FASTTEXT

The teletext pages are colour coded along the bottom of the screen and are selected by pressing the corresponding coloured button.

Page selection

1. Press the button to select the index page.
2. You can select the pages which are colour coded along the bottom line with the same coloured buttons.
3. Corresponding to the SIMPLE teletext mode, you can select a page by entering its three digit page number with the NUMBER buttons in FASTTEXT mode.
4. The ▲ / ▼ button can be used to select the preceding or following page.

Teletext (option)

Special teletext functions



REVEAL

Press this button to display concealed information, such as solutions of riddles or puzzles.

Press this button again to remove the information from the display.



SIZE

Selects double height text.



Press this button to enlarge the top half of the page.

Press this button again to enlarge the bottom half of the page.

Press this button again to return to the normal display.



UPDATE

Displays the TV picture on the screen while waiting for the new teletext page. The display  will appear at the top left hand corner of the screen. When the updated page is available then display  will change to the page number.

Press this button to view the updated teletext page.



HOLD

Stops the automatic page change which will occur if a teletext page consists of 2 or more sub pages. The number of sub pages and the sub page displayed is, usually, shown on the screen below the time. When this button is pressed the stop symbol is displayed at the top left-hand corner of the screen and the automatic page change is inhibited.

To continue press this button again.





MIX

Displays the teletext pages superimposed on the TV picture.

To switch the TV picture off press this button again.



TIME

When viewing a TV programme, press this button to display the time at the top right hand corner of the screen. Press this button again to remove the display. In the teletext mode, press this button to select a sub page number. The sub page number is displayed at the bottom of the screen. To hold or change the sub page, press the RED / GREEN,  /  or NUMBER buttons.

Press this button again to exit this function.

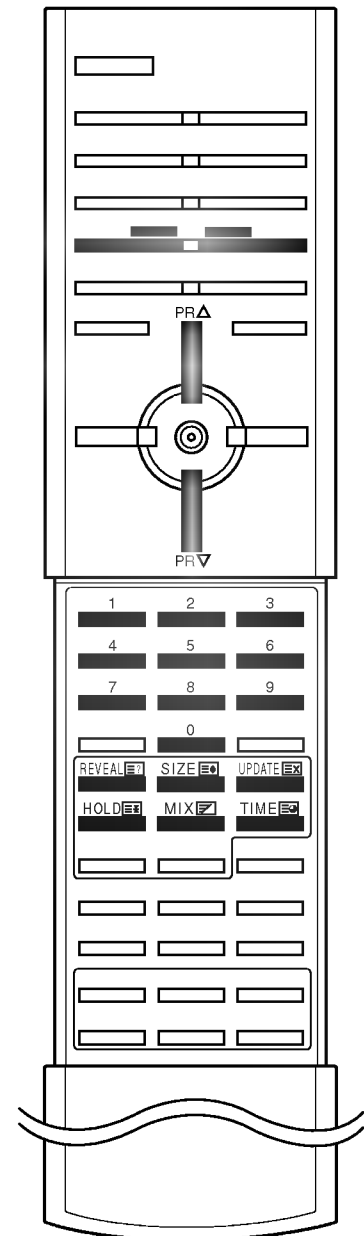

Connection of external equipment

You can connect additional equipment, such as VCRs, camcorders etc. to your set.

Here shown may be somewhat different from your set.

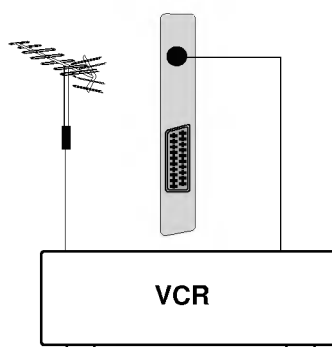

Aerial socket

1. Connect the RF out socket of the VCR to the aerial socket on the back of the set.
2. Connect the aerial cable to the RF aerial in socket of the VCR.
3. Store the VCR channel on a desired programme number using the 'Manual programme tuning' section.
4. Select the programme number where the VCR channel is stored.
5. Press the **PLAY** button on the VCR.

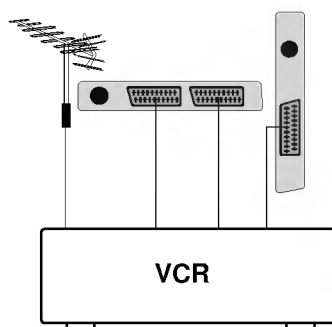

Euro scart sockets

1. Connect the Euro scart socket of the VCR to the Euro scart socket 1, 2 or 3 of the set.
2. Press the **PLAY** button on the VCR.
If your VCR outputs a switching voltage connect to Euro scart socket 1, 2 or 3, the set will switch to **AV 1**, **AV 2** or **AV 3** mode automatically. But if you want to keep on watching TV mode, press the **▲ / ▼** button.

Otherwise press the **INPUT SELECT** button on the remote control handset to select **AV 1**, **AV 2** or **AV 3**. The VCR playback picture appears on the screen.

You can also record programmes received by the TV on video tape.

Note :

- a. Signal type RGB, i.e. the signals red, green and blue can only be selected for the Euro scart 1 and the **AV 1** can be received. These signals are transmitted, for example, by a pay TV decoder, game machine or photo CD unit, etc.
- b. If both Euro scart 1, 2 and 3 sockets have been connected to the VCRs simultaneously, only the **AV 2** can be received.
- c. If the S-VHS signal is received through the S-VIDEO, you must change to the **S-Video** mode.
- d. In Euro scart 3 socket, the video output is not available.

Connection of external equipment

S-Video/Audio in sockets (S-Video)

When connecting an S-VIDEO VCR to the **S-VIDEO** socket, the picture quality will be further improved.

1. Connect the S-Video socket of the VCR to the **S-VIDEO** socket of the set.
2. Connect the audio cable from the S-VIDEO VCR to the **AV2 / S-VIDEO L/R** sockets of the set.
3. Select **S-Video** by pressing the **INPUT SELECT** button repeatedly.
4. Press the **PLAY** button on the VCR.
The VCR playback picture appears on the screen.

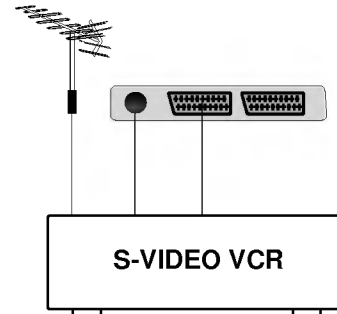

PC in socket

1. Connect the signal cable from the TV output socket of the PERSONAL COMPUTER to the **RGB INPUT** or **DVI INPUT** socket of the set.
2. Connect the audio cable from the PC to the **AUDIO INPUT** sockets of the set.
3. Press the **MULTIMEDIA** or **INPUT SELECT** button to select **RGB** or **DVI**.
4. Switch on the PC, and the PC screen appears on the set.
The set can be operated as the PC monitor.

Note :

- a. If you have an Apple macintosh, connect the VGA desktop block (not supplied) from the 3 row 15 pin to 2 row 15 pin with the signal cable and connect the VGA desktop block to the Macintosh.
- b. This set is only provided the DVI-D function although DVI jack drawing is DVI-I jack for connection convenience.

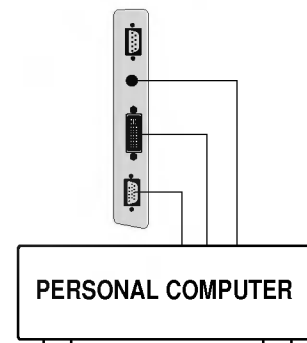

Connection of external equipment

Mounting speakers on the Set

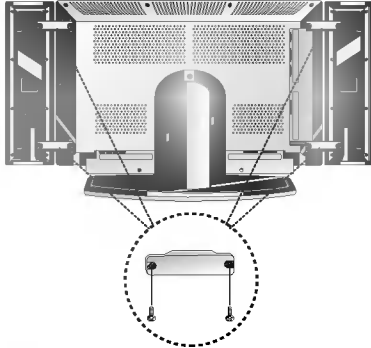

1. Turn the set off and disconnect the mains plug.
2. Install the speaker on the set with the parts (bracket and bolts) provided.
3. Be sure to connect the positive "+" wire to the "+" input and the negative "-" wire to the "-" input.
When connecting, match the colors of connecting jacks.
4. Any extra speaker wire length remaining can be bunched into the wire holders provided, see 1 above to install wire holders.

Note : *Once installed, the speaker wire holders lock into position and can't be removed.*

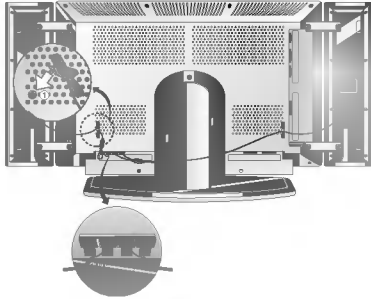

Displayable Monitor Specification

RGB Mode

MODE	Resolution	Horizontal Frequency (KHz)	Vertical Frequency (Hz)	MODE	Resolution	Horizontal Frequency (KHz)	Vertical Frequency (Hz)
EGA	640x350	31.468	70.09	XGA	1024x768	48.363	60.00
		37.861	85.08			56.476	70.06
DOS	720x400	31.469	70.08			60.023	75.02
		37.927	85.03			68.677	84.99
VGA	640x480	31.469	59.94	SXGA	1152x864	54.348	60.05
		37.861	72.80			67.500	75.00
		37.500	75.00			77.487	85.05
		43.269	85.00	WXGA (CVT)	1280x768	47.7	60.00
		60.15	75.00				
SVGA	800x600	35.156	56.25			68.596	85.00
		37.879	60.31	SXGA	1280x960	60.000	60.00
		48.077	72.18			75.000	75.00
		46.875	75.00			1280x1024	63.981
		53.674	85.06	79.976	75.02		
			MAC	832x624	49.725	74.55	

(Synchronization input form : separate)

Note :

- If the set is cold, there may be a small "flicker" when the set is switched on. This is normal, there is nothing wrong with the set.
- If possible, use the 1,280x768@60Hz video mode to obtain the best image quality for your LCD monitor. If used under the other resolutions, some scaled or processed pictures may appear on the screen. If used to PC vertical frequency 85Hz, some noise can be seen when PIP is on. In this case, set the PC vertical frequency to 60Hz.
- Some dot defects may appear on the screen, like Red, Green or Blue spots. However, this will have no impact or effect on the monitor performance.
- Do not press the LCD screen with your finger for a long time as this may produce some temporary distortion effects on the screen.
- When the PC screen appears on the set, a message may appear on the screen, and the message will differ according to the Window system version (Win98, 2000). If a message appears click "Next" until the message finishes.
- If the message "**Not accepted**" appears on the screen, adjust the PC as in the 'Displayable Monitor Specification' section.

Displayable Monitor Specification

DVI Mode

MODE	Resolution	Horizontal Frequency (KHz)	Vertical Frequency (Hz)	MODE	Resolution	Horizontal Frequency (KHz)	Vertical Frequency (Hz)		
EGA	640x350	31.468	70.09	XGA	1024x768	48.363	60.00		
		37.861	85.08			56.476	70.06		
DOS	720x400	31.469	70.08			60.023	75.02		
		37.927	85.03			68.677	84.99		
VGA	640x480	31.469	59.94			SXGA	1152x864	54.348	60.05
		37.861	72.80					67.500	75.00
		37.500	75.00	77.487	85.05				
		43.269	85.00	47.7	60.00				
SVGA	800x600	35.156	56.25	WXGA (CVT)	1280x768	60.15	75.00		
		37.879	60.31			68.596	85.00		
		48.077	72.18	SXGA	1280x960	60.000	60.00		
		46.875	75.00			75.000	75.00		
		53.674	85.06			1280x1024	63.981	60.02	
		MAC	832x624	49.725	74.55				

External Control Device Setup

Connect the RS-232C input jack to an external control device (such as a computer or an A/V control system) and control the set's functions externally.

RS-232C input socket

1. Connect the serial port of the control device to the RS-232C jack on the set.
2. RS-232C connection cables are not supplied with the set.
3. The set's remote control handset and front panel controls (except main power) will not be functional if the set is controlled by a PC computer or other external device.

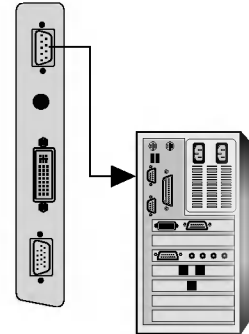

D-Sub 9-pin male

No.	Pin name
1	No connection
2	RXD (Receive data)
3	TXD (Transmit data)
4	DTR (DTE side ready)
5	GND
6	DSR (DCE side ready)
7	RTS (Ready to send)
8	CTS (Clear to send)
9	No Connection

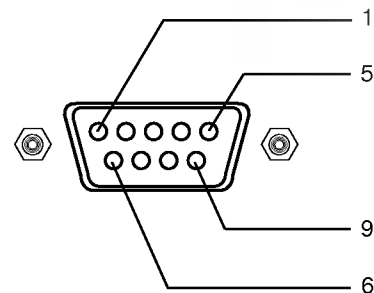

Set ID

Use this function to specify a monitor ID number. Refer to 'Real Data Mapping 1'. See page 41.

1. Press the **MENU** button and then use the ▲ / ▼ button to select the SPECIAL menu.

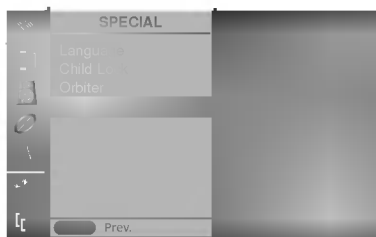

2. Press the ► button and then use ▲ / ▼ button to select **Set ID**.
3. Press the ► button and then use ◀ / ▶ button to adjust **Set ID** to choose the desired monitor ID number.

Note : The adjustment range of **Set ID** is 1 ~ 99.

Communication Parameters

- Baud rate : 115200 bps (UART)
 - Parity : None
 - Communication code : ASCII code
 - Data length : 8 bits
 - Stop bit : 1 bit
- * Use a crossed (reverse) cable.

External Control Device Setup

Command Reference List

	COMMAND 1	COMMAND 2	DATA (Hexadecimal)
01. Power	k	a	0 ~ 1
02. Input Select	k	b	0 ~ 6
03. Aspect Ratio	k	c	0 ~ 2
04. Screen Mute	k	d	0 ~ 1
05. Volume Mute	k	e	0 ~ 1
06. Volume Control	k	f	0 ~ 64
07. Contrast	k	g	0 ~ 64
08. Brightness	k	h	0 ~ 64
09. Colour	k	i	0 ~ 64
10. Tint	k	j	0 ~ 64
11. Sharpness	k	k	0 ~ 64
12. OSD Select	k	l	0 ~ 1
13. External Control Mode	k	m	0 ~ 1
14. PIP/Twin Picture (DW)	k	n	0 ~ 3
15. PIP Aspect Ratio	k	o	0 ~ 1
16. Split Zoom	k	p	
17. PIP Position	k	q	0 ~ 3
18. Treble	k	r	0 ~ 64
19. Bass	k	s	0 ~ 64
20. Balance	k	t	0 ~ 64
21. Colour Temperature (CSM)	k	u	0 ~ 2
22. Red Adjustment	k	v	0 ~ 64
23. Green Adjustment	k	w	0 ~ 64
24. Blue Adjustment	k	\$	0 ~ 64
25. PIP input Source	k	y	0 ~ 6
26. SSM Mode	k	x	0 ~ 4
27. Orbiter	j	p	0 ~ 1

Transmission / Receiving Protocol

Transmission

[Command1][Command2][][Set ID][][Data][Cr]

- * [Command 1] : First command to control set.
(j or k)
- * [Command 2] : Second command to control set.
- * [Set ID] : You can adjust the set ID to choose desired monitor ID number in special menu. See previous page. Adjustment range is 1 ~ 99. When selecting Set ID '0', every connected set is controlled. Set ID is indicated as decimal (1~99) on menu and as Hexa decimal (0x0~0x63) on transmission/receiving protocol.
- * [DATA] : To transmit command data. Transmit 'FF' data to read status of command.
- * [Cr] : Carriage Return ASCII code '0x0D'
- * [] : ASCII code 'space (0x20)'

OK Acknowledgement

[Command2][][Set ID][][OK][Data][x]

- * The Monitor transmits ACK (acknowledgement) based on this format when receiving normal data. At this time, if the data is data read mode, it indicates present status data. If the data is data write mode, it returns the data of the PC computer.

Error Acknowledgement

[Command2][][Set ID][][NG][Data][x]

- * The Monitor transmits ACK (acknowledgement) based on this format when receiving abnormal data from non-viable functions or communication errors.

- Data 1 : illegal code
- 2 : not support function
- 3 : wait more time

External Control Device Setup

01. Power (Command : a)

- ▶ To control Power On/Off of the TV.

Transmission

[k][a][][Set ID][][Data][Cr]

Data 0 : Power Off 1 : Power On

Ack

[a][][Set ID][][OK][Data][x]

- ▶ To show Power On/Off.

Transmission

[k][a][][Set ID][][FF][Cr]

Ack

[a][][Set ID][][OK][Data][x]

* In like manner, if other functions transmit '0xFF' data based on this format, Acknowledgement data feed back presents status about each function.

02. Input Select (Command : b)

- ▶ To select input source for the set.
You can also select an input source using the INPUT SELECT button on the set's remote control.

Transmission

[k][b][][Set ID][][Data][Cr]

Data 0 : TV	4 : S-Video
1 : AV1	5 : RGB
2 : AV2	6 : DVI
3 : AV3	

Ack

[b][][Set ID][][OK][Data][x]

03. Aspect Ratio (Command : c) (Main Picture Size)

- ▶ To adjust the screen format. (Main picture format)
You can also adjust the screen format using the ARC (Aspect Ratio Control) button on remote control or in the SPECIAL menu.

Transmission

[k][c][][Set ID][][Data][Cr]

Data 0 : Wide screen (16:9)
1 : Normal screen (4:3)
2 : Full screen (Zoom)
3 : Auto
4 : 14:9

Ack

[c][][Set ID][][OK][Data][x]

* Using the PC input, you select either 16:9 or 4:3 screen aspect ratio.

04. Screen Mute (Command : d)

- ▶ To select screen mute on/off.

Transmission

[k][d][][Set ID][][Data][Cr]

Data 0 : Screen mute off (Picture on)
1 : Screen mute on (Picture off)

Ack

[d][][Set ID][][OK][Data][x]

05. Volume Mute (Command : e)

- ▶ To control volume mute on/off.
You can also adjust mute using the MUTE button on remote control.

Transmission

[k][e][][Set ID][][Data][Cr]

Data 0 : Volume mute on (Volume off)
1 : Volume mute off (Volume on)

Ack

[e][][Set ID][][OK][Data][x]

06. Volume Control (Command : f)

- ▶ To adjust volume.
You can also adjust volume with the volume buttons on remote control.

Transmission

[k][f][][Set ID][][Data][Cr]

Data Min : 0 ~ Max : 64
* Refer to 'Real data mapping1'. See page 42.

Ack

[f][][Set ID][][OK][Data][x]

07. Contrast (Command : g)

- ▶ To adjust screen contrast.
You can also adjust contrast in the PICTURE menu.

Transmission

[k][g][][Set ID][][Data][Cr]

Data Min : 0 ~ Max : 64
* Refer to 'Real data mapping1'. See page 42.

Ack

[g][][Set ID][][OK][Data][x]

External Control Device Setup

08. Brightness (Command : h)

- ▶ To adjust screen brightness.
You can also adjust brightness in the PICTURE menu.

Transmission

[k][h][][Set ID][][Data][Cr]

Data Min : 0 ~ Max : 64
* Refer to 'Real data mapping1'. See page 42.

Ack

[h][][Set ID][][OK][Data][x]

09. Colour (Command : i)

- ▶ To adjust the screen colour.
You can also adjust colour in the PICTURE menu.

Transmission

[k][i][][Set ID][][Data][Cr]

Data Min : 0 ~ Max : 64
* Refer to 'Real data mapping1'. See page 42.

Ack

[i][][Set ID][][OK][Data][x]

10. Tint (Command : j) (option)

- ▶ To adjust the screen tint.
You can also adjust tint in the PICTURE menu.

Transmission

[k][j][][Set ID][][Data][Cr]

Data Red : 0 ~ Green : 64
* Refer to 'Real data mapping1'. See page 42.

Ack

[j][][Set ID][][OK][Data][x]

11. Sharpness (Command : k)

- ▶ To adjust the screen sharpness.
You can also adjust sharpness in the PICTURE menu.

Transmission

[k][k][][Set ID][][Data][Cr]

Data Min : 0 ~ Max : 64
* Refer to 'Real data mapping1'. See page 42.

Ack

[k][][Set ID][][OK][Data][x]

12. OSD Select (Command : l)

- ▶ To select OSD (On Screen Display) on/off when controlling remotely.

Transmission

[k][l][][Set ID][][Data][Cr]

Data 0 : OSD off 1 : OSD on

Ack

[l][][Set ID][][OK][Data][x]

13. External Control Mode (Command : m)

- ▶ To lock the front panel controls on the set and remote control. When setting this mode, only control the monitor with RS-232C.

Transmission

[k][m][][Set ID][][Data][Cr]

Data 0 : off 1 : on

Ack

[m][][Set ID][][OK][Data][x]

- * If you're not using the remote control, use this mode. When main power is on/off, external control lock is released.

14. PIP / DW (Command : n)

- ▶ To control the PIP (Picture In picture)/DW (Double Window) picture.
You can also control the PIP/DW picture using the PIP/DW button on the remote control or in the PIP/DW menu.

Transmission

[k][n][][Set ID][][Data][Cr]

Data 0 : PIP off 1 : PIP
2 : DW1 3 : DW2

Ack

[n][][Set ID][][OK][Data][x]

15. PIP Aspect Ratio (Command : o)

- ▶ To select the PIP picture format.
You can also adjust the screen format for PIP in the PIP/DW menu.

Transmission

[k][o][][Set ID][][Data][Cr]

Data 0 : Normal screen (4:3)
1 : Wide screen (16:9)

Ack

[o][][Set ID][][OK][Data][x]

External Control Device Setup

16. Split Zoom On/Off (Command : p)

- ▶ To operate split zoom function and select the split zoom section number.

Transmission

[k][p][][Set ID][][Data][Cr]

Data : Upper Byte : Split Selection
0 : Split Off, 1 : 2 Split, 2 : 4 Split, 3 : 9 Split
Low Byte : Window Selection
21: Selection 1 of 2 split zoom
24: Selection 4 of 2 split zoom
41: Selection 1 of 4 split zoom
42: Selection 2 of 4 split zoom
44: Selection 4 of 4 split zoom
45: Selection 5 of 4 split zoom
91: Selection 1 of 9 split zoom
⋮
99: Selection 9 of 9 split zoom

Ack

[p][][Set ID][][OK][Data][x]

Data : Upper Byte : Split Information
(0 : Split Off, 1 : 2 Split, 2 : 4 Split, 3 : 9 Split)
Low Byte : Displayed Window Number

17. PIP Position (Command : q)

- ▶ To select sub picture position for PIP.
You can also adjust the sub picture position using WIN.POSITION button on the remote control or in the PIP/DW menu.

Transmission

[k][q][][Set ID][][Data][Cr]

Data 0 : Right down on screen
1 : Left down on screen
2 : Left up on screen
3 : Right up on screen

Ack

[q][][Set ID][][OK][Data][x]

18. Treble (Command : r)

- ▶ To adjust treble.
You can also adjust treble in the SOUND menu.

Transmission

[k][r][][Set ID][][Data][Cr]

Data Min : 0 ~ Max : 64
* Refer to 'Real data mapping1'. See page 42.

Ack

[r][][Set ID][][OK][Data][x]

19. Bass (Command : s)

- ▶ To adjust bass.
You can also adjust bass in the SOUND menu.

Transmission

[k][s][][Set ID][][Data][Cr]

Data Min : 0 ~ Max : 64
* Refer to 'Real data mapping1'. See page 42.

Ack

[s][][Set ID][][OK][Data][x]

20. Balance (Command : t)

- ▶ To adjust balance.
You can also adjust balance in the SOUND menu.

Transmission

[k][t][][Set ID][][Data][Cr]

Data Min : 0 ~ Max : 64
* Refer to 'Real data mapping 1'. See page 42.

Ack

[t][][Set ID][][OK][Data][x]

21. Colour Temperature (Command : u)

- ▶ To adjust colour temperature.
You can also adjust CSM in the PICTURE menu.

Transmission

[k][u][][Set ID][][Data][][Cr]

Data 0: Normal 1: Cool 2: Warm 3: User

Ack

[u][][Set ID][][OK][Data][x]

22. Red Adjustment (Command : v)

- ▶ To adjust red in colour temperature.

Transmission

[k][v][][Set ID][][Data][Cr]

Data Min : 0 ~ Max : 64
* Refer to 'Real data mapping 1'. See page 42.

Ack

[v][][Set ID][OK][][Data]

23. Green Adjustment (Command : w)

- ▶ To adjust green in colour temperature.

Transmission

[k][w][][Set ID][][Data][Cr]

Data Min : 0 ~ Max : 64
* Refer to 'Real data mapping 1'. See page 42.

Ack

[w][][Set ID][][OK][Data][x]

External Control Device Setup

24. Blue Adjustment (Command : \$)

- ▶ To adjust blue in colour temperature.

Transmission

[k][x][][Set ID][][Data][Cr]

Data Min : 0 ~ Max : 64
* Refer to 'Real data mapping 1'. See page 42.

Ack

[x][][Set ID][][OK][Data][x]

25. PIP Input Select (Command : y)

- ▶ To select input source for sub picture in PIP/DW mode. You can also adjust input source for sub picture using PIP INPUT button on remote control.

Transmission

[k][y][][Set ID][][Data][Cr]

Data 0	: TV	4	: S-Video
1	: AV1	5	: RGB
2	: AV2	6	: DVI
3	: AV3		

Ack

[y][][Set ID][][OK][Data][x]

- * It's disable to choose the main and sub picture input source simultaneously.

26. SSM Mode (Command : x)

- ▶ To select sound mode.

Transmission

[k][x][][Set ID][][Data][Cr]

Data 0	: Flat	3	: Music
1	: Speech	4	: User
2	: Movie		

Ack

[x][][Set ID][][OK][Data][x]

27. Orbiter

(Command 1 : j, Command 2 : p)

- ▶ To control the ISM method. You can also adjust ISM Method in SPECIAL menu.

Transmission

[j][p][][Set ID][][Data][Cr]

Data 0 : off 1 : on

Ack

[p][][Set ID][OK][][Data]

* Real data mapping 1

0 : Step 0
⋮
A : Step 10 (Set ID 10)
⋮
F : Step 15 (Set ID 15)
10 : Step 16 (Set ID 16)
⋮
64 : Step 100

Troubleshooting check list

Symptoms

No picture, no sound

Sound OK, poor picture

Picture OK, poor sound

Picture blurred

Lines or streaks in picture

Poor reception on some channels

No colour

Poor colour

Remote control does not work

Incorrect position

Vertical bars or stripes on background

Horizontal noise

Signal Cable message appears

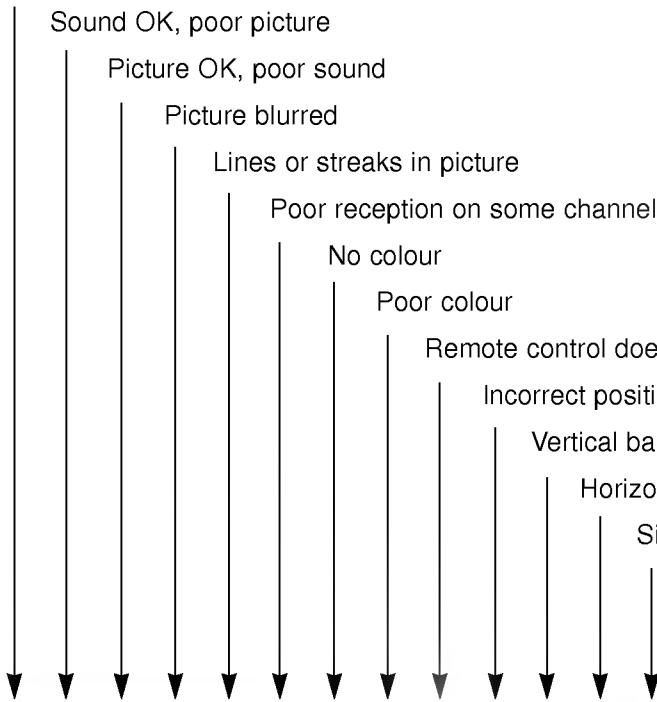
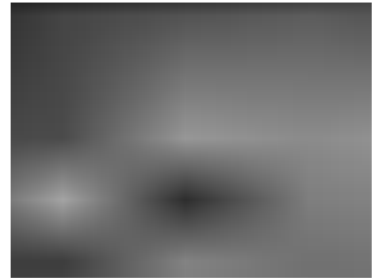

Check these items and try to adjust these

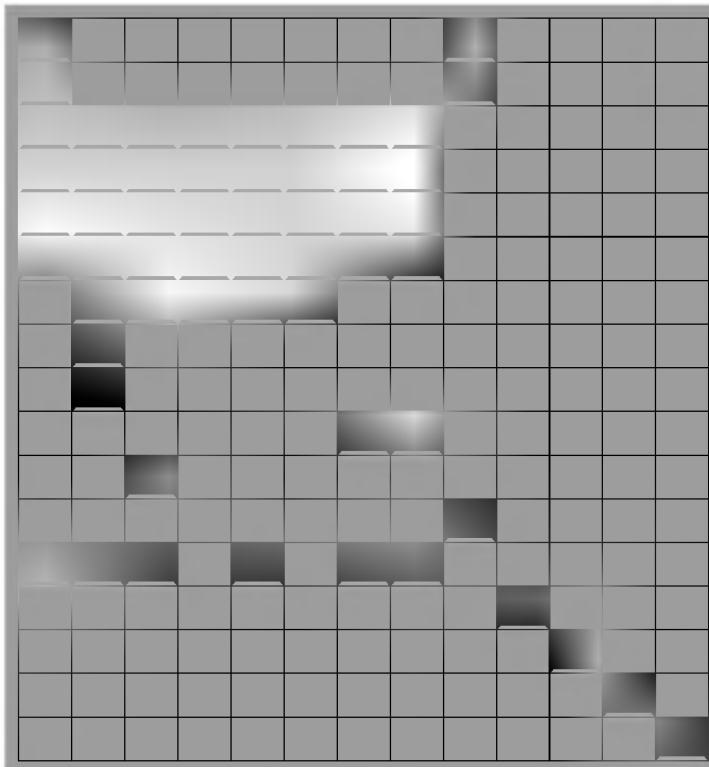

The mains plug-(plugged in and switched on)

Is the TV switched on

Try another channel (weak signal)

Check aerial (plugged into TV?)

Check aerial (broken lead?)

Check aerial

Check for local interference

Adjust contrast

Adjust brightness

Adjust colour

Adjust volume

Check the batteries in remote control

Check Audio/Video sockets (VCR only)

Auto-configure or adjust the H/V position

Auto-configure or adjust Clock

Auto-configure or adjust Clock Phase

Is the Signal Cable connected or loose

