



RECEIVER/ DVD PLAYER/ VIDEO CASSETTE RECORDER

OWNER'S MANUAL

MODEL : DT-77770V

(Main Unit : DT-77770V, Speakers : DTE-655T, DTE-655C, DTE-604W)



Before connecting, operating or adjusting this product,
please read this instruction booklet carefully and
completely.

Safety Precautions / Important notes on controlling this unit



CAUTION
RISK OF ELECTRIC SHOCK
DO NOT OPEN



CAUTION: TO REDUCE THE RISK OF ELECTRIC SHOCK
DO NOT REMOVE COVER (OR BACK)
NO USER-SERVICEABLE PARTS INSIDE
REFER SERVICING TO QUALIFIED SERVICE PERSONNEL.



This lightning flash with arrowhead symbol within an equilateral triangle is intended to alert the user to the presence of uninsulated dangerous voltage within the product's enclosure that may be of sufficient magnitude to constitute a risk of electric shock to persons.



The exclamation mark within an equilateral triangle is intended to alert the user to the presence of important operating and maintenance (servicing) instructions in the literature accompanying the product.

WARNING: TO REDUCE THE RISK OF FIRE OR ELECTRIC SHOCK, DO NOT EXPOSE THIS PRODUCT TO RAIN OR MOISTURE.

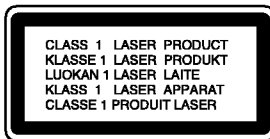

CAUTION:

This Digital Video Disc Player employs a Laser System.

To ensure proper use of this product, please read this owner's manual carefully and retain for future reference, should the unit require maintenance, contact an authorized service location-see service procedure.

Use of controls, adjustments or the performance of procedures other than those specified herein may result in hazardous radiation exposure.

To prevent direct exposure to laser beam, do not try to open the enclosure. Visible laser radiation when open. DO NOT STARE INTO BEAM.

CAUTION: The apparatus shall not be exposed to water, dripping or splashing and that no objects filled with liquids, such as vases, shall be placed on the apparatus.



This product is manufactured to comply with the radio interference requirements of EEC DIRECTIVE 89/336/EEC, 93/68/EEC and 73/23/EEC.



Notes on copyrights:

It is forbidden by law to copy, broadcast, show, broadcast via cable, play in public, or rent copyright material without permission.

This product features the copy protection function developed by Macrovision. Copy protection signals are recorded on some discs.

This product incorporates copyright protection technology that is protected by method claims of certain U.S. patents and other intellectual property rights owned by Macrovision Corporation and other rights owners. Use of this copyright protection technology must be authorized by Macrovision Corporation, and is intended for home and other limited viewing uses only unless otherwise authorized by Macrovision Corporation. Reverse engineering or disassembly is prohibited.

SERIAL NUMBER: The serial number is found on the back of this unit. This number is unique to this unit and not available to others. You should record requested information here and retain this guide as a permanent record of your purchase.

Model No. _____

Serial No. _____

Features:

- Complete versatility to play DVD, VCDs, audio CDs, VCR Tapes, DVD-R, DVD-RW or DVD+RW.
- Watch a DVD while recording a TV show to the VCR.
- Remote controls both DVD and VCR decks.
- Records from DVD to VCR (unless DVD is copy protected with Macrovision).
- Amplifier built in DVD player.
- Built in AM/FM Tuner.
- Dolby Digital Decoder.
- DTS Decoder.
- Hi-Fi Stereo VCR.

Important notes on controlling this unit

This unit uses one set of controls to operate both DVD and VCR. The following buttons are helpful in successfully controlling each part.

- 1 POWER Button**
Press the POWER button on the remote control or front panel to turn on this unit.
- 2 DVD Button**
Press DVD button on the remote control when you want to control the DVD.
- 3 VCR Button**
Press the VCR button on the remote control when you want to control the VCR.
- 4 DVD/VCR Button**
Press the DVD/VCR button on the front panel to toggle control between the DVD and the VCR.

Contents

Introduction

Safety Precautions	2
Important notes on controlling this unit	2
Table of Contents	3
Before Use	4-5
Playable Discs	4
Precautions	5
Notes on Discs	5
About Symbols	5
Front Panel and Display Window	6
Remote Control	7
Rear Panel	8

Preparation

Connections	9-10
Connecting to a TV & Decoder (or Satellite)	9
Radio Aerial Connections	9
Speaker System Connection	10
Speaker Positioning	10
Before Operation	11
Mini Glossary for Sound Mode	11
Sound Mode	11
Before Operation - VCR part	12-16
Tuning in a video channel on your TV	12
Using your VCR for the very first time	12
Setting the clock Manually	13
To set the colour system	13
How to using the main menu	14
Tuning in TV stations Automatically	14
Tuning in TV stations Manually	15
Changing the order of TV stations	16
Deleting TV stations	16
Before Operation - DVD part	17-20
General Explanation	17
On-Screen Display	17
Initial Settings	18-20
• Initial Settings General Operation	18
• Language	18
• Picture	18
• 5.1 Speaker settings	19
• Others	19
• Parental Control	20

Operation

Operation with Tape	21-23
Playing a tape	21
• CM (Commercial Message) Skip	21
• OPR (Optimum Picture Response)	21
Instant Timer Recording (ITR)	22
Timer recording using On Screen Display	23
Operation with DVD and Video CD	24-26
Playing a DVD and Video CD	24
General Features	24
• Moving to another TITLE	24
• Moving to another CHAPTER/TRACK	24
• Slow Motion	24
• Still Picture and Frame-by-Frame Playback	25
• Search	25
• Random	25
• Repeat	25
• Repeat A-B	25
• Time Search	25
• 3D Surround	25
• Zoom	26
• Marker Search	26
Special DVD Features	26
• Title Menu	26
• Disc Menu	26
• Camera Angle	26
• Changing the Audio Language	26
• Changing the Audio Channel	26
• Subtitles	26

Operation with Audio CD and MP3/WMA Disc

Playing an Audio CD and MP3/WMA Disc	27
• Notes on MP3/WMA Recordings	27
• Pause	28
• Moving to another Track	28
• Repeat Track/All/Off	28
• Search	28
• Random	28
• Repeat A-B	28
• 3D Surround	28
• Changing the Audio Channel	28

Operation with JPEG Disc

Viewing a JPEG disc	29
• Moving to another file	29
• Still Picture	29
• To flip the picture	29
• To rotate picture	29
• Notes on JPEG Recordings	29

Programmed Playback

Programmed Playback with Audio CD and MP3/WMA Disc	30
Programmed Playback with Video CD	30
• Repeat Programmed Tracks	30
• Erasing a Track from Program list	30
• Erasing the Complete Program list	30

Additional Operation - VCR part

On Screen Display	31
Tape Counter Memory Stop	31
Video Doctor (Self-Diagnosis)	31
ez (easy) repeat	31
Hi-Fi Stereo Sound System	32
Wide Screen Compatibility 16:9	32
To set the decoder	32

Additional Operation - DVD part

Last Condition Memory	33
Screen Saver	33

Special Recording

Copying from DVD to VCR	34
Recording from another video recorder	34

Radio Operation

Presetting the Radio Stations	35
Listening to the Radio	35
To Clear the Stored Radio Stations	35
Tuning into a Station Manually	36
Tuning into a Station Automatically	36
Mute	36

Reference

Speaker Settings	37
Troubleshooting	38
Language Code List	39
Country Code list	40
Specification	41

About the symbols for instructions



 Indicates hazards likely to cause harm to the unit itself or other material damage.

 Indicates special operating features of this unit.

 Indicates tips and hints for making the task easier.

Before Use

Playable Discs

	DVD (8 cm / 12 cm disc)
	Video CD (VCD) (8 cm / 12 cm disc)
	Audio CD (8 cm / 12 cm disc)

In addition, this unit can play a DVD-R, DVD±RW, Kodak PICTURE CD and CD-R or CD-RW that contains audio titles, MP3, WMA or JPEG files and SVCD also.

Notes

- Depending on the conditions of the recording equipment or the CD-R/RW (or DVD-R/±RW) disc itself, some CD-R/RW (or DVD-R/±RW) discs cannot be played on the unit.
- Do not attach any seal or label to either side (the labeled side or the recorded side) of a disc.
- Do not use irregular shaped CDs (e.g., heart-shaped or octagonal). It may result in malfunctions.

Notes on DVDs and Video CDs

Some playback operations of DVDs and Video CDs may be intentionally fixed by software manufacturers. As this unit plays DVDs and Video CDs according to disc content designed by the software manufacturer, some playback features of the unit may not be available, or other functions may be added. Refer also to the instructions applied with the DVDs and Video CDs. Some DVDs made for business purposes may not be played on the unit.

Regional code of the DVD player and DVDs

This DVD player is designed and manufactured for playback of region “5” encoded DVD software. The region code on the labels of some DVD discs indicates which type of player can play those discs. This unit can play only DVD discs labeled “5” or “ALL”. If you try to play any other discs, the message “Check Regional Code” will appear on the TV screen. Some DVD discs may not have a region code label even though their playback is prohibited by area limits.



Disc-related terms

Title (DVD only)

The main film content or accompanying feature content or additional feature content, or music album. Each title is assigned a title reference number enabling you to locate it easily.

Chapter (DVD only)

Sections of a picture or a musical piece that are smaller than titles.

A title is composed of one or several chapters. Each chapter is assigned a chapter number, enable you to locate the chapter you want. Depending on the disc, no chapters may be recorded.

Track (Video CD and audio CD only)

Sections of a picture or a musical piece on a video CD or an audio CD. Each track is assigned a track number, enabling you to locate the track you want.

Scene

On a video CD with PBC (Playback control) functions, moving pictures and still pictures are divided into sections called “Scenes”. Each scene is displayed in the menu screen and assigned a scene number, enabling you to locate the scene you want.

A scene is composed of one or several tracks.

Types of video CDs

There are two types of video CDs:

Video CDs equipped with PBC (Version 2.0)

PBC (Playback control) functions allow you to interact with the system via menus, search functions, or other typical computer-like operations. Moreover, still pictures of high resolution can be played if they are included in the disc.

Video CDs not equipped with PBC (Version 1.1)

Operated in the same way as audio CDs, these discs allow playback of video pictures as well as sound, but they are not equipped with PBC.

Before Use (Cont'd)

Precautions

Handling the unit

When shipping the unit

The original shipping carton and packing materials come in handy. For maximum protection, re-pack the unit as it was originally packed at the factory.

When setting the unit

The picture and sound of a nearby TV or radio may be distorted during playback. In this case, position the unit away from the TV or radio, or turn off the unit after removing the disc.

To keep the surface clean

Do not use volatile liquids, such as insecticide spray, near the unit. Do not leave rubber or plastic products in contact with the unit for a long period of time. They will leave marks on the surface.

Cleaning the unit

To clean the cabinet

Use a soft, dry cloth. If the surfaces are extremely dirty, use a soft cloth lightly moistened with a mild detergent solution. Do not use strong solvents, such as alcohol, benzene, or thinner, as these might damage the surface of the unit.

To obtain a clear picture

The DVD player is a high-tech, precision device. If the optical pick-up lens and disc drive parts are dirty or worn down, the picture quality will be poor. Regular inspection and maintenance are recommended after every 1,000 hours of use. (This depends on the operating environment.)
For details, please contact your nearest dealer.

Notes on Discs

Handling discs

Do not touch the playback side of the disc.
Hold the disc by the edges so that fingerprints will not get on the surface.
Do not stick paper or tape on the disc.

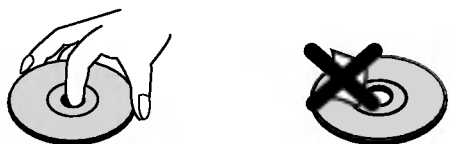

Storing discs

After playing, store the disc in its case. Do not expose the disc to direct sunlight or sources of heat, or leave it in a parked car exposed to direct sunlight, as there may be a considerable temperature increase inside the car.

Cleaning discs

Fingerprints and dust on the disc can cause poor picture quality and sound distortion. Before playing, clean the disc with a clean cloth. Wipe the disc from the center out.

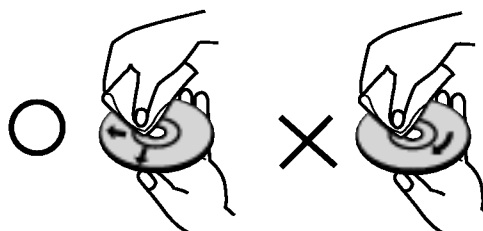

Do not use strong solvents such as alcohol, benzene, thinner, commercially available cleaners, or anti-static spray intended for older vinyl records.

About Symbols

About the symbol display

“” may appear on the TV screen during operation. This icon means the function explained in this owner's manual is not available on that specific DVD video disc.

About the disc symbols for instructions

A section whose title has one of the following symbol is applicable only to the disc represented by the symbol.

- DVD
- Video CDs with the PBC (playback control) function.
- Video CDs without the PBC (playback control) function.
- Audio CDs.
- MP3 disc.
- WMA disc.
- JPEG disc.

Front Panel and Display Window

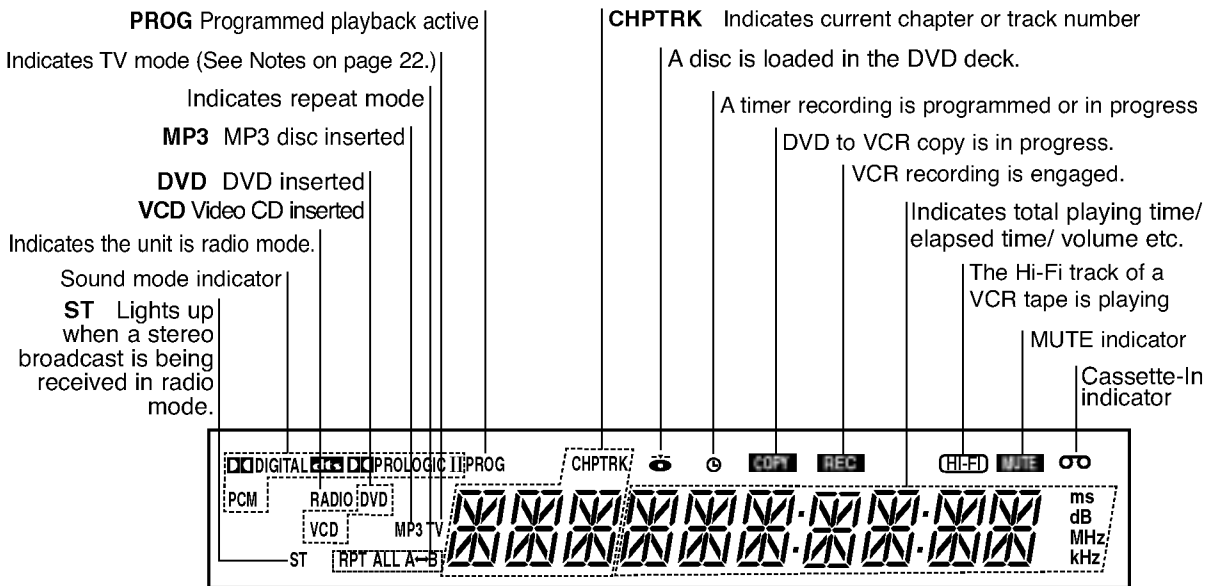
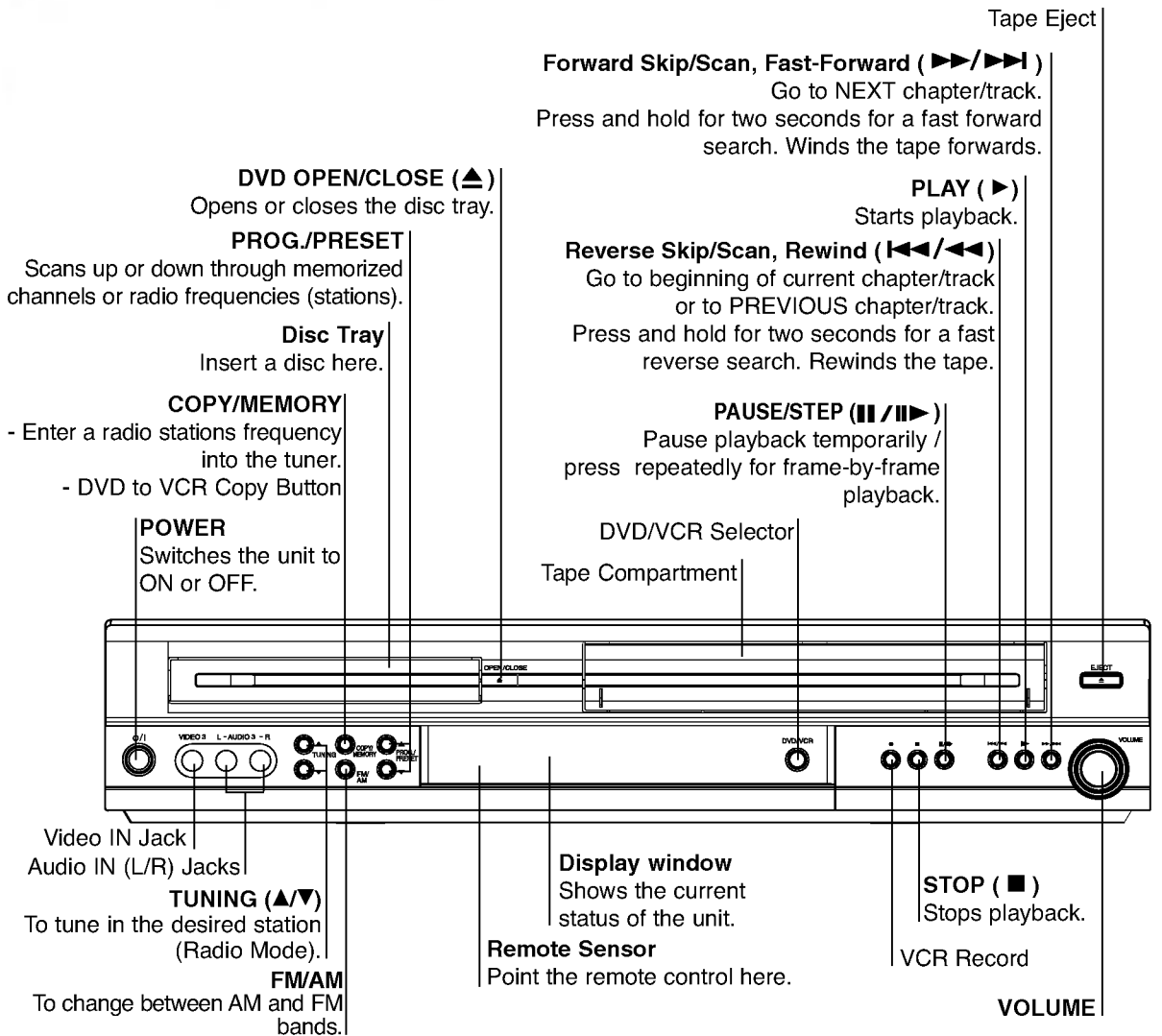

Remote Control

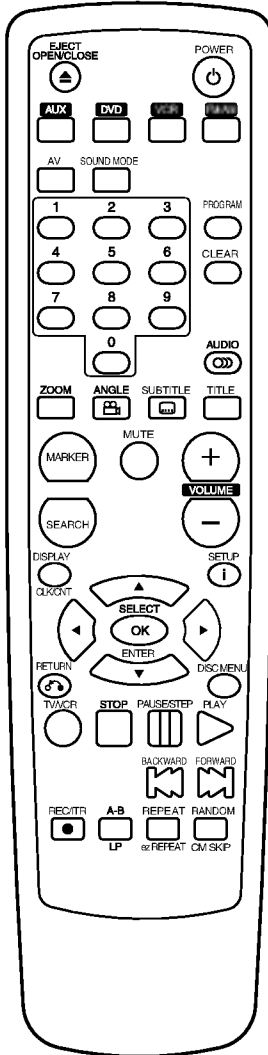

OPEN/CLOSE EJECT

- Open or close the disc tray.
- Tape Eject.

POWER

Switch this unit ON or OFF.

AUX

For selecting the digital signal from **DIGITAL AUDIO IN (OPTICAL)**.

DVD VCR select button

Selects operational mode of remote control.

FM/AM

Select this unit's tuner as the listening choice (FM or AM bands).

AV

Select input source for recording into tape.

SOUND MODE

0-9 numerical buttons

Select numbered items in a menu.

PROGRAM

Access or remove program menu.

CLEAR

- Clear a track number on the program menu or a mark on the MARKER SEARCH menu.
- Reset tape counter to zero.
- Press to clear preset stations from the tuner memory.

AUDIO

Select an audio language (DVD) or an audio channel (CD).

ZOOM

Enlarge video image.

ANGLE

Select DVD camera angle if available

SUBTITLE

Select a subtitle language.

TITLE

Display the title menu of the disc if available.

MARKER

Mark any point during playback.

SEARCH

Display MARKER SEARCH menu.

MUTE

Momentarily silence the speaker of the unit.

VOLUME (+/-)

DISPLAY CLK/CNT

Access the On-Screen Display. Shows you the current time or counter.

SETUP/ i

Access or remove setup menu.

◀ ▶ ▲ ▼ (left /right/up/down)

- Select an item in the menu
- Select programme of VCR or Tuner (▲/▼).
- Adjusts manually the tape's picture on screen (▲/▼).
- To tune in the desired radio stations (◀▶).

SELECT/ENTER/OK

- Acknowledge menu selection.
- Enter a radio stations frequency into the tuner.

RETURN

- Remove the setup menu.
- Displays the menu of a video CD with PBC.

DISC MENU

Access menu of a DVD disc.

TV/VCR

Switch between your TV's tuner and the VCR's internal tuner.

STOP (■)

Stops playback.

PAUSE/STEP

Pause playback temporarily / press repeatedly for frame-by-frame playback.

PLAY (▶)

Starts playback.

Reverse SKIP/SCAN (◀◀) / BACKWARD

- Search backward* / go to beginning of current chapter or track or go to previous chapter or track.
- Rewinds the tape.

* Press and hold button for about two seconds.

Forward SKIP/SCAN (▶▶) / FORWARD

- Search forward* / go to next chapter or track.
- Winds the tape forwards.

* Press and hold button for about two seconds.

REC/ITR

Record your input sources into tape.

A-B/LP

- Repeat sequence.
- Select the recording speed of the tape.

REPEAT/ez REPEAT

- Repeat chapter, track, title, all.
- ez REPEAT

RANDOM/CM SKIP

- Play tracks in random order.
- CM SKIP

Remote Control Operation Range

Point the remote control at the remote sensor and press the buttons.

- **Distance:** About 23 ft (7 m) from the front of the remote sensor
- **Angle:** About 30° in each direction of the front of the remote sensor

Remote control battery installation

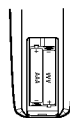

Detach the battery cover on the rear of the remote control, and insert two R03 (size AAA) batteries with + and - aligned correctly.



Caution
Do not mix old and new batteries. Never mix different types of batteries (standard, alkaline, etc.).

Rear Panel

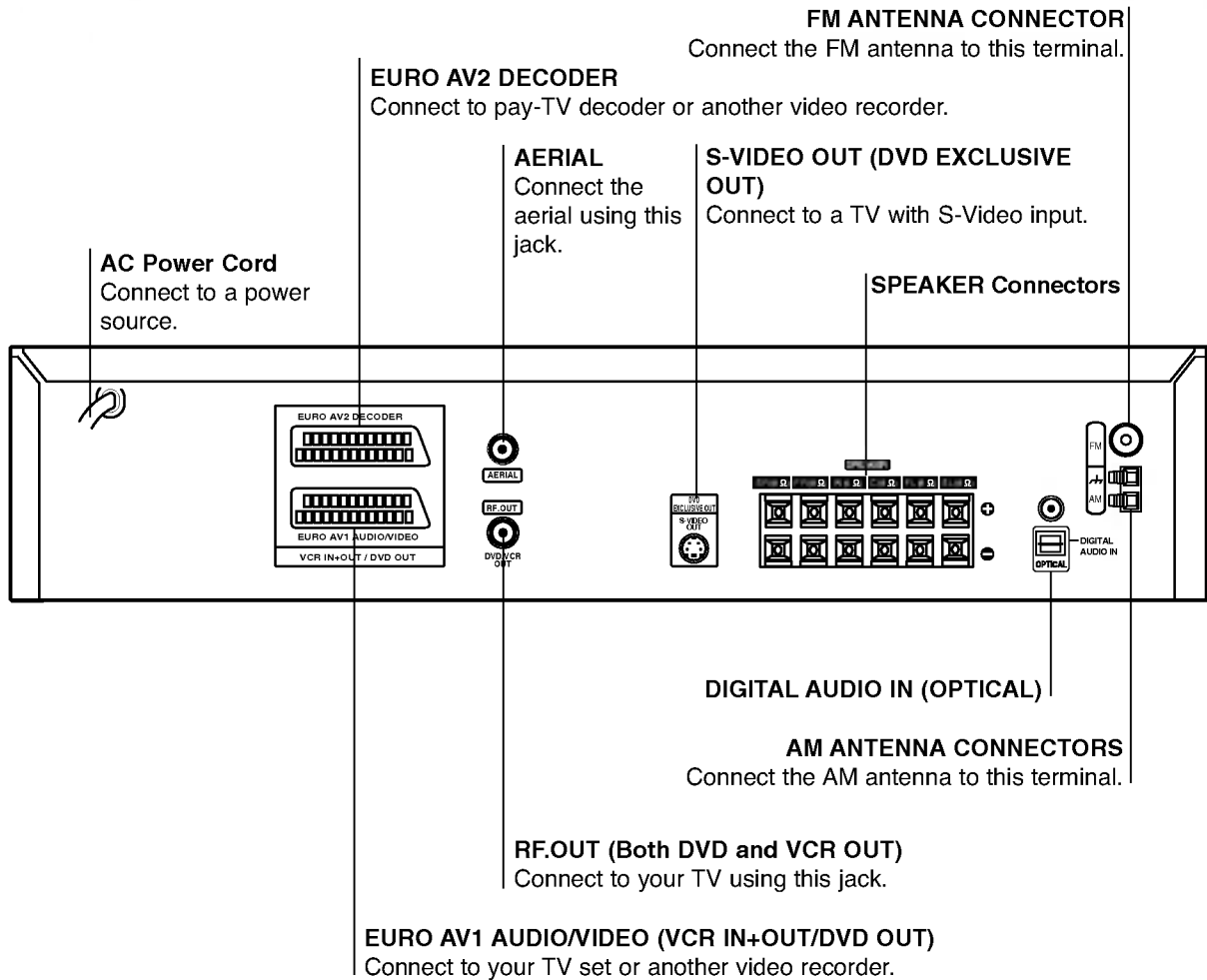

Dust protection cap

Remove the dust protection cap from the **DIGITAL AUDIO IN (OPTICAL)** jack and connect the optical digital cable (not supplied) securely so that the configurations of both the cable and the connector match. Keep the dust protection cap and always reattach the cap when not using the connector to protect against dust intrusion.

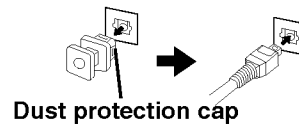

Do not touch the inner pins of the jacks on the rear panel. Electrostatic discharge may cause permanent damage to the unit.

Connections

Tips

- Depending on your TV and other equipment you wish to connect, there are various ways you could connect the unit.
- Please refer to the manuals of your TV, Stereo System or other devices as necessary to make the best connections.

Caution

- Make sure this unit is connected directly to the TV. Set the TV to the correct video input channel.

Connecting to a TV & Decoder (or Satellite)

- Make one of the following connections, depending on the capabilities of your existing equipment.

Basic connection (AV)

1 Connect the **EURO AV1 AUDIO/VIDEO** on the rear panel of this unit to the SCART input socket on the TV using a SCART lead.

2 Some TV broadcasters transmit encoded television signals which you can only see with a purchased or rented decoder. You can connect such a decoder (descrambler) to this unit.

Basic connection (RF)

1 Connect the RF antenna cable from your indoor/outdoor antenna to **AERIAL** jack on the rear panel of this unit.

2 Connect the supplied RF antenna cable from the **RF.OUT** jack on the rear panel of this unit to your television's Antenna Input.

S-Video connection

- You can only watch the DVD playback.

Connect the **S-VIDEO OUT** jack on this unit to the S-Video in jack on the TV using the optional S-Video cable.

Radio Aerial Connections

Connect the supplied FM/AM aerial for listening to the radio.

- Connect the AM loop aerial to the AM aerial connector.
- Connect the FM wire aerial to the FM aerial connector.

Notes

- To prevent noise pickup, keep the AM loop aerial away from this unit and other components.
- Be sure to fully extend the FM wire aerial.
- After connecting the FM wire aerial, keep it as horizontal as possible.

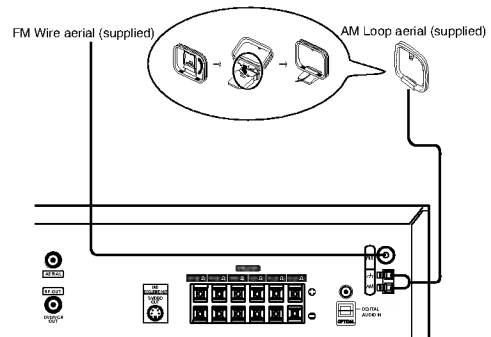
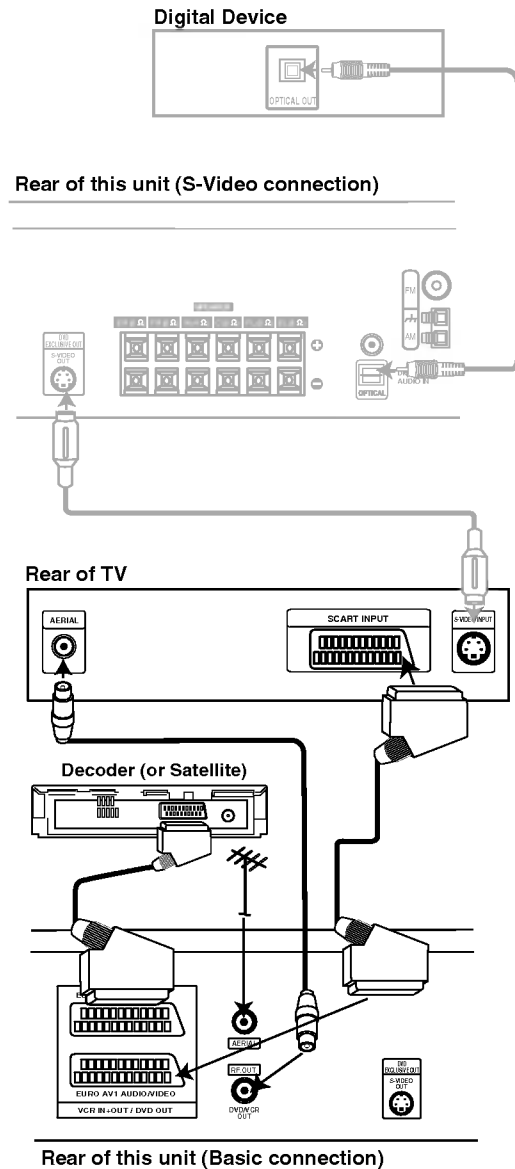

Connections (Continued)

Speaker System Connection

Connect the speakers using the supplied speaker cords. To obtain the best possible surround sound, adjust the speaker parameters (distance, level, etc.).

Notes

- Be sure to match the speaker cord to the appropriate terminal on the components: + to + and – to –. If the cords are reversed, the sound will be distorted and will lack base.
- If you use front speakers with low maximum input rating, adjust the volume carefully to avoid excessive output on the speakers.

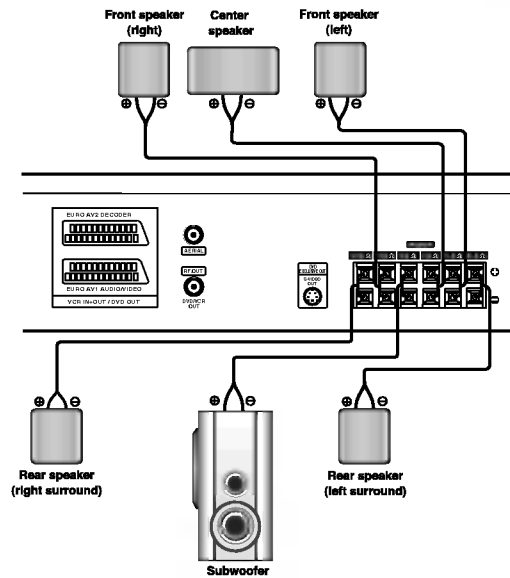

Important Note

About Ferrite Core

Be sure to attach the ferrite core to the speaker cables (for connecting to this unit).

This ferrite core can reduce noises.

How to attach the ferrite core.

- 1 Push the stopper [a] of the ferrite core to open.
- 2 Wind the Rear Speaker (Right Surround) cable once on one ferrite core. Pass the Front Speaker (Right) cable and the Subwoofer Speaker cable straight on one ferrite core. Wind the Rear Speaker (Left Surround) cable on the other ferrite core. Pass the Front Speaker (Left) cable and the Center Speaker cable straight on the other ferrite core.
- 3 Close the ferrite core until it clicks.

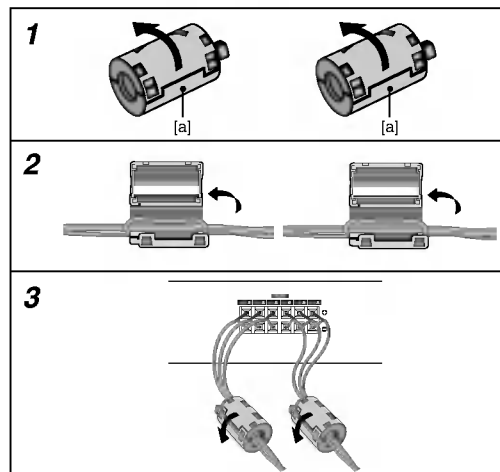

Speaker Positioning

In the case of normal position use the 6 speakers (2 front speakers, center speaker, 2 rear speakers and subwoofer).

If you want to play the excellent bass sound, DTS digital surround or Dolby Digital surround, you should connect a subwoofer.

• Front speakers

According to your listening position set up the speakers for equal distance. And by hearing position set up the interval between speakers to 45 degree.

• Center speaker

It is ideal that the center speakers and front speakers are same height. But normally place it above or below the television.

• Rear speakers

Place left and right behind the listening area. These speakers recreate sound motion and atmosphere required for surround playback. For best results, do not install the rear speakers too far behind the listening position and install them at or above the level of the listener's ears. It is also effective to direct the rear speakers towards a wall or ceiling to further disperse the sound.

In the case of a smaller room size, if the audience is near to the rear wall set the rear speakers opposite each other, and set the rear speakers above 60 - 90 cm than the listener's ears.

• Subwoofer

This can be placed in any front position.

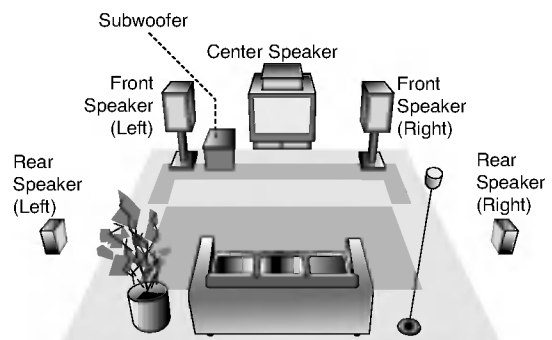

Speaker Positioning Example

Before Operation

Mini Glossary for Sound Mode

dts

Allows you to enjoy 5.1(or 6) discrete channels of high quality digital audio from DTS program sources such as discs, DVD and compact discs, etc.bearing the trademark. DTS Digital Surround delivers up to 6 channels of transparent audio(which means identical to the original masters) and results in exceptional clarity throughout a true 360 degree sound field. The term DTS is a trademark of DTS Technology, LLC. Manufactured under license from DTS Technology, LLC.

Dolby Digital

The Dolby Digital surround format lets you enjoy up to 5.1 channels of digital surround sound from a Dolby Digital program source. If you play DVDs with “” mark, you can enjoy even better sound quality, greater spatial accuracy, and improved dynamic range.

Dolby Pro Logic

Use this mode when playing movie or Dolby Digital 2 channel which carries the “” mark. This mode provides the effect of being in a movie theatre or live concert house—an effect with an intensity which can only be obtained through DOLBY PRO LOGIC SURROUND. The effect of the front/back/left/right movement of the sound image, as well as the sense of fixed position in the sound image, is much clearer and more dynamic than before.

Dolby Pro Logic II

Dolby Pro Logic II creates five full-bandwidth output channels from two-channel sources. This is done using an advanced, high-purity matrix surround decoder that extracts the spatial properties of the original recording without adding any new sounds or tonal colorations.

MOVIE mode:

The Movie mode is for use with stereo television shows and all programs encoded in Dolby Surround. The result is enhanced soundfield directionality that approaches the quality of discrete 5.1-channel sound.

MUSIC mode:

The Music mode is for use with any stereo music recordings, and provides a wide and deep sound space. The Music mode includes controls that allow the sound to be tailored to individual listening tastes.

MATRIX mode:

The Matrix mode is the same as the Music mode except that the directional enhancement logic is turned off. It may be used to enhance mono signals by making them seem “larger.” The Matrix mode may also find use in auto systems, where the fluctuations from poor FM stereo reception can otherwise cause disturbing surround signals from a logic decoder. The ultimate “cure” for poor FM stereo reception may be simply to force the audio to mono.

3D SURROUND

This unit can produce a 3D Surround effect, using 3D Surround Sound technology, which simulates multi-channel audio playback from two conventional stereo speakers instead of the five or more speakers normally required to listen to multi-channel audio from a home theatre. This feature works with DVD discs encoded with Dolby Pro Logic and Dolby Digital audio tracks.

BYPASS

Software with multichannel surround audio signals is played according to the way it was recorded.

Sound Mode

You can enjoy surround sound simply by selecting one of the pre-programmed sound fields according to the program you want to listen to.

Press **SOUND MODE** repeatedly until the sound mode you want appears in the display window as below.

Each time you press **SOUND MODE** button, the sound mode is changed in the following order;



PROL (PRO LOGIC) → PROLOGIC II MOVIE → PROLOGIC II MUSIC → PROLOGIC II MTRX (MATRIX) → 3D SUR (3D SURROUND) → BYPASS

When DVD is inserted.



You can change the stream of DVD (Dolby Digital, DTS, PCM, etc) by pressing the **AUDIO** button on the remote during playback.

Although the DVD contents differ from disc to disc, the following explains the basic operation when this feature is used.

Each time you press **AUDIO** button, the sound mode of DVD is changed as the following order;

 → **dts** → **PCM** → 

For your reference

- This unit memorizes the last mode settings for each source individually.
- You can identify the encoding format of program software by looking at its packaging.
 - Dolby Digital discs are labeled with the  logo.
 - Dolby Surround encoded programs are labeled with the  logo.
 - DTS Digital Surround discs are marked with DTS.

Note

- When you play sound tracks with 96kHz sampling frequency, the output signals will be converted to 48kHz (sampling frequency).

Before Operation - VCR part

Tuning in a video channel on your TV

Notes

- The output frequency of this video recorder (VCR) is set at UHF channel 36. If channel 36 is already used by another TV station, or if the picture is distorted, you can change the transmitter channel of your VCR. Stages 5 ~ 8 will show you how to change the output frequency of your VCR.
- Your TV receives signals from the video recorder (VCR) like another TV station. You have to select a channel number on your TV and tune it in so that you may watch video tapes. If you have used a **SCART** cable then your TV should already have a dedicated video channel built into it, usually called **AV**.

1 Make sure that you have correctly installed your VCR as described earlier in this book. Press **POWER** to turn on your VCR. Turn on your TV.

2 Insert a pre-recorded video tape into your VCR and press **PLAY** on the remote control. Select a TV channel number on which you wish to watch video's. Don't worry if you don't have a video-tape to play at this stage! If you switch your VCR on and continue stages 3 ~ 4, instead of seeing video playback tune your TV until you see a bright blue screen.

3 Tune this channel until the video picture is sharp and the sound is clear. If you have used a **SCART** cable you will not have to tune your TV, simply select the AV channel. The **AV** channel is already pre-tuned for optimum video playback on your TV.

4 Store this channel on your TV. You will need to look at the TV instruction book if you do not know how to do this.

5 **Only carry out stages 5 ~ 8 if you cannot obtain clear video playback as described in stages 1 ~ 4.** Select a TV channel number on which you wish to watch video's. Make sure that your VCR is in standby pressing **POWER** on the remote control (only the clock will be displayed).

6 Press **PROG. ▲** or **▼** on the front of your VCR for more than 4 seconds. **RF36** will appear in the display window. The following picture will be displayed on the TV screen.

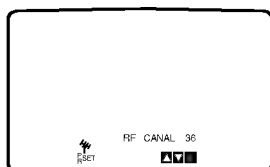

7 Press **PROG. ▲** or **▼** to select another video channel. You may select any channel number between 22 and 68.

You can also set it to "OFF" if there is any interference when your TV is connected to the VCR with a SCART lead.

8 Select a TV channel number on which you wish to watch video's. Press **0/1** on the front of your VCR when you have finished. Tune this channel so that a bright blue screen appears. Store this channel on your TV.

Notes

Make sure that you have correctly installed your VCR and successfully tuned in a dedicated video channel on your TV. If you do not tune in a dedicated video channel on your TV you will be unable to view and record video tapes!

Using your VCR for the very first time

Following picture will display on the TV screen when you have just connected your video recorder for the very first time.

To make tuning TV stations, please follow stages 3 to 4 as shown "ACMS" (see p.14).

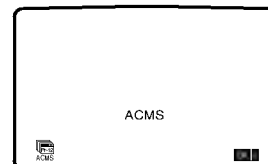

Before Operation - VCR part

Setting the clock Manually

The clock in your VCR controls time and date settings for your VCR.

- 1 Press **i**.
Press **◀** or **▶** to select **TIME DATE**.
Press **OK**.

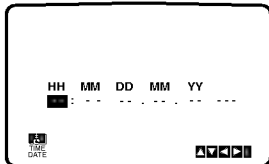

- 2 Use the **numbered buttons** on the remote control to alter the **HOURS, MINUTES, DAY, MONTH** and **YEAR**.
Please note your VCR uses a 24 hour clock. e.g. 1pm will be displayed as 13:00.
The day of the week will appear automatically when you enter the year.

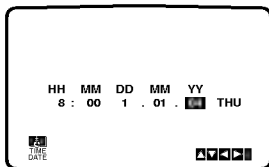

- 3 If you make a mistake press **◀** or **▶** and enter the correct details.
- 4 Press **i**.

To set the colour system

- 1 Press **i**.
- 2 The main menu will appear on the TV screen.
- 3 Press **◀** or **▶** to select the **SYSTEM** and press **OK**.
- 4 Press **▲** or **▼** to select according to the **COLOUR** system used.

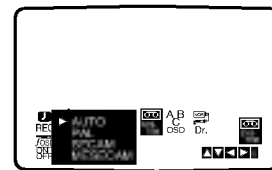

- 5 Press **◀** or **▶** to select the **RF AUDIO**. Press **▲** or **▼** to select according to the **RF AUDIO** used.

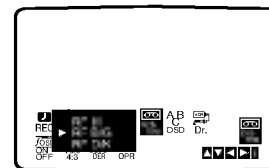

- 6 Press **i** to remove the menus from the TV screen.

Before Operation - VCR part

How to using the main menu

This VCR can easily be programmed by using the menus displayed on screen.

The menus are controlled from the Remote Control Handset.

- 1** Switch on your TV set and video recorder by pressing the **POWER** button.
- 2** Press **i** button.
The main menu will appear on the TV screen.

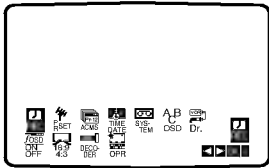

- **REC** - Timer recording setting (see p. 23).
- **PR SET** - Manual tuning setting (see p. 15).
- **ACMS** - ACMS (Automatic Channel Memory System) (see p. 14).
- **TIME DATE** - Date & clock setting (see p. 13).
- **SYSTEM** - To set the Colour TV System (see p. 13).
- **RF AUDIO** - To select the channel of audio output according to your TV type ("B/G" for PAL B/G TV, "D/K" for PAL D/K TV, "I/I" for PAL I/I TV) (see p. 13).
- **ABC OSD** - To change the language setting for OSD.
You can select the language among English, Deutsch, Français, Italiano, Español, Dutch and Portuguese.
- **Dr.** - To check a problem with your VCR (see p. 31).
- **F.OSD ON/OFF** - To display the operational mode of your VCR (see p. 31).
- **16:9/4:3** - To select the aspect ratio of your TV (see p.32).
- **DECODER** - To use a pay-TV decoder (or Satellite) with your VCR (see p. 32).
- **OPR** - To improve the playback picture (see p. 21).

3 Press **◀** and **▶** to select the desired menu.
Press **OK** and press **▲** or **▼** to select.

4 Press **"i"** to return to a TV picture.

Tuning in TV Stations Automatically

If the TV broadcast signal is weak your VCR may not detect the necessary information and will not be able to store them correctly. To overcome this problem please turn to the **MANUAL TUNING** section on page 15.

- 1** Press **POWER** to turn on your VCR.
- 2** Press **i** button.
The main menu will appear on the TV screen.
Press **◀** or **▶** to select the **ACMS**.
Press **OK**.

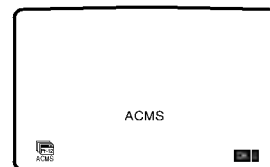
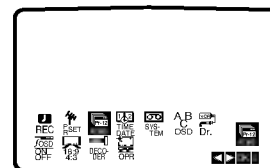

3 Press **OK** again to start the automatic tuning process.



4 The **TV STATION TABLE** will appear when tuning is complete.
Press **i** to save your settings.

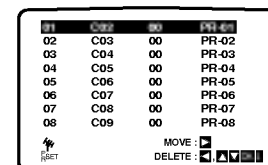

Before Operation - VCR part

Tuning in TV Stations Manually

In certain areas of the country broadcast signals may be too weak for your VCR's automatic tuning process to find or assign TV stations correctly. You must tune in these weaker broadcast stations manually in order for your VCR to store them.

- 1 Press **i**.
The main menu will appear on the TV screen.
Press **◀** or **▶** to select the **PR SET**.
Press **OK**.

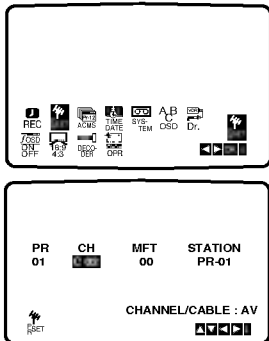

- 2 Press **i**.
The station table will appear.
Press **▲** or **▼** to select the programme number that you want to tune (for example, PR 09).

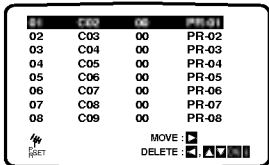

- 3 Press **OK**.
Press **AV** to select **C** (Standard stations) or **S** (Cable stations):
C02 - C69, S01 - S41.
Enter the channel number of station that you want to tune with **the numbered buttons** or use **▲** or **▼** to find the required station.

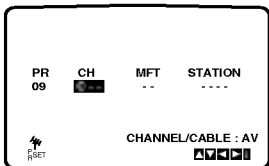

- 4 Searching will stop when it locates a stations.
Press **▶** to select **MFT**.
Press **▲** or **▼** to adjust.

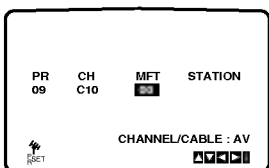

- 5 Press **▶** to select **STATION** so that you may name your TV station.
Press **OK**.

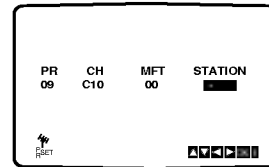

- 6 Press **▲** or **▼** to select **letters** and **numbers** for the new station name.
Press **◀** or **▶** to move back and forth between characters.
Press **OK**.

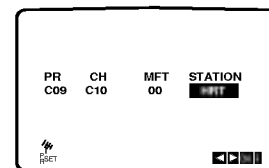

- 7 Press **i**, confirm the station placement.
Press **i** again.
Your new TV station has now been tuned into your VCR.
If you wish to manually tune other stations repeat stages 1 - 7.

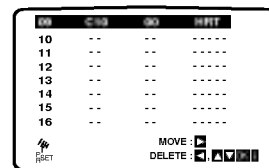

Before Operation - VCR part

Changing the order of TV Stations

After tuning TV stations into your VCR you may wish to change the order in which they are stored without having to retune them! The instructions given on this page will show you how you can simply move them into your desired order.

- 1 Press **i**.
The main menu will appear on the TV screen.
Press **◀** or **▶** to select the **PR SET**.
Press **OK**.

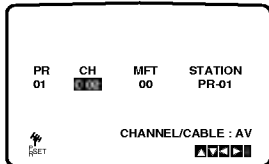
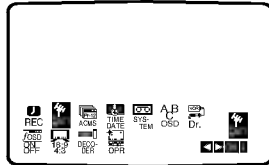

- 2 Press **i**.
Press **▲** or **▼** to select the **programme number** you want to move (for example, PR 03).
Press **▶**.

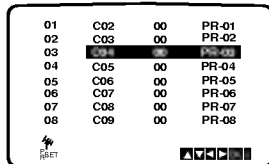
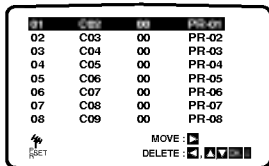

- 3 Press **▲** or **▼** to select the **programme number** you want to move to (for example, PR 05).

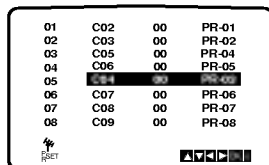

- 4 Press **OK**.
The selected **programme** will be moved to the **new programme number**.
If you wish to move other TV stations repeat stages 1 - 4.
Press **i** to remove the menus from the TV screen.

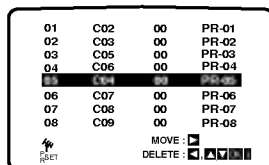

Deleting TV Stations

After tuning TV stations into your VCR you may wish to delete a station.
The instructions given on this page will show you how easily delete any unwanted TV stations.

- 1 Press **i**.
The main menu will appear on the TV screen.
Press **◀** or **▶** to select the **PR SET**.
Press **OK**.

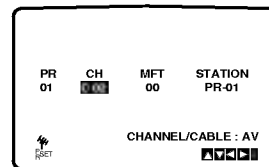
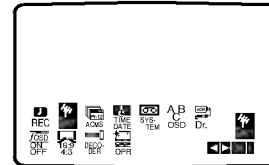

- 2 Press **i**.
Press **▲** or **▼** to select the **programme number** you want to delete. (for example, PR 03)

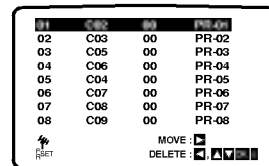

- 3 Press **◀**.
After a short while, the selected station will be deleted.

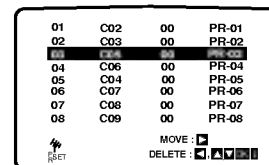

- 4 Press **i** to remove the menus from the TV screen.
If you wish to delete other TV stations repeat stages 1 - 3.

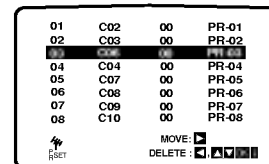

How to selecting Stored TV stations:

Stored TV stations can be selected in either of two ways.
Press **PROG.** **▲** or **▼** to select different stations that are tuned into your VCR.

You may also directly select stations using the **numbered buttons** on the remote control.

Before Operation - DVD part

General Explanation

This manual gives the basic instructions for operating this unit. Some DVDs require specific operation or allow only limited operation during playback. When this occurs, the symbol  appears on the TV screen, indicating that the operation is not permitted by this unit or is not available on the disc.









On-Screen Display

The general playback status can be displayed on the TV screen. Some items can be changed on the menu.

On-screen display operation

- 1** Press **DISPLAY** during playback.
- 2** Press **▲** or **▼** to select an item.
The selected item will be highlighted.
- 3** Press **◀** or **▶** to change the setting of an item.
The number buttons can be also be used for setting numbers (e.g., title number). For some functions, press **SELECT/ENTER** to execute the setting.







Temporary Feedback Field Icons

-  **TITLE** Repeat Title
-  **CHAPT** Repeat Chapter
-  **TRACK** Repeat Track (non-PBC Video CDs only)
-  **ALL** Repeat All Tracks (non-PBC Video CDs only)
-  **A B** Repeat A-B
-  **OFF** Repeat Off
-  Resume play from this point
-  Action prohibited or not available





Notes

- Some discs may not provide all of the below On-Screen Display.
- If no button is pressed for 10 seconds, the On-Screen Display disappears.

DVD

Items	Function (Press ▲/▼ to select desired item)	Selection Method
Title Number	 1 / 3 Shows the current title number and total number of titles, and skips to the desired title number.	◀ / ▶, or Numbers, SELECT/ENTER
Chapter Number	 1 / 12 Shows the current chapter number and total number of chapters, and skips to the desired chapter number.	◀ / ▶, or Numbers, SELECT/ENTER
Time search	 0:20:09 Shows the elapsed playing time, and searches the point by the elapsed time directly.	Numbers, SELECT/ENTER
Audio language and Digital Audio Output mode	 1 ENG D D D 5.1 CH Shows the current audio soundtrack language, encoding method, and channel number, and changes the setting.	◀ / ▶, or AUDIO
Subtitle language	 OFF Shows the current subtitles language, and changes the setting.	◀ / ▶, or SUBTITLE
Angle	 1 / 1 Shows the current angle number and total number of angles, and changes the angle number.	◀ / ▶, or ANGLE
Sound	 BYPASS Shows the current sound mode, and changes the setting.	◀ / ▶, or SOUND MODE

VCD2.0 VCD1.1

Items	Function (Press ▲/▼ to select desired item)	Selection Method
Track Number	 1 / 4 Shows the current track number, total number of tracks and PBC On mode, and skip to the desired track number.	◀ / ▶, or Numeric, SELECT/ENTER
Time	 0:20:09 Shows the elapsed playing time (Display only)	-
Audio Channel	 STER. Shows the audio channel, and changes the audio channel.	◀ / ▶, or AUDIO
Sound	 BYPASS Shows the current sound mode, and changes the setting.	◀ / ▶, or SOUND MODE

Before Operation (Continued) - DVD part

Initial Settings

You can set your own Personal Preferences on this unit.

Initial Settings General Operation

- 1 Press **SETUP**.
The setup menu appears.



- 2 Press **▲/▼** to select the desired item.
The screen will show the current setting for the selected item, as well as alternate setting(s).
- 3 While the desired item is selected, press **▶**, then **▲/▼** to select the desired setting.
- 4 Press **SELECT/ENTER** to confirm your selection.
Some items require additional steps.
- 5 Press **SETUP**, **RETURN** or **PLAY** to exit the setup menu.

Language

Disc Language **DVD**

Select a language for the disc's Menu, Audio, and Subtitle.

Original : The original language set for the disc is selected.
Other : To select another language, press number buttons to enter the corresponding 4-digit number according to the language code list on page 39. If you enter the wrong language code, press **CLEAR**.

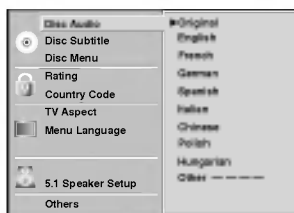

Menu Language

Select a language for the setup menu. This is the menu you see when you press **SETUP**.

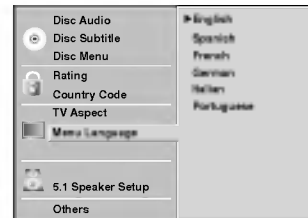

Picture

TV Aspect **DVD**

- 4:3 Letterbox**: Select when a standard 4:3 TV is connected. Displays theatrical images with masking bars above and below the picture.
- 4:3 Panscan**: Select when a conventional TV set is connected. The video material formatted in the Pan & Scan style is played back in that style (Both sides of the picture are cut off).
- 16:9 Wide**: Select when a 16:9 wide TV is connected.



Before Operation (Continued) - DVD part

5.1 Speaker settings **DVD**

Select speaker settings, including volume balance and delay time, or test the speaker settings.

Speaker settings are only active on the Analog Multi-Channel Output. (See "Speaker Settings", page 37.)

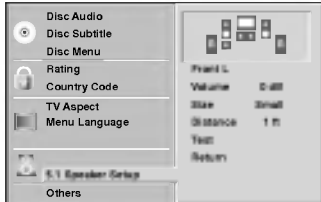

Others

The DRC, Vocal, PBC and Auto Play settings can be changed.

- Press ▲/▼ to select the desired item and press SELECT/ENTER. The setting of the selected item is changed between On and Off.



Dynamic Range Control (DRC)

With the DVD format, you can hear a program's soundtrack in the most accurate and realistic presentation possible, thanks to digital audio technology. However, you may wish to compress the dynamic range of the audio output (the difference between the loudest sounds and the quietest ones). Then, you may listen to a movie at a lower volume without losing clarity of sound. Set DRC to On for this effect.

Vocal

Set Vocal to On only when a multi-channel karaoke DVD is playing. The karaoke channels on the disc will mix into a normal stereo sound.

PBC

Set Playback Control (PBC) to On or Off.

- On:** Video CDs with PBC are played according to the PBC.
- Off:** Video CDs with PBC are played the same way as Audio CDs.

Auto Play **DVD**

You can set up the DVD Player so a DVD disc automatically starts playing whenever the DVD is inserted.

If Auto Play mode is set to On, this DVD player will search a title that playback time is long most and then play back the title automatically.

- On:** Auto Play function is activated.
- Off:** Auto Play function is not activated.

Note

The Auto Play function may not work for some DVDs.

Before Operation (Continued) - DVD part

Parental Control

Rating **DVD**

Movies on DVDs may contain scenes not suitable for children. Therefore, discs may contain Parental Control information that applies to the complete disc or to certain scenes on the disc. These scenes are rated from 1 to 8, and alternatively, more suitable scenes are available for selection on some discs. Ratings are country-dependent. The Parental Control feature allows you to prevent discs from being played by your children or to have certain discs played with alternative scenes.



1 Select "Rating" on the Setup menu using the ▲ and ▼ buttons.

2 While "Rating" is selected, press ►.

3 When you have not entered a password yet. Enter a 4-digit password using the numbered buttons to create a personal 4-digit security password, then press SELECT/ENTER. Enter the 4-digit password again and press SELECT/ENTER to verify. **When you have already entered a password;** Enter a 4-digit password using the numbered buttons to confirm the personal 4-digit security password, then press SELECT/ENTER.

If you make a mistake before pressing SELECT/ENTER, press CLEAR and enter 4-digit security password again.

4 Select a rating from 1 to 8 using the ▲/▼ buttons. One (1) has the least playback restrictions. Eight (8) has the most playback restrictions.

Unlock: If you select Unlock, Parental Control is not active. The disc will play in full.

Ratings 1 to 8: Some discs contain scenes not suitable for children. If you set a rating for the player, all disc scenes with the same rating or lower will be played. Higher rated scenes will not be played unless an alternative scene is available on the disc. The alternative must have the same rating or a lower one. If no suitable alternative is found, playback will stop. You must enter the 4-digit password or change the rating level in order to play the disc.

5 Press SELECT/ENTER to confirm your rating selection, then press SETUP to exit the menu.

Country Code **DVD**

Enter the code of a country/area whose standards were used to rate the DVD video disc, referring to the list (See "Country Code List", page 40.).



1 Select Country Code using the ▲/▼ buttons on the setup menu.

2 While Country Code is selected, press ►.

3 Follow step 3 of "Rating" on left.

4 Select the first character using the ▲/▼ buttons.

5 Shift the cursor using ◀▶ buttons and select the second character using ▲/▼ buttons.

6 Press SELECT/ENTER to confirm your country code selection, then press SETUP to exit the menu.

Note

Confirmation of the 4-digit password is necessary when the code is changed (see "Changing the 4-digit code" below).

Changing the 4-digit code

- 1 Follow Steps 1-2 as shown above to the left (Rating).
- 2 Enter the old code, then press SELECT/ENTER.
- 3 Select Change using the ▲/▼ buttons then press SELECT/ENTER.
- 4 Enter the new 4-digit code, then press SELECT/ENTER.
- 5 Enter exactly the same code a second time and verify by pressing SELECT/ENTER.
- 6 Press SETUP to exit the menu.

If you forget your 4-digit code

If you forget your password, to clear the current password, follow the procedure below.

- 1 Press SETUP to display the setup menu.
- 2 Use the Number buttons to enter the 6-digit number "210499".
The 4-digit password is cleared.
- 3 Enter a new code as shown above to the left (Rating).

Operation with tape

Playing a tape

You will only be able to load and eject video cassettes when your VCR is plugged into the mains. Your VCR may also playback recordings from NTSC tapes (on PAL TV).

Getting a better picture

When a cassette is inserted and playback started, the automatic tracking function works to get the best possible picture automatically. If the quality of the recording is poor, repeatedly press ▲ or ▼ on the remote control to manually adjust the tracking until any distortions have been removed. Press numbered 0 on the remote control to switch automatic tracking back on again.

1 Make sure that you have correctly connected your VCR as described earlier in this book. Turn on your TV. Press **POWER** to turn on your VCR. Insert the video cassette into your VCR. The video cassette should have the window side facing up and the arrow facing away from you.

2 Press **PLAY** to start playing your tape. If you load a video cassette which has had its record protection tab removed, playback of the cassette will start automatically.

AUTO TRACKING

Your VCR will automatically adjust the tracking to give the best picture quality.

3 Press **PAUSE/STEP** to still a picture. Press **PAUSE/STEP** repeatedly to advance the tape frame by frame. If you press **FORWARD**, the picture will be slowed down at about 1/19 times the normal playback. Tapes can be paused for up to 5 minutes. After 5 minutes your VCR will stop the tape to prevent damaging the tape or your VCR. Still picture quality can be improved slightly by pressing ▲ or ▼.

4 Press **PLAY** to continue playing your tape.
Picture search:
During playing back press either **FORWARD** or **BACKWARD** and this will enable you to rapidly wind the tape (7 times normal playback) and see where you are on the tape.

Logic search:

During fast forwarding or rewinding press and hold **FORWARD** or **BACKWARD** the picture will be played back at 7 times normal playback speed.

5 **Slow motion playback, Shuttle :**
During playing back or still picture press ◀ or ▶. You can reach the following playback speeds. (-7xplay, -3xplay, -play, still, 1/19 slow, play, 2xplay, 7xplay)
To switch off the slow motion and shuttle, press the desired function.
During slow motion and shuttle, the noise bars may appear on the picture according to the status of tape.
If distortions can be seen in the picture, reduce them with ▲ or ▼.

6 Press **STOP** to end playback. Press **EJECT**.
If the end of the tape is reached, your VCR will stop playback automatically, rewind, stop, eject the tape.

CM (Commercial Message) Skip:

This feature enables you during playback of a tape to skip a commercial break in a few seconds, then resume normal playback.

While tape is playing press **CM SKIP** on the remote control to skip commercial (or another programme material).

Repeatedly press **CM SKIP** to skip:

- 1 Press 30 seconds
- 2 Press 60 seconds
- 3 Press 90 seconds
- 4 Press 120 seconds
- 5 Press 150 seconds
- 6 Press 180 seconds

OPR (Optimum Picture Response)

This feature automatically improves playback picture quality by adjusting your VCR to the condition of the tape.

- 1** Press **i**.
- 2** Press ◀ or ▶ to select OPR.
- 3** Press **OK**.

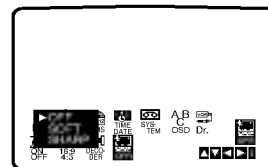

4 Press ▲ or ▼ repeatedly to select: **OFF**, **SOFT** or **SHARP**.

Please note you may only set OPR when playing a tape.

5 Press **i** return to screen.

Operation with tape

Instant Timer Recording (ITR)

Your VCR allows you to make recordings using a variety of simple methods:

Instant Timer Recording (ITR) start recording immediately for a set period of time or until the video cassette runs out.

Your VCR incorporates Long Play (LP) which enables you to record up to twice the amount of time on a video cassette. For example an E-180 will record up to 180 minutes using Standard Play (SP); using LP you will be able to record up to 360 minutes. Please note there will be a slight loss in picture and sound quality when using LP.

- 1** Make sure that you have correctly connected your VCR as described earlier in this book.
Press **POWER** to turn on your VCR.
- 2** Insert a video cassette with protection tab into your VCR.
The video cassette should have the window side facing up and the arrow facing away from you.
- 3** Press **▲** or **▼** to select the **programme number** you wish to record.
You may also directly select programme number using the **numbered buttons** on the remote control.
- 4** If you wish to record directly from the SCART or RCA sockets repeatedly press **AV** until the socket you wish to record from is displayed.

AV 1 Sound and Picture recording using the lower SCART socket on the back of your VCR.

AV 2 Sound and Picture recording using the upper SCART socket on the back of your VCR.

AV 3 for recording from VIDEO IN and AUDIO IN (Left & Right) sockets on the front of your unit.

5 Press **LP** if you wish to record in Long Play or Standard Play.
SP will produce improved picture and sound quality, however LP will provide twice as much recording time as SP.

6 Press **REC/ITR** to start recording.
RECORD will appear on the TV screen.
Press **REC/ITR** several times. Each successive press will increase the record time by 30 minutes until you reach a maximum of 9 hours.

7 Press **PAUSE/STEP** to avoid recording unwanted scenes.
Press **PAUSE/STEP** to continue recording.
If you press **PAUSE/STEP** during ITR, this unit will enter the record pause mode and ITR is cancelled. Tapes can be paused for up to 5 minutes; **RECP** will be displayed when a tape is paused. After 5 minutes your VCR will stop recording to prevent damaging the tape or your VCR.

8 Press **STOP** twice within 5 seconds to end recording.
Press **EJECT**.
EJECT will appear on the TV screen for a few seconds.

N Notes

- If you do not wish to record on a tape (this can happen quite easily by accident!) remove the protection tab on the back edge of the video cassette.
- It is possible to record on a video cassette with the record protection tab removed by covering the hole with self adhesive tape.
- Remember you can record one programme while watching another by starting your instant recording, press **TV/VCR** to appear **TV** indicator in the display window and then selecting a different channel on your TV.

Operation with tape

Timer recording using On Screen Display

You may set up to seven timer record events within one month of the current date.

Note

Before setting the timer make sure that you have set the VCR clock correctly and you know which stations you have tuned TV stations on your VCR.

1 Insert a video cassette with protection tab into your VCR.

The video cassette should have the window side facing up and the arrow facing away from you.

2 Press **i**.

Press **◀** or **▶** to select **REC**.

Press **OK**.

3 Press **OK** to start setting the timer record event. If all timer record events are full press **▲** or **▼** to select the event that you wish to remove and replace.

Press **◀** to delete the event.

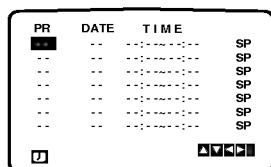

4 Press the **numbered buttons** to enter the station that you wish to record.

When selecting stations 1 - 9, press 0 first, then the channel number; for example PR NO.1 as 01. You may also select programme numbers by pressing **▲** or **▼**. Once selected press **▶**.

If you wish to record from AUDIO IN (L/R) and VIDEO IN on the front or from the EURO SCART sockets on the back of your unit, press **AV** to select for correct display (AV1, AV2 or AV3).

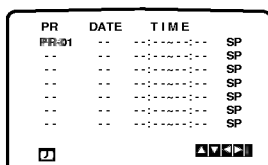

5 Press the **numbered buttons** to enter the date of the programme.

If you press **OK** before entering the date you may select one of the following automated recording features. Press **◀** or **▶** to select, then press **OK** to confirm.

DLY To record every day (except Saturday and Sunday) at the same time.

SU ~ SA To record at the same time every week.

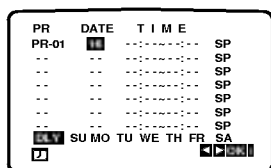

6 Press the **numbered buttons** to enter the recording start and end times of the programme that you wish to record. Please note your VCR uses a 24 hour clock. e.g. 1pm will be displayed as 13:00.

You may also select the the start and end times by pressing **▲** or **▼**.

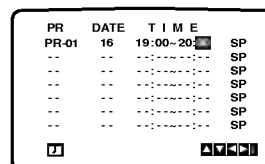

7 Press **▶** to select the recording speed.

Press **▲** or **▼** to select the desired tape speed (SP, IP, or LP). IP mode determines how much tape is left and switches speed from SP to LP, if necessary, to complete recording the program.

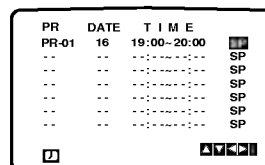

8 Check that the timer event details are correct.

Press **i** to save your settings.

If **PLEASE CHECK** is displayed, you have entered incorrect and will need to re-enter the data.

Press **POWER** to switch your VCR Standby.

Ⓞ will appear in the video recorder's display while your VCR waits to make the recording. To watch a DVD during timer recording standby mode, press **POWER** and **DVD** to switch to DVD mode.

9 Press **POWER** twice within 5 seconds to end recording.

Notes

- If at a later date you wish to **delete** or **change** any of the settings in timer event memory you may do so without having to enter all the timer event information again. Simply display the timer event screen. Press **▲** or **▼** to select the event that you wish to **delete** or **change**.

Press **◀** to delete the event...or

Press **OK** to change; then press **◀** or **▶** to select; Station, Date, Start and End times and LP. Press **▲** or **▼** to enter the correct information.

- If Timer record events Overlap...**

Make sure that the preset times of the timer recording events do not overlap. If they do, the earlier programme will always be given priority.

Example:

Programme 1 is programmed to start at 16:00 and end at 17:00.

Programme 2 is programmed to start at 16:30 and end at 17:30.

(In this case, Programme 1 will be recorded in its entirety, but only the last 30 minutes of Programme 2 will be recorded.)

Operation with DVD and Video CD

Playing a DVD and Video CD

Playback Setup

- Turn on the TV and select the video input source connected to the DVD player.
- Audio system: Turn on the audio system and select the input source connected to the DVD player.

1 Press OPEN/CLOSE to open the disc tray.

2 Load your chosen disc in the tray, with the label facing up.

When a double-sided DVD is inserted, make sure the side you want to play is facing down.

3 Press OPEN/CLOSE to close the tray. READING appears on the TV screen, and playback starts automatically. If playback does not start, press PLAY.

In some cases, the disc menu might appear instead.

If a menu screen is displayed

The menu screen may be displayed first after loading a DVD or Video CD which contains a menu.

Use the ◀ ▶ ▲ ▼ buttons to select the title/chapter you want to view, then press SELECT/ENTER to start playback.

Press TITLE or DISC MENU to return to the menu screen.

- Use the number buttons to select the track you want to view.
Press RETURN to return to the menu screen.
- Menu setting and the exact operating procedures for using the menu may differ depending on the disc. Follow the instructions on the each menu screen. You also may set PBC to Off under setup. See page 19.

Notes

- If Parental Control is set and the disc is not within the Rating settings (not authorized), the 4-digit code must be entered and/or the disc must be authorized (see “Parental Control”, on page 20).
- DVDs may have a region code.
- Your player will not play discs that have a region code different from your player. The region code for this player is 5 (five).
- To watch a DVD during timer recording standby mode, press POWER and DVD to switch to DVD mode.

General Features

Note

Unless stated otherwise, all operations described use the remote control. Some features may also be available on the Setup menu.

Moving to another TITLE



When a disc has more than one title, you can move to another title as follows:

- Press DISPLAY, then press the appropriate numbered button (0-9) to select a title number.

Moving to another CHAPTER/TRACK



When a title on a disc has more than one chapter or a disc has more than one track, you can move to another chapter/track as follows:

- Press ◀◀ or ▶▶ briefly during playback to select the next chapter/track or to return to the beginning of the current chapter/track.
- Press ◀◀ twice briefly to step back to the previous chapter/track.
- To go directly to any chapter during DVD playback, press DISPLAY. Then, press ▲/▼ to select the chapter/track icon. Then, enter the chapter/track number using the numbered buttons (0-9).

Note

For two-digit numbers, press the numbered buttons (0-9) in rapid succession.

Slow Motion

- 1 Press ◀◀ or ▶▶ during pause. The player will enter SLOW mode.
- 2 Use the ◀◀ or ▶▶ to select the required speed: ◀◀ 1/16, ◀◀ 1/8, ◀◀ 1/4 or ◀◀ 1/2 (backward), or ▶▶ 1/16, ▶▶ 1/8, ▶▶ 1/4 or ▶▶ 1/2 (forward).
- 3 To exit slow motion mode, press PLAY.

Note

Slow motion playback in reverse is not applicable for Video CD.

Operation with DVD and Video CD

General Features (continued)

Still Picture and Frame-by-frame playback

DVD VCD2.0 VCD1.1

- 1 Press PAUSE/STEP during playback.
The player will now go into PAUSE mode.
- 2 You can advance the picture frame-by-frame by pressing PAUSE/STEP repeatedly on the remote control.

Search

DVD VCD2.0 VCD1.1

- 1 Press and hold **◀◀** or **▶▶** for about two seconds during playback.
The player will now go into SEARCH mode.
- 2 Press and hold **◀◀** or **▶▶** repeatedly to select the required speed: **◀◀X2**, **◀◀X4**, **◀◀X16**, **◀◀X100** (backward) or **▶▶X2**, **▶▶X4**, **▶▶X16**, **▶▶X100** (forward).
With a Video CD, the Search speed changes: **◀◀X2**, **◀◀X4**, **◀◀X8** (backward) or **▶▶X2**, **▶▶X4**, **▶▶X8** (forward).
- 3 To exit SEARCH mode, press PLAY.

Random

Karaoke DVD VCD2.0 VCD1.1

- 1 Press RANDOM during playback or in stop mode.
The unit automatically begins Random Playback and "RANDOM" appears on the TV screen.
- 2 To return to normal playback, press RANDOM until "NORMAL" appears on the TV screen.

Tips

By pressing **▶▶** during Random playback, the unit selects another title (track) and resumes Random playback.

Note

- This function only works with DVD Karaoke discs and video CD without PBC.
- On a Video CD with PBC, you must set PBC to Off on the setup menu to use the Random function. See page 19.

Repeat

DVD VCD2.0 VCD1.1

CHAPT TITLE TRACK ALL OFF

DVD Video Discs - Repeat Chapter/Title/Off

- 1 To repeat the currently playing chapter, press REPEAT.
The Repeat Chapter icon appears on the TV screen.
- 2 To repeat the title currently playing, press REPEAT a second time.
The Repeat Title icon appears on the TV screen.
- 3 To exit Repeat mode, press REPEAT a third time.
The Repeat Off icon appears on the TV screen.

Video CDs - Repeat Track/All/Off

- 1 To repeat the track currently playing, press REPEAT.
The Repeat Track icon appears on the TV screen.
- 2 To repeat the disc currently playing, press REPEAT a second time.
The Repeat All icon appears on the TV screen.
- 3 To exit Repeat mode, press REPEAT a third time.
The Repeat Off icon appears on the TV screen.

Note

On a Video CD with PBC, you must set PBC to Off on the setup menu to use the Repeat function. See page 19.

Repeat A-B

DVD VCD2.0 VCD1.1

A+ A B OFF

To repeat a sequence in a title:

- 1 Press A-B at your chosen starting point.
A+ appears briefly on the TV screen.
- 2 Press A-B again at your chosen end point.
A B appears briefly on the TV screen, and the repeat sequence begins.
- 3 To cancel the sequence, press A-B.

Time Search

DVD 0:20:09

The Time Search function allows you to start playing at any chosen time on the disc.

- 1 Press DISPLAY during playback. The on-screen display appears on the screen.
The Time Search box shows the elapsed playing time of the current disc.
- 2 Within 10 seconds, press **▲/▼** to select the Time Search icon in the on-screen display.
The ":-:--" appears in the Time Search box.
- 3 Within 10 seconds, use the number buttons to enter the required start time. Enter hours, minutes, and seconds from left to right in the box.
If you enter the wrong numbers, press CLEAR to remove the numbers you entered. Then enter the correct numbers.
- 4 Within 10 seconds, press SELECT/ENTER to confirm the start time.
Playback starts from the selected time on the disc. If you enter an invalid time, playback will continue from the current point.

3D Surround

DVD VCD2.0 VCD1.1

BYPASS 3D SUR

This unit can produce a 3D Surround effect, which simulates multi-channel audio playback from two conventional stereo speakers, instead of the five or more speakers normally required to listen to multi-channel audio from a home theater system.

- 1 Press SOUND MODE to select "3D SUR" during playback.
- 2 To turn off the 3D Surround effect, press SOUND MODE again to select "BYPASS".

Note

On a DVD disc, you can select "3D SUR" only during playing 2 channel audio.

Operation with DVD and Video CD

General Features (continued)

Zoom

The Zoom function allows you to enlarge the video image and to move through the enlarged image.

- 1 Press ZOOM during playback or still playback to activate the Zoom function.
If you press ZOOM repeatedly, the magnification level increases up to six times.
- 2 Use the ◀▶▶▲▼ buttons to move through the zoomed picture.
- 3 Press CLEAR to resume normal playback or return to the paused image.

Note

- The zoom function may not work for some DVDs.
- The zoom function may not work on multi-angle scenes.

Marker Search



You can start playback from a memorized point. Up to nine points can be memorized.
To enter a mark, follow these steps.

- 1 During disc playback, press MARKER when playback reaches the spot that you want to memorize.
The Marker icon will appear on the TV screen briefly.
- 2 Repeat step 1 to enter up to nine Marker points on a disc.

To Recall a Marked Scene

- 1 During disc playback, press SEARCH.
The MARKER SEARCH menu will appear on the screen.
- 2 Within 10 seconds, press ◀▶ to select a Marker number that you want to recall.
- 3 Press SELECT/ENTER.
Playback will start from the Marked scene.
- 4 To remove the MARKER SEARCH menu, press SEARCH.

To clear a Marked Scene

- 1 During disc playback, press SEARCH.
The MARKER SEARCH menu will appear on the screen.
- 2 Press ◀▶ to select the Marker number that you want to erase.
- 3 Press CLEAR.
The Marker number will be erased from the list.
- 4 Repeat steps 2 and 3 to erase additional Marker numbers.
- 5 To remove the MARKER SEARCH menu, press SEARCH.

Special DVD Features

Checking the contents of DVD Video discs: Menus

DVDs may contain menus that allow you to access special features. To use the disc menu, press DISC MENU. Then, press the appropriate number button to select an option. Or, use the ◀▶/▲/▼ buttons to highlight your selection, then press SELECT/ENTER.

Title Menu

- 1 Press TITLE.
If the current title has a menu, the menu will appear on the screen. Otherwise, the disc menu may appear.
- 2 The menu can list camera angles, spoken language and subtitle options, and chapters for the title.
- 3 To remove the title menu, press TITLE again.

Disc Menu

- 1 Press DISC MENU.
The disc menu is displayed.
- 2 To remove the disc menu, press DISC MENU again.

Camera Angle

If the disc contains scenes recorded at different camera angles, you can change to a different camera angle during playback.

- Press ANGLE repeatedly during playback to select a desired angle.
The number of the current angle appears on the display.

Changing the Audio Language



Press AUDIO repeatedly during playback to hear a different audio language or audio track.

Changing the Audio Channel

Press AUDIO repeatedly during playback to hear a different audio channel (STER., LEFT or RIGHT).

Subtitles

Press SUBTITLE repeatedly during playback to see the different subtitle languages.

Note

If  appears, the feature is not available on the disc.

Operation with Audio CD and MP3/WMA Disc

Playing an Audio CD and MP3/WMA Disc

CD **MP3** **WMA**

The DVD Player can play MP3/WMA formatted recordings on CD-ROM, CD-R or CD-RW discs. Before playing MP3/WMA recordings, read the notes on MP3/WMA Recordings on the right.

- 1 Insert a disc and close the tray.**
Audio CD; Audio CD menu appears on the TV screen go to step 4.
MP3/WMA disc; The MP3/WMA-JPEG choice menu appears on the TV screen. Go to step 2



- 2 Press ▲▼ to select the MP3/WMA then press SELECT/ENTER.**
The MP3/WMA menu appears on the TV screen. Press RETURN to move to the MP3/WMA-JPEG choice menu.

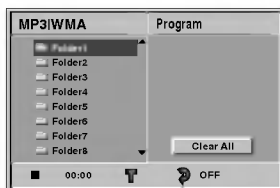

- 3 Press ▲▼ to select a folder, and SELECT/ENTER.**
A list of files in the folder appears.

- 4 Press ▲▼ to select a track then press PLAY or SELECT/ENTER.**
Playback starts.
During playback, the current track's elapsed playing time will appear on the display window and menu. Playback will stop at the end of the disc.
Press TITLE to move to the next page.
Press DISC MENU to move to the previous page.

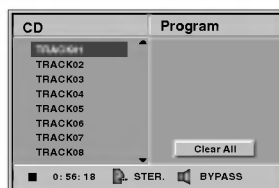

Audio CD menu

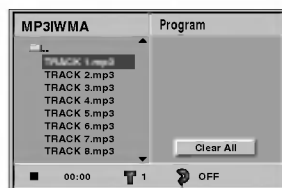

MP3/WMA menu



Tip
If you are in a file list and want to return to the Folder list, use the ▲▼ to highlight and press SELECT/ENTER to return to the previous menu screen.

- 5 To stop playback at any other time, press STOP.**

Notes on MP3/WMA Recordings

About MP3

- An MP3 file is audio data compressed by using the MPEG1 audio layer-3 file-coding scheme. We call files that have the “.mp3” file extension “MP3 files”.
- The player can not read an MP3 file that has a file extension other than “.mp3”.

About WMA(Window Media Audio)

- An WMA file is a Microsoft audio compression technology.
- WMA(Windows Media Audio) offers double the audio compression of the MP3 format.

MP3/WMA Disc compatibility with this player is limited as follows:

1. Sampling Frequency / only at 44.1 kHz (MP3), 22.05-44.1 kHz (WMA)
2. Bit rate / within 32-320 kbps (MP3), 32-128 kbps (WMA)
3. CD-R physical format should be “ISO 9660”
4. If you record MP3/WMA files using the software which cannot create a FILE SYSTEM, for example “Direct-CD” etc., it is impossible to playback MP3/WMA files. We recommend that you use “Easy-CD Creator”, which creates an ISO9660 file system.
5. A single session disc requires MP3/WMA files in the first track. If there is no MP3/WMA file in the 1st track, it cannot playback MP3/WMA files. If you wish to playback MP3/WMA files, format all the data in the disc or use a new one.
6. File names should be named using 8 letters or less and must incorporate “.mp3” or “.wma” extension e.g. “*****.MP3” or “*****.WMA”.
7. Do not use special letters such as “/ : * ? “ < > ” etc.
8. Total number of files on the disc should be less than 650.

This DVD player requires discs/recordings to meet certain technical standards in order to achieve optimal playback quality. Pre-recorded DVDs are automatically set to these standards. There are many different types of recordable disc formats (including CD-R containing MP3 or WMA files). That require certain pre-existing conditions (see above) to insure compatible playback.

Customers should also note that permission is required in order to download MP3/WMA files and music from the Internet. Our company has no right to grant such permission. Permission should always be sought from the copyright owner.

Operation with Audio and MP3/WMA Disc (Continued)

Pause **CD** **MP3** **WMA**

- 1 Press PAUSE/STEP during playback.
- 2 To return to playback, press PLAY or press PAUSE/STEP again.

Moving to another Track **CD** **MP3** **WMA**

- Press **I◀◀** or **▶▶I** briefly during playback to go to the next track or to return to the beginning of the current track.
- Press **I◀◀** twice briefly to step back to the previous track.
- In case of audio CD, to go directly to any track, enter the track number using the numbered buttons (0-9) during playback.

Repeat Track/All/Off **CD** **MP3** **WMA**

- 1 To repeat the track currently playing, press REPEAT. The Repeat icon and "TRACK" appears on the menu screen.
- 2 To repeat all tracks on a disc, press REPEAT a second time. The Repeat icon and "ALL" appears on the menu screen.
- 3 To cancel Repeat mode, press REPEAT a third time. The Repeat icon and "OFF" appears on the menu screen.

Search **CD** **MP3** **WMA**

- 1 Press and hold **I◀◀** or **▶▶I** for about two seconds during playback. The player will now go into SEARCH mode.
- 2 Press and hold **I◀◀** or **▶▶I** repeatedly to select the required speed: **◀◀X2**, **◀◀X4**, **◀◀X8** (backward) or **▶▶X2**, **▶▶X4**, **▶▶X8** (forward). Search speed and direction are indicated on the menu screen.
- 3 To exit SEARCH mode, press PLAY **▶**.

Random **CD** **MP3** **WMA**

- 1 Press RANDOM during playback or when playback is stopped. The unit automatically begins Random Playback and "RAND." appears on the menu screen.
- 2 To return to normal playback, press RANDOM repeatedly until "RAND." disappears on the menu screen.

Repeat A-B **CD**

To repeat a sequence.

- 1 During disc playback, press A-B at your chosen starting point. The Repeat icon and "A*" appears on the menu screen.
- 2 Press A-B again at your chosen end point. The Repeat icon and "A B" appears on the menu screen, and the sequence begins to play repeatedly.
- 3 To exit the sequence and return to normal play, press A-B again. The Repeat icon and "OFF" appears on the menu screen.

3D Surround **CD**

This unit can produce a 3D Surround effect, which simulates multi-channel audio playback from two conventional stereo speakers, instead of the five or more speakers normally required to listen to multi-channel audio from a home theater system.

- 1 Press SOUND MODE to select "3DSURR" during playback.
- 2 To turn off the 3D Surround effect, press SOUND MODE again to select "BYPASS".

Changing the Audio Channel **CD**

Press AUDIO repeatedly during playback to hear a different audio channel (STER., LEFT, or RIGHT).

Operation with JPEG Disc

Viewing a JPEG disc **JPEG**

This DVD Player can play discs with JPEG files and Kodak picture CD. Before playing JPEG recordings, read the notes on JPEG Recordings on the right.

- 1 Insert a disc and close the tray.**
The MP3/WMA-JPEG choice menu appears on the TV screen.



- 2 Press ▲▼ to select the JPEG then press SELECT/ENTER.**
The JPEG menu appears on the TV screen.



- 3 Press ▲▼ to select a folder, and SELECT/ENTER.**
A list of files in the folder appears.
Press RETURN to move to the MP3/WMA-JPEG choice menu.

T Tip

If you are in a file list and want to return to the Folder list, use the ▲▼ buttons on the remote to highlight “-.-” and press SELECT/ENTER to return to the previous menu screen.

- 4 If you want to view a particular file, press ▲▼ to highlight a file and press SELECT/ENTER or PLAY.**

Viewing the file proceeding starts.
During viewing a file, press RETURN to move to the previous menu (JPEG menu).
Press TITLE to move to the next page.
Press DISC MENU to move to the previous page.

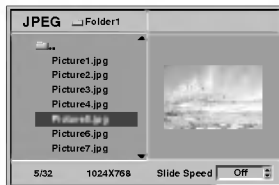

T Tip

There are three viewing Slide Speed options: Fast, Normal, Slow, and Off. Press ◀▶ to highlight the Slide Speed then press ▲▼ to select the option you want to use, and press SELECT/ENTER.

- 5 To stop viewing at any other time, press STOP.**
The JPEG menu appears.

Moving to another File

Press ◀◀ or ▶▶ once during viewing a picture to advance to the next file or to the previous file.

Still Picture

- 1 Press PAUSE/STEP during slide show.
The player will now go into PAUSE mode.
- 2 To return to the slide show, press PLAY or press PAUSE/STEP again.

To flip the picture

Press ▲▼ during showing a picture to flip the picture horizontally or a vertically.

To rotate picture

Press ◀▶ during showing a picture to rotate the picture clockwise or counter clockwise.

Notes on JPEG Recordings

- Depending upon the size and number of the JPEG files, it could take a long time for the DVD player to read the disc's contents. If you don't see an on-screen display after several minutes, some of the files are too big — reduce the resolution of the JPEG files to less than 2 mega pixels and burn another disc.
- Total number of files and folders on the disc should be less than 650.
- Some disc may be incompatible due to different recording format or condition of disc.
- When you are using software such as “Easy CD Creator” to burn the jpeg files into the CD-R, ensure that all the selected files have the “.jpg” extensions when copying into the CD layout.
- If the files have “.jpe” or “.jpeg” extensions, please rename them as “.jpg” files.
- File names without “.jpg” extension will not be able to be read by this DVD player. Even though the files are shown as JPEG image files in windows explorer.

Programmed Playback with Audio CD and MP3/WMA Disc

The Program function enables you to store your favorite tracks from any disc in the player memory.

Program can contain 30 tracks.

1 Press PROGRAM during playback or in the stop mode to enter the Program Edit mode.

The  mark will appear to the right of the word Program on the right side of the menu screen.

Note

Press PROGRAM to exit the Program Edit mode; the  mark will disappear.

2 Select a track, then press SELECT/ENTER to place the selected track on the Program list.

3 Repeat step 2 to place additional tracks on the Program list.

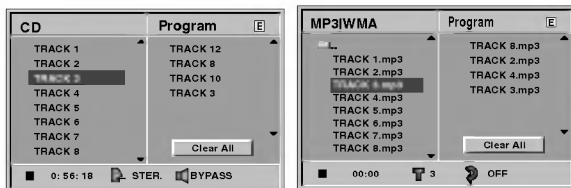

Audio CD menu

MP3/WMA menu

4 Press ►.

The programmed track you selected last is highlighted on the program list.

5 Press ▲/▼ to select the track you want to start playing.

Press TITLE to move to the next page.
Press DISC MENU to move to the previous page.

6 Press PLAY to start.

Playback begins in the order in which you programmed the tracks and "PROG." appears on the menu screen. Playback stops after all of the tracks on the Program list have played once.

7 To resume normal playback from programmed playback, press PROGRAM to disappear the mark and select a track of CD (or MP3/WMA) list and then press SELECT/ENTER.

"PROG." indicator disappears on the menu screen.

Programmed Playback with Video CD

Note

On a Video CD with PBC, you must set PBC to Off on the setup menu to use the Program function. See page 19.

1 Insert Video CD and close the tray.

2 Press PROGRAM while playback is stopped.

The VCD Program menu will appear.

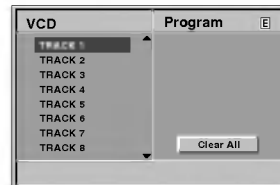

Note

Press RETURN or PROGRAM to exit the Program menu.

3 Follow steps 2-6 of "Programmed Playback with Audio CD and MP3/WMA disc" on left.

4 To resume normal playback from programmed playback, press PROGRAM.

"NORMAL" appears on the TV screen.

Repeat Programmed Tracks

- To repeat the track currently playing, press REPEAT. The Repeat icon and "TRACK" appears on the menu screen.
- To repeat all tracks on the program list, press REPEAT a second time. The Repeat icon and "ALL" appears on the menu screen.
- To cancel Repeat mode, press REPEAT a third time. The Repeat icon and "OFF" appears on the menu screen.

Erasing a Track from Program List

1 Press PROGRAM during playback (Audio CD and MP3/WMA disc only) or in the stop mode to enter the Program Edit mode.

The  mark will appear.

2 Press ► to move to the Program list.

3 Use ▲/▼ to select the track that you wish to erase from the Program list.

4 Press CLEAR.

The track will be erased from the Program list.

Erasing the Complete Program List

1 Follow steps 1-2 of "Erasing a Track from Program List" as above.

2 Use ▲/▼ to select "Clear All", then press SELECT/ENTER.

The complete Program for the disc will be erased.

The programs are also cleared when the disc is removed.

Additional Operation - VCR part

Hi-Fi Stereo Sound System

Your VCR will record and playback Hi-Fi stereo sound. This allows you to record and playback the sound in several different ways. Video cassettes recorded on your VCR will have a normal mono audio track and two VHS Hi-Fi stereo audio tracks. These stereo tracks allow you to make audio recordings in Hi-Fi stereo or bilingual mode from a TV broadcast, stereo audio system, video disc or another Hi-Fi VCR.

1 Your unit allows you to enjoy broadcasts with standard stereo, bilingual and mono sound. The particular type of sound received or that recorded will be briefly displayed on the TV screen for a couple of seconds:

STEREO

Sound is automatically recorded on the Hi-Fi stereo and mono tracks of the video tape.

BIL

Both audio channels will be recorded on the Hi-Fi stereo tracks. The primary language channel (left) will be recorded on the mono track of the video tape.

MONO

The sound is recorded on the Hi-Fi tracks and the mono track of the video tape without any separation.

2 Press **AUDIO** repeatedly until the desired audio mode appears.

3 The choice is **STEREO**, **LEFT**, **RIGHT** and **MONO**. In **BIL** playback the primary language is output on the left channel and the secondary channel is output simultaneously from the right channel when audio output is set to **STEREO**. The primary language will be output from both channels when the audio setting is **MONO**.

Please note that when adjusting the tracking control Hi-Fi stereo sound may revert to **MONO**.

Wide Screen Compatibility 16:9

Your VCR can record and play back wide screen aspect ratio programmes (16:9). To record a wide screen format programme successfully the correct type of wide screen signal must be broadcast by the TV station.

1 Switch on your VCR.
Press **i**.
Press **◀** or **▶** to select **16:9/4:3**.
Press **OK**.

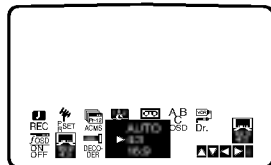
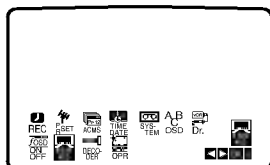

2 Press **▲** or **▼** repeatedly to select: **AUTO**, **4:3** or **16:9**.

AUTO:

Automatically plays back Wide-Screen programmes as Wide-Screen and Normal programmes as normal.

4:3

Only for playing back and recording Normal format recordings (4:3).

16:9:

Only for playing back and recording Wide-Screen format recordings (16:9).

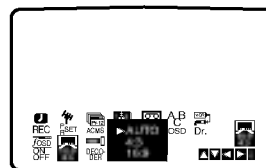

3 Press **i** to remove the menus from the TV screen. To enjoy Wide-Screen playback you must connect your VCR to the TV using a SCART cable.

To set the decoder

We have already described, how to connect a decoder for pay-TV station as CANAL+ or PREMIERE on page 9. For the recording of an encoded station you do not have to control anything. You just select the station and wait shortly until the decoding will start.

1 Press **i**.
The main menu will appear on the TV screen.
Press **◀** or **▶** to select the **DECODER**.
Press **OK**.

2 Press **▲** or **▼** to select.
ON: When the decoder is connected to the AV2 socket.
OFF: When another VCR is connected to the AV2 socket.
Press **i** to return to a TV picture.

Additional Operation - DVD part

Last Condition Memory

DVD CD VCD1.1

This player memorizes the user settings for the last disc that you have viewed. Settings remain in memory even if you remove the disc from the player or switch off the player. If you load a disc that has its settings memorized, the latest stop position is automatically recalled.

Notes

- Settings are stored in memory for use any time.
- This player does not memorize settings of a disc if you switch off the player before commencing to play it.

Screen Saver

The screen saver picture appears when you leave the DVD Player in stop mode for about five minutes.

Special Recording

Copying from DVD To VCR

This unit allows you to copy the contents of a DVD to a VHS tape with a press of the COPY/MEMORY button.

Note

- If the DVD you are attempting to copy is copy protected, you may not be able to copy the disc.

1 Insert Disc

Insert the disc you wish to copy in the DVD deck and close the disc tray.

2 Insert VHS Tape

Insert a blank VHS videotape into the VCR deck.

3 Press DVD.

4 Copy the DVD to VHS Tape

Press COPY/MEMORY on the front panel or press REC/ITR.

- The DVD will go into Play mode and the VCR will go into Record mode.
- If the DVD disc menu appears, you may need to press the Play button manually to begin copying.

5 Stop the Copy Process

When the DVD is finished playing, press the STOP button **twice** within 5 seconds to end the copy.

- You must stop the Copy process manually when the DVD movie ends, or the unit may replay and record over and over again.

Recording from another video recorder

With this video recorder you can make recordings from an external source, such as copying from another video recorder or a camcorder.

Note

In the following description, this video recorder will be one used for recording and will be referred to as VCR B. The other appliance will be used for playback and will be referred to as VCR A.

1 VCR A should be connected to the SCART socket on the rear panel of your unit or the AV sockets on the front panel of your unit.

2 Insert the recorded tape into VCR A and a blank tape into VCR B.

3 Press AV until the socket you wish to record from is displayed. (VCR B)

AV 1 Sound and Picture recording using the lower SCART socket on the back of your VCR.

AV 2 Sound and Picture recording using the upper SCART socket on the back of your VCR.

AV 3 for recording from VIDEO IN and AUDIO IN (Left & Right) sockets on the front of your unit.

4 To start recording, press the REC/ITR on VCR B and PLAY on VCR A.

5 When you want to finish copying, press the STOP on both video recorders.
Press STOP **twice** within 5 seconds at this unit.

Radio Operation

Presetting the Radio Stations

You can preset 30 stations for FM and AM. Before tuning, make sure that you have turned down the volume.

- 1 Press FM/AM on the remote control or on the front panel until the frequency band appears on the display and TV screen.



- 2 Press ▲▼ on the remote control to select your desired radio channel.

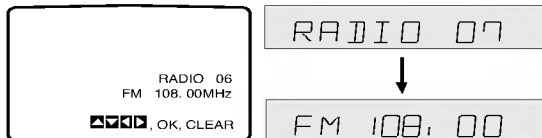

- 3 Press FM/AM on the remote control or on the front panel to select the desired band.
- 4 Hold down TUNING ▲ or ▼ on the front panel or hold down ◀ or ▶ on the remote control for 1 or 2 seconds, and a station is searched for automatically.

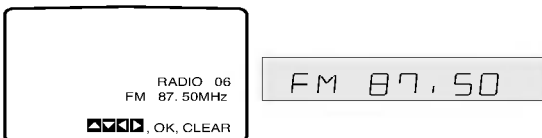

- 5 Press OK on the remote control or press COPY/MEMORY on the front panel.



- 6 Repeat steps 2 to 5 to store other stations.

Listening to the Radio

Preset radio stations in this unit's memory first (see "Presetting the radio stations" on the left).

- 1 Press FM/AM on the remote control or on the front panel until the frequency band appears on the display and TV screen.

The last received station is tuned in.

- 2 Press ▲▼ on the remote control repeatedly to select the preset station you want.

Each time you press the button, this unit's tunes in one preset station at a time.

- 3 Adjust the volume by rotating VOLUME on the front panel or by pressing VOLUME + or - on the remote control repeatedly.

To Clear the Stored Radio Stations

- 1 Press FM/AM on the remote control or on the front panel until the frequency band appears on the display and TV screen.



- 2 Press ▲▼ on the remote control to select your desired station.

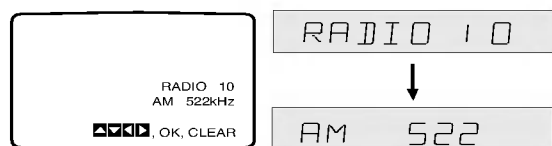

- 3 Press CLEAR the remote control to clear the stored radio station.

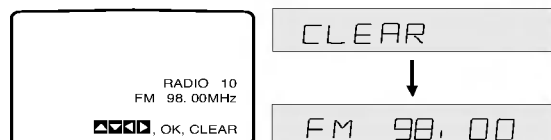

Radio Operation (Continued)

Tuning into a Station Manually

- 1** Press FM/AM on the remote control or on the front panel until the frequency band appears on the display and TV screen.
- 2** Press FM/AM on the remote control or on the front panel to select the desired band.
- 3** Press TUNING ▲ or ▼ on the front panel or press ◀ or ▶ on the remote control to tune in the desired station.

Tuning into a Station Automatically

Hold down TUNING ▲ or ▼ on the front panel or hold down ◀ or ▶ on the remote control for 1 or 2 seconds, and a station is searched for automatically.

Note

- The search may not stop at a station with a very weak signal.

Mute

Press MUTE to mute your unit.

You can mute your unit in order, for example, to answer the telephone, MUTING appear in the display.

Speaker Settings

Make the following settings for the built-in 5.1 channel surround decoder.



- 1** Select “5.1 Speaker Setup” using the ▲/▼ buttons on the setup menu.
- 2** While “5.1 Speaker Setup” is selected, press ► button.
- 3** Press ► button to select the desired speaker.
- 4** Adjust options by using ▲/▼/◀/▶ buttons.

Speaker selection

Select a speaker that you want to adjust. (Front speakers (Left), Front speakers (Right), Center Speaker, Rear speakers (Left), Rear speakers (Right), or Subwoofer)

Volume

Press ◀/▶ to adjust the output level of the selected speaker. (-6dB ~ +6dB)

Size

Since the speaker settings are fixed, you cannot change the settings.

Distance

If you connected speakers to your unit, setting the Distance lets the speakers know how far the sound has to travel to reach your set listening point. This allows the sound from each speaker to reach the listener at the same time. (1 ft = 30.48 cm)

Note

You can not set the distance of subwoofer speaker.

Test

Press SELECT/ENTER to test the signals of each speaker. Adjust the volume to match the volume of test signals memorized in the system.

- Front Left (L) → Center → Front Right (R)
→ Rear Right (R) → Rear Left (L) → Subwoofer

Return

Press SELECT/ENTER to return to the previous menu.

Troubleshooting

Check the following guide for the possible cause of a problem before contacting service.

Symptom	Cause	Correction
DVD or VCR do not work properly.	<ul style="list-style-type: none"> DVD or VCR button is not switched properly. 	<ul style="list-style-type: none"> Refer to page 2.
No power.	<ul style="list-style-type: none"> The power cord is disconnected. 	<ul style="list-style-type: none"> Plug the power cord into the wall outlet securely.
The power is on, but the DVD player does not work.	<ul style="list-style-type: none"> No disc is inserted. 	<ul style="list-style-type: none"> Insert a disc.
No picture.	<ul style="list-style-type: none"> The TV is not set to receive DVD signal output. 	<ul style="list-style-type: none"> Select the appropriate video input mode on the TV so the picture from the DVD player appears on the TV screen.
	<ul style="list-style-type: none"> The video cable is not connected securely. 	<ul style="list-style-type: none"> Connect the video cable into the jacks securely.
No sound.	<ul style="list-style-type: none"> The equipment connected with the audio cable is not set to receive DVD signal output. 	<ul style="list-style-type: none"> Select the correct input mode of the audio receiver so you can listen to the sound from the DVD player.
	<ul style="list-style-type: none"> The audio cables are not connected securely. 	<ul style="list-style-type: none"> Connect the audio cable into the jacks securely.
	<ul style="list-style-type: none"> The power of the equipment connected with the audio cable is turned off. 	<ul style="list-style-type: none"> Turn on the equipment connected with the audio cable.
The picture is poor.	<ul style="list-style-type: none"> The disc is dirty. 	<ul style="list-style-type: none"> Clean the disc.
	<ul style="list-style-type: none"> The TV channels are not tuned in properly. 	<ul style="list-style-type: none"> Check tuning, carry out tuning again.
The DVD player does not start playback.	<ul style="list-style-type: none"> An unplayable disc is inserted. 	<ul style="list-style-type: none"> Insert a playable disc. (Check the disc type and Regional code.)
	<ul style="list-style-type: none"> The disc is placed upside down. 	<ul style="list-style-type: none"> Place the disc with the playback side down.
	<ul style="list-style-type: none"> The disc is not placed within the guide. 	<ul style="list-style-type: none"> Place the disc on the disc tray correctly inside the guide.
	<ul style="list-style-type: none"> The disc is dirty. 	<ul style="list-style-type: none"> Clean the disc.
	<ul style="list-style-type: none"> The Rating level is set. 	<ul style="list-style-type: none"> Cancel the Rating function or change the rating level.
The remote control does not work properly.	<ul style="list-style-type: none"> There is an obstacle in the path of the remote control and this unit. 	<ul style="list-style-type: none"> Remove the obstacle.
	<ul style="list-style-type: none"> The batteries in the remote control are exhausted. 	<ul style="list-style-type: none"> Replace the batteries with new ones.
No Hi-Fi sound	<ul style="list-style-type: none"> Audio mode is not set properly. 	<ul style="list-style-type: none"> Select "STEREO" by repeatedly pressing "AUDIO" on the remote control.
Radio stations cannot be tuned in.	<ul style="list-style-type: none"> The antenna is positioned or connected poorly. 	<ul style="list-style-type: none"> Connect the antenna securely.
		<ul style="list-style-type: none"> Adjust the antennas and connect an external antenna if necessary.
	<ul style="list-style-type: none"> The signal strength of the stations is too weak (when tuning in with automatic tuning). 	<ul style="list-style-type: none"> Tune in the station manually.
	<ul style="list-style-type: none"> No stations have been preset or preset stations have been cleared (when tuning by scanning preset stations). 	<ul style="list-style-type: none"> Preset the stations (page 35).

Video Head Cleaning

Dirt accumulating on the head after a long period of time can cause the playback picture to become blurred or broken up. High quality video cassette tapes will not normally deposit dirt onto the video head, but old or damaged tapes might. Clean the video heads with a commercially available video heads cleaning tape.

Language Code List

Enter the appropriate code number for the initial settings “Disc Audio”, “Disc Subtitle” and/or “Disc Menu” (See page 18).

Code	Language	Code	Language	Code	Language	Code	Language
6566	Abkhazian	7074	Fiji	7678	Lingala	8373	Singhalese
6565	Afar	7073	Finnish	7684	Lithuanian	8375	Slovak
6570	Afrikaans	7082	French	7775	Macedonian	8376	Slovenian
8381	Albanian	7089	Frisian	7771	Malagasy	8379	Somali
6577	Ameharic	7176	Galician	7783	Malay	6983	Spanish
6582	Arabic	7565	Georgian	7776	Malayalam	8385	Sudanese
7289	Armenian	6869	German	7784	Maltese	8387	Swahili
6583	Assamese	6976	Greek	7773	Maori	8386	Swedish
6588	Aymara	7576	Greenlandic	7782	Marathi	8476	Tagalog
6590	Azerbaijani	7178	Guarani	7779	Moldavian	8471	Tajik
6665	Bashkir	7185	Gujarati	7778	Mongolian	8465	Tamil
6985	Basque	7265	Hausa	7865	Nauru	8484	Tatar
6678	Bengali, Bangla	7387	Hebrew	7869	Nepali	8469	Telugu
6890	Bhutani	7273	Hindi	7879	Norwegian	8472	Thai
6672	Bihari	7285	Hungarian	7982	Oriya	6679	Tibetan
6682	Breton	7383	Icelandic	8065	Panjabi	8473	Tigrinya
6671	Bulgarian	7378	Indonesian	8083	Pashto, Pushto	8479	Tonga
7789	Burmese	7365	Interlingua	7065	Persian	8482	Turkish
6669	Byelorussian	7165	Irish	8076	Polish	8475	Turkmen
7577	Cambodian	7384	Italian	8084	Portuguese	8487	Twi
6765	Catalan	7465	Japanese	8185	Quechua	8575	Ukrainian
9072	Chinese	7487	Javanese	8277	Rhaeto-Romance	8582	Urdu
6779	Corsican	7578	Kannada	8279	Rumanian	8590	Uzbek
7282	Croatian	7583	Kashmiri	8285	Russian	8673	Vietnamese
6783	Czech	7575	Kazakh	8377	Samoan	8679	Volapük
6865	Danish	7589	Kirghiz	8365	Sanskrit	6789	Welsh
7876	Dutch	7579	Korean	7168	Scots Gaelic	8779	Wolof
6978	English	7585	Kurdish	8382	Serbian	8872	Xhosa
6979	Esperanto	7679	Laothian	8372	Serbo-Croatian	7473	Yiddish
6984	Estonian	7665	Latin	8378	Shona	8979	Yoruba
7079	Faroese	7686	Latvian, Lettish	8368	Sindhi	9085	Zulu

Country Code List

Enter the appropriate code number for the initial setting "Country Code" (See page 20).

Code	Country	Code	Country	Code	Country	Code	Country
AD	Andorra	ER	Eritrea	LC	Saint Lucia	SC	Seychelles
AE	United Arab Emirates	ES	Spain	LI	Liechtenstein	SD	Sudan
AF	Afghanistan	ET	Ethiopia	LK	Sri Lanka	SE	Sweden
AG	Antigua and Barbuda	FI	Finland	LR	Liberia	SG	Singapore
AI	Anguilla	FJ	Fiji	LS	Lesotho	SH	Saint Helena
AL	Albania	FK	Falkland Islands	LT	Lithuania	SI	Slovenia
AM	Armenia	FM	Micronesia	LU	Luxembourg	SJ	Svalbard and Jan Mayen Islands
AN	Netherlands Antilles	FO	Faroe Islands	LV	Latvia	SK	Slovak Republic
AO	Angola	FR	France	LY	Libya	SL	Sierra Leone
AQ	Antarctica	FX	France (European Territory)	MA	Morocco	SM	San Marino
AR	Argentina	GA	Gabon	MC	Monaco	SN	Senegal
AS	American Samoa	GB	Great Britain	MD	Moldavia	SO	Somalia
AT	Austria	GD	Grenada	MG	Madagascar	SR	Suriname
AU	Australia	GE	Georgia	MH	Marshall Islands	ST	Saint Tome and Principe
AW	Aruba	GF	French Guyana	MK	Macedonia	SU	Former USSR
AZ	Azerbaijan	GH	Ghana	ML	Mali	SV	El Salvador
BA	Bosnia-Herzegovina	GI	Gibraltar	MM	Myanmar	SY	Syria
BB	Barbados	GL	Greenland	MN	Mongolia	SZ	Swaziland
BD	Bangladesh	GL	Greenland	MO	Macau	TC	Turks and Caicos Islands
BE	Belgium	GM	Gambia	MP	Northern Mariana Islands	TD	Chad
BF	Burkina Faso	GN	Guinea	MQ	Martinique (French)	TF	French Southern Territories
BG	Bulgaria	GP	Guadeloupe (French)	MR	Mauritania	TG	Togo
BH	Bahrain	GQ	Equatorial Guinea	MS	Montserrat	TH	Thailand
BI	Burundi	GR	Greece	MT	Malta	TJ	Tadjikistan
BJ	Benin	GS	S. Georgia & S. Sandwich Isls.	MU	Mauritius	TK	Tokelau
BM	Bermuda	GT	Guatemala	MV	Maldives	TM	Turkmenistan
BN	Brunei Darussalam	GU	Guam (USA)	MW	Malawi	TN	Tunisia
BO	Bolivia	GW	Guinea Bissau	MX	Mexico	TO	Tonga
BR	Brazil	GY	Guyana	MY	Malaysia	TP	East Timor
BS	Bahamas	HK	Hong Kong	MZ	Mozambique	TR	Turkey
BT	Bhutan	HM	Heard and McDonald Islands	NA	Namibia	TT	Trinidad and Tobago
BV	Bouvet Island	HN	Honduras	NC	New Caledonia (French)	TV	Tuvalu
BW	Botswana	HR	Croatia	NE	Niger	TW	Taiwan
BY	Belarus	HT	Haiti	NF	Norfolk Island	TZ	Tanzania
BZ	Belize	HU	Hungary	NG	Nigeria	UA	Ukraine
CA	Canada	ID	Indonesia	NI	Nicaragua	UG	Uganda
CC	Cocos (Keeling) Islands	IE	Ireland	NL	Netherlands	UK	United Kingdom
CF	Central African Republic	IL	Israel	NO	Norway	UM	USA Minor Outlying Islands
CG	Congo	IN	India	NP	Nepal	US	United States
CH	Switzerland	IO	British Indian Ocean Territory	NR	Nauru	UY	Uruguay
CI	Ivory Coast	IQ	Iraq	NU	Niue	UZ	Uzbekistan
CK	Cook Islands	IR	Iran	NZ	New Zealand	VA	Vatican City State
CL	Chile	IS	Iceland	OM	Oman	VC	Saint Vincent & Grenadines
CM	Cameroon	IT	Italy	PA	Panama	VE	Venezuela
CN	China	JM	Jamaica	PE	Peru	VG	Virgin Islands (British)
CO	Colombia	JO	Jordan	PF	Polynesia (French)	VI	Virgin Islands (USA)
CR	Costa Rica	JP	Japan	PG	Papua New Guinea	VN	Vietnam
CS	Former Czechoslovakia	KE	Kenya	PH	Philippines	VU	Vanuatu
CU	Cuba	KG	Kyrgyzstan	PK	Pakistan	WF	Wallis and Futuna Islands
CV	Cape Verde	KH	Cambodia	PL	Poland	WS	Samoa
CX	Christmas Island	KI	Kiribati	PM	Saint Pierre and Miquelon	YE	Yemen
CY	Cyprus	KM	Comoros	PN	Pitcairn Island	YT	Mayotte
CZ	Czech Republic	KN	Saint Kitts & Nevis Anguilla	PR	Puerto Rico	YU	Yugoslavia
DE	Germany	KP	North Korea	PT	Portugal	ZA	South Africa
DJ	Djibouti	KR	South Korea	PW	Palau	ZM	Zambia
DK	Denmark	KW	Kuwait	PY	Paraguay	ZR	Zaire
DM	Dominica	KY	Cayman Islands	QA	Qatar	ZW	Zimbabwe
DO	Dominican Republic	KZ	Kazakhstan	RE	Reunion (French)		
DZ	Algeria	LA	Laos	RO	Romania		
EC	Ecuador	LB	Lebanon	RU	Russian Federation		
EE	Estonia			RW	Rwanda		
EG	Egypt			SA	Saudi Arabia		
EH	Western Sahara			SB	Solomon Islands		

Specification

General

Power requirements	AC 200-240V, 50/60 Hz
Power consumption	74W
Dimensions (approx.)	430 X 83.5 X 360 mm (w/h/d)
Mass (approx.)	6.3 kg
Operating temperature	5°C to 35°C (41°F to 95°F)
Operating humidity	5 % to 90 %
Timer	24 hours display tape
RF Modulator	UHF 22-68 (Adjustable)

System

Laser	Semiconductor laser, wavelength 650 nm
Video Head system	Double azimuth 4 heads, helical scanning.
Signal system	PAL
Frequency response	DVD (PCM 48 kHz): 8 Hz to 22 kHz CD: 8 Hz to 20 kHz
Signal-to-noise ratio	More than 100dB (ANALOG OUT connectors only)
Harmonic distortion	Less than 0.008%
Dynamic range	More than 100 dB (DVD) More than 95 dB (CD)

Inputs (VCR)

Audio	-6.0dBm, more than 10 kohms (SCART) -6.0dBm, more than 47 kohms (RCA)
Video	1.0 Vp-p, 75 ohms, unbalanced (SCART/RCA)

Outputs (DVD)

S-VIDEO OUT	(Y) 1.0 Vp-p, 75 ohms, negative sync., Mini Din 4-pin x 1 (C) 0.3 Vp-p, 75 ohms
-------------	--

Outputs (VCR/DVD)

Audio	-6.0 dBm, less than 1 k-ohms (SCART)
Video	1.0 Vp-p, 75 ohms, unbalanced (SCART)

Amplifier

Stereo mode	60 W + 60 W (8 ohms at 1 kHz, THD 10%)
Surround	Front : 60 W + 60 W (THD 10%) Center* : 60 W
(*Depending on the sound mode settings and the source, there may be no sound output.)	Surround* : 60 W + 60 W (8 ohms at 1 kHz, THD 10%) Subwoofer* : 100 W (4 ohms at 30 Hz, THD 10%)

Speakers

	Satellite Speaker (DTE-655T)	Center Speaker (DTE-655C)	Passive Speaker (DTE-604W)
Type	1 Way 1 Speaker	2 Way 2 Speaker	1 Way 1 Speaker
Impedance	8 ohms	8 ohms	4 ohms
Frequency Response	130 - 20000 Hz	110 - 20000 Hz	45 - 1000 Hz
Sound Pressure Level	83 dB/W (1m)	83 dB/W (1m)	83 dB/W (1m)
Rated Input Power	60 W	60 W	100 W
Max. Input Power	100 W	100 W	200 W
Net Dimensions (W x H x D)	110 x 140 x 115 mm	240 x 110 x 116 mm	200 x 380 x 279 mm
Net weight	0.91 kg	1 kg	6.85 kg

- Design and specifications are subject to change without notice.

Manufactured under license from Dolby Laboratories. "Dolby", "Pro Logic", and the double-D symbol are trademarks of Dolby Laboratories.

"DTS" and "DTS Digital Surround" are trademarks of Digital Theater Systems, Inc.



P/NO : 3834RP0105M