



DVD RECORDER/ VIDEO CASSETTE RECORDER

OWNER'S MANUAL

MODEL : RC68223



**PROGRESSIVE
SCAN**

Before connecting, operating or adjusting this product,
please read this instruction booklet carefully and completely.

Safety Precautions



CAUTION
RISK OF ELECTRIC SHOCK
DO NOT OPEN



CAUTION: TO REDUCE THE RISK OF ELECTRIC SHOCK DO NOT REMOVE COVER (OR BACK) NO USER-SERVICEABLE PARTS INSIDE REFER SERVICING TO QUALIFIED SERVICE PERSONNEL.



This lightning flash with arrowhead symbol within an equilateral triangle is intended to alert the user to the presence of uninsulated dangerous voltage within the product's enclosure that may be of sufficient magnitude to constitute a risk of electric shock to persons.



The exclamation point within an equilateral triangle is intended to alert the user to the presence of important operating and maintenance (servicing) instructions in the literature accompanying the product.

WARNING: TO REDUCE THE RISK OF FIRE OR ELECTRIC SHOCK, DO NOT EXPOSE THIS PRODUCT TO RAIN OR MOISTURE.

WARNING: Do not install this equipment in a confined space such as a book case or similar unit.

CLASS 1 LASER PRODUCT
KLASSE 1 LASER PRODUKT
LUOKAN 1 LASER LAITE
KLASS 1 LASER APPARAT
CLASSE 1 PRODUIT LASER

CAUTION:

This DVD Recorder employs a Laser System.

To ensure proper use of this product, please read this owner's manual carefully and retain for future reference should the unit require maintenance, contact an authorized service location (see service procedure).

Use of controls, adjustments, or the performance of procedures other than those specified herein may result in hazardous radiation exposure.

To prevent direct exposure to laser beam, do not try to open the enclosure. Visible laser radiation when open. DO NOT STARE INTO BEAM.

CAUTION: The apparatus should not be exposed to water (dripping or splashing) and no objects filled with liquids, such as vases, should be placed on the apparatus.



This product is manufactured to comply with the radio interference requirements of EEC DIRECTIVE 89/336/EEC, 93/68/EEC and 73/23/EEC.



NOTES ON COPYRIGHTS:

It is forbidden by law to copy, broadcast, show, broadcast via cable, play in public, or rent copyrighted material without permission.

This product features the copy protection function developed by Macrovision. Copy protection signals are recorded on some discs. When recording and playing the pictures of these discs on a VCR, picture noise will appear.

This product incorporates copyright protection technology that is protected by method claims of certain U.S. patents and other intellectual property rights owned by Macrovision Corporation and other rights owners. Use of this copyright protection technology must be authorized by Macrovision Corporation, and is intended for home and other limited viewing uses only unless otherwise authorized by Macrovision Corporation. Reverse engineering or disassembly is prohibited.

SERIAL NUMBER: The serial number is found on the back of this unit. This number is unique to this unit and not available to others. You should record requested information here and retain this guide as a permanent record of your purchase.

Model No. _____

Serial No. _____

Table of Contents

INTRODUCTION

Safety Precautions	2
Table of Contents	3-4
Overview	5-10
Recordable Discs	5
Playable Discs	5
Disc-related terms	6
• Types of video CDs	6
About Symbols	6
• About the \emptyset symbol display	6
• About the disc symbols for instructions	6
About DVD-R and DVD-RW disc	7
• What are 'recording modes'?	7
• Is editing a DVD like editing a video tape?	7
• About word 'Original' and 'Playlist'	7
About DVD+R and DVD+RW disc	7
About DVD recording	8
• Disc types and recording formats, modes, and settings	8
• Notes for recording	8
• Recording TV audio channels	9
• Restrictions on video recording	9
• What is 'CPRM'?	9
• Copyright	9
Remote Control Operation Range	9
Remote Control Battery Installation	9
Reset the Recorder	9
Precautions	10
• Handling the unit	10
• Cleaning the unit	10
Notes on Discs	10
• Handling discs	10
• Storing discs	10
• Cleaning discs	10
Front Panel	11
Function Display Window	12
Remote Control Overview	13
Rear Panel	14

HOOKUP

Connections	15-18
Connecting to the Aerial	15
Connections to Your TV	15
Connecting to a cable box or satellite receiver	16
Connecting an external decoder box	16
Connecting to an Amplifier	17
Accessory Audio/Video (A/V) Connections to Recorder	18
Connecting a Digital Camcorder	18
Before Operation	19-31
Initial Settings	19
General Operation	19
GENERAL	19-23
• Auto Programming	19
• Program Edit	20-21
• Auto Clock Set	22
• Manual Clock Set	22
• TV Aspect	22
• VCR Play Aspect	22
• VCR Play System	23
• AV2 Connection	23
• Progressive Scan	23
• Factory Setting	23
LANGUAGE	23
• Display Language	23
• Disc Language	23
AUDIO	24
• Dolby Digital	24
• DTS	24
• MPEG	24
• Sampling Frequency	24
• DRC (Dynamic Range Control)	24
• Vocal	24
LOCK (Parental Control)	25-26
• Set Password	25
• Movie Rating	25
• Country Code	26
RECORD	26-27
• Disc Record Mode	26
• VCR Record Mode	26
• VCR Record System	27
• DV Record Audio	27
• Auto Chapter	27
DISC	27-29
• Disc Initialize	27
• Disc Finalize	28
• Disc Label	28
• Disc Protect	29
• PBC	29
• Auto Play	29
General Explanation of On-Screen Display	30-32
• Displaying Information on-screen	30-32
• Displaying Information While Watching TV	30
• Changing TV Channels	30
• Changing TV Audio Channel	30

Table of Contents

PLAYBACK









Operation with DVD and Video CD	33-36
Playing a DVD or Video CD	33
General Features	33
• Moving to another TITLE	33
• Moving to another CHAPTER/TRACK	33
• Search	33
• Still Picture and Frame-by-Frame Playback	33
• Slow Motion	34
• Random	34
• Repeat	34
• Repeat A-B	34
• Time Search	34
• Zoom	35
• Marker Search	35
• Checking the contents of DVD Video discs: Menus	35
• Title Menu	35
• Disc Menu	35
• Camera Angle	35
• Changing the Audio Soundtrack	35
• Changing the Audio Channel	36
• 3D Surround	36
• Subtitles	36
• Finding Locations on a Disc	36
• Last Condition Memory	36
Audio CD and MP3/WMA Operation	37-38
Playing an Audio CD or MP3/WMA Disc	37
Music menu options	37
• Pause	38
• Moving to Another Track	38
• Repeat Track/All(Folder)/Off	38
• Random	38
• Changing the Audio Channel	38
• Search	38
• Repeat A-B	38
Notes on MP3/WMA Recordings	38
Programmed Playback with Audio CD and MP3/WMA	39
JPEG File Operation	40
Viewing a JPEG File	40
• Skip Image	40
• Rotate Images	40
• View Slide Shows	40
• Notes on JPEG Recordings	40
VCR Mode Tape Playback	41
Preparation	41
Normal Playback	41
• Tracking Control	41
Special Effect Playback	41
• Search	41
• Still Picture and Frame-by-Frame Playback	41
• Slow Motion	41
• Counter Memory Function	41

RECORDING

Basic Recording	42-43
Basic Recording from a TV	42
Instant Timer Recording	42
Copying from DVD to VCR	43
Copying from VCR to DVD	43

Timer Recording	44-45
Checking Timer Recording Details	45
Canceling a Timer Recording	45
Stopping a Timer Recording in Progress	45
Timer Recording Troubleshooting	45
Recording from an External Input	46-47
Recording from External Components	46
Recording from a Digital Camcorder	46
What is DV?	47
• DV-Related Messages	47
• Troubleshooting	47



EDITING

Title List and Chapter List Menu	48-52
Using the Title List-Original menu 	48
Using the Chapter List-Original menu 	48
Using the Title List-Playlist menu 	49
Using the Chapter List-Playlist menu 	49
Using the Title List menu 	50
• Deleting a Title	50
• If the disc has already been finalized	50
Using the Title List menu 	51
Using the Chapter List menu 	51
Using the Title List menu 	52
Using the Chapter List menu 	52
Title and Chapter Editing	53-58
Titles, Chapters and Parts	53
Adding Chapter Markers	53
Changing Title Thumbnails	53
Making a New Playlist	54
Adding Additional Title/Chapters to the Playlist	54
Deleting a Title/Chapter	55
Deleting a Part	55
Naming a Title	56
Combining Two Chapters Into One	56
Moving a Playlist Chapter	57
Protect a Title	57
Hide a Title/Chapter	58
Divide One Title Into Two	58
Additional Information	59
Clean-up Recording	59
Overwrite Recording	59
Viewing Title List menu displayed on other DVD recorders or players	59
Playing Your Recordings on other DVD Players (Finalizing a Disc)	59

REFERENCE

Language Code List	60
Country Code List	61
Controlling Your TV with the Supplied Remote	62
Troubleshooting	63-64
Specifications	65

About the symbols for instructions

-  Indicates hazards likely to cause harm to the unit itself or other material damage.
-  Indicates special operating features of this unit.
-  Indicates tips and hints for making the task easier.

Overview

Recordable Discs



DVD-RW (Digital Video Disc - ReWritable):
These Discs can be recorded on repeatedly. Recordings can be erased, then you can record again on the same Disc.



DVD-R (Digital Video Disc - Recordable):
These Discs can be recorded only once. After you finalize a DVD-R, you cannot record on it or edit it any more.



DVD+RW (Digital Video Disc + ReWritable):
These Discs can be recorded on repeatedly. Recordings can be erased, then you can record again on the same Disc.



DVD+R (Digital Video Disc + Recordable):
These Discs can be recorded only once. After you finalize a DVD+R, you cannot record on it or edit it any more.



- Notes**
- This recorder cannot record CD-R or CD-RW discs.
 - DVD-R/RW, DVD+R/RW and CD-R/RW discs recorded using a personal computer or a DVD or CD recorder may not play if the disc is damaged or dirty, or if there is dirt or condensation on the recorder's lens.
 - If you record a disc using a personal computer, even if it is recorded in a compatible format, there are cases in which it may not play because of the settings of the application software used to create the disc. (Check with the software publisher for more detailed information.)
 - The company does not hold any responsibility to compensate the contents which should have been recorded, and any losses or damages (e.g. losses of business profit, or business intermission) that may arise from malfunction of this recorder (not recording/editing as intended).
Problems arising in the following situations are included.
 - When a DVD disc recorded on this recorder is used in a DVD recorder of another manufacturer, or used (insertion, playback, recording or editing) in a personal computer DVD drive.
 - When a DVD that has been used as above is used again in this recorder.
 - When a DVD disc recorded in a DVD recorder of another manufacturer, or in a personal computer DVD drive is used.

Playable Discs



DVD
(8 cm/12 cm disc)



Video CD (VCD)
(8 cm / 12 cm disc)



Audio CD
(8 cm/12 cm disc)

In addition, this unit can play DVD-R/DVD-RW discs; DVD+R/DVD+RW discs; CD-R/CD-RW discs that contain audio titles, MP3 files, WMA files, or JPEG files; SVCD; and kodak picture CDs.



- Notes**
- Depending on the conditions of the recording equipment or the CD-R/RW (or DVD±R/±RW) disc itself, some CD-R/RW (or DVD±R/±RW) discs cannot be played on the unit.
 - Do not attach any seal or label to either side (the labeled side or the recorded side) of a disc.
 - Do not use irregularly shaped CDs (e.g., heart-shaped or octagonal). Doing so may result in malfunctions.

Regional code of the DVD Recorder and DVDs

This DVD Recorder is designed and manufactured for playback of Region 2 encoded DVD software. The region code on the labels of some DVD discs indicates which type of DVD Recorder can play those discs. This unit can play only DVD discs labeled 2 or ALL. If you try to play any other discs, the message "Incorrect region code. Can't play back" will appear on the TV screen. Some DVD discs may not have a region code label even though their playback is prohibited by area limits.



Notes on DVDs and Video CDs

Some playback operations of DVDs and Video CDs may be intentionally fixed by software manufacturers. As this unit plays DVDs and Video CDs according to disc content designed by the software manufacturer, some playback features of the unit may not be available or other functions may be added. Refer also to the instructions supplied with the DVDs and Video CDs. Some DVDs made for business purposes may not be played on the unit.

Overview (Continued)

Disc-related terms

Title (DVD only)

The main film content or accompanying feature content or music album.

Each title is assigned a title reference number enabling you to locate it easily.

Chapter (DVD only)

Sections of a picture or a musical piece that are smaller than titles. A title is composed of one or several chapters. Each chapter is assigned a chapter number to enable you to locate the chapter you want. Depending on the disc, chapters may not be labeled.

Track (Video CD and audio CD only)

Sections of a picture or a musical piece on a video CD or an audio CD. Each track is assigned a track number, enabling you to locate the track you want.

Scene

On a video CD with PBC (Playback control) functions, moving pictures and still pictures are divided into sections called "Scenes". Each scene available is displayed on the Scene menu and assigned a scene number, enabling you to locate the scene you want.

A scene may be composed of one or several tracks.

Types of video CDs

There are two types of video CDs:

Video CDs equipped with PBC (Version 2.0)

PBC (Playback control) functions allow you to interact with the system via menus, search functions, or other typical computer-like operations. Moreover, high resolution still pictures can be played if they are included on the disc.

Video CDs not equipped with PBC (Version 1.1)

Operated in the same way as audio CDs, these discs allow playback of video pictures as well as sound, but they are not equipped with PBC.





About Symbols











About the symbol display

" " may appear on the TV screen during operation. This icon means the function explained in this owner's manual is not available on that specific disc.

About the disc symbols for instructions

A section whose title has one of the following symbols are applicable only to those discs represented by the symbol.

Many functions of this recorder are dependent on the recording mode. One or more of the symbols (, , , ) appear by each function explained in this manual so that you can see at a glance whether it's relevant for the disc loaded.

	DVD-R/RW with Video recording mode
	DVD-RW with VR recording mode
	DVD+R disc
	DVD+RW disc
	DVD-Video disc
	Video CDs
	Audio CDs
	MP3 CDs
	JPEG CDs
	VHS Tape.

The finalized DVD disc is as DVD-Video disc

Overview (Continued)

About DVD-R and DVD-RW disc

How are DVD-R and DVD-RW discs different?

The essential difference between DVD-R and DVD-RW is that DVD-R is a record-once medium, while DVD-RW is a re-recordable/erasable medium. You can re-record/erase a DVD-RW disc approximately 1,000 times.

Can I play my recordable discs in a regular DVD player?

Generally, DVD-R discs and DVD-RW discs recorded in Video mode are playable in a regular DVD player, but they must be 'finalized' first. This process fixes the contents of the disc to make them readable to other DVD players as DVD-Video discs.

DVD-RW discs recorded in VR (Video Recording) mode are playable in some players.



This indicates a product feature that is capable of playing DVD-RW discs recorded with Video Recording format.

What are 'recording modes'?

There are two recording modes available using this recorder: VR mode and Video mode. When recording to a DVD-R disc, recordings are always in Video mode. DVD-RW discs can be formatted for VR mode recording or Video mode recording.

VR mode recording

- 4 different picture quality/recording time settings available (XP, SP, LP, EP)
- Not playable on regular DVD players
- Recordings can be extensively edited

Video mode recording

- 4 different picture quality/recording time settings available (XP, SP, LP, EP)
- Playable on regular DVD players (after finalizing)
- Limited editing features



DVD-Video Format (Video mode) is a new format for recording on DVD-R/RW and DVD+R/RW discs that was approved by the DVD Forum in 2000. You may therefore experience problems playing recordable DVD discs in some players. Symptoms include video artifacts, audio and/or video dropouts and playback suddenly stopping.

Our company cannot take responsibility for problems playing discs recorded on this recorder in other players.

Is editing a DVD like editing a video tape?

No. When you edit a video tape you need one video deck to play the original tape and another to record the edits. With DVD, you edit by making a 'Playlist' of what to play and when to play it. On playback, the recorder plays the disc according to the Playlist.

About word 'Original' and 'Playlist'

Throughout this manual, you will often see the words Original and Playlist to refer to the actual content and the edited version.

- **Original:** content refers to what's actually recorded on the disc.
- **Playlist:** content refers to the edited version of the disc — how the Original content is to be played.

About DVD+R and DVD+RW disc

How are DVD+R and DVD+RW discs different?

The essential difference between DVD+R and DVD+RW is that DVD+R is a record-once medium, while DVD+RW is a re-recordable/erasable medium. You can re-record/erase a DVD+RW disc approximately 1,000 times.

DVD+RW mode recording

- 4 different picture quality/recording time settings available (XP, SP, LP, EP)
- Playable on regular DVD players
- The edited contents is playable on regular DVD players only after finalizing
- Recordings can be edited the title/chapter

DVD+R mode recording

- 4 different picture quality/recording time settings available (XP, SP, LP, EP)
- Playable on regular DVD players (after finalizing)
- Any edited contents are not be compatible on regular DVD players. (Hide, chapter combine, added chapter mark, etc.)
- Limited title/chapter editing features

Overview (Continued)

About DVD recording

Notes

- This recorder cannot make recordings on CD-R or CD-RW discs.
- Our company takes no responsibility for recording failure due to power cuts, defective discs, or damage to the recorder.
- Fingerprints and small scratches on a disc can affect playback and/or recording performance. Please take proper care of your discs.

Disc types and recording formats, modes, and settings

This recorder can play five different kinds of DVD disc: pre-recorded DVD-Video discs, DVD-RW, DVD-R, DVD+RW and DVD+R discs. The disc format for DVD-R discs is always “Video format”—the same as pre-recorded DVD-Video discs. This means that once finalized, you can play a DVD-R in a regular DVD player. By default, the DVD-RW disc format is Video Recording format, though you can change this to Video format, if required. (Reinitializing the disc will erase the contents of the disc.)

The recording mode is closely related to the disc format. If the disc format is Video Recording format, then the recording mode is VR mode; if the disc format is Video mode, then the recording mode is Video mode (except for DVD-Video, which is not recordable, and so does not have a recording mode).

Within the recording modes (which are fixed for the whole disc) are the record settings. These can be changed as required for each recording and determine the picture quality and how much space the recording will take up on the disc.

Notes for recording

- The recording times shown are not exact because the recorder uses variable bit-rate video compression. This means that the exact recording time will depend on the material being recorded.
- When recording a TV broadcast, if the reception is poor or the picture contains interference, the recording times may be shorter.
- If you record still pictures or audio only, the recording time may be longer.
- The displayed times for recording and time remaining may not always add up to exactly the length of the disc.
- The recording time available may decrease if you heavily edit a disc.
- If using a DVD-RW disc, make sure you change the recording format (Video mode or VR mode) before you record anything on the disc. See page 27 (Disc Initialize) for how to do this.
- When using a DVD-R disc, you can keep recording until the disc is full, or until you finalize the disc. Before you start a recording session, check the amount of recording time left on the disc.
- When using a DVD-RW disc in Video mode, recording time available will only increase if you erase the last title recorded on the disc.
- The Erase Title option in the Title List-Original menu only hides the title, it does not actually erase the title from the disc and increase the recording time available (except for the last recorded title on a DVD-RW disc in Video mode).
- The overwrite recording is available with DVD+RW disc.

Disc type	Disc format	Recording mode	Functions
DVD-Video	Video format	n/a	Playback only
DVD-RW	Video Recording format (default)	VR mode	Playback, recording, Original/Playlist editing
	Video format	Video mode	Playback, limited recording, limited editing
DVD-R	Video format	Video mode	Playback, limited recording, limited editing
DVD+RW	+RW Video format	DVD+RW	Playback, limited recording, Title/Chapter editing
DVD+R	+R Video format	DVD+R	Playback, limited recording, limited Title/Chapter editing

Overview (Continued)

Recording TV audio channels

This recorder can record either NICAM or regular audio. If the NICAM setting (page 21) is set to Auto, then if the broadcast is NICAM, you can record the NICAM audio. If the broadcast is non-NICAM, the regular audio is always recorded.

Restrictions on video recording

- You cannot record copy-protected video using this recorder. Copy-protected video includes DVD-Video discs and some satellite broadcasts. If copy-protected material is encountered during a recording, recording will pause or stop automatically and an error message will be displayed on-screen.
- Video that is 'copy-once only' can only be recorded using a DVD-RW disc in VR mode with CPRM (see below).
- NTSC format signals from the analog or the DV inputs is not recorded correctly with this recorder.
- Video signals in SECAM format (from the built-in TV tuner or from the analog inputs) are recorded in PAL format.

What is 'CPRM'?

CPRM is a copy protection system (with scramble system) only allowing the recording of 'copy once' broadcast programs. CPRM stands for Content Protection for Recordable Media.

This recorder is CPRM compatible, which means that you can record copy-once broadcast programs, but you cannot then make a copy of those recordings. CPRM recordings can only be made on DVD-RW discs formatted in VR mode, and CPRM recordings can only be played on players that are specifically compatible with CPRM.

Copyright

- Recording equipment should be used only for lawful copying and you are advised to check carefully what is lawful copying in the country in which you are making a copy. Copying of copyright material such as films or music is unlawful unless permitted by a legal exception or consented to by the rights owner.
- This product incorporates copyright protection technology that is protected by method claims of certain U.S. patents and other intellectual property rights owned by Macrovision Corporation and other rights owners. Use of this copyright protection technology must be authorized by Macrovision Corporation, and is intended for home and other limited viewing uses only unless otherwise authorized by Macrovision corporation. Reverse engineering or disassembly is prohibited.
- CONSUMERS SHOULD NOTE THAT NOT ALL HIGH DEFINITION TELEVISION SETS ARE FULLY COMPATIBLE WITH THIS PRODUCT AND MAY CAUSE ARTIFACTS TO BE DISPLAYED IN THE PICTURE. IN CASE OF 625 PROGRESSIVE SCAN PICTURE PROBLEMS, IT IS RECOMMENDED THAT THE USER SWITCH THE CONNECTION TO THE 'STANDARD DEFINITION' OUTPUT. IF THERE ARE QUESTIONS REGARDING OUR TV SET COMPATIBILITY WITH THIS MODEL 625p RECORDER, PLEASE CONTACT OUR CUSTOMER SERVICE CENTER.

Remote Control Operation Range

Point the remote control at the remote sensor and press the buttons.

Remote Control Battery Installation

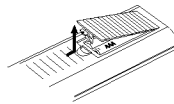

Detach the battery cover on the rear of the remote control, and insert two R03 (size AAA) batteries with \oplus and \ominus aligned correctly.

Caution

Do not mix old and new batteries. Never mix different types of batteries (standard, alkaline, etc.).

Reset the Recorder

If you observe any of the following symptoms...

- The front panel display is not working.
- The Recorder is not operating normally.

...you can reset the Recorder as follows:

- Press and hold the POWER button for at least five seconds. This will force the unit to power off. Press the POWER button again to turn the unit back on.
- Unplug the power cord, wait at least five seconds, and then plug it in again.

Overview (Continued)

Precautions

Handling the unit

When shipping the unit

The original shipping carton and packing materials come in handy. For maximum protection, re-pack the unit as it was originally packaged at the factory.

When setting up the unit

The picture and sound of a nearby TV, VCR, or radio may be distorted during playback. In this case, position the unit away from the TV, VCR, or radio, or turn off the unit after removing the disc.

To keep the surface clean

Do not use volatile liquids, such as insecticide spray, near the unit. Do not leave rubber or plastic products in contact with the unit for a long period of time. They will leave marks on the surface.

Cleaning the unit

To clean the cabinet

Use a soft, dry cloth. If the surfaces are extremely dirty, use a soft cloth lightly moistened with a mild detergent solution. Do not use strong solvents such as alcohol, benzene, or thinner, as these might damage the surface of the unit.

To obtain a clear picture

The Recorder is a high-tech, precision device. If the optical pick-up lens and disc drive parts are dirty or worn, the picture quality will be poor.

Regular inspection and maintenance are recommended after every 1,000 hours of use. (This depends on the operating environment.)

For details, please contact your nearest dealer.

Notes on Discs

Handling discs

Do not touch the playback side of the disc. Hold the disc by the edges so that fingerprints will not get on the surface. Do not stick paper or tape on the disc.



Storing discs

After playing, store the disc in its case.

Do not expose the disc to direct sunlight or sources of heat, or leave it in a parked car exposed to direct sunlight, as there may be a considerable temperature increase inside the car.

Cleaning discs

Fingerprints and dust on the disc can cause poor picture quality and sound distortion. Before playing, clean the disc with a clean cloth. Wipe the disc from the center outward.



Do not use strong solvents such as alcohol, benzene, thinner, commercially available cleaners, or anti-static spray intended for older vinyl records.

Front Panel

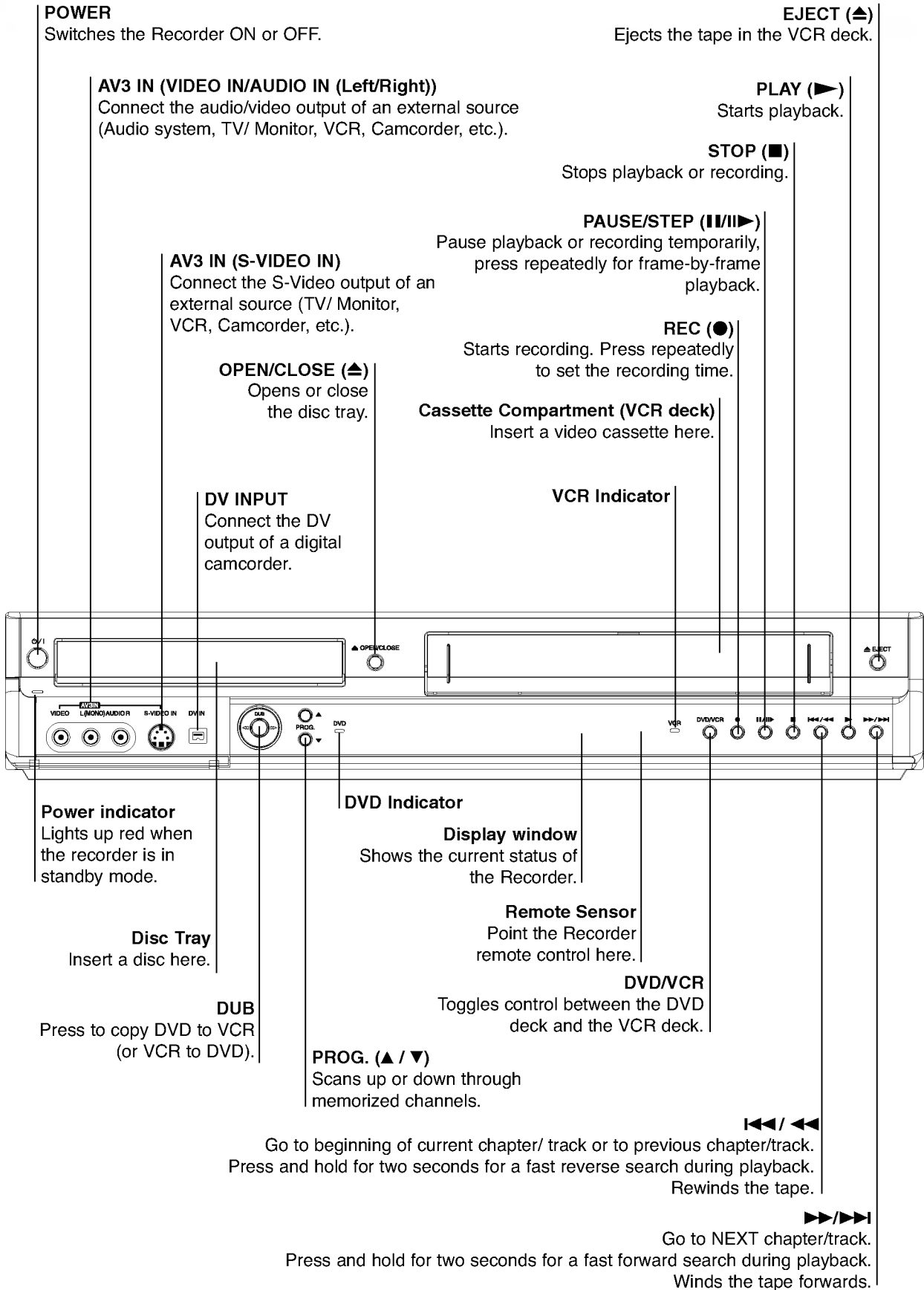

Function Display Window

Disc type indicators

Indicates the type of disc loaded.

 Indicates when the recorder is in timer recording or a timer recording is programmed.

REC The recorder is recording.

PRG Programmed playback active

TTL Indicates current title.

A disc is inserted in the DVD deck.

A VHS tape is inserted in the VCR deck.

Indicates a DVD-RW disc (VR mode only) is inserted in the DVD deck.

TV Indicates when the recorder is in TV tuner mode.

CHP/TRK Indicates current chapter or track number

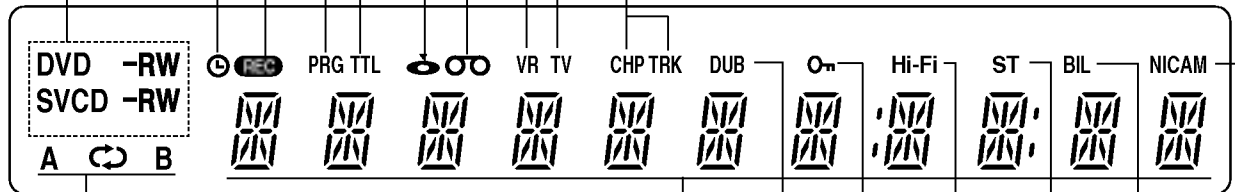

REPEAT Indicates repeat mode.

Character indicators

Indicates clock, total playing time, elapsed time, remaining time, title number, chapter/track number, channel, etc.

DUB Indicates that a DVD to VCR (or VCR to DVD) copy is in progress.

Indicates when the Recorder is Locked.

Hi-Fi Indicates when the Recorder is playing a tape in Hi-Fi.

ST Indicates a stereo broadcast is being received.

BIL Indicates when a BILINGUAL broadcast is being received.

NICAM Indicates when a NICAM broadcast is being received.

Remote Control Overview

- POWER**
Switches the recorder ON or OFF.
- DVD**
Select the Recorder's function mode to DVD.
- VCR**
Select the Recorder's function mode to VCR.
- AV**
Changes the input to use for recording (Tuner, AV1-3, or DV IN).
- 0-9 numerical buttons**
Selects numbered options in a menu.
- TITLE**
Displays the disc's Title menu, if available.
- AUDIO**
Selects an audio language (DVD) or an audio channel (CD).
- SUBTITLE**
Selects a subtitle language.
- ANGLE**
Selects a DVD camera angle, if available.
- REC (●)**
Starts recording. Press repeatedly to set the recording time.
- REC MODE**
Selects the recording mode: XP, SP, LP, or EP.
- TIMER REC**
Displays Timer Record menu.
- MARKER**
Marks any point during playback.
- SEARCH**
Displays Marker Search menu.
- ZOOM**
Enlarges DVD video image.
- DUBBING**
Press to copy DVD to VCR (or VCR to DVD).
- LOCK**
Locks/unlocks front panel buttons.
- CHP ADD**
Inserts a chapter marker when playing/recording a VR mode DVD-RW (and DVD+RW/+R) disc.
- THUMBNAIL**
Selects a thumbnail picture for the current title and chapter for use in the Original and Playlist menu.
- CLEAR**
- Removes a track number on the Program List or a mark on the Marker Search menu.
- Reset tape counter to zero.

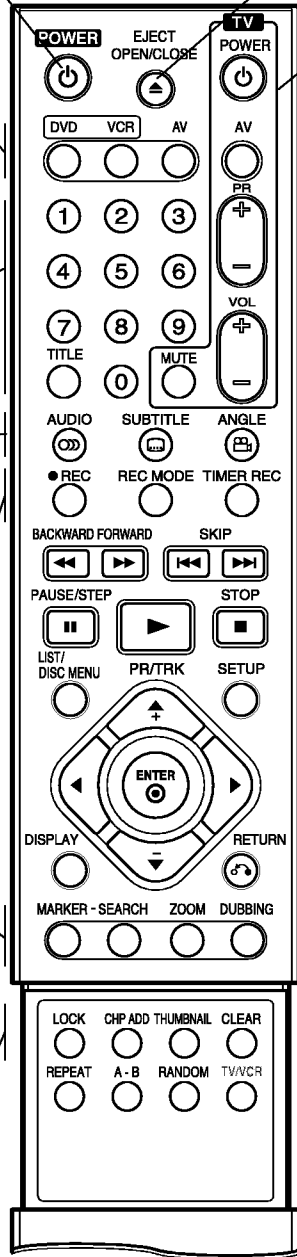

- EJECT, OPEN/CLOSE**
- Opens and closes the disc tray.
- Ejects the tape in the VCR deck.
- TV Control Buttons (See page 62)**
POWER: Turns the TV on or off.
AV: Selects the TV's source.
PR +/-: Selects TV's channel.
VOL +/-: Adjusts TV's volume.
MUTE: Temporarily turns TV sound OFF, press again to restore.
- BACKWARD / FORWARD (◀▶)**
- DVD: Search backward or forward.
- VCR: Rewinds the tape during the STOP mode, for fast reverse picture search and Advances the tape during the STOP mode, fast forward picture search.
- SKIP (◀◀ / ▶▶)**
Go to next chapter or track. Returns to beginning of current chapter or track or go to previous chapter or track.
- PAUSE/STEP (⏸)**
Pause playback temporarily / press repeatedly for frame-by-frame playback.
- ▶ (PLAY)**
Starts playback.
- STOP (■)**
Stops playback or recording.
- LIST / DISC MENU**
Accesses menu on a DVD disc, Title List or Playlist menu.
- ◀ / ▶ / ▲ / ▼ (left/right/up/down)**
Selects an option in the menu.
- PR/TRK(+/-)**
- Select channel programme of the recorder.
- To adjust tracking.
- To control vertical tremble during picture still.
- ENTER**
- Acknowledges menu selection.
- Displays information while viewing a TV program.
- SETUP**
Accesses or removes the Setup menu.
- DISPLAY**
Accesses On-Screen Display.
- RETURN (↶)**
- Removes the menu.
- Displays the menu of a video CD with PBC.
- REPEAT**
Repeat chapter, track, title, all.
- A-B**
Repeat sequence.
- RANDOM**
Plays tracks in random order.
- TV/VCR**
To view channels selected by the recorder tuner or by the TV tuner.

LOCK
The Lock feature disables the front panel buttons to prevent children from tampering with the Recorder. Simply press LOCK on the remote control to toggle this feature on and off.

Rear Panel

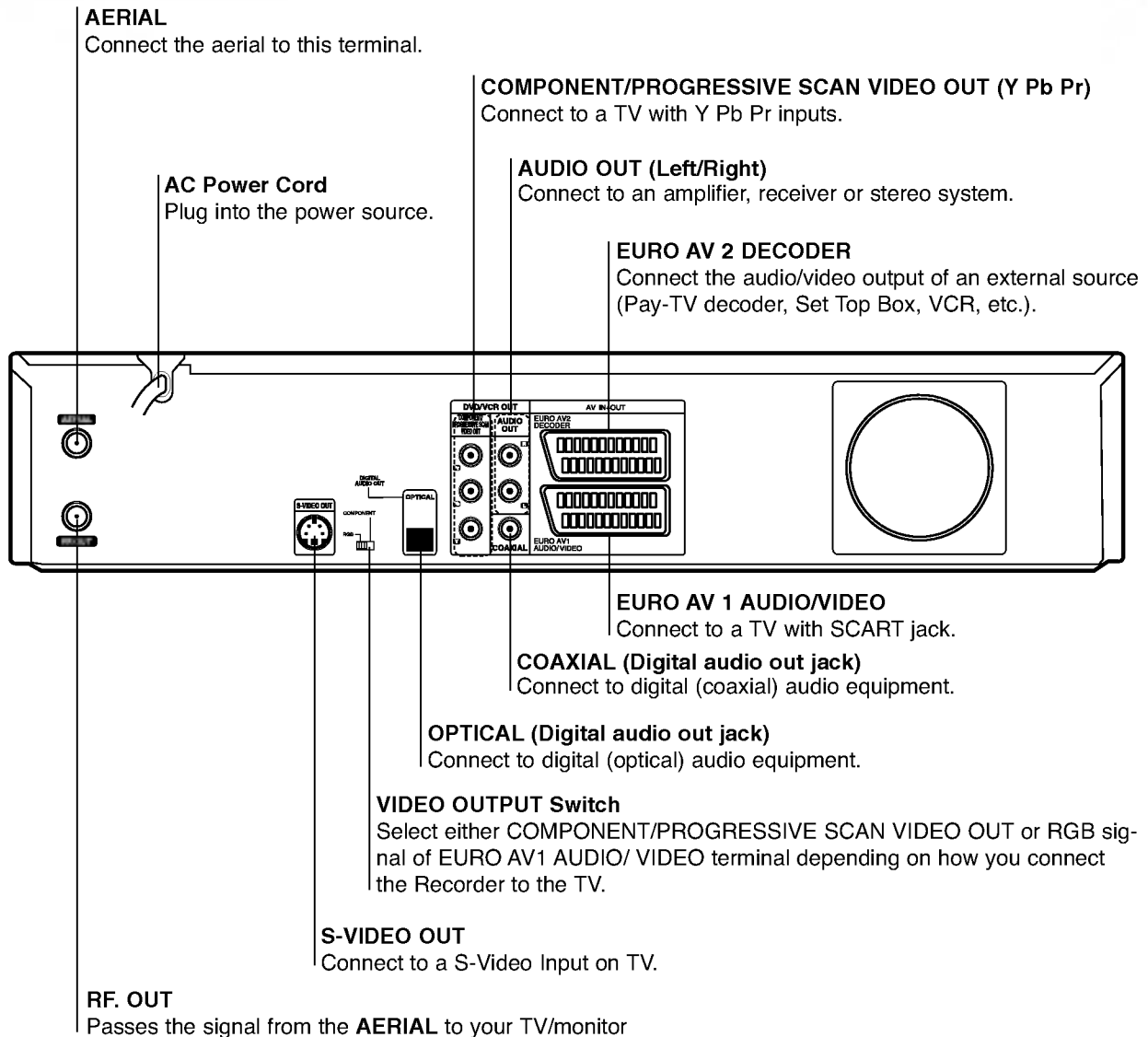

Important Note

About Ferrite Core

Be sure to attach the ferrite core to the power cord (for connecting to this unit).
This ferrite core can reduce noises.

- 1 Push the stopper [a] of the ferrite core to open.
- 2 Wind the power cord twice on ferrite core.
- 3 Close the ferrite core until it clicks.

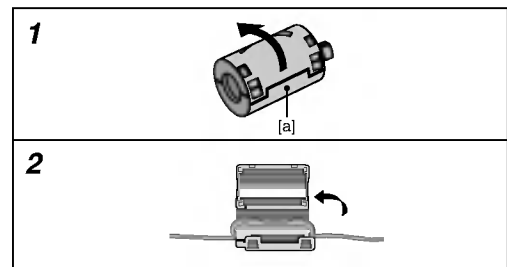

Caution

Do not touch the inner pins of the jacks on the rear panel. Electrostatic discharge may cause permanent damage to the unit.

Connections

Tips

- Depending on your TV and other equipment you wish to connect, there are various ways you could connect the recorder. Use only one of the connections described below.
- Please refer to the manuals of your TV, VCR, Stereo System or other devices as necessary to make the best connections.

Caution

- Make sure the Recorder is connected directly to the TV. Tune the TV to the correct video input channel.
- Do not connect the Recorder's AUDIO OUT jack to the phono in jack (record deck) of your audio system.
- Do not connect your Recorder via your VCR. The DVD image could be distorted by the copy protection system.

Connecting to the Aerial

Remove the aerial cable plug from your TV set and insert it into the aerial socket at the back of the recorder. Plug one end of the aerial cable into the TV socket on the recorder and the other end into the aerial input socket on your TV set.

RF coaxial connection

Connect the RF. OUT jack on the Recorder to the aerial input jack on the TV using the 75-ohm Coaxial Cable supplied (R). The RF. OUT jack passes the signal through from the AERIAL jack.

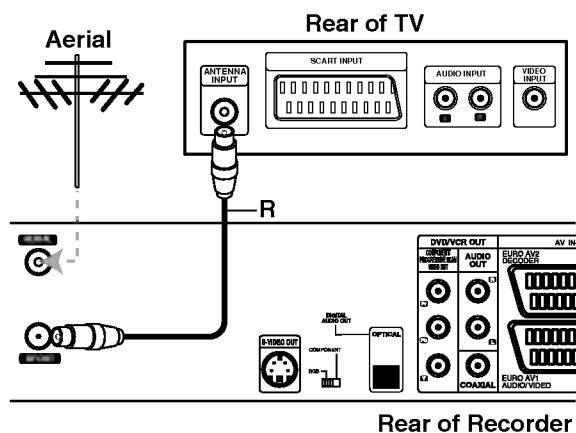

Connections to Your TV

- Make one of the following connections, depending on the capabilities of your existing equipment.
- When using the COMPONENT/PROGRESSIVE SCAN VIDEO OUT jacks, set the VIDEO OUTPUT switch to COMPONENT. When using the SCART jack, set the VIDEO OUTPUT switch to RGB.

SCART connection

Connect the EURO AV1 AUDIO/VIDEO scart jack on the Recorder to the corresponding in jacks on the TV using the scart cable (T).

S-Video connection

Connect the S-VIDEO OUT jack on the Recorder to the S-Video in jack on the TV using the S-Video cable (S).

Component Video connection

Connect the COMPONENT/PROGRESSIVE SCAN VIDEO OUT jacks on the Recorder to the corresponding input jacks on the TV using a Y Pb Pr cable (C).

Progressive Scan (ColorStream®Pro) connection

If your television is a high-definition or "digital ready" television, you may take advantage of the recorder's progressive scan output for the highest video resolution possible. If your TV does not accept the Progressive Scan format, the picture will appear scrambled if you try Progressive Scan on the recorder.

Connect the COMPONENT/PROGRESSIVE SCAN VIDEO OUT jacks on the Recorder to the corresponding input jacks on the TV using a Y Pb Pr cable (C).

Notes

- Set the Progressive to "ON" on the setup menu for progressive signal, see page 23.
- Set the progressive to "Off" by removing any disc from the unit and close the disc tray. Then press STOP and hold it for five seconds before releasing it.
- Progressive scan does not work with the analog video connections or S-VIDEO connection.

Audio (Left/Right) Connection

Connect the left and right AUDIO OUT jacks of the Recorder to the audio left and right IN jacks on the TV using the audio cables (A). Do not connect the Recorder's AUDIO OUT jack to the phono in jack (record deck) of your audio system. If you are using the COMPONENT/PROGRESSIVE SCAN VIDEO OUT jacks, but are connecting the recorder to a standard (analog) television, set Progressive Scan to OFF.

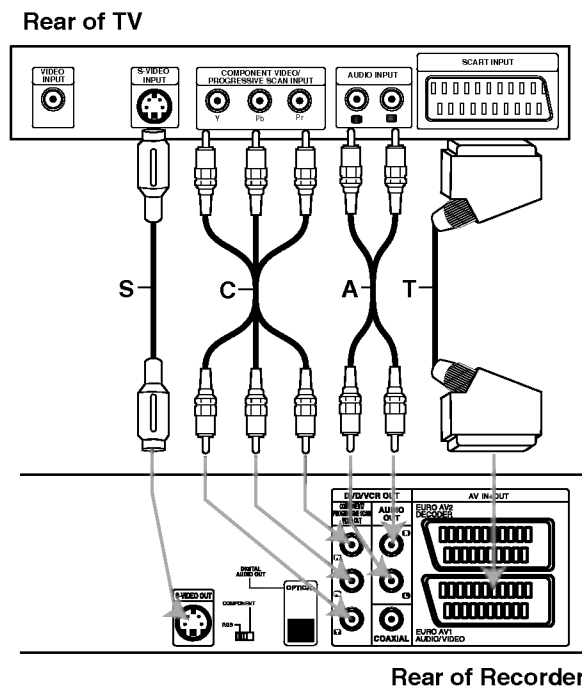

Connections (Continued)

Connecting to a cable box or satellite receiver

If you have a cable or satellite receiver with a built-in decoder, connect it to this recorder and your TV as shown on this page. If you are using a separate decoder box for your cable/satellite TV, set up following the instructions on the right.

Using the setup on this page you can:

- Record any channel by selecting it on the cable box/satellite tuner.

- 1 Connect RF cables as shown. This enables you to watch and record TV channels.
- 2 Use the SCART cable to connect the EURO AV1 AUDIO/VIDEO connector to a SCART AV connector on your TV.
- 3 Use a SCART cable to connect the EURO AV2 DECODER connector to a SCART AV connector on your satellite/cable box. This enables you to record scrambled TV channels.



This recorder has a 'loop through' function. This feature allows you to record a TV program from the built-in TV tuner in this recorder, while watching a satellite or cable channel. Press TV/VCR to select the TV mode during recording. The TV indicator appears.



Caution: Do not connect this recorder 'through' your VCR, satellite receiver or cable box. Always connect each component directly to your TV or AV receiver.

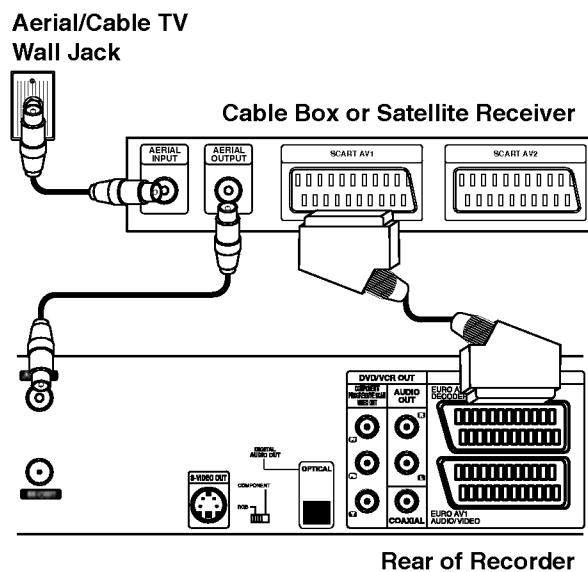

Connecting an external decoder box

If you have an external, dedicated decoder box for your satellite or cable TV system, use the setup described on this page.

- 1 Connect the cable from the aerial/cable TV outlet to the aerial input on your cable/satellite tuner.
- 2 Use a SCART cable to connect your decoder to your cable/satellite tuner. See the manual for your decoder box for more detailed instructions.
- 3 Use a SCART cable to connect the EURO AV2 DECODER connector to a SCART AV connector on your satellite/cable box.
- 4 Use the SCART cable to connect the EURO AV1 AUDIO/VIDEO connector to a SCART AV connector on your TV.



- Caution:**
- Do not connect your decoder box directly to this recorder.
 - Information from the decoder (for example, relating to pay TV services), is only viewable when this recorder is off (in standby).
 - For timer recording to work properly on this recorder, the satellite/cable box must also be switched on during recording.

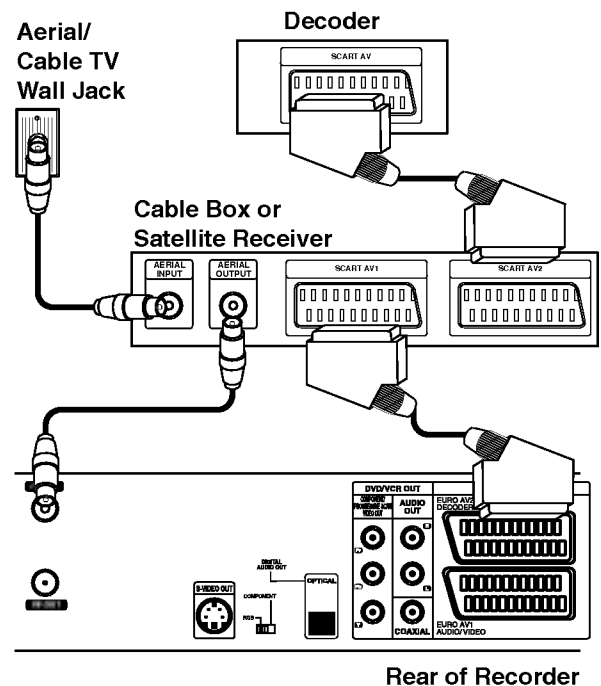

Connections (Continued)

Connecting to an Amplifier

Connecting to an amplifier equipped with two channel analog stereo or Dolby Pro Logic II/ Pro Logic

Connect the Left and Right AUDIO OUT jacks on the Recorder to the audio left and right in jacks on your amplifier, receiver, or stereo system, using the audio cables (A).

Connecting to an amplifier equipped with two channel digital stereo (PCM) or to an Audio/Video receiver equipped with a multi-channel decoder (Dolby Digital™, MPEG 2, or DTS)

- 1 Connect one of the Recorder's DIGITAL AUDIO OUT jacks (OPTICAL O or COAXIAL X) to the corresponding in jack on your amplifier. Use an optional digital (optical O or coaxial X) audio cable.
- 2 You will need to activate the recorder's digital output. (See "AUDIO" on page 24).

Digital Multi-channel sound

A digital multi-channel connection provides the best sound quality. For this you need a multi-channel Audio/Video receiver that supports one or more of the audio formats supported by your Recorder (MPEG 2, Dolby Digital and DTS). Check the receiver manual and the logos on the front of the receiver.

Caution:

Due to the DTS Licensing agreement, the digital output will be in DTS digital out when DTS audio stream is selected.

Notes

- If the audio format of the digital output does not match the capabilities of your receiver, the receiver will produce a strong, distorted sound or no sound at all.
- Six Channel Digital Surround Sound via digital connection can only be obtained if your receiver is equipped with a Digital Multi-channel decoder.
- To see the audio format of the current DVD in the on-screen display, press AUDIO.
- This recorder does not perform internal (2 channel) decoding of a DTS sound track. To enjoy DTS multi channel surround, you must connect this recorder to a DTS compatible receiver via one of this recorder's digital audio outputs.

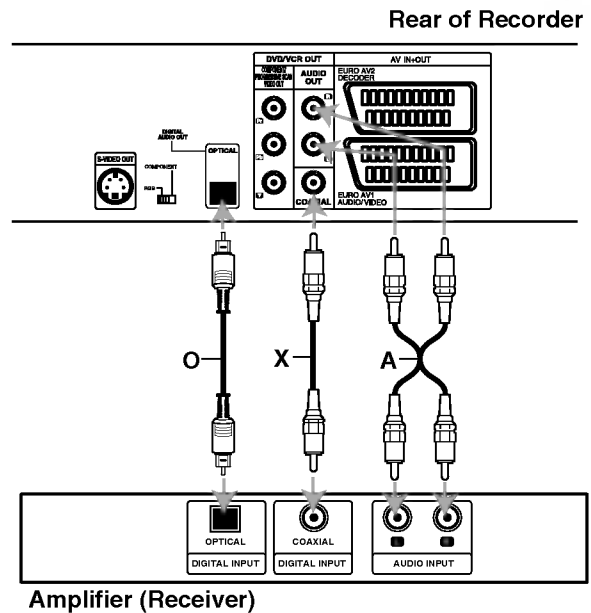

Connections (Continued)

Accessory Audio/Video (A/V) Connections to Recorder

Connect the input jacks (AV3) on the Recorder to the audio/video out jacks on your accessory component, using audio/video cables.

Note

If you use the S-VIDEO IN jack on the front panel, the VIDEO IN jack on the front panel is not available.

Jack panel of Accessory Component (VCR, Camcorder, etc.)

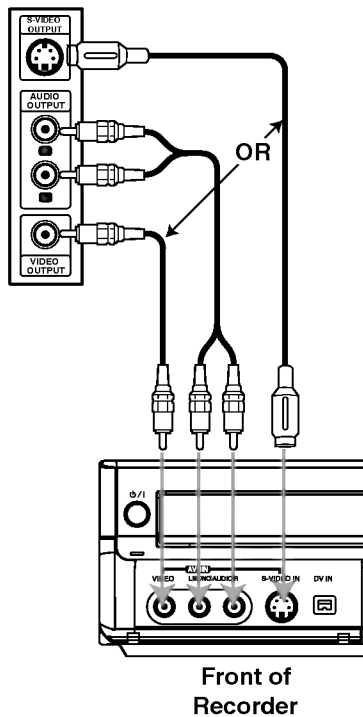

Connecting a Digital Camcorder

Using the front panel DV IN jack, it is possible to connect a DV digital camcorder or video deck or DVD-R/RW recorder and digitally transfer DV tapes or DVD-R/RW discs to DVD-R/RW.

Use a DV cable (not supplied) to connect the DV in/out jack of your DV camcorder/video deck to the front panel DV IN jack of this recorder.

Note

This jack is for connection to DV equipment only. It is not compatible with digital satellite tuners or D-VHS video decks.

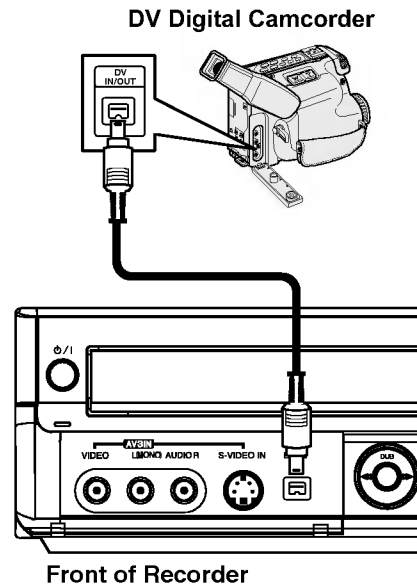

Before Operation

Initial Settings

In this menu system, there are several ways to customize the settings provided. Most menus consist of three levels to set up the options, but some require greater depth for the variety of settings. If you press SETUP, only the first and second level of the menu system will appear on the TV screen. The third level can be displayed by pressing ►. For navigating the menu levels, you will see “►” on the right side of the menu label to help you go to the next level.

To bring up and exit the Menu:

Press SETUP to bring up the menu. A second press of SETUP will take you back to initial screen.

To go to the next level:

Press ► on the remote control.

To go back to the previous level:

Press ◀ on the remote control.

General Operation

- 1** Press SETUP.
The Setup menu appears.
- 2** Use ▲ / ▼ to select the desired option.
- 3** While the desired item is selected, press ► to move to the second level.
- 4** Use ▲ / ▼ to select the second desired option.
- 5** Press ► to move to the third level.
- 6** Use ▲ / ▼ to select the desired setting then press ENTER to confirm your selection.
Some items require additional steps.
- 7** Press SETUP to exit the Setup menu.

GENERAL

Auto Programming

This Recorder is equipped with a frequency synthesized tuner capable of receiving up to 99 TV channels.

Preparation:

- Connect the Recorder to the desired type of aerial, as shown in Connecting to the Aerial on page 15.

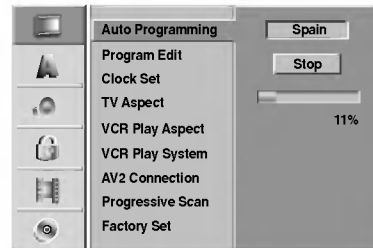

- 1** Press SETUP.
The Setup menu appears.
- 2** Use ▲ / ▼ to select the GENERAL option.
- 3** While the GENERAL option is selected, press ► to move to the second level.
- 4** Use ▲ / ▼ to select the Auto Programming option.
- 5** Press ► to move to the third level.
Country option is highlighted.
- 6** Use ▲ / ▼ to select a country then press ►.
“Start” icon is highlighted.
- 7** Press ENTER to begin the channel search.
The tuner will automatically cycle through all available channels in the area and place them in the tuner’s memory.

Before Operation (Continued)

Program Edit

You can edit a channel manually (add, delete, name, move, etc.).

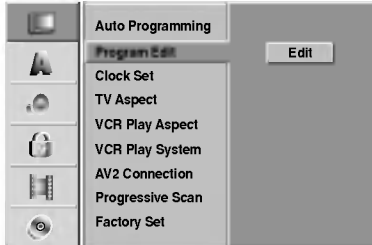

- 1** Press **SETUP**.
The Setup menu appears.
- 2** Use **▲ / ▼** to select the **GENERAL** option.
- 3** While the **GENERAL** option is selected, press **▶** to move to the second level.
- 4** Use **▲ / ▼** to select the **Program Edit** option then press **▶** to move to the third level.
"Edit" icon is highlighted.
- 5** Press **ENTER**.
Program List menu appears.

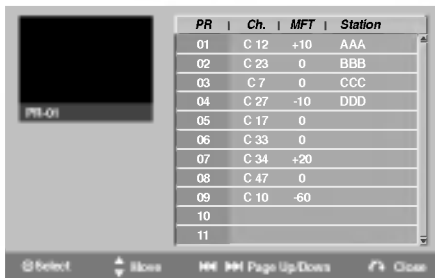

- 6** Use **▲ / ▼** to select a **PR** number then press **ENTER**.
Program List options appears on the left side of the menu display.
- 7** Use **▲ / ▼** to select an option then press **ENTER** to confirm.

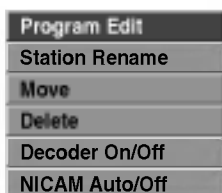

Program Edit: Edits the selected program.

Station Rename: Edits the station name.

Move: Moves the program's location on the program list.

Delete: Deletes the program from program list.

Decoder On/Off: Set the decoder for the program to On or Off.

NICAM Auto/Off: Set the NICAM function to for the program Auto or Off.

- 8** Press **RETURN** (**↵**) repeatedly to exit Program List menu.

Program Edit

You can perform a search to select and store TV channels manually.

1. Use **▲ / ▼** to select a program on the Program List menu then press **ENTER**.
Program List options appears on the left side of the Program List menu.
2. Use **▲ / ▼** to select 'Program Edit' option from the options then press **ENTER**.
Program Edit menu appears.

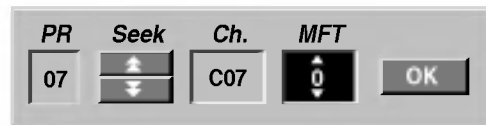

3. See the descriptions on below to use Program Edit menu.
 - ◀ / ▶** (left/right): Moves the cursor to the previous or next column.
 - ▲ / ▼** (up/down): Changes the setting at the current cursor position.
 - PR:** Indicates program number (display only)
 - Seek:** Searches a station automatically. Use **◀ / ▶** to select Seek option then press **▲ / ▼**. Searching stops when the recorder tunes in a station.
 - Ch.:** Changes the channel number to edit. Use **◀ / ▶** to select Ch. option then press **▲ / ▼**.
 - MFT:** Changes the frequency for fine tuning. Use **◀ / ▶** to select MFT option then press **▲ / ▼**.
4. Choose **OK** then press **ENTER** to confirm the setting and returns to the Program List menu.

Before Operation (Continued)

Program Edit (Continued)

Station Rename

You can name stations independently. Names can be up to 5 characters long.

1. Use ▲ / ▼ to select a program on the Program List menu then press ENTER.
Program List options appears on the left side of the Program List menu.
2. Use ▲ / ▼ to select 'Station Rename' option from Program List options then press ENTER.
Keyboard menu appears.

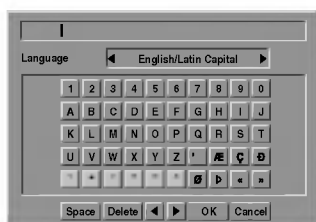

3. Enter a name for the station. Use ▲ ▼ ◀ ▶ to select a character then press ENTER to confirm your selection.
 - **English/Latin Capital:** Switches the keyboard upper case characters.
 - **English/Latin Lowercase:** Switches the keyboard to lower case characters.
 - **Symbols:** Switches the keyboard to symbol characters.
 - **Space:** Inserts a space at the cursor position.
 - **Delete:** Deletes the previous character at the cursor position.
 - **◀ / ▶:** Moves cursor to left or right.
 - **OK:** Select to finish.
 - **Cancel:** Select to exit the menu.
4. Choose 'OK' icon then press ENTER to fix the name and returns to the Program List menu.

Sort TV channels manually

You can sort the program's position on the Program List menu.

1. Use ▲ / ▼ to select a program on the Program List menu then press ENTER.
Program List options appears on the left side of the Program List menu.
2. Use ▲ / ▼ to select 'Move' option from Program List options then press ENTER.
3. Use ▲ / ▼ to select a desired position then press ENTER to store.

Deleting a program

You can delete a program on the Program List menu.

1. Use ▲ / ▼ to select a program on the Program List menu then press ENTER.
Program List options appears on the left side of the Program List menu.
2. Use ▲ / ▼ to select 'Delete' option from Program List options then press ENTER. The Program is deleted.

Setting the Decoder On/Off

1. Use ▲ / ▼ to select the program you wish to link with the decoder function on the Program List menu then press ENTER.
Program List options appears on the left side of the Program List menu.
2. Use ▲ / ▼ to select 'Decoder On/Off' option from Program List options then press ENTER. If you select On, 'Decoder' appears on the menu screen.

Setting the NICAM Auto/Off

This DVD recorder can receive Hi-Fi sound transmissions in NICAM Stereo. However, if sound distortion occurs, due to poor reception, you can switch Off

1. Use ▲ / ▼ to select a program on the Program List menu then press ENTER.
Program List options appears on the left side of the Program List menu.
2. Use ▲ / ▼ to select 'NICAM Auto/Off' option from Program List options then press ENTER. If you select Auto, 'NICAM' appears on the menu screen.

Before Operation (Continued)

Auto Clock Set

When Channel auto search is completed the actual Time and Date are also set automatically. If the time in the recorder display is not correct, the clock must be set manually.

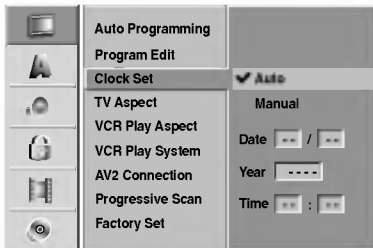

- 1** Press **SETUP**.
The Setup menu appears.
- 2** Use **▲ / ▼** to select the **GENERAL** menu.
- 3** While the **GENERAL** option is selected, press **▶** to move to the second level.
- 4** Use **▲ / ▼** to select the **Clock Set** option.
- 5** Press **▶** to move to the third level.
- 6** Use **▲ / ▼** to select the **Auto** option then press **ENTER**.
- 7** Press **SETUP** to exit the Setup menu.

Note

There are cases where the TV station does not send, or sends wrong date and/or time information and the Recorder sets the incorrect time. If this happens, we recommend that you set the clock manually.

Manual Clock Set

- 1** Follow steps 1-5 as shown above (Auto Clock Set).
- 2** Use **▲ / ▼** to select the **Manual** option then press **ENTER**.

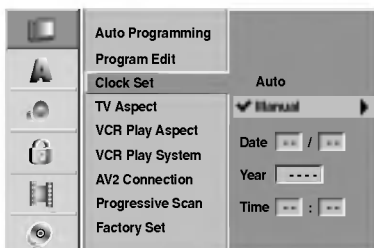

- 3** Enter the necessary information for date and time.

◀ / ▶ (left/right): Moves the cursor to the previous or next column.

▲ / ▼ (up/down): Changes the setting at the current cursor position.

- 4** Press **ENTER** to confirm your setting, then press **SETUP** to exit the Setup menu.

TV Aspect

To record a wide screen format programme successfully the correct type of wide screen signal must be broadcast by the TV station.

You can choose:

4:3 Letter Box: Select when a standard 4:3 TV is connected. Displays theatrical images with masking bars above and below the picture.

4:3 Pan Scan: Select when a standard 4:3 TV is connected. The video material formatted in the Pan & Scan style is played back in that style (Both sides of the picture are cut off).

16:9 Wide: Select when a 16:9 wide TV is connected.

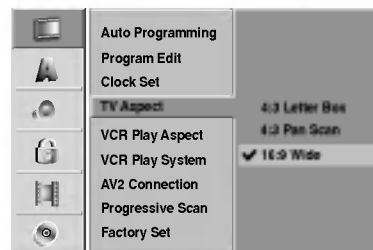

VCR Play Aspect

You can choose:

AUTO: Automatically plays back Wide-Screen programmes as Wide-Screen and Normal programmes as normal.

4:3: Only for playing back Normal format recordings (4:3).

16:9: Only for playing back Wide-Screen format recordings (16:9).



Before Operation (Continued)

VCR Play System

Your video recorder uses dual colour standards, PAL and MESECAM. During play your video recorder should select the colour system automatically, however if you experience problems you may need to do it manually.

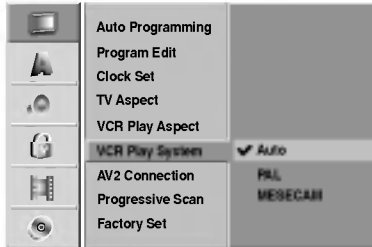

AV2 Connection

You can connect a decoder, satellite receiver or other device to the EURO AV2 socket on the back.

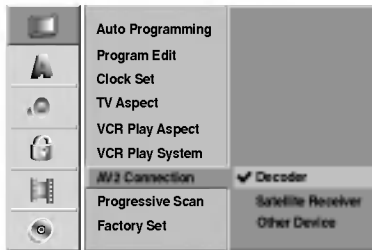

Progressive Scan

Progressive Scan Video provides the highest quality pictures with less flickering.

If you are using the COMPONENT/PROGRESSIVE SCAN VIDEO OUT jacks, but are connecting the recorder to a standard (analog) television, set Progressive Scan to OFF.

If you are using the component video jacks for connection to a TV or monitor that is compatible with a progressive scan signal, set Progressive Scan to ON.



Note

Progressive Scan will not be set when the VIDEO OUTPUT switch is set at RGB position.

Caution

Once the setting for progressive scan output is entered, an image will only be visible on a progressive scan compatible TV or monitor. If you set Progressive Scan to On in error, you must reset the unit.

- 1) Remove any disc from the unit and close the disc tray.
- 2) Press STOP and hold it for five seconds before releasing it. The video output will be restored to the standard setting and a picture will once again be visible on a conventional analog TV or monitor.

Factory Setting

If you need to, you can reset the recorder to all its factory settings. Select 'SET' icon then press ENTER.

Note

Some options can not be reset.

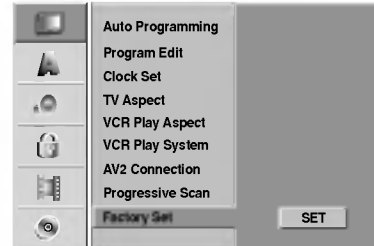

LANGUAGE

Display Language

Select a language for the Setup menu and on-screen display.



Disc Language

Select a language for the disc's Menu, Audio, and Subtitle.

- Original: The original language set for the disc is selected.
- Other: To select another language, select Other option then press ENTER. Use the numbered and ENTER buttons to key-in the corresponding 4-digit number according to the language code list on page 60. If you a mistake before pressing ENTER, press ◀ repeatedly to delete one by one and correct it.



Before Operation (Continued)

AUDIO

Each DVD disc has a variety of audio output options. Set the recorder's Audio Output according to the type of audio system you use.

Dolby Digital

PCM: Select when connected to a 2-channel digital stereo amplifier. The Recorder's digital audio outputs sounds in the PCM 2ch format when you play a DVD video disc recorded on the Dolby Digital recording system.

Bitstream: Select "Bitstream" if you connected the Recorder's DIGITAL OUT jack to a Dolby Digital decoder (or an amplifier or other equipment with a Dolby Digital decoder).



DTS

OFF: If you select "OFF", the DTS signal is not output through the DIGITAL OUT jack.

Bitstream: Select "Bitstream" if you connected the Recorder's DIGITAL OUT jack to a DTS decoder (or an amplifier or other equipment with a DTS decoder).



MPEG

PCM: Select when connected to a 2-channel digital stereo amplifier. The Recorder's digital audio outputs sounds in the PCM 2ch format when you play a DVD video disc recorded on the MPEG2 recording system.

Bitstream: Select "Bitstream" if you connected the Recorder's DIGITAL OUT jack to a MPEG decoder (or an amplifier or other equipment with a MPEG decoder).



Sampling Frequency

If your receiver or amplifier is NOT capable of handling 96 kHz signals, select 48 kHz. When this choice is made, this unit will automatically convert any 96 kHz signals to 48 kHz so your system can decode them. If your receiver or amplifier is capable of handling 96 kHz signals, select 96 kHz. When this choice is made, this unit will pass each type of signal through without any further processing.



DRC (Dynamic Range Control)

With the DVD format, you can hear a program's soundtrack in the most accurate and realistic presentation possible, thanks to digital audio technology. However, you may wish to compress the dynamic range of the audio output (the difference between the loudest sounds and the quietest ones). Then, you may listen to a movie at a lower volume without losing clarity of sound. Set DRC to ON for this effect.



Vocal

Set Vocal to ON only when a multi-channel karaoke DVD is playing. The karaoke channels on the disc will mix into normal stereo sound.

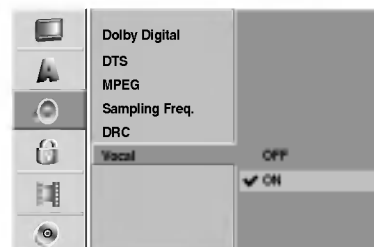

Before Operation (Continued)

LOCK (Parental Control)

Set Password

To access the Movie Rating, Set Password and Country Code features, you must enter a 4-digit security password.

- 1 Press **SETUP**.
The Setup menu appears.
- 2 Use **▲ / ▼** to select the **LOCK** option.
- 3 While the **LOCK** option is selected, press **▶** to move to the second level.
- 4 Use **▲ / ▼** to select the **Set Password** option.
- 5 Press **▶** to move to the third level.
- 6 When you have not entered a password yet; Enter a 4-digit password using the numbered buttons to create a personal 4-digit security password. Enter the 4-digit password again to verify.



When you have already entered a password; You can change or delete the password.

Use **▲ / ▼** to select "Change" or "Delete" then press **ENTER**.

Change : Enter a 4-digit password using the numbered buttons to confirm the personal 4-digit security password, then enter a 4-digit new password twice.

Delete : Enter a 4-digit password using the numbered buttons to confirm the personal 4-digit security password.



If you make a mistake, press **◀** repeatedly to delete password numbers one by one then correct it.

If you forget your 4-digit code

If you forget your password, to clear the current password, follow the procedure below.

1. Press **SETUP** to display the Setup menu.
2. Use the Number buttons to enter the 5-digit number "21019".
3. Select "Yes" then press **ENTER**. The 4-digit password is cleared. Enter a new code as shown above.

Movie Rating

Movies on DVDs may contain scenes not suitable for children. Therefore, discs may contain Parental Control information that applies to the complete disc or to certain scenes on the disc. These scenes are rated from Level 1 to 8, and alternatively, more suitable scenes are available for selection on some discs. Ratings are country-dependent. The Parental Control feature allows you to prevent discs from being played by your children or to have certain discs played with alternative scenes.

- 1 Follow steps 1-3 as shown above to the left (**Set Password**).
- 2 Use **▲ / ▼** to select the **Movie Rating** option.
- 3 Press **▶** to move to the third level.



- 4 Enter a 4-digit password using the numbered buttons to confirm the personal 4-digit security password.
- 5 Select a rating from 1 to 8 using the **▲ / ▼** buttons. **One (1) has the least playback restrictions. Eight (8) has the most playback restrictions.**
No Limit: If you select No Limit, Parental Control is not active. The disc will play in full.
Level 1 to 8: Some discs contain scenes not suitable for children. If you set a rating for the recorder, all disc scenes with the same rating or lower will be played. Higher rated scenes will not be played unless an alternative scene is available on the disc. The alternative must have the same rating or a lower one. If no suitable alternative is found, playback will stop. You must enter the 4-digit password or change the rating level in order to play the disc.
- 6 Press **ENTER** to confirm your rating selection, then press **SETUP** to exit the menu.

Before Operation (Continued)

Country Code

Enter the code of a country/area whose standards were used to rate the DVD video disc, referring to the list (See "Country Code List", page 61.).



- 1** Press **SETUP**.
The Setup menu appears.
- 2** Use **▲ / ▼** to select the **LOCK** option.
- 3** While the **LOCK** option is selected, press **▶** to move to the second level.
- 4** Use **▲ / ▼** to select the **Country Code** option.
- 5** Press **▶** to move to the third level.
- 6** When you have not entered a password yet;
Enter a 4-digit password using the numbered buttons to create a personal 4-digit security password. Enter the 4-digit password again to verify.
When you have already entered a password;
Enter a 4-digit password using the numbered buttons to confirm the personal 4-digit security password.



If you a mistake, press **◀** repeatedly to delete password numbers one by one then correct it.

- 7** Select the first character using the **▲ / ▼** buttons.
- 8** Shift the cursor using **▶** buttons and select the second character using **▲ / ▼** buttons.
- 9** Press **ENTER** to confirm your country code selection, then press **SETUP** to exit the menu.

RECORD

Disc Record Mode

You can set the picture quality for DVD recording; XP (High Quality), SP (Standard Quality), LP (Low Quality), EP (Extend Quality).



- 1** Press **SETUP**.
The Setup menu appears.
- 2** Use **▲ / ▼** to select the **RECORD** option.
- 3** While the **RECORD** option is selected, press **▶** to move to the second level.
- 4** Use **▲ / ▼** to select the **Disc Record Mode** option.
- 5** Press **▶** to move to the third level.
- 6** Use **▲ / ▼** to select a desired Record Mode (XP, SP, LP or EP)
- 7** Press **ENTER** to confirm your selection, then press **SETUP** to exit the menu.

VCR Record Mode

You can set the picture quality for VCR recording; SP (Standard Play), LP (Long Play).



Before Operation (Continued)

VCR Record System

Your video recorder uses dual colour standards, PAL and MESECAM. During recording your video recorder should select the colour system automatically, however if you experience problems you may need to do it manually.

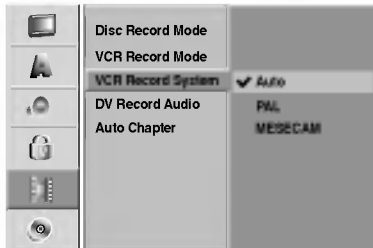

DV Record Audio

You need to set this if you have a camcorder using 32kHz/12-bit sound connected to the front panel DV IN jack.

Some digital camcorders have two stereo tracks for audio. One is recorded at the time of shooting; the other is for overdubbing after shooting.

On the Audio 1 setting, the sound that was recorded while shooting is used.

On the Audio 2 setting, the overdubbed sound is used.

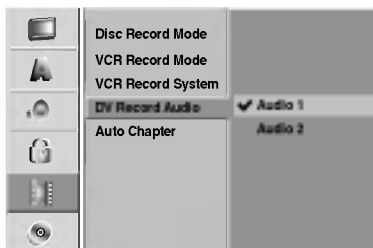

Auto Chapter

When recording, chapter markers are put in specified setting. You can change this interval to 5 minutes, or 10 minutes. If you select None, switch off automatic chapter marking altogether with the No Separation setting.

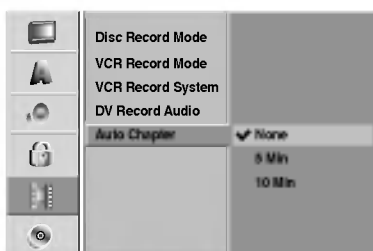

DISC

Disc Initialize

If you load a completely blank disc, the recorder will initialize the disc.

DVD-R: The recorder initialize the disc to Video mode. The recording mode will always be Video mode.

DVD-RW: The recorder initialize the disc to VR mode.

DVD+R: The Initialize menu will appears. Select "Yes" then press ENTER.

DVD+RW: The recorder initialize the disc to DVD+RW mode.

Also, you can format the disc from the Setup menu as below.

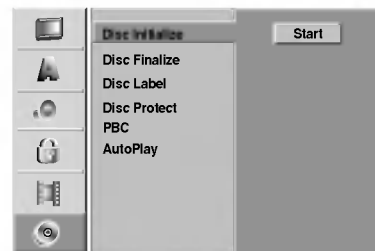

- 1 Press SETUP.**
The Setup menu appears.
- 2 Use ▲ / ▼ to select the DISC option.**
- 3 While the DISC option is selected, press ► to move to the second level.**
- 4 Use ▲ / ▼ to select the Disc Initialize option.**
- 5 Press ► to move to the third level.**
Start icon is highlighted.
- 6 Press ENTER.**
Disc Initialize menu appears.
- 7 In case of DVD-RW, use ◀ / ▶ to select a desired Disc Format Mode (VR Mode or Video Mode) then press ENTER.**
In case of DVD+RW, go to step 8.

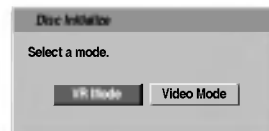

- 8 Use ◀ / ▶ to select "OK" then press ENTER.**
It takes a few moments to format the disc.

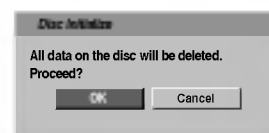

⚠ Caution

If you want to change the disc format, everything recorded on the disc will be erased.

Before Operation (Continued)

Disc Finalize

Finalizing 'fixes' the recordings in place so that the disc can be played on a regular DVD player or computer equipped with a suitable DVD-ROM drive. Finalizing a Video mode disc creates a menu screen for navigating the disc. This is accessed by pressing LIST/DISC MENU or TITLE.

⚠ Caution

- When DVD-R, DVD-RW, and DVD+R recording, you've finalized a disc recording, you can't edit or record anything else on that disc except DVD+RW.



- 1 Follow steps 1-3 as shown on page 27 (Disc Initialize).
- 2 Use ▲ / ▼ to select the Disc Finalize option.
- 3 Press ► to move to the third level. Finalize is highlighted.
- 4 Press ENTER. Finalize menu appears.

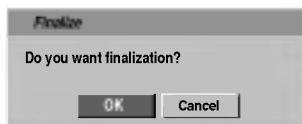

- 5 Select OK then press ENTER. The recorder starts finalizing the disc.

ℹ Note

How long finalization takes depends on the type of disc, how much is recorded on the disc, and the number of titles on the disc. A disc recorded can take up to 8 minutes or more to finalize.

💡 Tip

If you load a DVD-RW or DVD+RW that has already been finalized, you can 'unfinalize' it by choosing Unfinalize from the Disc Finalize menu. After doing this, you can edit and re-record onto the disc.

Disc Label

Use this to enter a name for the disc. This name appears when you load the disc and when you display disc information on-screen.

- The disc name can be up to 32 characters long.
- For discs formatted on a different Recorder, you will see only a limited character set.

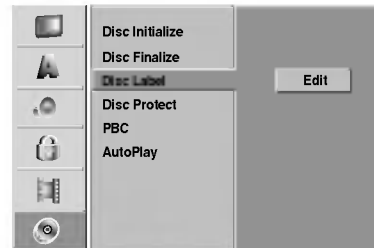

- 1 Follow steps 1-3 as shown Disc Initialize on page 27.
- 2 Use ▲ / ▼ to select the Disc Label option.
- 3 Press ► to move to the third level. Edit icon is highlighted.
- 4 Press ENTER. Keyboard menu appears.

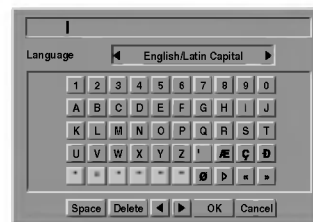

- 5 Enter a name for the disc. Use ▲ ▼ ◀ ▶ to select a character then press ENTER to confirm your selection. Refer step 3 as shown on page 21 (Station Rename).

⏮ Remote control buttons for entering a name

▶ (PLAY): Inserts a space at the cursor position.

⏮ (PAUSE/STEP): Deletes the after character at the cursor position.

■ (STOP), CLEAR: Deletes the previous character at the cursor position.

◀◀ / ▶▶: Moves cursor to left or right.

Numbers (0-9): Enters the character of corresponding location on the selected column.

LIST/DISC MENU, DISPLAY: Switches the keyboard type (English/Latin Capital, English/Latin Lowercase, Symbols)

- 6 Choose OK then press ENTER to fix the name and return to the Setup menu.

- 7 Press SETUP to exit the menu.

Before Operation (Continued)

Disc Protect

When recording in DVD+RW / +R disc or VR mode formatted DVD-RW disc, set to ON to prevent accidental recording, editing or deleting of the disc loaded. If you need to unlock the disc to make edits, select OFF.



PBC

Set Playback Control (PBC) to On or Off.

- ON: Video CDs with PBC are played according to the PBC.
- OFF: Video CDs with PBC are played the same way as Audio CDs.



Auto Play

You can set up the Recorder so a DVD disc automatically starts playing whenever the DVD is inserted. If Auto Play mode is set to On, this Recorder will search for title that has the longest playback time and then play back the title automatically.

ON: Auto Play function is active.

OFF: Auto Play function is not active.

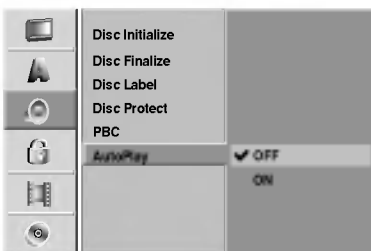

Note

The Auto Play function may not work for some DVDs.

Before Operation (Continued)

General Explanation of On-Screen Display

This manual gives basic instructions for operating the Recorder. Some DVDs require specific operation or allow only limited operation during playback. When this occurs, the symbol \emptyset appears on the TV screen, indicating that the operation is not permitted by the Recorder or is not available on the disc.

Displaying Information on-screen

You can display various information about the disc or tape loaded on-screen.

1 Press **DISPLAY** repeatedly to display/change the information displayed on-screen.

2 To remove the on-screen display, press **DISPLAY** or **RETURN** (↵) repeatedly until it disappears. See the descriptions on next pages for detailed explanation during playing.

Notes

- Some discs may not provide all of the features on the on-screen display example shown on next pages.
- If no button is pressed for 7 seconds, the on-screen display disappears.

Temporary Feedback Field Icons

- ■ ■ Resume play from this point
- \emptyset Action prohibited or not available

Displaying Information While Watching TV

During viewing the TV, press **DISPLAY** to display/remove the information displayed on-screen.

e.g., when DVD-RW in VR mode is inserted.

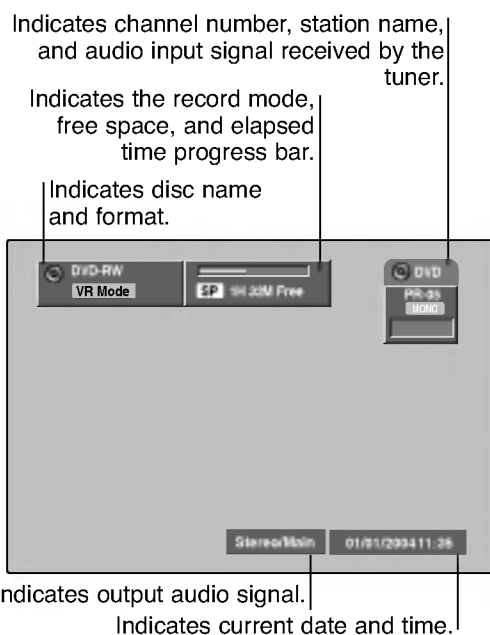

Changing TV Channels

If no disc or tape is playing, you can change TV channels using the number or **PR/TRK** (▲ / ▼) buttons on the remote control, or the **PROG.** (▲ / ▼) buttons on the front panel.

Changing TV Audio Channel

Some TV programs are broadcast with a bilingual audio program (BIL). You can change the TV audio using the **AUDIO** button.

Press **AUDIO** repeatedly to change the TV audio as shown below.

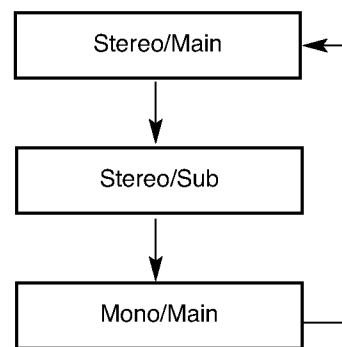

The current audio channel is displayed on-screen.

- For the detailed information, refer to the step 4 on page 42.
- If the sound is poor quality when set to Stereo, you can often improve it by changing to Mono.
- When an external input is selected, the audio channel can be switched only to Stereo.

Before Operation (Continued)

Displaying Information on-screen (Continued)

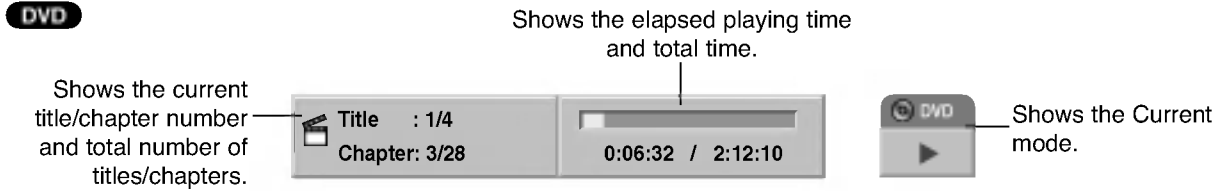

Menu Options	Function (Use ▲ / ▼ to select desired option)	Selection Method
Title Number	Shows the current title number and total number of titles, and skips to the desired title number.	◀ / ▶, or Numbers, ENTER
Chapter Number	Shows the current chapter number and total number of chapters, and skips to the desired chapter number.	◀ / ▶, or Numbers, ENTER
Time search	Shows the elapsed playing time, and searches the point by the elapsed time directly.	◀ / ▶, Numbers, ENTER
Audio language and Digital Audio Output mode	Shows the current audio soundtrack language, encoding method, and channel number, and changes the setting.	◀ / ▶
Subtitle language	Shows the current subtitles language, and changes the setting.	◀ / ▶
Angle	Shows the current angle number and total number of angles, and changes the angle number.	◀ / ▶
Sound	Shows the current sound mode, and changes the setting.	◀ / ▶

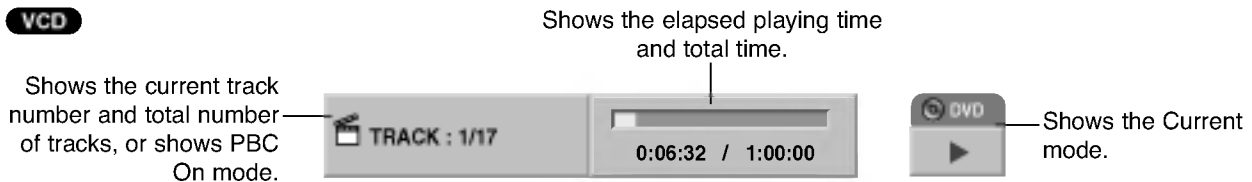

Menu Options	Function (Use ▲ / ▼ to select desired option)	Selection Method
Track Number	Shows the current track number and total number of tracks or PBC On mode, and skip to the desired track number.	◀ / ▶, or Numbers, ENTER
Time	Shows the elapsed playing time (Display only).	-
Audio Channel	Shows the audio channel, and changes the audio channel.	◀ / ▶
Sound	Shows the current sound mode, and changes the setting.	◀ / ▶

Before Operation (Continued)





Displaying Information on-screen (Continued)

VR

Shows the elapsed playing time and total time.

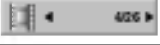
Shows the title name, recording date, recording mode, etc.
ORG: Original
PList: Playlist

Shows the Current mode.





Menu Options	Function (Use ▲ / ▼ to select desired option)	Selection Method
Title Number 	Shows the current title number and total number of titles, and skips to the desired title number.	◀ / ▶, or Numbers, ENTER
Chapter Number 	Shows the current chapter number and total number of chapters, and skips to the desired chapter number.	◀ / ▶, or Numbers, ENTER
Time search 	Shows the elapsed playing time, and searches the point by the elapsed time directly.	◀ / ▶, Numbers, ENTER
Digital Audio Output mode 	Shows the current audio encoding method, and channel number, and changes the setting.	◀ / ▶
Sound 	Shows the current sound mode, and changes the setting.	◀ / ▶

+RW +R Video

Shows the elapsed playing time and total time.

Shows the title name, recording date, recording mode, etc.

Shows the Current mode.

Menu Options	Function (Use ▲ / ▼ to select desired option)	Selection Method
Title Number 	Shows the current title number and total number of titles, and skips to the desired title number.	◀ / ▶, or Numbers, ENTER
Chapter Number 	Shows the current chapter number and total number of chapters, and skips to the desired chapter number.	◀ / ▶, or Numbers, ENTER
Time search 	Shows the elapsed playing time, and searches the point by the elapsed time directly.	◀ / ▶, Numbers, ENTER
Digital Audio Output mode 	Shows the current audio encoding method, and channel number, and changes the setting.	◀ / ▶
Sound 	Shows the current sound mode, and changes the setting.	◀ / ▶

VHS

Shows playing speed, the elapsed playing progress bar and elapsed playing time.

Shows the Current mode

Menu Options	Function (Use ▲ / ▼ to select desired option)	Selection Method
Time 	Shows the elapsed playing time (Display only).	-
Audio Channel 	Shows the audio channel, and changes the audio channel.	◀ / ▶

Operation with DVD and Video CD

Playing a DVD or Video CD

Playback Setup

- Before using the remote control, press the **DVD** button to select the device to be operated.
- Turn the TV on and select the video input source connected to the Recorder.
- Audio system: Turn the audio system on and select the input source connected to the Recorder.

1 Press **OPEN/CLOSE** () to open the disc tray.

2 Load your chosen disc in the tray, with the playback side down.

3 Press **OPEN/CLOSE** () to close the tray. **READING** appears on the display window, and playback starts automatically. If playback does not start, press **▶** (**PLAY**). In some cases, the disc menu might appear instead.

Tip

If a menu screen is displayed

The menu screen may be displayed first after loading a DVD or Video CD which contains a menu.

DVD

Use the **◀▶** **▲▼** buttons to select the title/chapter you want to view, then press **ENTER** to start playback. Press **TITLE** or **LIST/DISC MENU** to return to the menu screen.

VCD

- Use the number buttons to select the track you want to view. Press **RETURN** () to return to the menu screen.
- Menu setting and the exact operating procedures for using the menu may differ depending on the disc. Follow the instructions on the each menu screen. You may also set **PBC** to **OFF** under **Setup menu**. See page 29.

Notes

- If **Parental Control** is set and the disc is not within the **Rating** settings (not authorized), the 4-digit code must be entered and/or the disc must be authorized (see “**Movie Rating**”, on page 25).
- **DVDs** may have a **Region Code**. Your recorder will not play discs that have a region code different from your recorder. The region code for this recorder is 2 (two).

General Features

Note

Unless stated otherwise, all operations described use the remote control. Some features may also be available on the **Setup menu**.

Moving to another TITLE

DVD **Video** **VR** **+RW** **+R**

When a disc has more than one title, you can move to another title as follows:

- Press **DISPLAY** then use **▲ / ▼** to select the title icon. Then, press the appropriate numbered button (0-9) or **◀ / ▶** to select a title number.

Moving to another CHAPTER/TRACK



DVD **Video** **VR** **+RW** **+R** **VCD**

When a title on a disc has more than one chapter/track, you can move to another chapter/track as follows:

- Press **SKIP** (**I◀◀** or **▶▶I**) briefly during playback to select the next chapter/track or to return to the beginning of the current chapter/track.
- Press **SKIP** (**I◀◀**) twice briefly to step back to the previous chapter/track.
- To go directly to any chapter/track during playback, press **DISPLAY** twice. Then, use **▲ / ▼** to select chapter icon (or for a Video CD, select track icon). Then, enter the chapter/track number using the numbered buttons (0-9) or press **◀ / ▶**.

Search

DVD **Video** **VR** **+RW** **+R** **VCD**

- 1 Press **BACKWARD** (**I◀◀**) or **FORWARD** (**▶▶I**) during playback. The recorder will now go into **SEARCH** mode.
- 2 Press **BACKWARD** (**I◀◀**) or **FORWARD** (**▶▶I**) to select the required speed: **◀** (Reverse play), **◀◀**, **◀◀◀**, **◀◀◀◀**, **◀◀◀◀◀**, **◀◀◀◀◀◀** (backward) or **▶▶**, **▶▶▶**, **▶▶▶▶**, **▶▶▶▶▶**, **▶▶▶▶▶▶** (forward). With a Video CD, the Search speed changes: **◀◀**, **◀◀◀**, **◀◀◀◀** (backward) or **▶▶**, **▶▶▶**, **▶▶▶▶** (forward).
- 3 To exit **SEARCH** mode, press **▶** (**PLAY**).

Still Picture and Frame-by-Frame Playback

DVD **Video** **VR** **+RW** **+R** **VCD**

- 1 Press **PAUSE/STEP** (**||**) during playback. The recorder will now go into **PAUSE** mode.
- 2 You can advance or back up the picture frame-by-frame by pressing **◀ / ▶** repeatedly during **PAUSE** mode.
- 3 To exit **PAUSE** mode, press **▶** (**PLAY**).

Note

The picture frame-by-frame in reverse is not available for Video CD.

Tip

You can advance the picture frame-by-frame by pressing **PAUSE/STEP** (**||**) repeatedly on the remote control.

Operation with DVD and Video CD (Continued)

General Features (Continued)

Slow Motion



- 1 Press PAUSE/STEP (II) during playback.
The recorder will now go into PAUSE mode.
- 2 Press BACKWARD (◀◀) or FORWARD(▶▶) during PAUSE mode.
The Recorder will enter SLOW mode.
- 3 Use the BACKWARD (◀◀) or FORWARD(▶▶) to select the required speed: ◀◀ 1/16, ◀◀ 1/8, ◀◀ 1/4, or ◀◀ 1/2 (backward), or ▶▶ 1/16, ▶▶ 1/8, ▶▶ 1/4, or ▶▶ 1/2 (forward).
With a Video CD, the Slow speed changes: ▶▶ 1/8, ▶▶ 1/4 or ▶▶ 1/2 (forward).
- 4 To exit Slow Motion mode, press ▶ (PLAY).

Note

Slow motion playback in reverse is not possible with Video CDs.

Random

- 1 Press RANDOM during playback.
The unit automatically begins Random Playback and "RANDOM" appears on the TV screen.
- 2 To return to normal playback, press RANDOM until "NORMAL" appears on the TV screen.

Tip

By pressing SKIP ▶▶ during Random playback, the unit selects another title (track) and resumes Random playback.

Note

- This function only works with DVD Karaoke discs or video CDs without PBC.
- On a Video CD with PBC, you must set PBC to OFF in the Setup menu to use the Random function. See page 29.

Repeat



DVD Discs - Repeat Chapter/Title/All/Off

Press REPEAT to select a desired repeat mode.

- Chapter: repeats the current chapter.
- Title: repeats the current title .
- All: repeats the all titles on the disc.
(VR mode DVD-RW disc only)
- OFF: does not play repeatedly.

Video CDs - Repeat Track/All/Off

Press REPEAT to select a desired repeat mode.

- Track: repeats the current track.
- All: repeats the all tracks on the disc.
- OFF: does not play repeatedly.

Note

On a Video CD with PBC, you must set PBC to OFF in the Setup menu to use the Repeat function. See page 29.

Repeat A-B



To repeat a sequence in a title:

- 1 Press A-B at your chosen starting point.
Repeat icon and REPEAT A- appears on the TV screen.
- 2 Press A-B again at your chosen end point.
Repeat icon and REPEAT A-B appears on the TV screen, and the repeat sequence begins.
- 3 To cancel the sequence, press A-B repeatedly to select REPEAT OFF.

Time Search



The Time Search function allows you to start playing at any chosen time on the disc.

- 1 Press DISPLAY twice during playback. The on-screen display appears on the TV screen.
The Time Search box shows the elapsed playing time of the current disc.
- 2 Within 7 seconds, use ▲ / ▼ to select the Time Search icon in the on-screen display.
The ":-:--:" appears in the Time Search box.
- 3 Within 7 seconds, use the number buttons to enter the required start time. Enter hours, minutes, and seconds from left to right in the box.
You can not enter an invalid time.
If you enter the wrong numbers, press ◀ / ▶ to move the under bar () to the wrong number. Then enter the correct numbers.
- 4 Within 7 seconds, press ENTER to confirm the start time.
Playback starts from the selected time on the disc.

Operation with DVD and Video CD (Continued)

General Features (continued)

Zoom



The Zoom function allows you to enlarge the video image and to move through the enlarged image.

- 1 Press ZOOM during playback or still playback to activate the Zoom function.
Each press of the ZOOM button changes the TV screen in the sequence shown below.
x1 size → x2 size → x4 size → x1 size (normal size)
- 2 Use the ◀▶▲▼ buttons to move through the zoomed picture.
- 3 To resume normal playback, press CLEAR or press ZOOM repeatedly until the normal picture appears.



The zoom function may not work for some DVDs.

Marker Search



You can start playback from a memorized point. Up to six points can be memorized.

To enter a mark, follow these steps.

- 1 During disc playback, press MARKER when playback reaches the spot that you want to memorize.
The Marker icon will appear on the TV screen briefly.
- 2 Repeat step 1 to enter up to six Marker points on a disc.

To Recall a Marked Scene

- 1 Press SEARCH.
The Marker Search menu will appear on the TV screen.
- 2 Use the ◀▶▲▼ buttons to select a Marked scene that you want to recall.
- 3 Press ENTER.
Playback will start from the Marked scene.
- 4 To remove the Marker Search menu, press RETURN (↵).

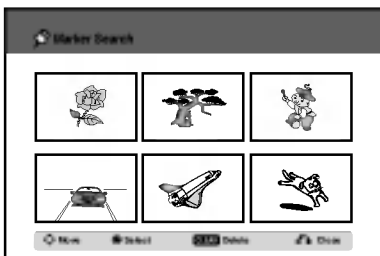

To clear a Marked Scene

- 1 Press SEARCH during playback or in stop mode.
The Marker Search menu will appear on the TV screen.
- 2 Use ◀▶▲▼ to select the Marked scene that you want to erase.

- 3 Press CLEAR.
“Delete selected marker. Continue?” message appears.
- 4 Use ◀ / ▶ to select “Yes” then press ENTER.
- 5 Repeat steps 2-4 to erase additional Marked scene.
- 6 To remove the Marker Search menu, press RETURN (↵).

Checking the Contents of DVD Video Discs: Menus

DVDs may contain menus that allow you to access special features. To open the disc menu, press LIST/DISC MENU. Then, press the appropriate number button to select an option. Or, use the ◀▶▲▼ buttons to highlight your selection, then press ENTER.

Title Menu

- 1 Press TITLE.
If the current title has a menu, the menu will appear on the TV screen. Otherwise, the disc menu may appear.
- 2 The menu may contain camera angles, spoken language and subtitle options, and chapters for the title.

Disc Menu

- 1 Press LIST/DISC MENU.
The disc menu is displayed.
- 2 To remove the disc menu, press LIST/DISC MENU again.

Camera Angle

If the disc contains scenes recorded at different camera angles, you can change to a different camera angle during playback.

- Press ANGLE then press ◀ / ▶ repeatedly during playback to select a desired angle.
The number of the current angle appears on the TV screen.



The ANGLE indicator will blink on the TV screen at scenes recorded at different angles to indicate that angle switching is possible.

Changing the Audio Soundtrack



Press AUDIO then press ◀ / ▶ repeatedly during playback to hear a different audio language or audio soundtrack if available.



Some discs feature both Dolby Digital and DTS soundtracks. There is no analog audio output when DTS is selected. To listen to the DTS soundtrack, connect this recorder to a DTS decoder via one of the digital outputs. See page 17 for connection details.

Operation with DVD and Video CD (Continued)

Changing the Audio Channel

VCD **Video** **VR** **+RW** **+R**

With a Video CD, press AUDIO then press ◀ / ▶ repeatedly during playback to hear a different audio channel (STEREO, LEFT or RIGHT).

With DVD-RW discs recorded in VR mode that have both a main and a Bilingual audio channel, you can switch between Main (L), Bilingual (R), or a mix of both (Main + Bilingual) by pressing AUDIO.

3D Surround

DVD **Video** **VR** **+RW** **+R** **VCD**

This unit can produce a 3D Surround effect, which simulates multi-channel audio playback from two conventional stereo speakers, instead of the five or more speakers normally required to listen to multi-channel audio from a home theater system.

- 1 Press DISPLAY twice then use ▲ / ▼ to select the sound icon. Then, use ◀ / ▶ to select "3D SUR."
- 2 To turn off the 3D Surround effect, select "NORMAL".

Subtitles **DVD**

Press SUBTITLE then press ◀ / ▶ repeatedly during playback to see the different subtitle languages.

Finding Locations on a Disc **VCD**

You can directly access any point on a video CD using this function. Use this function only while a video CD is playing. Playback jumps to the point specified.

- 1 Press SEARCH during playback.
The progress bar appears on the TV screen.



- 2 Use ◀ / ▶ to find a start position for playback.
- 3 Press ENTER to confirm the selected position.
Playback starts from the selected position.

note

This function works only when no marker is memorized.

Last Condition Memory **DVD**

This recorder memorizes the user settings for the last disc that you have viewed. Settings remain in memory even if you remove the disc from the recorder or switch off the recorder. If you load a disc that had its settings memorized, the latest stop position is automatically recalled.

notes

- Settings are stored in memory for use any time.
- This recorder does not memorize settings of a disc if you switch off the recorder before commencing to play it.

Audio CD and MP3/WMA Operation

Playing an Audio CD or MP3/WMA

Disc **CD** **MP3** **WMA**

The Recorder can play audio CDs. Also, the Recorder can play MP3/WMA formatted recordings on CD-ROM, CD-R, CD-RW, DVD±R or DVD±RW disc. Before playing MP3/WMA recordings, read the notes on MP3/WMA Recordings on page 38.

- 1 **Insert a disc and close the tray.**
AUDIO CD or MP3/WMA CD menu appears on the TV screen.



AUDIO CD Menu

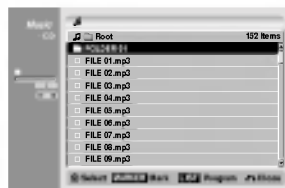

MP3/WMA CD Menu

- 2 Use **▲ / ▼** to select a track then press **▶ (PLAY)**.

Playback starts.

During playback, the current track's elapsed playing time will appear on the display window and menu.

Playback will stop at the end of the disc.

Tips

- You can view TV channel or video input source by pressing RETURN. If you want to return to the Music menu, press LIST/DISC MENU.
- You can switch between the Track List and Program List menus by pressing LIST/DISC MENU.
- On CDs with mixed content (audio tracks, MP3/WMA files and JPEG files), you can select among the Music-Audio CD menu, Music-MP3/WMA CD menu, and Photo CD menu by pressing TITLE repeatedly in Stop mode.
- If you select a MP3/WMA and press DISPLAY, the file informations are displayed. Press DISPLAY again to remove the file informations. If you select a folder and press DISPLAY, the number of subfolders and number of MP3/WMA files in the folder are displayed.
- If you are in a file list and want to return to the Folder list, use the **▲/▼** to highlight **[-]** and press ENTER to return to the previous menu screen.

- 3 To stop playback at any other time, press **STOP (■)**.

Music menu options

1. To display menu options, select a track (or folder) on the menu then press ENTER.
2. Use **▲ / ▼** to select an option then press ENTER to confirm your selection.

Music-Audio CD menu options **CD**

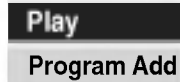

Play: Starts playback the selected track.

Program Add: Adds the track(s) to Program List. (page 39)

Music-CD menu options **MP3** **WMA**

- When you select a track.

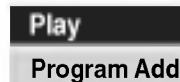

Play: Starts playback the selected track.

Program Add: Adds the track(s) to Program List. (page 39)

- When you select a folder.

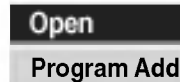

Open: Displays sub-folders and MP3/WMA files only in the folder.

Program Add: Adds all track(s) in the folder to Program List. (page 39)

Audio CD and MP3/WMA Operation (Continued)

Pause

- 1 Press PAUSE/STEP (||) during playback.
- 2 To return to playback, press ► (PLAY) or press PAUSE/STEP (||) again.

Moving to Another Track

- Press SKIP ◀◀ or ▶▶ briefly during playback to go to the next track or to return to the beginning of the current track.
- Press SKIP ◀◀ twice briefly to step back to the previous track.
- On an Audio CD, to go directly to any track, enter the track number using the numbered buttons (0-9) during playback on the Track List.

Repeat Track/All(Folder)/Off

Press REPEAT to select a desired repeat mode.

- TRACK: repeats the current track.
- ALL (CD): repeats the all tracks on the disc.
- FOLDER (MP3/WMA): repeats the all tracks in the current folder.
- OFF (No display): does not play repeatedly.

Random

- 1 Press RANDOM during playback or in stop mode. The unit automatically begins Random Playback and "RANDOM" appears on the menu screen.
- 2 To return to normal playback, press RANDOM repeatedly until "RANDOM" disappears from the menu screen.



By pressing SKIP ▶▶ during Random playback, the unit selects another track and resumes Random playback.

Changing the Audio Channel

Press AUDIO repeatedly to hear a different audio channel (stereo, left or right).

Search

- 1 Press BACKWARD (◀◀) or FORWARD(▶▶) during playback.
The recorder will now go into SEARCH mode.
- 2 Press BACKWARD (◀◀) or FORWARD(▶▶) to select the required speed: ◀◀, ◀◀◀, ◀◀◀◀ (backward) or ▶▶, ▶▶▶, ▶▶▶▶ (forward).
Search speed and direction are indicated on the menu screen.
- 3 To exit SEARCH mode, press ► (PLAY).

Repeat A-B

To repeat a sequence in a track:

- 1 Press A-B at your chosen start point.
Repeat icon and 'A-' appears on the menu screen.
- 2 Press A-B again at your chosen end point.
The Repeat icon and 'A - B' appears on the menu screen, and the repeat sequence begins.
- 3 To exit the sequence and return to normal play, press A-B again.
The Repeat icon disappears from the menu screen.

Notes on MP3/WMA Recordings

About MP3

- An MP3 file is audio data compressed by using the MPEG1 audio layer-3 file-coding scheme. We call files that have the ".mp3" file extension "MP3 files".
- The recorder can not read an MP3 file that has a file extension other than ".mp3".

About WMA(Window Media Audio)

- An WMA file is a Microsoft audio compression technology.
- WMA(Windows Media Audio) offers double the audio.compression of the MP3 format.

MP3/WMA Disc compatibility with this recorder is limited as follows:

1. CD-R physical format should be "ISO 9660" and "JOLIET".
2. If you record MP3/WMA files using the software which cannot create a FILE SYSTEM, for example "Direct-CD" etc., it is impossible to playback MP3/WMA files. We recommend that you use "Easy-CD Creator", which creates an ISO9660 or JOLIET file system.
3. Total number of files and folders on the disc should be less than 999.

This Recorder requires discs/recordings to meet certain technical standards in order to achieve optimal playback quality. Pre-recorded DVDs are automatically set to these standards. There are many different types of recordable disc formats (including CD-R containing MP3 or WMA files) that require certain pre-existing conditions (see above) to insure compatible playback.

Customers should also note that permission is required in order to download MP3/WMA files and music from the Internet. Our company has no right to grant such permission. Permission should always be sought from the copyright owner.

Programmed Playback with Audio CD and MP3/WMA

The Program function enables you to store your favorite tracks from any disc in the recorder memory. Program can contain 99 tracks (Audio CD) or 256 tracks (MP3/WMA).

- 1 Insert an Audio CD or MP3/WMA disc.**
Audio CD or MP3/WMA CD menu will appear.
- 2 Use ▲ ▼ to select a track or folder on the List then press ENTER.**
The options appears on the left side of the menu.
- 3 Use ▲ ▼ to highlight the "Program Add" icon then press ENTER.**
The selected track is added to the Program List.
- 4 Repeat steps 2-3 to place additional tracks on the Program list.**

Tip

You can add multi tracks on the List to the Program List.

- Select a track then press MARKER.
- Repeat step 1 to mark additional tracks.
- Select any track then press ENTER.
The options appears on the left side of the menu.
- Use ▲ / ▼ to highlight the "Program Add" icon then press ENTER.
The all marked tracks are added to the Program List.

Notes

- Use the CLEAR button to select all tracks, or cancel all marked tracks.
- If you select folder for Programmed Playback, all tracks in the folder are added to the program list.

5 AUDIO CD : Use ► to move to the Program list.

6 Use ▲ / ▼ to select the track you want to start playing.

7 Press PLAY (▶) to start.

Playback begins in the order in which you programmed the tracks and "PRG" indicator appears on the display window.
Playback stops after playing the last programmed track on the program list.

8 To resume normal playback from programmed playback, select a track on the List then press PLAY (▶).

"PRG" indicator disappears from the display window.

Program List menu options

- To display menu options, select a tack on the Program List menu then press ENTER.
The menu options appear on the left side of the menu.
- Use ▲ / ▼ to select an option then press ENTER to confirm your selection.



Play: Playback begins in the order in which you programmed the tracks from the selected track.

Move: Moves the track(s) to change the program order.

Delete: Deletes the track(s) from the Program List menu.

Repeat Programmed Tracks

Press REPEAT repeatedly during playback to select a desired repeat mode.

- TRACK: repeats the current track.
- ALL : repeats the all tracks on the Program list.
- OFF (No display): does not play repeatedly.

Erasing a Track from the Program List

- Select the track you wish to erase from the Program List.

Tip

Use the MARKER button to select multiple tracks.

- Press ENTER.
The menu options appear on the left side of the menu.
- Select 'Delete' option then press ENTER.
The selected track is deleted from the Program List.

Changing Track Order in the Program List

- Select the track you wish to move.

Tip

Use the MARKER button to select multiple tracks.

- Press ENTER.
The menu options appear on the left side of the menu.
- Select 'Move' option then press ENTER.
A yellow bar appears in the Program List.
- Use ▲ / ▼ to move the yellow bar to the desired location, then press ENTER.
The selected track is moved.

JPEG File Operation

Viewing a JPEG File **JPEG**

The recorder can play discs with JPEG files. Before playing JPEG recordings, read "Notes on JPEG Recordings" at right.

- 1 Insert a disc and close the tray.**
The Photo menu appears on the TV screen.

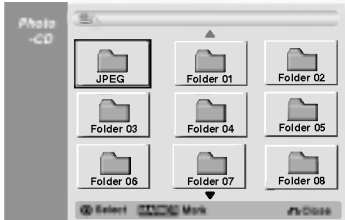

- 2 Use ▲▼◀▶ to select a folder, then press ENTER.**
Open icon is highlighted on the left side of the menu.
- 3 Press ENTER.**
A list of files in the folder appears.



Note

If the  icon displays in the Photo menu, it means you cannot see those JPEG files.

- 4 Use ▲▼◀▶ to select a file, then press ENTER.**
The options appear on the left side of the menu.

Tip

- If you are in a file list and want to return to the Folder list, use the ▲ / ▼ buttons on the remote to highlight the  icon and press ENTER.
- You can view TV channel or video input source by pressing RETURN. If you want to return to the Photo menu, press LIST/DISC MENU.
- On CDs with mixed content (audio tracks, MP3/WMA files and JPEG files), you can select among the AUDIO CD menu, MP3/WMA CD menu, and Photo CD menu by pressing TITLE repeatedly in Stop mode.

- 5 Use ▲ / ▼ to select "Full Screen" option then press ENTER.**

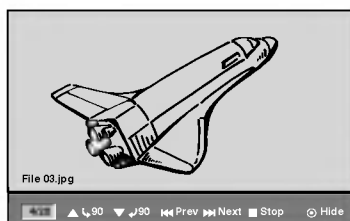

- 6 To stop viewing at any time, press STOP.**
The Photo menu reappears.

Skip Images

While viewing a picture, press SKIP (◀◀ or ▶▶) once to advance to the next file or return to the previous file.

Rotate Images

Use ▲ / ▼ while viewing a picture to flip the picture clockwise or counterclockwise.

View Slide Shows

1. Select "Slide Show" option on the Photo menu.
2. Press ENTER.
The Slide Show menu appears.

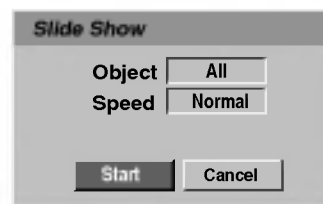

3. Use ▲▼◀▶ to set the options.
Object: Selected file or All files.
Speed: Sets the speed for Slide Show (Slow, Normal, or Fast)
4. Select the Start option then press ENTER to start the Slide Show.
5. Press STOP to stop the Slide Show and returns to the Photo menu.

Note

Use the MARKER button to select multiple files.

Notes on JPEG Recordings

- Depending on the size and number of JPEG files, it may take several minutes for the recorder to read the disc's content. If you don't see an on-screen display after several minutes, some of the files are too big — reduce the resolution of the JPEG files to less than 4 mega pixels and burn another disc.
- The total number of files and folders are free but the total number of files on the folder should be less than 999.
- Some discs may be incompatible due to different recording formats or the condition of the discs.
- When you are using software such as "Easy CD Creator" to burn JPEG files on a CD-R, ensure that all selected files have the ".jpg" or ".jpeg" extension before copying them into the CD layout.
- If the files have ".jpe" extensions, please rename them as ".jpg" or ".jpeg" files.
- File names without the ".jpg" or ".jpeg" extension cannot be read by this recorder, even though the files are shown as JPEG image files in Windows Explorer®.

VCR Mode Tape Playback

Preparation

- Before using the remote control, press the **VCR** button to select the device to be operated.
- Turn the TV on and select the video input source connected to the Recorder.
- Audio system: Turn the audio system on and select the input source connected to the Recorder.

Normal Playback **VHS**

1 Insert a prerecorded video cassette.

The  indicator will light and the Recorder will power-up automatically.

- Make sure that the **TIMER** indicator in the display window is not lighted. If it is, press **POWER** once.
- If a tape without a safety tab is inserted, the Recorder will start playback automatically.

2 Press **PLAY** (▶) once.

PLAY icon appears on the TV screen.

- It is not necessary to select the tape speed for playback. It will be automatically selected by the Recorder.

3 Press **STOP** (■) to stop playback.

STOP icon appears on the TV screen.

If the tape reaches the end before **STOP** (■) is pressed, the Recorder will automatically stop, rewind and eject the tape, and turn itself off.

Tracking Control **VHS**

Auto Tracking

The automatic tracking function adjusts the picture to remove snow or streaks.

The **AUTO TRACKING** function works in the following cases:

- A tape is played back for the first time.
- Tape speed (SP, LP) changes.
- Streaks or snow appear because of scratches on the tape.

Manual Tracking

If noise appears on the screen during playback, press either **PR/TRK** (▲/▼) on the remote control or **PROG.** (▲/▼) on the front panel until the noise on the screen is reduced.

- In case of vertical jitter, adjust these controls very carefully.
- Tracking is automatically reset to normal when the tape is ejected or the power cord is unplugged for more than 3 seconds.

Special Effect Playback **VHS**

Special effects playback notes

- Horizontal lines (noise bars) will appear on the TV screen. This is normal.
- The audio is automatically muted during special effect modes, so there is no sound during search.
- During the high-speed picture search modes, a short time is needed to stabilize tape speed when re-entering the **PLAY** mode. Slight interference may be observed during this time.

Search

This function lets you visually search forward and backward for a desired scene on your tape.

1 Press **BACKWARD** (◀◀) or **FORWARD** (▶▶) during playback.

The Recorder will be activated in the **SEARCH** mode.

- If the Recorder is left in the **SEARCH** mode for more than 3 minutes, the Recorder will automatically enter the **PLAY** mode, to protect the tape and video heads.

2 To return to playback, press **PLAY** (▶).

Still Picture and Frame-by-Frame Playback

1 Press **PAUSE/STEP** (||) during playback.

A still picture appears on the TV screen.

- If a still picture vibrates vertically, stabilize it by using **PR/TRK** (▲/▼) on the remote control.
- If the Recorder is left in the **STILL** mode for more than 5 minutes, the Recorder will automatically enter the **STOP** mode to protect the tape and video heads.

2 Press **PAUSE/STEP** (||) repeatedly to advance the video picture one frame at a time while viewing a still picture.

3 To return to playback, press **PLAY** (▶).

Slow Motion

1 While in still mode, press **FORWARD** (▶▶).

The tape will be played back at a speed 1/19 times slower than the normal speed.

- During slow playback, use **PR/TRK** (▲/▼) on the Remote Control to minimize noise bands.
- If slow motion mode continues for more than 3 minutes, the Recorder will automatically change to normal play mode.

2 To return to playback, press **PLAY** (▶).

Counter Memory Function

This is useful if there is a section of tape you want to view immediately after recording or if you want to return to the same point several times.

1 Begin recording or playing a tape.

2 Press **DISPLAY** repeatedly to display the real-time counter on the TV screen.

3 At the point you want to locate later, reset the real-time counter to 0:00:00 by pressing **CLEAR**.

Continue to play or record.

4 Press **STOP** when recording or playback finishes.

5 Press **RETURN** (↶).

The tape automatically stops when the tape counter returns to about "0:00:00".

Basic Recording

Basic Recording from a TV

Follow the instructions below to record a TV program. Recording starts immediately and continues until the disc or tape is full or you stop the recording.

1 Switch on the Recorder, select the device (VCR or DVD) for Recording and load a recordable disc or tape.

Also make sure that the TV input is set to this recorder. If you load a completely blank DVD-RW disc, Disc initialize menu will appear, to select a desired Recording Mode to initialize the disc (See page 27).

2 Set a recording mode as necessary by pressing REC MODE repeatedly.

DVD: SP (Standard quality), LP (Low quality), XP (High quality), EP (Extended quality)
VCR: SP (Standard Play), LP (Long Play)

3 Use PROG. (▲/▼) on the front panel or PR/TRK(▲/▼) on the remote control to select the TV channel to record.

4 Use AUDIO to select the audio channel to record.

The table below shows what will be recorded on the different settings for different types of broadcast. The last column (Monitor Audio) shows what you'll hear as it is recording.

TV Broadcast Audio	Selected Audio	Broadcast Audio				Monitor Audio
		VR mode or Tape		Video, +R or +RW mode		
		L Ch	R Ch	L Ch	R Ch	
STEREO	STEREO/MAIN	STEREO		STEREO		STEREO
	STEREO/SUB	STEREO		STEREO		STEREO
	MONO/MAIN	MONO		MONO		MONO
MAIN+SUB	STEREO/MAIN	MAIN	SUB	MAIN	MAIN	MAIN
	STEREO/SUB	MAIN	SUB	SUB	SUB	SUB
	MONO/MAIN	MAIN	SUB	MAIN	MAIN	MAIN
MONO	STEREO/MAIN	MONO		MONO		MONO
	STEREO/SUB	MONO		MONO		MONO
	MONO/MAIN	MONO		MONO		MONO

5 Press REC (●) once.

Recording will start. (The REC indicator lights in the display window.)

- Recording continues until you press STOP (■) or the disc (or tape) is full.
- To record for a fixed length of time, see Instant Timer Recording on right.

6 Press STOP (■) to stop recording.

Instant Timer Recording

Instant Timer Recording allows you to make a recording easily of a preset length without using the program timer.

1 Follow steps 1-5 as shown left (Basic Recording from a TV).

2 Press REC (●) repeatedly to select the recording time length.

Recording starts after the first press.

DVD: Each subsequent press increases the recording time by 10 minutes within free space.

VCR: Each subsequent press increases the recording time by 30 minutes. Please confirm the VHS tape has enough remaining time to be recorded before recording.



Instant Timer Record Menu

Checking the Recording Time

Press REC (●) or DISPLAY once to check the recording time. The recalled setting will automatically return to the TV screen for a moment.

Also, remaining time of recording is shown in the display window.

To Extend the Recording Time

The recording time can be extended anytime by pressing REC (●).

Each subsequent press increases the recording time by 10 minutes (DVD) within free space or 30 minutes (VCR).

To Pause the Recording

1 Press PAUSE/STEP (||) to pause the disc or tape during recording.

2 When you want to continue recording, press PAUSE/STEP (||) or REC (●).

Notes

- If you press PAUSE/STEP (||) during the Instant Timer Recording, it will be canceled.
- The Recorder will automatically power off when the Instant Timer Recording ends.

To record one TV program while watching another

1 Press TV/VCR to select the TV mode during recording. The TV indicator appears.

2 Using the TV remote controller, select the channel to be viewed.

Tips (VCR mode only)

Always use PAUSE/STEP (||) for best results when making changes during recording.

For example: To change channels during recording, first press PAUSE/STEP (||) to put the unit in pause mode. Then select the desired channel on the Recorder, and press PAUSE/STEP (||) again to resume recording.

Basic Recording (Continued)

Copying from DVD to VCR

You can copy the contents of a DVD to a VHS tape using the DUBBING (or DUB) button.

Note

If the DVD (or Discs) you are attempting to copy is copy protected, you will not be able to copy the disc. It is not permitted to copy Macrovision encoded DVDs (or Discs).

1 Insert a VHS Tape

Insert a blank VHS video tape into the VCR deck.

2 Insert a Disc

Insert the disc you wish to copy in the DVD deck and close the disc tray.

3 Select DVD mode by pressing DVD on the remote control or pressing DVD/VCR on the front panel.

4 Find the place on the DVD (or Disc) from which you want to start recording using the PLAY and PAUSE functions.

For best results, pause playback at the point from which you want to record.

5 Press the DUBBING button on the remote control or press DUB button on the front panel.

The Dubbing menu appears.

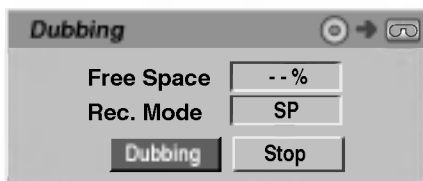

6 Use ▲ / ▼ / ◀ / ▶ to select the desired Record Mode:

- SP (Standard Play)
- LP (Long Play, 2 times SP).

7 Select Dubbing then press ENTER or DUBBING (or DUB) to start copying.

Tip

If you press PAUSE/STEP during Copy mode, both the DVD and VCR decks go into Pause mode and the "DUB" indicator blinks on the front panel display. While in Pause mode, you can adjust the DVD playback position using PLAY, BACKWARD, FORWARD, PAUSE/STEP, etc. The VCR deck will remain in Pause mode. To resume copying, press the DUBBING (or DUB) button twice.

8 Stop the Copy Process

To stop copying at any other time, press STOP (■). You must stop the Copy process manually when the DVD movie ends, or the unit may replay and record over and over again.

Copying from VCR to DVD

You can copy the contents of a VHS tape to a recordable DVD disc using the DUBBING (or DUB) button. This allows you to archive your old VHS tapes to DVD.

Note

If the VHS video tape you are attempting to copy is copy protected, you will not be able to copy the tape. It is not permitted to copy Macrovision encoded tapes.

1 Insert a recordable DVD disc.

Insert a blank recordable DVD disc in the DVD deck and close the disc tray.

2 Insert a VHS Tape

Insert the VHS video tape you wish to copy into the VCR deck.

Note

When using a DVD±RW disc, you must initialize before copying; see page 27.

3 Select VCR mode by pressing VCR on the remote control or pressing DVD/VCR on the front panel.

4 Find the place on the VHS tape from which you want to start recording using the PLAY, BACKWARD, FORWARD and PAUSE functions.

For best results, pause playback at the point from which you want to record.

5 Press the DUBBING button on the remote control or press DUB button on the front panel.

The Dubbing menu appears.



6 Use ▲ / ▼ / ◀ / ▶ to select the desired Record Mode:

- EP (Extended Quality)
- LP (Low Quality)
- SP (Standard Quality)
- XP (High Quality)

7 Select Dubbing then press ENTER or DUBBING (or DUB) to start copying.

Tip

If you press PAUSE/STEP during Copy mode, both the DVD and VCR decks go into Pause mode and the "DUB" indicator blinks on the front panel display. While in Pause mode, you can adjust the VCR playback position using PLAY, BACKWARD, FORWARD, PAUSE/STEP, etc. The DVD deck will remain in Pause mode. To resume copying, press the DUBBING (or DUB) button twice.

8 Stop the Copy Process

To stop copying at any other time, press STOP (■). Copying will stop automatically when the VHS tape ends.

Timer Recording

This Recorder can be programmed to record up to 8 programs within a period of 1 month.

- 1 Press **TIMER REC.**
The Timer Record menu will appear.



- **Media** – Choose a media (DVD or VCR).
- **PR** – Choose a memorized program number, or one of the external inputs from which to record.
- **Date** – Choose a date up to 1 month in advance, or select a daily or weekly program.
- **Start Time** – Set the recording start time.
- **End Time** – Set the recording end time.
- **Mode** – Choose a record mode.
DVD: SP, LP, EP, XP, or AT (Auto)
VCR: SP, LP, AT (Auto)
AT (Auto) mode determines how much time is available on the disc or tape and switches record mode, if necessary, to complete recording the program.
- **VPS/PDC** – The VPS/PDC system automatically adjusts the recording time so that even if a program is not running to schedule, you won't miss it. For VPS/PDC to work properly, you must input the correct announced time and date of the program you want to record.
Note that VPS/PDC may not work with every station.

Notes

- Stations that use VPS/PDC typically include VPS/PDC information in the teletext TV guide pages. Please refer to these pages when setting a timer recording.
- This recorder takes approximately 20 seconds to switch on and start recording. This means that when using VPS/PDC, there may be instances where the beginning of the program is not recorded.

- 2 Enter the necessary information for your timer recording(s).

- ◀ / ▶ (left/right) – move the cursor left/right
- ▲ / ▼ (up/down) – change the setting at the current cursor position
- Press RETURN (↵) to exit the Timer Record menu.
- Press **TIMER REC** to display Timer Record List.

- 3 Press **ENTER** to save the program.
The Timer Record List will appear.

- 4 Press **RETURN** (↵) to exit the Timer Record List.

- 5 Make sure that you load a recordable disc or tape and press **POWER** to switch your unit to Standby.

Notes

- The Timer indicator lights on the front panel display.
- If the Disc and Tape indicator are blinking, either no disc or tape is loaded, or the loaded disc is not recordable.
- The Recorder will record the audio according to the current TV tuner setting (Stereo, Mono or Bilingual). Use the **AUDIO** button to set the audio before switching the Recorder to Standby mode.
- You must press **POWER** to stop the Timer Recording.
- The Recorder will automatically power off when the Timer Recording ends.
- There is a short delay when a timer recording finishes to confirm the recorded program. If two timer recordings are set to record sequentially (one right after the other), the very beginning of the later program may not be recorded.
- The Recommendable DVD discs :

DVD-R	DVD+R	DVD-RW	DVD+RW
SONY	SONY	SONY	SONY
TDK	TDK	TDK	TDK
Imation	Imation	Imation	Imation
Verbatim	MAXELL	Verbatim	Verbatim
RiDATA	RiDATA	Memorex	RiDATA
Panasonic	Fujifilm	Fujifilm	Fujifilm
LG	Ricoh	LG	Ricoh
Mitsubishi	HP	Mitsubishi	HP
That's	That's	Samsung	Ritek
Pioneer	Philips	Pioneer	Radus

Timer Recording (Continued)

Checking Timer Recording Details

Programming can be checked whenever the Recorder is turned on. Press TIMER REC twice.

- Use ▲ / ▼ to select a timer recording.
- Press ENTER to edit the selected program. Timer Record menu appears.
- Press CLEAR to delete the selected program from the Timer Record List.



Canceling a Timer Recording

You can clear a timer setting anytime before the recording actually starts.

- Use ▲ / ▼ to select a program you want to erase on the Timer Recorder List. If you want to erase the program, press CLEAR.

Stopping a Timer Recording in Progress

After a timer recording has started, you can still cancel the program.

- Press POWER.

Timer Recording Troubleshooting

Even though the timer is set, the recorder will not record when:

- There is no disc (or tape) loaded.
- A non-recordable disc (or tape) is loaded.
- Disc Protect is set to ON in the Setup menu (see page 29).
- Power is turned on.
- There are already 99 titles (DVD-RW, DVD-R) or 49 titles (DVD+RW, DVD+R) recorded on the disc.

You cannot enter a timer program when:

- A recording is already underway.
- The time you're trying to set has already passed.
- There are already 8 timer programs set.

If two or more timer programs overlap:

- The earlier program takes priority.
- When the earlier program finishes, the later program starts.
- If two programs are set to start at exactly the same time, the program entered first takes priority.

If the disc is damaged, the recording may not complete successfully. In this case even though the Check field shows "Rec. OK", it may not be.

Recording from an External Input

Recording from External Components

You can record from an external component, such as a camcorder or VCR, connected to any of the recorder's external inputs.

- 1 Make sure that the component you want to record from is connected properly to the Recorder. See page 18.**
- 2 Press AV repeatedly to select the external input to record from.**
 - Tuner: Built-in tuner
 - AV1: EURO AV1 AUDIO/VIDEO mounted on back panel
 - AV2: EURO AV2 DECODER mounted on back panel
 - AV3: AV3 IN (VIDEO, AUDIO (L/R), S-VIDEO IN) mounted on front panel
 - DV: DV IN mounted on front panel

Note

Check that the Audio In settings DV Record Audio are as you want them. See page 27.

- 3 Load a recordable disc or tape.**

- 4 Select the recording mode as necessary by pressing REC MODE repeatedly.**

DVD: SP (Standard Quality), LP (Low Quality), XP(High Quality), EP (Extended Quality)

VCR: SP (Standard Play), LP (Long Play)

- 5 Press REC (●) once.**

Recording will start. (The REC indicator lights in the display window.)

- Recording continues until you press STOP (■) or the disc or tape is full.
- To record for a fixed length of time, see Instant Timer Recording on page 42.

- 6 Press STOP (■) to stop recording.**

Note

If your source is copy-protected using CopyGuard, you will not be able to record it using this recorder. See Copyright on page 9 for more details.

Recording from a Digital Camcorder

You can record from a digital camcorder connected to the DV IN jack on the front panel of this recorder. Using the recorder's remote, you can control both the camcorder and this recorder.

Before recording, make sure that the audio input for the DV IN jack is set up (see page 27).

Tips

- The source signal must be DVC-SD format.
- Some camcorders cannot be controlled using this recorder's remote.
- If you connect a second DVD Recorder using a DV cable, you cannot control the second DVD Recorder from this one.
- You can't control this unit remotely from a component connected to the DV IN jack.
- You can't record date and time information from a DV cassette.

- 1 Make sure your digital camcorder is connected to the front panel DV IN jack. See page 18.**

- 2 Check that the DV audio input is as you require.**

You can choose between Audio 1 (original audio) and Audio 2 (overdubbed audio).

- DV Input is set from the DV Record Audio in sub-menu of the Setup menu. See DV Record Audio on page 27 for more information.

- 3 Press AV repeatedly to select the DV input.**

DV appears in the display window.

- 4 Find the place on the camcorder tape that you want to the recording to start from.**

For best results, pause playback at the point from which you want to record.

- Depending on your camcorder, you can use this recorder's remote to control the camcorder using the STOP, PLAY and PAUSE functions.

- 5 Press REC (●) once to start recording.**

- Recording is automatically stopped if the recorder detects no signal.
- You can pause or stop the recording by pressing PAUSE/STEP (||) or STOP (■). You cannot control the camcorder from this remote control during recording.
- In Video mode, the final frame of the recording may remain displayed on screen for a while after recording stops.
- For timer recording to work properly on this recorder, the digital camcorder must also be switched on and in operating.

Recording from an External Input (Continued)

What is DV?

Using DV, also known as i.LINK, you can connect a DV-equipped camcorder to this recorder using a single DV cable for input and output of audio, video, data and control signals.

The i.LINK interface is also known as IEEE 1394-1995. "i.LINK" and the "i.LINK" logo are trademarks.

- This recorder is only compatible with DV-format (DVC-SD) camcorders. Digital satellite tuners and Digital VHS video recorders are not compatible.
- You cannot connect more than one DV camcorder at a time to this recorder.
- You cannot control this recorder from external equipment connected via the DV IN jack (including two DVD recorders).
- It may not always be possible to control the connected camcorder via the DV IN jack.
- Digital camcorders can usually record audio as stereo 16-bit/48kHz, or twin stereo tracks of 12-bit/32kHz. This recorder can only record one stereo audio track. Set DV Record Audio to Audio 1 or Audio 2 as required (see page 27).
- Audio input to the DV IN jack should be 32 or 48kHz (not 44.1kHz).
- Picture disturbance on the recording may occur if the source component pauses playback or plays an unrecorded section of tape, or if the power fails in the source component, or the DV cable becomes disconnected.
- Although DV Record Audio is set to Audio 2 and Audio 2 signal is not present, DV Record Audio will be reset to Audio 1 automatically.

DV-Related Messages

You may see the following messages appear on your TV screen when using the DV IN jack.

Not connected to Camcorder.

The camcorder is not connected properly, or the camcorder is switched off.

Too many devices connected.

The DV jack on this recorder supports connection to just one camcorder.

Check the tape.

There is no cassette loaded into the connected equipment.

Uncontrollable device.

This recorder cannot control the camcorder.

Updating the information.

Camcorder is updating the information for DV.

Camera mode.

Camcorder is set to camera mode.

Troubleshooting

If you can't get a picture and/or audio through the DV IN jack, check the bullet points:

- Make sure the DV cable is properly connected.
- Try switching off the connected equipment then switch back on.
- Try switching the audio input.

Notes

- Depending on the connected camcorder, you may not be able to control it using the remote control supplied with this recorder.
- Before you set the mode of your Camcorder to camera mode, turn down the volume of connected Sound device. There can be a howling sound.

Title List and Chapter List Menu

Using the Title List-Original menu **VR**

The Title List-Original is where you build and edit your Playlist, and where you can delete titles and make other changes to the Original content of the disc. You can also play individual titles directly from the Title List-Original menu.

The recorder must be stopped in order to edit using the Title List-Original.

1 Press LIST/DISC MENU repeatedly to display the Title List-Original menu.

- Use the ▲ / ▼ buttons to display the previous/ next page if there are more than 6 titles.
- To exit the Title List-Original menu, press RETURN (↵).

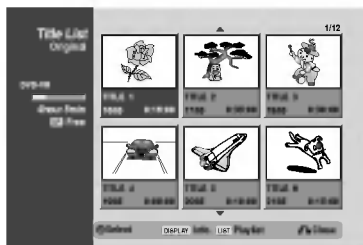

2 To view Title List-Original options, select the title you want then press ENTER.

Title List-Original options appears on the left side of the menu.

3 Use ▲ / ▼ to select an option then press ENTER to confirm.

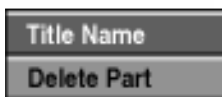
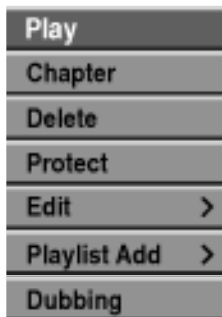

Play: Starts playback the selected title.

Chapter: Moves Chapter List-Original menu of the title. (refer to right on this page)

Delete: Deletes the title. (page 55)

Protect: Protects accidental recording, editing or deleting of the title. (page 57)

Edit: Selects Edit options.

- **Title Name:** Edits the title name. (page 56)

- **Delete Part:** Deletes a part of the Title. (page 55)

Playlist Add: Adds the title to the Playlist. (page 54)

Dubbing: Copsys the title to a VHS tape.

4 Press RETURN (↵) repeatedly to exit Title List-Original menu.



Press DISPLAY to display more detailed title information for selected title.

Using the Chapter List-Original menu **VR**

1 Press LIST/DISC MENU repeatedly to display Title List-Original menu.

2 Use ▲ ▼ ◀ ▶ to choose the title you want to view Chapter List-Original menu then press ENTER.

Title List-Original options appears on the left side of the menu.

3 Use ▲ / ▼ to select 'Chapter' from Title List-Original options then press ENTER.

Chapter List-Original menu appears on the TV screen.

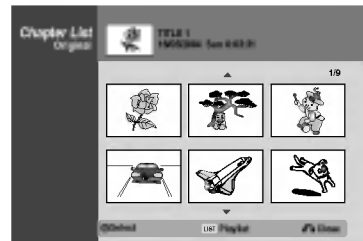

4 To view Chapter List-Original options, select the chapter you want then press ENTER.

Chapter List-Original options appears on the left side of the menu.

5 Use ▲ / ▼ to select an option then press ENTER to confirm.



Play: Starts playback of the selected chapter.

Title: Moves to Title List-Original menu of the chapter. (refer to left on this page)

Delete: Deletes the chapter. (page 55)

Combine: Merges two chapters into one. (page 56)

Playlist Add: Adds the chapter to the Playlist. (page 54)

6 Press RETURN (↵) repeatedly to exit Chapter List-Original menu.

Title List and Chapter List Menu (Continued)

Using the Title List-Playlist Menu **VR**

- 1 Press LIST/DISC MENU repeatedly to display the Title List-Playlist menu.
 - Use the ▲ / ▼ buttons to display the previous/next page if there are more than 6 titles.
 - To exit the Title List-Playlist, press RETURN (↵).

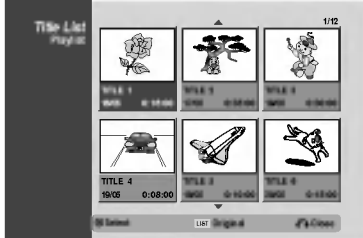

- 2 To view Title List-Playlist options, select the title you want then press ENTER.

Title List-Playlist options appears on the left side of the menu.

- 3 Use ▲ / ▼ to select an option then press ENTER to confirm.

Play
Chapter
Title Name
Delete
Delete Part
Dubbing

Play: Starts playback the selected title.

Chapter: Moves Chapter List-Playlist menu of the title. (refer to right on this page)

Title Name: Edits the title name. (page 56)

Delete: Deletes the title from the Title List-Playlist menu. (page 55)

Delete Part: Deletes a part of the Title. (page 55)

Dubbing: Copys the title to a VHS tape.

- 4 Press RETURN (↵) repeatedly to exit Title List-Playlist menu.



Press DISPLAY to display more detailed title information for selected title.

Using the Chapter List-Playlist Menu **VR**

- 1 Press LIST/DISC MENU repeatedly to display the Title List-Playlist menu.

- 2 Use ▲ ▼ ◀ ▶ to choose the title you want to view Chapter List-Playlist menu then press ENTER.

Title List-Playlist options appears on the left side of the menu.

- 3 Use ▲ / ▼ to select 'Chapter' from Title List-Playlist options then press ENTER.

Chapter List-Playlist menu appears on the TV screen.

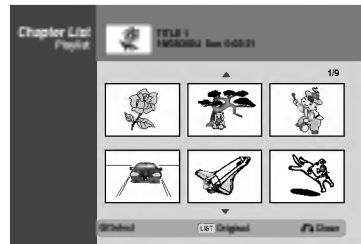

- 4 To view Chapter List-Playlist options, select the chapter you want then press ENTER.

Chapter List-Playlist options appears on the left side of the menu.

- 5 Use ▲ / ▼ to select an option then press ENTER to confirm.

Play
Title
Delete
Move
Combine

Play: Starts playback of the selected chapter.

Title: Moves to Title List-Playlist menu of the chapter. (refer to left on this page)

Delete: Deletes the chapter from the Chapter List-Playlist menu. (page 55)

Move: Moves a chapter of Chapter List-Playlist menu to a position on the menu. (page 57)

Combine: Merges two chapters into one. (page 56)

- 6 Press RETURN (↵) repeatedly to exit Chapter List-Playlist menu.

Title List and Chapter List Menu (Continued)

Using the Title List menu Video

From the Title List display you can play, name and delete titles.

Once a Video mode disc is finalized, the Title List screen changes its appearance and all you can do is select titles to play.

1 Press LIST/DISC MENU to display the Title List.

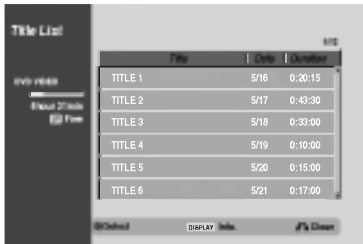

2 Use ▲ / ▼ to choose a title then press ENTER.

Title List options appears on the left side of the Title List display.

3 Use ▲ / ▼ to select an option then press ENTER to confirm.



Play: Starts playback the selected title.

Title Name: Edits the title name. (page 56)

Delete: Deletes the title from the Title List.

Dubbing: Copies the title to a VHS tape.

4 Press RETURN (↵) repeatedly to exit Title List.



Tip
Press DISPLAY to display more detailed title information for selected title.

Deleting a Title Video

Before a disc is finalized, you can delete titles recorded on the disc.

⚠ Caution

- If you delete a title from a DVD-R disc, the title will disappear from the Title List, but the available recording time will not increase.
- When deleting a title from a DVD-RW disc, the remaining time available for recording will only increase if it is the last title on the disc.

1 Press LIST/DISC MENU to display Title List

2 Use ▲ ▼ ◀ ▶ to choose a title you want to delete then press ENTER.

Title List options appears on the left side of the Title List menu.

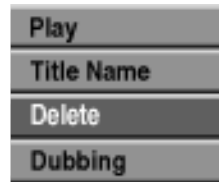

3 Use ▲ / ▼ to select 'Delete' then press ENTER to confirm.

The confirm message for deleting will appear.

4 Use ◀ / ▶ to select 'Yes' then press ENTER.

The selected chapter or title is deleted. After pressing ENTER, the new, updated menu is displayed.

5 Repeat steps 2-4 to delete additional titles from the Title List.

6 Press RETURN (↵) repeatedly to remove the Title List display.

If the disc has already been finalized

You should see a screen like the one below.

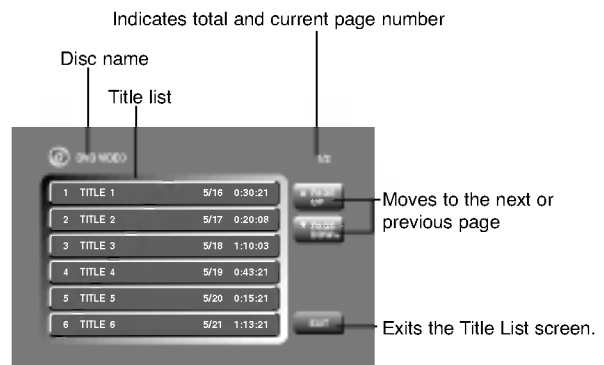

Title List and Chapter List Menu (Continued)

Using the Title List menu **+RW**

The Title List is where you can see the all recorded titles, and where you can delete titles and make other changes to the Original content of the disc. You can also play titles directly from the Title List menu. The recorder must be stopped in order to edit using the Title List menu.

1 Press LIST/DISC MENU to display the Title List menu.

- Use the ▲ / ▼ buttons to display the previous/ next page if there are more than 6 titles.
- To exit the Title List menu, press RETURN (↵).

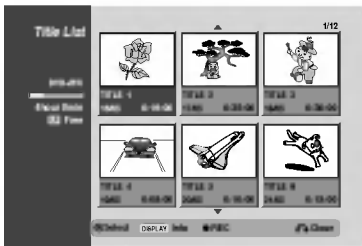

2 To view Title List options, select the title you want then press ENTER.

Title List options appears on the left side of the menu.

3 Use ▲ / ▼ to select an option then press ENTER to confirm.

Play
Full Play
Chapter
Delete
Protect
Edit >
Dubbing

Play: Starts playback the selected title except the hidden chapters.

Full Play: Starts playback the selected title including the hidden chapters.

Chapter: Moves Chapter List menu of the title. (refer to right on this page)

Delete: Deletes the title. (page 55)

Protect: Protects accidental recording, editing or deleting of the title. (page 57)

Edit: Selects Edit options.

- **Title Name:** Edits the title name. (page 56)
- **Divide:** Divides one title into two titles. (page 58)
- **Hide (Show):** Hides (or Shows) the all chapters within the title. (page 58)

Dubbing: Copys the title to a VHS tape.

4 Press RETURN (↵) repeatedly to exit Title List menu.

Title Name
Divide
Hide



Tip
Press DISPLAY to display more detailed title information for selected title.



Caution
If you press REC (●) when the Title List menu appears, the selected title is erased then overwrite recording starts. (See page 59 for more details.)

Using the Chapter List menu **+RW**

1 Press LIST/DISC MENU to display Title List menu.

2 Use ▲ ▼ ◀ ▶ to choose the title you want to view Chapter List menu then press ENTER. Title List options appears on the left side of the menu.

3 Use ▲ / ▼ to select 'Chapter' from Title List options then press ENTER. Chapter List menu appears on the TV screen.

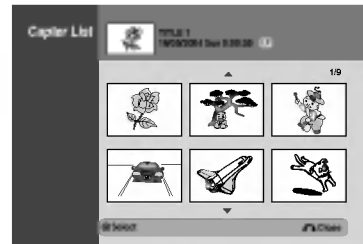

4 To view Chapter List options, select the chapter you want then press ENTER.

Chapter List options appears on the left side of the menu.

5 Use ▲ / ▼ to select an option then press ENTER to confirm.

Play
Title
Combine
Hide

Play: Starts playback of the selected chapter.

Title: Moves to Title List menu of the chapter. (refer to left on this page)

Combine: Combines two chapters into one. (page 56)

Hide (Show): Hides (or Shows) the selected chapter. (page 58)

6 Press RETURN (↵) repeatedly to exit Chapter List menu.

Title List and Chapter List Menu (Continued)

Using the Title List menu **+R**

The Title List is where you can see the all recorded titles, and where you can delete titles and make other changes to the Original content of the disc. You can also play titles directly from the Title List menu. The recorder must be stopped in order to edit using the Title List menu.

1 Press LIST/DISC MENU to display the Title List menu.

- Use the ▲ / ▼ buttons to display the previous/ next page if there are more than 6 titles.
- To exit the Title List menu, press RETURN (↵).

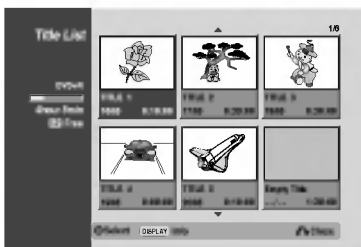

2 To view Title List options, select the title you want then press ENTER.

Title List options appears on the left side of the Title List menu.

3 Use ▲ / ▼ to select an option then press ENTER to confirm.

Play
Full Play
Chapter
Delete
Protect
Edit >
Dubbing

Play: Starts playback the selected title except the hidden chapters.

Full Play: Starts playback the selected title including the hidden chapters.

Chapter: Moves Chapter List menu of the title. (refer to right on this page)

Delete: Deletes the title. (page 55)

Protect: Protects accidental recording, editing or deleting of the title. (page 57)

Edit: Selects Edit options.

- **Title Name:** Edits the title name. (page 56)
- **Hide (Show):** Hides (or Shows) the all chapters within the title. (page 58)

Dubbing: Copys the title to a VHS tape.

Title Name
Divide
Hide

4 Press RETURN (↵) repeatedly to exit Title List menu.



Tip
Press DISPLAY to display more detailed title information for selected title.

Using the Chapter List menu **+R**

1 Press LIST/DISC MENU to display Title List menu.

2 Use ▲ ▼ ◀ ▶ to choose the title you want to view Chapter List menu then press ENTER.

Title List options appears on the left side of the menu.

3 Use ▲ / ▼ to select 'Chapter' from Title List options then press ENTER.

Chapter List menu appears on the TV screen.

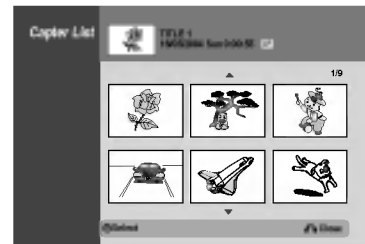

4 To view Chapter List options, select the chapter you want then press ENTER.

Chapter List options appears on the left side of the menu.

5 Use ▲ / ▼ to select an option then press ENTER to confirm.

Play
Title
Combine
Hide

Play: Starts playback of the selected chapter.

Title: Moves to Title List menu of the chapter. (refer to left on this page)

Combine: Combines two chapters into one. (page 56)

Hide (Show): Hides (or Shows) the selected chapter. (page 58)

6 Press RETURN (↵) repeatedly to exit Chapter List menu.

Title and Chapter Editing

Edits you make to the Original content changes the actual content of the disc. For example, if you delete a title or chapter from the Original content (Title or Chapter), that title or chapter is deleted from the disc, freeing up extra recording time.

When you edit the Playlist, on the other hand, you are not changing the content of the disc. For example, when you delete a title from the Playlist, you are just telling the recorder not to play that title; nothing is actually deleted from the disc.

Titles, Chapters and Parts

Titles in the disc's original content contain one or more chapters. When you insert a title into the Playlist, all the chapters within that title also appear. In other words, chapters in the Playlist behave exactly as chapters on a DVD-Video disc do. Parts are sections of Original or Playlist titles. From the Original and Playlist menu you can add or delete parts. Adding a chapter or title to the Playlist creates a new title made up of a section (i.e., chapter) of an Original title. Deleting a part removes part of a title from the Original or Playlist menu.

Caution

- When editing using the Delete, Add and Move functions, the start and end frames may not be exactly as set in the start and end point display.
- During Playlist playback, you may notice a momentary pause between edits. This is not a malfunction.

Adding Chapter Markers

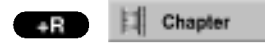

You can put a chapter marker anywhere in a Playlist or Original title during recording or playback.

Once the chapter is marked, you can use the Chapter Search feature, as well as delete, combine and move chapters in the Chapter List-Original or Chapter List-Playlist menu.

You can insert up to 999 chapter markers in both the Original and Playlist contents.

Note

Chapter markers are inserted at regular intervals automatically. You can change this interval from the Initial Setup menu (see Auto Chapter on page 27).

1 Play the title (Original or Playlist).

2 At the point you want to start a new chapter, press **CHP ADD**.

- A chapter marker icon appears on the TV screen.
- You can also put chapter markers in during recording.

Changing Title Thumbnails



Each title displayed in the Title List menu is represented by a thumbnail picture taken from the start of that title or chapter.

If you prefer, select a different still picture from within a title.

1 Play the title (Original or Playlist).

2 Press **THUMBNAIL** to make the currently displayed picture the one that appears in the Original or Playlist menu.

- The still picture that you choose appears in both the Original or Playlist menu.

Tip

You can also change the thumbnail picture of the title on the Chapter List-Original or Chapter List-Playlist menu. Select a chapter on the Chapter List-Original or Chapter List-Playlist menu then press **THUMBNAIL**. The thumbnail picture of the title that includes the chapter is changed.

Title and Chapter Editing (Continued)

Making a New Playlist **VR**

Use this function to add an Original title or chapter to the Playlist. When you do this, the whole title is put into the Playlist (you can delete bits you don't need later — see Deleting an Original or Playlist title/chapter on page 55).

The title appears in the Playlist complete with the chapter markers that appear in the Original. However, if you add more chapter markers to the Original later, these are not automatically copied over into the Playlist title.

You can add up to 999 chapters to one disc. If you only want to add a chapter of a title, use the Adding a title/chapter to the Playlist on this page.

1 Press LIST/DISC MENU repeatedly to display Title List-Original menu.

If you want to display the Chapter List-Original menu, refer to “Using the Chapter List-Original menu” on page 48.

2 Choose a title or chapter on the Original menu to put into the Playlist, then press ENTER.

Original (Title or Chapter) options appears on the left side of the Original menu.

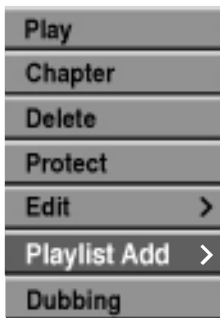

Title List-Original

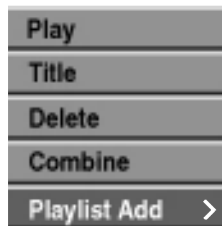

Chapter List-Original

3 Use ▲ / ▼ to select 'Playlist Add' from Original options then press ENTER.

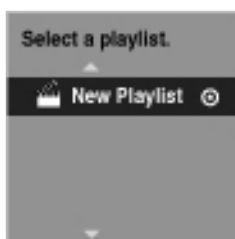

4 Select 'New Playlist' then press ENTER.

The new title appears in the updated Playlist. All chapters of the title are added to the Playlist.

Adding Additional Title/Chapters to the Playlist **VR**

You can add an Original title or chapter to add to a Playlist title even if it is already registered.

1 Press LIST/DISC MENU repeatedly to display Title List-Original menu.

If you want to show the Chapter List-Original menu, refer to “Using the Chapter List-Original menu” on page 48.

2 Choose an Original title or chapter to put into the Playlist, then press ENTER.

Original menu options appears on the left side of the screen.

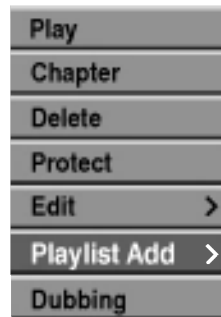

Title List-Original

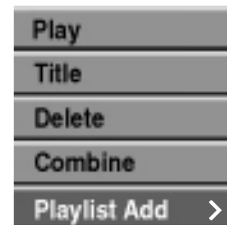

Chapter List-Original

3 Use ▲ / ▼ to select 'Playlist Add' from Original menu options then press ENTER.

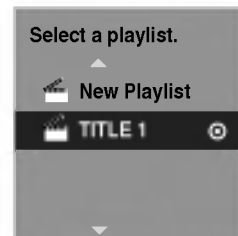

4 Choose a Title List-Playlist that is already registered to insert a title or chapter, then press ENTER.

The title or chapter appears in the updated Playlist menu.

5 Repeat steps 1-4 to add additional title or chapter on the Playlist.

6 Press RETURN (↵) to exit, or LIST/DISC MENU to go back to the Title List-Original menu.

Title and Chapter Editing (Continued)

Deleting a Title/Chapter

VR +RW +R

When you erase a title or chapter from the Playlist menu on DVD-RW discs formatted in VR mode, you only remove it from the Playlist; the title/chapter remains in the Original menu.

If you choose to delete a title or chapter from Title List or Chapter List menu, the title or chapter is actually deleted from the disc and the remaining time available for recording increases. Titles/chapters deleted from the Original are also removed from the Playlist.

Note

It may not be possible to delete chapters that are less than 3 seconds long.

1 On the Title List or Chapter List menu, use **▲▼◀▶** to choose a chapter or title you want to delete then press **ENTER**.
Options appears on the left side of the screen.

2 Select 'Delete' option on the options on the menu.

e.g., If you select "Delete" on Title List-Original menu.

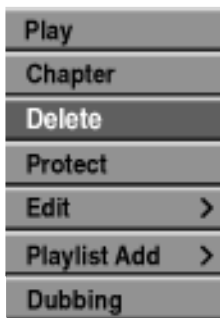

3 Press **ENTER** to confirm.
The confirm message for deleting will appear.

4 Use **◀/▶** to select 'Yes' then press **ENTER**.
The selected chapter or title is deleted.
After pressing **ENTER**, the new, updated menu is displayed.

5 Repeat steps 1 - 4 to continue to delete from the menu.

6 Press **RETURN** (↵) repeatedly to exit the menu.

Note

- When DVD+RW recording, the deleted title's name is changed to 'Deleted Title'.
- If the deleted titles more than two are continued, the titles are combined into one.

Deleting a Part **VR**

You can delete a part which you do not want in the title.

1 Press **LIST/DISC MENU** repeatedly to display Title List-Original or Title List-Playlist menu.

2 Use **▲▼◀▶** to choose a title you want to delete then press **ENTER**.
The options appears on the left side of the menu.

3 Select 'Delete Part' from the options on the menu.
e.g., If you select "Delete Part" on Title List-Original menu.



4 Press **ENTER**.
Title Edit (Delete Part) menu appears on the TV screen.
'Start Point' icon is highlighted.



5 Starts playback and use pause step, search and slow-motion to find the starting point.

6 Press **ENTER** at the starting point of the section you want to delete.
'End Point' icon is highlighted.
The part is indicated on the Progress Bar.

7 Use pause step, search, skip and slow-motion to find the ending point.

8 Press **ENTER** at the ending point of the section you want to delete.
You can cancel the selected point, use **▲/▼** to select 'Cancel' icon then press **ENTER**.

9 If you finish to edit, select 'Done' icon then press **ENTER**.
The confirm message for deleting will appear.

10 Use **◀/▶** to select 'Yes' then press **ENTER**.
The selected part is deleted from the title.

11 When finished editing, press **RETURN** (↵).

Title and Chapter Editing (Continued)

Naming a Title

You can name titles independently. Names can be up to 32 characters long.

1 On the Title List menu, use ▲▼◀▶ to choose the title you want to name then press ENTER. Options appears on the left side of the menu.

2 Use ▲/▼ to select 'Title Name' option then press ENTER.
Keyboard menu appears.

e.g., If you select "Title Name" on Title List-Original menu.

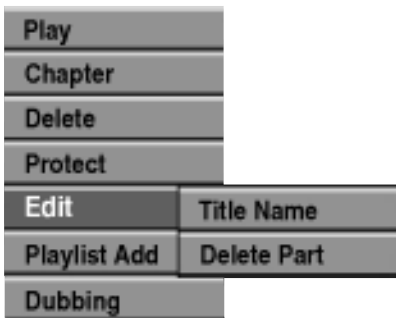

3 Enter a name for the title. Use ▲▼◀▶ to select a character then press ENTER to confirm your selection. Refer step 3 as shown on page 21 (Station Rename).

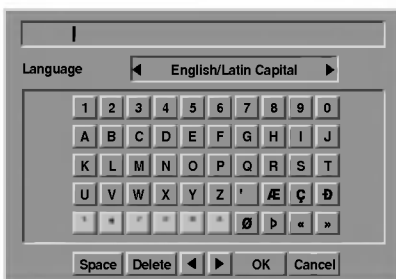

4 Choose OK then press ENTER to fix the name and return to the previous menu screen.

5 Press RETURN (↵) repeatedly to exit the menu.

Notes

- Names can be up to 32 characters long.
- For discs formatted on a different DVD Recorder, you will see only a limited character set.
- When recording in DVD-R, DVD+R or DVD+RW, the entered name is displayed on the DVD player only after finalizing.

Combining Two Chapters Into One

Use this function to combine two adjacent Playlist or Original chapters into one.

Note

This function is not available if there is only one chapter within the title.

1 On the Chapter List menu, select the second chapter of the two chapters you want to combine then press ENTER.

Chapter List options appears on the left side of the menu.

2 Use ▲ / ▼ to select 'Combine'.

The combine indicator appears between the two chapters you want to combine.

e.g., If you select "Combine" on Chapter List-Original menu.



3 Press ENTER to confirm.

After pressing ENTER, the new, updated menu is displayed.

4 Repeat steps 1 - 3 to continue to combine from the menu.

5 Press RETURN (↵) repeatedly to exit the menu.

Note

This function cannot operate listed below;

- If there is only one chapter within the title.
- If two chapters created by erasing a part from an original title.
- If two chapters created from different titles.
- If two chapters created by moving an order from an original title.

Title and Chapter Editing (Continued)

Moving a Playlist Chapter **VR**

Use this function to re-arrange the playing order of Playlist chapters on the Title List-Playlist menu.

- 1** Press LIST/DISC MENU repeatedly to display Title List-Playlist menu.
To display the Chapter List-Playlist menu, refer to "Using the Chapter List-Playlist Menu" on page 49.

Note

This function is not available if there is only one chapter.

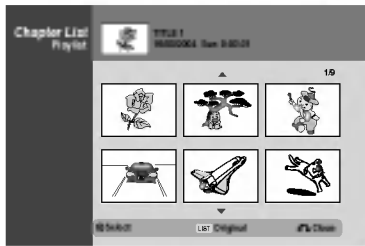

- 2** Select a chapter from the Chapter List-Playlist menu.
- 3** Press ENTER.
Chapter List-Playlist options appears on the left side of the menu.
- 4** Use ▲ / ▼ to select 'Move' from Playlist options then press ENTER.



- 5** Use ▲ ▼ ◀ ▶ to choose the place you want to move the chapter to then press ENTER.
After pressing ENTER, the new, updated menu is displayed.
- 6** Repeat steps 2 - 5 to continue to move from the menu.
- 7** Press RETURN (↵) repeatedly to exit the menu.

Protect a Title **VR** **+RW** **+R**

Use this function to protect accidental recording, editing or deleting of the title.

- 1** Press LIST/DISC MENU to display Title List menu.
- 2** Use ▲ ▼ ◀ ▶ to choose a title you want to protect then press ENTER.
Options appears on the left side of the screen.
- 3** Select 'Protect' option on the options.

e.g., If you select "Protect" on Title List menu.(DVD+RW/+R)

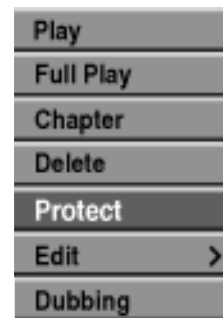

- 4** Press ENTER to confirm.
The lock mark will appears on the title's thumbnail.

Tip

If you select a title that has already been protected on the Title List menu, you can unprotect it by choosing "Unprotect" from the Title List menu options. After doing this, you can edit and delete the title.

Title and Chapter Editing (Continued)

Hide a Title/Chapter **+RW** **+R**

Use this function to hide a title/chapter on the Title List or Chapter List menu.

1 On the Title List or Chapter List menu, use **▲▼◀▶** to choose a title or chapter you want to hide then press **ENTER**.

Options appears on the left side of the screen.

2 Select 'Hide' option on the options.

e.g., If you select "Hide" on Title List menu.

Play	
Full Play	
Chapter	
Delete	
Protect	Title Name
Edit	Divide
Dubbing	Hide

3 Press **ENTER** to confirm.
The title's thumbnail will be dim.



Tip
If you select a title that has already been dim on the Title List menu, you can show it by choosing "Show" from the Title List menu options. After doing this, you can see the title.

Divide One Title Into Two **+RW**

Use this command to split a title up into two new titles.

1 On the Title List menu, select a title you want to divide then press **ENTER**.

The menu options appears on the left side of the screen.

2 Select 'Divide' from the Title List menu options.

Play	
Full Play	
Chapter	
Delete	
Protect	Title Name
Edit	Divide
Dubbing	Hide

3 Press **ENTER** when 'Divide' option is highlighted.

Title Edit-Divide menu appears and goes into STOP mode.

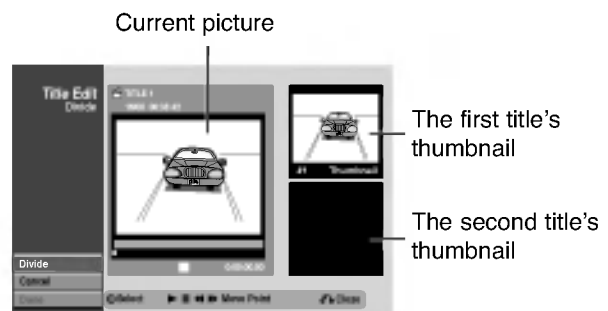

4 Use pause step, search, skip and slow-motion to find the point you want to divide the title.

5 When 'Divide' option is highlighted, press **ENTER** at the point.

You can clear the dividing point and exit the Title Edit-Divide menu, use **▲/▼** to select 'Cancel' option then press **ENTER**. The dividing point is clear.

6 Choose 'Done' option then press **ENTER** to fix the dividing point.

The title is divided into two new titles. It take up to 4 minutes to divide.

Additional Information

Clean-up Recording

You can simply clean-up (erase) all contents on the disc then start recording from the first section of the disc. The disc format is not changed.

- 1 Switch on the recorder and load a recordable disc.**
- 2 Press and hold REC (●) button for more than 3 seconds.**
The message will appear on the TV screen.



- 3 Use ◀/▶ to select "Yes" then press ENTER.**
Recording will start. (The REC icon appears on the TV screen.)

Overwrite Recording

To overwrite a new video recording to a previously recorded title, follow these steps. This feature is not available on DVD+R, which always record at the end of the Disc.

- 1 Select input source you want to record (channel, AV1-3, DV).**
- 2 Press LIST/DISC MENU to display the Title List menu.**

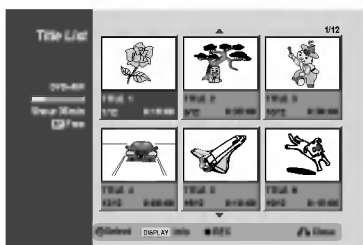

- 3 Use ▲▼◀▶ to choose a title you want to overwrite.**
- 4 Press REC (●) to start overwrite recording.**
Overwrite recording is started from the start point of the title.
- 5 Press STOP (■) to stop the overwrite recording.**
The new title is created and updated menu is displayed.

Notes

- This function is not available with a protected title.
- If the overwriting is elapsed more than the recording length of the current title, the next title is overwritten. But if next title is protected, the overwriting is stopped at the starting point of the title.
- If the selected title's recording length is less than 10 seconds, the next title is overwritten. But if next title is protected, the overwriting is stopped.

Viewing Title List menu displayed on other DVD recorders or players



You can view the Title List menu displayed on the another DVD player that is capable of playing DVD+RW or DVD+R discs.

- 1 Insert DVD+R or DVD+RW disc recorded already.**
- 2 Press TITLE button.**
Title List menu will appear as below.



You can remove the Title List menu by pressing STOP (■).



- 3 To play back a title, select the title you want then press ENTER or ▶ (PLAY).**

Playing Your Recordings on other DVD Players (Finalizing a Disc)

Most regular DVD players can play finalized discs recorded in Video mode, finalized DVD+R or DVD+RW. A small number of players can also play DVD-RW discs recorded in VR mode, finalized or not. Check the manual that came with the other player to check what kinds of discs it will play.

Finalizing 'fixes' the recordings and editings in place so that the disc can be played on a regular DVD player or computer equipped with a suitable DVD-ROM drive. Finalizing a Video mode disc creates a menu screen for navigating the disc. This is accessed by pressing LIST/DISC MENU or TITLE.

To finalize a disc, refer to "Disc Finalize" on page 28.

Notes

- Unfinalized DVD+RW is playable on regular DVD players.
- The edited contents of DVD+RW disc is compatible on regular DVD players only after finalizing.
- Any edited contents of the DVD+R disc are not be compatible on regular DVD players. (Hide, chapter combine, added chapter mark, etc.)

Language Code List

Enter the appropriate code number for the initial settings “Disc Audio”, “Disc Subtitle” and/or “Disc Menu” (See page 23).

Code	Language	Code	Language	Code	Language	Code	Language
6566	Abkhazian	7074	Fiji	7678	Lingala	8373	Singhalese
6565	Afar	7073	Finnish	7684	Lithuanian	8375	Slovak
6570	Afrikaans	7082	French	7775	Macedonian	8376	Slovenian
8381	Albanian	7089	Frisian	7771	Malagasy	8379	Somali
6577	Amharic	7176	Galician	7783	Malay	6983	Spanish
6582	Arabic	7565	Georgian	7776	Malayalam	8385	Sudanese
7289	Armenian	6869	German	7784	Maltese	8387	Swahili
6583	Assamese	6976	Greek	7773	Maori	8386	Swedish
6588	Aymara	7576	Greenlandic	7782	Marathi	8476	Tagalog
6590	Azerbaijani	7178	Guarani	7779	Moldavian	8471	Tajik
6665	Bashkir	7185	Gujarati	7778	Mongolian	8465	Tamil
6985	Basque	7265	Hausa	7865	Nauru	8484	Tatar
6678	Bengali; Bangla	7387	Hebrew	7869	Nepali	8469	Telugu
6890	Bhutani	7273	Hindi	7879	Norwegian	8472	Thai
6672	Bihari	7285	Hungarian	7982	Oriya	6679	Tibetan
6682	Breton	7383	Icelandic	8065	Panjabi	8473	Tigrinya
6671	Bulgarian	7378	Indonesian	8083	Pashto, Pushto	8479	Tonga
7789	Burmese	7365	Interlingua	7065	Persian	8482	Turkish
6669	Byelorussian	7165	Irish	8076	Polish	8475	Turkmen
7577	Cambodian	7384	Italian	8084	Portuguese	8487	Twi
6765	Catalan	7465	Japanese	8185	Quechua	8575	Ukrainian
9072	Chinese	7487	Javanese	8277	Rhaeto-Romance	8582	Urdu
6779	Corsican	7578	Kannada	8279	Romanian	8590	Uzbek
7282	Croatian	7583	Kashmiri	8285	Russian	8673	Vietnamese
6783	Czech	7575	Kazakh	8377	Samoan	8679	Volapük
6865	Danish	7589	Kirghiz	8365	Sanskrit	6789	Welsh
7876	Dutch	7579	Korean	7168	Scots Gaelic	8779	Wolof
6978	English	7585	Kurdish	8382	Serbian	8872	Xhosa
6979	Esperanto	7679	Laothian	8372	Serbo-Croatian	7473	Yiddish
6984	Estonian	7665	Latin	8378	Shona	8979	Yoruba
7079	Faeroese	7686	Latvian, Lettish	8368	Sindhi	9085	Zulu

Country Code List

Enter the appropriate code number for the initial setting "Country Code" (See page 26).

Code	Country	Code	Country	Code	Country	Code	Country
AD	Andorra	ER	Eritrea	LC	Saint Lucia	SC	Seychelles
AE	United Arab Emirates	ES	Spain	LI	Liechtenstein	SD	Sudan
AF	Afghanistan	ET	Ethiopia	LK	Sri Lanka	SE	Sweden
AG	Antigua and Barbuda	FI	Finland	LR	Liberia	SG	Singapore
AI	Anguilla	FJ	Fiji	LS	Lesotho	SH	Saint Helena
AL	Albania	FK	Falkland Islands	LT	Lithuania	SI	Slovenia
AM	Armenia	FM	Micronesia	LU	Luxembourg	SJ	Svalbard and Jan Mayen Islands
AN	Netherlands Antilles	FO	Faroe Islands	LV	Latvia	SK	Slovak Republic
AO	Angola	FR	France	LY	Libya	SL	Sierra Leone
AQ	Antarctica	FX	France (European Territory)	MA	Morocco	SM	San Marino
AR	Argentina	GA	Gabon	MC	Monaco	SN	Senegal
AS	American Samoa	GB	Great Britain	MD	Moldavia	SO	Somalia
AT	Austria	GD	Grenada	MG	Madagascar	SR	Suriname
AU	Australia	GE	Georgia	MH	Marshall Islands	ST	Saint Tome and Principe
AW	Aruba	GF	French Guyana	MK	Macedonia	SU	Former USSR
AZ	Azerbaijan	GH	Ghana	ML	Mali	SV	El Salvador
BA	Bosnia-Herzegovina	GI	Gibraltar	MM	Myanmar	SY	Syria
BB	Barbados	GL	Greenland	MN	Mongolia	SZ	Swaziland
BD	Bangladesh	GM	Gambia	MO	Macau	TC	Turks and Caicos Islands
BE	Belgium	GN	Guinea	MP	Northern Mariana Islands	TD	Chad
BF	Burkina Faso	GP	Guadeloupe (French)	MQ	Martinique (French)	TF	French Southern Territories
BG	Bulgaria	GQ	Equatorial Guinea	MR	Mauritania	TG	Togo
BH	Bahrain	GR	Greece	MS	Montserrat	TH	Thailand
BI	Burundi	GS	S. Georgia & S. Sandwich Isls.	MT	Malta	TJ	Tadjikistan
BJ	Benin	GT	Guatemala	MU	Mauritius	TK	Tokelau
BM	Bermuda	GU	Guam (USA)	MV	Maldives	TM	Turkmenistan
BN	Brunei Darussalam	GW	Guinea Bissau	MW	Malawi	TN	Tunisia
BO	Bolivia	GY	Guyana	MX	Mexico	TO	Tonga
BR	Brazil	HK	Hong Kong	MY	Malaysia	TP	East Timor
BS	Bahamas	HM	Heard and McDonald Islands	MZ	Mozambique	TR	Turkey
BT	Bhutan	HN	Honduras	AN	Namibia	TT	Trinidad and Tobago
BV	Bouvet Island	HR	Croatia	NC	New Caledonia (French)	TV	Tuvalu
BW	Botswana	HT	Haiti	NE	Niger	TW	Taiwan
BY	Belarus	HU	Hungary	NF	Norfolk Island	TZ	Tanzania
BZ	Belize	ID	Indonesia	NG	Nigeria	UA	Ukraine
CA	Canada	IE	Ireland	NI	Nicaragua	UG	Uganda
CC	Cocos (Keeling) Islands	IL	Israel	NL	Netherlands	UK	United Kingdom
CF	Central African Republic	IN	India	NO	Norway	UM	USA Minor Outlying Islands
CG	Congo	IO	British Indian Ocean Territory	NP	Nepal	US	United States
CH	Switzerland	IQ	Iraq	NR	Nauru	UY	Uruguay
CI	Ivory Coast	IR	Iran	NU	Niue	UZ	Uzbekistan
CK	Cook Islands	IS	Iceland	NZ	New Zealand	VA	Vatican City State
CL	Chile	IT	Italy	OM	Oman	VC	Saint Vincent & Grenadines
CM	Cameroon	JM	Jamaica	PA	Panama	VE	Venezuela
CN	China	JO	Jordan	PE	Peru	VG	Virgin Islands (British)
CO	Colombia	JP	Japan	PF	Polynesia (French)	VI	Virgin Islands (USA)
CR	Costa Rica	KE	Kenya	PG	Papua New Guinea	VN	Vietnam
CS	Former Czechoslovakia	KG	Kyrgyzstan	PH	Philippines	VU	Vanuatu
CU	Cuba	KH	Cambodia	PK	Pakistan	WF	Wallis and Futuna Islands
CV	Cape Verde	KI	Kiribati	PL	Poland	WS	Samoa
CX	Christmas Island	KM	Comoros	PM	Saint Pierre and Miquelon	YE	Yemen
CY	Cyprus	KN	Saint Kitts & Nevis Anguilla	PN	Pitcairn Island	YT	Mayotte
CZ	Czech Republic	KP	North Korea	PR	Puerto Rico	YU	Yugoslavia
DE	Germany	KR	South Korea	PT	Portugal	ZA	South Africa
DJ	Djibouti	KW	Kuwait	PW	Palau	ZM	Zambia
DK	Denmark	KY	Cayman Islands	PY	Paraguay	ZR	Zaire
DM	Dominica	KZ	Kazakhstan	QA	Qatar	ZW	Zimbabwe
DO	Dominican Republic	LA	Laos	RE	Reunion (French)		
DZ	Algeria	LB	Lebanon	RO	Romania		
EC	Ecuador			RU	Russian Federation		
EE	Estonia			RW	Rwanda		
EG	Egypt			SA	Saudi Arabia		
EH	Western Sahara			SB	Solomon Islands		

REFERENCE

Controlling Your TV with the Supplied Remote

You can control the sound level, input source, and power switch of your LG TV with the supplied remote.

You can control your TV using the buttons below.

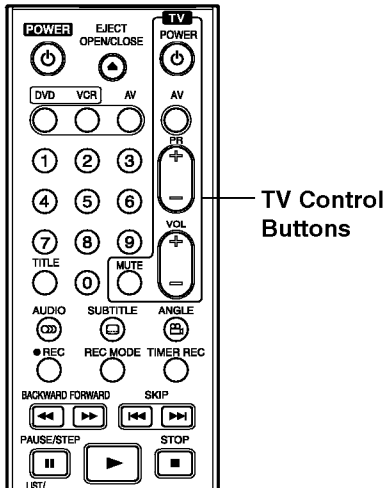

By pressing	You can
POWER	Turn the TV on or off.
AV	Switch the TV's input source between the TV and other input sources.
PR +/-	Scans up or down through memorized channels.
VOL +/-	Adjust the volume of the TV.
MUTE	Temporarily turns TV sound OFF, press again to restore.

Controlling other TVs with the remote

You can control the sound level, input source, and power switch of non-LG TVs as well. If your TV is listed in the table below, set the appropriate manufacturer code.

1. While holding down TV POWER button, press the number buttons to select the manufacturer code for your TV (see the table below).
2. Release TV POWER button.

Code numbers of controllable TVs

If more than one code number is listed, try entering them one at a time until you find the one that works with your TV.

Manufacturer	Code Number
LG / GoldStar	1 (Default), 2
Zenith	1, 3, 4
Samsung	6, 7
Sony	8, 9
Hitachi	4

Notes

- Depending on your TV, some or all buttons may not function on the TV, even after entering the correct manufacturer code.
- If you enter a new code number, the code number previously entered will be erased.
- When you replace the batteries of the remote, the code number you have set may be reset to the default setting. Set the appropriate code number again.

Troubleshooting

Check the following guide for the possible cause of a problem before contacting service.

Symptom	Cause	Solution
No power.	<ul style="list-style-type: none"> The power cord is disconnected. 	<ul style="list-style-type: none"> Plug the power cord into the wall outlet securely.
No picture.	<ul style="list-style-type: none"> The TV is not set to receive Recorder signal output. 	<ul style="list-style-type: none"> Select the appropriate video input mode on the TV so the picture from the Recorder appears on the TV screen.
	<ul style="list-style-type: none"> The video cable is not connected securely. 	<ul style="list-style-type: none"> Connect the video cable securely.
	<ul style="list-style-type: none"> The connected TV power is turned off. 	<ul style="list-style-type: none"> Turn on the TV.
No sound.	<ul style="list-style-type: none"> The equipment connected with the audio cable is not set to receive Recorder signal output. 	<ul style="list-style-type: none"> Select the correct input mode on the audio receiver so you can listen to the sound from the Recorder.
	<ul style="list-style-type: none"> The audio cables are not connected securely. 	<ul style="list-style-type: none"> Connect the audio cable securely.
	<ul style="list-style-type: none"> The power of the equipment connected with the audio cable is turned off. 	<ul style="list-style-type: none"> Turn on the equipment connected with the audio cable.
	<ul style="list-style-type: none"> The audio connecting cord is damaged. 	<ul style="list-style-type: none"> Replace it with new one.
The playback picture is poor.	<ul style="list-style-type: none"> The disc is dirty. 	<ul style="list-style-type: none"> Clean the disc.
The Recorder does not start playback.	<ul style="list-style-type: none"> No disc is inserted. 	<ul style="list-style-type: none"> Insert a disc.
	<ul style="list-style-type: none"> An unplayable disc is inserted. 	<ul style="list-style-type: none"> Insert a playable disc. (Check the disc type, color system, and regional code.)
	<ul style="list-style-type: none"> The disc is placed upside down. 	<ul style="list-style-type: none"> Place the disc with the playback side down.
	<ul style="list-style-type: none"> The disc is not placed within the guide. 	<ul style="list-style-type: none"> Place the disc on the disc tray correctly inside the guide.
	<ul style="list-style-type: none"> The disc is dirty. 	<ul style="list-style-type: none"> Clean the disc.
	<ul style="list-style-type: none"> The Movie Rating level is set. 	<ul style="list-style-type: none"> Cancel the Rating function or change the rating level.
The picture from the external input is distorted	<ul style="list-style-type: none"> The video signal from the external component is copy-protected. 	<ul style="list-style-type: none"> You cannot connect via this recorder. Connect the component directly to your TV.
Some channels are skipped over when using ▲ / ▼.	<ul style="list-style-type: none"> Those channels are not stored in the recorder. 	<ul style="list-style-type: none"> Restore channels. See "Program Edit" on pages 20-21.
The picture or sound of broadcasting channel is weak or missing.	<ul style="list-style-type: none"> Aerial or cables are loose. 	<ul style="list-style-type: none"> Tighten connections or replace cable.
Camcorder image is not shown.	<ul style="list-style-type: none"> Camcorder is off. 	<ul style="list-style-type: none"> Turn camcorder on and operate properly.
Camcorder image via A/V input or DV IN to Recorder is not shown on TV screen.	<ul style="list-style-type: none"> Recorder INPUT SELECT is incorrect. 	<ul style="list-style-type: none"> Use AV to select input channel (AV1, AV2, AV3, DV, etc.)

Troubleshooting (Continued)

Symptom	Cause	Solution
Can't play a disc recorded using this recorder on another player.	• The disc was recorded in Video mode.	• Finalize the disc. (page 28)
	• Some players will not play even a finalized disc recorded in Video mode.	• No solution.
	• The disc was recorded in VR mode,	• The other player must be RW compatible in order to play it.
	• Discs recorded with copy-once material cannot be played on other players.	• No solution.
Cannot record or did not record successfully.	• The remaining blank space on the disc is insufficient.	• Use another disc.
	• The source you are trying to record is copy protected.	• You cannot record the source.
	• When setting the recording channel, the channel is tuned on the TV's own tuner.	• Select the channel on the recorder's built-in TV tuner.
	• When recording to a Video mode disc, programs that are copy-once protected cannot be recorded.	• Use a VR mode formatted disc for copy-once material.
Timer recording is not possible.	• Clock in Recorder is not set to correct time.	• Set clock to correct time. See "Auto Clock Set" or "Manual Clock Set" on page 22.
	• Timer has been programmed incorrectly.	• Reprogram Timer. See "Timer Recording" on page 44-45.
	• Timer record indicator light does not appear after programming timer.	• Reprogram Timer.
Stereo Audio Record and/or Playback is not present.	• TV is not Stereo-compatible.	• No solution.
	• Broadcast program is not in stereo format.	• No solution.
	• Recorder A/V Out jacks are not connected to TV A/V In jacks.	• Make A/V connections. Stereo is available only via A/V output from Recorder.
	• Recorder Audio/Video Out is not selected for viewing at the TV.	• Select AUX or A/V source as TV input.
	• Recorder's TV audio channel is set to mono.	• Set TV audio channel mode to Stereo. See "Changing TV audio channel" on page 30.
The remote control does not work properly.	• The remote control is not pointed at the remote sensor of the Recorder.	• Point the remote control at the remote sensor of the Recorder.
	• The remote control is too far from the Recorder.	• Operate the remote control within 7 m.
	• There is an obstacle in the path of the remote control and the Recorder.	• Remove the obstacle.
	• The batteries in the remote control are exhausted.	• Replace the batteries with new ones.

Moisture Condensation

Moisture condensation can occur:	In locations where moisture condensation may occur:
<ul style="list-style-type: none"> • When the Recorder is moved from a cold place to a warm place. • Under extremely humid conditions. 	<ul style="list-style-type: none"> • Keep the Recorder plugged into an AC power outlet with POWER On. This will help prevent condensation. • When condensation has occurred, wait a few hours for the Recorder to dry before using it.

Specifications

General

Power requirements	AC 200-240V, 50 Hz
Power consumption	35W
Dimensions (approx.)	430 X 78.5 X 354 mm (w x h x d)
Mass (approx.)	5.7 kg
Operating temperature	5°C to 35°C
Operating humidity	5 % to 90 %
Television system	PAL B/G, PAL I/I, SECAM D/K colour system
Recording format	PAL

System

Laser	Semiconductor laser, wavelength 650 nm
Video head system	Double azimuth 4 heads, helical scanning
Signal system	PAL

Recording

Recording format	DVD VideoRecording, DVD-VIDEO
Recordable discs	DVD-ReWritable, DVD-Recordable, DVD+ReWritable, DVD+Recordable
Recordable time	Approx. 1 hour (XP mode), 2 hours (SP mode), 4 hours (LP mode), 6 hours (EP mode)
Video recording format	
Sampling frequency	27MHz
Compression format	MPEG 2
Audio recording format	
Sampling frequency	48kHz
Compression format	Dolby Digital

Playback

Frequency response	DVD (PCM 48 kHz): 8 Hz to 22 kHz, CD: 8 Hz to 20 kHz DVD (PCM 96 kHz): 8 Hz to 44 kHz
Signal-to-noise ratio	More than 100 dB (AUDIO OUT connector)
Harmonic distortion	Less than 0.008% (AUDIO OUT connector)
Dynamic range	More than 95 dB (AUDIO OUT connector)

Inputs

AERIAL IN	Aerial input, 75 ohms
VIDEO IN	1.0 Vp-p 75 ohms, sync negative, RCA jack x 1 / SCART x 2
AUDIO IN	0 dBm more than 47 kohms, RCA jack (L, R) x 1 / SCART x 2
DV IN	4 pin (i.LINK/IEEE 1394 standard)
S-VIDEO IN	(Y) 1.0 V (p-p), 75 Ω, negative sync, Mini DIN 4-pin x 1 (C) 0.3 V (p-p) 75 Ω

Outputs

S-VIDEO OUT	(Y) 1.0 V (p-p), 75 Ω, negative sync, Mini DIN 4-pin x 1 (C) 0.3 V (p-p) 75 Ω
COMPONENT VIDEO OUT	(Y) 1.0 V (p-p), 75 Ω, negative sync, RCA jack x 1 (Pb)/(Pr) 0.7 V (p-p), 75 Ω, RCA jack x 2
Audio output (digital audio)	0.5 V (p-p), 75 Ω, RCA jack x 1
Audio output (optical audio)	3 V (p-p), 75 Ω, Optical connector x 1
Audio output (analog audio)	2.0 Vrms (1 KHz, 0 dB), 600 Ω, RCA jack (L, R) x 1 / SCART

- Design and specifications are subject to change without notice.
- Manufactured under license from Dolby Laboratories. "Dolby", "Pro Logic" and the double-D symbol are trademarks of Dolby Laboratories.
- DTS and DTS Digital Out are registered trademarks of Digital Theater Systems, Inc.

