



PLASMA TV OWNER'S MANUAL

Please read this manual carefully before operating your set.
Retain it for future reference.
Record model number and serial number of the set.
See the label attached on the back cover and quote this information to your dealer when you require service.

Model number :
Serial number :

P/NO : 3828VA0509H (RF043B, 116W/137F TX, 026H) ©

Safety Instructions

- Use the set at the place lower than the altitude of 6562 feet (2000m) to get the best quality of picture and sound.

WARNING

Do not place the set in direct sunlight or near heat sources such as heat registers, stove and so on.

- This may cause a fire.

Do not use the set in damp place such as a bathroom or any place where it is likely to get wet.

- This may cause a fire or could give an electric shock.

Bend antenna cable between inside and outside building to prevent rain from flowing in.

- This may cause water damaged inside the set and could give an electric shock.

Earth wire should be connected.

- If the earth wire is not connected, there is possible a danger of electric shock caused by the current leakage.
- If grounding methods are not possible, a separate circuit breaker should be employed and installed by a qualified electrician.

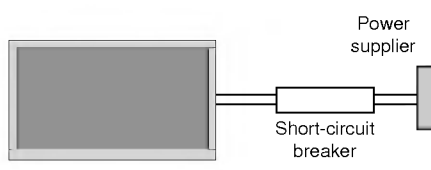

- Do not connect ground to telephone wires, lightning rods or gas pipe.

Do not place anything containing liquid on top of the set.

- This may cause a fire or could give an electric shock.

Do not insert any object into the exhaust vent.

- This may cause a fire or could give an electric shock.

Do not place heavy objects on the set.

- This may cause serious injury to a child or adult.

WARNING in U.K. only

* This set is supplied with a BS 1363 approved 13 amp mains plug, fused at 13 amp. When replacing the fuse always use a 13 amp BS 1362, BSI or ASTA approved type. Never use this plug with the fuse cover omitted. To obtain a replacement fuse cover contact your dealer or "LG Electronics U.K. Ltd." If the type of plug supplied is not suitable for the mains sockets in your home, then the plug should be removed and a suitable type fitted.

A mains plug removed from the mains lead of this set must be destroyed. A mains plug with bared wires is hazardous if inserted in a mains socket. Do not connect either wire to the earth pin, marked with the letter E or with the earth symbol  or coloured green or green and yellow. If any other plug is fitted, use a 13 amp fuse, either in the plug, or at the distribution board.

The wires in this mains lead are coloured in accordance with the following codes: BLUE: NEUTRAL, BROWN: LIVE. As the colours of the wires in the mains lead of this set may not correspond with the coloured marking identifying the terminals in your plug, proceed as follows: The wire which is coloured blue must be connected to the terminal which is marked with the letter N or coloured black. The wire which is coloured brown must be connected to the terminal which is marked with the letter L or coloured red.

* Safety instructions have two kinds of information, and each meaning of it is as below.

⚠ WARNING The violation of this instruction may cause serious injuries and even death.

⚠ NOTES The violation of this instruction may cause light injuries or damage of the product.

⚠ Take care of danger that may happen under specific condition.

⚠ NOTES

Never touch the power plug with a wet hand.

- This may cause an electric shock.

Disconnect from the mains and remove all connections before moving.

Do not place the set in a built-in installation such as a bookcase or rack.

- Ventilation required.

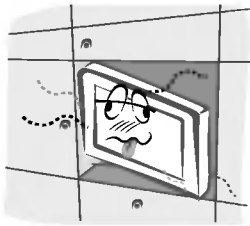

When installing the set on a table, be careful not to place the edge of its stand.

- This may cause the set to fall, causing serious injury to a child or adult, and serious damage to the set.

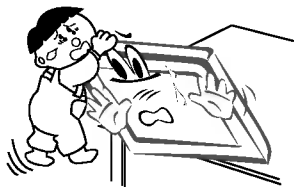

Do not place an outside antenna in the vicinity of overhead power lines or other electric light or power circuits.

- This may cause an electric shock.

There should be enough distance between an outside antenna and power lines to keep the former from touching the latter even when the antenna falls.

- This may cause an electric shock.

Do not pull the cord but the plug when unplugging.

- This may cause a fire.

Ensure the power cord doesn't trail across any hot objects like a heater.

- This may cause a fire or an electric shock.

Do not plug when the power cord or the plug is damaged or the connecting part of the power outlet is loose.

- This may cause a fire or an electric shock.

Dispose of used batteries carefully to protect a child from eating them.

- In case that it eats them, take it to see a doctor immediately.

When moving the set assembled with speakers do not carry holding the speakers.

- This may cause the set to fall, causing serious injury to a child or adult, and serious damage to the Monitor.

Unplug this product from the wall outlet before cleaning. Do not use liquid cleaners or aerosol cleaners.

- This may cause damaged the set or could give an electric shock.

Contact the service center once a year to clean the internal part of the set.

- Accumulated dust can cause mechanical failure.

The distance between eyes and the screen should be about 5 ~ 7 times as long as diagonal length of the screen.

- If not, eyes will strain.

Unplug the set from the wall outlet when it is left unattended and unused for long periods of time.

- Accumulated dust may cause a fire or an electric shock from deterioration or electric leakage.

Contents

Safety Warnings		
Safety Instructions	2~3
Introduction		
Remote Control Key Functions	6
Location and Function of Controls	7~8
Installation		
External Equipment Viewing Setups	9~12
Displayable Monitor Specification	13
Accessories	14
Installation Options	15
Operation		
Turning on the Set	16
On-Screen Menu Language Selection (option)	16
Channel Menu Options		
Auto Programme Tuning	17
Manual Programme Tuning	17
Fine Tuning	18
Assigning a Station Name	18
Booster (option)	18
Programme Edit	19
Favourite Programme	19
Calling the Programme Table	19
Picture Menu Options		
PSM (Picture Status Memory)	20
XD	20
Adjusting Auto Colour Control	20
Manual Colour Temperature Control (User option)	20
sRGB (RGB[PC], DVI[PC] mode only)	21
Fleshtone	21
Manual Picture Control (User option)	21
Sound Menu Options		
SSM (Sound Status Memory)	22
BBE	22
AVL (Auto Volume Leveler)	22
Adjusting Sound Control (User option)	22
Stereo/Dual Reception	23
NICAM Reception (option)	23
Time Menu Options		
Setting the Clock	24
Setting the On/Off Timer	24
Auto Sleep	24
Sleep Timer	24
Special Menu Options		
Child Lock	25
ISM (Image Sticking Minimization) Method	25
Low Power	26
XD Demo	26
LED DISPLAY adjustment	26
Screen Menu Options		
Auto adjustment (RGB [PC] mode only)	27
Setting Picture Format	27
Screen Position	27
Manual Configure (RGB [PC] mode only)	28
Selecting Wide VGA/XGA mode (RGB [PC] mode only)	28
Screen Adjustments	28
Cinema	28
Luminance Noise Reduction (option)	29
Initializing (Reset to original factory value)	29
Split Zoom	29
PIP (Picture In Picture) Feature		
Watching PIP	30
Programme Selection for Sub Picture	30
Selecting an Input Signal Source for the PIP	30
Moving the PIP (PIP mode only)	30
Picture Size	30
Adjusting PIP Transparency (PIP mode only)	30
Teletext (option)		
Switch on/off	31
SIMPLE Text (option)	31
TOP Text (option)	31
FASTEXT	32
Special Teletext Functions	32
Miscellaneous		
External Control Device Setup	33~38
IR Code (NEC format)	39~40
Troubleshooting Checklist	42
Product Specifications	43

After reading this manual, keep it in the place where the user can always contact easily.

Introduction

What is a Plasma Display ?

If voltage is inputted to gas in glass panels, ultraviolet rays is outputted and fused with a fluorescent substance. At this moment, light is emitted. A Plasma Display is a next generation flat Display using this phenomenon.

160° - Wide angle range of vision

A Plasma Display provides more than 160° angle range of vision so that you can get a picture without distortion from any direction.

Easy installation

A Plasma Display is much lighter and smaller than other same class products so that you can install the Plasma Display at the desired place.

Big screen

The screen of a Plasma Display is 42", 50" or 60" so that you can get vivid experience as if you are in a theater.

Multimedia Plasma Display

A Plasma Display can be connected with a computer so that you can use it as a screen for conference, game, internet and so on.

The explanation about coloured dots may be present on PDP screen

The PDP which is the display device of this product is composed of 0.9 to 2.2 million cells and a few cell defects can occur in the manufacture of the PDP. Several coloured dots visible on the screen would be acceptable, in line with other PDP manufacturers and would not mean that the PDP is faulty. We hope you will understand that the product which corresponds to this standard is regarded as acceptable. It means that it could not be changed or refunded. We promise that we'll do our best to develop our technology to minimize the cell defects.

The explanation about noise of PDP

In the same way that a fan is used in a PC to keep the CPU cool, the PDP is equipped with cooling fans to improve the reliability of this product. Therefore, a certain level of noise could occur when the fan is operated. This noise doesn't have any negative effect on its efficiency and liability and it's also determined to have no difficulty while using this product. The noise from the fans is normal in the operation of this product. We hope you will understand that a certain level of noise is acceptable. It means that it is not changeable nor refundable.

WARNING

This is Class B product. In a domestic environment this product may cause radio interference in which case the user may be required to take adequate measures.

WARNING

TO REDUCE THE RISK OF FIRE AND ELECTRIC SHOCK, DO NOT EXPOSE THIS PRODUCT TO RAIN OR MOISTURE.

Remote Control Key Functions

- When using the remote control aim it at the remote control sensor of the set.
- There's maybe a defect in consecutive operation of remote control in specified brightness according to this set feature.

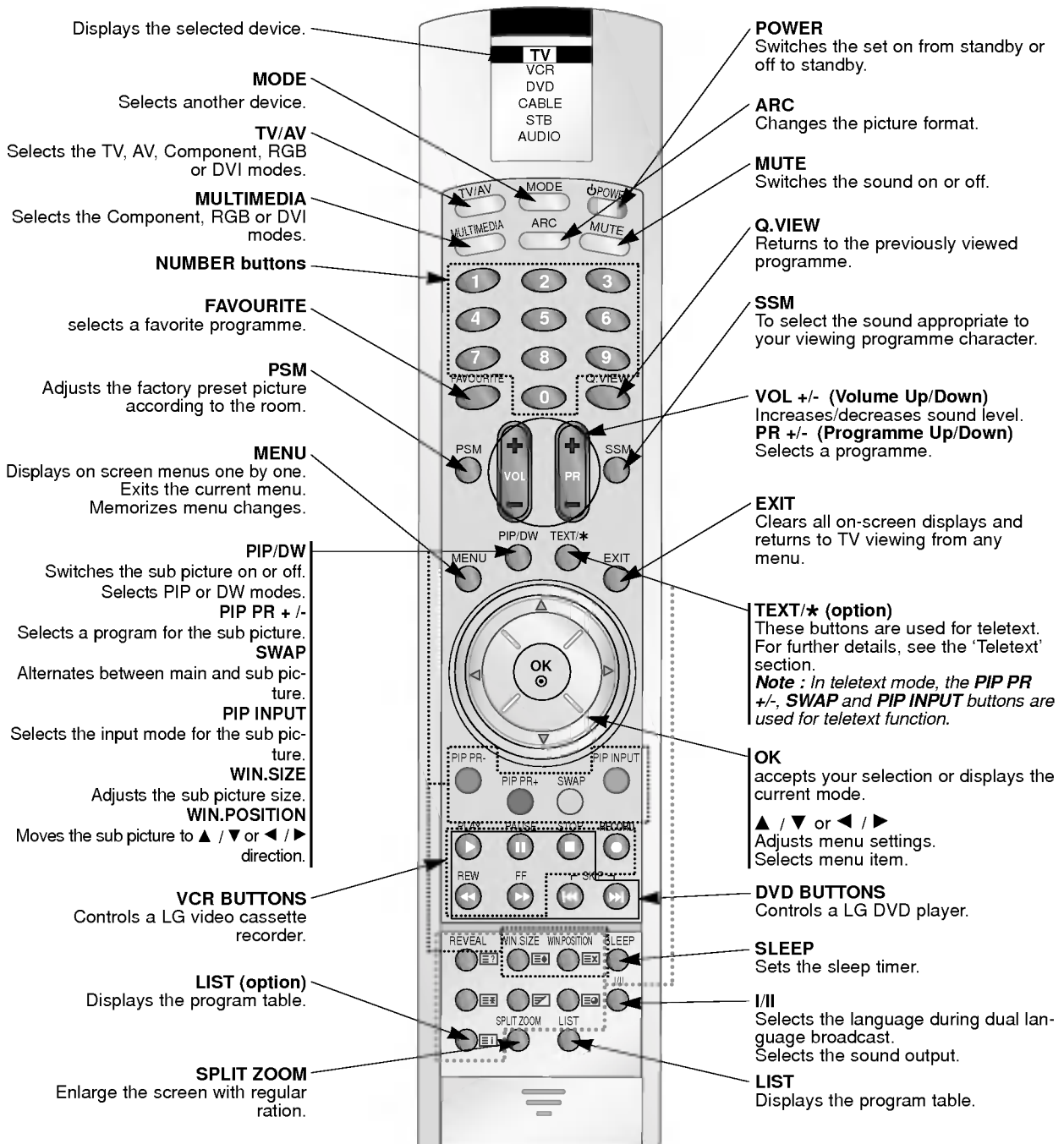

Installing Batteries



- Open the battery compartment cover on the back side and insert the batteries with correct polarity.
- Install two 1.5V alkaline batteries of AA type. Don't mix used batteries with new batteries.

Location and Function of Controls

<Front Panel Controls>

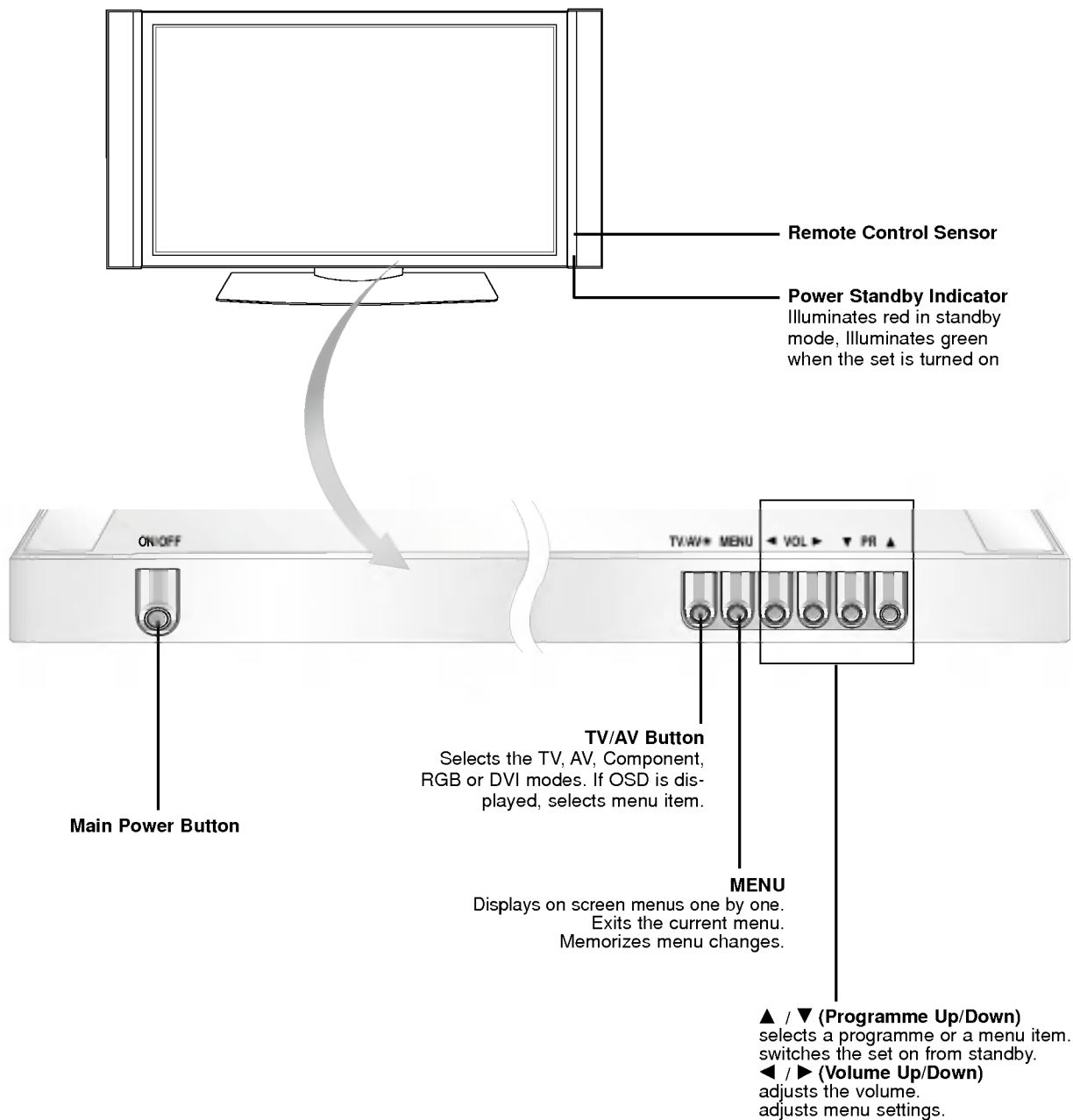

Location and Function of Controls

- Shown is a simplified representation of the set.
- Here shown may be somewhat different from your set.
- This manual explains the features available on the RZ-42PY10/11 series.

<Back Panel>

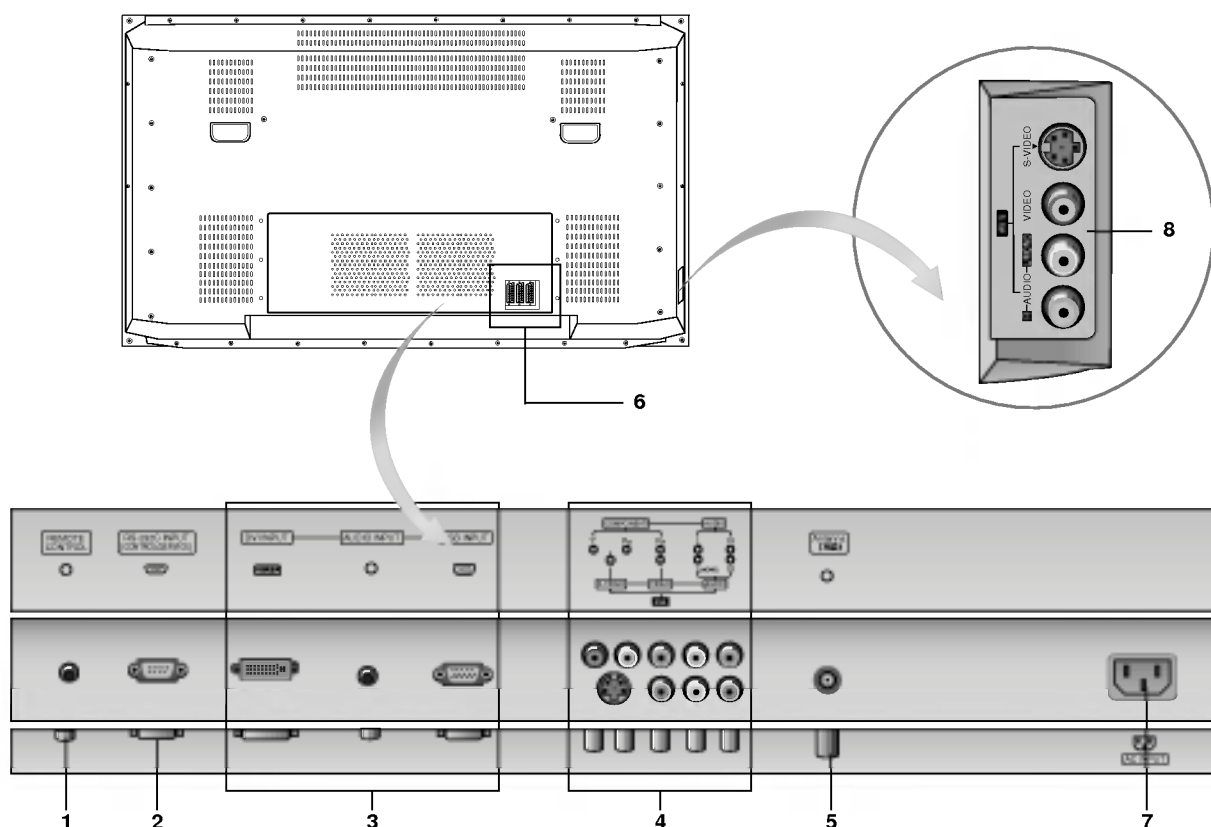

1. REMOTE CONTROL

2. RS-232C INPUT (CONTROL/SERVICE) PORT
Connect to the RS-232C port on a PC.

3. DVI INPUT / AUDIO INPUT / RGB INPUT
Connect the monitor output socket of the PERSONAL COMPUTER to this socket.
Note: If you want to use RGB/DVI audio, we strongly recommend that you use the cable that has a core, or the EMI Filter core along with separate cable.

4. COMPONENT INPUT
Connect DVD video outputs to Y, P_B, P_R of COMPONENT INPUT and audio outputs to Audio sockets of AUDIO INPUT.

AUDIO/VIDEO IN SOCKETS (AV4)
Connect the audio/video out sockets of external equipment to these sockets.

S-VIDEO/AUDIO IN SOCKETS
Connect the S-VIDEO out socket of an VCR to the **S-VIDEO** socket.
Connect the audio out sockets of the VCR to the audio sockets as in **AV4**.

5. ANTENNA INPUT

6. EURO SCART SOCKET
Connect the euro scart socket of the VCR to these sockets.

7. POWER CORD SOCKET
This Monitor operates on an AC power. The voltage is indicated on the Specifications page. Never attempt to operate the Monitor on DC power.

**8. AUDIO/VIDEO IN SOCKETS (AV5)
S-VIDEO/AUDIO IN SOCKETS**

External Equipment Viewing Setups

Antenna Connection

- Be careful for the bronze wire not to be bended in connecting to antenna input port.

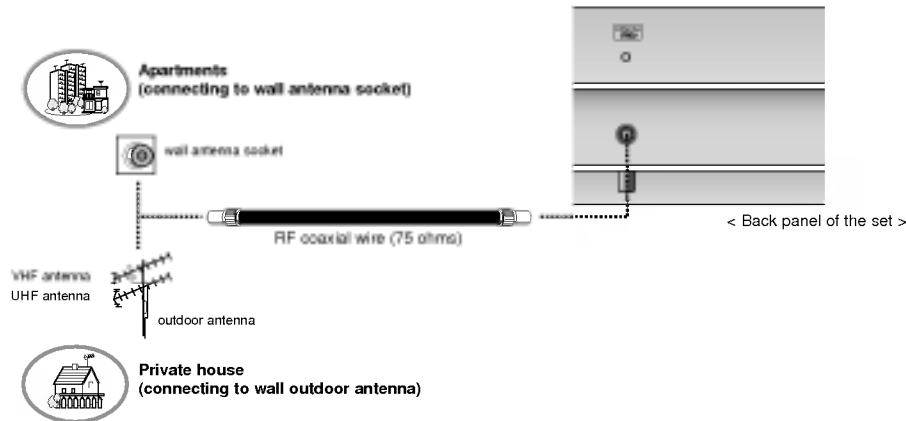

Watching VCR

- When connecting the set to external equipment, match the colours of connecting ports (Video - yellow, Audio (L) - white, Audio (R) - red).
- Connect the VIDEO INPUT socket (yellow) to the VIDEO INPUT on the set.
- If you have a mono VCR, connect the audio cable from the VCR to the AUDIO (L/MONO) input on the set.
- If you connect an S-VIDEO VCR to the S-VIDEO input, the picture quality is improved; compared to connecting a regular VCR to the Video input.
Or, connect the Euro scart socket of the VCR to the Euro scart socket of the set.
- Use the orbiter function to Avoid having a fixed image remain on the screen for a long period of time. Typically a frozen still picture from a VCR. (Refer to p. 25)
If a 4:3 picture format is used; the fixed image may remain visible on the screen.
- To avoid picture noise (interference), leave an adequate distance between the VCR and set.

Watching TV programmes

- Turn the set on and select the programme you want.

Watching VCR

1. Use the **TV/AV** button on the remote control to select **AV1**, **AV2**, **AV3**, **AV4** or **AV5**.
- If both S-VIDEO and VIDEO sockets have been connected to the S-VHS VCR simultaneously, only the S-VIDEO can be received.
2. Insert a video tape into the VCR and press the **PLAY** button on the VCR.
(See VCR owner's manual)

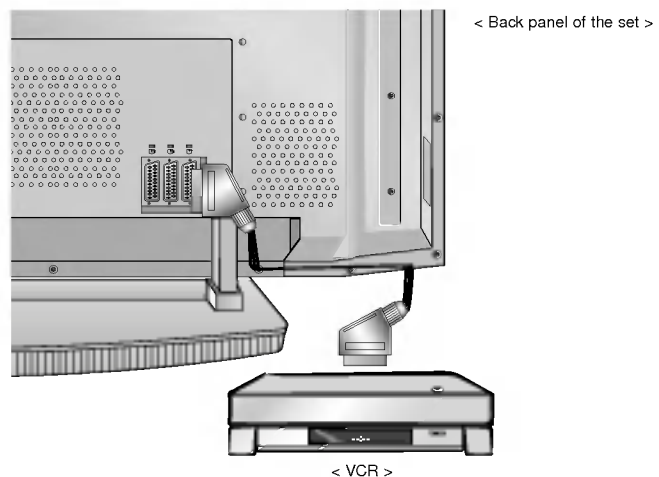

External Equipment Viewing Setups

Watching Cable TV

- After subscribing for a local cable TV station and installing a converter you can watch cable TV.
- For further information of cable TV, contact the local cable TV station.

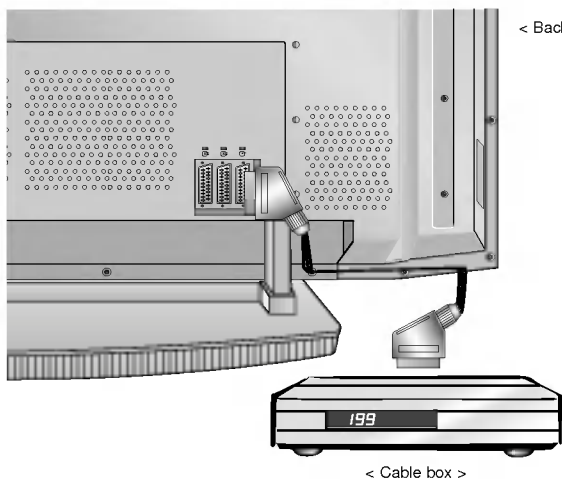

To watch cable TV

1. Use the **TV/AV** button on the remote control to select **AV1, AV2, AV3, AV4** or **AV5**.
2. Tune to cable service provided channels using the cable box.

Watching external AV source

- When connecting the set to an external source, match the colours of AUDIO/VIDEO input jacks on the set with the output jacks on the audio/video equipment: Video = yellow, Audio (Left) = white, Audio (Right) = red.
Or, connect the Euro scart socket of the VCR to the Euro scart socket of the set.

How to use

1. Use the **TV/AV** button on the remote control to select **AV1, AV2, AV3, AV4** or **AV5**.
2. Operate the corresponding external equipment.
See external equipment operating guide.

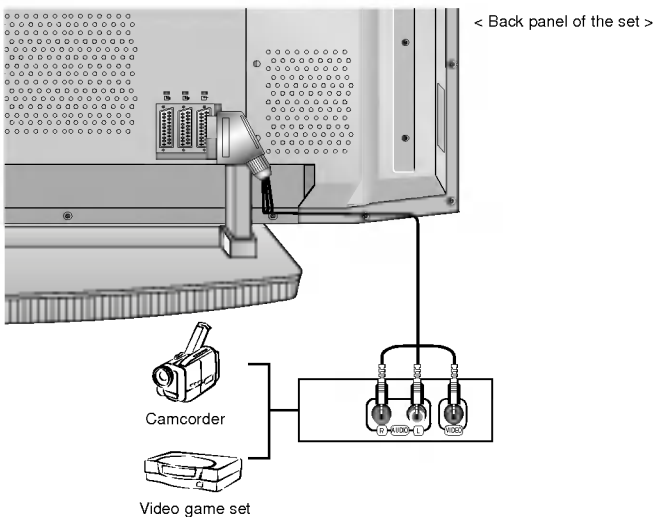

Watching DVD

How to connect

Connect DVD video outputs to Y, P_B, P_R of COMPONENT INPUT and audio outputs to Audio sockets of AUDIO INPUT.

How to use

1. Turn on the DVD player, and insert a DVD.
2. Use **TV/AV** or **MULTIMEDIA** button on the remote control to select **Component**. Refer to the DVD player's manual for operating instructions.

- **Component Input ports**

You can get better picture quality if you connect DVD player with component input ports as below.

Component ports of the set	Y	P _B	P _R
Video output ports of DVD player	Y	P _b	P _r
	Y	B-Y	R-Y
	Y	C _b	C _r
	Y	P _B	P _R

< Back panel of the set >

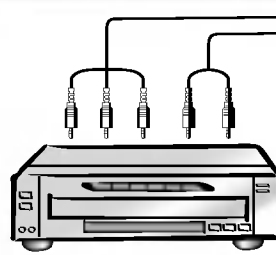
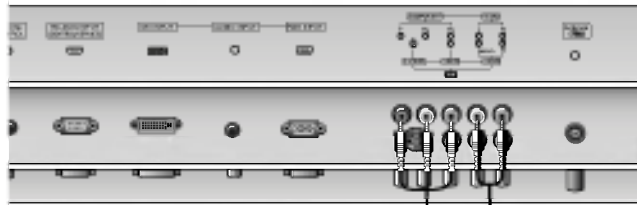

< DVD player >

External Equipment Viewing Setups

Connecting PC

- To enjoy vivid picture and sound, connect a PC to the set.
- Avoid keeping a fixed image on the set's screen for a long period of time. The fixed image may become permanently imprinted on the screen; use a screen saver when possible.
- Connect PC to the RGB INPUT(PC INPUT) or DVI INPUT(DIGITAL RGB INPUT) port of the set; change the resolution output of PC accordingly.
- There might be a noise according to some resolution, vertical pattern, contrast or brightness in PC mode. Then change the PC mode into other resolution or change the refresh rate into other rate or adjust the brightness and contrast on the menu until the picture is clean. If the refresh rate of the PC graphic card can not be changed, change the PC graphic card or consult it to the manufacturer of the PC graphic card.
- The synchronization input form for Horizontal and Vertical frequencies is separate.

Setup Instructions to Connect a PC to your set

- We recommend using 1024x768, 60Hz for the PC mode, they provide the best picture quality.
 - If the resolution of PC is over UXGA, there will be no picture on the set.
 - Connect the signal cable from the monitor output port of the PC to the RGB INPUT port of the set or the signal cable from the DVI output port of the PC to the DVI INPUT port on the set.
 - Connect the audio cable from the PC to the Audio input on the set. (Audio cables are not included with the set).
 - If using a sound card, adjust PC sound as required.
 - This set apply a VESA Plug and Play Solution. The set provides EDID data to the PC system with a DDC protocol. The PC adjusts automatically to use this set.
 - DDC protocol is preset for RGB (Analog RGB), DVI (Digital RGB) mode.
 - If required, adjust the set settings for Plug and Play functionally.
 - If graphic card on the PC does not output analog and digital RGB simultaneously, connect only one of both RGB INPUT or DVI INPUT to display the PC on the set.
- If graphic card on the PC does output analog and digital RGB simultaneously, set the set to either RGB or DVI; (the other mode is set to Plug and Play automatically by the set.)
- DOS mode may not work depending on video card if using a DVI-I cable.

< Back panel of the set >

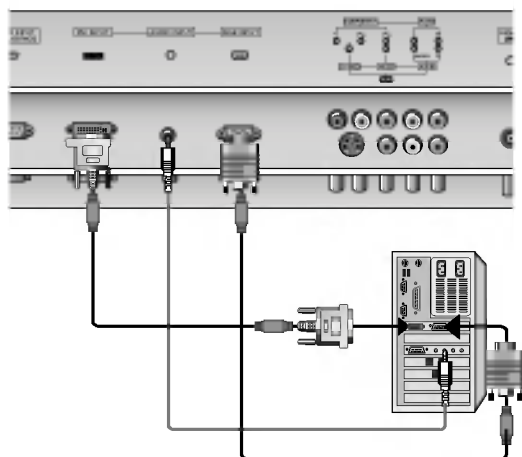

PC Setup

1. Turn on the PC and apply power to the set.
2. Turn on the display by pressing the **POWER** button on the set's remote control.
3. Use the **TV/AV** or **MULTIMEDIA** button on the remote control to select the **RGB** or **DVI** input source.
4. Set the resolution output of the PC to SXGA or under (1280 x 1024, 60Hz). (Refer to p. 13)

Displayable Monitor Specification

RGB / DVI mode

Resolution	Horizontal Frequency(KHz)	Vertical Frequency(Hz)
640x350	31.468	70.09
	37.861	85.08
720x400	31.469	70.08
	37.927	85.03
640x480	31.469	59.94
	35.000	66.66
	37.861	72.80
	37.500	75.00
848x480	43.269	85.00
	31.500	60.00
	37.799	70.00
852x480	39.375	75.00
	31.500	60.00
800x600	37.799	70.00
	39.375	75.00
	35.156	56.25
	37.879	60.31
832x624	48.077	72.18
	46.875	75.00
	53.674	85.06
1024x768	49.725	74.55
	48.363	60.00
	56.476	70.06
	60.023	75.02
1360x768	68.677	85.00
	47.700	60.00
1366x768	59.625	75.02
	47.700	60.00
1152x864 (RGB)	59.625	75.02
	54.348	60.05
	63.995	70.01
	67.500	75.00
1152x870 (RGB)	77.487	85.00
1280x768	68.681	75.06
	47.693	60.00
	60.091	75.00
1280x960 (RGB)	68.504	85.00
	60.023	60.02
1280x1024 (RGB)	63.981	60.02

RZ-42PY10X/11X series

RGB / DVI mode

Resolution	Horizontal Frequency(KHz)	Vertical Frequency(Hz)
640x350	31.468	70.09
	37.861	85.08
720x400	31.469	70.08
	37.927	85.03
640x480	31.469	59.94
	35.000	66.66
	37.861	72.80
	37.500	75.00
848x480	43.269	85.00
	31.500	60.00
	37.799	70.00
852x480	39.375	75.00
	31.500	60.00
800x600	37.799	70.00
	39.375	75.00
	35.156	56.25 (RGB)
	37.879	60.31
832x624	48.077	72.18
	46.875	75.00
	53.674	85.06
1024x768	49.725	74.55
	48.363	60.00
	56.476	70.06
	60.023	75.02
1360x768	68.677	85.00
	47.700	60.00
1366x768	59.625	75.02
	47.700	60.00
1152x864	59.625	75.02
	69.500	85.00
	54.348	60.05
	63.995	70.01
1152x870	67.500	75.00
	77.487	85.00
	68.681	75.06
1280x768	47.693	60.00
	60.091	75.00
	68.504	85.00
1280x960	60.023	60.02
1280x1024	63.981	60.02

RZ-50/60PY10/11 series

Accessories

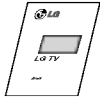

Owner's Manual

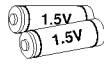

Alkaline batteries



Remote Control handset



Power Cord



2-TV bracket bolts
(or RZ-50PY10 series: 4-TV
bracket bolts)
(Only RZ-60PY10/11 series : 6-
Wall mounting bracket bolts)



2-TV brackets
2-Wall brackets (optional)



6-RING SPACER
(Only RZ-60PY10/11 series)

Joining the TV assembly to the wall to protect the set tumbling

- Secure the TV assembly by joining it to a wall by using the TV/Wall brackets.

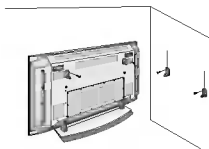

- After the set must be mounted on a desk top, install the TV brackets on the TV as shown. Insert the 2 bolts and tighten securely, in the holes on the bracket.
(Only RZ-50PY10 series: After removing the existing bolts, insert the 4 bolts and tighten securely, in the holes on the bracket.)
Install the wall brackets on the wall with 4 bolts, (not supplied with the product), as shown. Match the height of the TV brackets and the wall brackets.
Check to be sure the brackets are tightened securely.

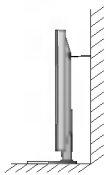

- Secure the TV assembly to the wall with strong strings or wound wire cables, (not supplied with the product), as shown.

Optional Extras

- Optional extras can be changed or modified for quality improvement without any notification new optional extras can be added.
- Contract your dealer for buying these items.



Tilt wall mounting bracket

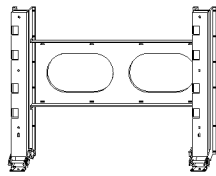

Wall mounting bracket
(Only RZ-60PY10/11 series)

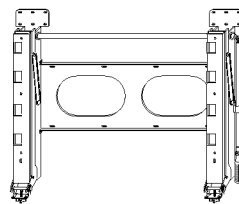

Tilt wall mounting bracket
(Only RZ-60PY10/11 series)



Ceiling mounting bracket

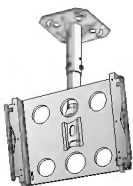

Ceiling mounting bracket

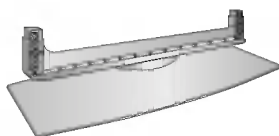

Desktop stand (optional)



Video cables



Audio cables

Installation Options

- The set can be installed in different ways such as on a wall, or on a desktop etc.

Desktop Pedestal Installation

- The set can be mounted on a desk as shown above. (For further information, refer to the optional 'Desktop Stand Installation and Setup Guide'.)
- Speakers and speaker stands shown are optional, and are shown for example only.

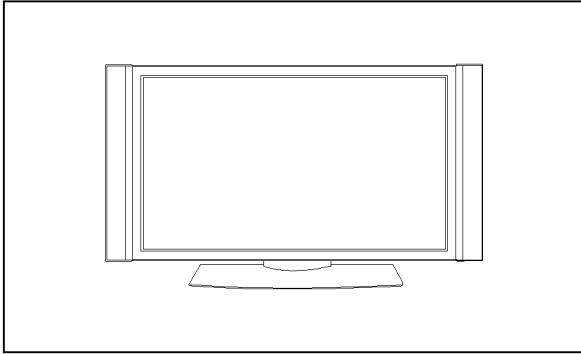

To Install on a Desktop

Pedestal mount minimum allowable clearances for adequate ventilation.

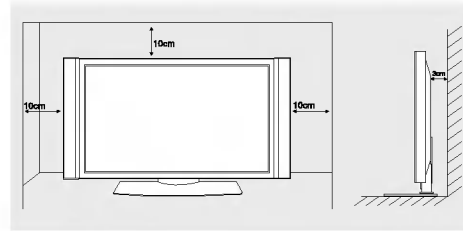

Wall Mount: Horizontal Installation

- The set can be installed on a wall as shown above. (For further information, refer to the optional 'Wall Mounting Bracket Installation and Setup Guide'.)
- Speakers are optional, and are shown for illustration only.

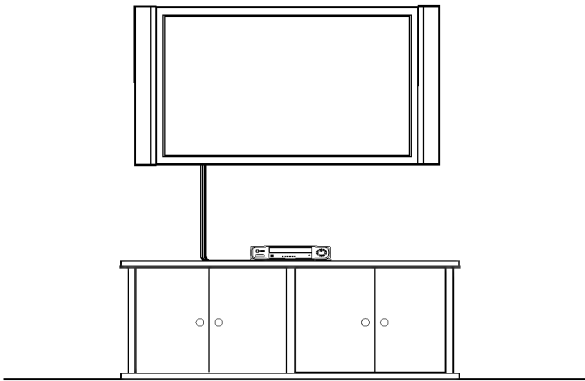

To Mount on a Wall

Wall mount minimum allowable clearances for adequate ventilation.

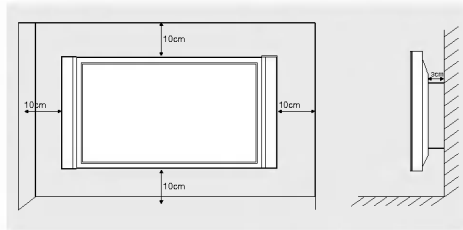

- Install the RING SPACER with the bolts on the set as shown.** (Only RZ-60PY10/11 series)

- Put the RING SPACER in the holes of the bolts before connecting to the wall mounting bracket.
- When you connect the wall mounting bracket to the set, connect to it by using the bolts, (supplied with the product), as shown.

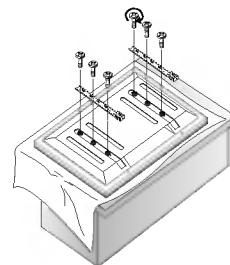
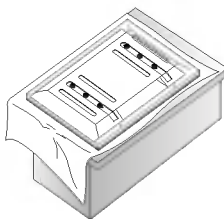

Turning on the Set

- When using the remote control, aim it at its sensor on the set.

Turning on the set just after installation

1. Connect power cord correctly.
2. Press the **⓪ ON/OFF** button on the set. At this moment, the set is switched to standby mode. Press the **TV/AV** or **PR ▲ / ▼** button on the set or press the **POWER, TV/AV, MULTIMEDIA, PR+/-** or **NUMBER** buttons on the remote control and then the set will switch on.

Turning on the set (power cord is still connected)

1. If the set was turned off with the **⓪ ON/OFF** button on the set
 - Press the **⓪ ON/OFF** button on the set to turn the set on.
2. If the set was turned off with the remote control and the **⓪ ON/OFF** button on the set
 - Press the **⓪ ON/OFF** button on the set and then press the **TV/AV** or **PR ▲ / ▼** button on the set or press the **POWER, TV/AV, MULTIMEDIA, PR+/-** or **NUMBER** button on the remote control to turn the set on.

On-Screen Menu Language Selection (option)

- The menus can be shown on the screen in the selected language. First select your language.
 1. Press the **MENU** button and then use **▲ / ▼** button to select the **SPECIAL** menu.
 2. Press the **▶** button and then use **▲ / ▼** button to select **Language**.
 3. Press the **▶** button and then use **▲ / ▼** button to select your desired language.
From this point on, the on-screen menus will be shown in the language of your choice.
 4. Repeatedly press the **MENU** button to return to normal TV viewing.

Channel Menu Options

Auto Programme Tuning

- All stations that can be received are stored by this method. It is recommended that you use auto programme during installation of this set.

1. Press the **MENU** button and then use **▲ / ▼** button to select the **STATION** menu.
2. Press the **▶** button and then **▲ / ▼** button to select **Auto programme**.
3. Press the **▶** button to select **System**. Select a TV system with the **◀ / ▶** button;
 - L** : SECAM L/L'
 - BG** : PAL B/G, SECAM B/G (Europe / East Europe / Asia / New Zealand / M.East / Africa / Australia)
 - I** : PAL I/II (U.K. / Ireland / Hong Kong / South Africa)
 - DK** : PAL D/K, SECAM D/K (East Europe / China / Africa / CIS)
 - M** : (USA / Korea / Philippines) (option)
4. Press the **▼** button to select **Storage from**. Select the beginning programme number with the **◀ / ▶** button or **NUMBER** buttons on the **Storage from** menu.
5. Press the **▼** button to select **Start**.
6. Press the **▶** button to begin auto programming.
All receivable stations are stored.

Note :

- a. In some models, the station name is stored for stations which broadcast VPS (Video Programme Service), PDC (Programme Delivery Control) or TELETEXT data. If no station name can be assigned to a station, the channel number is assigned and stored as **C** (V/UHF 01-69) or **S** (Cable 01-47), followed by a number.
- b. In Australia, if no station name can be assigned to a station, the channel number is assigned and stored as ----- followed by a number see 'Assigning a station name' section to assign the station name.

To stop auto programming, press the **MENU** button.

When auto programming is completed, the **Programme edit** menu appears on the screen. See the 'Programme edit' section to edit the stored programme.

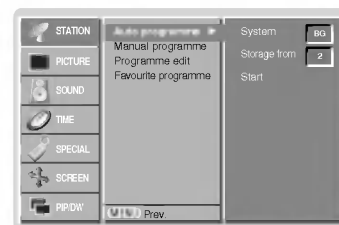

Manual Programme Tuning

- Manual programme lets you manually tune and arrange the stations in whatever order you desire. Also you can assign a station name with five characters to each programme number.

1. Press the **MENU** button and then use **▲ / ▼** button to select the **STATION** menu.
2. Press the **▶** button and then **▲ / ▼** button to select **Manual Programme**.
3. Press the **▶** button to select **Storage**. Select the desired programme number with the **◀ / ▶** button or **NUMBER** buttons on the **Storage** menu.
4. Press the **▼** button to select **System**. Select a TV system with the **◀ / ▶** button;
 - L** : SECAM L/L'
 - BG** : PAL B/G, SECAM B/G (Europe / East Europe / Asia / New Zealand / M.East / Africa / Australia)
 - I** : PAL I/II (U.K. / Ireland / Hong Kong / South Africa)
 - DK** : PAL D/K, SECAM D/K (East Europe / China / Africa / CIS)
 - M** : (USA / Korea / Philippines) (option)
5. Press the **▼** button to select **Band**. Press the **◀ / ▶** button to select **V/UHF** or **Cable** as required.
6. Press the **▼** button to select **Channel**. You can select the desired channel number with the **◀ / ▶** button or **NUMBER** buttons. If possible, select the channel number directly with the number buttons.
7. Press the **▼** button to select **Search**. Press the **◀ / ▶** button to commence searching. If a station is found the search will stop.
8. Press the **OK** button to store it.
9. To store another station, repeat steps 3 to 8.

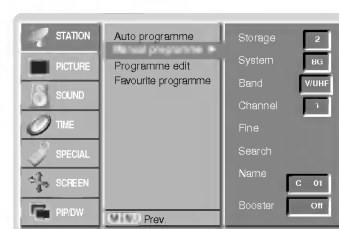

Channel Menu Options

Fine Tuning

- Normally fine tuning is only necessary if reception is poor.
- 1. Repeat the 'Manual programme tuning' steps 1 to 2.
- 2. Press the ► button and then ▲ / ▼ button to select **Fine**.
- 3. Press the ◀ / ▶ button to fine tune for the best picture and sound.
- 4. Press the **OK** button.
- 5. Repeatedly press the **MENU** button to return to normal TV viewing.
The finely tuned programme will be indicated by yellow number during programme selection.

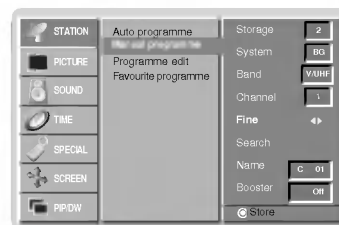

Assigning a Station Name

1. Repeat the 'Manual programme tuning' steps 1 to 2.
2. Press the ► button and then ▲ / ▼ button to select **Name**.
3. Press the ► button to display the **Name** menu.
4. Press the ▲ button. You can use a blank, +, -, the alphabet **A** to **Z** and the numeric **0** to **9**.
With the ▼ button you can select in the opposite direction.
5. Select the next position by pressing the ► button and then take your choice of the second character, and so on.
6. Press the **OK** button in twice.
7. Repeatedly press the **MENU** button to return to normal TV viewing.

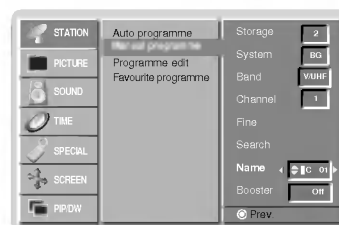

Booster (option)

In some models, **Booster** is an optional function. Only a set with **Booster** can perform this function. If the reception is poor at the fringe area of TV signal, select **Booster** to **On**.

1. Repeat the 'Manual programme tuning' steps 1 to 2.
2. Press the ► button and then ▲ / ▼ button to select **Booster**.
3. Press the ◀ / ▶ button to select **On** or **Off**.
4. Press the **OK** button.
5. Repeatedly press the **MENU** button to return to normal TV viewing.

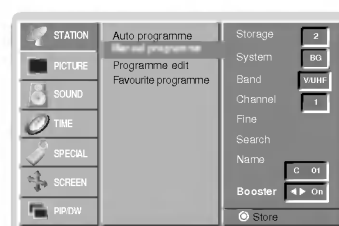

Programme Edit

- This function enables you to delete or skip the stored programmes. Also you can move some stations to other programme numbers or copy a blank station data into the selected programme number.

1. Press the **MENU** button and then use **▲ / ▼** button to select the STATION menu.
2. Press the **▶** button and then **▲ / ▼** button to select **Programme edit**.
3. Press the **▶** button to display the **Programme edit** menu.

Deleting a programme

1. Select a programme to be deleted with the **▲ / ▼** or **◀ / ▶** button.
2. Press the **RED** button twice.
The selected programme is deleted, all the following programmes are shifted up one position.

Copying a programme

1. Select a programme to be copied with the **▲ / ▼** or **◀ / ▶** button.
2. Press the **GREEN** button.
All the following programmes are shifted down one position.

Moving a programme

1. Select a programme to be moved with the **▲ / ▼** or **◀ / ▶** button.
2. Press the **YELLOW** button.
3. Move the programme to the desired programme number with the **▲ / ▼** or **◀ / ▶** button.
4. Press the **YELLOW** button again to release this function.

Skipping a programme number

1. Select a programme number to be skipped with the **▲ / ▼** or **◀ / ▶** button.
2. Press the **BLUE** button. The skipped programme turns to blue.
3. Press the **BLUE** button again to release the skipped programme.
When a programme number is skipped it means that you will be unable to select it using the **▲ / ▼** button during normal TV viewing. If you want to select the skipped programme, directly enter the programme number with the NUMBER buttons or select it in the programme edit or table menu.

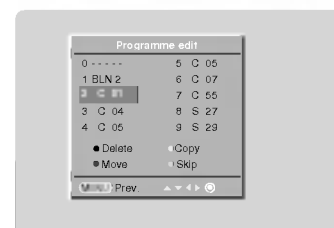

Favourite Programme

- This function lets you select your favourite programmes directly.

1. Press the **MENU** button and then use **▲ / ▼** button to select the STATION menu.
2. Press the **▶** button and then **▲ / ▼** button to select **Favourite programme**.
3. Press the **▶** button to display the **Favourite programme** menu.
4. Press the **▲ / ▼** button to select -- -----.
5. Select a desired programme with the **◀ / ▶** button or NUMBER buttons. Any number under 10 is entered with a numeric '0' in front of it, i.e. '05' for 5.
6. To store another programme, repeat steps 4 to 5.
You can store up to 8 programmes.
7. Press the **OK** button.

Repeatedly press the **FAVOURITE** button to select stored favorite programmes.



Calling the Programme Table

- You can check the programmes stored in the memory by displaying the programme table.

Displaying programme table

Press the **LIST** button to display the Programme table menu.
The programme table appears on the screen.

- You may find some blue highlighted programmes shown. They have been set up in the programme edit mode.
- Some programmes with the channel number shown in the programme table indicate there is no station name assigned.

Selecting a programme in the programme table

Select a programme with the **▲ / ▼** or **◀ / ▶** button.
Then press the **OK** button.
The Plasma Display switches to the chosen programme number.

Paging through a programme table

There are 10 programme table pages in which contain 100 programmes.
Pressing the **▲ / ▼** or **◀ / ▶** button repeatedly turns the pages.

Press the **LIST** button to return to normal TV viewing.

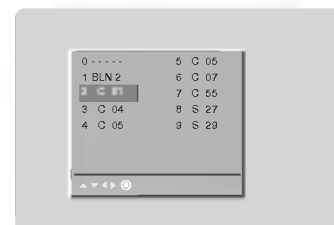

Picture Menu Options

PSM (Picture Status Memory)

- This function adjusts the set to the best picture appearance.
- When adjusting picture options (contrast, brightness, colour, sharpness and tint (NTSC input only)) manually, PSM is automatically changed to **User**.

1. Press the **PSM** button

- Each press of the **PSM** button changes the screen display as shown below.

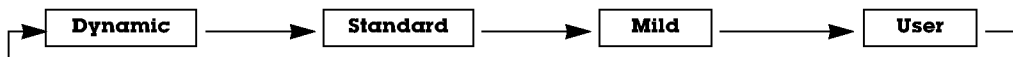

- You can also select **Dynamic**, **Standard**, **Mild** or **User** in the PICTURE menu.
- Picture options **Dynamic**, **Standard** and **Mild** are preset and programmed for good picture quality at the factory and cannot be changed.

XD

- You can enjoy the vivid and hi-definition picture with LG's excellent Digital Reality processor technology.
- When selecting picture options (**Dynamic**, **Standard** and **Mild**) in PICTURE manu, **XD** is automatically changed to **On**.

1. Press the **MENU** button and then use **▲ / ▼** button to select the PICTURE menu.

2. Press the **▶** button and then use **▲ / ▼** button to select **XD**.

3. Press the **▶** button and then use **▲ / ▼** button to select **On** or **Off**.

4. Repeatedly press the **MENU** button to return to normal TV viewing.



Adjusting Auto Colour Control

- To initialize values (reset to default settings), select the **Normal** option.

1. Press the **MENU** button and then use **▲ / ▼** button to select the PICTURE menu.

2. Press the **▶** button and then use **▲ / ▼** button to select **CSM**.

3. Press the **▶** button and then use **▲ / ▼** button to select the desired colour temperature.

4. Repeatedly press the **MENU** button to return to normal TV viewing.

- Each press of **▲ / ▼** button changes the screen display as shown below.

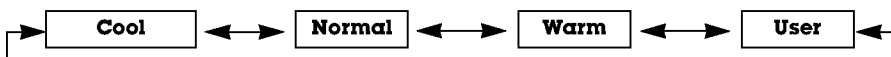

Manual Colour Temperature Control (User option)

- You can adjust red, green, or blue to any colour temperature you prefer.

1. Press the **MENU** button and then use **▲ / ▼** button to select the PICTURE menu.

2. Press the **▶** button and then use **▲ / ▼** button to select **CSM**.

3. Press the **▶** button and then use **▲ / ▼** button to select **User**.

4. Press the **▶** button and then use **▲ / ▼ / ◀ / ▶** button to make appropriate adjustments.

- The adjustment range of **Red**, **Green** and **Blue** is -30~+30.

5. Repeatedly press the **MENU** button to return to normal TV viewing.

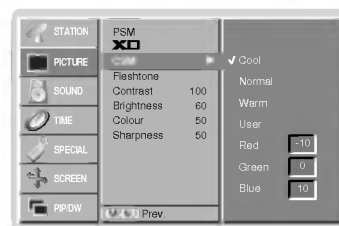

sRGB (RGB[PC], DVI[PC] mode only)

- When the set was connected to external equipment with sRGB function, It's adjusted a colour difference to display the equal image each other.
1. Press the **MENU** button and then use ▲ / ▼ button to select the PICTURE menu.
 2. Press the ► button and then use ▲ / ▼ button to select **sRGB**.
 3. Press the ► button and then use ▲ / ▼ button to select **On** or **Off**.
 4. Repeatedly press the **MENU** button to return to normal TV viewing.

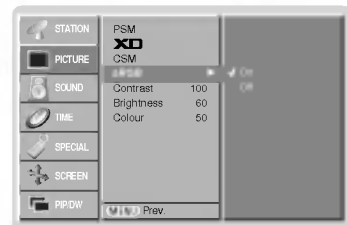
**Fleshtone**

- Adjust the **Fleshtone** to select the desired skin colour option.
 - This function works in the following mode:
TV, AV1, AV2, AV3, AV4, AV5 or COMPONENT 480i/480p/576i/576p/720p/1080i.
1. Press the **MENU** button and then use ▲ / ▼ button to select the PICTURE menu.
 2. Press the ► button and then use ▲ / ▼ button to select **Fleshtone**.
 3. Press the ► button and then use ◀ / ▶ button to make appropriate adjustments.
 - The adjustment range of **Fleshtone** is 0 ~ 3.
 4. Repeatedly press the **MENU** button to return to normal TV viewing.

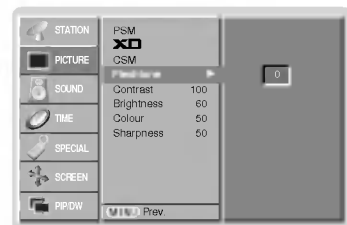
**Manual Picture Control (User option)**

- You can adjust picture contrast, brightness, colour, sharpness and tint (NTSC input only) to the levels you prefer.
- In the broadcasting system PAL/SECAM, the picture item Tint doesn't work.

1. Press the **MENU** button and then use ▲ / ▼ button to select the PICTURE menu.
2. Press the ► button and then use ▲ / ▼ button to select the desired picture option.
3. Press the ► button and then use ◀ / ▶ button to make appropriate adjustments.
4. Repeatedly press the **MENU** button to return to normal TV viewing.

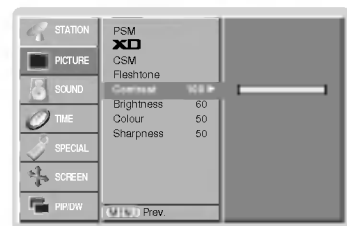

Sound Menu Options

SSM (Sound Status Memory)

- This function lets you enjoy the best sound without any special adjustment because the set automatically selects the appropriate sound option based on the program content.
- When adjusting sound options (treble and bass) manually, SSM is automatically changed to **User**.

1. Press the **SSM** button.
2. Press the **SSM** button to select your desired sound.

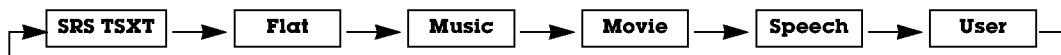

- You can also select **SRS TSXT**, **Flat**, **Music**, **Movie**, **Speech** or **User** in the SOUND menu.
- The sound **SRS TSXT**, **Flat**, **Music**, **Movie** and **Speech** are programmed for good sound reproduction at the factory and cannot be changed.

-  is a trademark of SRS Labs, Inc.
- TruSurround XT technology is incorporated under license from SRS Labs, Inc.

BBE

- BBE High Definition Sound restores clarity and presence for better speech intelligibility and musical realism.

1. Press the **MENU** button and then use **▲ / ▼** button to select the SOUND menu.
2. Press the **▶** button and then use **▲ / ▼** button to select **BBE**.
3. Press the **▶** button and then use **▲ / ▼** button to select **On** or **Off**.
4. Repeatedly press the **MENU** button to return to normal TV viewing.

BBE. Manufactured under license from BBE Sound, Inc.

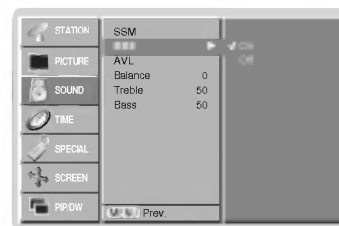

AVL (Auto Volume Leveler)

- This feature maintains an equal volume level; even if you change channels.

1. Press the **MENU** button and then use **▲ / ▼** button to select the SOUND menu.
2. Press the **▶** button and then use **▲ / ▼** button to select **AVL**.
3. Press the **▶** button and then use **▲ / ▼** button to select **On** or **Off**.
4. Repeatedly press the **MENU** button to return to normal TV viewing.



Adjusting Sound Control (User option)

1. Press the **MENU** button and then use **▲ / ▼** button to select the SOUND menu.
2. Press the **▶** button and then use **▲ / ▼** button to select the desired sound item.
3. Press the **▶** button and then use **◀ / ▶** button to make appropriate adjustments.
4. Repeatedly press the **MENU** button to return to normal TV viewing.

Note : Treble, Bass or BBE aren't suitable to use **SRS TSXT**.

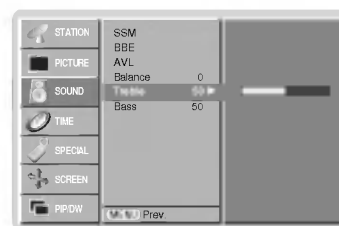

Stereo / Dual Reception

- When a programme is selected, the sound information for the station appears after the programme number and station name disappear.

On Screen Display

Press the **I/II** button to received broadcast state.

Broadcast	On screen Display
Mono	MONO
Stereo	STEREO
Dual	DUAL I

Mono Sound Selection

In stereo reception if the stereo signal is weak, you can switch to mono by pressing the **I/II** button twice. In mono reception the depth of sound is improved. To switch back to stereo, press the **I/II** button twice again.

Language Selection for Dual Language Broadcast

If a programme received in two languages (dual language), you can switch to **DUAL I**, **DUAL II** or **DUAL I + II** by pressing the **I/II** button repeatedly.

- **DUAL I** sends the primary broadcast language to the loudspeakers.
- **DUAL II** sends the secondary broadcast language to the loudspeakers.
- **DUAL I + II** sends a separate language to each loudspeaker.

NICAM Reception (option)

- If your Plasma Display is equipped with the PDP Tuner for NICAM reception, the high quality NICAM (Near Instantaneous Companding Audio Multiplex) digital sound can be received.

Sound output can be selected according to the type of received broadcast as follows by pressing the **I/II** button repeatedly.

- When NICAM mono is received, you can select **NICAM MONO** or FM MONO.
- When NICAM stereo is received, you can select **NICAM STEREO** or FM MONO. If the stereo signal is weak, switch to FM mono.
- When NICAM dual is received, you can select **NICAM DUAL I**, **NICAM DUAL II**, **NICAM DUAL I + II**, or **MONO**. When FM mono is selected the display **MONO** appears on the screen.

Sound output selection

In AV, Component, RGB or DVI mode, you can select output sound for the left and right loudspeakers.

Repeatedly press the **I/II** button to select the sound output.

- **L+R** : Audio signal from audio L input is sent to left loud-speaker and audio signal from audio R input is sent to right loud-speaker.
- **L+L** : Audio signal from audio L input is sent to left and right loud-speakers.
- **R+R** : Audio signal from audio R input is sent to left and right loud-speakers.

Time Menu Options

Setting the Clock

- If current time setting is erased by a power failure, if TV is unplugged or if the set is turned off with the **ON/OFF** button on the set, reset the clock.

1. Press the **MENU** button and then use **▲ / ▼** button to select the **TIME** menu.
2. Press the **▶** button and then use **▲ / ▼** button to select **Clock**.
3. Press the **▶** button and then use **▲ / ▼** button to adjust the hour.
4. Press the **▶** button and then use **▲ / ▼** button to adjust the minute.
5. Repeatedly press the **MENU** button to return to normal TV viewing.

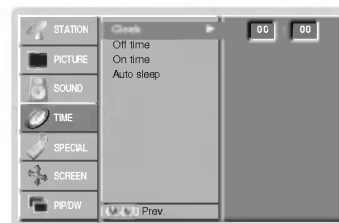

Setting the On/Off Timer

- Timer function operates only if current time has been already set.
 - Off Timer function overrides on Timer function if they are set to the same time.
 - The set must be in standby mode for the On Timer to work.

1. Press the **MENU** button and then use **▲ / ▼** button to select the **TIME** menu.
2. Press the **▶** button and then use **▲ / ▼** button to select **Off time** or **On time**.
3. Press the **▶** button and then use **▲ / ▼** button to select **On**.
4. Press the **▶** button and then use **▲ / ▼** button to adjust the hour.
5. Press the **▶** button and then use **▲ / ▼** button to adjust the minute.
6. **Only On time function**; Press the **▶** button and then use **▲ / ▼** button to adjust programme number or volume level.
7. Repeatedly press the **MENU** button to return to normal TV viewing.

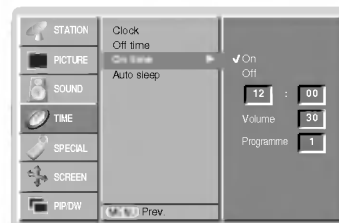

- To cancel **Off/On time** function Press the **▲ / ▼** button to select **Off** in step 3.
- Two hours after the set is switched on by the on time function it will automatically switch back to standby mode unless a button has been pressed.

Auto Sleep

- If there is no input signal, the monitor turn off automatically after 10 minutes.

1. Press the **MENU** button and then use **▲ / ▼** button to select the **TIME** menu.
2. Press the **▶** button and then use **▲ / ▼** button to select **Auto sleep**.
3. Press the **▶** button and then use **▲ / ▼** button to select **On** or **Off**.
4. Repeatedly press the **MENU** button to return to normal TV viewing.

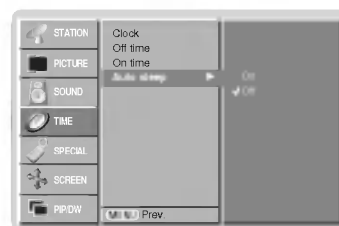

Sleep Timer

- Sleep timer turns the set off at the preset time.
 - Press the **SLEEP** button to select the number of minutes. The display **zz --- Min** will appear on the screen, followed by **10, 20, 30, 60, 90, 120, 180** and **240** minutes. The timer begins to count down from the number of minutes selected.

- a. To check the remaining sleep time, press the **OK** button once.
- b. To cancel the sleep time, repeatedly press the **SLEEP** button until the display **zz --- Min** appears.
- c. If you turn the set off after setting the sleep timer, the setting will be erased.

Special Menu Options

Child lock

- The set can be set up so that it can only be used with the remote control.

 1. Press the **MENU** button and then **▲ / ▼** button to select the **SPECIAL** menu.
 2. Press the **▶** button and then **▲ / ▼** button to select **Child lock**.
 3. Press the **▶** button and then **▲ / ▼** button to select **On** or **Off**.
 4. Repeatedly press the **MENU** button to return to normal TV viewing.



- This set programmed to remember which option it was last set to event if you turn the set off.
- In **Child lock 'On'**, if the set is turned off, press the **TV/AV**, **▲ / ▼** button on the set or **POWER**, **TV/AV**, **MULTI-MEDIA**, **▲ / ▼** or **NUMBER** buttons on the remote control.
- With the **Child lock On**, the display '▲ Child lock on' appears on the screen if any button on the front panel is pressed while viewing the set.

ISM (Image Sticking Minimization) Method

- Frozen still picture from a PC/video game displayed on the screen for prolonged periods will result in an ghost image remaining even when you change the image. Avoid allowing a fixed image to remain on the set's screen for a long period of time.

1. Press the **MENU** button and then use **▲ / ▼** button to select the **SPECIAL** menu.
2. Press the **▶** button and then **▲ / ▼** button to select **ISM Method**.
3. Press the **▶** button and then **▲ / ▼** button to select either **Normal**, **White wash**, **Orbiter** or **Inversion**. If you unnecessary to set this function, set **Normal**.

- **White Wash :**

White Wash removes permanent images from the screen.

Note: An excessive permanent image may be impossible to clear entirely with White Wash.

- **Orbiter :**

Orbiter may help prevent ghost images. However, it is best not to allow any fixed image to remain on the screen. To avoid a permanent image on the screen, the screen will move every 2 minutes.

- **Inversion :**

This is the function to invert the panel color of the screen. The panel color is automatically inverted every 30 minutes.

4. Repeatedly press the **MENU** button to return to normal TV viewing.

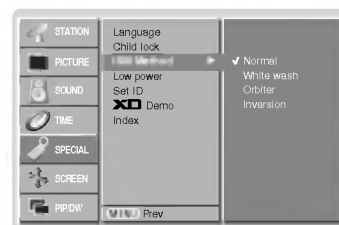

Special Menu Options

Low Power

- This is the function to reduce the power consumption of the set.
 1. Press the **MENU** button and then use **▲ / ▼** button to select the **SPECIAL** menu.
 2. Press the **▶** button and then use **▲ / ▼** button to select **Low power**.
 3. Press the **▶** button and then use **▲ / ▼** button to select **On** or **Off**.
 4. Repeatedly press the **MENU** button to return to normal TV viewing.



XD Demo

- Use it to see the difference between XD demo on and XD Demo off.
 1. Press the **MENU** button and then use **▲ / ▼** button to select the **SPECIAL** menu.
 2. Press the **▶** button and then use **▲ / ▼** button to select **XD Demo**.
 3. Press the **▶** button to begin **XD Demo**.
 4. To stop **XD Demo**, press the **EXIT** button.

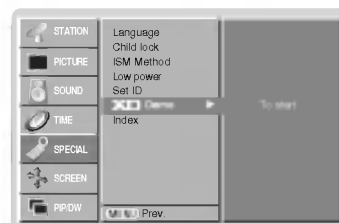

LED DISPLAY adjustment

- You can switch LED DISPLAY on or off.
 1. Press the **MENU** button and then use **▲ / ▼** button to select the **SPECIAL** menu.
 2. Press the **▶** button and then use **▲ / ▼** button to select **Index**.
 3. Press the **▶** button and then use **▲ / ▼** button to select **On** or **Off**.
When you select **On** mode, The LED DISPLAY illuminates brightly.
 4. Repeatedly press the **MENU** button to return to normal TV viewing.

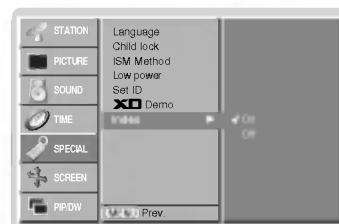

Screen Menu Options

Auto adjustment (RGB [PC] mode only)

- Automatically adjusts picture position and minimizes image shaking.
1. Press the **MENU** button and then use **▲** / **▼** button to select the **SCREEN** menu.
 2. Press the **▶** button and then use **▲** / **▼** button to select **Auto config.**
 3. Press the **▶** button to start **Auto config.**
 - When **Auto config.** has finished, **Ok** will be shown on screen.
 - If the position of the image is still not correct, try Auto adjustment again.
 4. If picture needs to be adjusted more after Auto adjustment in RGB (PC), you can adjust the **Manual config.**
 5. Repeatedly press the **MENU** button to return to normal TV viewing.
- Although the image is still not correct, your set is functioning properly but needs further adjustment.
 - The **Auto config.** and the **Manual config.** functions don't need to be run for DVI mode.



Setting Picture Format

- You can watch the screen in various picture formats; **Spectacle**, **Full**, **Original**, **4:3**, **16:9** (Wide), **14:9** and **Zoom**.

1. Press the **MENU** button and then use **▲** / **▼** button to select the **SCREEN** menu.
2. Press the **▶** button and then use **▲** / **▼** button to select **ARC**.
3. Press the **▶** button and then use **▲** / **▼** button to select **Spectacle**, **Full**, **Original**, **4:3**, **16:9**, **14:9** or **Zoom**.

• Spectacle

When your TV receives the wide screen signal, following selection will lead you to adjust the picture horizontally, in a linear proportion, to fill the entire screen.

• Full

When your TV receives the wide screen signal, following selection will lead you to adjust the picture horizontally or vertically, in a linear proportion, to fill the entire screen fully.

• Original

When your TV receives the wide screen signal, it will be automatically changed to the picture format to be sent.

• 4:3

Following selection will lead you to view a picture with an original 4:3 aspect ratio, with gray bars appearing at both the left and right sides.

• 16:9 (Wide)

Following selection will lead you to adjust the picture horizontally, in a linear proportion, to fill the entire screen (useful for viewing 4:3 formatted DVDs).

• 14:9

You can enjoy the picture format of 14:9 or general TV programme through the 14:9 mode. The screen 14:9 is viewed just like that the screen 4:3 is magnified to the left / right.

• Zoom

Following selection will lead you to view the picture without any alternation, while filling the entire screen. However, the top and bottom portions of the picture will be cropped.

4. Repeatedly press the **MENU** button to return to normal TV viewing.

- You can only select **4:3** and **16:9** (Wide) in RGB, DVI.
- You can only select **4:3**, **16:9** (Wide) and **Zoom** in Component 480p/576p/720p/1080i.



Screen Position

- This function works in the following mode:
RGB-PC or COMPONENT 480p/576p/720p/1080i.

1. Press the **MENU** button and then **▲** / **▼** button to select the **SCREEN** menu.
2. Press the **▶** button and then **▲** / **▼** button to select **Position**.
3. Press the **▶** button and then **▲** / **▼** or **◀** / **▶** button to adjust the position.
4. Repeatedly press the **MENU** button to return to normal TV viewing.



Screen Menu Options

Manual Configure (RGB [PC] mode only)

- If the picture isn't clear after auto adjustment and especially that characters are still trembling, adjust the picture phase manually.
- To correct the screen size, adjust **Clock**.

1. Press the **MENU** button and then **▲ / ▼** button to select the **SCREEN** menu.
2. Press the **▶** button and then **▲ / ▼** button to select **Manual config.**
3. Press the **▶** button and then **▲ / ▼** button to select **Phase** or **Clock**.
4. Press the **◀ / ▶** button to make appropriate adjustments.
 - The adjustment range of **Phase** is 0 ~ 30.
 - The adjustment range of **Clock** is -127 ~ +128.
5. Repeatedly press the **MENU** button to return to normal TV viewing.



Selecting Wide VGA/XGA mode (RGB[PC] mode only)

- To see a normal picture, match the resolution of RGB mode and selection of VGA/XGA mode.
- In some models, it's not available to selection of XGA mode.

1. Press the **MENU** button and then use **▲ / ▼** button to select the **SCREEN** menu.
2. Press the **▶** button and then use **▲ / ▼** button to select **VGA Mode** (or **XGA Mode**).
3. Press the **▶** button and then use **▲ / ▼** button to select the desired VGA/XGA resolution.
4. Repeatedly press the **MENU** button to return to normal TV viewing.



Screen Adjustments

- Use this function to correct jittering or picture instability while viewing a video tape.
- This function works in the following mode:
TV, AV1, AV2, AV3, AV4, AV5 or Component 480i/576i.

1. Press the **MENU** button and then use **▲ / ▼** button to select the **SCREEN** menu.
2. Press the **▶** button and then use **▲ / ▼** button to select **Screen adj.**
3. Press the **▶** button and then use **▲ / ▼** button to select **TV** or **VCR**.
 - Select the **VCR** option if watching a VCR.
 - Select the **TV** option for other equipment.(Except VCR)
4. Repeatedly press the **MENU** button to return to normal TV viewing.

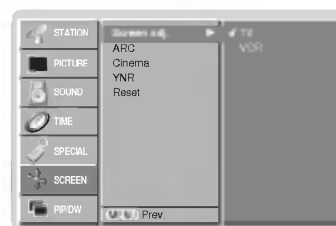

Cinema

- When you watch the movie, this function adjusts the set to the best picture appearance.
- This function works in the following mode:
TV, AV1, AV2, AV3, AV4, AV5 or COMPONENT 480i/576i.

1. Press the **MENU** button and then use **▲ / ▼** button to select the **SCREEN** menu.
2. Press the **▶** button and then use **▲ / ▼** button to select **Cinema**.
3. Press the **▶** button and then use **▲ / ▼** button to select **On** or **Off**.
4. Repeatedly press the **MENU** button to return to normal TV viewing.

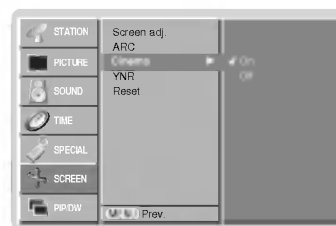

Luminance Noise Reduction (option)

- You can select **On** or **Off** to reduce the picture noise which may appear on the screen during watching the TV.
- This function works in the following mode:
TV, AV1, AV2, AV3, AV4, AV5 or Component 480i/576i.

1. Press the **MENU** button and then use **▲ / ▼** button to select the **SCREEN** menu.
2. Press the **▶** button and then use **▲ / ▼** button to select **YNR**.
3. Press the **▶** button and then use **▲ / ▼** button to select **On** or **Off**.
4. Repeatedly press the **MENU** button to return to normal TV viewing.

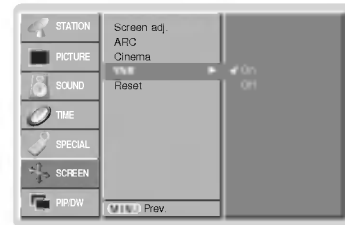

Initializing (Reset to original factory value)

This function operates in current mode.
To initialize the adjusted value

1. Press the **MENU** button and then **▲ / ▼** button to select the **SCREEN** menu.
2. Press the **▶** button and then **▲ / ▼** button to select **Reset**.
3. Press the **▶** button.
 - You can initialize Position, SPLIT ZOOM, PIP size, PIP position, PIP Transparency and sub picture size of twin picture.

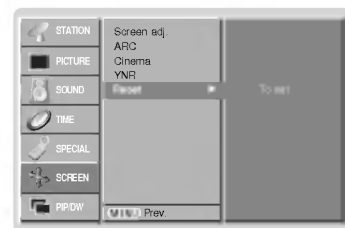

Split Zoom

- This is the function to enlarge the screen with regular ration.
- It's available to use this function in every input source.
- With 2-SPLIT ZOOM, you can only move the screen into upside or downside.
- If a screen is enlarged, a screen can move without selecting a section of screen.

1. Press the **SPLIT ZOOM** button.
 - Each press of **SPLIT ZOOM** button changes the screen display as shown below.



In case of 9-Split Zoom:

Press the number button to select the section you want to enlarge.
If you choose No.5, the 5 section is enlarged and also can move the enlarged screen with using the **▲ / ▼** or **◀ / ▶** button.

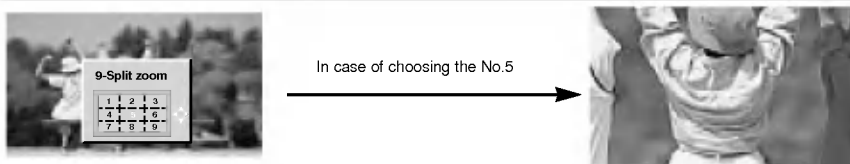

The 5 section is changed to a full screen.

PIP (Picture-in-Picture) Feature

- PIP lets you view 2 different inputs (sources) on your set screen at the same time.
- It's not available to use this function in TELETEXT mode.

Watching PIP

Press the **PIP/DW** button to show the sub picture.

- Each press of **PIP/DW** button changes the screen display as shown below.

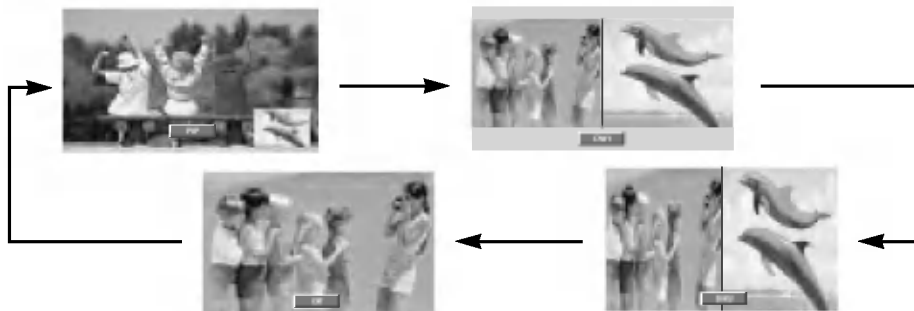

Programme Selection for Sub Picture

Press the **PIP PR +/-** button to select a programme for the sub picture.

Moving the PIP (PIP mode only)

Press the **WIN.POSITION** button.

Repeatedly press the **▲ / ▼** or **◀ / ▶** button until desired position is achieved. The sub picture moves up/down or left/right.

Selecting an Input Signal Source for the PIP

Press the **PIP INPUT** button to select the input source for the sub picture.



- In RGB, DVI and COMPONENT 480p/576p/720p/1080i for main picture, you can select TV, AV1, AV2, AV3, AV4, AV5 and COMPONENT 480i/576i for sub picture.
- In TV, AV1, AV2, AV3, AV4, AV5 and COMPONENT 480i/576i for main picture, you can select TV, AV1, AV2, AV3, AV4, AV5, COMPONENT 480i/480p/576i/576p/720p/1080i, RGB and DVI for sub picture.
- You can't select the same modes for main picture and sub picture simultaneously. (except TV)

Picture Size

Press the **WIN.SIZE** button and then **◀ / ▶** button to adjust the sub picture size.

With **WIN.SIZE** button in DW1, DW2 modes, main and sub picture are adjusted simultaneously. With **WIN.SIZE** button in PIP mode, sub picture is adjusted.



Adjusting PIP Transparency (PIP mode only)

1. Press the **MENU** button and then **▲ / ▼** button to select the PIP/DW menu.
2. Press the **▶** button and then **▲ / ▼** button to select **PIP Transparency**.
3. Press the **▶** button and then **◀ / ▶** button to adjust PIP transparency.
 - The adjustment range of **PIP Transparency** is 0 ~ 10.
4. Repeatedly press the **MENU** button to return to normal TV viewing.

Teletext (option)

- Teletext (or TOP text) is an optional function, therefore only the set with the teletext system can receive the teletext broadcast.
- Teletext is a free service broadcast by most TV stations which gives up-to-the-minute information on news, weather, television programmes, share prices and many other topics.
- The teletext decoder of this set can support the SIMPLE, TOP and FASTEXT systems. SIMPLE (standard teletext) consists of a number of pages which are selected by directly entering the corresponding page number. TOP and FASTEXT are more modern methods allowing quick and easy selection of teletext information.

Switch on/off

Press the **TEXT/★** button to switch to teletext.

- The initial page or last page appears on the screen.
Two page numbers, TV station name, date and time are displayed on the screen headline. The first page number indicates your selection, while the second shows the current page displayed.

Press the **TEXT/★** button to switch off teletext.

SIMPLE Text (option)

Page selection

1. Enter the desired page number as a three digit number with the NUMBER buttons. If during selection you press a wrong number, you must complete the three digit number and then reenter the correct page number.
2. The **PR +/-** button can also be used to select the preceding or following page.

TOP Text (option)

The user guide displays four fields-red, green, yellow and blue at the bottom of the screen. The yellow field denotes the next group and the blue field indicates the next block.

Block / group / page selection

1. With the blue button you can progress from block to block.
2. Use the yellow button to proceed to the next group with automatic overflow to the next block.
3. With the green button you can proceed to the next existing page with automatic overflow to the next group. (Alternatively the **PR +** button can be used.)
4. The red button permits to return to previous selection. (Alternatively the **PR -** button can be used.)

Direct page selection

Corresponding to the SIMPLE text mode, you can select a page by entering it as a three digit number using the NUMBER buttons in TOP mode.

FASTEXT

The teletext pages are colour coded along the bottom of the screen and are selected by pressing the corresponding coloured button.

Page selection

1. Press the  button to select the index page.
2. You can select the pages which are colour coded along the bottom line with the same coloured buttons.
3. Corresponding to the SIMPLE text mode, you can select a page by entering its three digit page number with the NUMBER buttons in FASTEXT mode.
4. The **PR +/-** button can also be used to select the preceding or following page.

Special Teletext Functions



REVEAL

Press this button to display concealed information, such as solutions of riddles or puzzles.

Press this button again to remove the information from the display.



SIZE

Selects double height text.

Press this button to enlarge the top half of the page.

Press this button again to enlarge the bottom half of the page.

Press this button again to return to the normal display.



UPDATE

Displays the TV picture on the screen while waiting for the new teletext page.

Press this button to view the updated teletext page.



HOLD

Stops the automatic page change which will occur if a teletext page consists of 2 or more sub pages. The number of sub pages and the sub page displayed is, usually, shown on the screen below the time. When this button is pressed the stop symbol is displayed at the top left-hand corner of the screen and the automatic page change is inhibited.

To continue press this button again.



MIX

Displays the teletext pages superimposed on the TV picture.

To switch the TV picture off press this button again.



TIME

This button has two functions:

- a) When viewing a TV programme, press this button to display the time at the top right hand corner of the screen. Press this button again to remove the display.
- b) In teletext mode, press this button to select a sub page number. The sub page number is displayed at the bottom of the screen. To hold or change the sub page, press the RED/ GREEN or **PR +/-** buttons. Press this button again to exit this function.

External Control Device Setup

- Connect the RS-232C input jack to an external control device (such as a computer or an A/V control system) and control the set's functions externally.

How to connect external control equipment

- Connect the serial port of the control device to the RS-232C jack on the Monitor back panel.
- RS-232C connection cables are not supplied with the set.
- The set remote control and front panel controls (except main power) will not be functional if the Monitor is controlled by a PC computer or other external device.

< Back panel of the set >

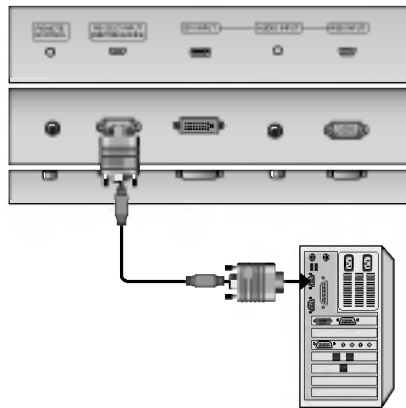

Type of connector; D-Sub 9-pin male

No.	Pin name
1	No connection
2	RXD (Receive data)
3	TXD (Transmit data)
4	DTR (DTE side ready)
5	GND
6	DSR (DCE side ready)
7	RTS (Ready to send)
8	CTS (Clear to send)
9	No Connection

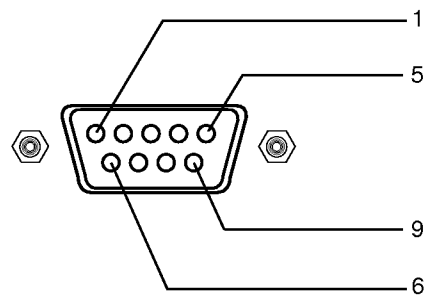

RS-232C configurations

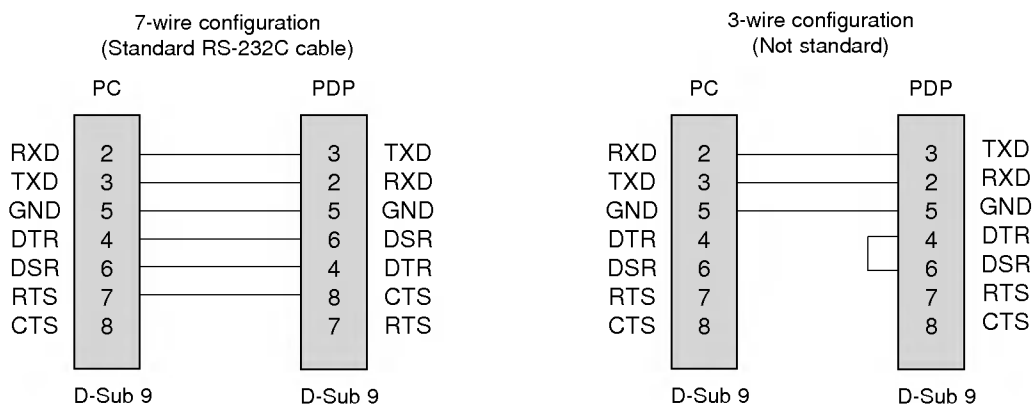

Set ID

- Use this function to specify a set ID number.
- Refer to 'Real Data Mapping 1'. See page 38.

1. Press the **MENU** button and then use the **▲ / ▼** button to select the **SPECIAL** menu.
2. Press the **▶** button and then use **▲ / ▼** button to select **Set ID**.
3. Press the **▶** button and then use **◀ / ▶** button to adjust **Set ID** to choose the desired monitor ID number.
 - The adjustment range of **Set ID** is 1 ~ 99.
4. Repeatedly press the **MENU** button to return to normal TV viewing.

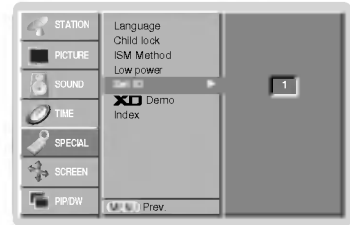

Communication Parameters

- Baud rate : 9600 bps (UART)
- Data length : 8 bits
- Parity : None
- * Use a crossed (reverse) cable.
- Stop bit : 1 bit
- Communication code : ASCII code

Command Reference List

	COMMAND 1	COMMAND 2	DATA (Hexadecimal)
01. Power	k	a	0 ~ 1
02. Input Select	k	b	0 ~ 8
03. Aspect Ratio	k	c	0 ~ 6
04. Screen Mute	k	d	0 ~ 1
05. Volume Mute	k	e	0 ~ 1
06. Volume Control	k	f	0 ~ 64
07. Contrast	k	g	0 ~ 64
08. Brightness	k	h	0 ~ 64
09. Colour	k	i	0 ~ 64
10. Tint	k	j	0 ~ 64
11. Sharpness	k	k	0 ~ 64
12. OSD Select	k	l	0 ~ 1
13. Remote control lock mode	k	m	0 ~ 1
14. PIP/DW	k	n	0 ~ 3
15. Split Zoom	k	p	0 ~ 99
16. PIP Position	k	q	0 ~ 3
17. Treble	k	r	0 ~ 64
18. Bass	k	s	0 ~ 64
19. Balance	k	t	0 ~ 64
20. Colour Temperature (CSM)	k	u	0 ~ 3
21. Red Adjustment	k	v	0 ~ 3C
22. Green Adjustment	k	w	0 ~ 3C
23. Blue Adjustment	k	\$	0 ~ 3C
24. PIP input Source	k	y	0 ~ 8
25. Abnormal Status	k	z	0 ~ a
26. ISM Method	j	p	0 ~ 3
27. Low Power	j	q	0 ~ 1
28. Orbiter Time Setting	j	r	1 ~ FE
29. Orbiter Pixel Setting	j	s	1 ~ 9
30. Picture Size Setting for DW Mode	j	t	0 ~ 1E (or 20)
31. Auto Configure	j	u	1
32. Programme selection	m	a	0 ~ 63
33. Programme selection for sub picture	m	b	0 ~ 63

* When setting the 25 ~ 33, a menu doesn't display on screen.

Transmission / Receiving Protocol

Transmission

[Command1][Command2][][Set ID][][Data][Cr]

- * [Command 1] : First command to control PDP set. (j or k)
- * [Command 2] : Second command to control PDP set.
- * [Set ID] : You can adjust the set ID to choose desired monitor ID number in special menu. See previous page. Adjustment range is 1 ~ 99. When selecting Set ID '0', every connected PDP set is controlled. Set ID is indicated as decimal (1~99) on menu and as Hexa decimal (0x0~0x63) on transmission/receiving protocol.
- * [DATA] : To transmit command data. Transmit 'FF' data to read status of command.
- * [Cr] : Carriage Return ASCII code '0x0D'
- * [] : ASCII code 'space (0x20)'

OK Acknowledgement

[Command2][][Set ID][][OK][Data][x]

- * The Monitor transmits ACK (acknowledgement) based on this format when receiving normal data. At this time, if the data is data read mode, it indicates present status data. If the data is data write mode, it returns the data of the PC computer.

Error Acknowledgement

[Command2][][Set ID][][NG][Data][x]

- * The Monitor transmits ACK (acknowledgement) based on this format when receiving abnormal data from non-viable functions or communication errors.

- Data
- 1: Illegal Code
 - 2: not support function
 - 3: Wait more time

01. Power (Command 2 : a)

- ▶ To control Power On/Off of the Monitor.

Transmission

```
[k][a][ ][Set ID][ ][Data][Cr]
```

Data 0 : Power Off 1 : Power On

Ack

```
[a][ ][Set ID][ ][OK][Data][x]
```

- ▶ To show Power On/Off.

Transmission

```
[k][a][ ][Set ID][ ][FF][Cr]
```

Ack

```
[a][ ][Set ID][ ][OK][Data][x]
```

* In like manner, if other functions transmit '0xFF' data based on this format, Acknowledgement data feed back presents status about each function.

02. Input Select (Command 2 : b)

- ▶ To select input source for the Monitor.
You can also select an input source using the INPUT SELECT button on the Monitor's remote control.

Transmission

```
[k][b][ ][Set ID][ ][Data][Cr]
```

Data 0 : TV 5 : AV5
1 : AV1 6 : Component
2 : AV2 7 : RGB
3 : AV3 8 : DVI
4 : AV4

Ack

```
[b][ ][Set ID][ ][OK][Data][x]
```

03. Aspect Ratio (Command 2 : c) (Main Picture Size)

- ▶ To adjust the screen format. (Main picture format)
You can also adjust the screen format using the ARC (Aspect Ratio Control) button on remote control or in the SCREEN menu.

Transmission

```
[k][c][ ][Set ID][ ][Data][Cr]
```

Data 0 : Spectacle 4 : Wide screen (16:9)
1 : full 5 : Wide screen (14:9)
2 : Original 6 : Full screen (Zoom)
3 : Normal screen (4:3)

Ack

```
[c][ ][Set ID][ ][OK][Data][x]
```

* Using the PC input, you select either 16:9 or 4:3 screen aspect ratio.

04. Screen Mute (Command 2 : d)

- ▶ To select screen mute on/off.

Transmission

```
[k][d][ ][Set ID][ ][Data][Cr]
```

Data 0 : Screen mute off (Picture on)
1 : Screen mute on (Picture off)

Ack

```
[d][ ][Set ID][ ][OK][Data][x]
```

05. Volume Mute (Command 2 : e)

- ▶ To control volume mute on/off.
You can also adjust mute using the MUTE button on remote control.

Transmission

```
[k][e][ ][Set ID][ ][Data][Cr]
```

Data 0 : Volume mute on (Volume off)
1 : Volume mute off (Volume on)

Ack

```
[e][ ][Set ID][ ][OK][Data][x]
```

06. Volume Control (Command 2 : f)

- ▶ To adjust volume.
You can also adjust volume with the volume buttons on remote control.

Transmission

```
[k][f][ ][Set ID][ ][Data][Cr]
```

Data Min : 0 ~ Max : 64
* Refer to 'Real data mapping 1'. See page 38.

Ack

```
[f][ ][Set ID][ ][OK][Data][x]
```

07. Contrast (Command 2 : g)

- ▶ To adjust screen contrast.
You can also adjust contrast in the PICTURE menu.

Transmission

```
[k][g][ ][Set ID][ ][Data][Cr]
```

Data Min : 0 ~ Max : 64
* Refer to 'Real data mapping 1'. See page 38.

Ack

```
[g][ ][Set ID][ ][OK][Data][x]
```

08. Brightness (Command 2 : h)

- ▶ To adjust screen brightness.
You can also adjust brightness in the PICTURE menu.

Transmission

```
[k][h][ ][Set ID][ ][Data][Cr]
```

Data Min : 0 ~ Max : 64
* Refer to 'Real data mapping 1'. See page 38.

Ack

```
[h][ ][Set ID][ ][OK][Data][x]
```

09. Colour (Command 2 : i)

- ▶ To adjust the screen colour.
You can also adjust colour in the PICTURE menu.

Transmission

[k][i][][Set ID][][Data][Cr]

Data Min : 0 ~ Max : 64

* Refer to 'Real data mapping 1'. See page 38.

Ack

[i][][Set ID][][OK][Data][x]

10. Tint (Command 2 : j) (option)

- ▶ To adjust the screen tint.
You can also adjust tint in the PICTURE menu.

Transmission

[k][j][][Set ID][][Data][Cr]

Data Red : 0 ~ Green : 64

* Refer to 'Real data mapping 1'. See page 38.

Ack

[j][][Set ID][][OK][Data][x]

11. Sharpness (Command 2 : k)

- ▶ To adjust the screen sharpness.
You can also adjust sharpness in the PICTURE menu.

Transmission

[k][k][][Set ID][][Data][Cr]

Data Min : 0 ~ Max : 64

* Refer to 'Real data mapping 1'. See page 38.

Ack

[k][][Set ID][][OK][Data][x]

12. OSD Select (Command 2 : l)

- ▶ To select OSD (On Screen Display) on/off when controlling remotely.

Transmission

[k][l][][Set ID][][Data][Cr]

Data 0 : OSD off 1 : OSD on

Ack

[l][][Set ID][][OK][Data][x]

13. Remote control lock mode (Command 2 : m)

- ▶ To lock the front panel controls on the monitor and remote control.

Transmission

[k][m][][Set ID][][Data][Cr]

Data 0 : Lock off 1 : Lock on

Ack

[m][][Set ID][][OK][Data][x]

* If you're not using the remote control, use this mode.
When main power is on/off, external control lock is released.

14. PIP / DW (Command 2 : n)

- ▶ To control the PIP (Picture In picture)/DW.
You can also control the PIP/DW using the PIP/DW button on the remote control or in the PIP/DW menu.

Transmission

[k][n][][Set ID][][Data][Cr]

Data 0: PIP/DW off

1: PIP

2: DW1

3: DW2

Ack

[n][][Set ID][][OK][Data][x]

15. Split Zoom (Command 2 : p)

- ▶ To operate split zoom function and select the split zoom section number.

Transmission

[k][p][][Set ID][][Data][Cr]

Data Min: 0 ~ Max: 99

ex. Data 21: Selection 1 of 2 split zoom.

• Refer to 'Real data mapping 2'.

Ack

[p][][Set ID][][OK][Data][x]

* Real data mapping 2	
0	: Reset split zoom
21	: Selection 1 of 2 split zoom
24	: Selection 4 of 2 split zoom
41	: Selection 1 of 4 split zoom
42	: Selection 2 of 4 split zoom
44	: Selection 4 of 4 split zoom
45	: Selection 5 of 4 split zoom
91	: Selection 1 of 9 split zoom
⋮	
99	: Selection 9 of 9 split zoom

16. PIP Position (Command 2 : q)

- ▶ To select sub picture position for PIP.
You can also adjust the sub picture position using WIN.POSITION button on the remote control or in the PIP/DW menu.

Transmission

[k][q][][Set ID][][Data][Cr]

Data 0 : Right down on screen

1 : Left down on screen

2 : Left up on screen

3 : Right up on screen

Ack

[q][][Set ID][][OK][Data][x]

17. Treble (Command 2 : r)

- ▶ To adjust treble.
You can also adjust treble in the SOUND menu.

Transmission

[k][r][][Set ID][][Data][Cr]

Data Min : 0 ~ Max : 64
* Refer to 'Real data mapping 1'. See page 38.

Ack

[r][][Set ID][][OK][Data][x]

18. Bass (Command 2 : s)

- ▶ To adjust bass.
You can also adjust bass in the SOUND menu.

Transmission

[k][s][][Set ID][][Data][Cr]

Data Min : 0 ~ Max : 64
* Refer to 'Real data mapping 1'. See page 38.

Ack

[s][][Set ID][][OK][Data][x]

19. Balance (Command 2 : t)

- ▶ To adjust balance.
You can also adjust balance in the SOUND menu.

Transmission

[k][t][][Set ID][][Data][Cr]

Data Min : 0 ~ Max : 64
* Refer to 'Real data mapping 1'. See page 38.

Ack

[t][][Set ID][][OK][Data][x]

20. Colour Temperature (Command 2 : u)

- ▶ To adjust colour temperature.
You can also adjust CSM in the PICTURE menu.

Transmission

[k][u][][Set ID][][Data][Cr]

Data 0: Cool 1: Normal 2: Warm 3: User

Ack

[u][][Set ID][][OK][Data][x]

21. Red Adjustment (Command 2 : v)

- ▶ To adjust red in colour temperature.

Transmission

[k][v][][Set ID][][Data][Cr]

Data Min : 0 ~ Max : 3C
* Refer to 'Real data mapping 3'. See page 38.

Ack

[v][][Set ID][][OK][Data][x]

22. Green Adjustment (Command 2 : w)

- ▶ To adjust green in colour temperature.

Transmission

[k][w][][Set ID][][Data][Cr]

Data Min : 0 ~ Max : 3C
* Refer to 'Real data mapping 3'. See page 38.

Ack

[w][][Set ID][][OK][Data][x]

23. Blue Adjustment (Command 2 : \$)

- ▶ To adjust blue in colour temperature.

Transmission

[k][\$][][Set ID][][Data][Cr]

Data Min : 0 ~ Max : 3C
* Refer to 'Real data mapping 3'. See page 38.

Ack

[\$][][Set ID][][OK][Data][x]

24. PIP Input Select (Command 2 : y)

- ▶ To select input source for sub picture in PIP/Twin picture mode. You can also adjust input source for sub picture using PIP INPUT button on remote control.

Transmission

[k][y][][Set ID][][Data][Cr]

Data 0 : TV	5 : AV5
1 : AV1	6 : Component
2 : AV2	7 : RGB
3 : AV3	8 : DVI
4 : AV4	

Ack

[y][][Set ID][][OK][Data][x]

25. Abnormal State (Command 2 : z)

- ▶ To recognize an abnormal state.

Transmission

[k][z][][Set ID][][FF][][Cr]

Data FF : Read

Ack

[z][][Set ID][][OK][Data][x]

Data 0: Normal (Power on and signal exist)
1: No signal (Power on)
2: Turn the monitor off by remote control
3: Turn the monitor off by sleep time function
4: Turn the monitor off by RS-232C function
5: 5V down
6: AC down
7: Turn the monitor off by Fan Alarm function
8: Turn the monitor off by Off time function
9: Turn the monitor off by Auto sleep function
a: Turn the monitor off by On time function

* This function is "read only".

26. ISM Method

(Command 1 : j, Command 2 : p)

- ▶ To control the ISM method. You can also adjust ISM Method in SPECIAL menu.

Transmission

[j][p][][Set ID][][Data][Cr]

Data 0 : Normal Mode 2 : Orbiter
 1 : White Wash 3 : Inversion

Ack

[p][][Set ID][][OK][Data][x]

27. Low Power

(Command 1 : j, Command 2 : q)

- ▶ To reduce the power consumption of the monitor. You can also adjust Low Power in SPECIAL menu.

Transmission

[j][q][][Set ID][][Data][][Cr]

Data 0 : Off
 1 : On

Ack

[q][][Set ID][][OK][Data][x]

28. Orbiter Time Setting

(Command 1 : j, Command 2 : r)

- ▶ To adjust orbiter operation time term.

Transmission

[j][r][][Set ID][][Data][][Cr]

Data Min: 1 ~ Max: FE
 * Refer to 'Real data mapping 1'. See page 38.

Ack

[r][][Set ID][][OK][Data][x]

29. Orbiter Pixel Setting

(Command 1 : j, Command 2 : s)

- ▶ To adjust pixel number in orbiter function.

Transmission

[j][s][][Set ID][][Data][Cr]

Data Min: 1 ~ Max: 9
 * Refer to 'Real data mapping 1'. See page 38.

Ack

[s][][Set ID][][OK][Data][x]

30. Picture Size Setting for DW Mode

(Command 1 : j, Command 2 : t)

- ▶ To select the PIP picture format. You can also select the PIP picture format using the WIN.SIZE on the remote control.

Transmission

[j][t][][Set ID][][Data][Cr]

Data Min: 0 ~ Max: 1E (or 20)

* Refer to 'Real data mapping 1'. See page 38.

Ack

[t][][Set ID][][OK][Data][x]

31. Auto Configure

(Command 1 : j, Command 2 : u)

- ▶ To adjust picture position and minimize image shaking automatically. It works only in RGB (PC) mode.

Transmission

[j][u][][Set ID][][Data][Cr]

Data 1: To set

Ack

[u][][Set ID][][OK][Data][x]

32. Programme selection

(Command 1 : m, Command 2 : a)

- ▶ To select a programme for the main picture.

Transmission

[m][a][][Set ID][][Data][Cr]

Data Min: 0 ~ Max: 63 (0 ~ C7, 200Pr is on)

Ack

[a][][Set ID][][OK][Data][x]

33. Programme selection for sub picture

(Command 1 : m, Command 2 : b)

- ▶ To select a programme for the sub picture.

Transmission

[m][b][][Set ID][][Data][Cr]

Data Min: 0 ~ Max: 63 (0 ~ C7, 200Pr is on)

Ack

[b][][Set ID][][OK][Data][x]

* Real data mapping 1

0 : Step 0
 ⋮
 A : Step 10 (Set ID 10)
 ⋮
 F : Step 15 (Set ID 15)
 10 : Step 16 (Set ID 16)
 ⋮
 64 : Step 100
 ⋮
 6E : Step 110
 ⋮
 73 : Step 115
 74 : Step 116
 ⋮
 C7 : Step 199

* Real data mapping 3

0 : -30
 1 : -29
 2 : -28
 ⋮
 1E : 0
 ⋮
 3A : +28
 3B : +29
 3C : +30

IR Code (NEC Format)

How to connect

- ▶ Connect your wired remote control to the Remote Control port on the Monitor.

Remote Control IR Code (NEC Format)

▶ Output waveform

Single pulse, modulated with 37.917KHz signal at 455KHz

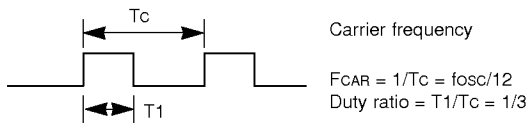

▶ Configuration of frame

- 1st frame

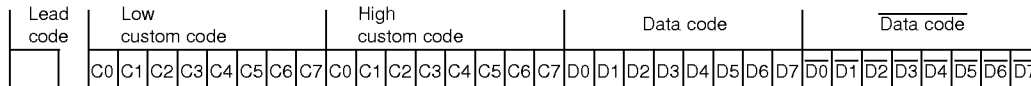

- Repeat frame

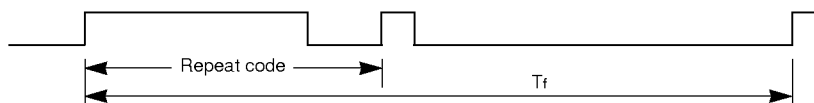

▶ Lead code

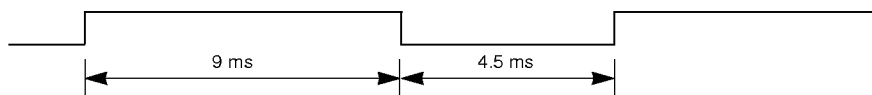

▶ Repeat code

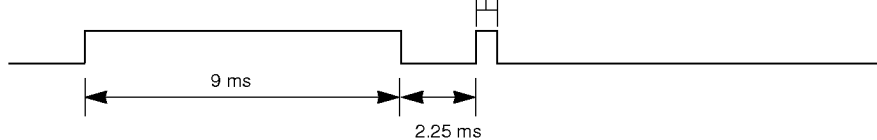

▶ Bit description

- Bit "0"

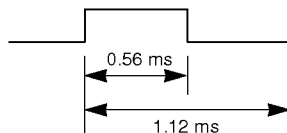

- Bit "1"

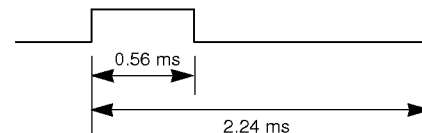

▶ Frame interval : Tf

The waveform is transmitted as long as a key is depressed.

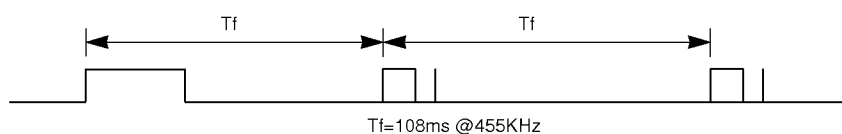

Code (Hexa)	Function	Note
00	PR+	R/C Button
01	PR-	R/C Button
02	VOL+	R/C Button
03	VOL-	R/C Button
40	Up (▲)	R/C Button
41	Down (▼)	R/C Button
06	Right (▶)	R/C Button
07	Left (◀)	R/C Button
08	POWER	R/C Button (Power On/Off)
C4	POWER ON	Discrete IR Code (Only Power On)
C5	POWER OFF	Discrete IR Code (Only Power Off)
09	MUTE	R/C Button
10	Number Key 0	R/C Button
11	Number Key 1	R/C Button
12	Number Key 2	R/C Button
13	Number Key 3	R/C Button
14	Number Key 4	R/C Button
15	Number Key 5	R/C Button
16	Number Key 6	R/C Button
17	Number Key 7	R/C Button
18	Number Key 8	R/C Button
19	Number Key 9	R/C Button
0B	TV/AV	R/C Button
98	MULTIMEDIA	R/C Button
BF	COMPONENT	Discrete IR Code (Input COMPONENT Selection)
D5	DVI	Discrete IR Code (Input DVI Selection)
C6	RGB	Discrete IR Code (Input RGB Selection)
D6	TV	Discrete IR Code (Input TV Selection)
5A	AV1	Discrete IR Code (Input AV1 Selection)
D0	AV2	Discrete IR Code (Input AV2 Selection)
D1	AV3	Discrete IR Code (Input AV3 Selection)
D2	AV4	Discrete IR Code (Input AV4 Selection)
CF	AV5	Discrete IR Code (Input AV5 Selection)
0A	I/II	R/C Button
0E	SLEEP	R/C Button
43	MENU	R/C Button
44	OK(■)	R/C Button
4D	PSM	R/C Button
52	SSM	R/C Button
53 or 70	LIST	R/C Button
20	TEXT/*	R/C Button
2A	REVEAL	R/C Button
22	MODE	R/C Button
24	MIX	R/C Button
26	TIME	R/C Button
62	UPDATE / WIN.POSITION	R/C Button
64	SIZE / WIN.SIZE	R/C Button
65	HOLD	R/C Button
70	INDEX	R/C Button
60	PIP/DW	R/C Button
61	PIP INPUT	R/C Button
63	SWAP	R/C Button
71	PIP PR+	R/C Button
72	PIP PR-	R/C Button
7B	SPLIT ZOOM	R/C Button
79	ARC	R/C Button
76	ARC (4:3)	Discrete IR Code (Only 4:3 mode)
77	ARC (16:9)	Discrete IR Code (Only 16:9 mode)
AF	ARC (Zoom)	Discrete IR Code (Only Zoom mode)

Notes

Troubleshooting Checklist

No picture & No sound

- Check whether the set is turned on.
- Power cord inserted into wall outlet?
- Plug another product's power cord into the wall outlet where the set's power cord was plugged in.

Picture OK & No sound

- Press the **VOLUME (+)** button.
- Sound muted? Press **MUTE** button.

The remote control doesn't work

- Check to see if there is any object between the set and the remote control causing obstruction.
- Check to see if the batteries are installed with the correct polarities. (Refer to p.6)
- Check if the remote control handset is set up to correct mode.
- Install new batteries. (Refer to p.6)

Picture appears slowly, after switching on

- This is normal as the image is muted during the startup process of the set. Please contact your service centre, if the picture has not appeared after five minutes.

No or Poor colour or Poor picture

- Select **Colour** in the PICTURE menu and press the ► button. (Refer to p.21)
- Keep a certain distance between the set and the VCR.
- Activate any function to restore the brightness of the picture. (If still picture is on the screen for more than 5 minutes, the screen gets dark.)

Horizontal/vertical bars or picture shaking

- Check for local interference such as an electrical appliance or power tool.

No output from one of the speakers

- Adjust **Balance** in the SOUND menu. (Refer to p.22)

Unusual sound from inside the set

- A change in ambient humidity or temperature may result in an unusual noise at the time of switching off or on of the set and does not indicate a fault with the set.

Product Specifications

MODEL	RZ-42PY10X/H	RZ-42PY11X/H
Width (inches / mm)	48 / 1216	48 / 1216
Height (inches / mm)	27 / 691	25 / 630
Depth (inches / mm)	10.7 / 271.4	3.8 / 96
Weight (pounds / kg)	86 / 39	70.5 / 32
Power requirement	AC100-240V, 50/60Hz	
Resolution	1024 x 768 (Dot)	
Colour	16,770,000 (256 steps of each R, G and B)	
Operating Temperature Range	32 ~ 104°F (0 ~ 40°C)	
Operating Humidity Range	Less than 80%	

MODEL	RZ-50PY10/H	RZ-50PY11/H
Width (inches / mm)	55 / 1402	55 / 1402
Height (inches / mm)	31.4 / 798.5	29 / 734
Depth (inches / mm)	12 / 302.5	3.9 / 98
Weight (pounds / kg)	122 / 55.3	98 / 44.5
Power requirement	AC100-240V, 50/60Hz	
Resolution	1366 x 768 (Dot)	
Colour	16,770,000 (256 steps of each R, G and B)	
Operating Temperature Range	32 ~ 104°F (0 ~ 40°C)	
Operating Humidity Range	Less than 80%	

MODEL	RZ-60PY10/H	RZ-60PY11/H
Width (inches / mm)	67 / 1708	67 / 1708
Height (inches / mm)	37 / 931	34 / 862
Depth (inches / mm)	13 / 320.7	3.9 / 99
Weight (pounds / kg)	188.5 / 85.5	146 / 66.2
Power requirement	AC100-240V, 50/60Hz	
Resolution	1366 x 768 (Dot)	
Colour	16,770,000 (256 steps of each R, G and B)	
Operating Temperature Range	32 ~ 104°F (0 ~ 40°C)	
Operating Humidity Range	Less than 80%	

- The specifications shown above may be changed without notice for quality improvement.

