



DVD/VCR COMBI RECEIVER

Combi Receiver System

OWNER'S MANUAL

MODEL: LH-CX245
(Main Unit: LH-CX245Y
Speakers: LHS-CX245T, LHS-CX245W



SHOWVIEW®

Before connecting up, operating or repairing this product,
please read this instruction booklet carefully and completely.

CAUTION
RISK OF ELECTRIC SHOCK
DO NOT OPEN



Warning: To reduce the risk of electric shock, do not remove the cover or back of this product. There are no user-serviceable parts inside. Refer servicing to qualified service personnel.



Warning: To reduce the risk of fire or electric shock, do not expose this product to dripping or splashing water, rain, or moisture. Do not place objects filled with water such as vases, on the product.

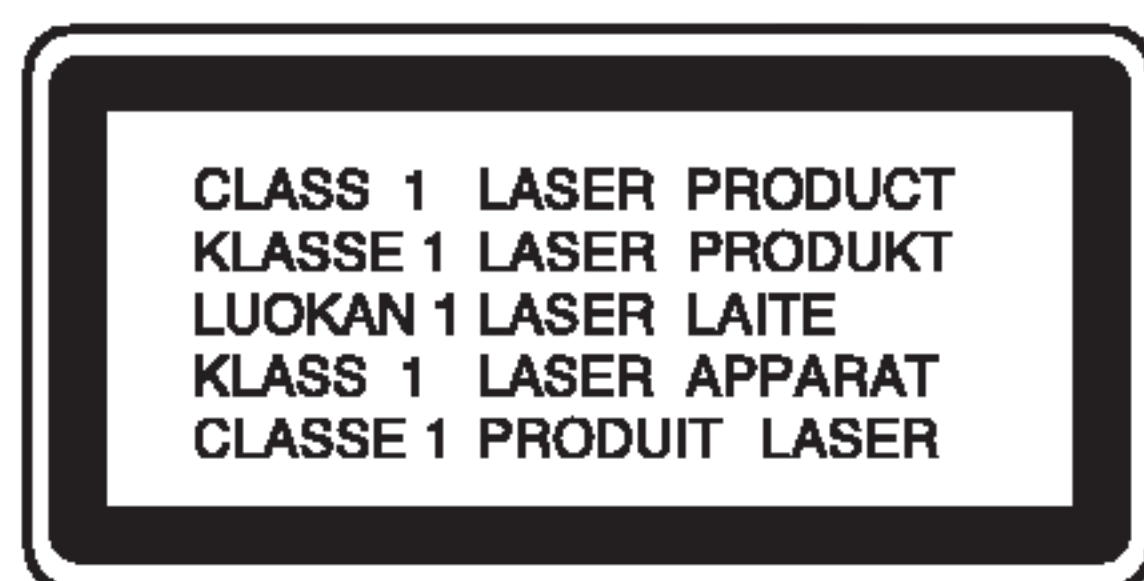

Warning: This digital video disc player employs a laser system. Use of controls, adjustments, or the performance of procedures other than those specified herein may result in hazardous radiation exposure.



Warning: To prevent direct exposure to laser beam, do not open the enclosure. Visible laser radiation when open.



Warning: Never stare directly into the laser beam.



Caution: Do not install this product in a confined space such as a book case or similar unit.



This product is manufactured to comply with the radio interference requirements of EEC DIRECTIVE 89/336/EEC, 93/68/EEC and 73/23/EEC.

Notes on Copyrights:

It is forbidden by law to copy, broadcast, show, broadcast via cable, play in public, or rent copyrighted material without permission. This product features the copy protection function developed by Macrovision. Copy protection signals are recorded on some discs. When recording and playing the pictures of these discs picture noise will appear. This product incorporates copyright protection technology that is protected by method claims of certain U.S. patents and other intellectual property rights owned by Macrovision Corporation and other rights owners. Use of this copyright protection technology must be authorized by Macrovision Corporation, and is intended for home and other limited viewing uses only unless otherwise authorized by Macrovision Corporation. Reverse engineering or disassembly is prohibited.

CONSUMERS SHOULD NOTE THAT NOT ALL HIGH DEFINITION TELEVISION SETS ARE FULLY COMPATIBLE WITH THIS PRODUCT AND MAY CAUSE ARTIFACTS TO BE DISPLAYED IN THE PICTURE. IN CASE OF 625 PROGRESSIVE SCAN PICTURE PROBLEMS, IT IS ECOMMENDED THAT THE USER SWITCH THE CONNECTION TO THE 'STANDARD DEFINITION' OUTPUT. IF THERE ARE QUESTIONS REGARDING OUR TV SET COMPATIBILITY WITH THIS MODEL 625p DVD PLAYER, PLEASE CONTACT OUR CUSTOMER SERVICE CENTER.

SERIAL NUMBER:

You can find the serial number on the back of the unit. This number is unique to this unit and not available to others. You should record requested information here and retain this guide as a permanent record of your purchase.

Model No. _____

Serial No. _____

Date of Purchase _____

Contents

Introduction	4	General Features	32
Symbol Used in this Manual	4	Moving to another TITLE	32
About the  Symbol Display	4	Moving to another CHAPTER/TRACK	32
Notes on Discs	4	Search	32
Handling Discs	4	Changing the Audio Channel	32
Storing Discs	4	Still Picture and Frame-by-Frame Playback	33
Cleaning Discs	4	Slow Motion	33
Types of Playable Discs	5	Random	33
Regional code	5	Repeat A-B	33
Disc-related terms	6	Repeat	33
Front Panel	7	3D Surround	33
Display Window	8	Time Search	33
Remote Control	9	Zoom	34
Rear Panel	10	Marker Search	34
Installation and Setup	11	Special DVD Features	34
TV & Set Top Box		Title Menu	34
(or another VCR Connections)	11-12	Disc Menu	34
Accessory Audio/Video (A/V) Connections to		Camera Angle	34
DVD/VCR Combi receiver	13	Changing the Audio Language	34
Radio Aerial Connections	13	Subtitles	34
Speaker System Connection	14	Playing an Audio CD or MP3/WMA Disc	35
Speaker Positioning	15	Audio CD and MP3 / WMA Disc Features	36
Mini Glossary for Audio Stream &		Pause	36
Surround mode	16	Moving to another Track	36
Sound Mode	16	Repeat Track/All/Off	36
Before Operation-VCR part	17-21	Search	36
Tuning in a video channel on your TV	17	Random	36
Using your receiver for the very first time	17	Repeat A-B	36
Setting the clock Manually	18	3D Surround	36
To set the colour system	18	Programmed Playback	37
How to use the main menu	19	Repeat Programmed Tracks	37
Tuning in TV stations Automatically	19	Erasing a Track from Program List	37
Tuning in TV stations Manually	20	Erasing the Complete Program List	37
Changing the order of TV stations	21	Viewing a JPEG Disc	38
Deleting TV stations	21	Slide Show	38
Before Operation-DVD part	22-27	Still Picture	38
On-Screen Display	22	Moving to another File	38
Initial Settings	23-27	Zoom	38
General Operation	23	To rotate picture	38
LANGUAGE	23	To listen to MP3/WMA music watching picture	38
• Menu Language	23	Speaker Setup	39
• Disc Audio / Subtitle / Menu	23	Playing a DVD VR format Disc	40
DISPLAY	24	Maintenance and Service	40
• TV Aspect	24	Playing a DivX Movie Disc	41
• Display Mode	24	Additional Features-VCR part	42-43
• Progressive Scan	24	On Screen Display	42
• TV Output Select	25	Tape Counter Memory Stop	42
AUDIO	25	Friendly User Guide (Video Doctor)	42
• 5.1 Speaker Setup	25	Hi-Fi Stereo Sound System	43
• Dynamic Range Control (DRC)	25	Wide Screen Compatibility 16:9	43
• Vocal	25	Additional Features	44
OTHERS	26	Last Scene Memory	44
• PBC	26	Screen Saver	44
• Auto Play	26	Video Mode Setting	44
• DivX(R) VOD	26	Copying from DVD to VCR	45
LOCK (Parental Control)	27	Recording from another video recorder	45
• Rating	27	Radio Operation	45
• Password (Security Code)	27	Presetting the Radio Stations	46
• Country Code	27	Listening to the Radio	46
Operation	27	To Clear the Stored Radio Stations	46
Playing a tape	27-31	Tuning into a Station Manually	47
• CM (Commercial Message) Skip	27	Tuning into a Station Automatically	47
• OPR (Optimum Picture Response)	27	RDS Operation	47
Instant Timer Recording (ITR)	28	Reference	48
ShowView Programming	29	Language Codes	48
Timer recording using On Screen Display	30	Country Codes	48
If Timer record events Overlap	31	Troubleshooting	49-50
Change (Deleting) the Timer Programme	31	Specification	51-52
Playing a DVD or Video CD	32-34		

Introduction

To ensure proper use of this product, please read this owner's manual carefully and retain for future reference.

This manual provides information on the operation and maintenance of your DVD player. Should the unit require service, contact an authorized service location.

Symbol Used in this Manual



The lightning flash symbol alerts you to the presence of dangerous voltage within the product enclosure that may constitute a risk of electric shock.



The exclamation point alerts you to the presence of important operating and maintenance / servicing instructions.



Indicates hazards likely to cause harm to the unit itself or other material damage.

Note:

Indicates special notes and operating features.

Tip:

Indicates tips and hints for making the task easier.

A section whose title has one of the following symbols is applicable only to the disc represented by the symbol.



DVD and finalized DVD±R/RW



Video CDs



Audio CDs



MP3 Discs



WMA Discs



JPEG Discs



DivX Discs

About the Ⓞ Symbol Display

" Ⓞ " may appear on your TV display during operation and indicates that the function explained in this owner's manual is not available on that specific DVD video disc.

Notes on Discs

Handling Discs

Do not touch the playback side of the disc. Hold the disc by the edges so that fingerprints do not get on the surface. Never stick paper or tape on the disc.



Storing Discs

After playing, store the disc in its case. Do not expose the disc to direct sunlight or sources of heat and never leave it in a parked car exposed to direct sunlight.

Cleaning Discs

Fingerprints and dust on the disc can cause poor picture quality and sound distortion. Before playing, clean the disc with a clean cloth. Wipe the disc from the center out.

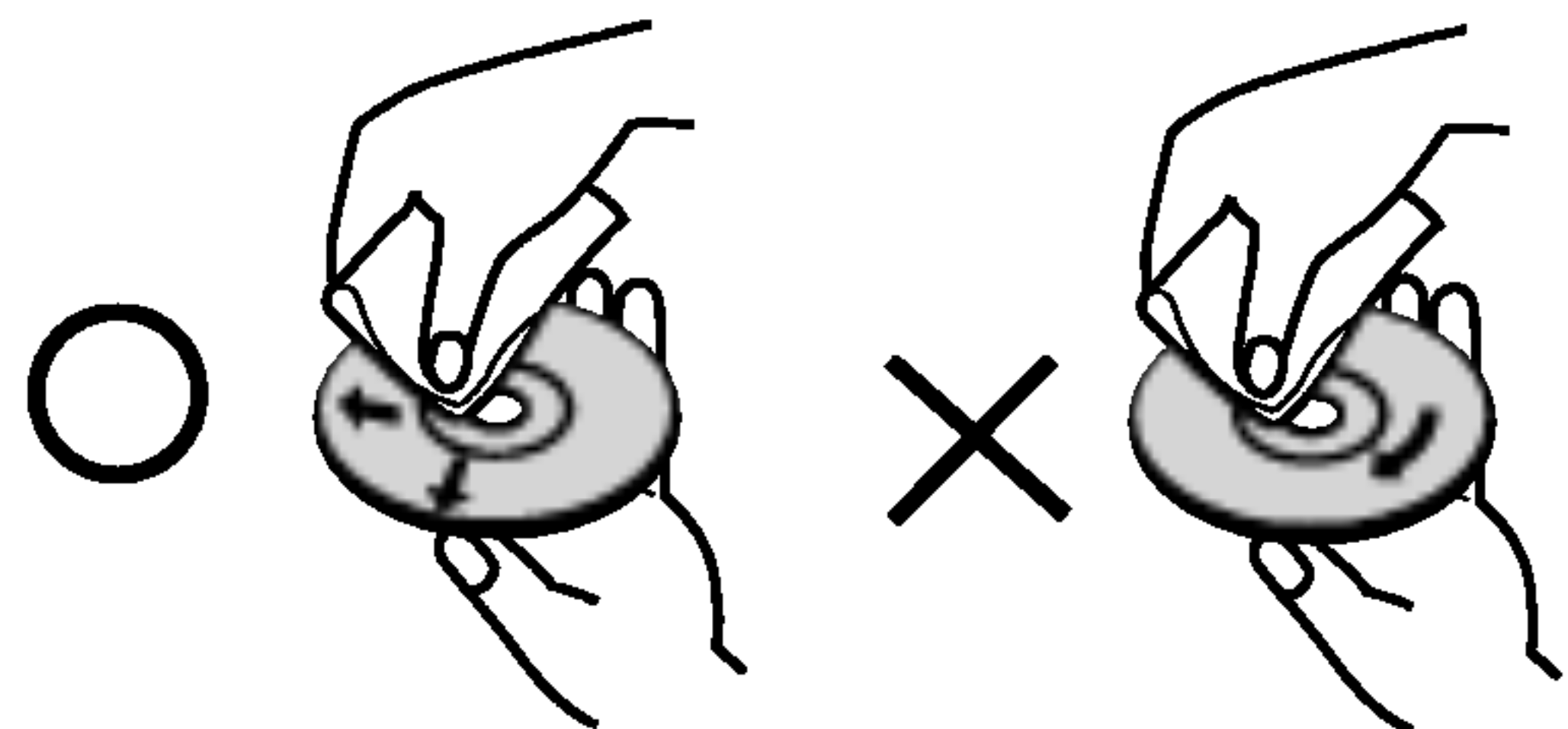

Do not use strong solvents such as alcohol, benzene, thinner, commercially available cleaners, or anti-static spray intended for older vinyl records.

Setting the Output Source

You must select one of your output sources (DVD or VCR) to view on the TV screen.

- **If you want to view output source of DVD deck:**
Press DVD on the remote or DVD/VCR on the front panel until DVD indicator on the front panel lights and output source of DVD deck is viewed on the TV screen.
- **If you want to view output source of VCR deck:**
Press VCR on the remote or DVD/VCR on the front panel until VCR indicator on the front panel lights and output source of VCR deck is viewed on the TV screen.

Types of Playable Discs

	DVD (8 cm / 12 cm disc)
	Video CD (VCD) (8 cm / 12 cm disc)
	Audio CD (8 cm / 12 cm disc)

In addition, this unit plays DivX file, DVD -R, DVD +R, DVD -RW, DVD +RW, Kodak Picture CDs, SVCD, and CD-R / CD-RW that contains audio titles, MP3, WMA, and/or JPEG files.

Notes:

- Depending on the conditions of the recording equipment or the CD-R/RW (or DVD -R, DVD +R, DVD -RW, DVD +RW) disc itself, some CD-R/RW (or DVD -R, DVD +R, DVD -RW, DVD +RW) discs cannot be played on the unit.
- Do not attach any seal or label to either side (the labeled side or the recorded side) of a disc.
- Do not use irregularly shaped CDs (e.g., heart-shaped or octagonal) since they may result in malfunctions.

Notes on DVDs and Video CDs

Some playback operations of DVDs and Video CDs may be intentionally programmed by software manufacturers. This unit plays DVDs and Video CDs according to disc content designed by the software manufacturer, therefore some playback features may not be available or other functions may be added.

Manufactured under license from Dolby Laboratories. "Dolby", "Pro Logic", and the double-D symbol are trademarks of Dolby Laboratories. Confidential Unpublished works. Copyright 1992-1997 Dolby Laboratories. All rights reserved.

Manufactured under license from Digital Theater Systems, Inc. US Pat. No's. 5,451,942; 5,956,674; 5,974,380; 5,978,762; 6,487,535 and other US and world-wide patents issued and pending. "DTS" and "DTS Digital Surround" are registered trademarks of Digital Theater Systems, Inc. Copyright 1996, 2003 Digital Theater Systems, Inc. All rights reserved.

Regional code

This DVD player is designed and manufactured for playback of region "2" encoded DVD software. This unit can play only DVD discs labeled "2" or "ALL".



Notes on Regional Codes

- Most DVD discs have a globe with one or more numbers in it clearly visible on the cover. This number must match your DVD player's regional code or the disc cannot play.
- If you try to play a DVD with a different region code from your player, the message "Check Regional Code" appears on the TV screen.

Disc-related terms

DVD ±R / DVD ±RW

DVD -R and DVD +R are two different standards for recordable DVD drives and discs. This format allows information to be recorded onto the DVD disc only once. DVD +RW and DVD -RW are two standards for re-writable media, meaning the DVD content can be erased and re-recorded. Single-sided discs can hold 4.38 Gigabytes and double-sided discs hold twice as much. There are no dual layer single sided recordable discs.

VCD (Video CD)

A VCD holds up to 74 minutes (650 MB disc) or 80 minutes (700 MB disc) of MPEG-1 full-motion video along with quality stereo sound.

MPEG

MPEG is an international standard for video and audio compression. MPEG-1 is used in encoding video for VCD and provides for multichannel surround sound coding such as PCM, Dolby Digital, DTS and MPEG audio.

MP3

MP3 is a popular compression format used for digital audio files that yields very high near-CD quality.

WMA

Windows media audio file. A type of coding / decoding developed by Microsoft Corp.

JPEG

Joint Pictures Expert Group. JPEG is a compressed file format that allows you to save images with no limit on the number of colors.

DivX

DivX is the name of a revolutionary new video codec which is based on the new MPEG-4 compression standard for video. You will be able to play DivX movies using this DVD/VCR Combi receiver.

PBC: Playback Control (Video CD only)

Playback control is available for Video CD (VCD) version 2.0 disc formats. PBC allows you to interact with the system via menus, search functions, or other typical computer-like operations. Moreover, still pictures of high resolution can be played if they are included in the disc. Video CDs not equipped with PBC (Version 1.1) operate in the same way as audio CDs.

Title (DVD video discs only)

A title is generally a distinct section of a DVD disc. For example the main feature could be title 1, a documentary describing how the film was made could be title 2, and cast interviews could be title 3. Each title is assigned a reference number enabling you to locate it easily.

Chapter (DVD video discs only)

A chapter is a segment of a title such as a scene in a film or one interview in a series. Each chapter is assigned a chapter number, enabling you to locate the chapter you want. Depending on the disc, chapters may not be recorded.

Scene (VCD)

On a video CD with PBC (playback control) functions, moving pictures and still pictures are divided into sections called "scenes". Each scene is displayed in the menu screen and assigned a scene number, enabling you to locate the scene you want. A scene is composed of one or several tracks.

Track

A distinct element of audiovisual information, such as the picture or sound track for a specific language (DVD), or a musical piece on a video or audio CD. Each track is assigned a track number, enabling you to locate the track you want. DVD discs allow one track of video (with multiple angles) and several tracks of audio.

Front Panel

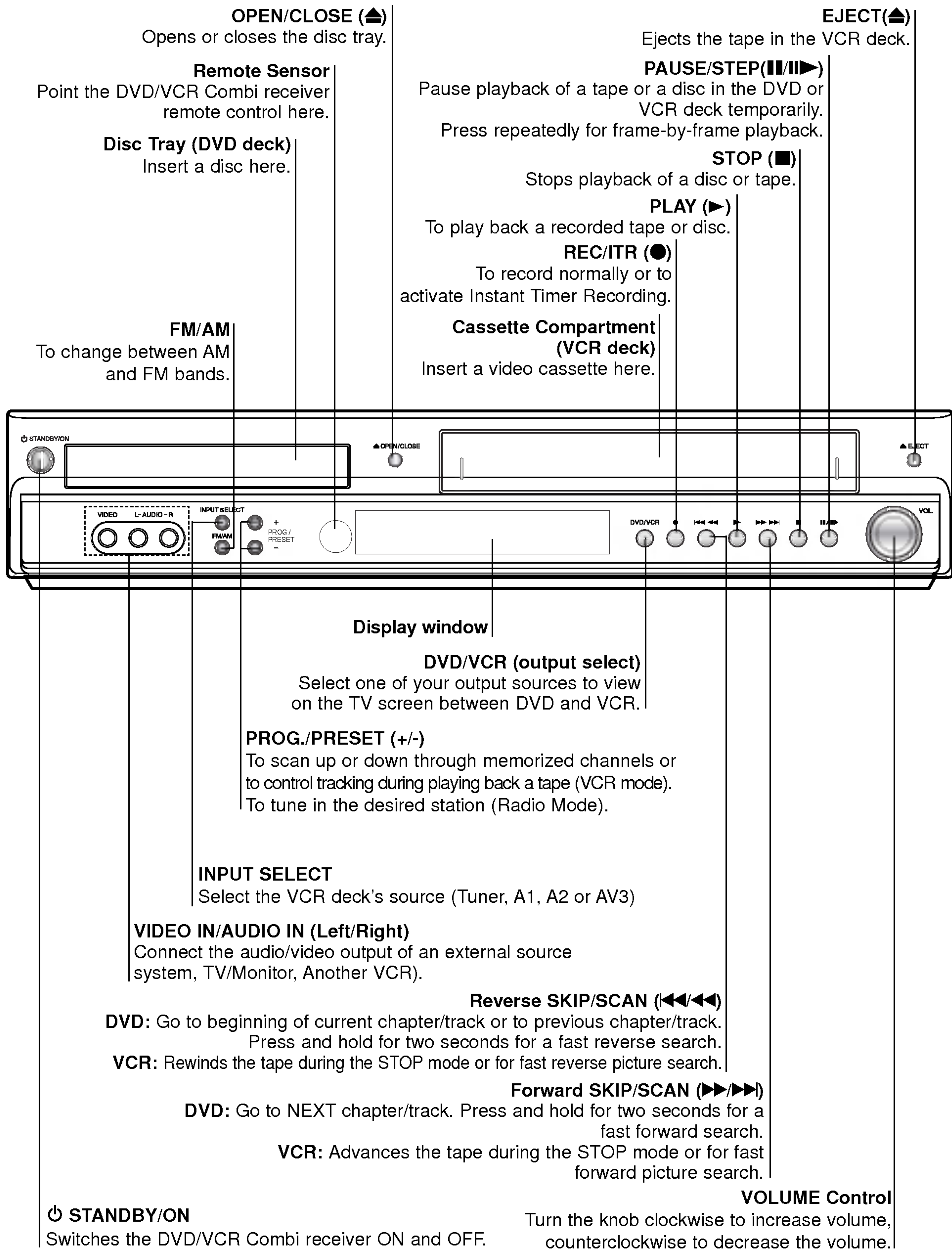

Display Window

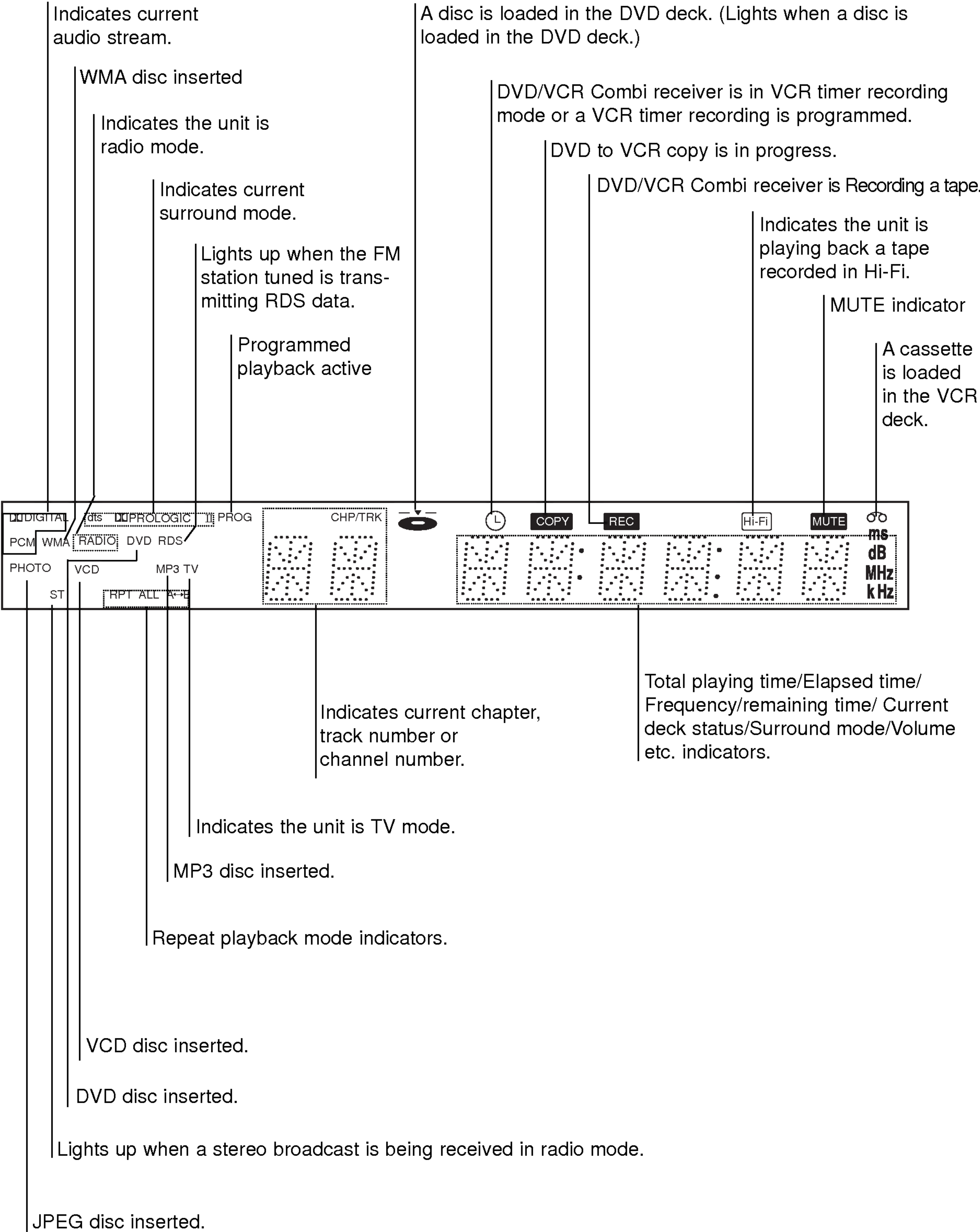

Remote Control

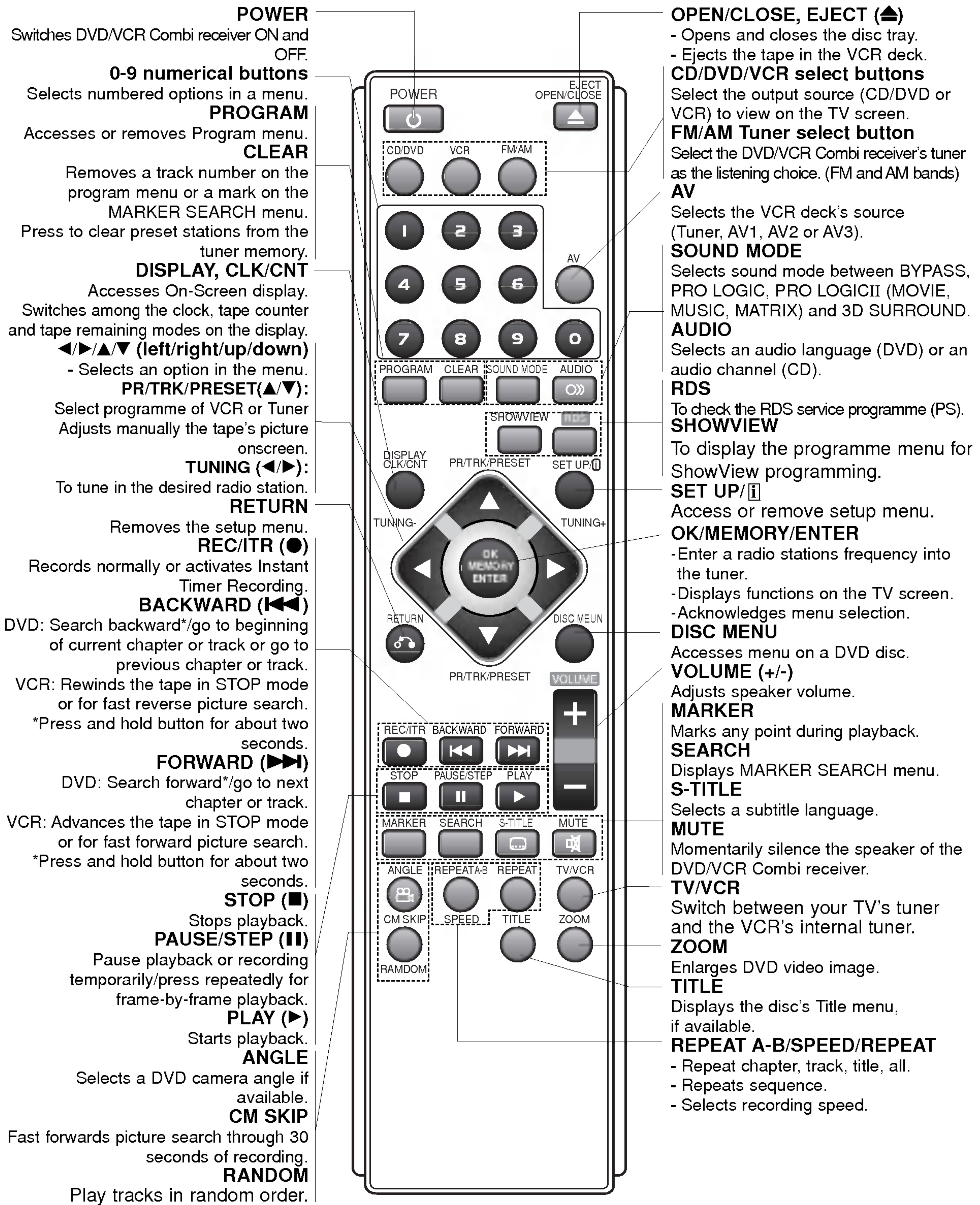

Note

This remote control use the same buttons for VCR and DVD functions (ex. PLAY).
To use the VCR, first press the VCR button.
To use the DVD, first press the CD/DVD button.

Rear Panel

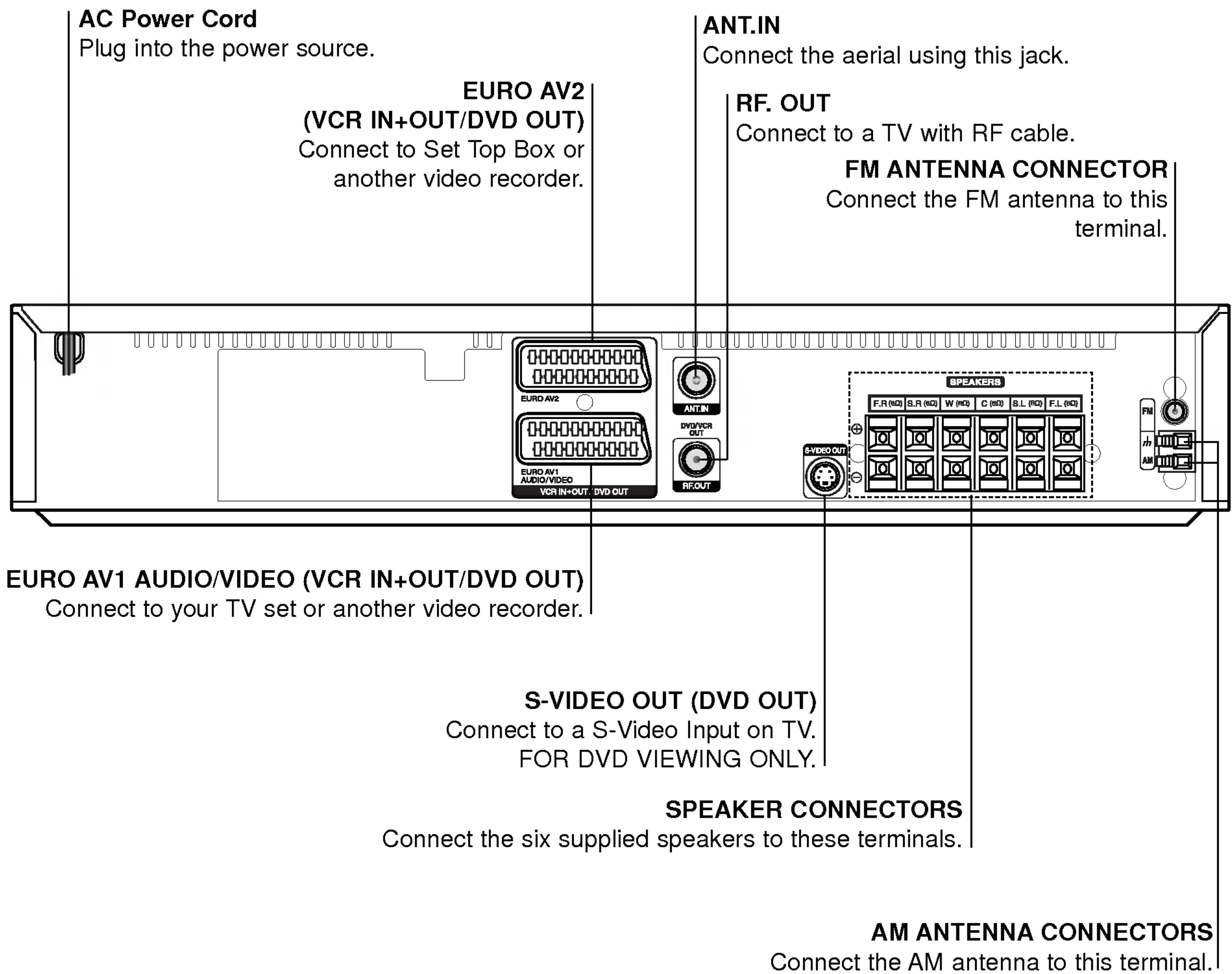

Do not touch the inner pins of the jacks on the rear panel.
Electrostatic discharge may cause permanent damage to the unit.

Remote Control Operation Range

Point the remote control at the remote sensor and press the buttons.

- **Distance:** About 6m (20ft) from the front of the remote sensor
- **Angle:** About 30° in each direction of the front of the remote sensor

Remote control battery installation

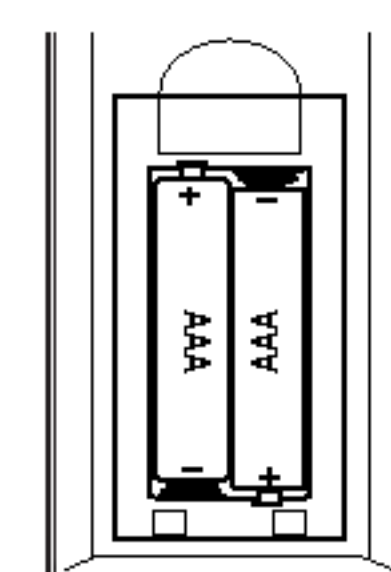

Detach the battery cover on the rear of the remote control, and insert two R03 (size AAA) batteries with \oplus and \ominus aligned correctly.



Caution
Do not mix old and new batteries. Never mix different types of batteries (standard, alkaline, etc.).

Installation and Setup

TV & Set Top Box (or another VCR Connections)

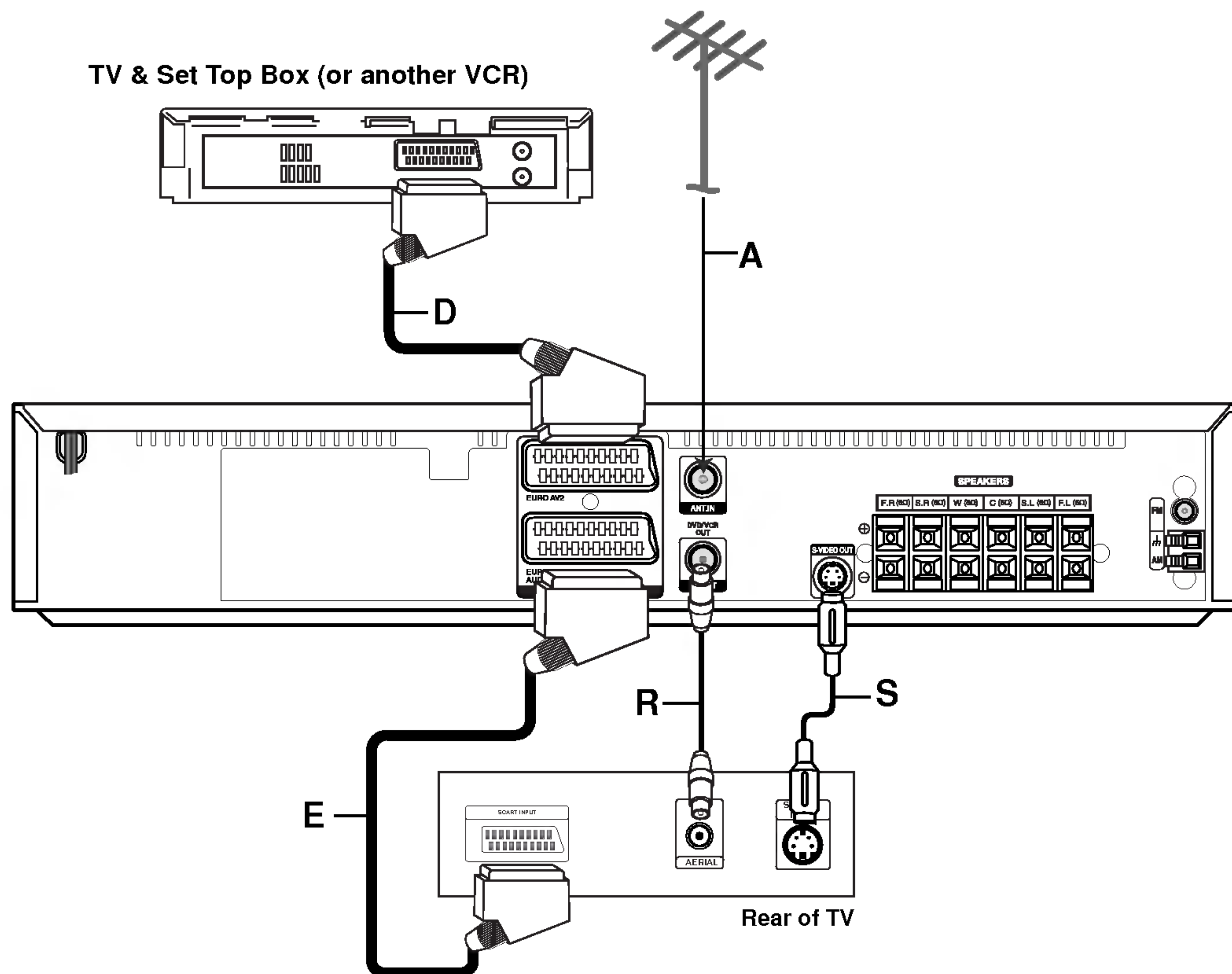

- Make one of the following connections, depending on the capabilities of your existing equipment.

Tips

- Depending on your TV and other equipment you wish to connect, there are various ways you could connect the DVD/VCR Combi receiver. Use one of the connections described below.
- Please refer to the manuals of your TV, VCR, Stereo System or other devices as necessary to make the best connections.

Caution

- Make sure the DVD/VCR Combi receiver is connected directly to the TV. Select the correct AV input on your TV.
- Do not connect your DVD/VCR Combi receiver to TV via your DVD/VCR Combi receiver. The DVD image could be distorted by the copy protection system.

Basic connections (AV)

1. Connect the **EURO AV1 AUDIO/VIDEO** on the rear panel of the DVD/VCR Combi receiver to the scart input socket on the TV using a SCART lead (E).
2. You can connect such a Set Top Box (or another VCR) to the DVD/VCR Combi receiver (D).

Basic connections (RF)

1. Connect the aerial cable (A) from your indoor/ outdoor aerial to ANT.IN jack on the rear panel of DVD/VCR Combi receiver.
2. Connect the supplied RF cable (R) from the **RF. OUT** jack on the rear panel of DVD+VCR Receiver to your television's Aerial Input.

S-Video connection

Connect the S-VIDEO OUT jack on the DVD/VCR Combi receiver to the S-VIDEO IN jack on the TV using the S-Video cable (S).

Notes

- The signal of S-VIDEO OUT jack will output only when the function mode is selected to CD/DVD.
- When you connect the DVD/VCR Combi receiver to your TV, be sure to turn off the power and unplug both units from the wall outlet before making any connections.

Progressive Scan (ColorStream® pro) connection

Connect the EURO AV1 AUDIO/VIDEO socket on the DVD/VCR Combi receiver to the COMPONENT VIDEO INPUT(Y Pb Pr) jacks on the TV using the SCART to RCA cable (Optional).

- If your television is a high-definition or “digital ready” television, you may take advantage of the DVD/VCR Combi receiver progressive scan output for the highest video resolution possible.
- If your TV does not accept the Progressive Scan format, the picture will appear scrambled if you try Progressive Scan on the DVD/VCR Combi receiver.

Notes:

- Set the Progressive Mode to “On” on the setup menu for progressive signal, see page 24.
- Once the setting for progressive scan output is entered, an image will only be visible on a progressive scan compatible TV or monitor. If you set Progressive Scan to On in error, you must reset the unit.
 - 1) Remove any disc from the unit and close the disc tray. See that “NO DISC” is displayed on the display window.
 - 2) Press STOP and hold it for five seconds before releasing it. The video output will be restored to the standard setting and a picture will once again be visible on a conventional analog TV or monitor.
- Progressive scan does not work with the analog video connections (yellow VIDEO OUT jack).

Rear of TV

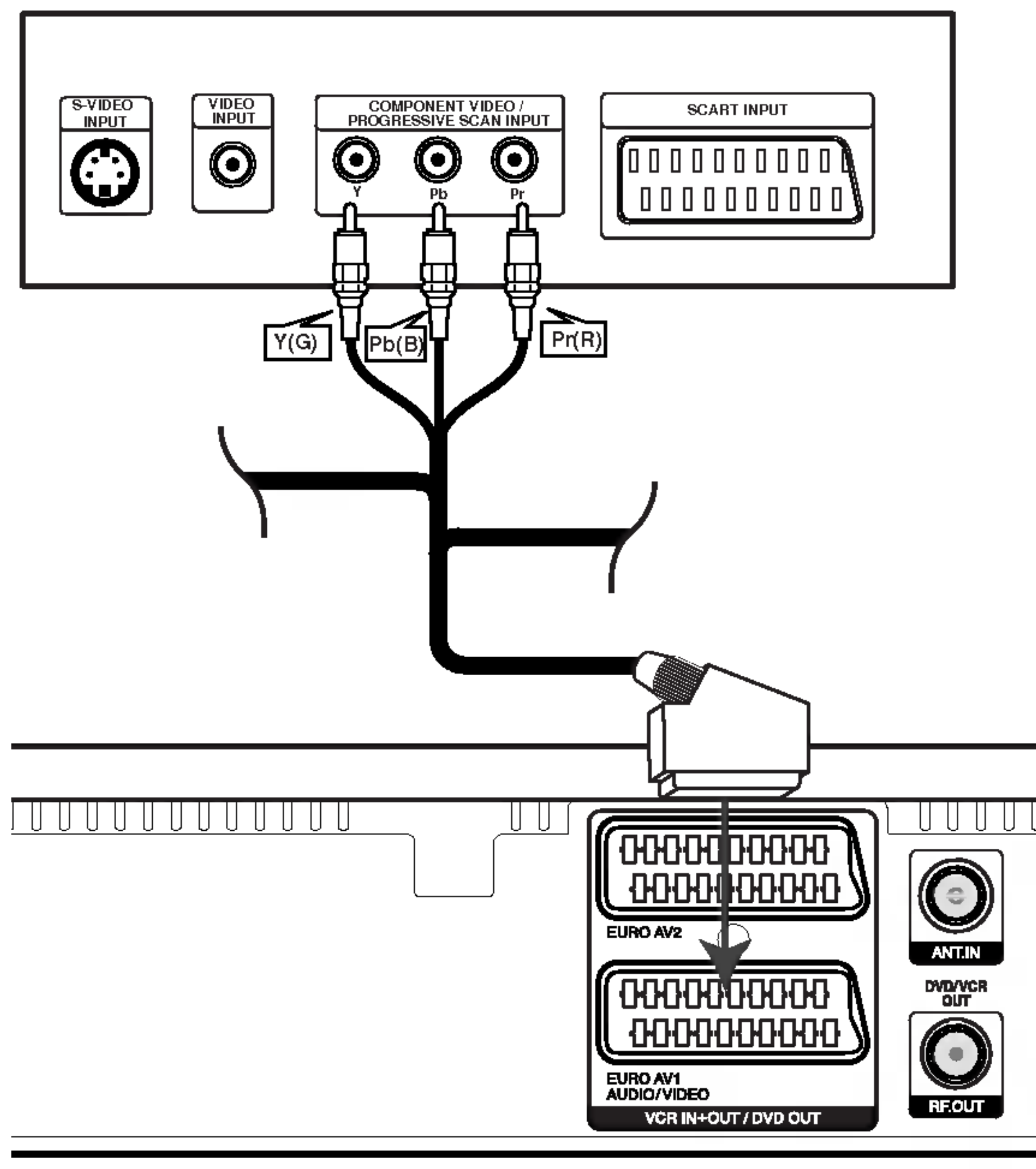

Rear of DVD/VCR Combi receiver

Caution:

You must set the TV Output Select option on the setup menu to use Y Pb Pr or RGB signal from the EURO AV1 AUDIO/VIDEO socket. (See “TV Output Select” on page 24.)

Accessory Audio/Video (A/V) Connections to DVD/VCR Combi receiver

Connect the **AV3** jacks on the DVD/VCR Combi receiver to the audio/video out jacks on your accessory component, using the optional audio/video cables..

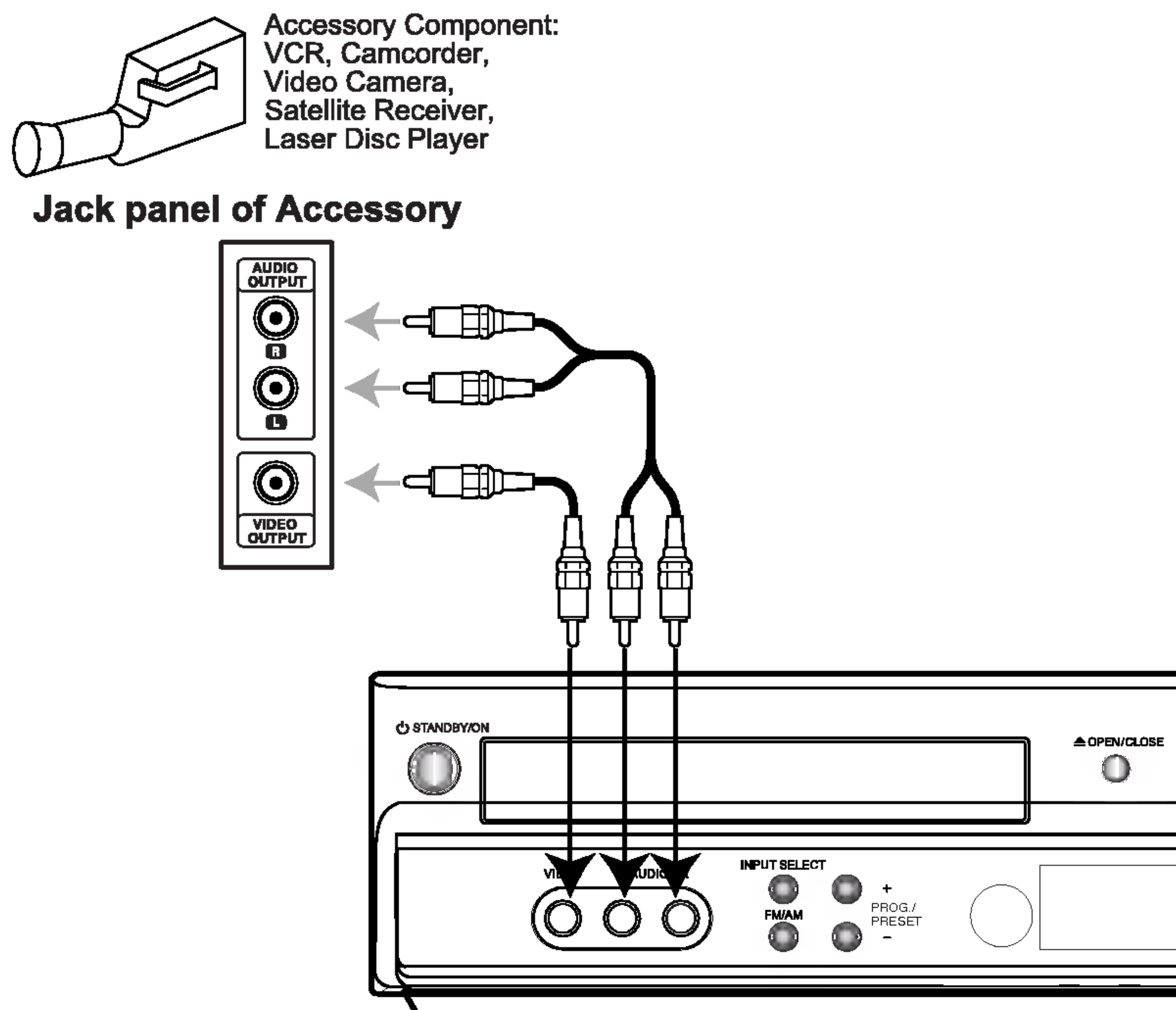

Radio Aerial Connections

Connect the supplied FM/AM aerial for listening to the radio.

- Connect the AM loop aerial to the AM aerial connector.
- Connect the FM wire aerial to the FM aerial connector.

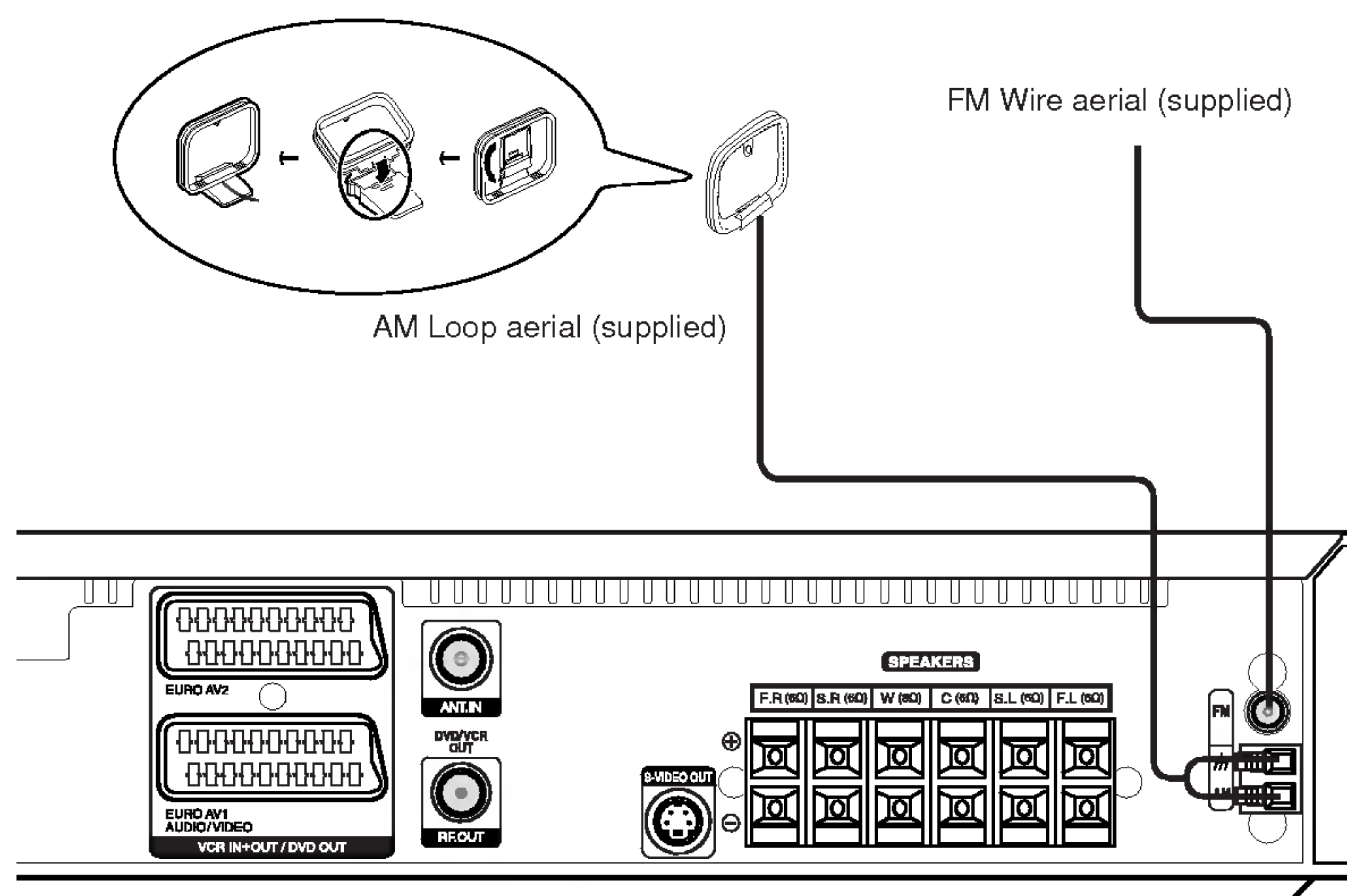

Notes

- To prevent noise pickup, keep the AM loop aerial away from the DVD/VCR Combi receiver and other components.
- Be sure to fully extend the FM wire aerial.
- After connecting the FM wire aerial, keep it as horizontal as possible.

Speaker System Connection

Connect the speakers using the supplied speaker cords.

To obtain the best possible surround sound, adjust the speaker parameters; distance, level, etc..

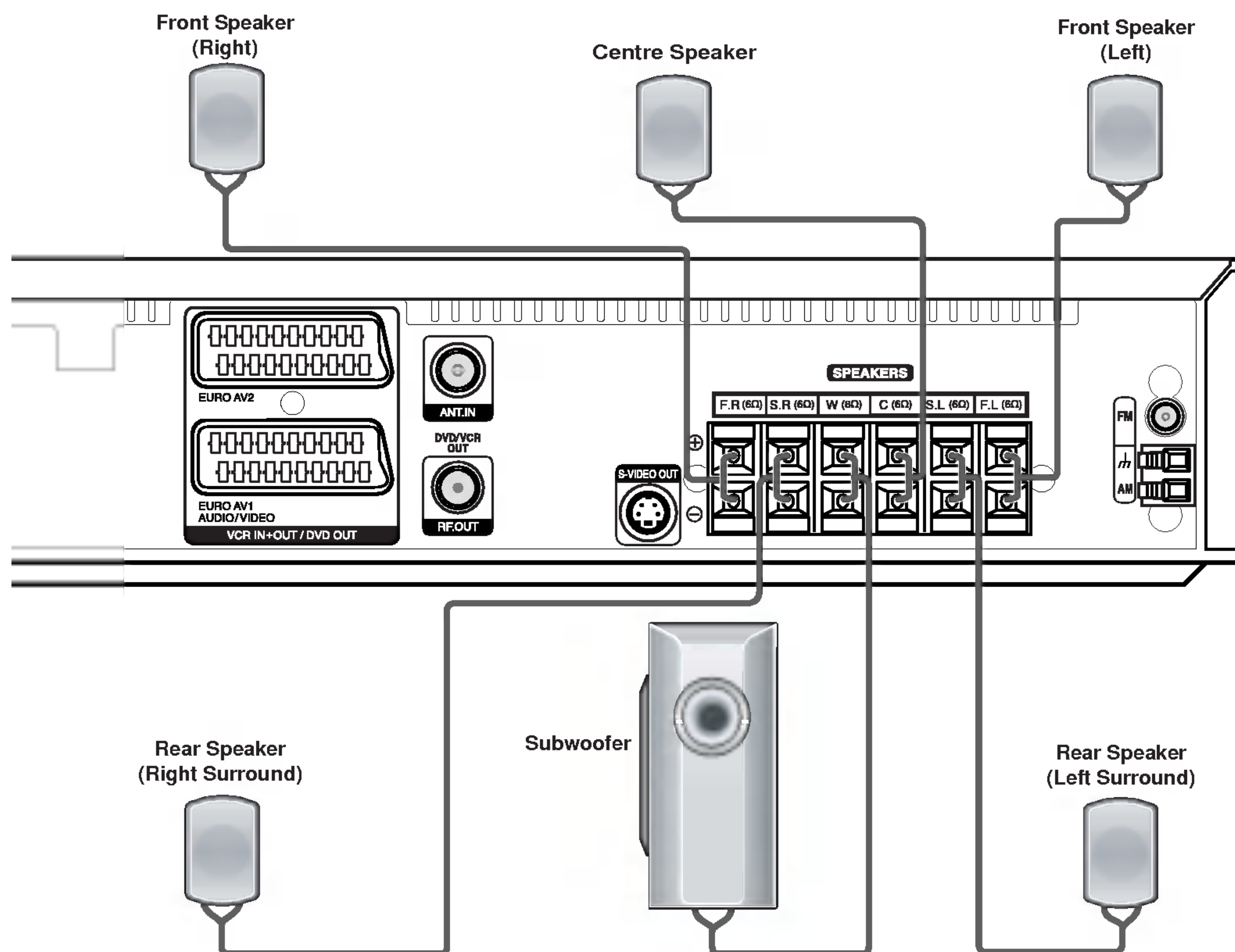

Notes

- Be sure to match the speaker cable to the appropriate terminal on the components: + to + and - to -. If the cables are reversed, the sound will be distorted and will lack base.
- If you use front speakers with low maximum input rating, adjust the volume carefully to avoid excessive output on the speakers.
- Do not remove the front cover of supplied speaker.

About Ferrite Core

Be sure to attach the ferrite core to the speaker cables (for connecting to this unit). This ferrite core can reduce noises.

How to attach the ferrite core

1. Push the stopper [a] of the ferrite core to open.
2. Wind the Subwoofer cable three times on the ferrite core (A). Wind the Subwoofer cable once on the ferrite core (B).
3. Pass the others straight on the ferrite core (B).
4. Close the ferrite core until it clicks.

Notes

- Take care not to pinch the speaker cables between the ferrite cores.
- Attach the ferrite core near the unit (Refer to the fig.3 and comment.).

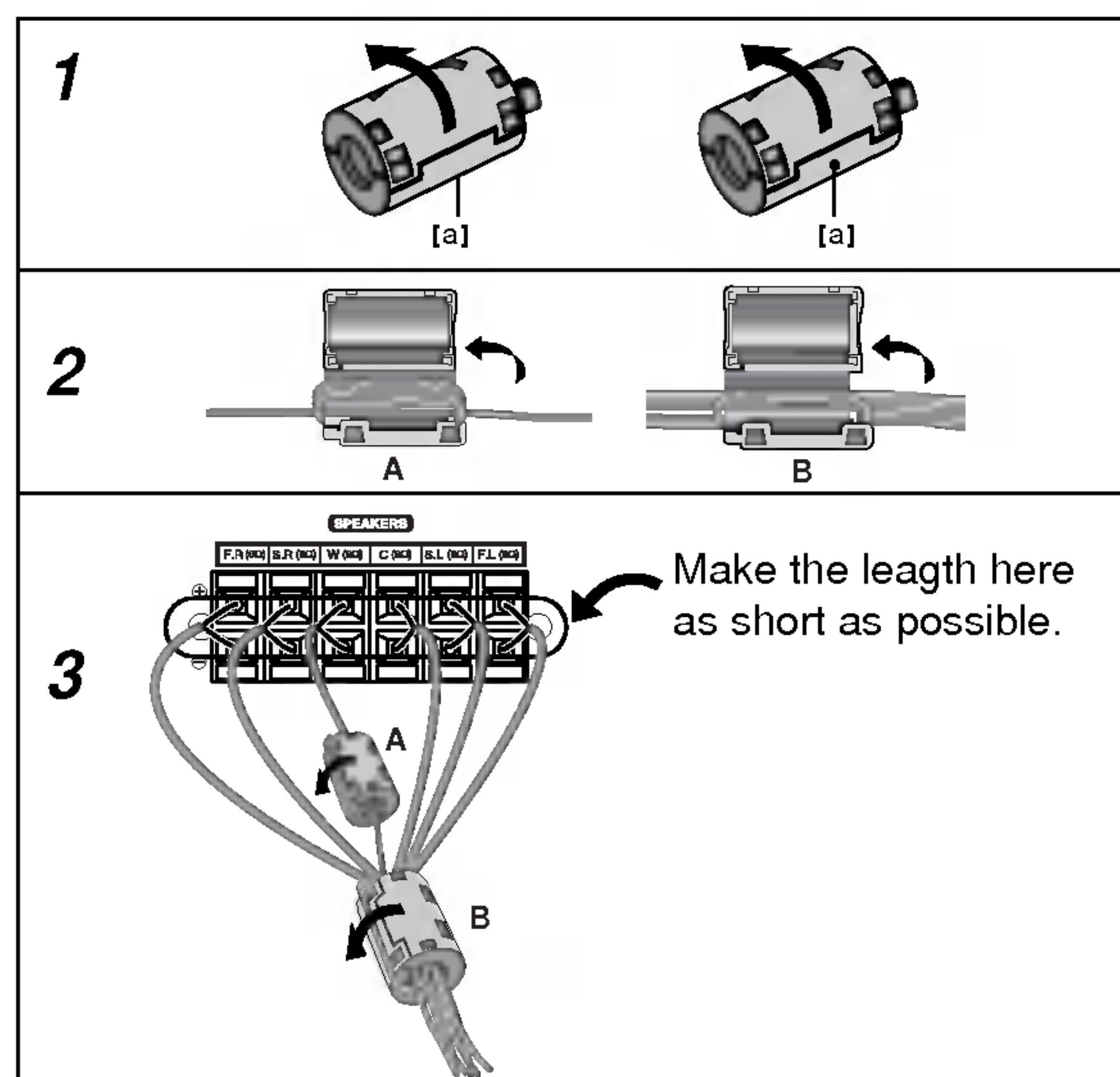

Speaker Positioning

In the case of normal position use the 6 speakers (2 front speakers, centre speaker, 2 rear speakers and subwoofer).

If you want to play the excellent bass sound, DTS digital surround or Dolby Digital surround, you should connect a subwoofer.

- **Front speakers**

According to your listening position set up the speakers for equal distance. And by hearing position set up the interval between speakers to 45 degree.

- **Centre speaker**

The centre speakers and front speakers are ideally the same height. But normally place it above or below the television.

- **Rear speakers**

Place left and right behind the listening area. These speakers recreate sound motion and atmosphere required for surround sound playback. For best results, do not install the rear speakers too far behind the listening position and install them at or above the level of the listener's ears. It is also effective to direct the rear speakers towards a wall or ceiling to further disperse the sound.

In the case of a smaller room size, if the audience is near to the rear wall set the rear speakers opposite each other, and set the rear speakers above 60 - 90 cm than the listener's ears.

- **Subwoofer**

This can be placed in any front position.

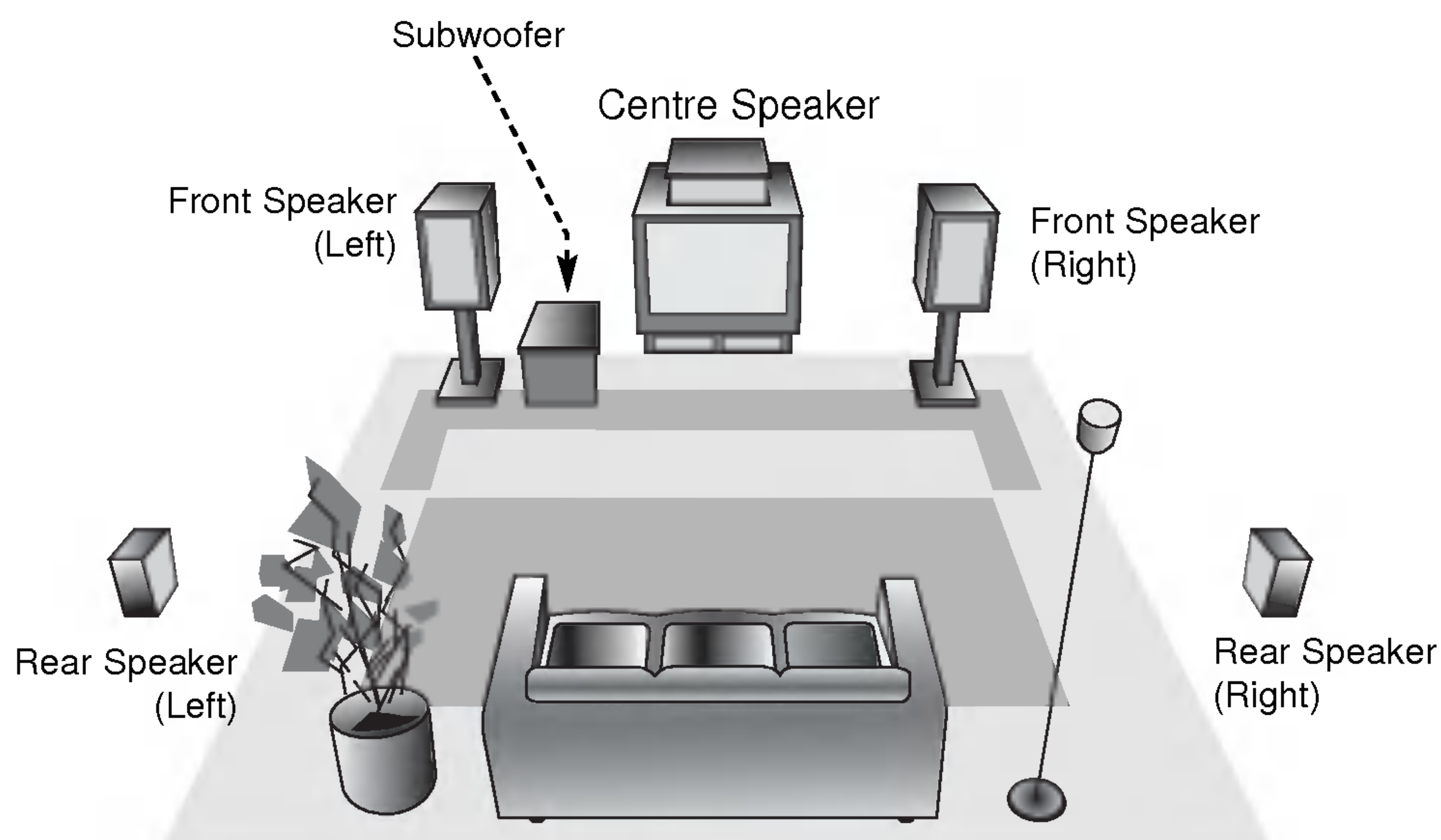

Speaker Positioning Example

Mini Glossary for Audio Stream & Surround mode

dtS

Allows you to enjoy 5.1(or 6) discrete channels of high quality digital audio from DTS program sources such as discs, DVD and compact discs, etc.bearing the trademark. DTS Digital Surround delivers up to 6 channels of transparent audio(which means identical to the original masters) and results in exceptional clarity throughout a true 360 degree sound field. The term DTS is a trademark of DTS Technology, LLC. Manufactured under license from DTS Technology, LLC.

DIGITAL

The Dolby Digital surround format lets you enjoy up to 5.1 channels of digital surround sound from a Dolby Digital program source. If you play DVDs with “” mark, you can enjoy even better sound quality, greater spatial accuracy, and improved dynamic range.

PRO LOGIC

Use this mode when playing movie or Dolby Digital 2 channel which carries the “” mark. This mode provides the effect of being in a movie theatre or live concert house-an effect with an intensity which can only be obtained through DOLBY PRO LOGIC SURROUND. The effect of the front/back/left/right movement of the sound image, as well as the sense of fixed position in the sound image, is much clearer and more dynamic than before.

PRO LOGIC (II)

Dolby Pro Logic II creates five full-bandwidth output channels from two-channel sources. This is done using an advanced, high-purity matrix surround decoder that extracts the spatial properties of the original recording without adding any new sounds or tonal colorations.

MOVIE mode:

The Movie mode is for use with stereo television shows and all programs encoded in Dolby Surround. The result is enhanced soundfield directionality that approaches the quality of discrete 5.1-channel sound.

MUSIC mode:

The Music mode is for use with any stereo music recordings, and provides a wide and deep sound space. The Music mode includes controls that allow the sound to be tailored to individual listening tastes.

MATRIX mode:

The Matrix mode is the same as the Music mode except that the directional enhancement logic is turned off. It may be used to enhance mono signals by making them seem “larger.” The Matrix mode may also find use in auto systems, where the fluctuations from poor FM stereo reception can otherwise cause disturbing surround signals from a logic decoder. The ultimate “cure” for poor FM stereo reception may be simply to force the audio to mono.

3D SURROUND

This unit can produce a 3D Surround effect, using 3D Surround Sound technology, which simulates multi-channel audio playback from two conventional stereo speakers instead of the five or more speakers normally required to listen to multi-channel audio from a home theatre. This feature works with DVD discs encoded with Dolby Pro Logic and Dolby Digital audio tracks.

BYPASS

Software with multichannel surround audio signals is played according to the way it was recorded.

Sound Mode

You can enjoy surround sound simply by selecting one of the pre-programmed sound fields according to the program you want to listen to.

Press **SOUND MODE** repeatedly until the sound mode you want appears in the display window as below.

Each time you press **SOUND MODE** button, the sound mode is changed in the following order;

PRO LOGIC → PL2 MOVIE → PL2 MUSIC → PL2 MATRIX → 3D SURROUND → BYPASS

When DVD is inserted.

You can change the stream of DVD (Dolby Digital, DTS, PCM, etc) by pressing the **AUDIO** button on the remote during playback.



Although the DVD contents differ from disc to disc, the following explains the basic operation when this feature is used.

Each time you press **AUDIO** button, the sound mode of DVD is changed as the following order;

DIGITAL → **dtS** → **PCM** → **DIGITAL**



For your reference

- The DVD/VCR Combi receiver memorizes the last mode settings for each source individually.
- You can identify the encoding format of program software by looking at its packaging.
 - Dolby Digital discs are labeled with the  logo.
 - Dolby Surround encoded programs are labeled with the  logo.
 - DTS Digital Surround discs are marked with DTS.

Note

- When you play sound tracks with 96kHz sampling frequency, the output signals will be converted to 48kHz (sampling frequency).

Before Operation-VCR part

Tuning in a video channel on your TV

Notes

- The output frequency of this video recorder (VCR) is set at UHF channel 60. If channel 60 is already used by another TV station, or if the picture is distorted, you can change the transmitter channel of your DVD/VCR Combi receiver. Stages 5 ~ 8 will show you how to change the output frequency of your DVD/VCR Combi receiver.
- Your TV receives signals from the video recorder (VCR) like another TV station. You have to select a channel number on your TV and tune it in so that you may watch video tapes. If you have used a **SCART** cable then your TV should already have a dedicated video channel built into it, usually called **AV**.

1. Make sure that you have correctly installed your VCR as described earlier in this book. Press **POWER** to turn on your DVD/VCR Combi receiver. Turn on your TV.
2. Insert a pre-recorded video tape into your DVD/VCR Combi receiver and press **PLAY** on the remote control. Select a TV channel number on which you wish to watch video's. Don't worry if you don't have a video-tape to play at this stage! If you switch your DVD/VCR Combi receiver on and continue stages 3 ~ 4, instead of seeing video playback tune your TV until you see a bright blue screen.
3. Tune this channel until the video picture is sharp and the sound is clear. If you have used a **SCART** cable you will not have to tune your TV, simply select the AV channel. The **AV** channel is already pre-tuned for optimum video playback on your TV.
4. Store this channel on your TV. You will need to look at the TV instruction book if you do not know how to do this.
5. **Only carry out stages 5 ~ 8 if you cannot obtain clear video playback as described in stages 1 ~ 4.** Select a TV channel number on which you wish to watch video's. Make sure that your DVD/VCR Combi receiver is in standby pressing **POWER** on the remote control (only the clock will be displayed).
6. Press **PROG.** + or - on the front of your DVD/ VCR Combi receiver for more than 4 seconds. **RF60** will appear in the display window. The following picture will be displayed on the TV screen.

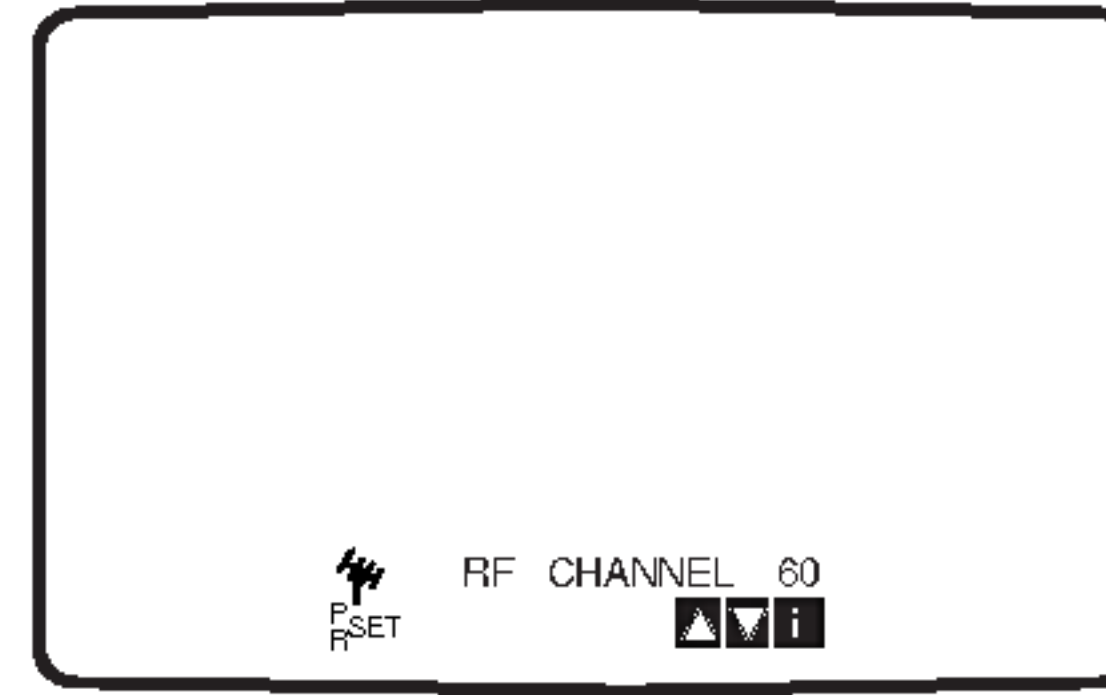

7. Press **PROG.** + or - to select another video channel. You may select any channel number between 22 and 68. You can also set it to "OFF" if there is any interference when your TV is connected to the DVD/VCR Combi receiver with a SCART lead.
8. Select a TV channel number on which you wish to watch video's. Press **STANDBY/ON** on the front of your DVD/VCR Combi receiver when you have finished. Tune this channel so that a bright blue screen appears. Store this channel on your TV.

Notes

Make sure that you have correctly installed your DVD/VCR Combi receiver and successfully tuned in a dedicated video channel on your TV. If you do not tune in a dedicated video channel on your TV you will be unable to view and record video tapes!

Using your VCR for the very first Initial preset

For the following steps we do assume that you have just connected your video recorder for the very first time. In this case the video recorder is on after mains connection. You should not touch any buttons yet. On the connected TV you will now see.

Note - If this menu does not appear, your video recorder was programmed already.

1. Select the country according to your area with **◀** and **▶**.
 "A": Austria, "B": Belgium, "CH": Switzerland, "D": Germany, "DK": Denmark, "E": Spain, "F": France, "I": Italy, "N": Norway, "NL": Netherlands, "P": Portugal, "S": Sweden, "SF": Finland, OTHERS.

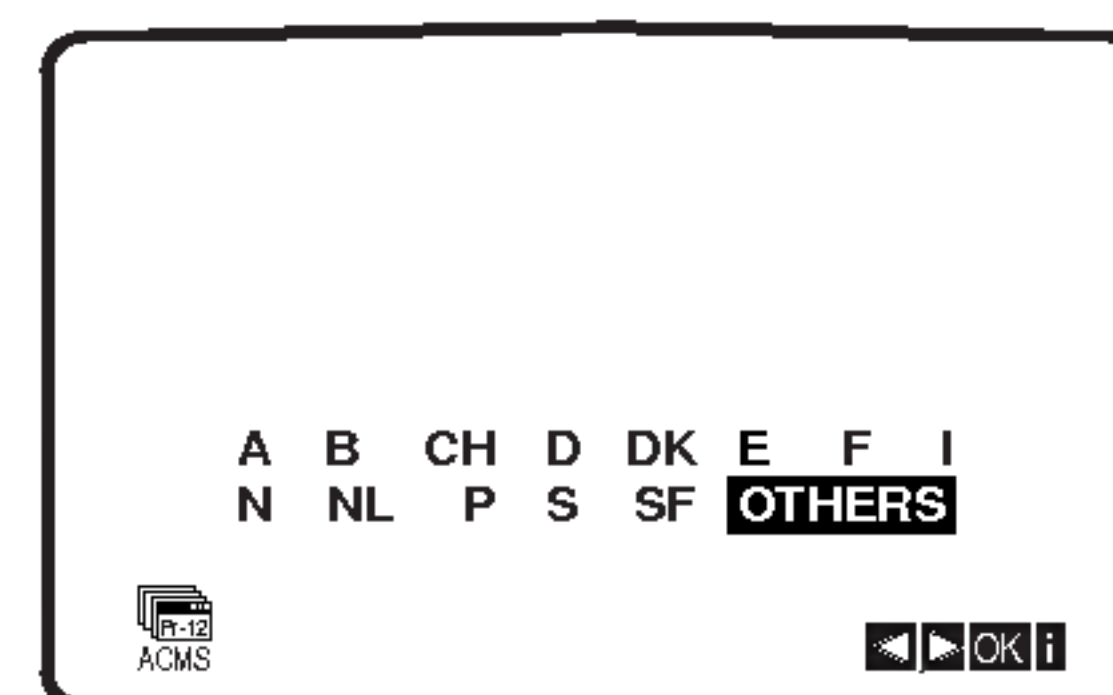

2. Press **OK** to start the automatic storing of the channels of the TV stations in your area.

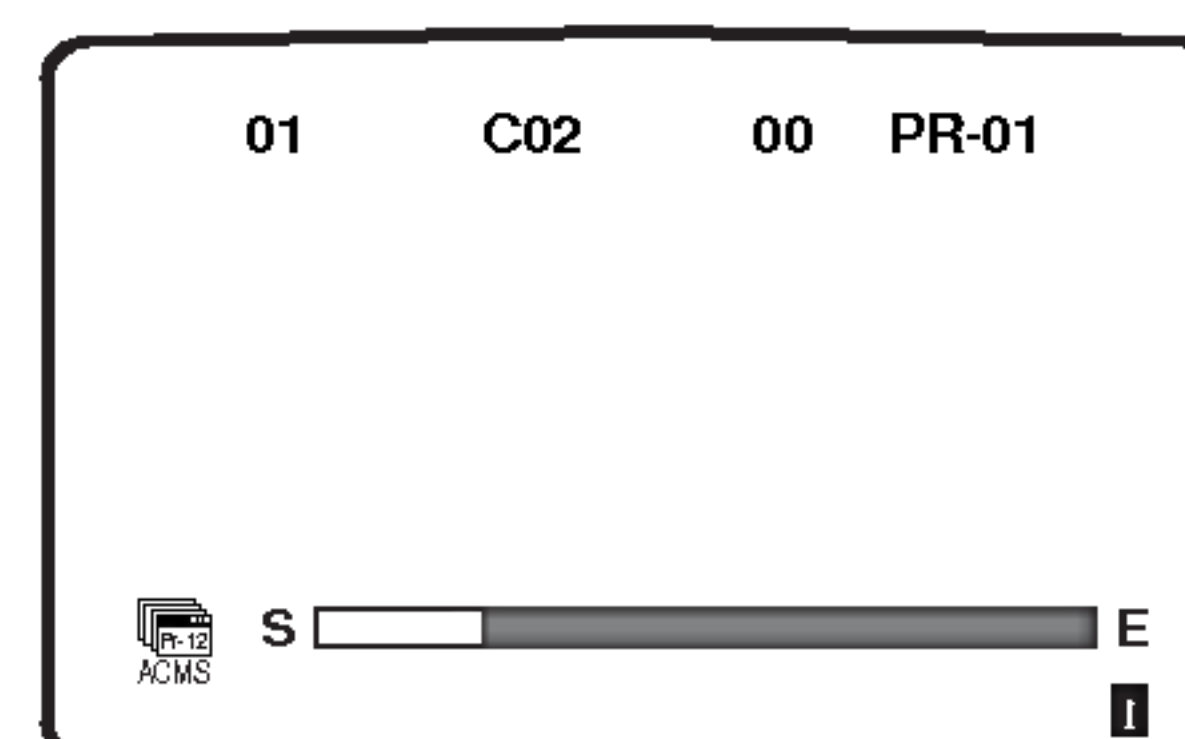

Setting the clock Manually

The clock in your DVD/VCR Combi receiver controls time and date settings for your DVD/VCR Combi receiver.

1. Press **i**.
Press ◀ or ▶ to select **TIME DATE**.
Press **OK**.

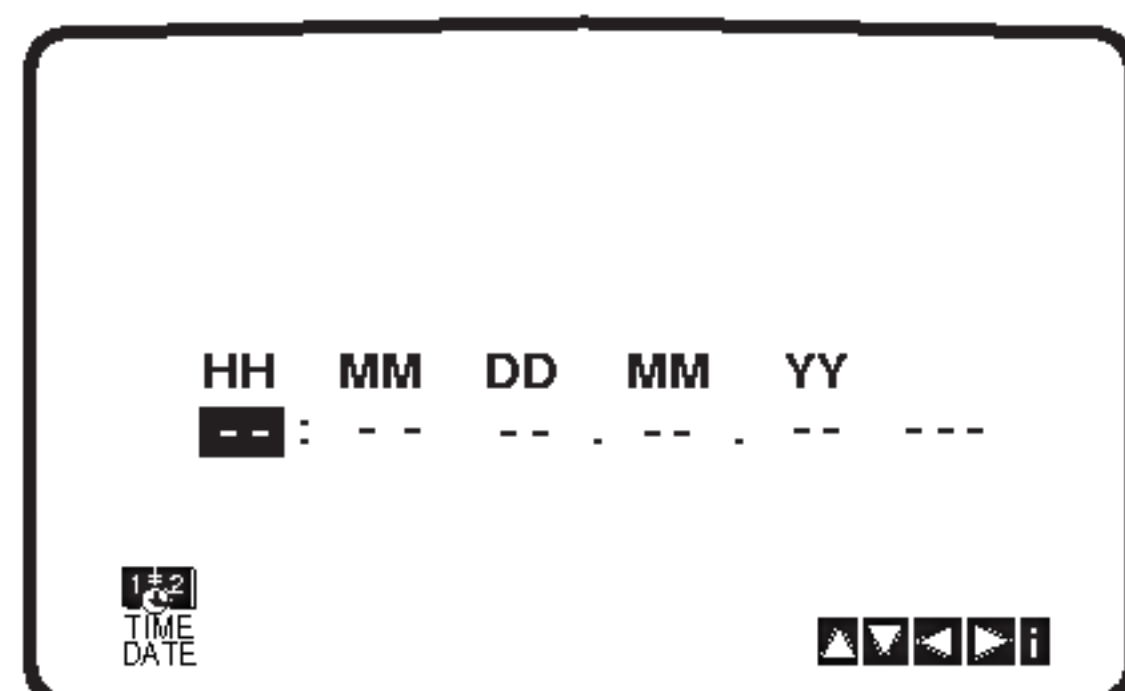

2. Use the **numbered buttons** on the remote control to alter the **HOURS, MINUTES, DAY, MONTH** and **YEAR**.
Please note your VCR uses a 24 hour clock. e.g. 1pm will be displayed as 13:00.
The day of the week will appear automatically when you enter the year.

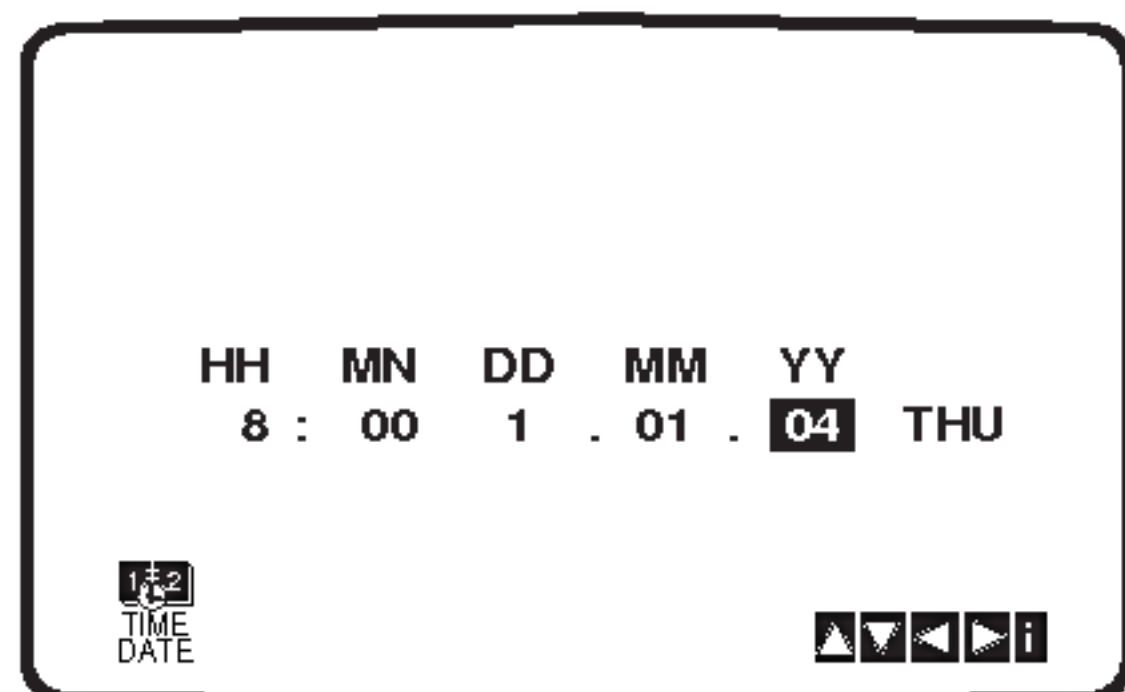

3. If you make a mistake press ◀ or ▶ and enter the correct details.
4. Press **i**.

To set the colour system

1. Press **i**.
2. The main menu will appear on the TV screen.
3. Press ◀ or ▶ to select the **SYSTEM** and press **OK**.
4. Press ▲ or ▼ to select according to the **COLOUR** system used.

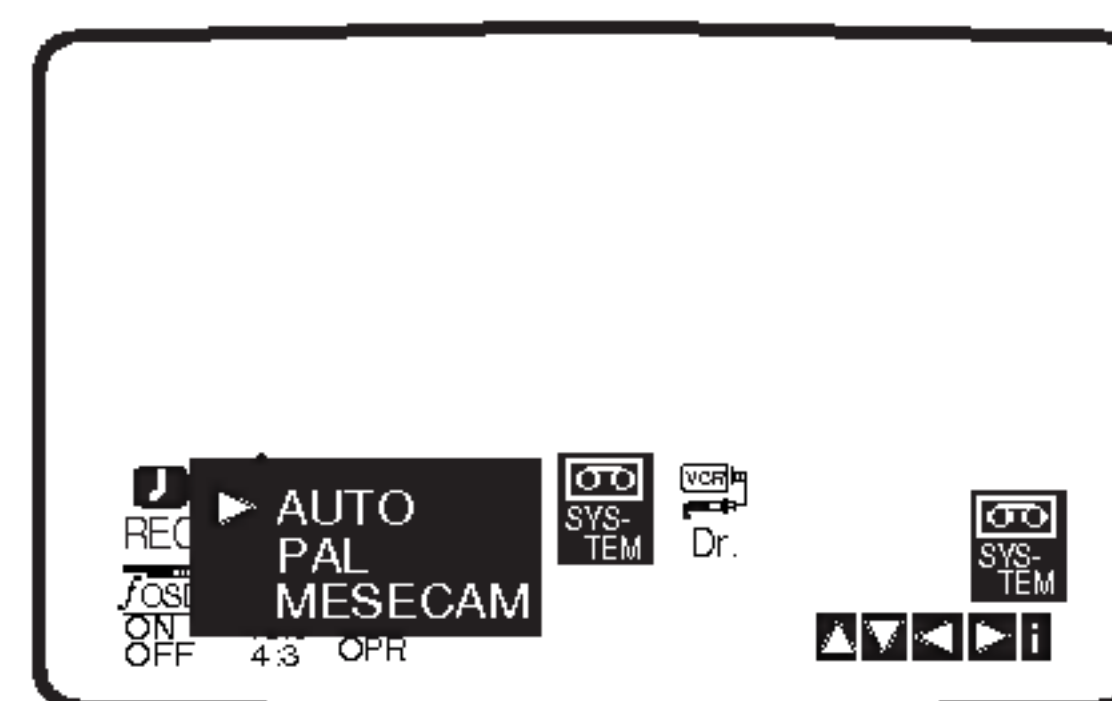

5. Press ◀ or ▶ to select the **RF AUDIO**.
Press ▲ or ▼ to select according to the **RF AUDIO** used.

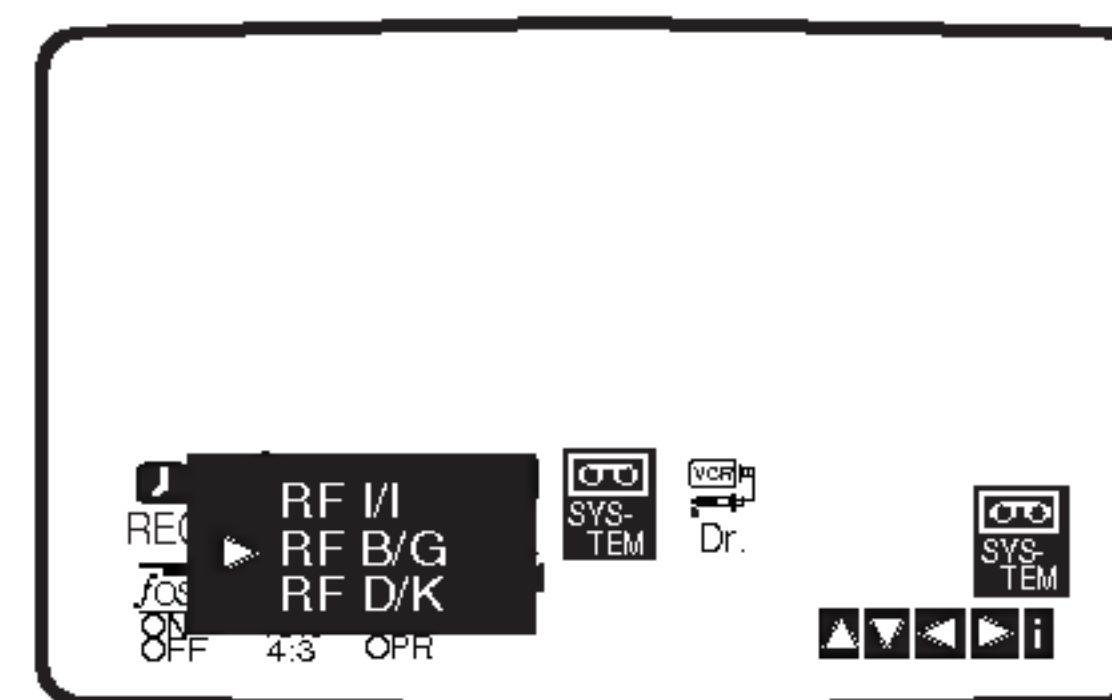

6. Press **i** to remove the menus from the TV screen.

How to use the main menu

This DVD/VCR Combi receiver can easily be programmed by using the menus displayed on screen. The menus are controlled from the Remote Control Handset.

1. Switch on your TV set and DVD/VCR Combi receiver by pressing the **POWER** button.
2. Press **i** button.
The main menu will appear on the TV screen.

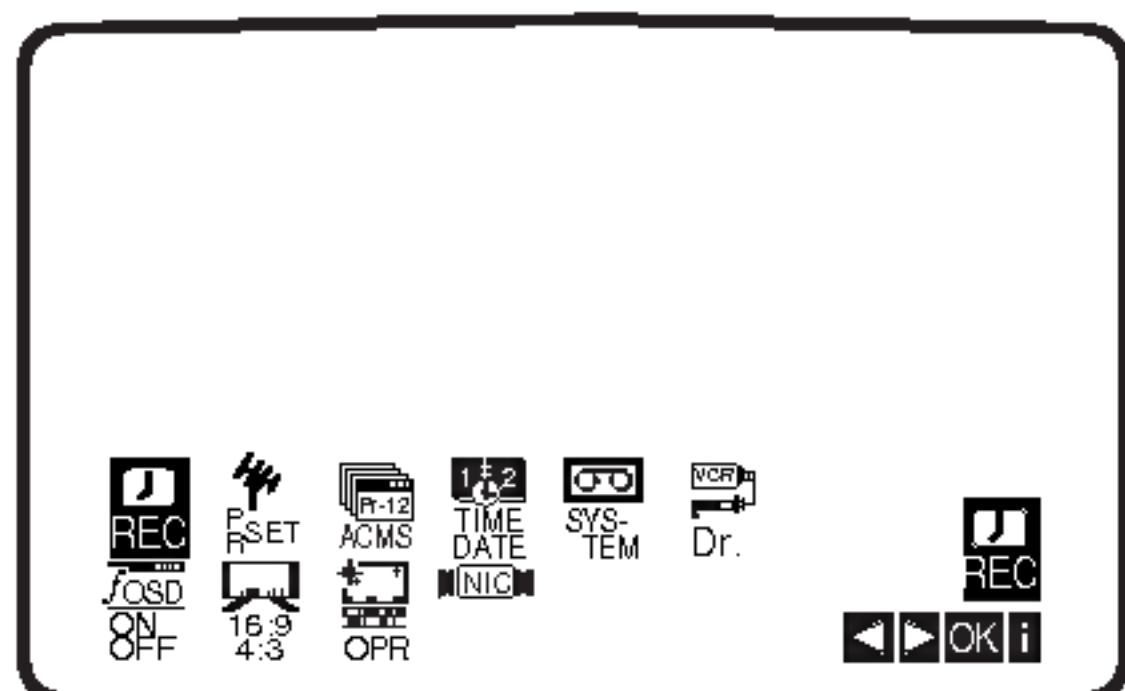

- **REC**
Timer recording setting (see p. 30).
- **PR SET**
Manual tuning setting (see p. 20).
- **ACMS**
ACMS (Automatic Channel Memory System) (see right column).
- **TIME DATE**
Date & clock setting (see p. 18).
- **SYSTEM**
To set the Colour TV System (see p. 18).
- **Dr.**
To check a problem with your DVD/CD/VCR receiver (see p. 42).
- **fOSD ON/OFF**
To display the operational mode of your DVD/VCR Combi receiver (see p. 42).
- **16:9/4:3**
To select the aspect ratio of your TV (see p. 43).
- **OPR**
To improve the playback picture (see p. 27).
- **NIC**
To activate or deactivate the NICAM digital sound (see p. 43).

Tip:

You can change the menu language on the DVD setup menu. (See the Menu Language on page 23.)

3. Press ◀ or ▶ to select the desired menu.
Press OK and press ▲ or ▼ to select.
5. Press **i** to return to a TV picture.

Tuning in TV Stations Automatically

If the TV broadcast signal is weak your DVD/VCR Combi receiver may not detect the necessary information and will not be able to store them correctly. To overcome this problem please turn to the **MANUAL TUNING** section on page 20.

1. Press **POWER** to turn on your DVD/VCR Combi receiver.
2. Press **i** button.
The main menu will appear on the TV screen.
Press ◀ or ▶ to select the **ACMS**. Press **OK**.

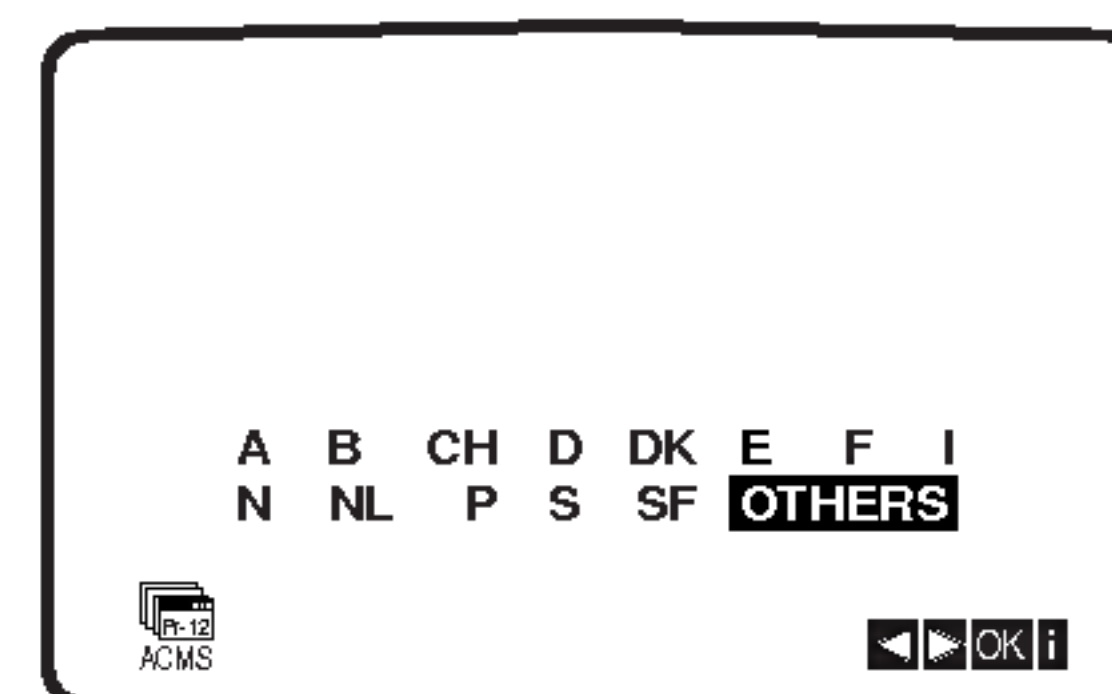
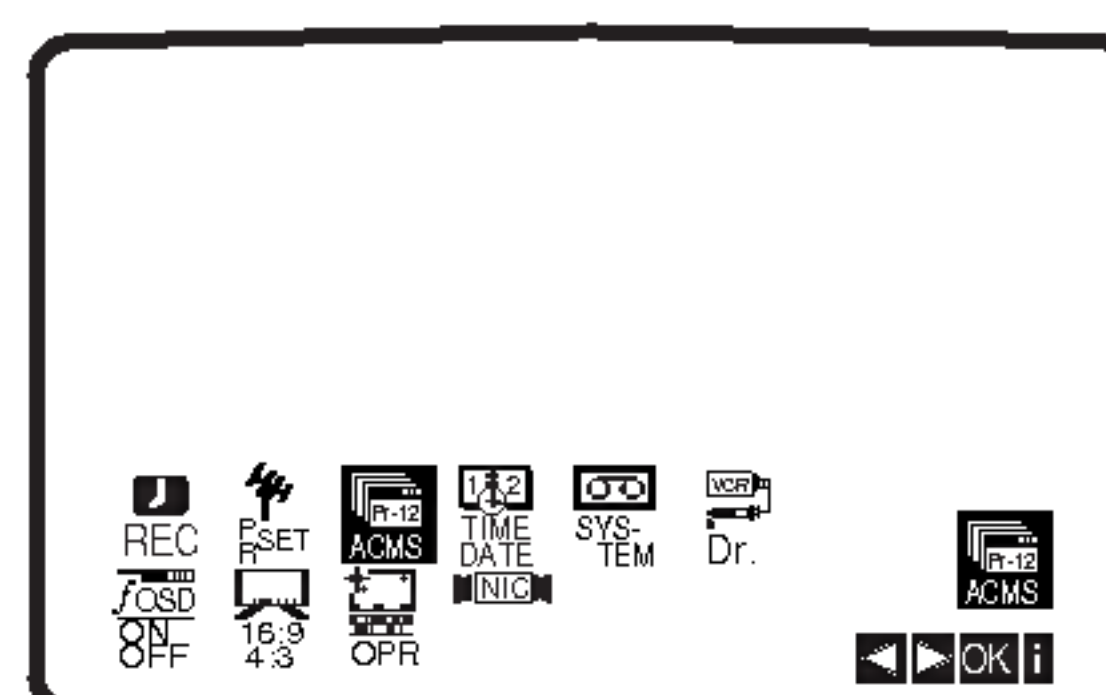

3. Press ◀ or ▶ to select **COUNTRY**.
(**A:Austria**, **B:Belgium**, **CH:Switzerland**, **D:Germany**, **DK:Denmark**, **E:Spain**, **F:France**, **I:Italy**, **N:Norway**, **NL:Netherlands**, **P:Portugal**, **S:Sweden**, **SF:Finland**, **OTHERS**)
Press **OK** again to start the automatic tuning process.

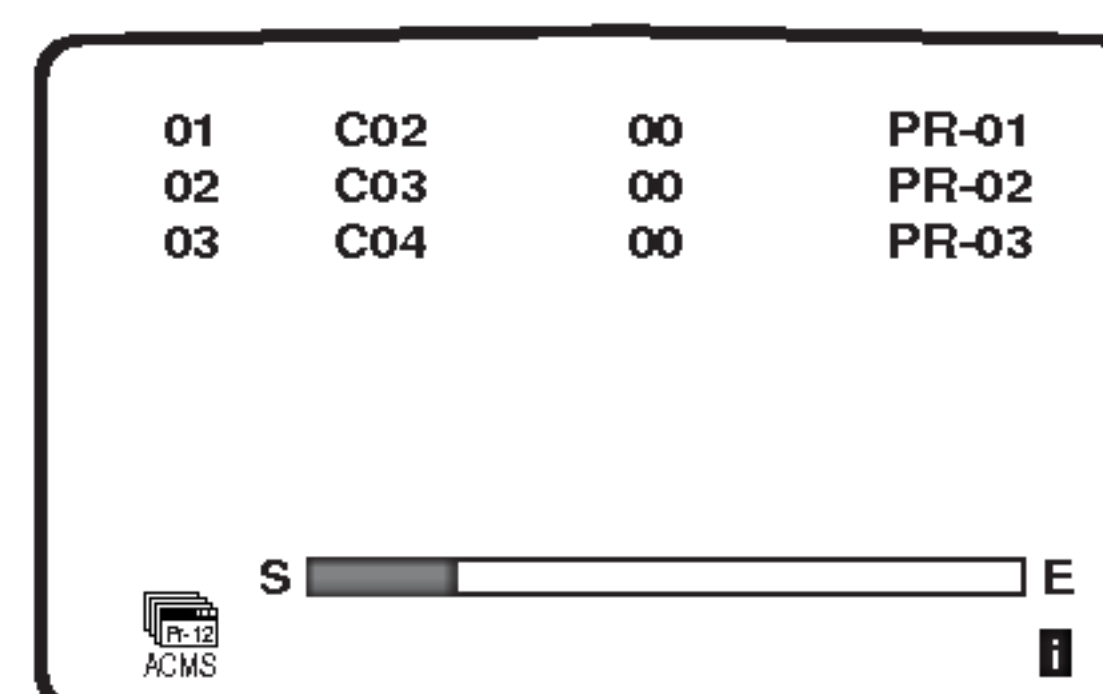

4. Press **i** to remove the menus from the TV screen.
Press **i** to save your settings.

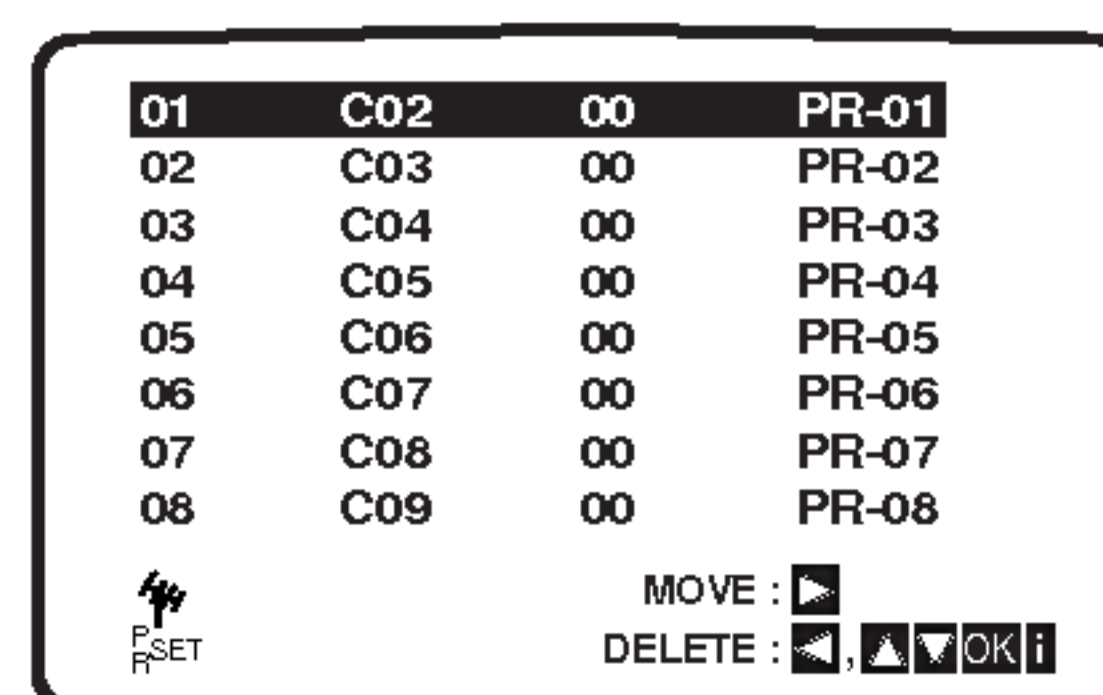

Tuning in TV Stations Manually

In certain areas of the country broadcast signals may be too weak for your DVD/VCR Combi receiver automatic tuning process to find or assign TV stations correctly.

You must tune in these weaker broadcast stations manually in order for your DVD/VCR Combi receiver to store them.

1. Press **i**.

The main menu will appear on the TV screen. Press **◀** or **▶** to select the **PR SET**. Press **OK**.

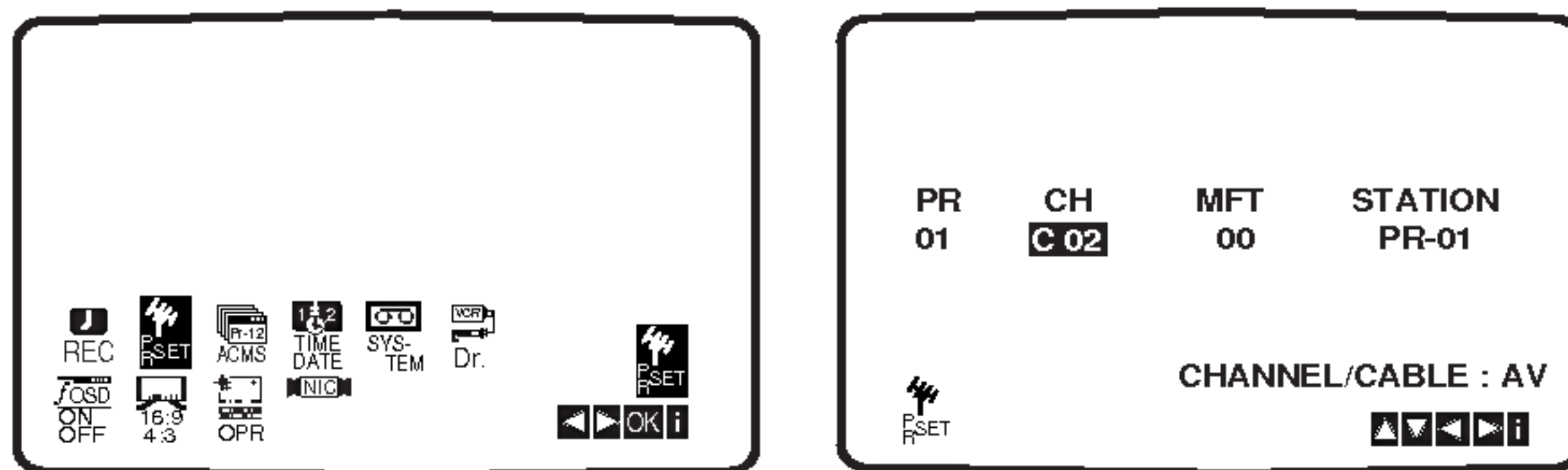

2. Press **i**.

The station table will appear. Press **▲** or **▼** to select the programme number that you want to tune (for example, PR 09).

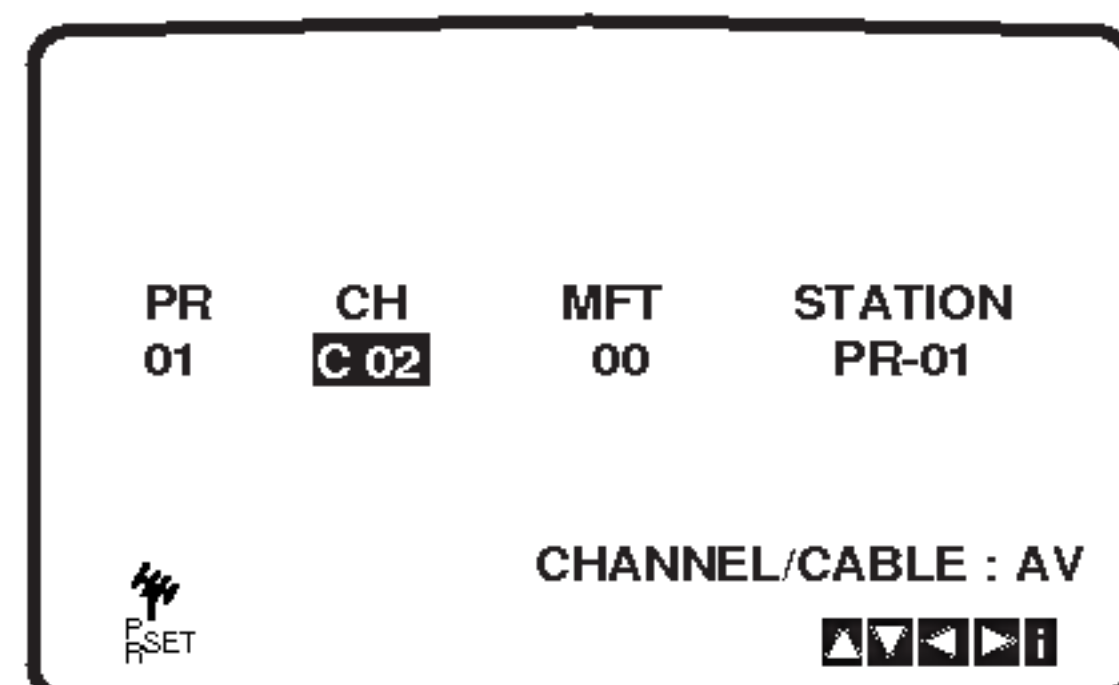

3. Press **OK**.

Press **AV** to select **C** (Standard stations) or **S** (Cable stations):
C02 - C69, S01 - S41.
Enter the channel number of station that you want to tune with **the numbered buttons** or use **▲** or **▼** to find the required station.

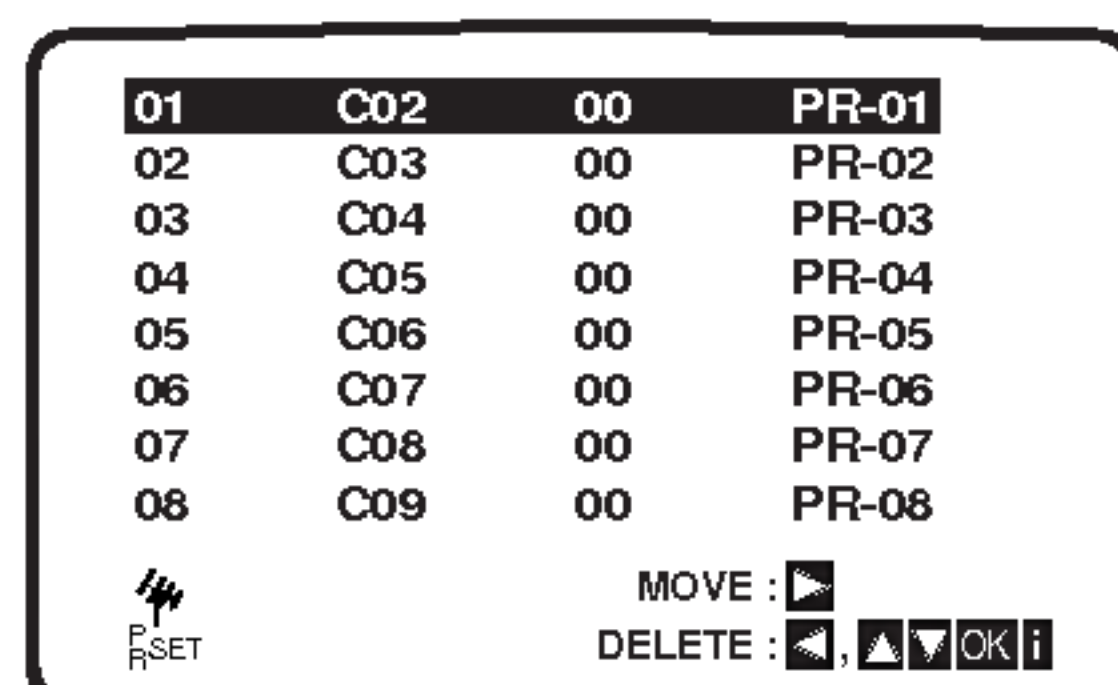

4. Searching will stop when it locates a station.

Press **▶** to select **MFT**. Press **▲** or **▼** to adjust.

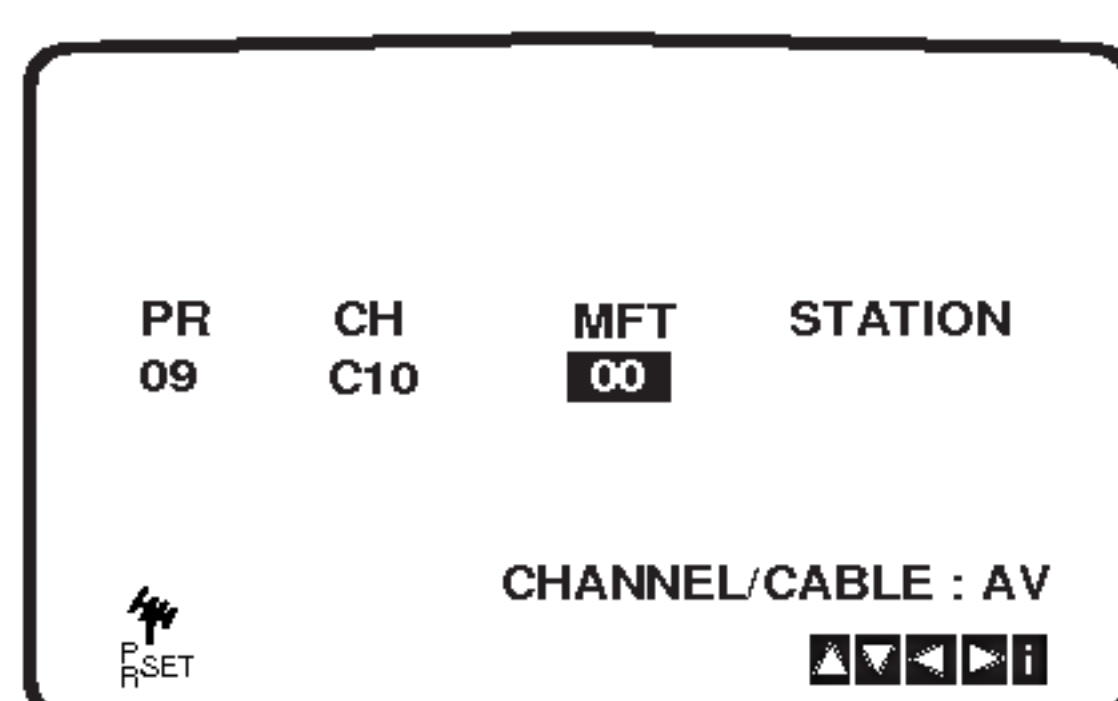

5. Press **▶** to select **STATION** so that you may name your TV station. Press **OK**. The TV station name list will appear.

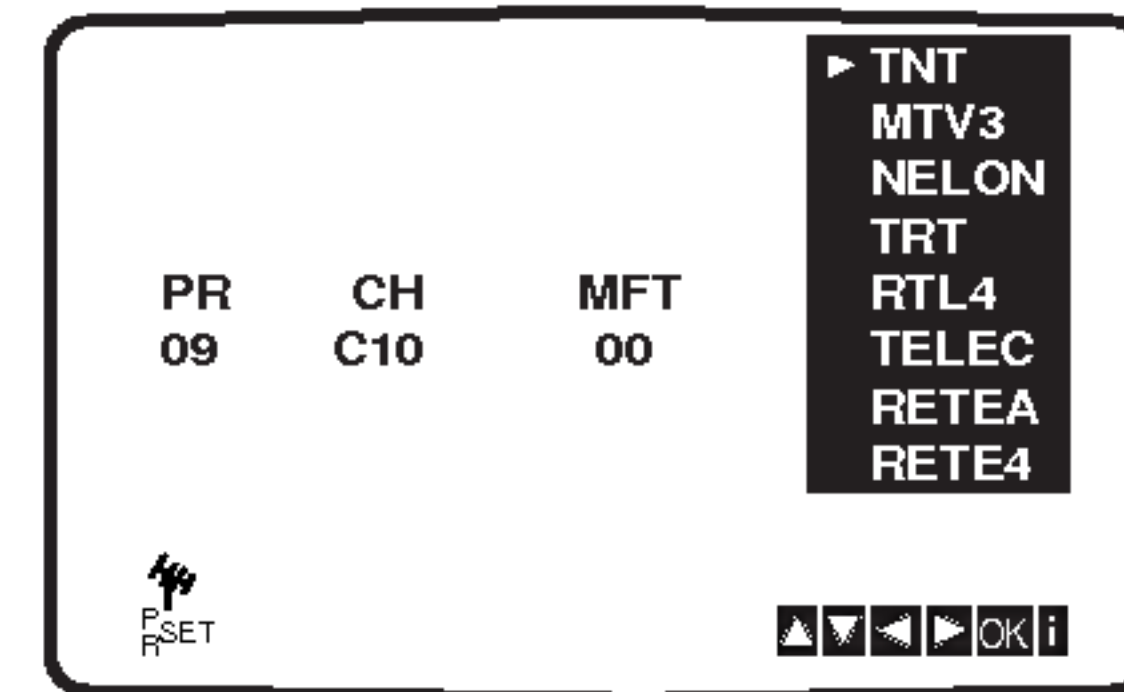

6. Press **▲** or **▼** to select a station name from the list. Press **OK** to select it.

If your station name isn't on the list do not press **OK**, but go to stage 7.

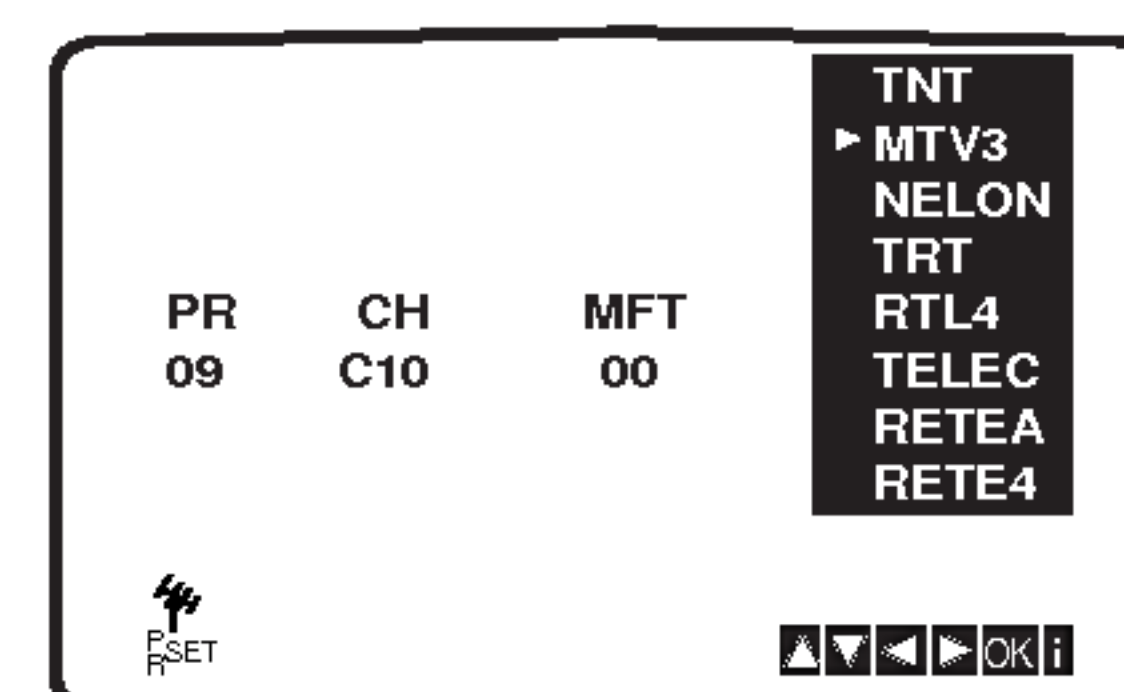

7. You can change a TV station name manually rather than using the "standard" names. Press **▶**. Press **▲** or **▼** to select **letters** and **numbers** for the new station name. Press **◀** or **▶** to move back and forth between characters. Press **OK**.

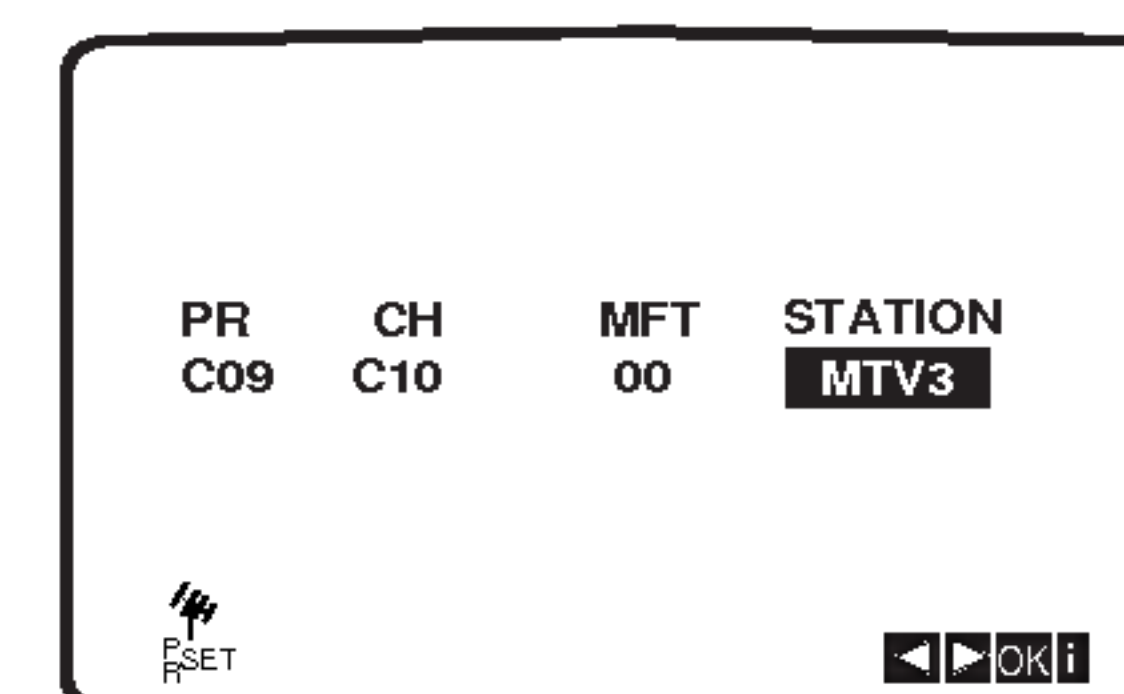

8. Press **i**, confirm the station placement. Press **i** again. Your new TV station has now been tuned into your DVD/VCR Combi receiver. If you wish to manually tune other stations repeat stages **1 - 8**.

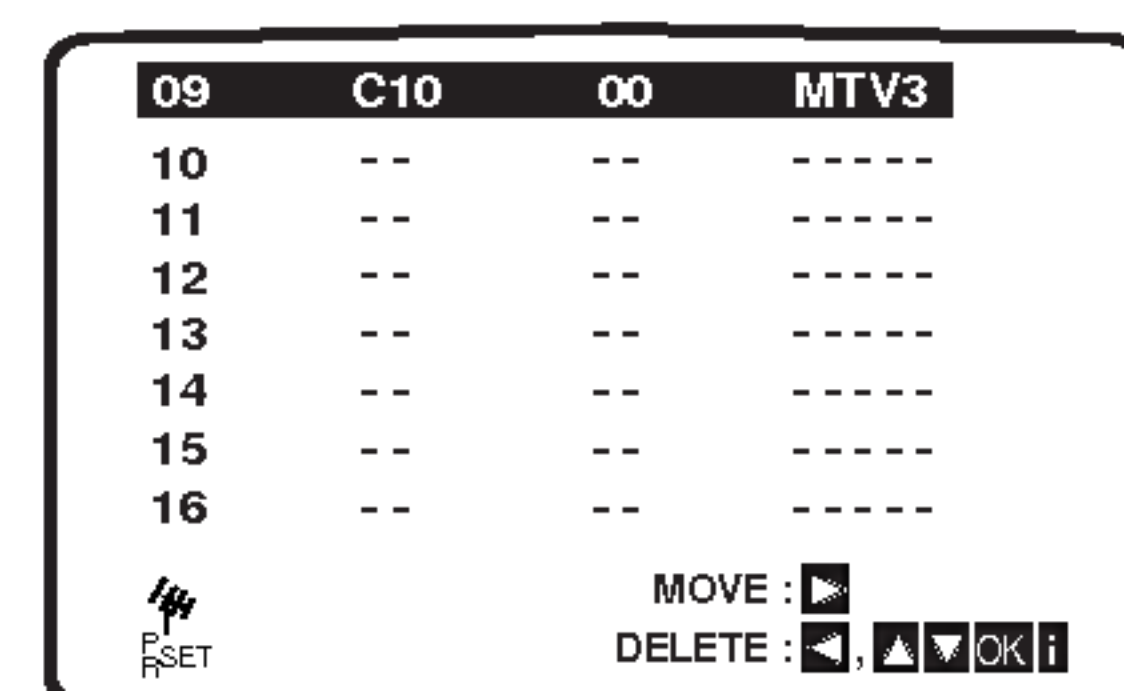

Changing the order of TV Stations

After tuning TV stations into your DVD/VCR Combi receiver you may wish to change the order in which they are stored without having to retune them against! The instructions given on this page will show you how you can simply move them into your desired order.

1. Press **i**.
The main menu will appear on the TV screen.
Press **◀** or **▶** to select the **PR SET**.
Press **OK**.

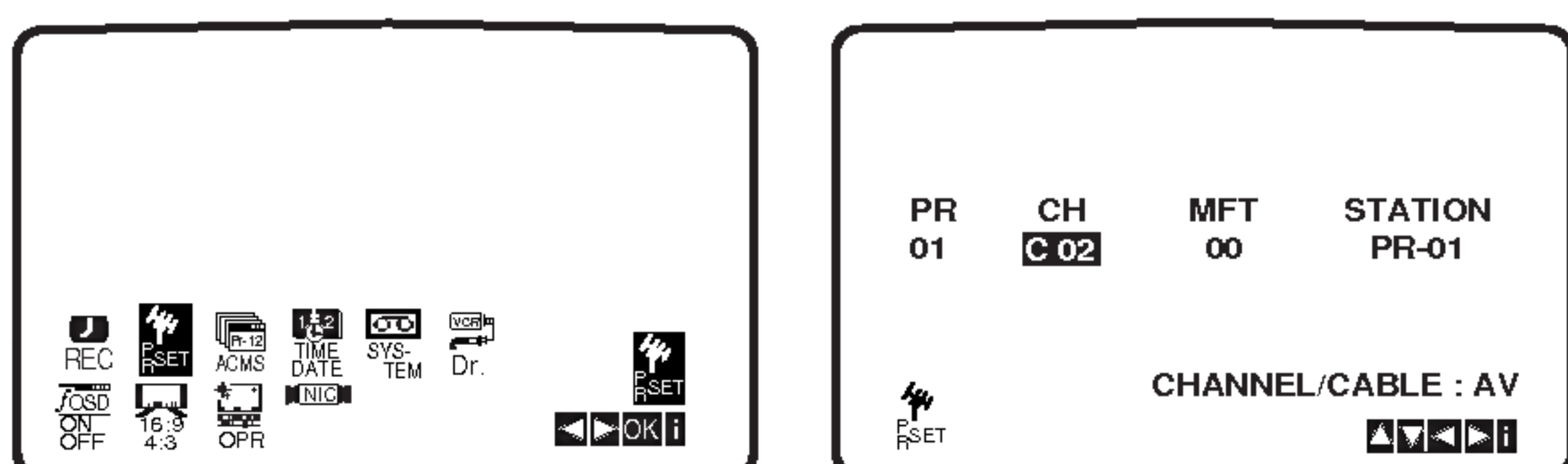

2. Press **i**.
Press **▲** or **▼** to select the **programme number** you want to move (for example, PR 03).
Press **▶**.

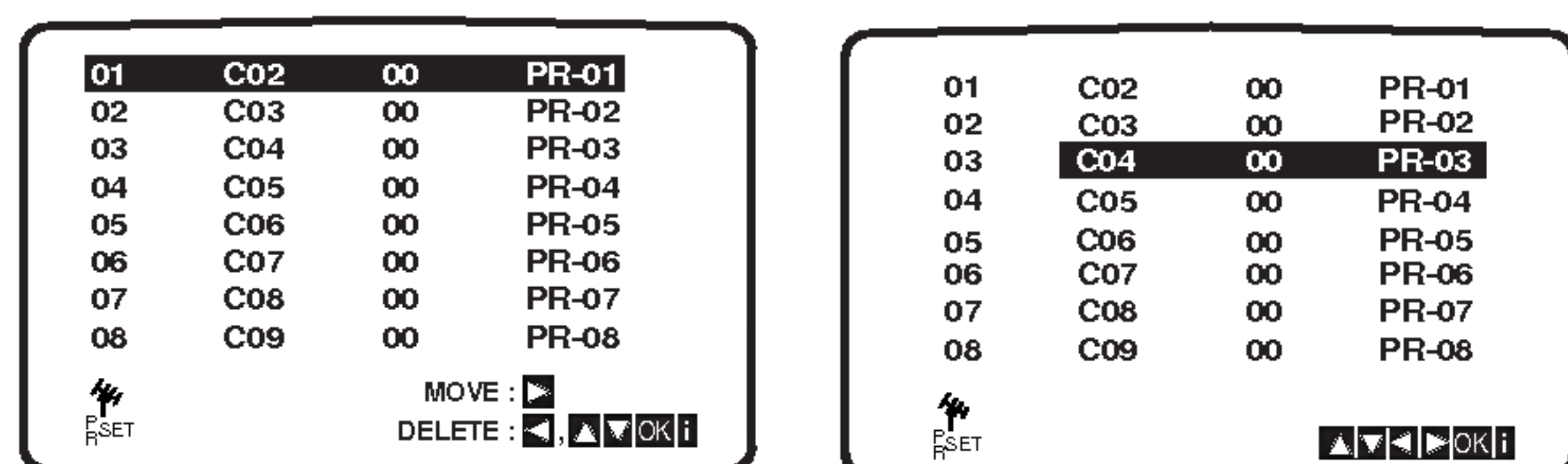

3. Press **▲** or **▼** to select the **programme number** you want to move to (for example, PR 05).

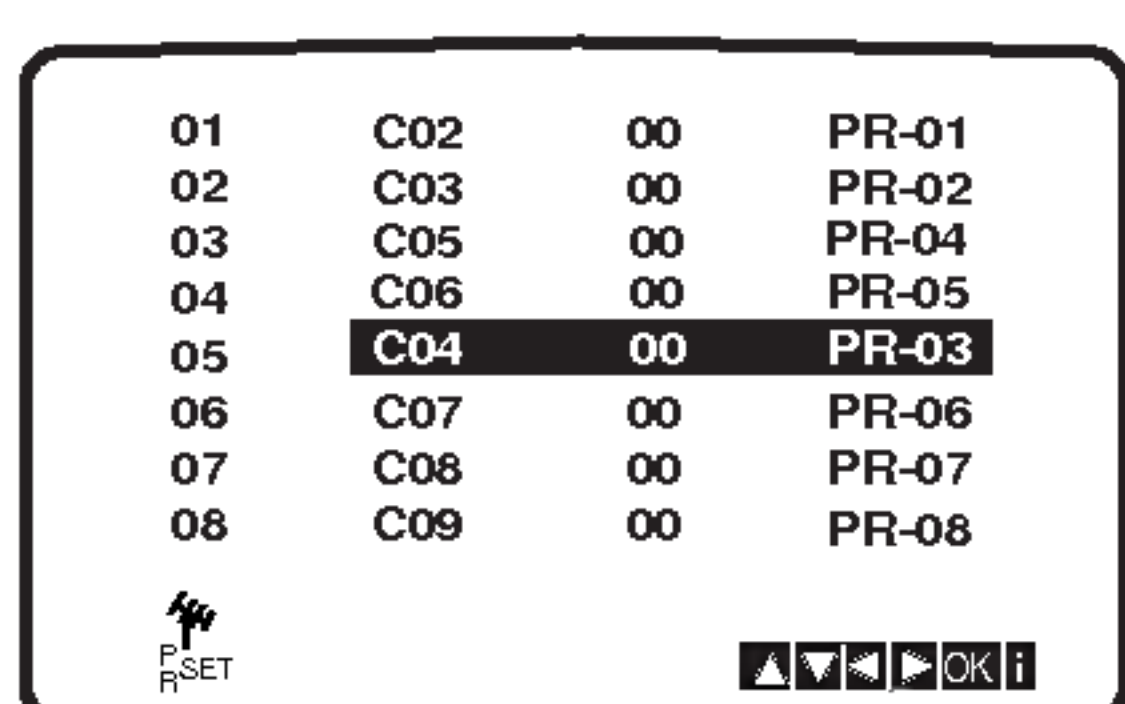

4. Press **OK**.
The selected **programme** will be moved to the **new programme number**.
If you wish to move other TV stations repeat stages 1 - 4.
Press **i** to remove the menus from the TV screen.

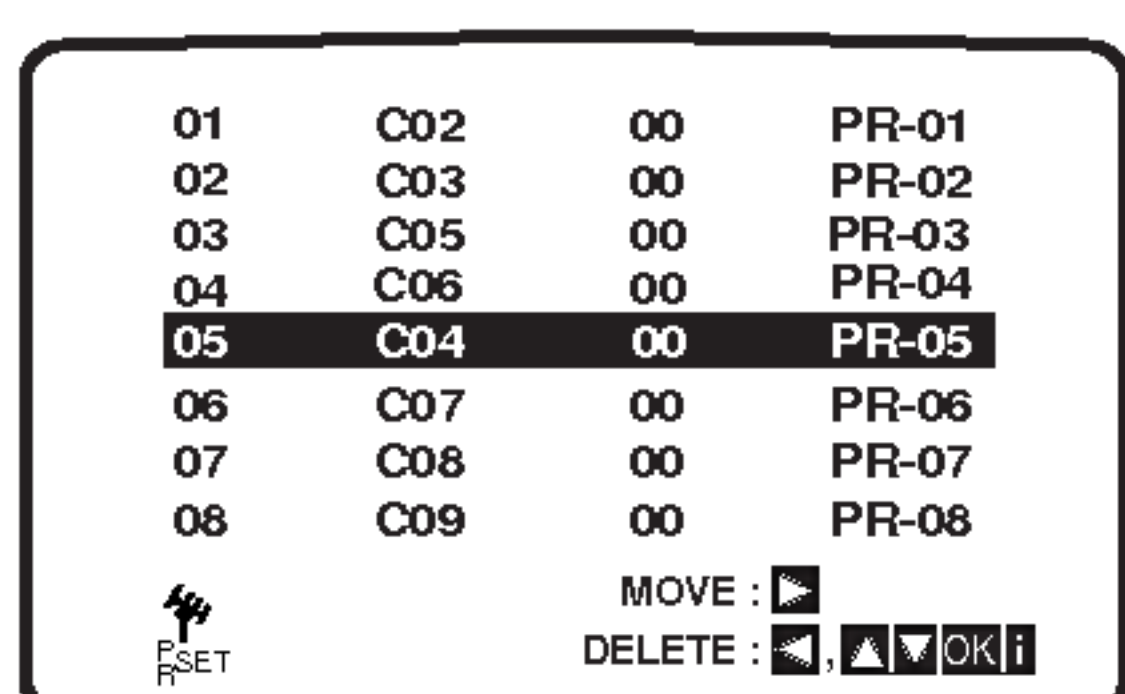

Deleting TV Stations

After tuning TV stations into your DVD/VCR Combi receiver you may wish to delete a station. The instructions given on this page will show you how easily delete any unwanted TV stations.

1. Press **i**.
The main menu will appear on the TV screen.
Press **◀** or **▶** to select the **PR SET**.
Press **OK**.

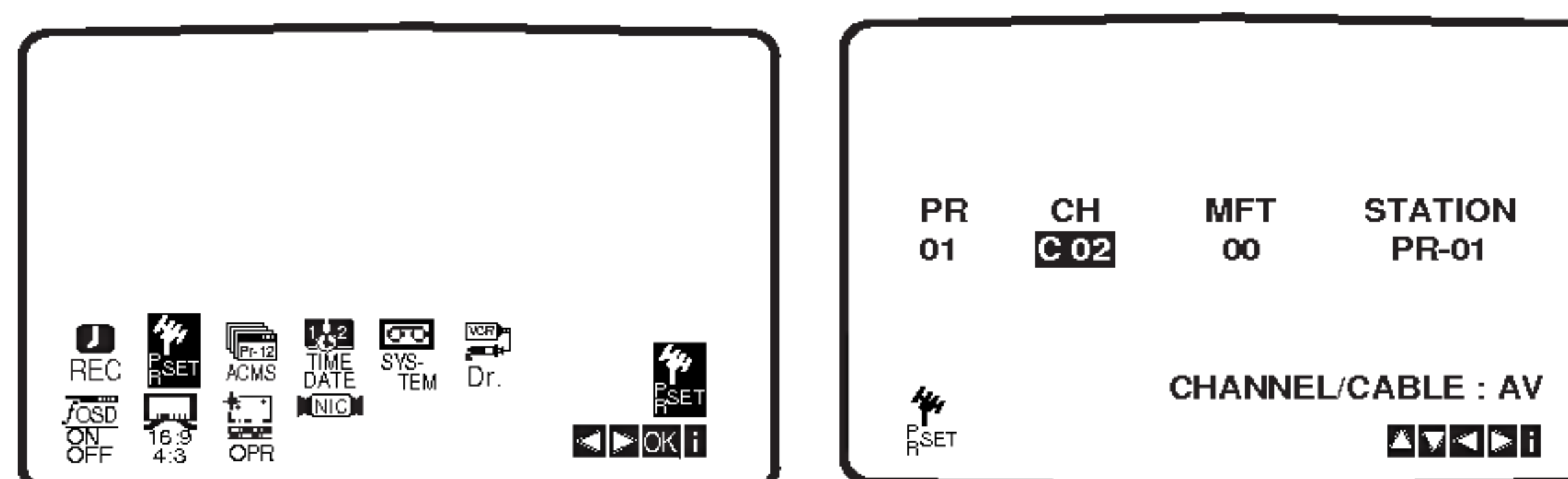

2. Press **i**.
Press **▲** or **▼** to select the **programme number** you want to delete. (for example, PR 03)

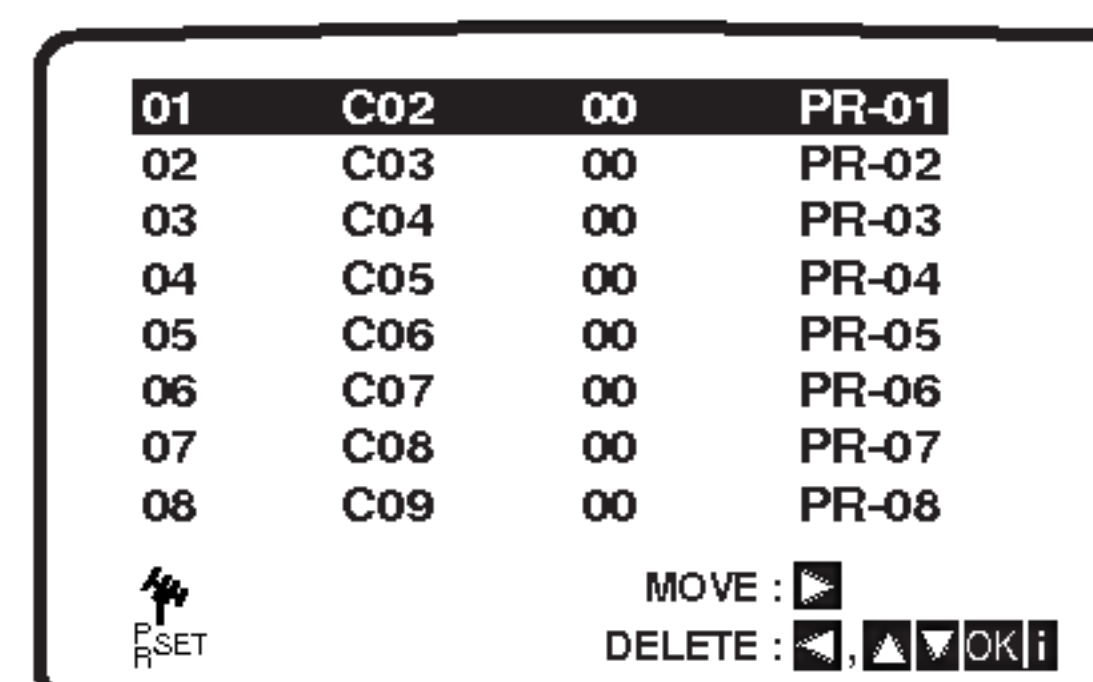

3. Press **◀**.
After a short while, the selected station will be deleted.

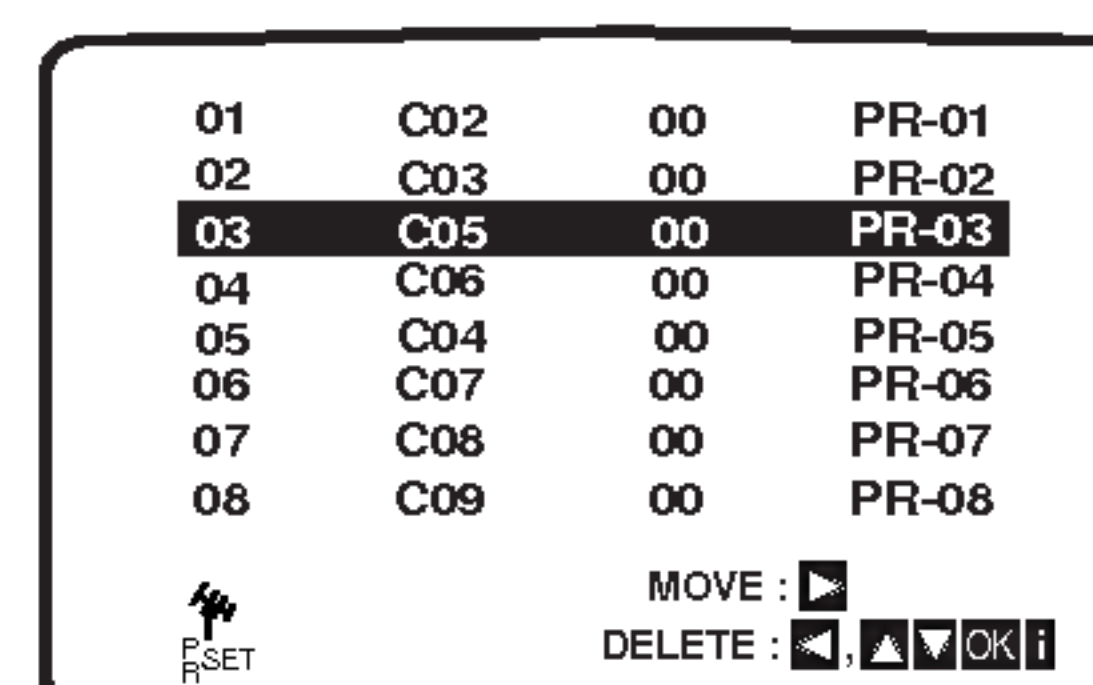

4. Press **i** to remove the menus from the TV screen.
If you wish to delete other TV stations repeat stages 1 - 3.

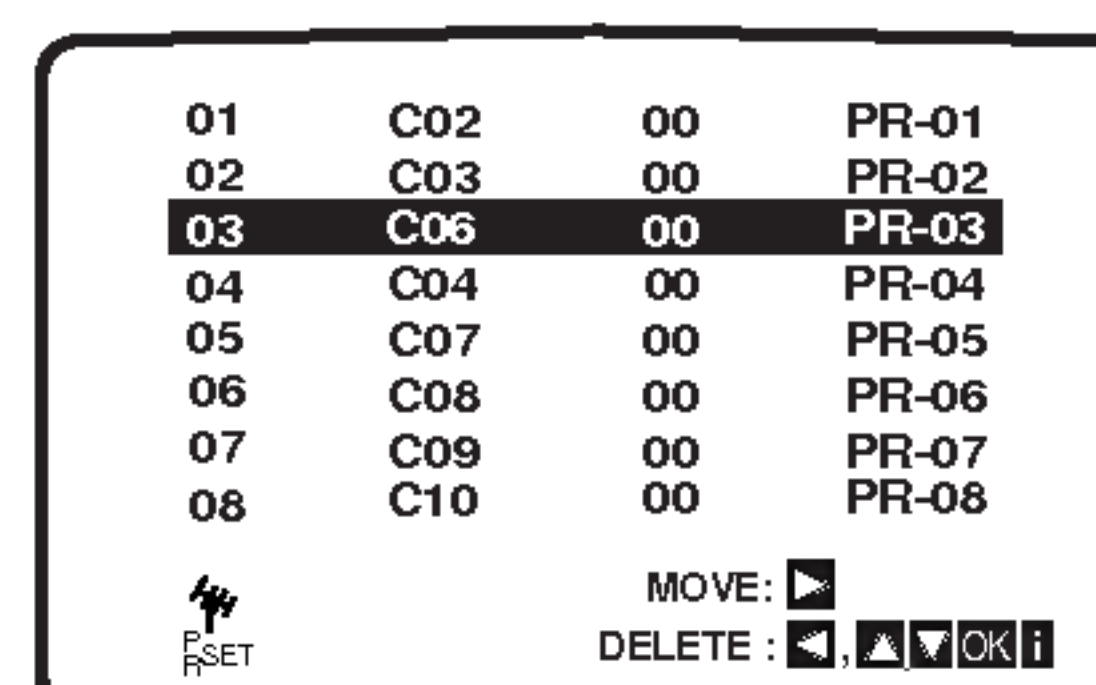

How to selecting Stored TV stations:

Stored TV stations can be selected in either of two ways.

Press **▲** or **▼** to select different stations that are tuned into your DVD/VCR Combi receiver.
You may also directly select stations using the **numbered buttons** on the remote control.

Before Operation-DVD part

On-Screen Display





You can display the general playback status on the TV screen. Some items can be changed using the menu. To use the on-screen display:

1. Press DISPLAY during playback.
2. Press ▲ / ▼ to select an item. The selected item is highlighted.
3. Press ◀ / ▶ to change the setting. You can also use the number buttons if appropriate (e.g. inputting the title number). For some functions, press ENTER to execute the setting.



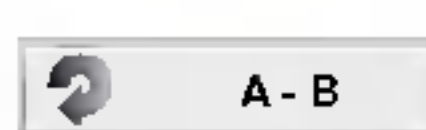

Notes:

- Some discs may not provide all of the features shown below.
- If no button is pressed for 10 seconds, the on-screen display disappears.

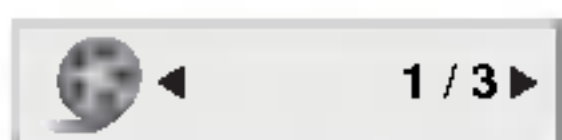

Playback Status/Restrictions

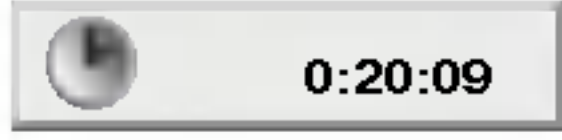
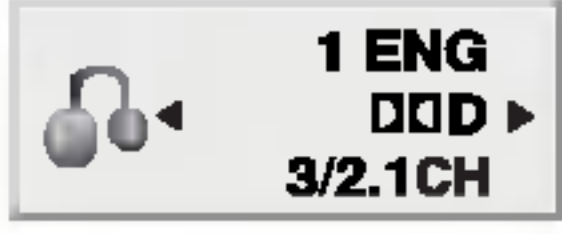
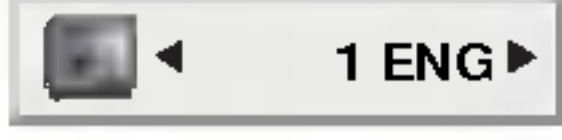
-  TITLE Repeat title
-  A-B Repeat sequence
-  1/9 Enter a Marker
-  MARKER SEARCH 1 2 3 4 5 6 7 8 9 Marker Search menu
-  Resume play from this point
-  Action prohibited or not available

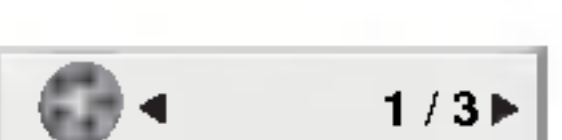
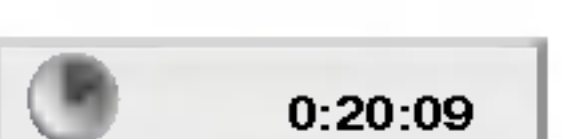

Example: On-Screen Display during playing DVD Video

Items	Selection Method
Title Number 	◀ / ▶, Numbers ENTER
Chapter Number 	◀ / ▶, Numbers ENTER
Time search 	Numbers, ENTER
Audio language and Digital Audio Output mode 	◀ / ▶ or AUDIO
Subtitle language 	◀ / ▶ or S-TITLE
Angle 	◀ / ▶ or ANGLE
Sound 	◀ / ▶

Example: On-Screen Display during playing VCD

Items	Selection Method
Track Number (or PBC mode) 	◀ / ▶, Numbers ENTER
Time search 	Numbers ENTER
Audio Channel 	◀ / ▶ or AUDIO
Sound 	◀ / ▶

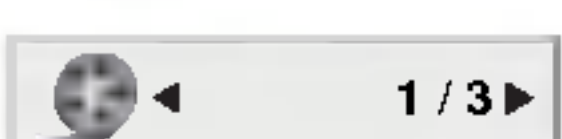
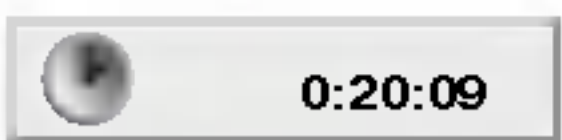
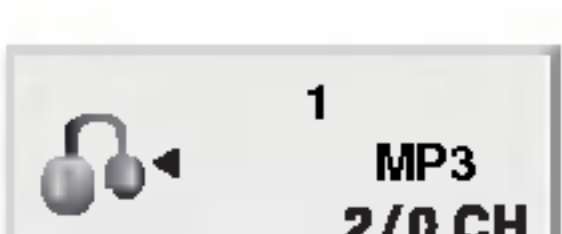
Example: On-Screen Display during playing divx movie disc

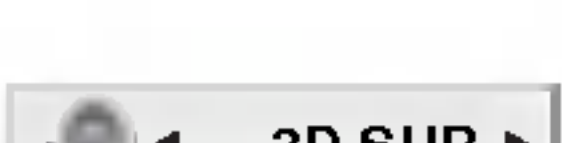
Items	Selection Method
Track Number 	◀ / ▶, Numbers ENTER
Time search 	Numbers, ENTER
Audio language and Digital Audio Output mode 	◀ / ▶ or AUDIO
Subtitle language 	◀ / ▶ or S-TITLE
Sound 	◀ / ▶

Initial Settings

By using the Setup menu, you can make various adjustments to items such as picture and sound. You can also set a language for the subtitles and the Setup menu, among other things. For details on each Setup menu item, see pages 23 to 26.

To display and exit the Menu:

Press SETUP to display the menu. A second press of SETUP will take you back to initial screen.

To go to the next level:

Press ► on the remote control.

To go back to the previous level:

Press ◀ on the remote control.

General Operation

1. Press SETUP. The Setup menu appears.
2. Use ▲ / ▼ to select the desired option then press ► to move to the second level. The screen shows the current setting for the selected item, as well as alternate setting(s).
3. Use ▲ / ▼ to select the second desired option then press ► to move to the third level.
4. Use ▲ / ▼ to select the desired setting then press ENTER to confirm your selection. Some items require additional steps.
5. Press SETUP or PLAY to exit the Setup menu.

LANGUAGE



Menu Language

Select a language for the Setup menu and on-screen display.

Disc Audio / Subtitle / Menu **DVD**

Select the language you prefer for the audio track (disc audio), subtitles, and the disc menu.

Original: Refers to the original language in which the disc was recorded.

Other: To select another language, press number buttons then ENTER to enter the corresponding 4-digit number according to the language code list in the reference chapter. If you enter the wrong language code, press CLEAR.

DISPLAY



TV Aspect **DVD**

4:3 : Select when a standard 4:3 TV is connected.

16:9 Wide: Select when a 16:9 wide TV is connected.

Display Mode **DVD**

Display Mode setting works only when the TV Aspect mode is set to "4:3".

LetterBox: Displays a wide picture with bands on the upper and lower portions of the screen.

Panscan: Automatically displays the wide picture on the entire screen and cuts off the portions that do not fit.

Progressive Scan

Progressive Scan Video provides the highest quality pictures with less flickering. If you are using the Component Video jacks for connection to a TV or monitor that is compatible with a progressive scan signal, set Progressive Scan to On.

To turn On progressive scan:

Connect component out of this unit to the input of your monitor/television, set your television or monitor to Component Input.

1. Select "Progressive Scan" on the DISPLAY menu then press ►.

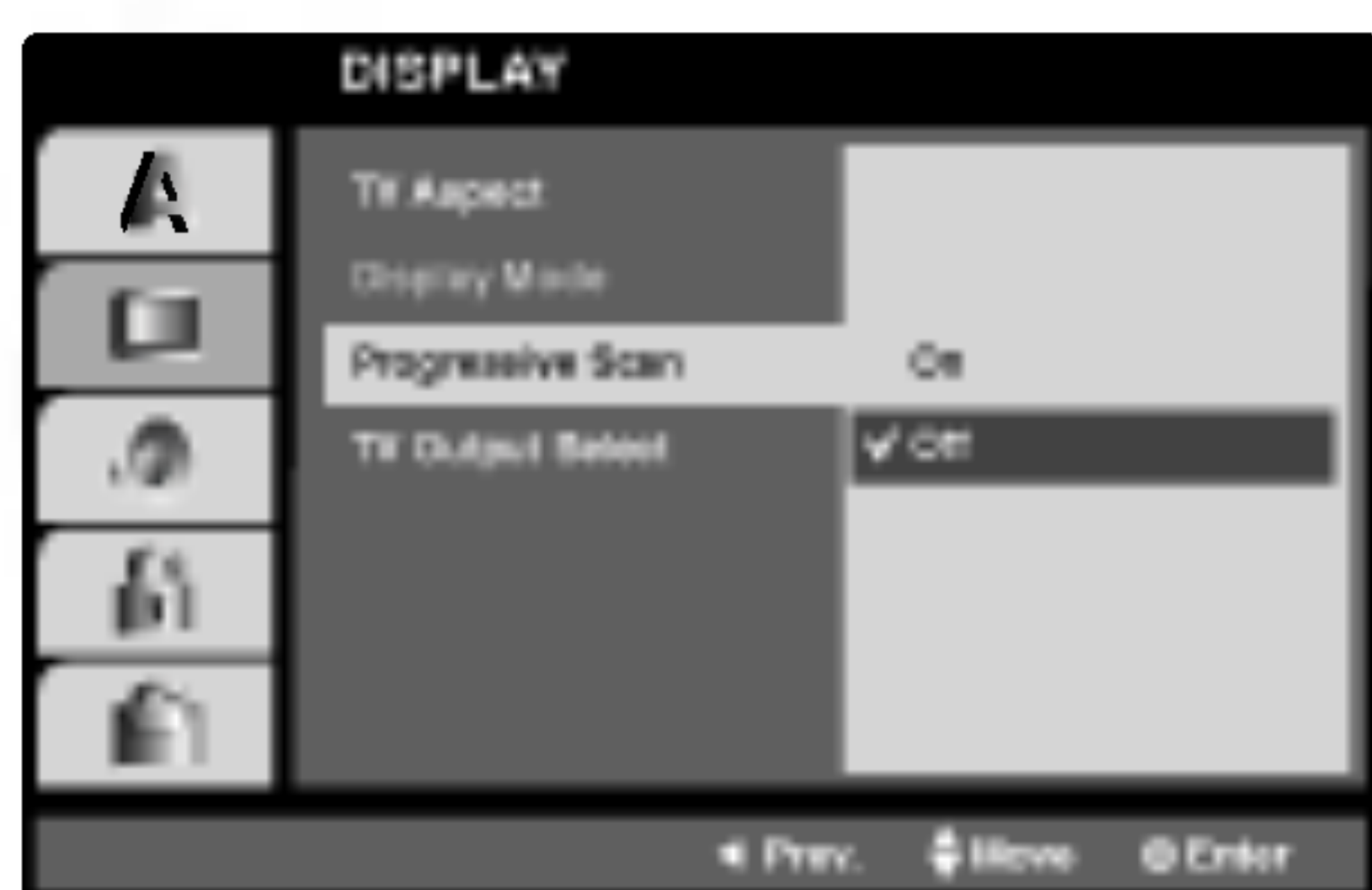

2. Select "On" using the ▲ / ▼ buttons.
3. Press ENTER to confirm your selection. The confirm menu will appear.

Note:

If your TV does not accept the Progressive Scan format, the picture will appear scrambled if you try Progressive Scan on the DVD Player.

4. When the confirm menu appears on your screen Cancel is highlighted as default. Use the ◀ button to highlight Enter.

5. Pressing ENTER will set this unit to Progressive scan mode.

Caution:

Once the setting for progressive scan output is entered, an image will only be visible on a progressive scan compatible TV or monitor. If you set Progressive Scan to On in error, you must reset the unit.

- 1) Remove any disc from the unit and close the disc tray. See that "NO DISC" is displayed on the display window.
- 2) Press STOP and hold it for five seconds before releasing it. The video output will be restored to the standard setting and a picture will once again be visible on a conventional analog TV or monitor.

TV Output Select

Set this unit TV Output Select options according to the TV connection type.

YPbPr: When your TV is connected with the COMPONENT/PROGRESSIVE SCAN VIDEO OUT jacks on this unit.

RGB: When your TV is connected with the SCART (RGB signal) jack.

AUDIO

Each DVD disc has a variety of audio output options. Set this unit AUDIO options according to the type of audio system you use.



5.1 Speaker Setup **DVD**

Select speaker settings, including volume balance and distance, or test the speaker settings.

Speaker settings are only active on the Analog Multi-Channel Output. (See "Speaker Settings", page 39.)

Dynamic Range Control (DRC) **DVD** **DivX**

With the DVD format, you can hear a program's soundtrack in the most accurate and realistic presentation possible, thanks to digital audio technology. However, you may wish to compress the dynamic range of the audio output (the difference between the loudest sounds and the quietest ones). This allows you to listen to a movie at a lower volume without losing clarity of sound. Set DRC to On for this effect.

Vocal **DVD**

Set to On only when a multi-channel karaoke DVD is playing. The karaoke channels on the disc mix into normal stereo sound.

OTHERS

The PBC, Auto Play and DivX(R) VOD settings can be changed.



PBC **VCD**

Set Playback Control (PBC) to On or Off.

On: Video CDs with PBC are played according to the PBC.

Off: Video CDs with PBC are played the same way as Audio CDs.

Auto Play **DVD**

You can set up the DVD Player so a DVD disc automatically starts playing whenever the DVD is inserted. If Auto Play mode is set to On, this DVD player will search for title that has the longest playback time and then play back the title automatically.

On: Auto Play function is active.

Off: Auto Play function is not active.

Notes:

The Auto Play function may not work for some DVDs.

DivX(R) VOD **DivX**

You can display the DivX DRM (Digital Rights Management) Registration code for your unit only.



The Registration code is used for VOD (Video-On-Demand) service agent. You can purchase or rent an encrypt move file.

Notes:

If you rent the DivX VOD file, it has several options of viewing limits as shown below.

- Display the number which you can watch the file.

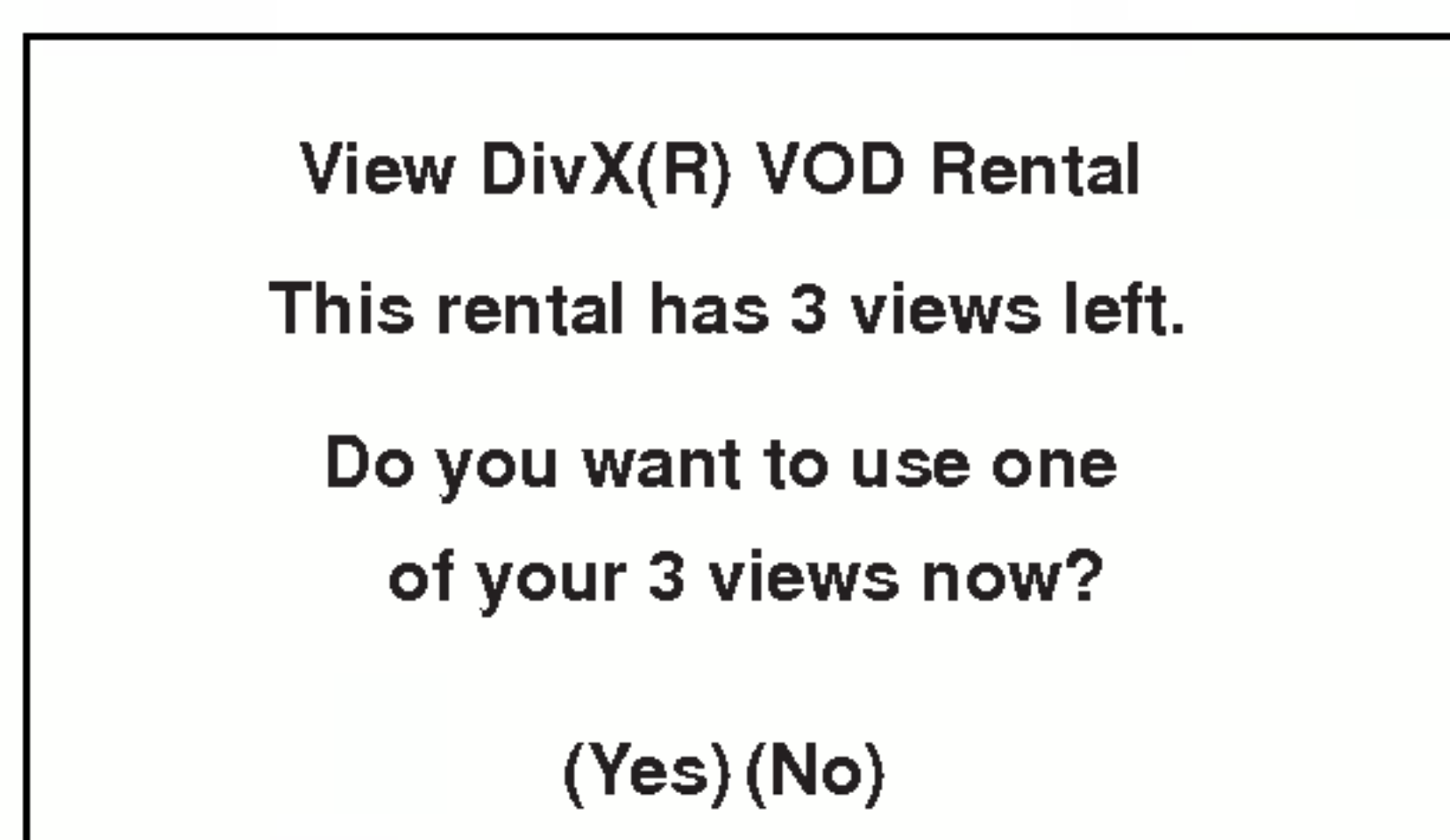

- The rental has been expired.

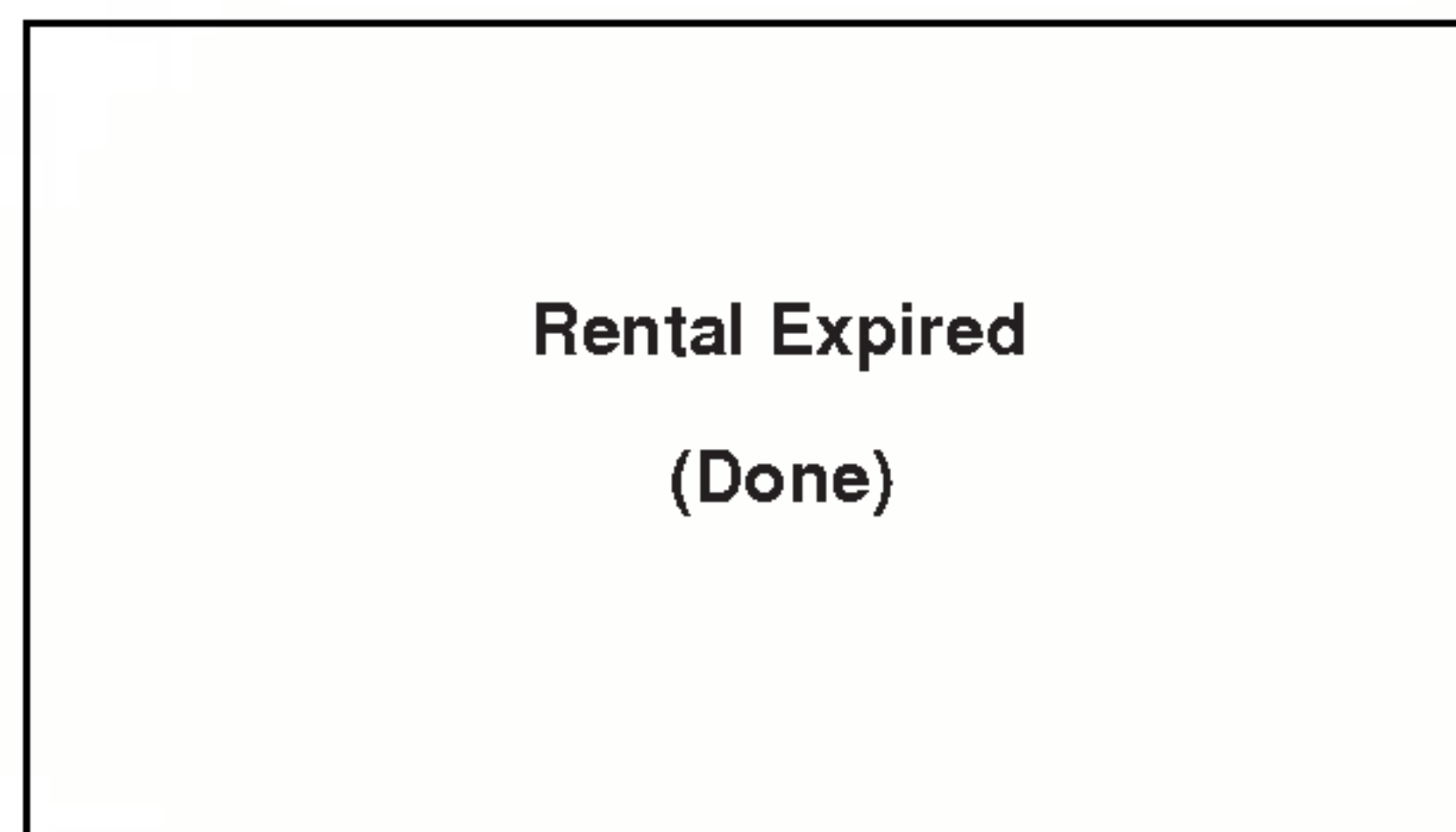

- Display the authorization error.

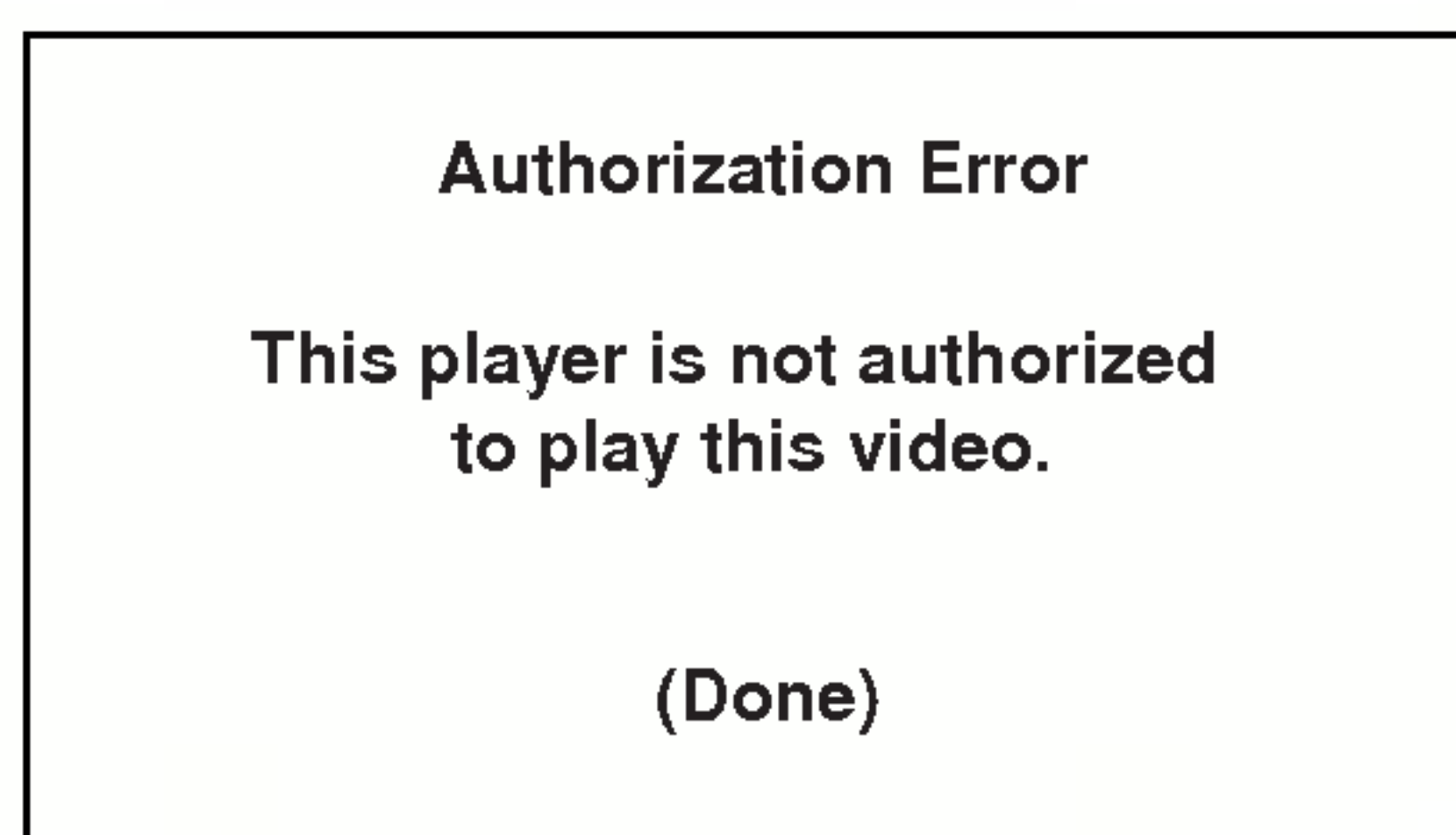

LOCK (Parental Control)



Rating **DVD**

Some movies contain scenes that may not be suitable for children to view. Many of these discs contain parental control information that applies to the complete disc or to certain scenes on the disc. Movies and scenes are rated from 1 to 8, depending on the country. Some discs offer more suitable scenes as an alternative.

The parental control feature allows you to block access to scenes below the rating you input, thereby preventing your children from being able to view material you believe is unsuitable.

1. Select "Rating" on the LOCK menu then press ►.
2. To access the Rating, Password and Country Code features, you must input the 4-digit security code you created. If you have not yet entered a security code you are prompted to do so.

Input a 4-digit code and press ENTER. Enter it again and press ENTER to verify. If you make a mistake before pressing ENTER, press CLEAR.

3. Select a rating from 1 to 8 using the ▲ / ▼ buttons.

Rating 1-8: Rating one (1) has the most restrictions and rating eight (8) is the least restrictive.

Unlock

If you select unlock, parental control is not active and the disc plays in full.

Notes:

If you set a rating for the player, all disc scenes with the same rating or lower are played. Higher rated scenes are not played unless an alternate scene is available on the disc. The alternative must have the same rating or a lower one. If no suitable alternative is found, playback stops. You must enter the 4-digit password or change the rating level in order to play the disc.

4. Press ENTER to confirm your rating selection, then press SETUP to exit the menu.

Password (Security Code)

You can enter or change password.

1. Select Password on the LOCK menu then press ►.
2. Follow step 2 as shown left (Rating). "Change" or "New" is highlighted.
3. Enter the new 4-digit code, then press ENTER. Input it again to verify.
4. Press SETUP to exit the menu.

If you forget your Security Code

If you forget your security code you can clear it using the following steps:

1. Press SETUP to display the Setup menu.
2. Input the 6-digit number "210499" and the security code is cleared.
3. Enter a new code as described above.

Country Code **DVD**

Enter the code of the country/area whose standards were used to rate the DVD video disc, based on the list in the reference chapter.

1. Select "Country Code" on the LOCK menu then press ►.
2. Follow step 2 as shown left (Rating).
3. Select the first character using ▲ / ▼ buttons.
4. Shift the cursor using ► button and select the second character using ▲ / ▼ buttons.
5. Press ENTER to confirm your country code selection.

Operation

Playing a Tape

You will only be able to load and eject video cassettes when your DVD/VCR Combi receiver is plugged into the mains. Your DVD/VCR Combi receiver may also playback recordings from NTSC tapes (on PAL TV).

Getting a better picture

When a cassette is inserted and playback started, the automatic tracking function works to get the best possible picture automatically. If the quality of the recording is poor, repeatedly press ▲ or ▼ on the remote control or press PROG. + or - on the front pannel to manually adjust the tracking until any distortions have been removed. Press numbered 0 on the remote control to switch automatic tracking back on again.

1. Make sure that you have correctly connected your DVD/VCR Combi receiver as described earlier in this book.

Turn on your TV. Press **POWER** to turn on your DVD/VCR Combi receiver. Insert the video cassette into your DVD/VCR Combi receiver. The video cassette should have the window side facing up and the arrow facing away from you.

2. Press **PLAY** to start playing your tape. If you load a video cassette which has had its record protection tab removed, playback of the cassette will start automatically.

AUTO TRACKING

Your DVD/VCR Combi receiver will automatically adjust the tracking to give the best picture quality.

3. Press **PAUSE/STEP** to still a picture. Press **PAUSE/STEP** repeatedly to advance the tape frame by frame. If you press **FORWARD**, the picture will be slowed down at about 1/19 times the normal playback. Tapes can be paused for up to 5 minutes. After 5 minutes your DVD/VCR Combi receiver will stop the tape to prevent damaging the tape or your DVD/VCR Combi receiver. Still picture quality can be improved slightly by pressing ▲ or ▼.

4. Press **PLAY** to continue playing your tape.

Picture search:

During playing back press either **FORWARD** or **BACKWARD** and this will enable you to rapidly wind the tape (7 times normal playback) and see where you are on the tape.

Logic search:

During fast forwarding or rewinding press and hold **FORWARD** or **BACKWARD** the picture will be played back at 7 times normal playback speed.

5. **Slow motion playback, Shuttle :**

During playing back or still picture press ◀ or ▶.

You can reach the following playback speeds. (-7xplay, -3xplay, -play, still, 1/19 slow, play, 2xplay, 7xplay)

To switch off the slow motion and shuttle, press the desired function.

During slow motion and shuttle, the noise bars may appear on the picture according to the status of tape.

If distortions can be seen in the picture, reduce them with ▲ or ▼.

6. Press **STOP** to end playback. Press **EJECT**. If the end of the tape is reached, your DVD/VCR Combi receiver will stop playback automatically, rewind, stop, eject the tape.

CM (Commercial Message) Skip:

This feature enables you during playback of a tape to skip a commercial break in a few seconds, then resume normal playback.

While tape is playing press **CM SKIP** on the remote control to skip commercial (or another programme material).

Repeatedly press **CM SKIP** to skip:

- 1 Press 30 seconds
- 2 Press 60 seconds
- 3 Press 90 seconds
- 4 Press 120 seconds
- 5 Press 150 seconds
- 6 Press 180 seconds

OPR (Optimum Picture Response)

This feature automatically improves playback picture quality by adjusting your DVD/VCR Combi receiver to the condition of the tape.

1. Press **i**.
2. Press ◀ or ▶ to select **OPR**.
3. Press **OK**.

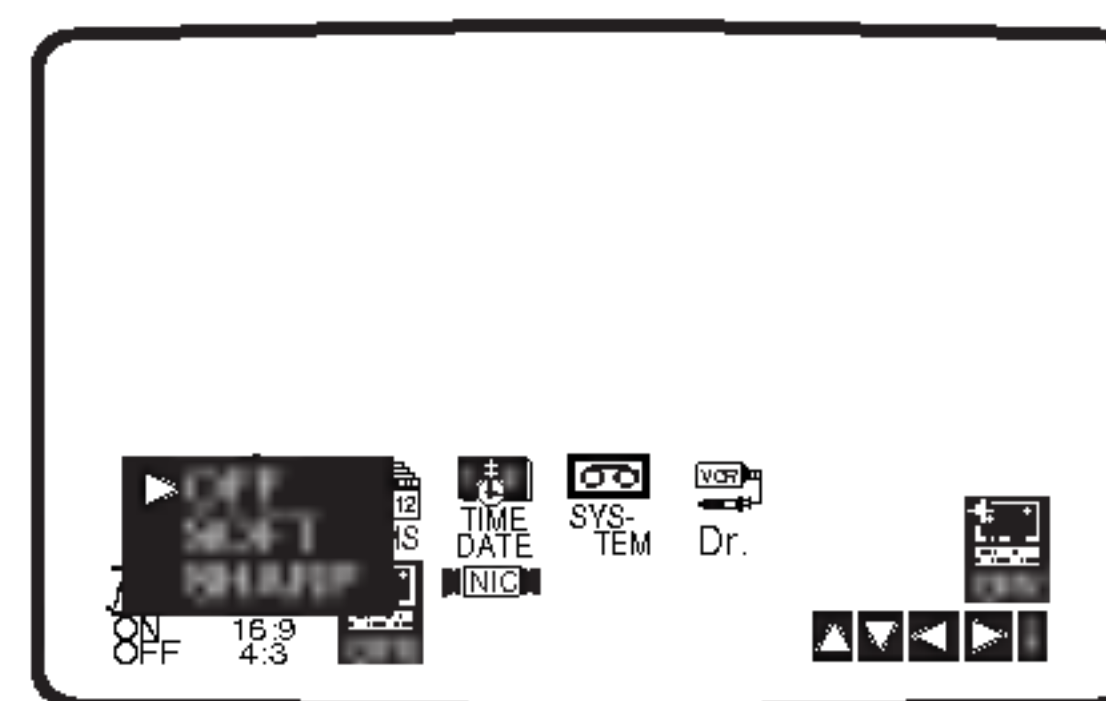

4. Press ▲ or ▼ repeatedly to select: **OFF**, **SOFT** or **SHARP**. Please note you may only set OPR when playing a tape.
5. Press **i** return to screen.

Instant Timer Recording (ITR)

Your DVD/VCR Combi receiver allows you to make recordings using a variety of simple methods: Instant Timer Recording (ITR) start recording immediately for a set period of time or until the video cassette runs out.

Your DVD/VCR Combi receiver incorporates Long Play (LP) which enables you to record up to twice the amount of time on a video cassette. For example an E-180 will record up to 180 minutes using Standard Play (SP); using LP you will be able to record up to 360 minutes. Please note there will be a slight loss in picture and sound quality when using LP.

1. Make sure that you have correctly connected your DVD/VCR Combi receiver as described earlier in this book.
Press **POWER** to turn on your VCR.
2. Insert a video cassette with protection tab into your DVD/VCR Combi receiver.
The video cassette should have the window side facing up and the arrow facing away from you.
3. Press PR ▲ or ▼ to select the **programme number** you wish to record.
You may also directly select programme number using the **numbered buttons** on the remote control.
4. If you wish to record directly from the SCART sockets repeatedly press **AV** until the socket you wish to record from is displayed.
AV 1 for recording from EURO AV1 SCART socket on the rear of your DVD/VCR Combi receiver.
AV 2 for recording from EURO AV2 SCART socket on the rear of your DVD/VCR Combi receiver.
AV 3 for recording from VIDEO IN and AUDIO IN (Left & Right) sockets on the front of your DVD/VCR Combi receiver.

5. Press **SPEED** if you wish to record in Long Play or Standard Play.
SP will produce improved picture and sound quality, however LP will provide twice as much recording time as SP.
6. Press **REC/ITR** to start recording.
RECORD will appear on the TV screen.
Press **REC/ITR** several times. Each successive press will increase the record time by 30 minutes until you reach a maximum of 9 hours.
7. Press **PAUSE/STEP** to avoid recording unwanted scenes.
Press **PAUSE/STEP** to continue recording.
If you press **PAUSE/STEP** during ITR, this DVD/VCR Combi receiver will enter the record pause mode and ITR is cancelled.
Tapes can be paused for up to 5 minutes; RECP will be displayed when a tape is paused. After 5 minutes your DVD/VCR Combi receiver will stop recording to prevent damaging the tape or your DVD/VCR Combi receiver.
8. Press **STOP** to end recording.
Press **EJECT**.
EJECT will appear on the TV screen for a few seconds.

Notes:

- If you do not wish to record on a tape (this can happen quite easily by accident!) remove the protection tab on the back edge of the video cassette.
- It is possible to record on a video cassette with the record protection tab removed by covering the hole with self adhesive tape.
- Remember you can record one programme while watching another by starting your instant recording, press **TV/VCR** to appear **TV** indicator in the display window and then selecting a different channel on your TV.

ShowView Programming

ShowView greatly simplifies entering the date, channel, start and end times of a Timer Recording by simply entering a ShowView Code. ShowView Codes are published in most TV guide magazines; they can vary one to nine numbers in length.

SHOWVIEW is a registered trademark of Gemstar Development Corporation.

The SHOWVIEW system is manufactured under licence from Gemstar Development Corporation.

1. Make sure that TV channels have been tuned and stored in correct SHOWVIEW order. Insert a video cassette with protection tab into your DVD/VCR Combi receiver.

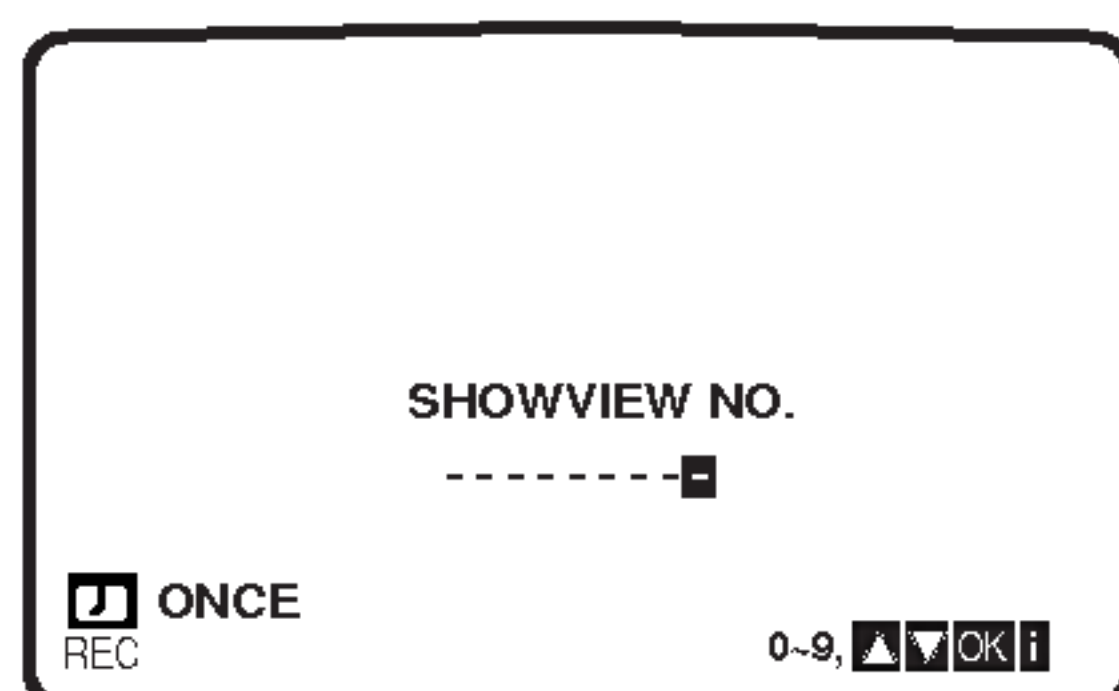

2. Press **SHOWVIEW**.
3. Press ▲ or ▼ to select the recording type.
ONCE: To record once.
WEEKLY: To record at the same time every week.
DAILY: To record every day (except Saturday and Sunday) at the same time.
4. Press the **numbered buttons** to enter the **ShowView Code** of the TV programme that you wish to record.
 If you make a mistake press ◀ then enter the revised number.

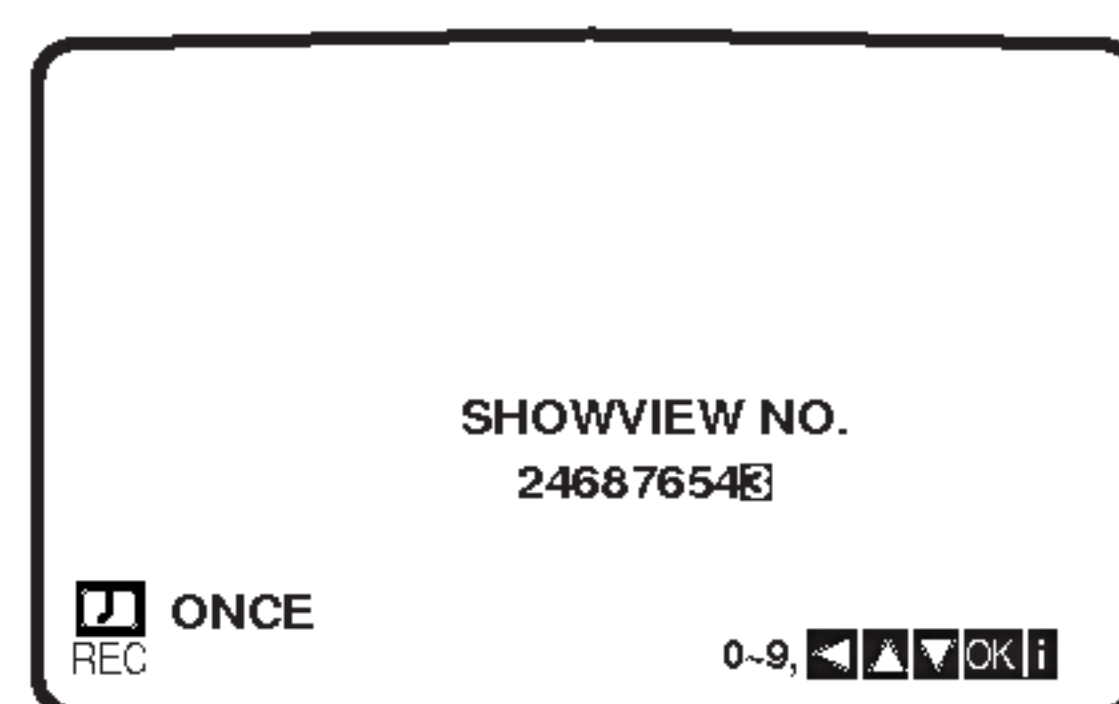

5. Press **OK**.
 If **PLEASE CHECK** is displayed it means that you have entered the wrong ShowView number, entered the ShowView number incorrectly.
 If "-" is displayed, you have to enter the programme number of the station, you want to record from.

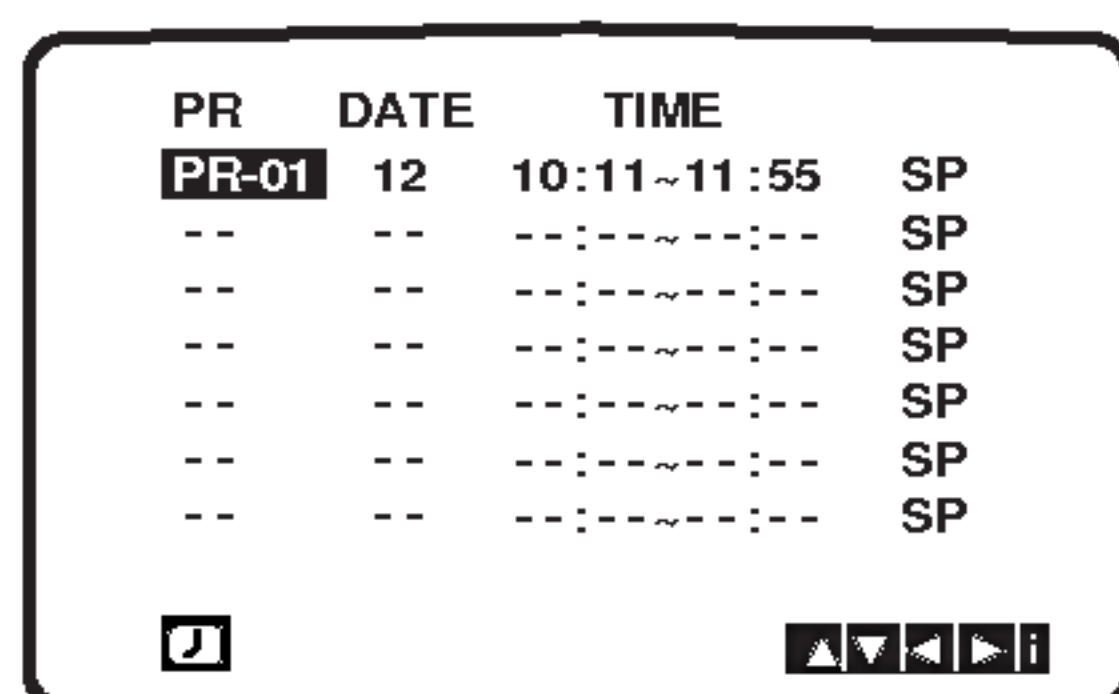

6. Press ◀ or ▶ to select the settings that you wish to revise. (PR, DATE, TIME, VPS and SP).
 Press ▲ or ▼ to enter the correct information.

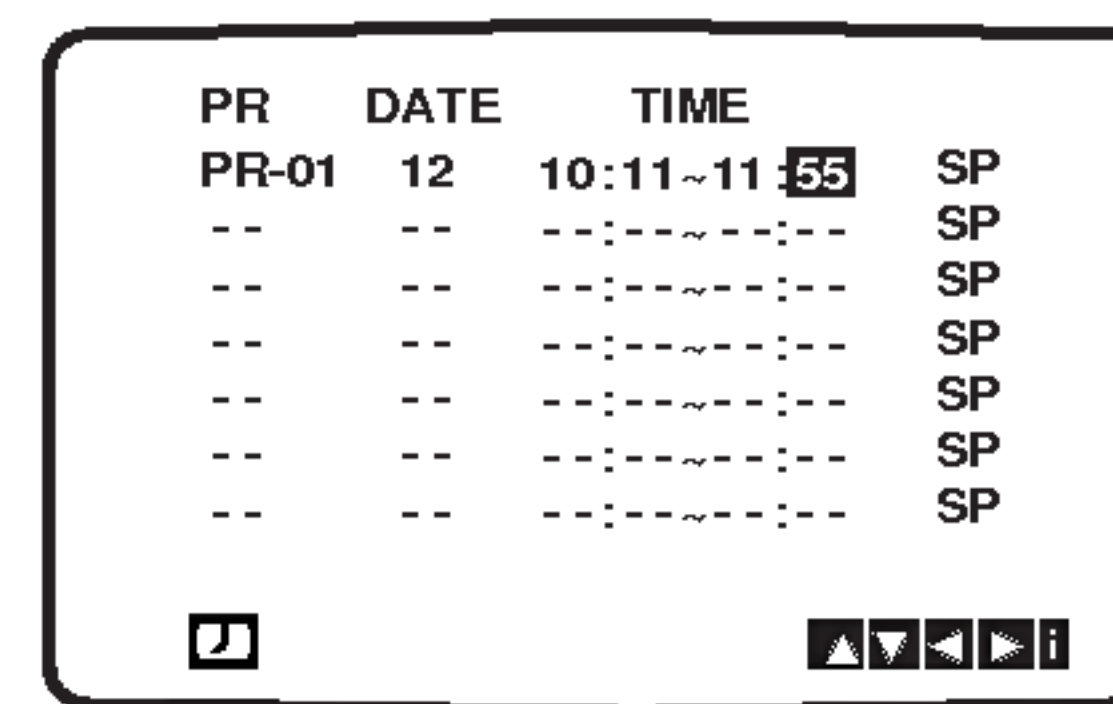

7. Press ▲ or ▼ to switch VPS/PDC on or off.
 Press ▶ to select the recording speed.
 Press ▲ or ▼ to select the desired tape speed (SP, IP, or LP).
 IP mode determines how much tape is left and switches speed from SP to LP, if necessary, to complete recording the program. IP mode is not selected when VPS/PDC is ON. Check that the timer event details are correct. If you wish to record from AUDIO IN and VIDEO IN on the front or from either of the EURO SCART sockets on the back of DVD/VCR Combi receiver, press AV to select for correct display (AV1, AV2 or AV3).

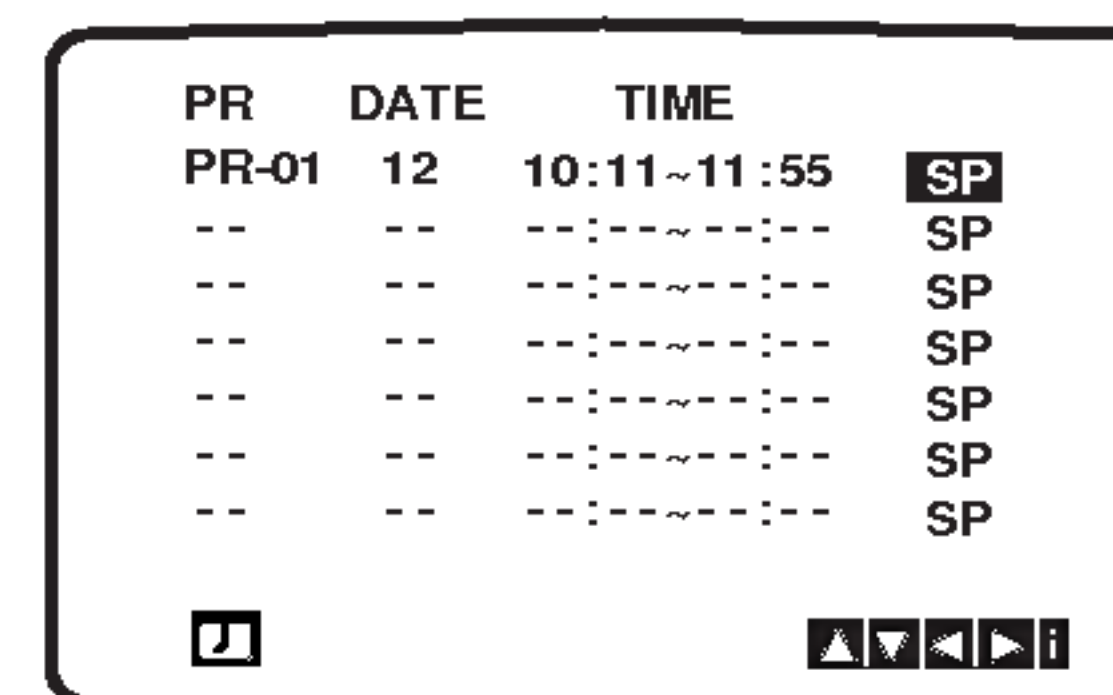

8. If you want to make another ShowView recording repeat stages 2 - 7. Press **i** twice.
 If **PLEASE CHECK** is displayed, you have entered incorrect information and will need to re-enter the data.
 Press **POWER** to switch your DVD/VCR Combi receiver power off mode. Ⓞ will appear in the video recorder's display while your DVD/VCR Combi receiver waits to make the recording.
 To watch a DVD during timer recording standby mode, press **POWER** and **DVD** to switch to DVD mode.
9. Press **STOP** to end recording.

Notes

• Video Programme System (VPS)

The Video Programme System (VPS) ensures that the TV programmes that you have programmed for timer recording will be recorded exactly from their beginning to end, even if the actual broadcasting time differs from the scheduled time due to delayed start, or if the programme is extended beyond its scheduled time. Also, if a programme is interrupted, for example, if a news flash is inserted, the recording will also be interrupted automatically and resumed when the programme continues. The VPS signal is broadcast by the TV station and this controls the timer in the video recorder. VPS should be set ON for all timer recordings from TV stations broadcasting these signals. It should be set OFF for all timer recordings from TV stations that are not broadcasting these signals.

Timer recording using On Screen Display

You may set up to seven timer record events within one month of the current date.

Note

Before setting the timer make sure that you have set the DVD/VCR Combi receiver clock correctly and you know which stations you have tuned TV stations on your DVD/VCR Combi receiver.

1. Insert a video cassette with protection tab into your DVD/VCR Combi receiver.
The video cassette should have the window side facing up and the arrow facing away from you.
2. Press **i**.
Press **◀** or **▶** to select **REC**.
Press **OK**.
3. Press **OK** to start setting the timer record event.
If all timer record events are full press **▲** or **▼** to select the event that you wish to remove and replace. Press **◀** to delete the event.

PR	DATE	TIME	
--	--	-----	SP
--	--	-----	SP
--	--	-----	SP
--	--	-----	SP
--	--	-----	SP
--	--	-----	SP
--	--	-----	SP
--	--	-----	SP

4. Press the **numbered buttons** to enter the station that you wish to record.
When selecting stations 1 - 9, press 0 first, then the channel number; for example Stations 3 - 03.
You may also select Channels by pressing **▲** or **▼**.
Once selected press **▶**.
If you wish to record from AUDIO IN (L/R) and VIDEO IN on the front or from the EURO SCART sockets on the back of your unit, press **AV** to select for correct display (AV1, AV2 or AV3).

PR	DATE	TIME	
PR-01	--	-----	SP
--	--	-----	SP
--	--	-----	SP
--	--	-----	SP
--	--	-----	SP
--	--	-----	SP
--	--	-----	SP

5. Press the **numbered buttons** to enter the date of the programme. If you press **OK** before entering the date you may select one of the following automated recording features. Press **◀** or **▶** to select, then press **OK** to confirm.
DLY To record every day (except Saturday and Sunday) at the same time.
SU~SA To record at the same time every week.

PR	DATE	TIME	
PR-01	16	-----	SP
--	--	-----	SP
--	--	-----	SP
--	--	-----	SP
--	--	-----	SP
--	--	-----	SP
--	--	-----	SP
DLY	SU MO TU WE TH FR SA		

6. Press the **numbered buttons** to enter the recording start and end times of the programme that you wish to record. Please note your DVD/VCR Combi receiver uses a 24 hour clock. e.g. 1pm will be displayed as 13:00. You may also select the the start and end times by pressing **▲** or **▼**.

PR	DATE	TIME	
PR-01	16	19:00~20:00	SP
--	--	-----	SP
--	--	-----	SP
--	--	-----	SP
--	--	-----	SP
--	--	-----	SP
--	--	-----	SP

7. Press **▲** or **▼** to switch VPS on or off.
Press **▶** to select the recording speed.
Press **▲** or **▼** to select the desired tape speed (SP, IP, or LP).
IP mode determines how much tape is left and switches speed from SP to LP, if necessary, to complete recording the program. IP mode is not selected when VPS is ON.

PR	DATE	TIME	
PR-01	16	19:00~20:00	SP
--	--	-----	SP
--	--	-----	SP
--	--	-----	SP
--	--	-----	SP
--	--	-----	SP
--	--	-----	SP

8. Check that the timer event details are correct.
Press **i** twice.
If **PLEASE CHECK** is displayed, you have entered incorrect and will need to re-enter the data.
Press **POWER** to switch your DVD/VCR Combi receiver Standby. **⊙** will appear in the display window while your DVD/VCR Combi receiver waits to make the recording. To watch a DVD during timer recording standby mode, press **POWER** and **DVD** to switch to DVD mode.
9. Press **STOP** to end recording.

Notes

- If at a later date you wish to **delete** or **change** any of the settings in timer event memory you may do so without having to enter all the timer event information again. Simply display the timer event screen. Press **▲** or **▼** to select the event that you wish to **delete** or **change**.
Press **◀** to delete the event...or
Press **OK** to change; then press **◀** or **▶** to select; Station, Date, Start and End times and LP. Press **▲** or **▼** to enter the correct information.

• If Timer record events Overlap...

Make sure that the preset times of the timer recording events do not overlap. If they do, the earlier programme will always be given priority.

Example:

Programme 1 is programmed to start at 16:00 and end at 17:00.

Programme 2 is programmed to start at 16:30 and end at 17:30.

(In this case, Programme 1 will be recorded in its entirety, but only the last 30 minutes of Programme 2 will be recorded.)

If Timer record events Overlap...

Do not overlap programmes, since overlapping portions of the conflicting programmes will not be recorded. Earlier recording times have priority over later recording times as shown in the diagram.

Example:

Programme 1 will be recorded in its entirety, but only the last 30 minutes of Programme 2 will be recorded.

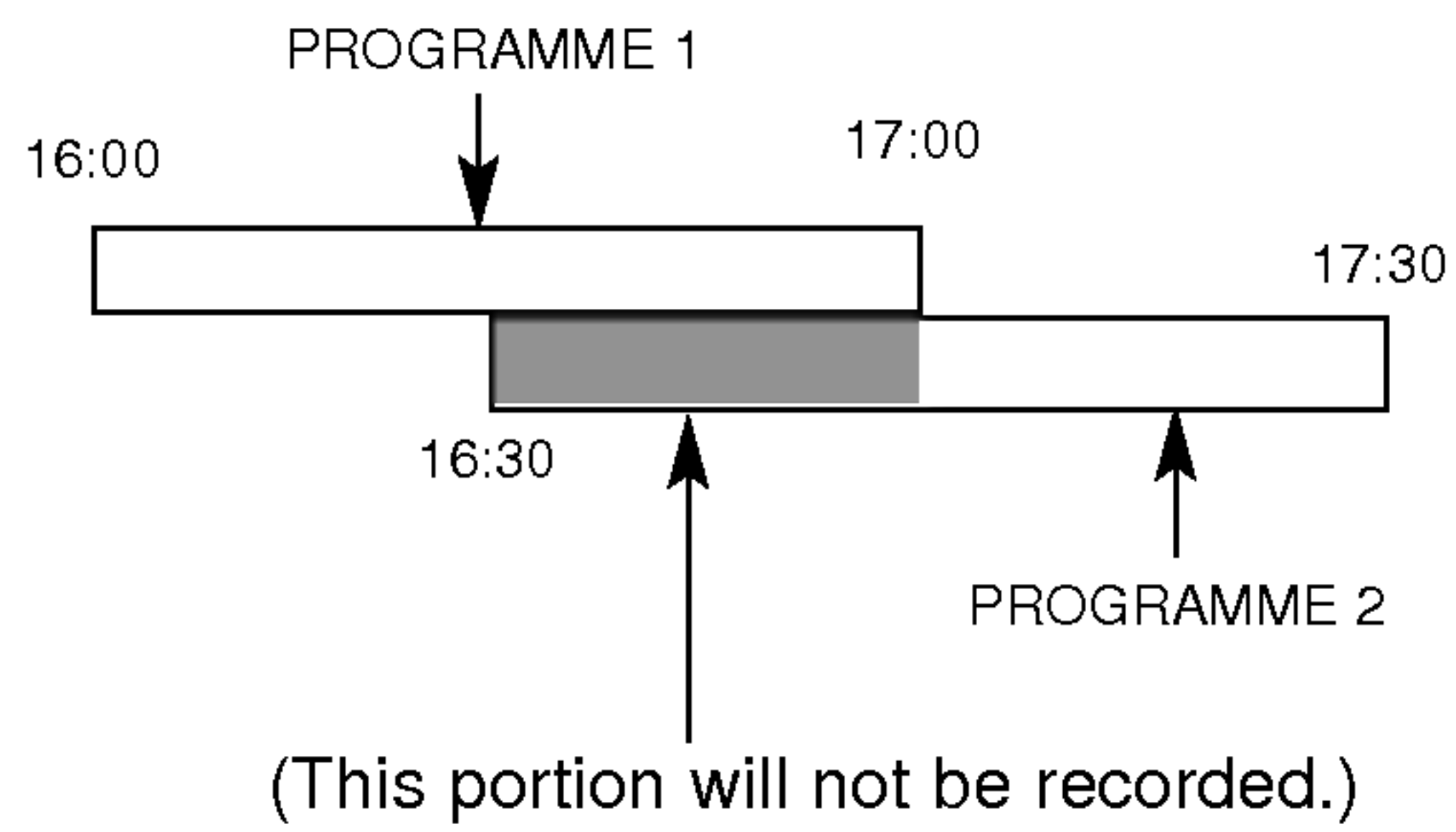

If two programmed timer recordings overlap at midnight 00:00 a.m., programme 2 will not be recorded.

Change (Deleting) the Timer Programme

If at a later date you wish to **delete** or **change** any of the settings in timer event memory you may do so without having to enter all the timer event information again. Simply display the timer event screen. Press ▲ or ▼ to select the event that you wish to **delete** or **change**. Press ◀ to delete the event...or Press **OK** to change, then press ◀ or ▶ to select; Station, Date, Start and End times and LP. Press ▲ or ▼ to enter the correct information.

Playing a DVD or Video CD

Playback Setup

1. Turn on the TV and select the video input source connected to the DVD/VCR Combi receiver.
2. Turn on the audio system (if applicable) and select the input source connected to the DVD/VCR Combi receiver.
3. Press OPEN/CLOSE to open the disc tray and load your chosen disc in the tray, with the playback side down.
4. Press OPEN/CLOSE to close the tray. Playback starts automatically. If playback does not start, press PLAY.

In some cases, the disc menu might appear instead:

DVD

Use the ◀ ▶ ▲ ▼ buttons to select the title/chapter you want to view, then press ENTER to start. Press TITLE or DISC MENU to return to the menu screen.

VCD

Use the number buttons to select the track you want to view and press RETURN to return to the menu screen. Menu settings and operating procedures may differ. Follow the instructions on the each menu screen. You also may set PBC to Off (See "PBC" on page 25).

Notes:

- If parental control is set and the disc is not within the rating settings you must input the password. (See "Lock Menu" on page 26.)
- DVDs may have a region code. Your player does not play discs that have a region code different from your player. The region code for this player is 2 (two).
- To watch a DVD during timer recording standby mode, press POWER and DVD to switch to DVD mode.

General Features

Note:

Unless stated otherwise, all operations described use the remote control. Some features may also be available on the Setup menu.

Moving to another TITLE **DVD**

When a disc has more than one title, you can move to another title. Press DISPLAY while playback is stopped then the appropriate number (0-9) or use ◀ / ▶ to move to another title.

You can play any title by inputting its number while playback is stopped.

Moving to another CHAPTER/TRACK

DVD VCD DivX

When a title on a disc has more than one chapter or a disc has more than one track, you can move to another chapter/track as follows:

- Press ◀◀ or ▶▶ briefly during playback to select the next chapter/track or to return to the beginning of the current chapter/track.
- Press ◀◀ twice briefly to step back to the previous chapter/track.
- To go directly to any chapter during DVD playback, press DISPLAY and press ▲ / ▼ to select the chapter/track icon. Then, input the chapter/track number or use ◀ / ▶.

Search **DVD VCD DivX**

1. Press and hold ◀◀ or ▶▶ for about two seconds during playback.
The player will now go into SEARCH mode.
2. Press and hold ◀◀ or ▶▶ repeatedly to select the required speed: ◀◀X2, ◀◀X4, ◀◀X16, ◀◀X100 (backward) or ▶▶X2, ▶▶X4, ▶▶X16, ▶▶X100 (forward).
With a Video CD, the Search speed changes: ◀◀X2, ◀◀X4, ◀◀X8 (backward) or ▶▶X2, ▶▶X4, ▶▶X8 (forward).
3. To exit SEARCH mode, press PLAY.

Changing the Audio Channel **VCD**

Press AUDIO repeatedly during playback to hear a different audio channel (Stereo, Left, or Right).

Still Picture and Frame-by-Frame Playback**DVD VCD DivX**

1. Press PAUSE/STEP on the remote control during playback. Advance the picture frame-by-frame by pressing PAUSE/STEP repeatedly.
2. To exit still motion mode, press PLAY.

Slow Motion DVD VCD DivX

1. Press PAUSE/STEP (II) during playback.
The DVD/VCR Combi receiver will now go into PAUSE mode.
2. Press I◀◀ or ▶▶I during pause.
The player will enter SLOW mode.
Use the I◀◀ or ▶▶I to select the required speed:
◀◀ 1/16, ◀◀ 1/8, ◀◀ 1/4 or ◀◀ 1/2 (backward), or
▶▶ 1/16, ▶▶ 1/8, ▶▶ 1/4 or ▶▶ 1/2 (forward).
3. To exit Slow Motion mode, press PLAY.

Note:

Slow motion playback in reverse is not possible with Video CDs and DivX Discs.

Random VCD Karaoke DVD

1. Press RANDOM during playback or in stop mode.
The unit automatically begins random playback and RANDOM appears on the TV screen.
2. Press RANDOM again to normal.

Tip:

By pressing I◀◀ or ▶▶I during Random playback, the unit selects another title (track) and resumes Random playback.

Note:

On a Video CD with PBC, You must set PBC to Off on the setup menu to use the random function (See "PBC" on page 25).

Repeat A-B DVD VCD DivX

To repeat a sequence.

1. Press A-B at your chosen starting point. "A * " appears briefly on the TV screen.
2. Press A-B again at your chosen end point.
"A B" appears briefly on the TV screen and the repeat sequence begins.
3. Press A-B again to cancel.

Repeat DVD VCD DivX

You can play a title/chapter/all/track on a disc. Press REPEAT during playback to select a desired repeat mode.

DVD Video Discs - Repeat Chapter/Title/Off

- Chapter: repeats the current chapter.
- Title: repeats the current title.
- Off : does not play repeatedly.

Video CDs - Repeat Track/All/Off

- Track : repeats the current track
- All : repeats all the tracks on a disc.
- Off : does not play repeatedly.

Notes:

- On a Video CD with PBC, you must set PBC to Off on the setup menu to use the repeat function (See "PBC" on page 25).
- If you press ▶▶I once during Repeat Chapter (Track) playback, the repeat playback cancels.

3D Surround DVD VCD DivX

To produce a 3D surround effect that simulates multi-channel audio from two stereo speakers (instead of the five+ speakers normally required for multi-channel audio from a home theater system).

1. Press DISPLAY during playback.
2. Use ▲ or ▼ to select the sound option.
The sound option will be highlighted.
3. Use ◀ or ▶ to select "3D SUR".
To turn off the 3D Surround effect, select "Normal".

Time Search DVD VCD DivX

To start playing at any chosen time on the disc:

1. Press DISPLAY during playback. The time search box shows the elapsed playing time.
2. Press ▲ / ▼ to select the time clock icon and "-:--:--" appears.
3. Input the required start time in hours, minutes, and seconds from left to right. If you enter the wrong numbers, press CLEAR to remove the numbers you entered. Then input the correct numbers.
4. Press ENTER to confirm. Playback starts from the selected time.

Zoom **DVD** **VCD** **DivX**

Use zoom to enlarge the video image.

1. Press ZOOM during playback or still playback to activate the Zoom function. The square frame appears briefly in the right bottom of the picture.
2. Each press of the ZOOM button changes the TV screen in the sequence: 100% size → 400% size → 1600% size → screen fit mode → 100% size

Screen fit mode:

You can change the way the image appears on the screen when you're playing a DVD movie. Press ▲/▼ to select between Normal, Enhanced, and Maximum.

3. Use the ◀ ▶ ▲ ▼ buttons to move through the zoomed picture.
4. To resume normal playback, press ZOOM repeatedly or CLEAR button.

Notes:

- Zoom may not work on some DVDs.
- Screen fit mode is available for playing the DVD disc, VR disc and movie file.

Marker Search **DVD** **VCD** **DivX**

To enter a Marker

You can start playback from up to nine memorized points. To enter a marker, press MARKER at the desired point on the disc. The Marker icon appears on the TV screen briefly. Repeat to enter up to nine markers.

To Recall or Clear a Marked Scene

1. During disc playback, press SEARCH. The marker search menu appears on the screen.
2. Within 10 seconds, press ◀ / ▶ to select a marker number that you want to recall or clear.
3. Press ENTER and playback starts from the marked scene. Or, press CLEAR and the marker number is erased from the list.
4. You can play any marker by inputting its number on the marker search menu.

Special DVD Features

Checking the contents of DVD discs: Menu

DVDs may offer menus that allow you to access special features. To use the disc menu, press DISC MENU. Input the corresponding number or use the ◀ ▶ ▲ ▼ buttons to highlight your selection. Then press ENTER.

Title Menu **DVD**

1. Press TITLE. If the current title has a menu, the menu appears on the screen. Otherwise, the disc menu may appear.
2. The menu offers features such as camera angles, spoken language and subtitle options, and chapters for the title.
3. Press TITLE to exit.

Disc Menu **DVD**

Press DISC MENU and the disc menu is displayed. Press DISC MENU again to exit.

Camera Angle **DVD**

If the disc contains scenes recorded at different camera angles, you can change to a different camera angle during playback. Press ANGLE repeatedly during playback to select a desired angle. Note that the number of the current angle appears on the display.

Changing the Audio Language **DVD** **DivX**

Press AUDIO repeatedly during playback to hear a different audio language or audio track. With DVD-RW discs recorded in VR mode that have both a main and a Bilingual audio channel, you can switch between Main (L), Bilingual (R), or a mix of both (Main + Bilingual) by pressing AUDIO.

Subtitles **DVD** **DivX**

Press S-TITLE repeatedly during playback to see the different subtitle languages.

Note:

- The subtitle file of the DivX file is displayed only smi, srt and sub.
- If there is no information or there is a code that can not read in the DivX file, " 1 " or etc. are displayed.

Playing an Audio CD or MP3/WMA Disc

The DVD/VCR Combi receiver can play MP3/WMA formatted recordings on CD-ROM, CD-R, or CD-RW discs.

Audio CD

Once you insert an audio CD a menu appears on the TV screen. Press ▲ / ▼ to select a track then press PLAY or ENTER and playback starts.



MP3 / WMA

1. Press ▲ / ▼ to select a folder, and press ENTER to see the folder contents.
2. Press ▲ / ▼ to select a track then press PLAY or ENTER. Playback starts.



Tip:

- If you are in a file list on the MUSIC menu and want to return to the Folder list, use the ▲ / ▼ to highlight  and press ENTER.
- Press DISC MENU to move to the next page.
- On a CD with MP3/WMA and JPEG you can switch MP3/WMA and JPEG. Press TITLE and MUSIC or PHOTO word on top of the menu is highlighted.
- When playing a file containing information such as track titles, you can see the information by pressing DISPLAY.

MP3 / WMA disc compatibility with this player is limited as follows:

- Sampling frequency: within 8 - 48 kHz (MP3), within 32 - 48kHz (WMA)
- Bit rate: within 8 - 320kbps (MP3), 32 - 192kbps (WMA)
- The player cannot read an MP3/WMA file that has a file extension other than ".mp3" / ".wma".
- CD-R physical format should be ISO 9660
- If you record MP3 / WMA files using software that cannot create a file system (eg. Direct-CD) it is impossible to playback MP3 / WMA files. We recommend that you use Easy-CD Creator, which creates an ISO 9660 file system.
- File names should have a maximum of 8 letters and must incorporate an .mp3 or .wma extension.
- They should not contain special letters such as / ? * : " < > | etc.
- The total number of files on the disc should be less than 650.

This DVD player requires discs and recordings to meet certain technical standards in order to achieve optimal playback quality. Pre-recorded DVDs are automatically set to these standards. There are many different types of recordable disc formats (including CD-R containing MP3 or WMA files) and these require certain pre-existing conditions (see above) to ensure compatible playback.

Customers should note that permission is required in order to download MP3 / WMA files and music from the Internet. Our company has no right to grant such permission. Permission should always be sought from the copyright owner.

Audio CD and MP3 / WMA Disc Features

Pause **CD** **MP3** **WMA**

1. Press PAUSE/STEP during playback.
2. To return to playback, press PLAY, ENTER or press PAUSE/STEP again.

Moving to another Track **CD** **MP3** **WMA**

1. Press **⏮** or **⏭** briefly during playback to go to the next track or to return to the beginning of the current track.
2. Press **⏮** twice briefly to step back to the previous track.
3. In case of audio CD, to go directly to any track, enter the track number using the numbered buttons (0-9).

Repeat Track/All/Off **CD** **MP3** **WMA**

You can play a track/all on a disc.

1. Press REPEAT when playing a disc. The repeat icon appears.
2. Press REPEAT to select a desired repeat mode.
 - Track: repeats the current track
 - All: repeats all the tracks on a disc.
 - Off(No display): does not play repeatedly.

Note:

If you press **⏭** once during Repeat Track playback, the repeat playback cancels.

Search **CD** **MP3** **WMA**

1. Press and hold **⏮** or **⏭** for about two seconds during playback.
The player will now go into SEARCH mode.
2. Press and hold **⏮** or **⏭** repeatedly to select the required speed: **⏮X2**, **⏮X4**, **⏮X8** (backward) or **⏭X2**, **⏭X4**, **⏭X8** (forward).
Search speed and direction are indicated on the menu screen.
3. To exit SEARCH mode, press PLAY.

Random **CD** **MP3** **WMA**

1. Press RANDOM during playback or when playback is stopped. Random Playback begins immediately and RANDOM appears on the menu screen.
2. To return to normal playback, press RANDOM repeatedly until RANDOM disappears from the menu screen.

Tip:

By pressing **⏭** during random playback, the unit selects another track and resumes random playback.

Repeat A-B **CD**

1. To repeat a sequence during disc playback press A-B at your chosen starting point. The Repeat icon and "A" appear on the menu screen.
2. Press A-B again at your chosen end point. The Repeat icon and "A-B" appear on the menu screen, and the sequence begins to play repeatedly.
3. To exit the sequence and return to normal play, press A-B again. The Repeat icon disappears from the menu screen.

3D Surround **CD**

To produce a 3D surround effect that simulates multi-channel audio from two stereo speakers (instead of the five+ speakers normally required for multi-channel audio from a home theater system).

1. Press AUDIO during playback.
"3D SUR." appears on the menu screen.
2. To return to normal playback, press AUDIO repeatedly until "3D SUR." disappears from the menu screen.

Programmed Playback

The program function enables you to store your favorite tracks from any disc in the player memory. A program can contain 30 tracks.

1. Insert a disc.

Audio CD or MP3/WMA Discs:

AUDIO CD or MUSIC menu appears.

2. Press PROGRAM.
The  mark will appear to the right of the word "Program" on the right side of the menu screen.

Note:

Press PROGRAM again, then the  mark will disappear to exit the Program Edit mode.



Audio CD Menu

MP3/WMA Menu

Video CD: Press PROGRAM while playback is stopped. The program menu appears. Press PROGRAM to exit the menu.

Note:

On a Video CD with PBC, you must set PBC to Off on the setup menu to use the programmed playback (See "PBC" on page 25).



Video CD Menu

3. Select a track on the "List", then press ENTER to place the selected track on the "Program" list. Repeat to place additional tracks on the list.
4. Press .
Select the track you want to start playing on the "Program" list.
5. Press PLAY or ENTER to start. Playback begins in the order in which you programmed the tracks. Playback stops after all of the tracks on the "Program" list have played once.
6. To resume normal playback from programmed playback, select a track of CD (or MP3/WMA) list and then press PLAY.



Repeat Programmed Tracks

1. Press REPEAT when playing a disc. The repeat icon appears.
2. Press REPEAT to select a desired repeat mode.
 - Track: repeats the current track
 - All: repeats all the tracks on programmed list.
 - Off(No display): does not play repeatedly.



Note:

If you press  once during Repeat Track playback, the repeat playback cancels.

Erasing a Track from Program List

1. Video CD : Press PROGRAM in the stop mode to enter Program Edit mode.
2. Press  to move to the "Program" list.
3. Use / to select the track that you wish to erase from the "Program" list.
4. Press CLEAR. Repeat to erase additional tracks on the list.

Erasing the Complete Program List

1. Follow steps 1-2 of "Erasing a Track from Program List" as above.
2. Use / to select "Clear All", then press ENTER.
The complete Program for the disc will be erased.

Note:

The programs are also cleared when the disc is removed.

Viewing a JPEG Disc

Using this DVD/VCR Combi receiver you can view Kodak PICTURE CDs and discs with JPEG files.

1. Insert a disc and close the tray. The PHOTO menu appears on the TV screen.



2. Press ▲ / ▼ to select a folder, and press ENTER. A list of files in the folder appears. If you are in a file list and want to return to the previous Folder list, use the ▲ / ▼ buttons on the remote to highlight and press ENTER.
3. If you want to view a particular file, press ▲ / ▼ to highlight a file and press ENTER or PLAY. Viewing the file proceeding starts. While viewing a file, you can press STOP to move to the previous menu (PHOTO menu). Press DISC MENU to move to the next page.

Slide Show **JPEG**

Use ▲ ▼ ◀ ▶ to highlight the (Slide Show) then press ENTER.

Tip:

- There are three Slide Speed options : >>> (Fast), >> (Normal) and > (Slow).
- On a disc with MP3/WMA and JPEG you can switch MP3/WMA and JPEG. Press TITLE and MUSIC or PHOTO word on top of the menu is highlighted.
- Press RETURN, information of file is hidden.

Still Picture **JPEG**

1. Press PAUSE/STEP during slide show. The player will now go into PAUSE mode.
2. To return to the slide show, press PLAY or press PAUSE/STEP again.

Moving to another File **JPEG**

Press ◀◀ or ▶▶ once during viewing a picture to advance to the next file or to the previous file.

Zoom **JPEG**

Use zoom to enlarge the photo image. (see 34 page)

To rotate picture

Press ▲ / ▼ during showing a picture to rotate the picture clockwise or counter clockwise.

To listen to MP3/WMA music watching picture

JPEG

You can display files while listening to MP3/WMA music files recorded on the same disc.

1. Insert the disc containing the two types of file in the player.
2. Press TITLE to display PHOTO menu.
3. Press ▲ / ▼ to select a photo file.
4. Use ▶ / ▼ to select icon then press ENTER. Playback starts. The playback will continue until STOP is pressed.

Tip:

To listen to only the desired music watching picture, programmed the desired tracks from the "MUSIC" menu and then proceed as above.

JPEG disc compatibility with this player is limited as follows:

- Depending upon the size and number of JPEG files, it could take a long time for the DVD player to read the disc's contents. If you don't see an on-screen display after several minutes, some of the files may be too large — reduce the resolution of the JPEG files to less than 2M pixels as 2760 x 2048 pixels and burn another disc.
- The total number of files and folders on the disc should be less than 650.
- Some discs may be incompatible due to a different recording format or the condition of disc.
- Ensure that all the selected files have the ".jpg" extensions when copying into the CD layout.
- If the files have ".jpe" or ".jpeg" extensions, please rename them as ".jpg" file.
- File names without ".jpg" extension will not be able to be read by this DVD player. Even though the files are shown as JPEG image files in Windows Explorer.

5.1 Speaker Setup

This chapter includes important reference information to help you set your DVD/VCR Combi receiver.

Speaker Setup

Make the following settings for the built-in 5.1 channel surround decoder.

1. Press SETUP. The setup menu appears.
2. Use ▲ / ▼ to select the AUDIO option then press ► to move to the second level.
3. Use ▲ / ▼ to select the Speaker Setup option then press ► to move to the third level. "Select" is highlighted.
4. Press ENTER and 5.1 Speaker Setup menu appears.



5. Use ◀ / ▶ to select the desired speaker.
6. Adjust options using ▲ / ▼ / ◀ / ▶ buttons.
7. Press RETURN to return to the menu screen.

Speaker selection

Select a speaker that you want to adjust. (Front speakers (Left), Center Speaker, Front speakers (Right), Rear speakers (Right), Rear speakers (Left), or SubWoofer)

Note:

Certain speaker settings are prohibited by the Dolby Digital licensing agreement.

Size

Since the speaker settings are fixed, you cannot change the settings.

Volume

Press ◀ / ▶ to adjust the output level of the selected speaker. (-6dB ~ 6dB)

Distance

If you connected speakers to your DVD/VCR Combi receiver, setting the Distance lets the speakers know how far the sound has to travel to reach your set listening point. This allows the sound from each speaker to reach the listener at the same time.

Press ◀ / ▶ to adjust the Distance of the selected speaker.

[0.3(1)m(ft) - 6.0(20)m(ft)]

Test

Press ◀ / ▶ to test the signals of each speaker. Adjust the volume to match the volume of test signals memorized in the system.

Front Left (L) → Center → Front Right (R)

→ Rear Left (R) → Rear Right (L) → SubWoofer

Playing a DVD VR format Disc

This unit will play DVD-R/RW discs recorded using the DVD-Video format that have been finalized using a DVD-recorder.

- This unit will play DVD-RW discs recorded using the Video Recording (VR) format.
1. Insert a disc and close the tray. The TITLE LIST menu appears on the TV screen.

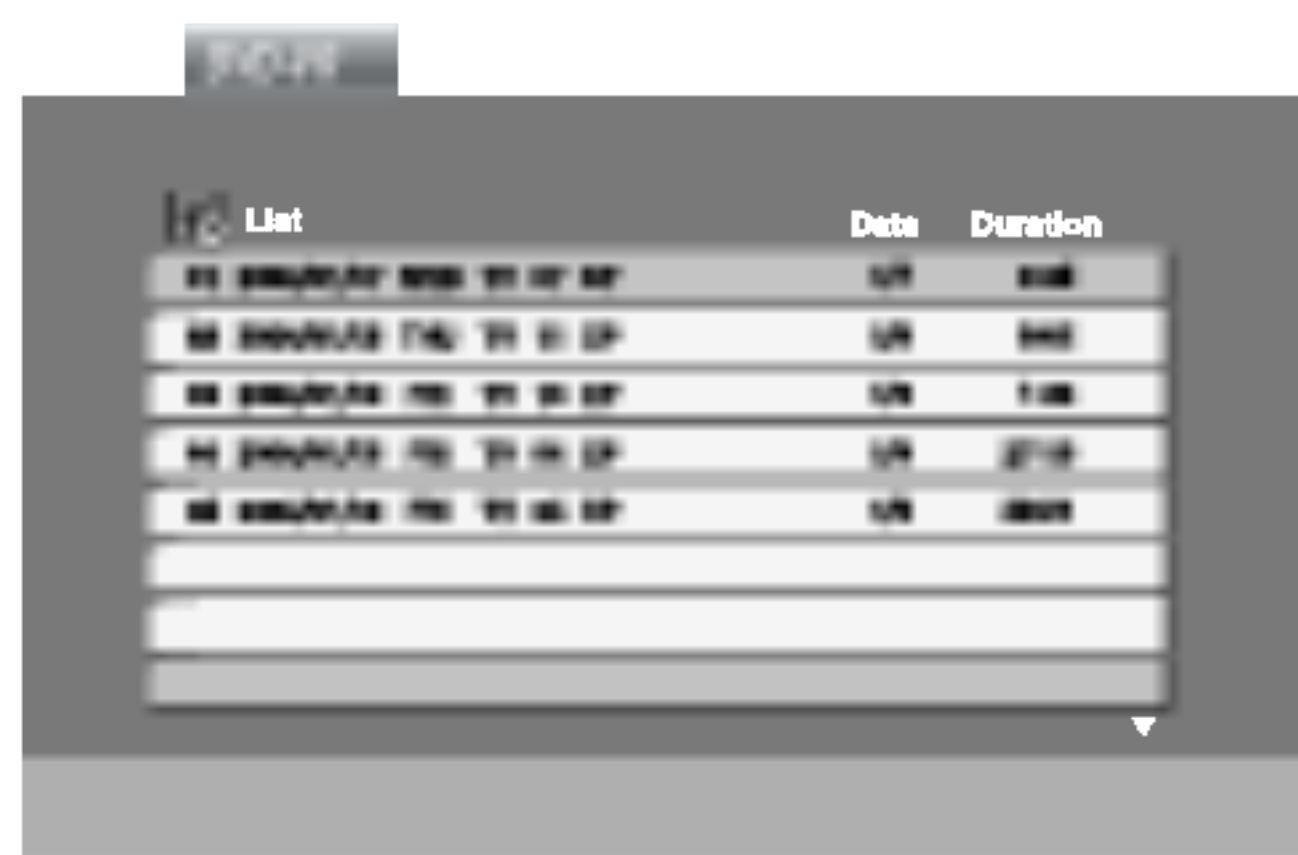

2. Press ▲ / ▼ to select a track then press PLAY or ENTER and playback starts.
3. Press TITLE to move to the list menu.

Note:

- Unfinalized DVD-R/RW discs cannot be played in this player.
- Some DVD-VR disc are made with CPRM data by DVD RECORDER. Player does not support these kinds of discs.

What is 'CPRM'?

CPRM is a copy protection system (with scramble system) only allowing the recording of 'copy once' broadcast programs. CPRM stands for Content Protection for Recordable Media.

This play is CPRM compatible, which means that you can record copy-once broadcast programs, but you cannot then make a copy of those recordings. CPRM recordings can only be made on DVD-RW discs formatted in VR mode, and CPRM recordings can only be played on players that are specifically compatible with CPRM.

Maintenance and Service

Refer to the information in this chapter before contacting a service technician.

Handling the Unit

When shipping the unit

Please save the original shipping carton and packing materials. If you need to ship the unit, for maximum protection, re-pack the unit as it was originally packed at the factory.

Keeping the exterior surfaces clean

- Do not use volatile liquids such as insecticide spray near the unit.
- Do not leave rubber or plastic products in contact with the unit for a long period of time. since they leave marks on the surface.

Cleaning the unit

To clean the player, use a soft, dry cloth. If the surfaces are extremely dirty, use a soft cloth lightly moistened with a mild detergent solution.

Do not use strong solvents such as alcohol, benzene, or thinner, as these might damage the surface of the unit.

Maintaining the Unit

The DVD/VCR Combi receiver is a high-tech, precision device. If the optical pick-up lens and disc drive parts are dirty or worn, the picture quality could be diminished.

Depending on the operating environment, regular inspection and maintenance are recommended after every 1,000 hours of use.

For details, please contact your nearest authorized service center.

Playing a DivX Movie Disc

Using this DVD/VCR Combi receiver you can play DivX disc.

1. Insert a disc and close the tray. The MOVIE menu appears on the TV screen.

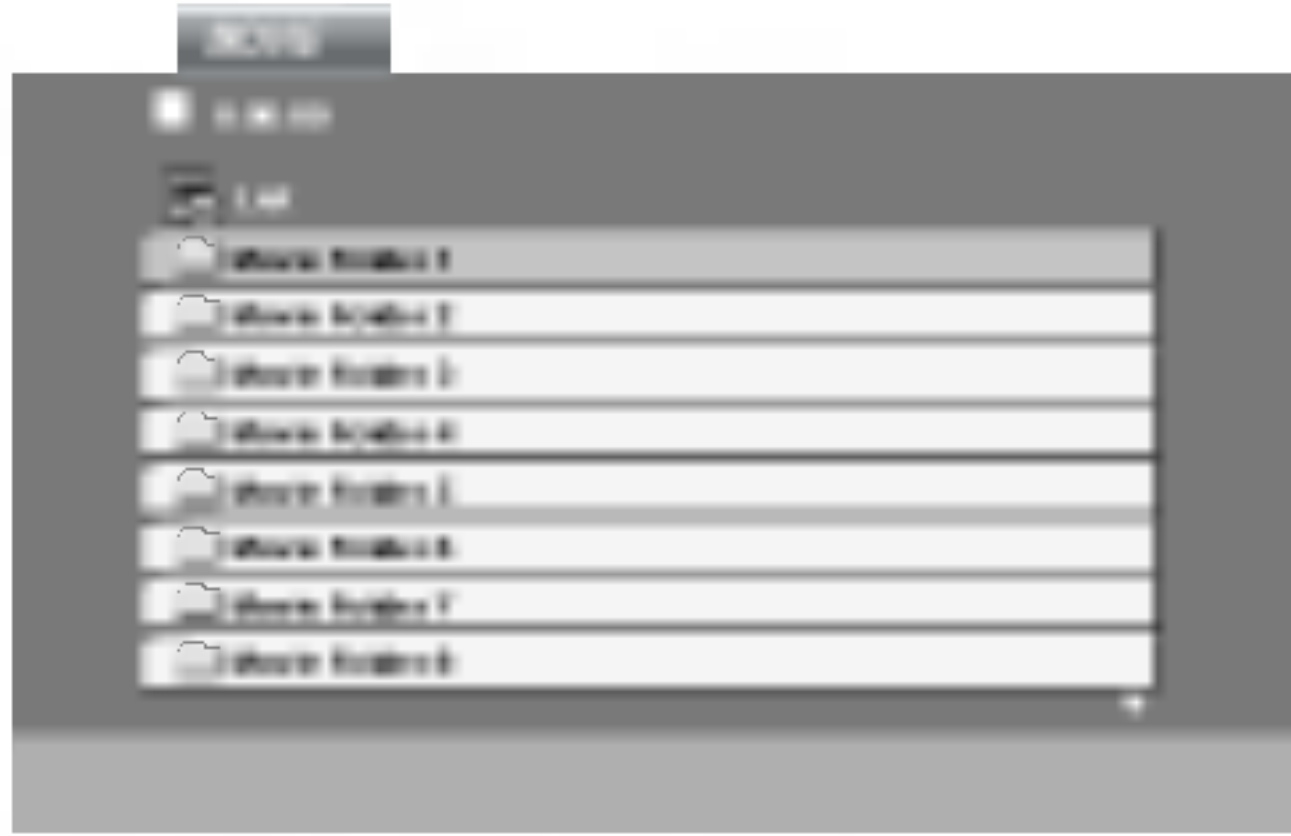

2. Press ▲ / ▼ to select a folder, and press ENTER. A list of files in the folder appears. If you are in a file list and want to return to the Folder list, use the ▲ / ▼ buttons on the remote to highlight ⏪ and press ENTER.
3. If you want to view a particular file, press ▲ / ▼ to highlight a file and press ENTER or PLAY.
4. Press STOP to exit.

Tip:

- Press DISC MENU to move to the next page.
- On a CD with MP3/WMA, JPEG and MOVIE file, you can switch MUSIC, PHOTO and MOVIE menu. Press TITLE and MUSIC, PHOTO and MOVIE word on top of the menu is highlighted.

DivX disc compatibility with this player is limited as follows:

- Available resolution size of the DivX file is under 720x576 (W x H) pixel.
- The file name of the DivX subtitle is available by 56 characters.
- If there is impossible code to express in the DivX file, it may be displayed as " _ " mark on the display.
- **If the number of the screen frame is over 30 per 1 second, this unit may not operate normally.**
- **If the video and audio structure of recorded file is not interleaved, either video or audio is outputted.**
- **If the file is recorded with GMC, the unit supports only 1-point of the record level.**
 - * GMC?

GMC is the acronym for Global Motion Compensation. It is an encoding tool specified in MPEG4 standard. Some MPEG4 encoders, like DivX or Xvid, have this option. There are different levels of GMC encoding, usually called 1-point, 2-point, or 3-point GMC.

Playable DivX file

- ".avi ", ".mpg ", ".mpeg "

Playable Codec format

- "DIVX3.xx ", "DIVX4.xx ", "DIVX5.xx ", "XVID ", "MP43 ", "3IVX "

Playable Audio format

- "AC3 ", "DTS ", "PCM ", "MP3 ", "WMA ".
 - Sampling frequency: within 8 - 48 kHz (MP3), within 32 - 48kHz (WMA)
 - Bit rate: within 8 - 320kbps (MP3), 32 - 192kbps (WMA)

Additional Features-VCR part

On Screen Display

You may easily display the current time or tape counter, amount of tape left, day, month, year, day of week, programme channel, tape speed and operational mode of your DVD/VCR Combi receiver will appear on the TV screen. If a recording is taking place these On Screen Displays will not be recorded onto the tape.

1. Press **CLK/CNT** to display.
Press **CLK/CNT** repeatedly to cycle through the display options. The tape counter and amount of tape left will appear if there is a tape loaded.
2. After 3 seconds the majority of the On Screen Displays will clear leaving only the clock or tape counter and the amount of tape left on the screen. Press **CLK/CNT** again to remove all displays from the TV screen.

Tape Counter Memory Stop

The **Digital Tape Counter** can be displayed on the display window instead of the time by pressing **CLK/CNT** on the remote control. The Digital Tape Counter indicates the relative positions of recordings on the tape.

1. Press **CLK/CNT**.
Press **CLEAR** to set the counter to 0:00:00.
Press **PLAY** or start recording.
The tape counter will display the actual play time in hours, minutes and seconds.
2. Press **STOP** when playback or recording is complete.
Press **BACKWARD**.
The tape will rewind and automatically stop when the counter returns to 0:00:00.

Video Doctor (Self-Diagnosis)

This feature informs you that there is a problem with your DVD/VCR Combi receiver. These error messages will appear on the TV screen.

1. Press **i**.
Press **◀** or **▶** to select **Dr**.
Press **OK**.

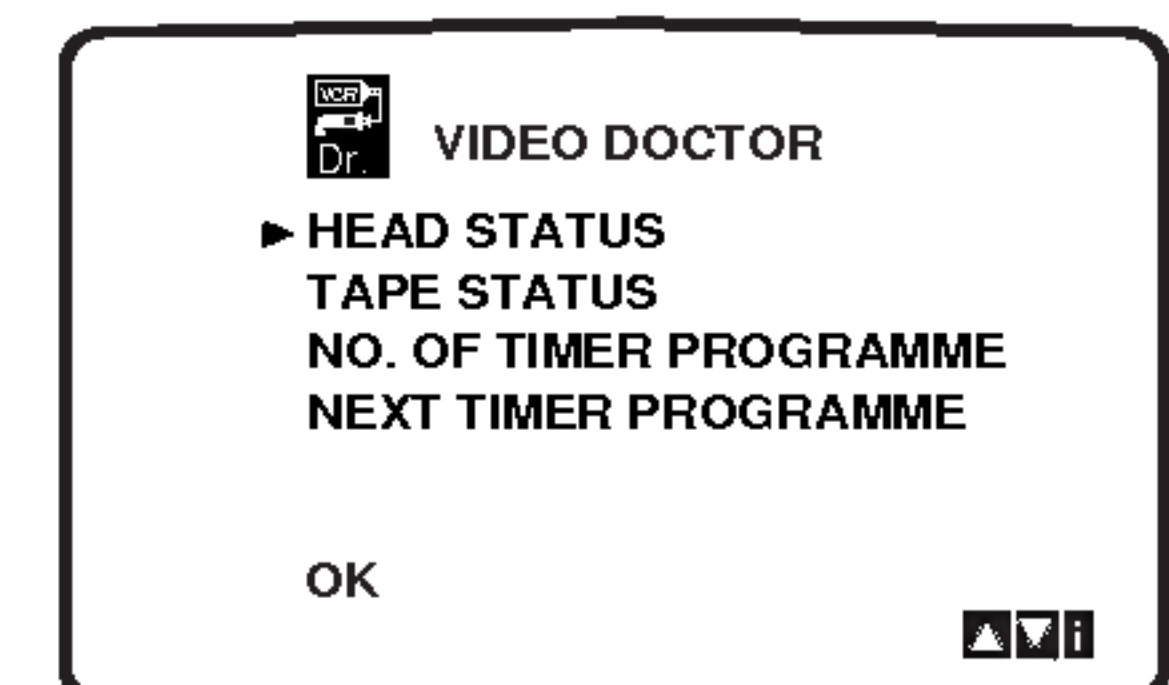
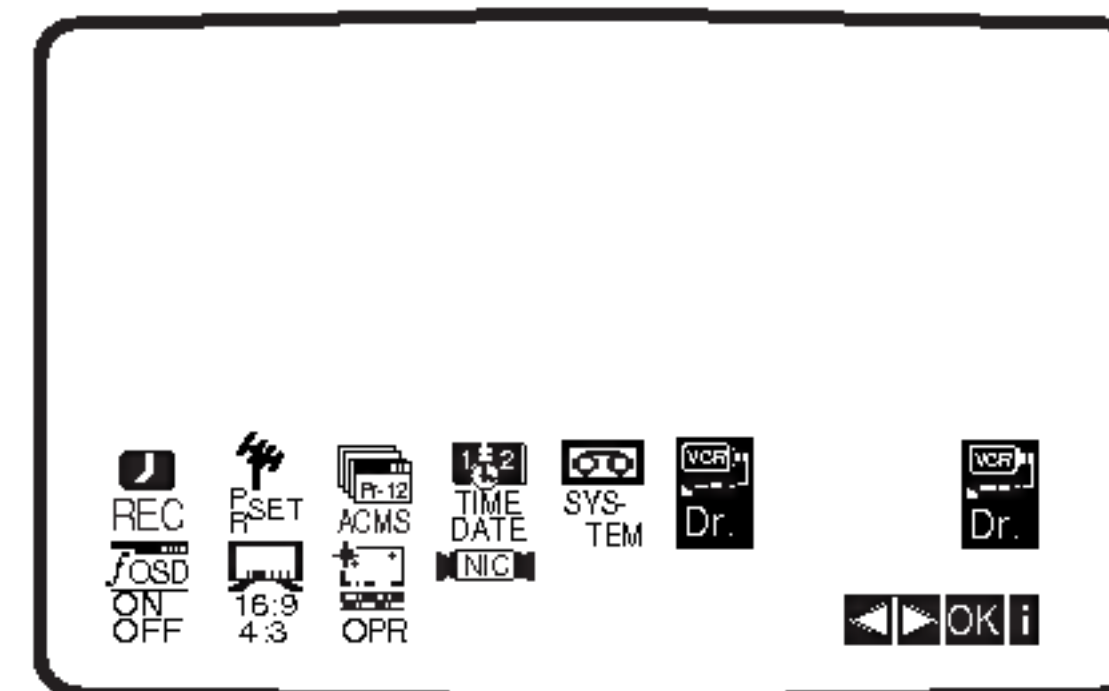

2. Press **▲** or **▼** to check a problem.
HEAD STATUS
● **PLEASE CLEAN:**
Clean your video heads.
TAPE STATUS
● **NOT RECORDABLE:**
Insert a tape with its protection tab in place
NO. OF TIMER PROGRAMME
● **2**
Shows the number of timer recording.
NEXT TIMER PROGRAMME
● **PR-01 26 10:00~11:00 SP**
Shows the current status of timer recording.
3. Press **i**

Hi-Fi Stereo Sound System

Your DVD/VCR Combi receiver will record and playback Hi-Fi stereo sound. In addition it has a stereo NICAM digital stereo sound decoder. This allows you to record and playback the sound in several different ways. Video cassettes recorded on your DVD/VCR Combi receiver will have a normal mono audio track and two VHS Hi-Fi stereo audio tracks. These stereo tracks allow you to make audio recordings in Hi-Fi stereo or bilingual mode from a TV broadcast, stereo audio system, video disc or another Hi-Fi VCR.

1. Your DVD/VCR Combi receiver's NICAM digital sound decoder allows you to enjoy broadcasts with NICAM sound, as well as standard stereo, bilingual and mono sound. The particular type of sound received or that recorded will be briefly displayed on the TV screen for a couple of seconds:

STEREO NICAM

Sound is automatically recorded on the Hi-Fi stereo and mono tracks of the video tape.

BIL NICAM

Both audio channels will be recorded on the Hi-Fi stereo tracks. The primary language channel (left) will be recorded on the mono track of the video tape.

MONO

The sound is recorded on the Hi-Fi tracks and the mono track of the video tape without any separation.

2. Press **AUDIO** repeatedly until the desired audio mode appears.
3. The choice is **STEREO**, **LEFT**, **RIGHT** and **MONO**. In **BIL NICAM** playback the primary language is output on the left channel and the secondary channel is output simultaneously from the right channel when audio output is set to **STEREO**.
The primary language will be output from both channels when the audio setting is **MONO**. Please note that when adjusting the tracking control Hi-Fi stereo sound may revert to **MONO**.

Wide Screen Compatibility 16:9

Your DVD/VCR Combi receiver can record and playback wide screen aspect ratio programmes (16:9). To record a wide screen format programme successfully the correct type of wide screen signal must be broadcast by the TV station.

1. Switch on your VCR.
Press **i**.
Press **◀** or **▶** to select **16:9/4:3**.
Press **OK**.

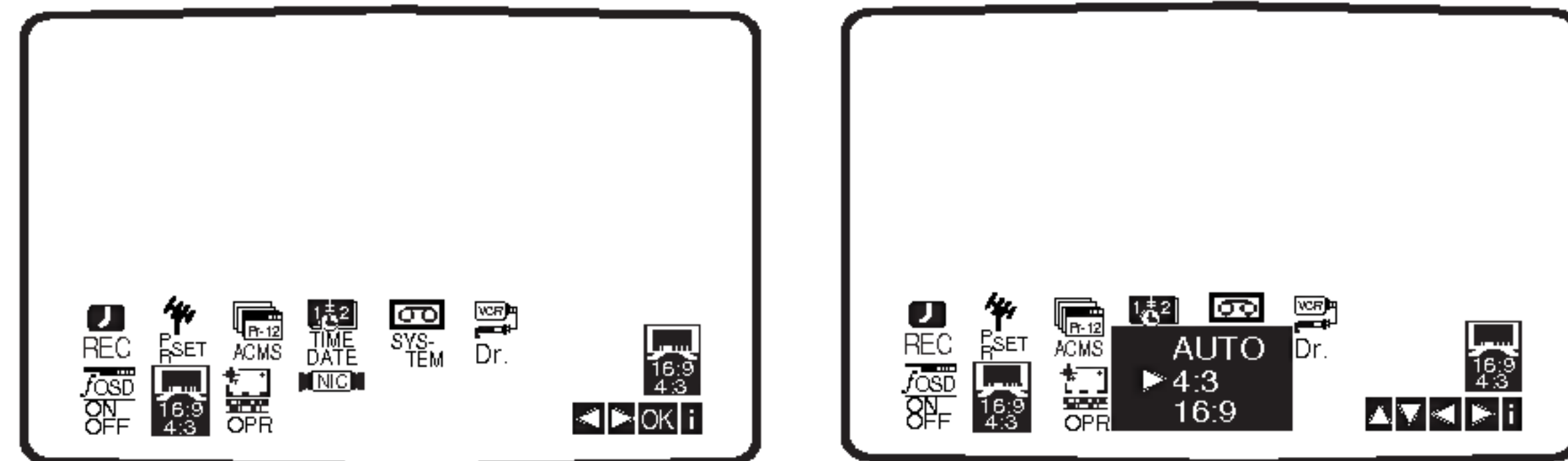

2. Press **▲** or **▼** repeatedly to select: **AUTO**, **4:3** or **16:9**.
AUTO:
Automatically plays back Wide-Screen programmes as Wide-Screen and Normal programmes as normal.
4:3
Only for playing back and recording Normal format recordings (4:3).
16:9:
Only for playing back and recording Wide-Screen format recordings (16:9).

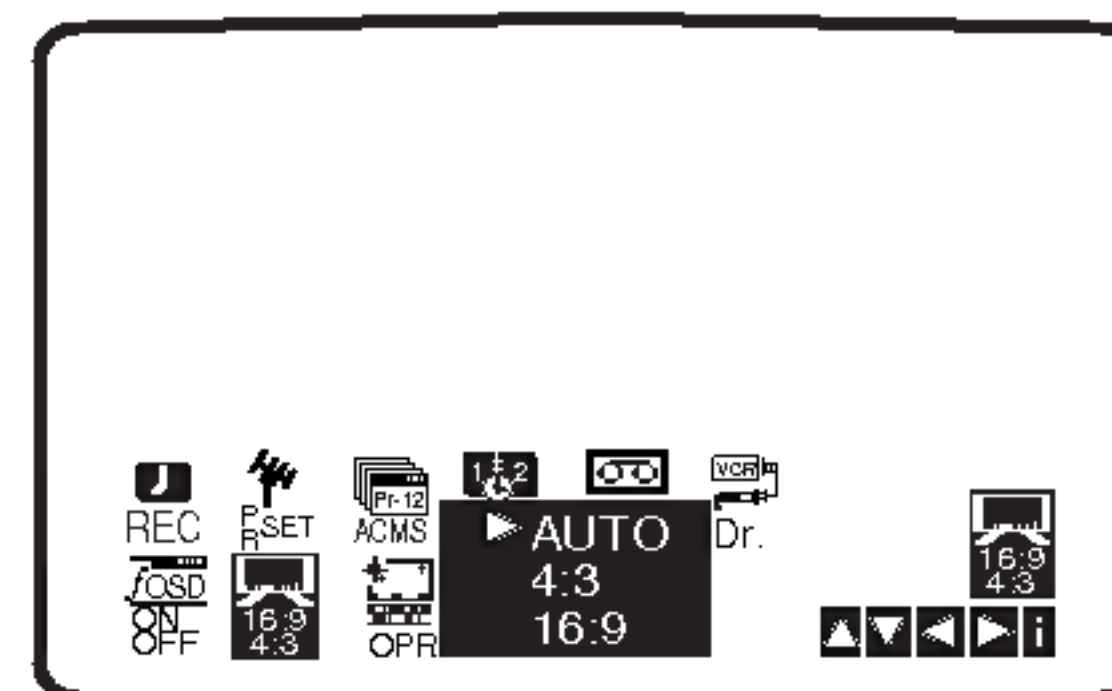

3. Press **i** to remove the menus from the TV screen. To enjoy Wide-Screen playback you must connect your DVD/VCR Combi receiver to the TV using a SCART cable.

Additional Features

Last Scene Memory

DVD **CD** **VCD**

This player memorizes last scene from the last disc that is viewed. The last scene remains in memory even if you remove the disc from the player or switch off the player. If you load a disc that has the scene memorized, the scene is automatically recalled.

Note:

This player does not memorize the scene of a disc if you switch off the player before commencing to play the disc.

Screen Saver

The screen saver appears when you leave the DVD player in Stop mode for about five minutes.

Video Mode Setting

- With certain discs, the playback picture may be flickering or Dot Crawl is shown on straight lines. That means Vertical interpolation or De-interlace is not perfectly matched with the disc. In this case, the picture quality may be improved by changing the video mode.
- To change the video mode, press and hold DISPLAY about 3 seconds during disc playback. The new video mode number selected is displayed on the TV screen. Check whether the video quality has improved. If not, repeat the above procedure until picture quality is improved.
- Video mode sequence:
MODE1 → MODE2 → MODE3 → MODE1
- If you turn off the power, the video mode will return to initial default state (MODE1).

Detailed Description of each Video Mode

MODE1 : The source material of the DVD video (film material or video material) is determined from disc information.

MODE2 : Suitable for playing film based content or video based material recorded by the progressive scan method.

MODE3 : Suitable for playing video based content with comparatively little motion.

Note:

The video mode setting only works when the Progressive Scan mode is set to "On" on the setup menu.

Copying from DVD To VCR

This unit allows you to copy the contents of a DVD to a VHS tape with a press of the COPY button.

Notes:

- Be sure to set "Progressive Scan" to "Off" on the setup menu.
- If the DVD you are attempting to copy is copy protected, you may not be able to copy the disc.

1. Insert Disc

Insert the disc you wish to copy in the DVD deck and close the disc tray.

2. Insert VHS Tape

Insert a blank VHS videotape into the VCR deck.

3. Copy the DVD to VHS Tape

Press the REC/ITR button.

- The DVD will go into Play mode and the DVD/VCR Combi receiver will go into Record mode.
- If the DVD disc menu appears, you may need to press the Play button manually to begin copying.

Note:

If you press the REC/ITR button, be sure this DVD/VCR Combi receiver is in DVD mode.

4. Stop the Copy Process

When the DVD is finished playing, press STOP to end the copy.

- You must stop the Copy process manually when the DVD movie ends, or the unit may replay and record over and over again.

Recording from another video recorder

With this video recorder you can make recordings from an external source, such as copying from another DVD/VCR Combi receiver or a camcorder.

Note:

In the following description, this video recorder will be one used for recording and will be referred to as DVD/VCR Combi receiver B. The other appliance will be used for playback and will be referred to as DVD/VCR Combi receiver A.

1. DVD/VCR Combi receiver A should be connected to the SCART socket on the rear panel of your unit or the AV sockets on the front panel of your unit.
2. Insert the recorded tape into DVD/CD/VCR receiver A and a blank tape into DVD/VCR Combi receiver B.
3. Press **AV** until the socket you wish to record from is displayed. (DVD/VCR Combi receiver B)

AV 1 for recording from EURO AV1 SCART socket on the rear of your unit.

AV 2 for recording from EURO AV2 SCART socket on the rear of your unit.

AV 3 for recording from VIDEO IN and AUDIO IN (Left & Right) sockets on the front of your unit.

4. To start recording, press the REC/ITR on DVD/VCR Combi receiver B and PLAY on DVD/VCR Combi receiver A.
5. When you want to finish copying, press the STOP on both DVD/VCR Combi receiver.

Presetting the Radio Stations

You can preset 50 stations for FM and AM. Before tuning, make sure that you have turned down the volume.

1. Press FM/AM on the remote control or on the front panel until the frequency band appears on the display and TV screen.

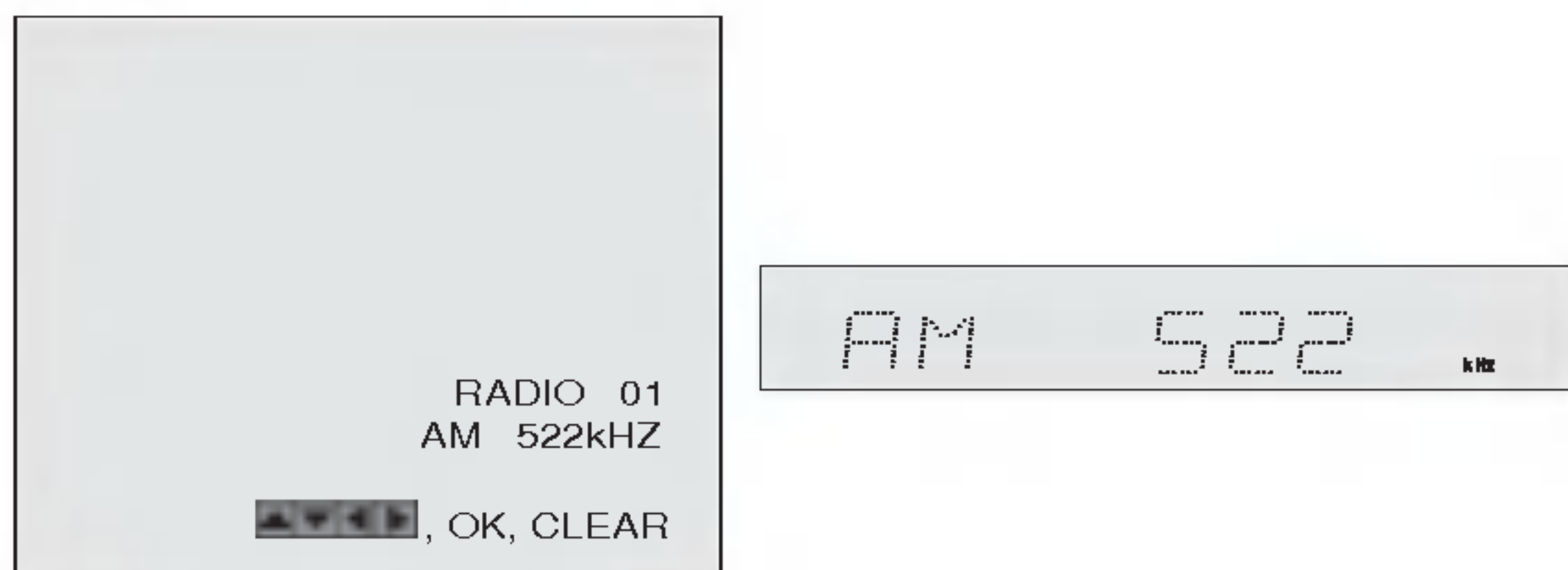

2. Press ▲/▼ on the remote control to select your desired radio channel.

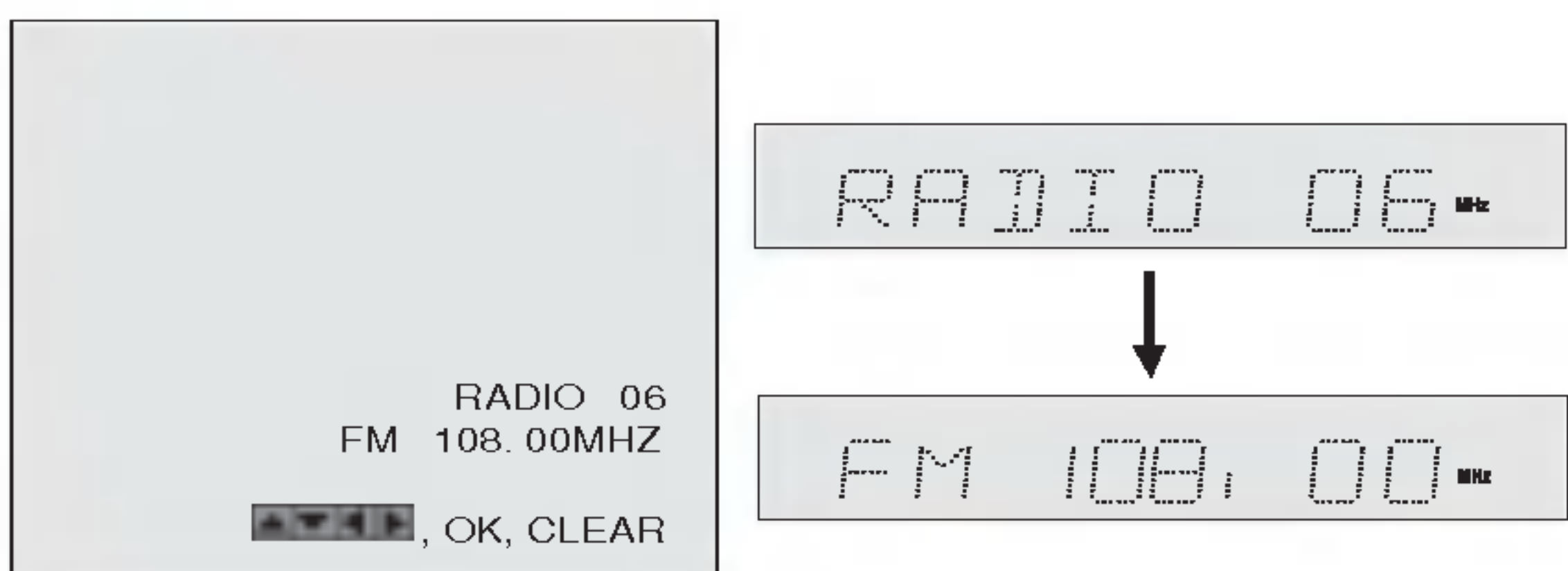

3. Press FM/AM on the remote control or on the front panel to select the desired band.
4. Hold down + PRESET - n the front panel or hold down ◀ and ▶ on the remote control for 1 or 2 seconds, and a station is searched for automatically.

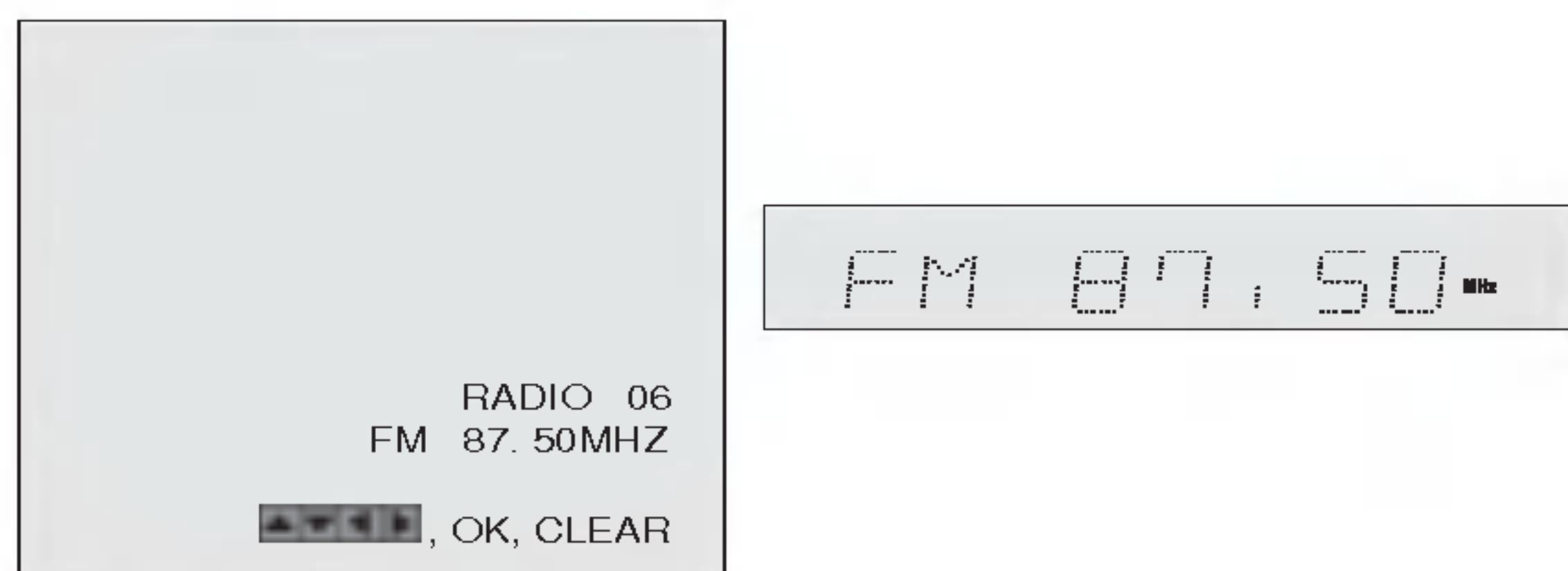

5. Press MEMORY on the remote control.



6. Repeat steps 2 to 5 to store other stations.

Listening to the Radio

Preset radio stations in the DVD/VCR Combi receiver memory first (see "Presetting radio stations" on the left).

1. Press FM/AM on the remote control or on the front panel until the frequency band appears on the display and TV screen.
The last received station is tuned in.
2. Press ▲/▼ on the remote control repeatedly to select the preset station you want.
Each time you press the button, the DVD/VCR Combi receiver tunes in one preset station at a time.
3. Adjust the volume by rotating VOLUME on the front panel or by pressing VOLUME + or - on the remote control repeatedly.

To Clear the Stored Radio Stations

1. Press FM/AM on the remote control or on the front panel until the frequency band appears on the display and TV screen.

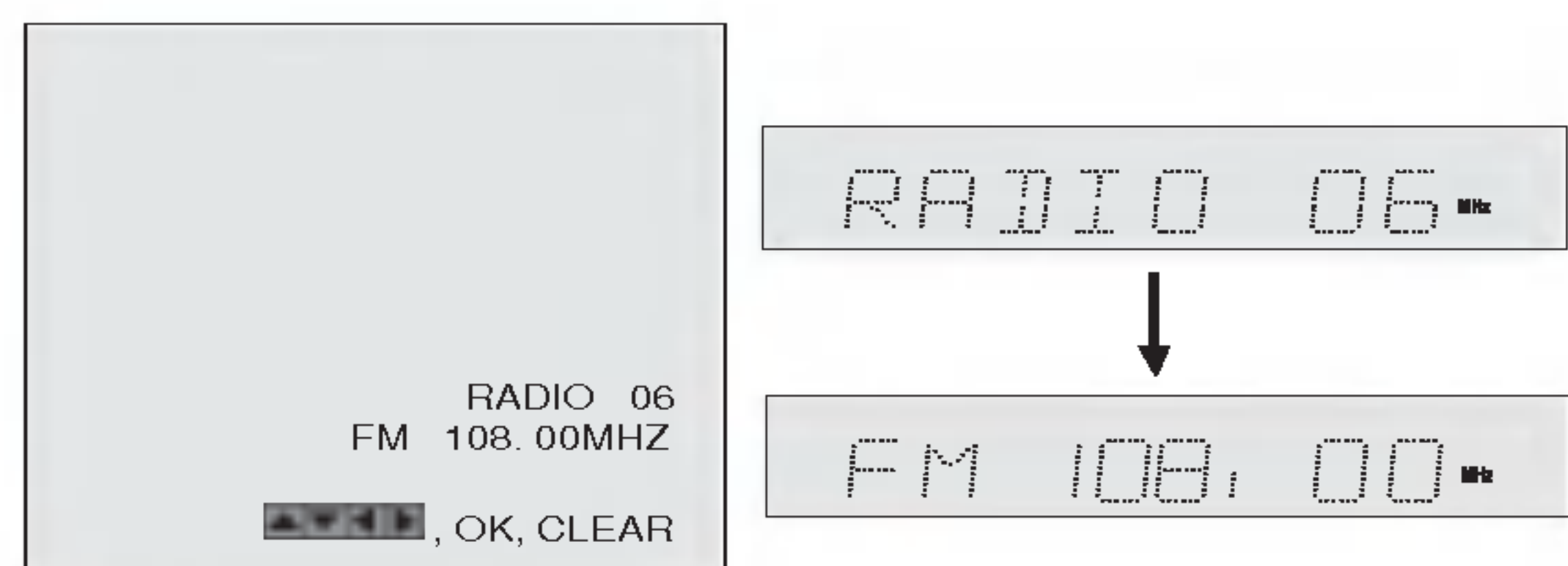

2. Press ▲/▼ on the remote control to select your desired station.

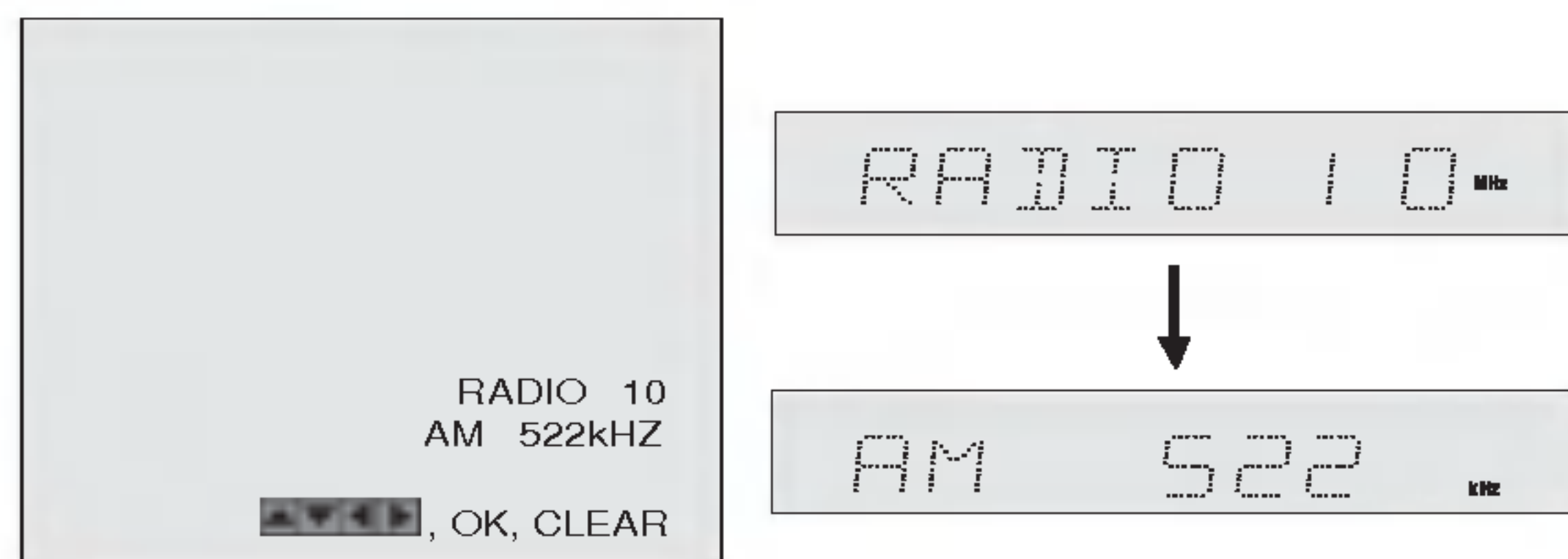

3. Press CLEAR the remote control to clear the stored radio station.

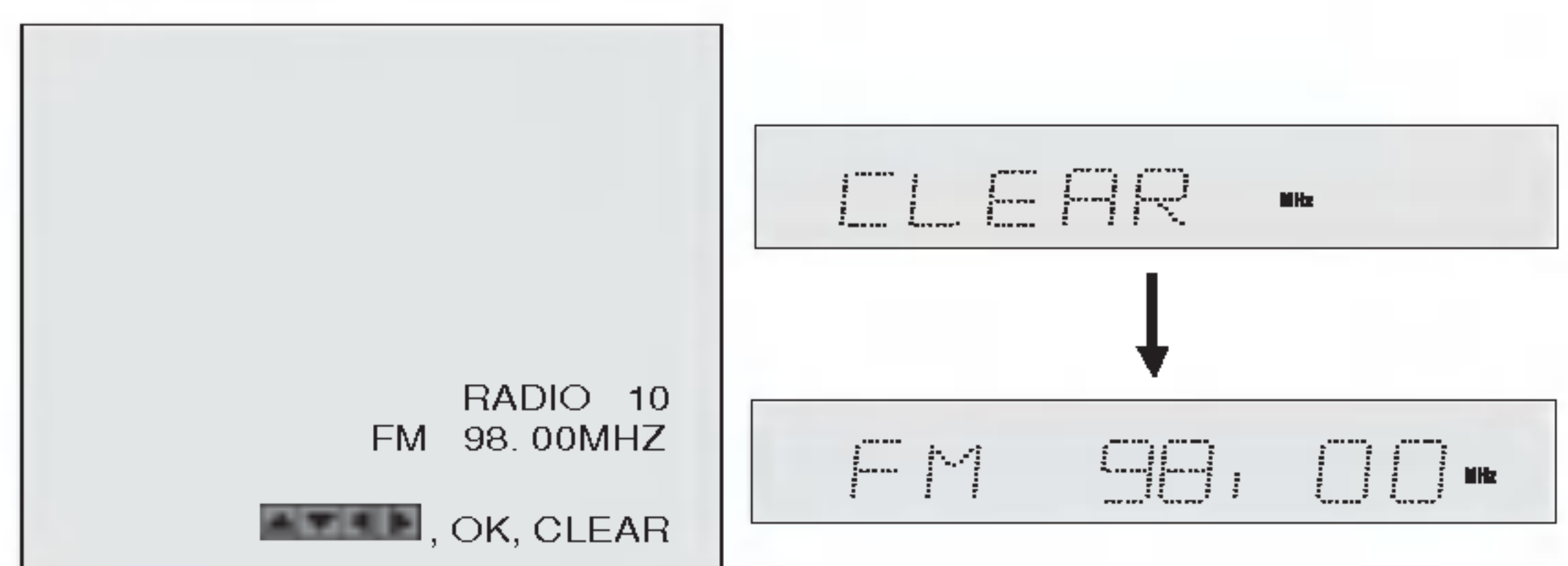

Note

- While record or record pause mode, the CLEAR function may not be operated.

Tuning into a Station Manually

1. Press **FM/AM** on the remote control or on the front panel until the frequency band appears on the display and TV screen.
2. Press **FM/AM** on the remote control or on the front panel to select the desired band.
3. Press **+ PRESET -** on the front panel or hold down **◀** and **▶** on the remote control to tune in the desired station.

Tuning into a Station Automatically

Hold down **+ PRESET -** on the front panel or hold down **◀** and **▶** on the remote control for 1 or 2 seconds, and a station is searched for automatically.

Note

- The search may not stop at a station with a very weak signal.

Mute

Press **MUTE** to mute your unit.

You can mute your unit in order, for example, to answer the telephone, **MUTING** and **MUTE** indicator appear in the display.

RDS Operation

This unit is equipped with RDS (Radio Data System), which brings a wide range of information to FM radio. Now in use in many countries, RDS is a system for transmitting station call signs or network information, a description of station programme type text message about the station or specifics of musical selection and the correct time.

RDS Tuning

When a FM station is tuned in and it contains RDS data, the unit will automatically display the station's call sign and the RDS indicator will light in the Display Window as well as indicators for the RDS services programme (PS) if transmitted by the station.

RDS Display

The RDS system is capable of transmitting a wide variety of information in addition to the initial call sign that appears when a station is first tuned. In normal RDS operation the display will indicate the station name. Pressing **RDS** on the remote control enables you to show the station name.

Note

- If the RDS services programme (PS) is not being transmitted, the Display Window will show a **PS NONE** message.

Language Codes

Use this list to input your desired language for the following initial settings:
Disc Audio, Disc Subtitle, Disc Menu.

Language	Code	Language	Code	Language	Code	Language	Code
Abkhazian	6566	Fiji	7074	Lingala	7678	Singhalese	8373
Afar	6565	Finnish	7073	Lithuanian	7684	Slovak	8375
Afrikaans	6570	French	7082	Macedonian	7775	Slovenian	8376
Albanian	8381	Frisian	7089	Malagasy	7771	Somali	8379
Ameharic	6577	Galician	7176	Malay	7783	Spanish	6983
Arabic	6582	Georgian	7565	Malayalam	7776	Sudanese	8385
Armenian	7289	German	6869	Maltese	7784	Swahili	8387
Assamese	6583	Greek	6976	Maori	7773	Swedish	8386
Aymara	6588	Greenlandic	7576	Marathi	7782	Tagalog	8476
Azerbaijani	6590	Guarani	7178	Moldavian	7779	Tajik	8471
Bashkir	6665	Gujarati	7185	Mongolian	7778	Tamil	8465
Basque	6985	Hausa	7265	Nauru	7865	Tatar	8484
Bengali; Bangla	6678	Hebrew	7387	Nepali	7869	Telugu	8469
Bhutani	6890	Hindi	7273	Norwegian	7879	Thai	8472
Bihari	6672	Hungarian	7285	Oriya	7982	Tibetan	6679
Breton	6682	Icelandic	7383	Panjabi	8065	Tigrinya	8473
Bulgarian	6671	Indonesian	7378	Pashto, Pushto	8083	Tonga	8479
Burmese	7789	Interlingua	7365	Persian	7065	Turkish	8482
Byelorussian	6669	Irish	7165	Polish	8076	Turkmen	8475
Cambodian	7577	Italian	7384	Portuguese	8084	Twi	8487
Catalan	6765	Japanese	7465	Quechua	8185	Ukrainian	8575
Chinese	9072	Javanese	7487	Rhaeto-Romance	8277	Urdu	8582
Corsican	6779	Kannada	7578	Rumanian	8279	Uzbek	8590
Croatian	7282	Kashmiri	7583	Russian	8285	Vietnamese	8673
Czech	6783	Kazakh	7575	Samoan	8377	Volapük	8679
Danish	6865	Kirghiz	7589	Sanskrit	8365	Welsh	6789
Dutch	7876	Korean	7579	Scots Gaelic	7168	Wolof	8779
English	6978	Kurdish	7585	Serbian	8382	Xhosa	8872
Esperanto	6979	Laothian	7679	Serbo-Croatian	8372	Yiddish	7473
Estonian	6984	Latin	7665	Shona	8378	Yoruba	8979
Faroese	7079	Latvian, Lettish	7686	Sindhi	8368	Zulu	9085

Country Codes

Choose a country code from this list.

Country	Code	Country	Code	Country	Code	Country	Code
Afghanistan	AF	Ethiopia	ET	Malaysia	MY	Saudi Arabia	SA
Argentina	AR	Fiji	FJ	Maldives	MV	Senegal	SN
Australia	AU	Finland	FI	Mexico	MX	Singapore	SG
Austria	AT	France	FR	Monaco	MC	Slovak Republic	SK
Belgium	BE	Germany	DE	Mongolia	MN	Slovenia	SI
Bhutan	BT	Great Britain	GB	Morocco	MA	South Africa	ZA
Bolivia	BO	Greece	GR	Nepal	NP	South Korea	KR
Brazil	BR	Greenland	GL	Netherlands	NL	Spain	ES
Cambodia	KH	Islands	HM	Netherlands Antilles	AN	Sri Lanka	LK
Canada	CA	Hong Kong	HK	New Zealand	NZ	Sweden	SE
Chile	CL	Hungary	HU	Nigeria	NG	Switzerland	CH
China	CN	India	IN	Norway	NO	Taiwan	TW
Colombia	CO	Indonesia	ID	Oman	OM	Thailand	TH
Congo	CG	Israel	IL	Pakistan	PK	Turkey	TR
Costa Rica	CR	Italy	IT	Panama	PA	Uganda	UG
Croatia	HR	Jamaica	JM	Paraguay	PY	Ukraine	UA
Czech Republic	CZ	Japan	JP	Philippines	PH	United States	US
Denmark	DK	Kenya	KE	Poland	PL	Uruguay	UY
Ecuador	EC	Kuwait	KW	Portugal	PT	Uzbekistan	UZ
Egypt	EG	Libya	LY	Romania	RO	Vietnam	VN
El Salvador	SV	Luxembourg	LU	Russian Federation	RU	Zimbabwe	ZW

Check the following guide for the possible cause of a problem before contacting service.

Symptom	Cause	Correction
No power.	<ul style="list-style-type: none"> The power cord is disconnected. 	<ul style="list-style-type: none"> Plug the power cord into the wall outlet securely.
The power is on, but the DVD/VCR Combi receiver does not work.	<ul style="list-style-type: none"> No disc is inserted. No tape is inserted. 	<ul style="list-style-type: none"> Insert a disc or tape. (Check that the disc or tape indicator in the display window is lit.)
No picture.	<ul style="list-style-type: none"> The TV is not set to receive DVD/VCR Combi receiver signal output. 	<ul style="list-style-type: none"> Select the appropriate video input mode on the TV so the picture from the DVD/VCR Combi receiver appears on the TV screen.
	<ul style="list-style-type: none"> TV/VCR mode for DVD/VCR Combi receiver is set to TV. 	<ul style="list-style-type: none"> Press the TV/VCR button on the remote control repeatedly to choose VCR mode. TV indicator disappears in the display window.
	<ul style="list-style-type: none"> The video cable is not connected securely. 	<ul style="list-style-type: none"> Connect the video cable securely.
	<ul style="list-style-type: none"> The connected TV power is turned off. 	<ul style="list-style-type: none"> Turn on the TV.
No sound.	<ul style="list-style-type: none"> The equipment connected with the audio cable is not set to receive DVD/VCR Combi receiver signal output. 	<ul style="list-style-type: none"> Select the correct input mode on the audio receiver so you can listen to the sound from the DVD/VCR Combi receiver.
	<ul style="list-style-type: none"> The audio cables are not connected securely. 	<ul style="list-style-type: none"> Connect the audio cables securely.
	<ul style="list-style-type: none"> The power of the equipment connected with the audio cables is turned off. 	<ul style="list-style-type: none"> Turn on the equipment connected with the audio cables.
	<ul style="list-style-type: none"> The digital audio output is set to the wrong position. 	<ul style="list-style-type: none"> Set the digital audio output to the correct position, then turn on the DVD/VCR Combi receiver again by pressing POWER.
The playback picture is poor.	<ul style="list-style-type: none"> The disc is dirty. 	<ul style="list-style-type: none"> Clean the disc.
	<ul style="list-style-type: none"> Tape heads are dirty. 	<ul style="list-style-type: none"> Clean video heads.
	<ul style="list-style-type: none"> Tape is a rental or was recorded on another DVD/VCR Combi receiver. 	<ul style="list-style-type: none"> Use (▲/▼) for manual tracking adjustment while tape is playing.
The DVD/VCR Combi receiver does not start playback.	<ul style="list-style-type: none"> No disc is inserted. No tape is inserted. 	<ul style="list-style-type: none"> Insert a disc or tape. (Check that the disc or tape indicator in the display window is lit.)
	<ul style="list-style-type: none"> An unplayable disc is inserted. 	<ul style="list-style-type: none"> Insert a playable disc. (Check the disc type, color system, and Regional code.)
	<ul style="list-style-type: none"> The disc is placed upside down. 	<ul style="list-style-type: none"> Place the disc with the playback side down.
	<ul style="list-style-type: none"> The disc is not placed within the guide. 	<ul style="list-style-type: none"> Place the disc on the disc tray correctly inside the guide.
	<ul style="list-style-type: none"> The disc is dirty. 	<ul style="list-style-type: none"> Clean the disc.
	<ul style="list-style-type: none"> The Rating level is set. 	<ul style="list-style-type: none"> Cancel the Rating function or change the rating level.

Video Head Cleaning

Whenever a video cassette is inserted into or ejected from your DVD/VCR Combi receiver the video head is automatically cleaned. This should mean that additional head cleaning should not be necessary. However dirt accumulating on the head after a long period of time can cause the playback picture to become blurred or broken up. High quality video cassette tapes will not normally deposit dirt onto the video head, but old or damaged tapes might.

Symptom	Cause	Correction
<ul style="list-style-type: none"> This remote control uses the same buttons for VCR and DVD functions (ex. PLAY). 	<ul style="list-style-type: none"> The remote control is not pointed at the remote sensor of the DVD/VCR Combi receiver. 	<ul style="list-style-type: none"> Point the remote control at the remote sensor of the DVD/VCR Combi receiver.
	<ul style="list-style-type: none"> The remote control is too far from the DVD/VCR Combi receiver. 	<ul style="list-style-type: none"> Operate the remote control within 23 ft (7 m).
	<ul style="list-style-type: none"> There is an obstacle in the path of the remote control and the DVD/VCR Combi receiver. 	<ul style="list-style-type: none"> Remove the obstacle.
	<ul style="list-style-type: none"> The batteries in the remote control are exhausted. 	<ul style="list-style-type: none"> Replace the batteries with new ones.
	<ul style="list-style-type: none"> This remote control uses the same buttons for VCR and DVD functions (ex. PLAY). 	<ul style="list-style-type: none"> When using a VCR, first press the VCR button. When using a DVD, first press the CD/DVD button.
The tape does not run during recording.	<ul style="list-style-type: none"> The DVD/VCR Combi receiver is in the RECORD PAUSE MODE. 	<ul style="list-style-type: none"> Press PAUSE/STEP (III) to resume recording.
The tape will not rewind or fast-forward.	<ul style="list-style-type: none"> The tape is already fully rewound or fast-forwarded. 	<ul style="list-style-type: none"> Check the tape.
The playback picture does not appear while the tape is running.	<ul style="list-style-type: none"> If you're using only the RF cable for connection. 	<ul style="list-style-type: none"> Set the TV to the Video channel (see p. 17).
Noise appears during visual search.	<ul style="list-style-type: none"> This is normal. 	<ul style="list-style-type: none"> Turn camcorder on and operate properly.
Noise appears during normal playback.	<ul style="list-style-type: none"> The automatic tracking mode is engaged. The automatic tracking mode is engaged. 	<ul style="list-style-type: none"> Try manual tracking (see p. 27).
Breaks are noticeable in Hi-Fi soundtrack.	<ul style="list-style-type: none"> There is no tape loaded, or the tape loaded has had its record safety tab removed. 	<ul style="list-style-type: none"> Try manual tracking (see p. 27).
Recording cannot be started.	<ul style="list-style-type: none"> The source (another VCR, camcorder) has not been properly connected. 	<ul style="list-style-type: none"> Insert a tape, or using adhesive tape, cover the hole where the tab was removed.
Tape-to-tape editing is not possible.	<ul style="list-style-type: none"> The clock/or the timer have been set incorrectly. 	<ul style="list-style-type: none"> Confirm that the camcorder is properly connected.
Timer recording won't work.	<ul style="list-style-type: none"> The timer is not engaged. The loaded tape has had its record safety tab removed. Audio mode is not set properly. 	<ul style="list-style-type: none"> Re-perform the clock and/or timer settings. Press POWER and confirm that the timer indicator is displayed on the DVD/VCR Combi receiver's Display. Insert a pate with adhesive tape, or insert a tape with the record safety tab intact.
No Hi-Fi sound.		<ul style="list-style-type: none"> Select "STEREO" by repeatedly pressing AUDIO on the remote control.

Moisture Condensation

Moisture condensation can occur:	In locations where moisture condensation may occur:
<ul style="list-style-type: none"> When the DVD/VCR Combi receiver is moved from a cold place to a warm place. Under extremely humid conditions. 	<ul style="list-style-type: none"> Keep the DVD/VCR Combi receiver plugged into an AC power outlet with POWER On. This will help prevent condensation. When condensation has occurred, wait a few hours for the DVD/VCR Combi receiver to dry before using it.

General

Power requirements	Refer to main label
Power consumption	Refer to main label
Dimensions (approx.)	430 X 81 X 360 mm (w x h x d)
Mass (approx.)	5.8 kg (17.6 lbs)
Operating temperature	5°C to 40°C (41°F to 104°F)
Timer	24-hour display type
Operating humidity	5 % to 90 %

DVD Section

Laser	Semiconductor laser, wavelength 650 nm
Signal system	PAL/NTSC
Frequency response	DVD (PCM 96 kHz): 8 Hz to 44 kHz DVD (PCM 48 kHz): 8 Hz to 20 kHz CD: 8 Hz to 20 kHz
Signal-to-noise ratio	More than 65 dB (analog out connectors only)
Harmonic distortion	Less than 1.0%
Dynamic range	More than 60 dB (DVD, CD)

Outputs

S-VIDEO OUT	(Y) 1.0 V (p-p), 75 ohms, negative sync, Mini DIN 4-pin x 1 (C) 0.3 V (p-p) 75 ohms
-------------	--

VCR Section

Head system	6 heads helical scan azimuth system
Television system	PAL/SECAM colour system
Recording format	PAL/MESECAM
RF OUT	K
RF-Modulator	UHF 22-68 (adjustable)
Tape speed	PAL/MESECAM; 23.39 mm/s (SP), 16.69 mm/s (LP) NTSC (Playback only); 35.35 mm/s (SP), 16.67 mm/s (LP), 11.12 mm/s (EP)
Maximum recording time	SP: 4 h (E-240 tape), LP: 8 h (E-240 tape)
Rewind time	About 180 min (E-180 tape)
Input level	VIDEO: 1.0 V(p-p), 75 ohms, unbalanced AUDIO: -6.0 dBm, more than 10 kohms (SCART) -6.0 dBm, more than 47 kohms (RCA)
Output level	VIDEO: 1.0 V(p-p), 75 ohms, unbalanced
Signal-to-noise ratio	VIDEO: More than 43 dB AUDIO: More than 72 dB (Hi-Fi) More than 42 dB (Mono)
Dynamic range	AUDIO: More than 85 dB

Tuner Section

Tuning range	FM: 87.5 - 108.0 MHz AM: 522 - 1611 kHz
Intermediate frequency	FM: 10.7 MHz AM: 450 kHz

Amplifier Section

Stereo mode	25W + 25W (6 ohm at 1 kHz, THD 10%)
Surround mode	Front: 25W + 25W (THD 10%) Centre: 25W Surround: 25W + 25W (6 ohm at 1 kHz, THD 10%) Subwoofer: 60W (8 ohm at 30 Hz, THD 10%)

Speaker Section

Satellite (LHS-CX245T)

Type	1 Way 1 Speaker
Impedance	6 Ω
Frequency Response	130 - 20,000 Hz
Sound Pressure Level	85 dB/W (1m)
Rated Input Power	25W
Max Input Power	50W
Net Dimensions (W x H x D)	90 x 138.5 x 100 mm
Net Weight	0.89 kg

Passive Subwoofer (LHS-CX245W)

Type	1 Way 1 Speaker
Impedance	8 Ω
Frequency Response	50 - 1,500 Hz
Sound Pressure Level	82 dB/W (1m)
Rated Input Power	60W
Max Input Power	120W
Net Dimensions (W x H x D)	160 x 350 x 345 mm
Net Weight	4.5 kg

Accessories:

AM/FM antenna, Speaker cable x 5, Scart cable x 1, Remote control x 1, Batteries (AAA) x 2

- Design and specifications are subject to change without notice.

Manufactured under license from Dolby Laboratories. "Dolby", "Pro Logic" and the double-D symbol are trademarks of Dolby Laboratories.

"DTS" and "DTS Digital Out" are trademarks of Digital Theater Systems, Inc.



P/N: 3835RH0049K