





# **MP3/CD CASSETTE RECORDER OWNER'S MANUAL**

**MODEL: LPC-LM730A/X  
LPC-LM735A/X**

**Please read this manual carefully before operating your set.  
Retain it for future reference.**

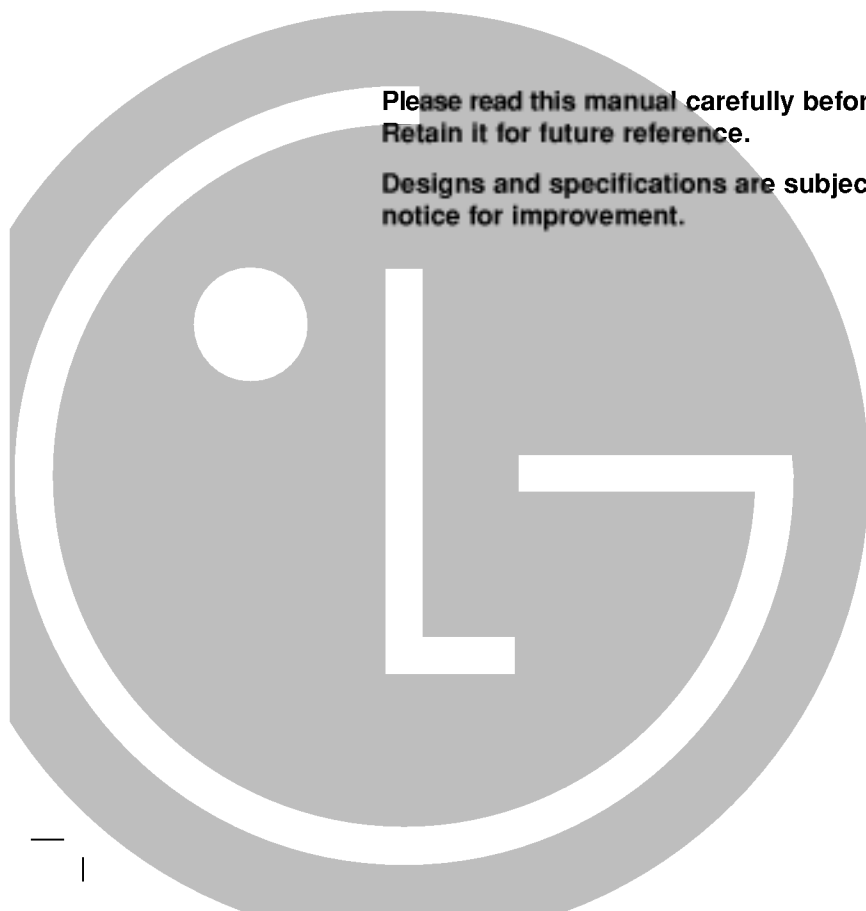
**Designs and specifications are subject to change without  
notice for improvement.**



	<b>CAUTION</b> RISK OF ELECTRIC SHOCK DO NOT OPEN	
CAUTION: TO REDUCE THE RISK OF ELECTRIC SHOCK DO NOT REMOVE COVER (OR BACK) NO USER SERVICEABLE PARTS INSIDE. REFER SERVICING TO QUALIFIED SERVICE PERSONNEL.		

**Explanation Graphical Symbols:**



The lightning flash with arrowhead symbol, within an equilateral triangle is intended to alert the user to the presence of uninsulated dangerous voltage within the product's enclosure that may be of sufficient magnitude to constitute a risk of electric shock to persons.



The exclamation point within an equilateral triangle is intended to alert the user to the presence of important operating and maintenance (servicing) instructions in the literature accompanying the appliance.

**WARNING**

TO REDUCE THE RISK OF FIRE OF ELECTRIC SHOCK, DO NOT EXPOSE THIS APPLIANCE TO RAIN OR MOISTURE.

To avoid electrical shock, do not open the cabinet, Refer servicing to qualified personnel only.

**The apparatus shall not be exposed to dripping or splashing and that no objects filled with liquids, such as vases, shall be placed on the apparatus.**

**Do not install this equipment in a confined space such a bookcase or similar unit.**

<b>CAUTION</b> Use of controls or adjustments or performance of procedures other than those specified herein may result in hazardous radiation exposure.
---

Laser component in this product is capable of emitting radiation exceeding the limit for Class 1.

<b>CAUTION: INVISIBLE LASER RADIATION WHEN OPEN AND INTERLOCKS DEFEATED. AVOID EXPOSURE TO BEAM.</b>
--

**WARNING: OSYNLIG LASERSTRÅLNING NÄR DENNA DEL ÄR ÖPPNAD STRÅLEN ÄR FARLIG.**

**Attention:** Quand l'appareil est ouvert, ne pas s'exposer aux radiations invisibles du faisceau laser.

This label is located on the interior.

<b>CLASS 1 LASER PRODUCT          KLASSE 1 LASER PRODUKT          LUOKAN 1 LASER LAITE          KLASS 1 LASER APPARAT          CLASSE 1 PRODUCT LASER</b>
---

This Compact Disc player is classified as a CLASS 1 LASER product. The CLASS 1 LASER PRODUCT label is located on the exterior.

## Contents



<b>1 Introduction</b> .....	4
Symbols Used in this Manual .....	4
Notes on Tapes .....	4
Notes on Discs .....	4
Handling discs .....	4
Storing discs .....	4
Cleaning discs .....	4
Front / Rear Panel .....	5
Remote Control .....	6
Display Window .....	6
<b>2 Installation</b> .....	7
The AC Power Cord Connection .....	7
Adjusting the voltage (OPTIONAL) .....	7
Battery Installation .....	7
Unit .....	7
Remote Control .....	7
Sound Adjustment .....	8
Volume Adjustment .....	8
Sound Quality Adjustment .....	8
MUTE .....	8
SURROUND .....	8
XDSS (Extreme Dynamic Sound System) .....	8
Headphone Socket .....	8
<b>3 Operation</b> .....	9
Auto Function Selection .....	9
Setting the Clock .....	9
Using the Sleep Function .....	9
Timer .....	10
Presetting the Radio Stations .....	11
Listening to the Radio .....	11
Tape Playback .....	12
Basic Playback .....	12
To Stop Play .....	12
To Play Rewind or Fast Forward .....	12
Auto Stop Deck : LPC-LM730A/X model only .....	12
Auto Reverse Deck : LPC-LM735A/X model only .....	12
Tape Recording .....	12
Basic Recording .....	12
Recording from Radio or CD .....	12
CD to Tape Synchronized Recording .....	12
CD Playback .....	13
Basic Playback .....	13
Pause Playback .....	13
Stop Playback .....	13
Skipping a Track .....	13
Searching a Track .....	13
Repeat .....	13
Program Play .....	13
<b>4 Maintenance and Service</b> .....	14
Shipping the Unit .....	14
Cleaning the Unit .....	14
Troubleshooting .....	14
<b>5 Reference</b> .....	15
Remote Control Operation Range .....	15
Specifications .....	15

# 1 Introduction

To ensure proper use of this product, please read this owner's manual carefully and retain for future reference.

This manual provides information on the operation and maintenance of your CD player. Should the unit require service, contact an authorized service location (refer to Chapter 4, Maintenance and Service).

## Symbols Used in this Manual

-  Indicates hazards likely to cause harm to the unit itself or other material damage.
-  Indicates special notes and operating features.

## Notes on Tapes

### Preventing record

Removing the tab(s) of the cassette (with a small screwdriver) will prevent accidental erasure.

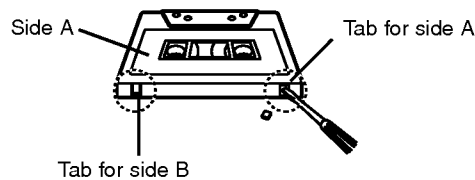

To record again, cover the hole of the tab with adhesive tape.

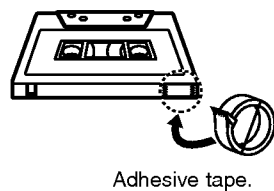

## Notes on Discs

### Handling discs

Do not touch the playback side of the disc. Hold the disc by the edges so that fingerprints do not get on the surface. Never stick paper or tape on the disc.

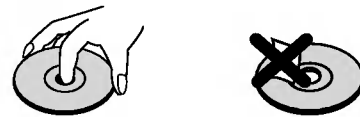

### Storing discs

After playing, store the disc in its case. Do not expose the disc to direct sunlight or sources of heat and never leave it in a parked car exposed to direct sunlight.

### Cleaning discs

Fingerprints and dust on the disc can cause poor picture quality and sound distortion. Before playing, clean the disc with a clean cloth. Wipe the disc from the center out.

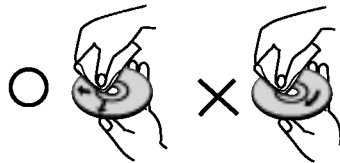

Do not use strong solvents such as alcohol, benzene, thinner, commercially available cleaners, or anti-static spray intended for older vinyl records.

## Front / Rear Panel

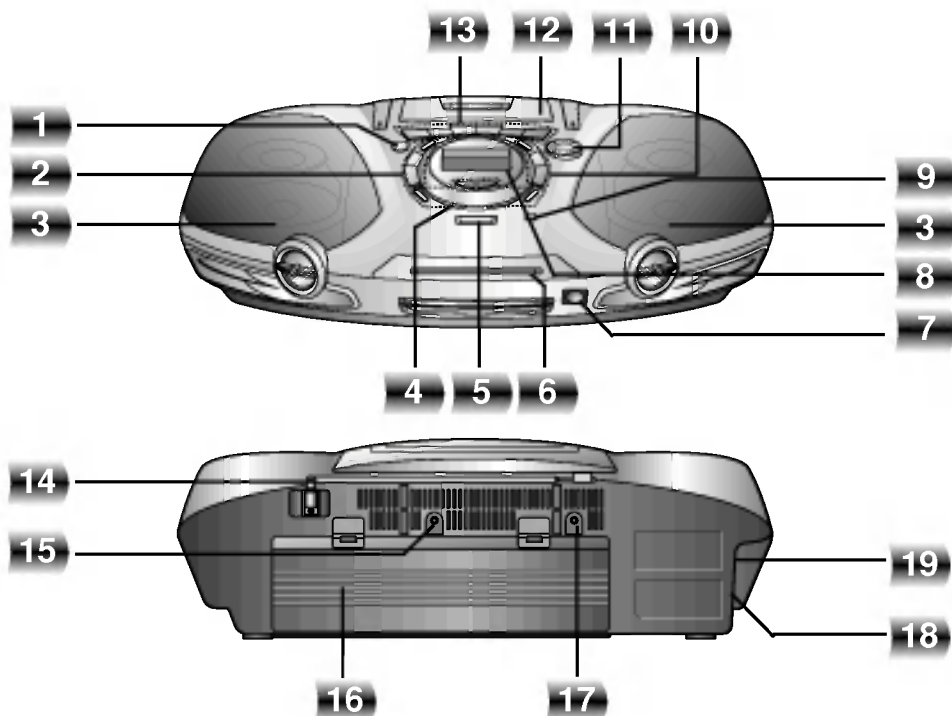

1. POWER (STANDBY/ON) button
2. • CD SYNC. button  
• FUNCTION SELECT buttons (CD/TAPE)
3. LEFT/RIGHT SPEAKER
4. • TAPE MODE button : LPC-LM735A/X model only  
• COUNTER RESET button  
• TIMER button  
• CLOCK button  
• SET/CD PAUSE (CD II) buttons
5. XDSS button
6. CD DOOR
7. REMOTE SENSOR
8. DISPLAY WINDOW
9. CD OPEN/CLOSE (▲ OPEN/CLOSE) button
10. • PROG./MEMORY button  
• FUNCTION SELECT button (TUNER/BAND)  
• MODE/RIF/REPEAT button
11. VOLUME (▼/▲) button
12. TAPE DOOR (▲ PUSH EJECT)
13. • RECORD/RECORD PAUSE (●/II) button  
• TUNING/TIME (-/+) buttons  
• CD SKIP/SEARCH (|◀◀◀/▶▶▶|) buttons  
• TAPE REWIND/FAST FORWARD (◀◀◀/▶▶▶) buttons  
• PRESET (-/+) buttons  
• TAPE REVERSE PLAY (◀) button:  
LPC-LM735A/X model only  
• TAPE PLAY (▶)/CD PLAY (▶) button  
• STOP (■)/CLEAR button
14. FM ANTENNA
15. MICROPHONE SOCKET- ∅ 3.5mm :  
OPTIONAL
16. BATTERY COMPARTMENT
17. HEADPHONE SOCKET (🎧 PHONES) - ∅  
3.5mm : OPTIONAL
18. AC POWER INPUT SOCKET
19. VOLTAGE SELECTOR : OPTIONAL

## Remote Control

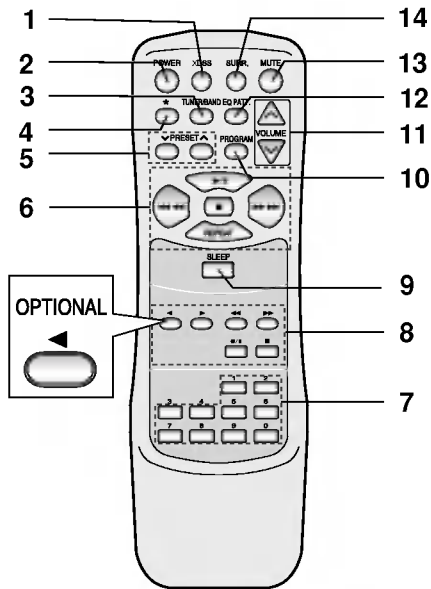

1. XDSS button
2. POWER button
3. TUNER/BAND button
4. This button is not available.
5. PRESET (∇/∧) button
6. CD FUNCTION buttons
  - PLAY/PAUSE (▶/||) button
  - CD STOP (■) button
  - CD SKIP/SEARCH (◀◀◀/▶▶▶) button
  - REPEAT button
7. NUMBER buttons
8. TAPE FUNCTION buttons
  - RECORD/ RECORD PAUSE button (●/||)
  - BACKWARD PLAY button (◀) : OPTIONAL
  - FORWARD PLAY (▶) button
  - TAPE STOP button (■)
  - FAST FORWARD (▶▶) button
  - REWIND (◀◀) button
9. SLEEP button
10. PROGRAM button
11. VOLUME (∇/∧) button
12. EQUALIZER PATTERN (EQ PATT.) button
13. MUTE button
14. SURROUND (SURR.) button

## Display Window

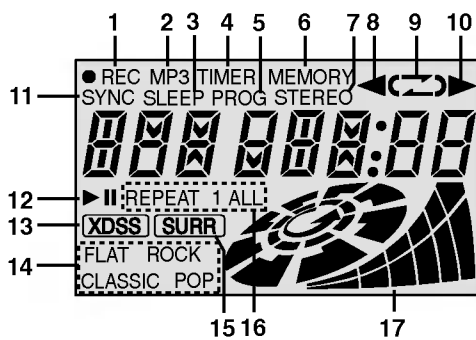

1. RECORD/ RECORD PAUSE indicator
2. MP3 file indicator
3. SLEEP indicator
4. TIMER indicator
5. PROGRAM indicator
6. MEMORY indicator
7. STEREO indicator
8. BACKWARD PLAY indicator (LPC-LM735A/X model only)
9. TAPE MODE indicator (LPC-LM735A/X model only)
10. FORWARD PLAY indicator
11. CD SYNCHRO RECORDING indicator
12. CD PLAY/PAUSE indicator
13. XDSS indicator
14. Equalizer indicator
15. Surround indicator
16. CD REPEAT indicator
17. • VOLUME indicator
  - SOUND LEVEL METER

## 2 Installation

### The AC Power Cord Connection

1. Before connecting the AC power cord, check that the operating voltage of your unit is identical with the voltage of your local power supplied.
2. Connect one end of the AC power cord (supplied) to the AC IN socket located at the backside of your unit.
3. Plug the other end into the wall outlet.



#### Note

Unplug the AC power cord from the wall outlet if you do not to use for an extended period of time.

### Adjusting the voltage (OPTIONAL)

If your unit is equipped with a voltage selector at the back side, be sure to set it to your local power supplied before connecting the AC power cord.

### Battery Installation

#### Unit

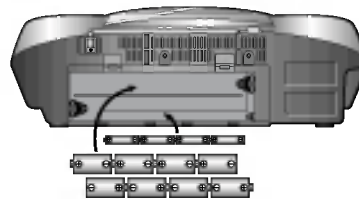

1. Press and open the battery cover.
2. Put eight "D" (R20) batteries and four "AA" (R6) batteries into the compartment making sure the  $\oplus$  and  $\ominus$  are correctly positioned.
3. Replace the battery cover.

#### Remote Control

1. Detach the battery cover on the rear of the remote control.
2. Insert two R03 (size AAA) batteries with  $\oplus$  and  $\ominus$  aligned correctly.

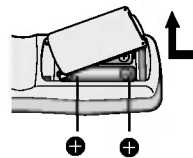

3. Replace the battery cover.

#### Note

- To avoid damage from possible battery leakage, remove the batteries if you do not plan to use the unit for an extended period of time.
- When the batteries are weak, replace all the batteries with new ones.
- During the AC power cord connect to the wall outlet, the batteries are not worn out.

## Sound Adjustment

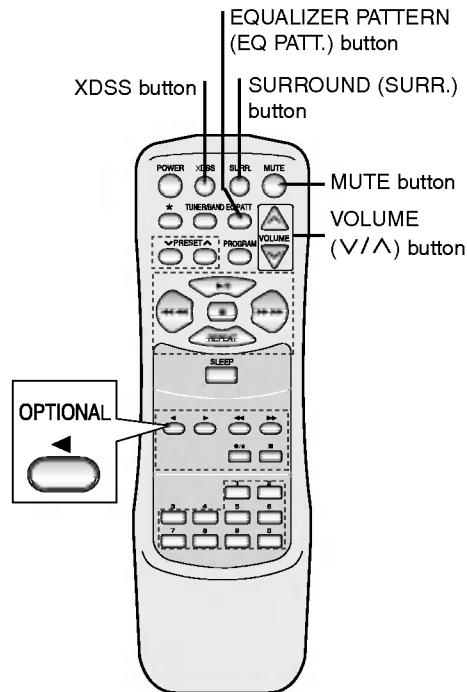

## Volume Adjustment

Press VOLUME (Unit: ▲, Remote control: ▲) to increase the sound level, or press the VOLUME (Unit: ▼, Remote control: ▼) to decrease it.

## Sound Quality Adjustment

You can choose between 4 fixed sound impressions.

Select a desired sound mode by using EQ PATT. button on the remote control.

- FLAT : linear frequency response
- ROCK : more bass, more treble
- POP : less bass, less treble
- CLASSIC : for orchestral music

## MUTE

Press **MUTE** to mute your unit.

You can mute your unit in order, for example, to answer the telephone, "MUTE" indicator flashes in the display window.

## SURROUND

To activate surround mode

Press SURROUND(SURR.) to reinforce surround effect.

- "SURR" indicator lights up in the display window.

To cancel it press SURROUND(SURR.) again.

## XDSS (Extreme Dynamic Sound System)

Press XDSS to reinforce treble and bass.

- "XDSS" and "SURR" indicator lights up in the display window.

To cancel it press XDSS again.

## Headphone Socket

Connect a stereo headphone plug (∅ 3.5mm) into the headphone jack.

The speakers are automatically disconnected when you plug in the headphones (not supplied).



## 3 Operation

### Auto Function Selection

- If you press CD PLAY/ PAUSE (▶/||) during listen to the radio, CD playback will begin.
- If you press PRESET (∇/∧) or TUNER/ BAND during CD or CASSETTE play, radio function will work.

### Setting the Clock

1. Press CLOCK.  
(If the clock is requires setting, press and hold CLOCK for more than 2 seconds.)
2. Select a 24 hour cycle or 12 hour cycle by pressing TUNING/TIME (-/+).

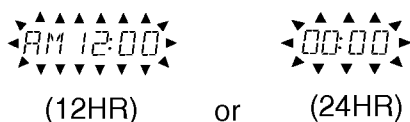

3. Press SET to confirm the selected hour cycle.
4. Use TUNING/TIME (-/+) to set the correct hours.
5. Press SET.
6. Use TUNING/TIME (-/+) to set the correct minutes.
7. Press SET and the correct time is shown on the display.
8. Press CLOCK at any time to display the time for about 5 seconds.

### Using the Sleep Function

When the sleep timer is used, the power is automatically turned off after the specified time has elapsed.

1. To specify the time delay before the power is turned off, press SLEEP.  
In the display window you can see "90 SLEEP" for about 5 seconds. This means that the system turns off automatically after 90 minutes.  
Each time the button is pressed the time interval before it turns off is reduced by 10 minutes. i.e. 80...70... etc.  
Select the desired time to turn off.
2. To check the remaining time until the power is turned off.  
While the sleep function is active press SLEEP briefly. The time remaining until it turns off is displayed for about 5 seconds.



#### Note

If you press SLEEP while the sleep time is displayed, the SLEEP time is reset.

To cancel the sleep timer mode

If you wish to stop the function, press the SLEEP button repeatedly until 10 SLEEP appears, and then press SLEEP once again while 10 SLEEP is displayed.

## Timer

- This function is automatically turned on and off at the time you want.
- Select your desired radio station, press CD button and load a disc or press TAPE button and insert a TAPE.

1. Press CLOCK to check the current time.

For your reference

If you don't set clock, timer function doesn't work.

2. Press TIMER to enter the timer setting mode. TUN-CD-TAPE flashes in the display window in turn.

For your reference

- If you want to correct the previous memorized TIMER setting, press and hold the TIMER button more than 2 seconds.
- The previous memorized timer on time and TIMER indicators appear in the display window.

3. Press SET when the desired function is flashing.

4. 1. a. When you select the TUNER(TUN) function, 'PLAY' and 'REC' indicator flash in the display window alternately for about 3 seconds.

'PLAY' indicator : TUNER play only  
'REC' indicator : TUNER play and  
recording

b. Press SET when the desired function is flashing.

c. Select the previous memorized preset number with TUNING/TIME (-/+) button and press SET.

- 'ON' indicator appears for about 0.5 seconds in the display window and then disappears.

2. When you select the CD or TAPE function,

- 'ON' indicator appears for about 0.5 seconds in the display window and then disappears.

5. Set the hour to switch on by pressing TUNING/TIME (-/+).

6. Press SET to confirm the hour to switch on.

7. Set the minute to switch on by pressing TUNING/TIME (-/+).

8. Press SET to confirm the minute to switch on. 'OFF' indicator appears for about 0.5 seconds in the display window and then disappears.

9. Set the hour to switch off by pressing TUNING/TIME (-/+).

10. Press SET to confirm the hour to switch off.

11. Set the minute to switch off by pressing TUNING/TIME (-/+).

12. Press SET.

13. Adjust the volume level by pressing TUNING/TIME (-/+).

14. Press SET. "TIMER" appears in the display window and the timer setting has been completed.

15. Switch the system off. The selected function is automatically switched on and off at the time set.

### To cancel or check the timer

Each time the TIMER button is pressed you can select the timer set or cancel. You can also check the timer setting status.

To activate or check the timer, press the **TIMER** button so that "TIMER" appears in the display window.

To cancel the TIMER, press the **TIMER** button so that "TIMER" disappears in the display window.

## Presetting the Radio Stations

You can preset 30 stations for FM and AM. Before tuning, make sure that you have turned down the volume to the minimum.

1. Press TUNER/BAND to select the frequency (FM or AM) you want. Every time you press this button, FM and AM changes alternately.
2. Select a station you want by pressing TUNING/TIME (-/+) buttons.
 

Tuning in manually

  - Press TUNING/TIME (-/+) briefly and repeatedly.

Tuning in automatically

  - Press TUNING/TIME (-/+) for more than 1 seconds. Scanning stops when the unit tunes in a stations.
3. Press PROG./MEMORY on the front panel. A preset number will flash in the display window.
4. Press PRESET (- /+) [unit] or PRESET (∨/∧) [remote control] to select the preset number you want.
5. Press PROG./MEMORY again. The station is stored.
6. Repeat steps 1 (or 2) to 5 to store other stations.

### To delete all the memorized stations

Press and hold **PROG./MEMORY** on the front panel for about two seconds, "DEL" appears in the display window and then press **CLEAR** again, the stations are deleted.

### For your reference

If all stations have already been entered, FULL message will appear in the display window for a moment and then a preset number will flash. To change the preset number, follow the steps 4-5.

### To recall presets

Press and hold PRESET (- /+) [unit] or PRESET (∨/∧) [remote control] until the desired preset number appears or press it repeatedly.

## Listening to the Radio

1. Press TUNER/BAND to select the frequency (FM or AM) you want. Every time you press this button, FM and AM changes alternately. The last received station is tuned in.
2. Press PRESET (-/+) (or PRESET (∨/∧) on the remote control) repeatedly to select the preset station you want.
  - Each time you press the button, the unit tunes in one preset station at a time.
3. Adjust the volume by rotating VOLUME CONTROL KNOB (or pressing VOLUME (∨/∧) on the remote control) repeatedly.

### To listen to non-preset radio stations

- Use manual or automatic tuning in step 2.
- For automatic tuning, press and hold TUNING/TIME (-/+) on the front panel.

### To turn off the radio

Press POWER(STANDBY/ON) to turn the unit off or select another function mode (CD or TAPE).

### For your reference

- If an FM program is noisy
  - Press MODE/RIF so that "STEREO" disappears in the display window. There will be no stereo effect, but the reception will improve. Press MODE/RIF again to restore the stereo effect.
- When recording the MW(AM) broadcast, beat noises may occur. If it does, press MODE/RIF once.
  - "—" indicator lights up in the display window.
- Adjust the antenna to get more clear reception.
  - AM antenna
    - This antenna is built within the unit and rotate the unit for better reception.
  - FM antenna
    - Pull the telescopic antenna out and adjust the angle and direction for better reception.

## Tape Playback

Note: Use only normal tapes during playback.

### Basic Playback

1. Press TAPE to select tape function.  
("NO TAPE" appears in the display window.)
2. Open the cassette door by pushing TAPE DOOR (▲ PUSH EJECT) position.
3. Insert a cassette and close the TAPE.
4. Press TAPE PLAY (▶) [or TAPE REVERSE PLAY (◀); LPC-LM735A/X model only] button.

### To Stop Play

Press STOP(■) during playback.

### To Play Rewind or Fast Forward

After pressing ◀◀◀◀/▶▶▶▶ on the front panel or ◀◀/▶▶ on the remote control during playback, or stop, press PLAY(▶) at the point you want.

### Auto Stop Deck : LPC-LM730A/X model only

After auto stop deck plays only front side, the unit stops automatically.

### Auto Reverse Deck : LPC-LM735A/X model only

You can select direction of the cassette you want by pressing TAPE MODE.

Pressing	Display	Function
Once	⏮	After the cassette plays front or reverse (backward play) side, stops automatically.
Twice	⏪	After the cassette plays front and reverse side, stops automatically.
Three times	⏩	After the cassette plays six times repeatedly front and reverse side, stops automatically.

## Tape Recording

Wind the tape to the point recording starts.

Note: Use only normal tapes.

### Basic Recording

1. Select the function (CD or TUNER/ BAND) you want to record.
2. Open the cassette deck and insert a blank cassette into the cassette compartment.  
To set the recording direction (LPC-LM735A/X model only)  
Press TAPE MODE repeatedly to set the recording direction.

### Recording from Radio or CD

1. Press ●/|| on the front panel or the remote control and then select the CD or TUNER function.  
"●REC" flashes and holds the cassette in pause mode.
2. Press ●/|| or PLAY(▶) on the front panel or the remote control.  
The recording begins.

### To pause recording

Press ●/|| during recording.

- "●REC" flashes in display window.

### To stop recording

Press TAPE STOP(■).

### CD to Tape Synchronized Recording

The CD synchro recording function dubs a complete CD and programmed titles automatically into a cassette.

1. Press CD SYNC. in stop mode.  
"●REC" flashes and "CD SYNC" displays in the display window.
2. The synchronized recording is started automatically after about 8 seconds.

### Notes

- If you wish to record from the desired track, select the desired track with CD SKIP/SEARCH (◀◀◀◀/▶▶▶▶) before commencing CD synchro recording.
- The function change is not possible during recording.

## CD Playback

### Basic Playback

1. Press CD button to select CD function.
2. Press CD OPEN/CLOSE (▲ OPEN/ CLOSE) to open the disc compartment.
3. Load a disc with the printed side facing up and Close the disc compartment.
4. Press CD PLAY/PAUSE (▶/||) button to begin play.  
The total track number will be shown in the display.

### Pause Playback

Press CD PLAY/PAUSE (▶/||) button to pause during playback. Press CD PLAY/ PAUSE (▶/||) button again to resume play.

### Stop Playback

Press CD STOP (■ STOP or ■) button during playback.

### Skipping a Track

- Press CD SKIP/SEARCH (▶▶▶▶) button to go to the next track.
- When CD SKIP/SEARCH (◀◀◀◀) button is pressed once midway through a track, the player returns to the start of that track. When it is pressed again, a track is skipped each time the button is pressed.

### Searching a Track

After pressing and holding CD SKIP/ SEARCH (◀◀◀◀/▶▶▶▶) button during playback, then release at the point you want.

### Notes

This function is not available to play a MP3 file.

### Repeat

To play one track repeatedly  
Press REPEAT button once during playback.  
- "REPEAT 1" appears in the display.

To play all tracks repeatedly  
Press REPEAT button again during playback.  
- "REPEAT ALL" appears in the display.

To cancel repeat play  
Press REPEAT button once more during playback.  
- Repeat indicator disappears.

## Program Play

You can arrange the order of the tracks on the discs and create your own program.  
The program can contain up to 20 tracks.

### Program Play (Audio CD)

1. Press PROG./MEMORY (or PROGRAM on the remote control) on the stop mode.
2. Press CD SKIP/SEARCH (◀◀◀◀/ ▶▶▶▶) buttons to select the track.
3. Press PROG./MEMORY (or PROGRAM on the remote control).
4. Repeat 2~3.
5. Press CD PLAY/ PAUSE (▶/||).

### Program Play (MP3 File)

1. Press PROG./MEMORY (or PROGRAM on the remote control) on the stop mode.
2. Press CD SKIP/SEARCH (◀◀◀◀/ ▶▶▶▶) buttons to select a file.  
EX) "04 P-01" will be shown in the display.
3. Press third PROG./MEMORY (or PROGRAM on the remote control).
4. Repeat 2~3.
5. Press CD PLAY/ PAUSE (▶/||).

### To check program contents

Press PROG./MEMORY (or PROGRAM on the remote control) on the stop mode.  
- Track and program number will be displayed.

### To clear program contents

Press PROG./MEMORY (or PROGRAM on the remote control) on the stop mode. And then press CLEAR on the front panel or CD STOP(■) on the remote control.

### To add program contents

1. Press PROG./MEMORY (or PROGRAM on the remote control) repeatedly on the program stop mode until "Track Number" blinks.
2. Repeat 2~5 on above.

### To modify program contents

1. Press the PROG./MEMORY (or PROGRAM on the remote control) to display program number you want to modify.
2. Repeat 2~4 on above.

## 4 Maintenance and Service

### Shipping the Unit

The original shipping carton and packing materials can come in handy. For maximum protection, re-pack the unit as it was originally packed at the factory if you need to ship it.

### Cleaning the Unit

Use a soft, dry cloth when cleaning the player. If the surfaces are extremely dirty, use a soft cloth lightly moistened with a mild detergent solution.

Never use strong solvents, such as alcohol, benzene, or paint thinner. These might damage the surface of the unit.

Do not use volatile liquids, such as insecticide spray, near the unit. Do not leave rubber or plastic products in contact with the unit for a long period of time. They will leave marks on the surface.

### Cleaning discs

Fingerprints and dust on the disc can cause poor picture quality and sound distortion. Before playing, clean the disc with a clean cloth. Wipe the disc from the center out.

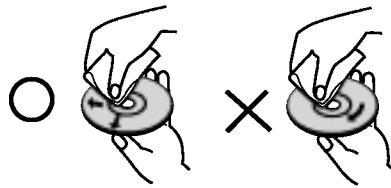

Do not use strong solvents such as alcohol, benzene, thinner, commercially available cleaners, or anti-static spray intended for older vinyl records.

### Troubleshooting

Symptom	Cause	Correction
No power.	<ul style="list-style-type: none"> <li>The power cord is disconnected.</li> </ul>	<ul style="list-style-type: none"> <li>Plug the power cord into the wall outlet securely.</li> </ul>
No sound.	<ul style="list-style-type: none"> <li>The power of the external source equipment is switched off.</li> </ul>	<ul style="list-style-type: none"> <li>Switch on the external source equipment.</li> </ul>
The unit does not start playback.	<ul style="list-style-type: none"> <li>No disc or tape is inserted.</li> </ul>	<ul style="list-style-type: none"> <li>Insert a disc or tape.</li> </ul>
	<ul style="list-style-type: none"> <li>An unplayable disc or tape is inserted.</li> </ul>	<ul style="list-style-type: none"> <li>Insert a playable disc or tape.</li> </ul>
	<ul style="list-style-type: none"> <li>The disc is placed upside down.</li> </ul>	<ul style="list-style-type: none"> <li>Place the disc with the playback side down.</li> </ul>
	<ul style="list-style-type: none"> <li>The disc is not placed within the guide.</li> </ul>	<ul style="list-style-type: none"> <li>Place the disc on the disc tray correctly inside the guide.</li> </ul>
The remote control does not work properly.	<ul style="list-style-type: none"> <li>The disc is dirty.</li> </ul>	<ul style="list-style-type: none"> <li>Clean the disc.</li> </ul>
	<ul style="list-style-type: none"> <li>The remote control is not pointed at the remote sensor of the unit.</li> </ul>	<ul style="list-style-type: none"> <li>Point the remote control at the remote sensor of the unit.</li> </ul>
	<ul style="list-style-type: none"> <li>The remote control is too far from the unit.</li> </ul>	<ul style="list-style-type: none"> <li>Operate the remote control within about 23 ft (7 m).</li> </ul>
	<ul style="list-style-type: none"> <li>There is an obstacle in the path of the remote control and the unit.</li> </ul>	<ul style="list-style-type: none"> <li>Remove the obstacle.</li> </ul>
	<ul style="list-style-type: none"> <li>The batteries in the remote control are exhausted.</li> </ul>	<ul style="list-style-type: none"> <li>Replace the batteries with new ones.</li> </ul>

## 5 Reference

### Remote Control Operation Range

Point the remote control at the remote sensor and press the buttons.

Distance: About 23 ft (7 m) from the front of the remote sensor.

Angle: About 30° in each direction of the front of the remote sensor.

### Specifications

SECTION		MODEL	LPC-LM730A/X LPC-LM735A/X
[General]	Power supply	Refer to the back panel of the unit.	
	Power consumption	30W	
	Mass	2.75kg	
	External dimensions (W x H x D)	550 x 290 x 220 mm	
	Output Power	7.5W X 2	
	Speakers	8Ω X 2	
	Battery Operation	DC 12V, eight "D"(R20) batteries (not supplied)	
[CD]	Frequency response	100 - 18000 Hz	
	Signal-to-noise ratio	59 dB	
	T.H.D	0.7 %	
[Tuner]	FM	Tuning Range	65 -74 MHz, 87.5 -108 MHz or 87.5 -108 MHz
		Intermediate Frequency	10.7 MHz
		Antenna	Telescopic antenna
	AM (MW)	Tuning Range	522 - 1611 kHz or 530 - 1610 kHz
		Intermediate Frequency	450 kHz
		Antenna	Ferrite bar antenna
[TAPE]	Recording System	4 Tracks 2 channel stereo	
	Frequency Response	125 - 8000Hz	
	Signal to Noise Ratio	40/45dB (REC/PLAY)	

\* Designs and specifications are subject to change without notice.



P/NO : 3834RC0028D