



# PLASMA MONITOR OWNER'S MANUAL

Please read this manual carefully before operating your set.  
Retain it for future reference.  
Record model number and serial number of the set.  
See the label attached on the back cover and quote this information to your dealer when you require service.

Model number :  
Serial number :

P/NO : 3828VA0513F (RF04GA, 138D TX, 026H)

# Safety Instructions

- Use the set at the place lower than the altitude of 6562 feet (2000m) to get the best quality of picture and sound.

## WARNING

**Do not place the set in direct sunlight or near heat sources such as heat registers, stove and so on.**

- This may cause a fire.

**Do not use the set in damp place such as a bathroom or any place where it is likely to get wet.**

- This may cause a fire or could give an electric shock.

**Bend antenna cable between inside and outside building to prevent rain from flowing in.**

- This may cause water damaged inside the set and could give an electric shock.

**Earth wire should be connected.**

- If the earth wire is not connected, there is possible a danger of electric shock caused by the current leakage.
- If grounding methods are not possible, a separate circuit breaker should be employed and installed by a qualified electrician.

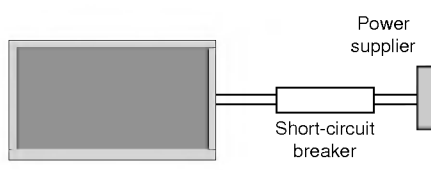

- Do not connect ground to telephone wires, lightning rods or gas pipe.

**Do not place anything containing liquid on top of the set.**

- This may cause a fire or could give an electric shock.

**Do not insert any object into the exhaust vent.**

- This may cause a fire or could give an electric shock.

**Do not place heavy objects on the set.**

- This may cause serious injury to a child or adult.

## WARNING in U.K. only

- \* This set is supplied with a BS 1363 approved 13 amp mains plug, fused at 13 amp. When replacing the fuse always use a 13 amp BS 1362, BSI or ASTA approved type. Never use this plug with the fuse cover omitted. To obtain a replacement fuse cover contact your dealer or "LG Electronics U.K. Ltd." If the type of plug supplied is not suitable for the mains sockets in your home, then the plug should be removed and a suitable type fitted. A mains plug removed from the mains lead of this set must be destroyed. A mains plug with bared wires is hazardous if inserted in a mains socket. Do not connect either wire to the earth pin, marked with the letter E or with the earth symbol  or coloured green or green and yellow. If any other plug is fitted, use a 13 amp fuse, either in the plug, or at the distribution board. The wires in this mains lead are coloured in accordance with the following codes: BLUE: NEUTRAL, BROWN: LIVE. As the colours of the wires in the mains lead of this set may not correspond with the coloured marking identifying the terminals in your plug, proceed as follows: The wire which is coloured blue must be connected to the terminal which is marked with the letter N or coloured black. The wire which is coloured brown must be connected to the terminal which is marked with the letter L or coloured red.

\* Safety instructions have two kinds of information, and each meaning of it is as below.

**⚠ WARNING** The violation of this instruction may cause serious injuries and even death.

**⚠ NOTES** The violation of this instruction may cause light injuries or damage of the product.

**⚠** Take care of danger that may happen under specific condition.

## ⚠ NOTES

**Never touch the power plug with a wet hand.**

- This may cause an electric shock.

**Disconnect from the mains and remove all connections before moving.**

**Do not place the set in a built-in installation such as a bookcase or rack.**

- Ventilation required.

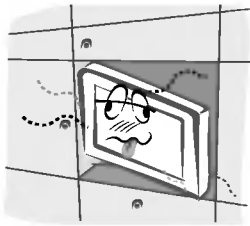

**When installing the set on a table, be careful not to place the edge of its stand.**

- This may cause the set to fall, causing serious injury to a child or adult, and serious damage to the set.

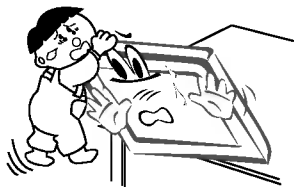

**Do not place an outside antenna in the vicinity of overhead power lines or other electric light or power circuits.**

- This may cause an electric shock.

**There should be enough distance between an outside antenna and power lines to keep the former from touching the latter even when the antenna falls.**

- This may cause an electric shock.

**Do not pull the cord but the plug when unplugging.**

- This may cause a fire.

**Ensure the power cord doesn't trail across any hot objects like a heater.**

- This may cause a fire or an electric shock.

**Do not plug when the power cord or the plug is damaged or the connecting part of the power outlet is loose.**

- This may cause a fire or an electric shock.

**Dispose of used batteries carefully to protect a child from eating them.**

- In case that it eats them, take it to see a doctor immediately.

**When moving the set assembled with speakers do not carry holding the speakers.**

- This may cause the set to fall, causing serious injury to a child or adult, and serious damage to the Monitor.

**Unplug this product from the wall outlet before cleaning. Do not use liquid cleaners or aerosol cleaners.**

- This may cause damaged the set or could give an electric shock.

**Contact the service center once a year to clean the internal part of the set.**

- Accumulated dust can cause mechanical failure.

**The distance between eyes and the screen should be about 5 ~ 7 times as long as diagonal length of the screen.**

- If not, eyes will strain.

**Unplug the set from the wall outlet when it is left unattended and unused for long periods of time.**

- Accumulated dust may cause a fire or an electric shock from deterioration or electric leakage.

# Contents

<b>Safety Warnings</b>	
Safety Instructions	2~3
<b>Introduction</b>	
Remote Control Key Functions	6
Location and Function of Controls	7~9
<b>Installation</b>	
External Equipment Viewing Setups	10~11
Displayable Monitor Specification	12
Accessories	13
Installation Options	14
<b>Operation</b>	
Turning on the Set	15
On-Screen Menu Language Selection (option)	15
<b>Picture Menu Options</b>	
PSM (Picture Status Memory)	16
<b>XD</b>	16
Adjusting Auto Colour Control	16
Manual Colour Temperature Control (User option)	16
sRGB (RGB[PC], DVI[PC] mode only)	17
Flesh tone	17
Manual Picture Control (User option)	17
<b>Sound Menu Options</b>	
SSM (Sound Status Memory)	18
BBE	18
AVL (Auto Volume Leveler)	18
Adjusting Sound Control (User option)	18
<b>Time Menu Options</b>	
Setting the Clock	19
Setting the On/Off Timer	19
Auto Sleep	19
Sleep Timer	19
<b>Special Menu Options</b>	
Child Lock	20
ISM (Image Sticking Minimization) Method	20
Low Power	21
<b>XD</b> Demo	21
Menu Rotation for Vertical Viewing	21
<b>Screen Menu Options</b>	
Auto adjustment (RGB [PC] mode only)	22
Setting Picture Format	22
Screen Position	22
Manual Configure (RGB [PC] mode only)	23
Selecting Wide VGA/XGA mode (RGB[PC] mode only)	23
Screen Adjustments	23
Cinema	23
Luminance Noise Reduction (option)	24
Initializing (Reset to original factory value)	24
Split Zoom	24
<b>PIP (Picture In Picture) Feature</b>	
Watching PIP	25
Selecting an Input Signal Source for the PIP	25
Moving the PIP (PIP mode only)	25
Picture Size	25
Adjusting PIP Transparency (PIP mode only)	25
<b>Miscellaneous</b>	
External Control Device Setup	26~31
IR Code (NEC format)	32~33
Troubleshooting Checklist	34
Product Specifications	35

After reading this manual, keep it in the place where the user can always contact easily.

# Introduction

## What is a Plasma Display ?

If voltage is inputted to gas in glass panels, ultraviolet rays is outputted and fused with a fluorescent substance. At this moment, light is emitted. A Plasma Display is a next generation flat Display using this phenomenon.

## 160° - Wide angle range of vision

A Plasma Display provides more than 160° angle range of vision so that you can get a picture without distortion from any direction.

## Easy installation

A Plasma Display is much lighter and smaller than other same class products so that you can install the Plasma Display at the desired place.

## Big screen

The screen of a Plasma Display is 42" (or 50") so that you can get vivid experience as if you are in a theater.

## Multimedia Plasma Display

A Plasma Display can be connected with a computer so that you can use it as a screen for conference, game, internet and so on.

## The explanation about coloured dots may be present on PDP screen

The PDP which is the display device of this product is composed of 0.9 to 2.2 million cells and a few cell defects can occur in the manufacture of the PDP. Several coloured dots visible on the screen would be acceptable, in line with other PDP manufacturers and would not mean that the PDP is faulty. We hope you will understand that the product which corresponds to this standard is regarded as acceptable. It means that it could not be changed or refunded. We promise that we'll do our best to develop our technology to minimize the cell defects.

## The explanation about noise of 42" (or 50") PDP

In the same way that a fan is used in a PC to keep the CPU cool, the PDP is equipped with cooling fans to improve the reliability of this product. Therefore, a certain level of noise could occur when the fan is operated. This noise doesn't have any negative effect on its efficiency and liability and it's also determined to have no difficulty while using this product. The noise from the fans is normal in the operation of this product. We hope you will understand that a certain level of noise is acceptable. It means that it is not changeable nor refundable.

### **WARNING**

This is Class A product. In a domestic environment this product may cause radio interference in which case the user may be required to take adequate measures.

### **WARNING**

TO REDUCE THE RISK OF FIRE AND ELECTRIC SHOCK, DO NOT EXPOSE THIS PRODUCT TO RAIN OR MOISTURE.

# Remote Control Key Functions

- When using the remote control aim it at the remote control sensor of the set.
- There's maybe a defect in consecutive operation of remote control in specified brightness according to this set feature.

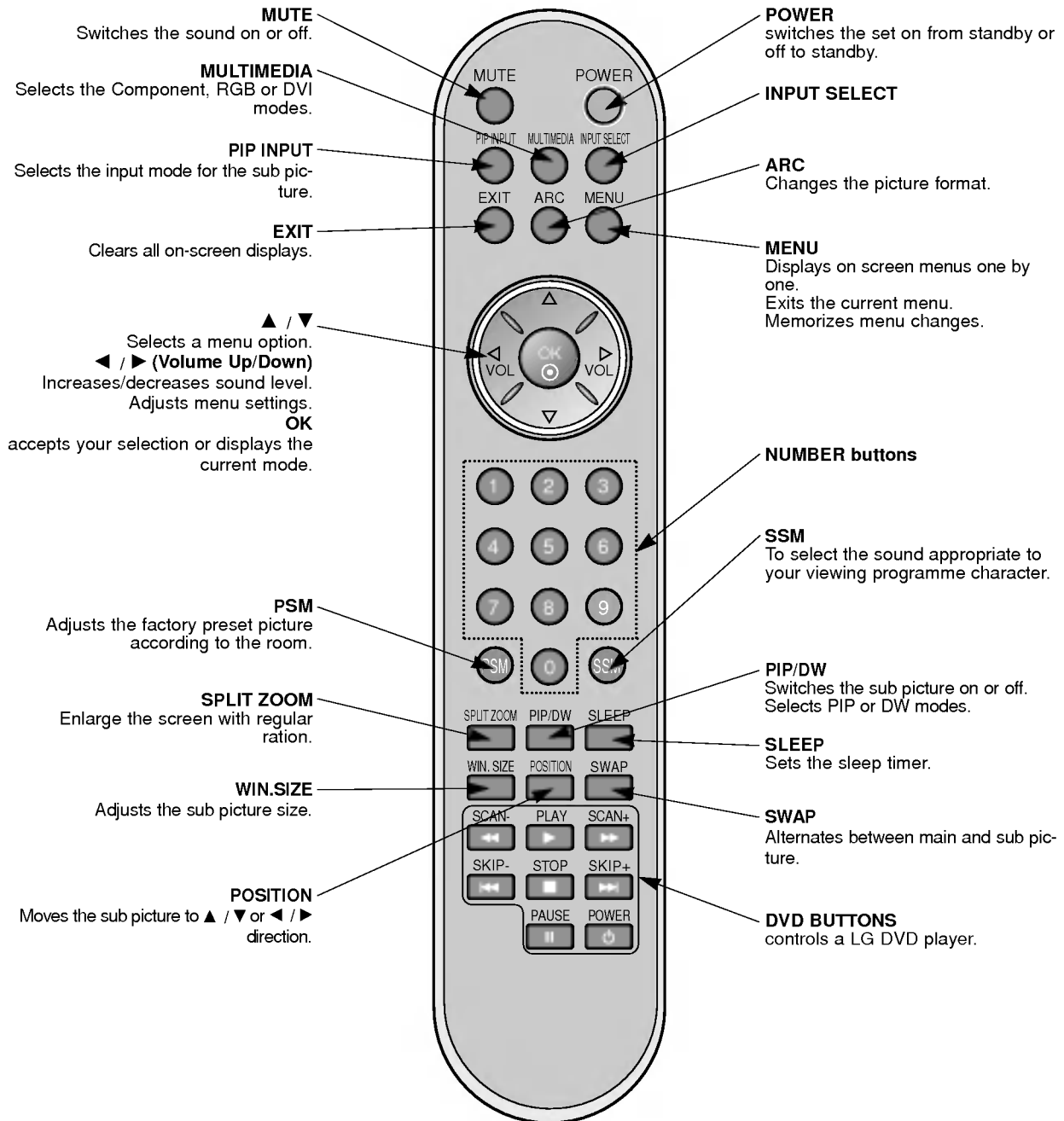

## Installing Batteries

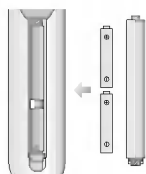

- Open the battery compartment cover on the back side and insert the batteries with correct polarity.
- Install two 1.5V alkaline batteries of AAA type. Don't mix used batteries with new batteries.

# Location and Function of Controls

- Shown is a simplified representation of the set.
- Here shown may be somewhat different from your set.

## <Front Panel Controls>

### MZ-42/50PM10 series

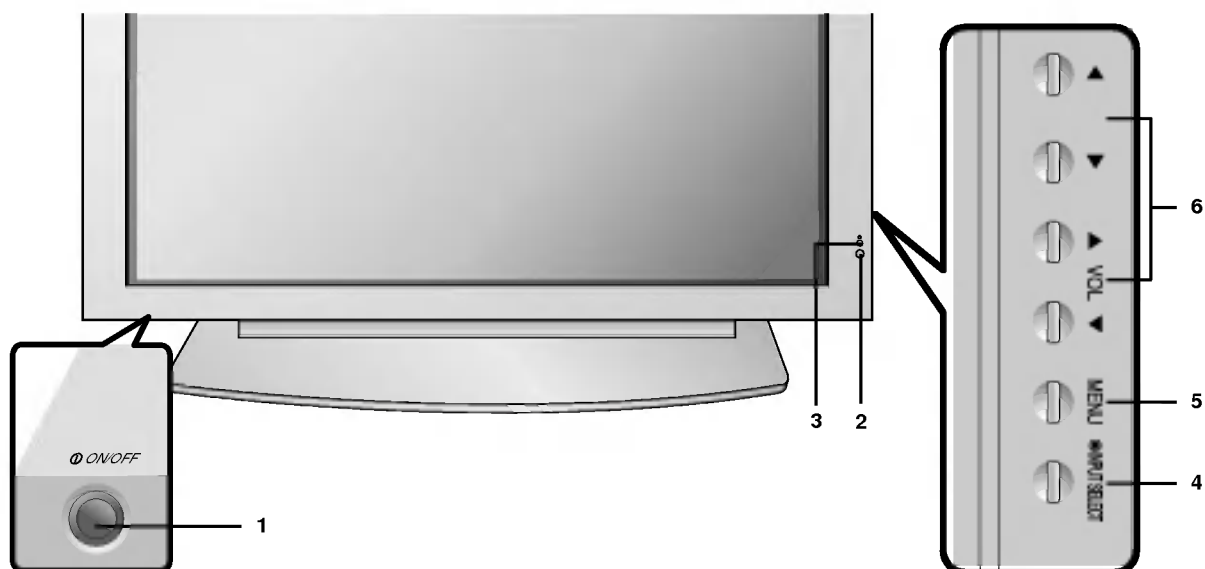

### MZ-42/50PM20 series

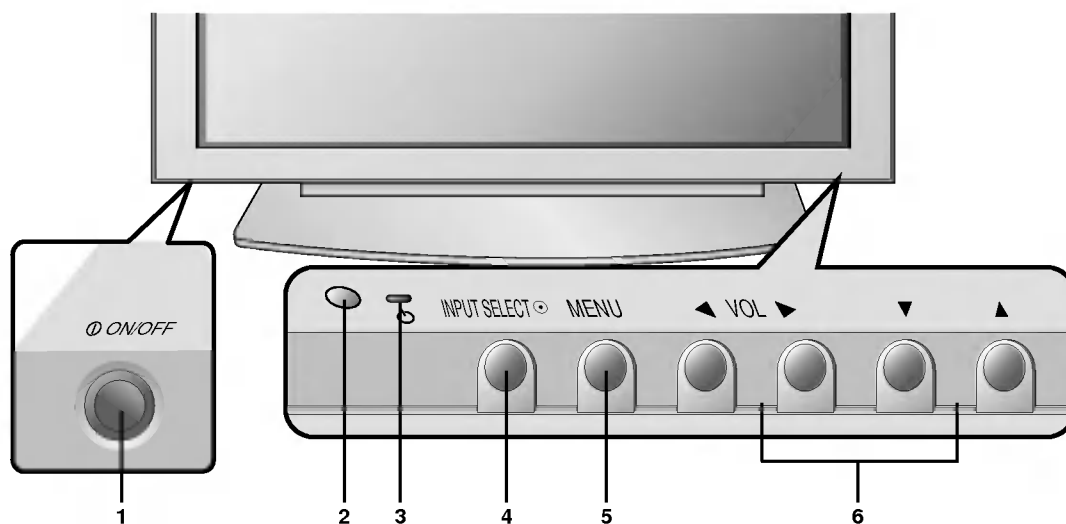

#### 1. Main Power Button

#### 2. Remote Control Sensor

#### 3. Power Standby Indicator

Illuminates red in standby mode, Illuminates green when the set is turned on

#### 4. INPUT SELECT Button

#### 5. MENU

Displays on screen menus one by one.  
Exits the current menu.  
Memorizes menu changes.

#### 6. ▲ / ▼

Selects a menu option.

#### ◀ / ▶ (Volume Up/Down)

Increases/decreases sound level.  
Adjusts menu settings.





## &lt;Back Panel&gt;

## RCA Type

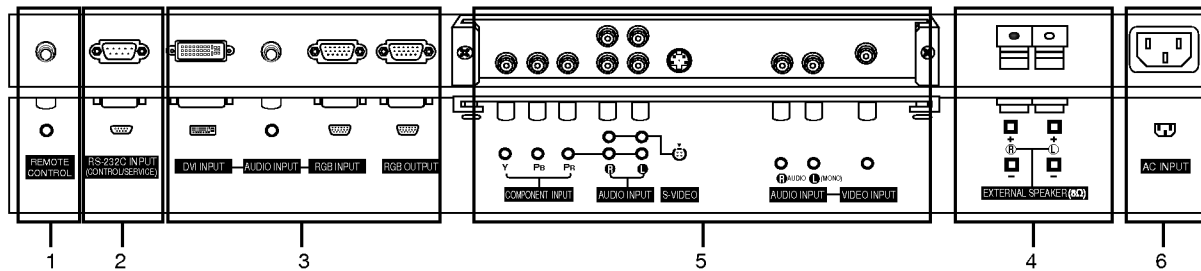

## Scart Type

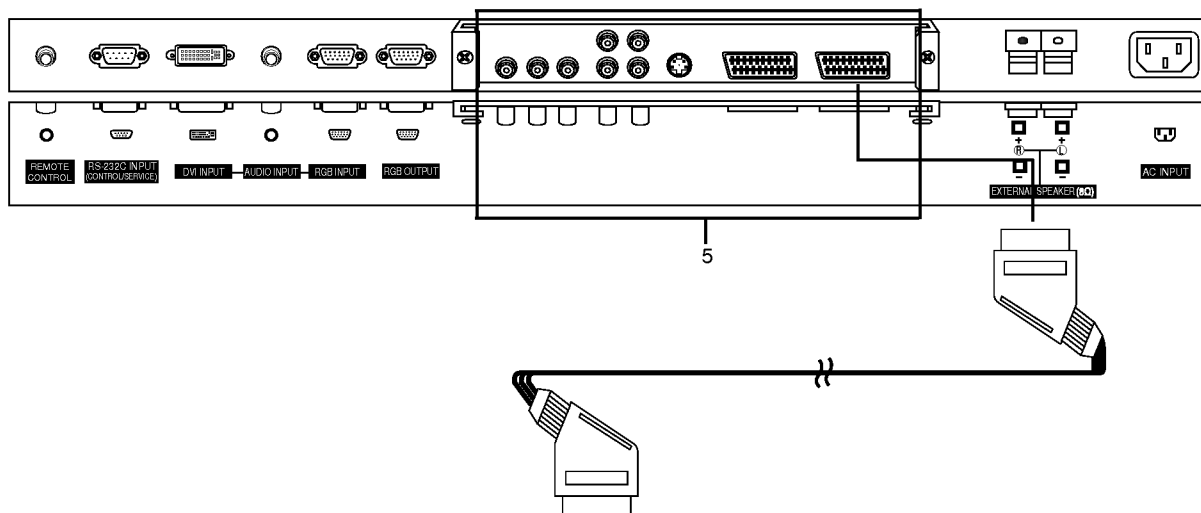
**1. CONTROL LOCK / REMOTE CONTROL**

- 2. RS-232C INPUT(CONTROL/SERVICE) PORT**  
Connect to the RS-232C port on a PC.

- 3. DVI INPUT / AUDIO INPUT / RGB INPUT SOCKETS**  
Connect the monitor output socket of the PERSONAL COMPUTER to this socket.

**RGB OUTPUT SOCKET**

You can watch the RGB signal on another monitor, connect RGB OUTPUT to another monitor's PC input port.

**4. EXTERNAL SPEAKER OUTPUT (8 ohm)**

Connect to optional external speaker(s).  
\*For further information, refer to 'Speaker & Speaker Stand' manual.

- 5. COMPONENT / AUDIO INPUT SOCKETS**  
**S-VIDEO / AUDIO (L/MONO) INPUT SOCKETS**  
**VIDEO / AUDIO (L/MONO) INPUT SOCKETS**

**EURO SCART SOCKET**

**Note:** If you want to use your external hi-fi stereo system, turn off the internal speakers of the set.

**6. POWER CORD SOCKET**

This Monitor operates on an AC power. The voltage is indicated on the Specifications page. Never attempt to operate the Monitor on DC power.

# External Equipment Viewing Setups

## Watching VCR (When the Interface board is installed.)

- When connecting the Plasma Monitor with external equipments, match the colours of connecting ports (Video - yellow, Audio(L) - white, Audio(R) -red).
- Connect the VIDEO INPUT socket(yellow) with the BNC-RCA adapter to the VIDEO INPUT socket of the set.
- If you have a mono VCR, connect the audio cable from the VCR to the AUDIO(L/MONO) input of the Plasma Monitor.
- If you connect an S-VIDEO VCR to the S-VIDEO input, the picture quality is improved; compared to connecting a regular VCR to the Video input.
- Or, connect the Euro scart socket of the VCR to the Euro scart socket of the set.

Avoid having a fixed image remain on the screen for a long period of time. Typically a frozen still picture from a VCR, 4:3 picture format or if a CH label is present; the fixed image may remain visible on the screen. Use the orbiter function to avoid having a fixed image. (Refer to p.20)

1. Press **INPUT SELECT** button on the remote control and select **AV** or (**AV1** or **AV2**).  
(When connecting with S-Video, select the **S-Video**.)
2. Insert a video tape into the VCR and press the **PLAY** button on the VCR. (See VCR owner's manual)

## Watching Cable TV (When the Interface board is installed.)

- After subscribing to a cable TV service from a local provider and installing a converter, you can watch cable TV programming. This monitor cannot display TV programming without a TV tuner device or cable TV converter box connected to the monitor.

1. Press **INPUT SELECT** button on the remote control and select **AV** or (**AV1** or **AV2**).
2. Tune to cable service provided channels using the cable box.

## Watching external AV source (When the Interface board is installed.)

- When connecting the Plasma Monitor with external equipments, match the colours of connecting ports.
- Or, connect the Euro scart socket of the VCR to the Euro scart socket of the set.

1. Press **INPUT SELECT** button on the remote control of the monitor to select **AV** or (**AV1** or **AV2**).
2. Operate the corresponding external equipment. (See external equipment operating guide.)

## Watching DVD (When the Interface board is installed.)

### How to connect

- Connect DVD video inputs to Y, P<sub>B</sub>, P<sub>R</sub> of COMPONENT (DVD INPUT) and audio inputs to Audio sockets of AUDIO INPUT.
- Or, connect the Euro scart socket of the VCR to the Euro scart socket of the set.

### How to use

1. Press **INPUT SELECT** button on the remote control of the monitor to select **Component** or (**AV1** or **AV2**).
2. Try this after turning on the DVD player.  
(Refer to the DVD player's manual for operating instructions.)

### • Component Input ports

You can get better picture quality if you connect DVD player with component input ports as below.

Component ports of the Monitor	Y	P <sub>B</sub>	P <sub>R</sub>
Video output ports of DVD player	Y	P <sub>B</sub>	P <sub>R</sub>
	Y	B-Y	R-Y
	Y	Cb	Cr
	Y	P <sub>B</sub>	P <sub>R</sub>

### Connecting PC

- To enjoy vivid picture and sound, connect a PC to the set.
- Avoid keeping a fixed image on the set's screen for a long period of time. The fixed image may become permanently imprinted on the screen; use a screen saver when possible.
- Connect PC to the RGB INPUT(PC INPUT) or DVI INPUT(DIGITAL RGB INPUT) port of the set; change the resolution output of PC accordingly.
- There might be a noise according to some resolution, vertical pattern, contrast or brightness in PC mode. Then change the PC mode into other resolution or change the refresh rate into other rate or adjust the brightness and contrast on the menu until the picture is clean. If the refresh rate of the PC graphic card can not be changed, change the PC graphic card or consult it to the manufacturer of the PC graphic card.
- The synchronization input form for Horizontal and Vertical frequencies is separate.

### Setup Instructions to Connect a PC to your set

- We recommend using 640x480, 60Hz for the PC mode, they provide the best picture quality.
- If the resolution of PC is over UXGA, there will be no picture on the set.
- Connect the signal cable from the monitor output port of the PC to the RGB INPUT port of the set or the signal cable from the DVI output port of the PC to the DVI INPUT port on the set.
- Connect the audio cable from the PC to the Audio input on the set. (Audio cables are not included with the set).
- If using a sound card, adjust PC sound as required.
- This set apply a VESA Plug and Play Solution. The set provides EDID data to the PC system with a DDC protocol. The PC adjusts automatically to use this set.
- DDC protocol is preset for RGB (Analog RGB), DVI (Digital RGB) mode.
- If required, adjust the set settings for Plug and Play functionally.
- If graphic card on the PC does not output analog and digital RGB simultaneously, connect only one of both RGB INPUT or DVI INPUT to display the PC on the set.  
If graphic card on the PC does output analog and digital RGB simultaneously, set the set to either RGB or DVI; (the other mode is set to Plug and Play automatically by the set.)
- DOS mode may not work depending on video card if using a DVI-I cable.

### PC Setup

1. Turn on the PC and apply power to the set.
2. Turn on the display by pressing the **POWER** button on the set's remote control.
3. Use the **INPUT SELECT** or **MULTIMEDIA** button on the remote control to select the **RGB** or **DVI** input source.
4. Set the resolution output of the PC to SXGA or under (1280 x 1024, 60Hz). (Refer to p. 12)

# Displayable Monitor Specification

RGB / DVI mode

Resolution	Horizontal Frequency(KHz)	Vertical Frequency(Hz)
640x350	31.468	70.09
	37.861	85.08
720x400	31.469	70.08
	37.927	85.03
640x480	31.469	59.94
	35.000	66.66
	37.861	72.80
	37.500	75.00
848x480	43.269	85.00
	31.500	60.00
852x480	37.799	70.00
	39.375	75.00
800x600	31.500	60.00
	37.799	70.00
	39.375	75.00
	35.156	56.25
832x624	37.879	60.31
	48.077	72.18
	46.875	75.00
	53.674	85.06
1024x768	49.725	74.55
	48.363	60.00
	56.476	70.06
	60.023	75.02
1152x864 (RGB)	68.677	85.00
	54.348	60.05
	63.995	70.01
	67.500	75.00
1152x870 (RGB)	77.487	85.00
1280x960 (RGB)	68.681	75.06
1280x1024 (RGB)	60.023	60.02
	63.981	60.02

**MZ-42PM10/12X/20 series**

RGB / DVI mode

Resolution	Horizontal Frequency(KHz)	Vertical Frequency(Hz)
640x350	31.468	70.09
	37.861	85.08
720x400	31.469	70.08
	37.927	85.03
640x480	31.469	59.94
	35.000	66.66
	37.861	72.80
	37.500	75.00
848x480	43.269	85.00
	31.500	60.00
852x480	37.799	70.00
	39.375	75.00
800x600	31.500	60.00
	37.799	70.00
	39.375	75.00
	35.156	56.25 (RGB)
832x624	37.879	60.31
	48.077	72.18
	46.875	75.00
	53.674	85.06
1024x768	49.725	74.55
	48.363	60.00
	56.476	70.06
	60.023	75.02
1360x768	68.677	85.00
	47.700	60.00
	59.625	75.02
	68.500	85.00
1366x768	47.700	60.00
	59.625	75.02
1152x864	69.500	85.00
	54.348	60.05
	63.995	70.01
	67.500	75.00
1152x870	77.487	85.00
1280x960 (RGB)	68.681	75.06
1280x1024 (RGB)	60.023	60.02
	63.981	60.02

**MZ-50PM10/20 series**

# Accessories

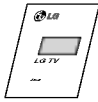

Owner's Manual

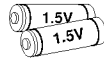

Alkaline batteries



Remote Control handset



Power Cord



BNC-RCA adapter  
(optional)

## Optional Extras

- Optional extras can be changed or modified for quality improvement without any notification new optional extras can be added.
- Contact your dealer for buying these items.



Tilt wall mounting bracket

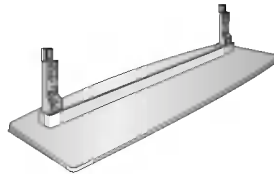

Desktop stand



Ceiling mounting bracket



Speakers



Video cables



Audio cables

# Installation Options

- The set can be installed in different ways such as on a wall, or on a desktop etc.
- Install this set only in a location where adequate ventilation is available.
- This set is designed so that it can be mounted either horizontally or vertically.

## Wall Mount: Horizontal Installation



- The set can be installed on a wall as shown above. (For further information, refer to the optional 'Wall Mounting Bracket Installation and Setup Guide'.)
- Speakers are optional, and are shown for illustration only.

## Desktop Pedestal Installation

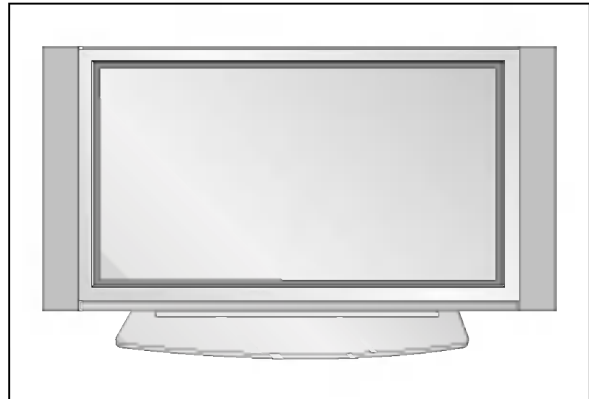

- The set can be mounted on a desk as shown above. (For further information, refer to the optional 'Desktop Stand Installation and Setup Guide'.)
- Speakers and speaker stands shown are optional, and are shown for example only.

### To Mount on a Wall

Wall mount minimum allowable clearances for adequate ventilation.

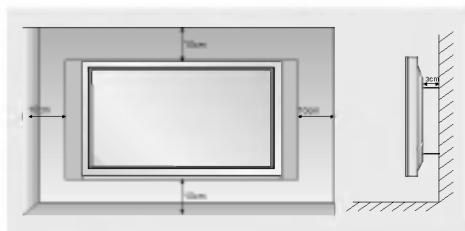

### To Install on a Desktop

Pedestal mount minimum allowable clearances for adequate ventilation.

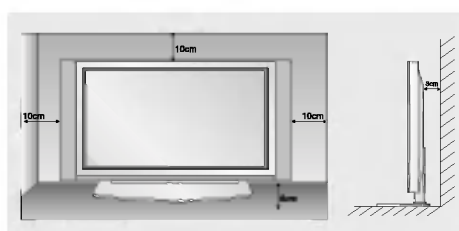

## Turning on the Set

- When using the remote control, aim it at its sensor on the set.

### Turning on the set just after installation

1. Connect power cord correctly.
2. Press the **⓪ ON/OFF** button on the set. At this moment, the set is switched to standby mode. Press the **INPUT SELECT** button on the set or press the **POWER**, **INPUT SELECT** or **MULTIMEDIA** button on the remote control and then the set will switch on.

### Turning on the set (power cord is still connected)

1. If the set was turned off with the **⓪ ON/OFF** button on the set
  - Press the **⓪ ON/OFF** button on the set to turn the set on.
2. If the set was turned off with the remote control and the **⓪ ON/OFF** button on the set
  - Press the **⓪ ON/OFF** button on the set and then press the **INPUT SELECT** button on the set or press the **POWER**, **INPUT SELECT** or **MULTIMEDIA** button on the remote control to turn the set on.

## On-Screen Menu Language Selection (option)

- The menus can be shown on the screen in the selected language. First select your language.
  1. Press the **MENU** button and then use **▲ / ▼** button to select the **SPECIAL** menu.
  2. Press the **▶** button and then use **▲ / ▼** button to select **Language**.
  3. Press the **▶** button and then use **▲ / ▼** button to select your desired language.  
From this point on, the on-screen menus will be shown in the language of your choice.
  4. Press the **EXIT** button to return to normal viewing.

# Picture Menu Options

## PSM (Picture Status Memory)

- This function adjusts the set to the best picture appearance.
- When adjusting picture options (contrast, brightness, colour, sharpness and tint (NTSC input only)) manually, PSM is automatically changed to **User**.

1. Press the **PSM** button

- Each press of the **PSM** button changes the screen display as shown below.

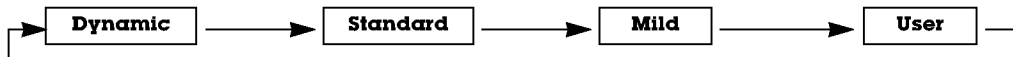

- You can also select **Dynamic**, **Standard**, **Mild** or **User** in the PICTURE menu.
- Picture options **Dynamic**, **Standard** and **Mild** are preset and programmed for good picture quality at the factory and cannot be changed.

## XD

- You can enjoy the vivid and hi-definition picture with LG's excellent Digital Reality processor technology.
- When selecting picture options (**Dynamic**, **Standard** and **Mild**) in PICTURE menu, **XD** is automatically changed to **On**.

1. Press the **MENU** button and then use **▲ / ▼** button to select the PICTURE menu.
2. Press the **▶** button and then use **▲ / ▼** button to select **XD**.
3. Press the **▶** button and then use **▲ / ▼** button to select **On** or **Off**.
4. Press the **EXIT** button to return to normal viewing.



## Adjusting Auto Colour Control

- To initialize values (reset to default settings), select the **Normal** option.

1. Press the **MENU** button and then use **▲ / ▼** button to select the PICTURE menu.
2. Press the **▶** button and then use **▲ / ▼** button to select **CSM**.
3. Press the **▶** button and then use **▲ / ▼** button to select the desired colour temperature.
4. Press the **EXIT** button to return to normal viewing.

- Each press of **▲ / ▼** button changes the screen display as shown below.

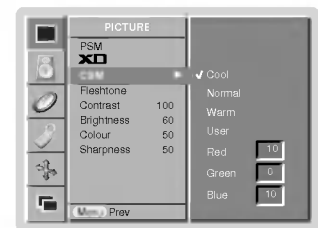
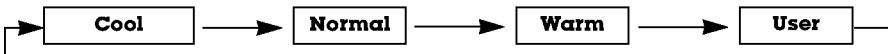

## Manual Colour Temperature Control (User option)

- You can adjust red, green, or blue to any colour temperature you prefer.

1. Press the **MENU** button and then use **▲ / ▼** button to select the PICTURE menu.
2. Press the **▶** button and then use **▲ / ▼** button to select **CSM**.
3. Press the **▶** button and then use **▲ / ▼** button to select **User**.
4. Press the **▶** button and then use **▲ / ▼ / ◀ / ▶** button to make appropriate adjustments.
  - The adjustment range of **Red**, **Green** and **Blue** is -30~+30.
5. Press the **EXIT** button to return to normal viewing.

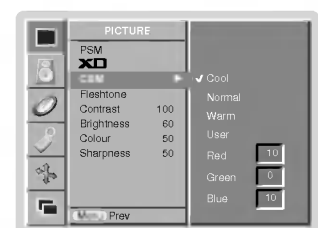



**sRGB (RGB[PC], DVI[PC] mode only)**

- When the set was connected to external equipment with sRGB function, It's adjusted a colour difference to display the equal image each other.

1. Press the **MENU** button and then use ▲ / ▼ button to select the PICTURE menu.
2. Press the ► button and then use ▲ / ▼ button to select **sRGB**.
3. Press the ► button and then use ▲ / ▼ button to select **On** or **Off**.
4. Press the **EXIT** button to return to normal viewing.

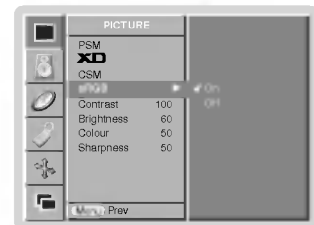
**Fleshtone**

- Adjust the **Fleshtone** to select the desired skin colour option.
- This function works in the following mode:  
AV (or AV1, AV2), COMPONENT 480i/480p/576i/576p/720p/1080i.

1. Press the **MENU** button and then use ▲ / ▼ button to select the PICTURE menu.
2. Press the ► button and then use ▲ / ▼ button to select **Fleshtone**.
3. Press the ► button and then use ◀ / ▶ button to make appropriate adjustments.
  - The adjustment range of **Fleshtone** is 0 ~ 3.
4. Press the **EXIT** button to return to normal viewing.

**Manual Picture Control (User option)**

- You can adjust picture contrast, brightness, colour, sharpness and tint (NTSC input only) to the levels you prefer.
- In the broadcasting system PAL/SECAM, the picture item Tint doesn't work.

1. Press the **MENU** button and then use ▲ / ▼ button to select the PICTURE menu.
2. Press the ► button and then use ▲ / ▼ button to select the desired picture option.
3. Press the ► button and then use ◀ / ▶ button to make appropriate adjustments.
4. Press the **EXIT** button to return to normal viewing.

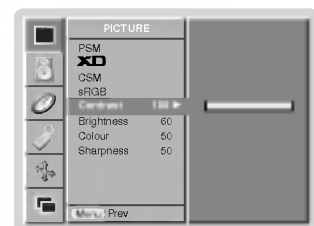

# Sound Menu Options

## SSM (Sound Status Memory)

- This function lets you enjoy the best sound without any special adjustment because the set automatically selects the appropriate sound option based on the program content.
- When adjusting sound options (treble and bass) manually, SSM is automatically changed to **User**.

1. Press the **SSM** button.
2. Press the **SSM** button to select your desired sound.

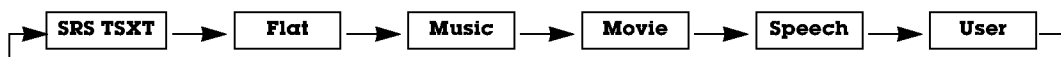

- You can also select **SRS TSXT**, **Flat**, **Music**, **Movie**, **Speech** or **User** in the SOUND menu.
- The sound **SRS TSXT**, **Flat**, **Music**, **Movie** and **Speech** are programmed for good sound reproduction at the factory and cannot be changed.

-  is a trademark of SRS Labs, Inc.
- TruSurround XT technology is incorporated under license from SRS Labs, Inc.

## BBE

- BBE High Definition Sound restores clarity and presence for better speech intelligibility and musical realism.

1. Press the **MENU** button and then use **▲ / ▼** button to select the SOUND menu.
2. Press the **▶** button and then use **▲ / ▼** button to select **BBE**.
3. Press the **▶** button and then use **▲ / ▼** button to select **On** or **Off**.
4. Press the **EXIT** button to return to normal viewing.

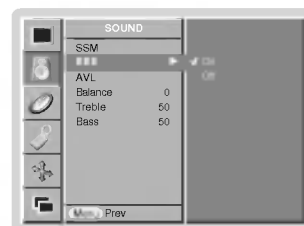

**BBE**. Manufactured under license from BBE Sound, Inc.

## AVL (Auto Volume Leveler)

- This feature maintains an equal volume level; even if you change channels.

1. Press the **MENU** button and then use **▲ / ▼** button to select the SOUND menu.
2. Press the **▶** button and then use **▲ / ▼** button to select **AVL**.
3. Press the **▶** button and then use **▲ / ▼** button to select **On** or **Off**.
4. Press the **EXIT** button to return to normal viewing.



## Adjusting Sound Control (User option)

1. Press the **MENU** button and then use **▲ / ▼** button to select the SOUND menu.
2. Press the **▶** button and then use **▲ / ▼** button to select the desired sound item.
3. Press the **▶** button and then use **◀ / ▶** button to make appropriate adjustments.
4. Press the **EXIT** button to return to normal viewing.

**Note** : Treble, Bass or BBE aren't suitable to use **SRS TSXT**.



# Time Menu Options

## Setting the Clock

- If current time setting is erased by a power failure, if the set is unplugged or turned off with the **ⓘ ON/OFF** button on the set, reset the clock.

1. Press the **MENU** button and then use **▲ / ▼** button to select the **TIME** menu.
2. Press the **▶** button and then use **▲ / ▼** button to select **Clock**.
3. Press the **▶** button and then use **▲ / ▼** button to adjust the hour.
4. Press the **▶** button and then use **▲ / ▼** button to adjust the minute.
5. Press the **EXIT** button to return to normal viewing.



## Setting the On/Off Timer

- Timer function operates only if current time has been already set.
- Off Timer function overrides on Timer function if they are set to the same time.
- The set must be in standby mode for the On Timer to work.

1. Press the **MENU** button and then use **▲ / ▼** button to select the **TIME** menu.
2. Press the **▶** button and then use **▲ / ▼** button to select **Off time** or **On time**.
3. Press the **▶** button and then use **▲ / ▼** button to select **On**.
4. Press the **▶** button and then use **▲ / ▼** button to adjust the hour.
5. Press the **▶** button and then use **▲ / ▼** button to adjust the minute.
6. **Only On time function**; Press the **▶** button and then use **▲ / ▼** button to adjust volume level.
7. Press the **EXIT** button to return to normal viewing.



- To cancel **Off/On time** function  
Press the **▲ / ▼** button to select **Off** in step 3.
- Two hours after the set is switched on by the on time function it will automatically switch back to standby mode unless a button has been pressed.

## Auto Sleep

- If there is no input signal, the monitor turn off automatically after 10 minutes.

1. Press the **MENU** button and then use **▲ / ▼** button to select the **TIME** menu.
2. Press the **▶** button and then use **▲ / ▼** button to select **Auto sleep**.
3. Press the **▶** button and then use **▲ / ▼** button to select **On** or **Off**.
4. Press the **EXIT** button to return to normal viewing.

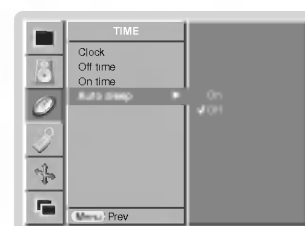

## Sleep Timer

- Sleep timer turns the set off at the preset time.
- Press the **SLEEP** button to select the number of minutes. The display **Ⓛ<sup>zz</sup> --- Min** will appear on the screen, followed by **10, 20, 30, 60, 90, 120, 180** and **240** minutes. The timer begins to count down from the number of minutes selected.

- a. To check the remaining sleep time, press the **OK** button once.
- b. To cancel the sleep time, repeatedly press the **SLEEP** button until the display **Ⓛ<sup>zz</sup> --- Min** appears.
- c. If you turn the set off after setting the sleep timer, the setting will be erased.

# Special Menu Options

## Child lock

- The set can be set up so that it can only be used with the remote control.

  1. Press the **MENU** button and then **▲ / ▼** button to select the **SPECIAL** menu.
  2. Press the **▶** button and then **▲ / ▼** button to select **Child lock**.
  3. Press the **▶** button and then **▲ / ▼** button to select **On** or **Off**.
  4. Press the **EXIT** button to return to normal viewing.



- This set programmed to remember which option it was last set to event if you turn the set off.
- In **Child lock 'On'**, if the set is turned off, press the **INPUT SELECT** button on the set or **POWER, INPUT SELECT** or **MULTIMEDIA** button on the remote control.
- With the **Child lock On**, the display '**▲ Child lock on**' appears on the screen if any button on the front panel is pressed while viewing the set.

## ISM (Image Sticking Minimization) Method

- Frozen still picture from a PC/video game displayed on the screen for prolonged periods will result in an ghost image remaining even when you change the image. Avoid allowing a fixed image to remain on the set's screen for a long period of time.

1. Press the **MENU** button and then use **▲ / ▼** button to select the **SPECIAL** menu.
2. Press the **▶** button and then **▲ / ▼** button to select **ISM Method**.
3. Press the **▶** button and then **▲ / ▼** button to select either **Normal, White wash, Orbiter** or **Inversion**. If you unnecessary to set this function, set **Normal**.

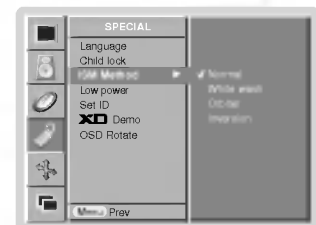

- **White Wash :**

White Wash removes permanent images from the screen.

**Note:** An excessive permanent image may be impossible to clear entirely with White Wash.

- **Orbiter :**

Orbiter may help prevent ghost images. However, it is best not to allow any fixed image to remain on the screen. To avoid a permanent image on the screen, the screen will move every 2 minutes.

- **Inversion :**

This is the function to invert the panel color of the screen. The panel color is automatically inverted every 30 minutes.

4. Press the **EXIT** button to return to normal viewing.

### Low Power

- This is the function to reduce the power consumption of the set.

  1. Press the **MENU** button and then use ▲ / ▼ button to select the **SPECIAL** menu.
  2. Press the ► button and then use ▲ / ▼ button to select **Low power**.
  3. Press the ► button and then use ▲ / ▼ button to select **On** or **Off**.
  4. Press the **EXIT** button to return to normal viewing.



### XD Demo

- Use it to see the difference between XD demo on and XD Demo off.

  1. Press the **MENU** button and then use ▲ / ▼ button to select the **SPECIAL** menu.
  2. Press the ► button and then use ▲ / ▼ button to select **XD Demo**.
  3. Press the ► button to begin **XD Demo**.
  4. To stop **XD Demo**, press the **EXIT** button.



### Menu Rotation for Vertical Viewing

1. Press the **MENU** button and then use ▲ / ▼ button to select the **SPECIAL** menu.
2. Press the ► button and then use ▲ / ▼ button to select **OSD Rotate**.
3. Press the ► button and then use the ▲ / ▼ button to select **Normal** or **Rotate**.
  - Select **Normal** : if the monitor is installed horizontally.
  - Select **Rotate** : if the monitor is installed vertically.
4. Press the **EXIT** button to return to normal viewing.



# Screen Menu Options

## Auto adjustment (RGB [PC] mode only)

- Automatically adjusts picture position and minimizes image shaking.
  - 1. Press the **MENU** button and then use **▲ / ▼** button to select the **SCREEN** menu.
  - 2. Press the **▶** button and then use **▲ / ▼** button to select **Auto config.**
  - 3. Press the **▶** button to start **Auto config.**
    - When **Auto config.** has finished, **OK** will be shown on screen.
    - If the position of the image is still not correct, try Auto adjustment again.
  - 4. If picture needs to be adjusted more after Auto adjustment in RGB (PC), you can adjust the **Manual config.**
  - 5. Press the **EXIT** button to return to normal viewing.
- Although the image is still not correct, your set is functioning properly but needs further adjustment.  
 - The **Auto config.** and the **Manual config.** functions don't need to be run for DVI mode.



## Setting Picture Format

- You can watch the screen in various picture formats; **Spectacle, Full, Original** (option), **4:3, 16:9** (Wide), **14:9** and **Zoom**.
  - It's available to use **Original** in MZ-42PM10/12X/20 / MZ-50PM10/20 series.
  - 1. Press the **MENU** button and then use **▲ / ▼** button to select the **SCREEN** menu.
  - 2. Press the **▶** button and then use **▲ / ▼** button to select **ARC**.
  - 3. Press the **▶** button and then use **▲ / ▼** button to select **Spectacle, Full, Original** (option), **4:3, 16:9, 14:9** or **Zoom**.
    - **Spectacle**  
When your set receives the wide screen signal, following selection will lead you to adjust the picture horizontally, in a linear proportion, to fill the entire screen.
    - **Full**  
When your set receives the wide screen signal, following selection will lead you to adjust the picture horizontally or vertically, in a linear proportion, to fill the entire screen fully.
    - **Original** (option)  
When your set receives the wide screen signal, it will be automatically changed to the picture format to be sent.
    - **4:3**  
Following selection will lead you to view a picture with an original 4:3 aspect ratio, with gray bars appearing at both the left and right sides.
    - **16:9** (Wide)  
Following selection will lead you to adjust the picture horizontally, in a linear proportion, to fill the entire screen (useful for viewing 4:3 formatted DVDs).
    - **14:9**  
You can enjoy the picture format of 14:9 or general TV programme through the 14:9 mode. The screen 14:9 is viewed just like that the screen 4:3 is magnified to the left / right.
    - **Zoom**  
Following selection will lead you to view the picture without any alternation, while filling the entire screen. However, the top and bottom portions of the picture will be cropped.
  - 4. Press the **EXIT** button to return to normal viewing.
- You can only select **4:3** and **16:9** (Wide) in RGB[PC], DVI[PC].  
 - You can only select **4:3, 16:9** (Wide) and **Zoom** in Component 480p/576p/720p/1080i, RGB[DVI] or DVI[DVI].

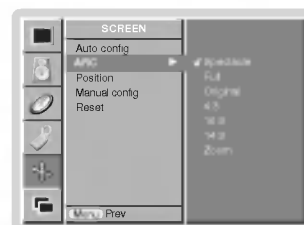

## Screen Position

- This function works in the following mode:  
RGB-PC or COMPONENT 480p/576p/720p/1080i.
- 1. Press the **MENU** button and then **▲ / ▼** button to select the **SCREEN** menu.
- 2. Press the **▶** button and then **▲ / ▼** button to select **Position**.
- 3. Press the **▶** button and then **▲ / ▼** or **◀ / ▶** button to adjust the position.
- 4. Press the **EXIT** button to return to normal viewing.

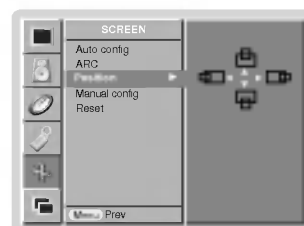

### Manual Configure (RGB [PC] mode only)

- If the picture isn't clear after auto adjustment and especially that characters are still trembling, adjust the picture phase manually.
- To correct the screen size, adjust **Clock**.
  1. Press the **MENU** button and then **▲ / ▼** button to select the SCREEN menu.
  2. Press the **▶** button and then **▲ / ▼** button to select **Manual config.**
  3. Press the **▶** button and then **▲ / ▼** button to select **Phase** or **Clock**.
  4. Press the **◀ / ▶** button to make appropriate adjustments.
    - The adjustment range of **Phase** is 0 ~ 30.
    - The adjustment range of **Clock** is -127 ~ +128.
  5. Press the **EXIT** button to return to normal viewing.

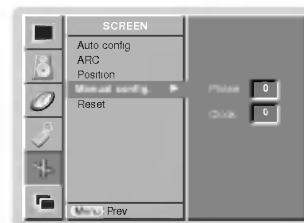

### Selecting Wide VGA/XGA mode (RGB[PC] mode only)

- To see a normal picture, match the resolution of RGB mode and selection of VGA/XGA mode.
- In some models, it's not available to selection of XGA mode.
  1. Press the **MENU** button and then use **▲ / ▼** button to select the SCREEN menu.
  2. Press the **▶** button and then use **▲ / ▼** button to select **VGA Mode** (or **XGA Mode**).
  3. Press the **▶** button and then use **▲ / ▼** button to select the desired VGA/XGA resolution.
  4. Press the **EXIT** button to return to normal viewing.

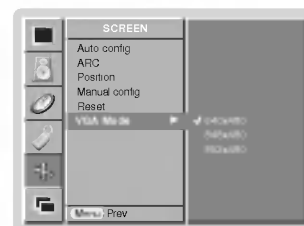

### Screen Adjustments

- Use this function to correct jittering or picture instability while viewing a video tape.
- This function works in the following mode:  
AV (or AV1, AV2) or Component 480i/576i.
  1. Press the **MENU** button and then use **▲ / ▼** button to select the SCREEN menu.
  2. Press the **▶** button and then use **▲ / ▼** button to select **Screen adj.**
  3. Press the **▶** button and then use **▲ / ▼** button to select **TV** or **VCR**.
    - Select the **VCR** option if watching a VCR.
    - Select the **TV** option for other equipment.(Except VCR)
  4. Press the **EXIT** button to return to normal viewing.



### Cinema

- When you watch the movie, this function adjusts the set to the best picture appearance.
- This function works in the following mode:  
AV (or AV1, AV2) or COMPONENT 480i/576i.
  1. Press the **MENU** button and then use **▲ / ▼** button to select the SCREEN menu.
  2. Press the **▶** button and then use **▲ / ▼** button to select **Cinema**.
  3. Press the **▶** button and then use **▲ / ▼** button to select **On** or **Off**.
  4. Press the **EXIT** button to return to normal viewing.

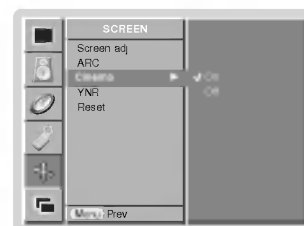

# Screen Menu Options

## Luminance Noise Reduction (option)

- You can select **On** or **Off** to reduce the picture noise which may appear on the screen during watching the TV.
- This function works in the following mode:  
AV (or AV1, AV2) or Component 480i/576i.

1. Press the **MENU** button and then use **▲ / ▼** button to select the **SCREEN** menu.
2. Press the **▶** button and then use **▲ / ▼** button to select **YNR**.
3. Press the **▶** button and then use **▲ / ▼** button to select **On** or **Off**.
4. Press the **EXIT** button to return to normal viewing.

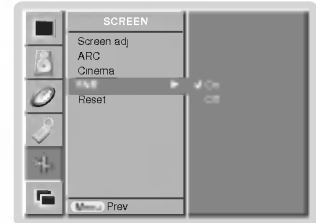

## Initializing (Reset to original factory value)

This function operates in current mode.  
To initialize the adjusted value

1. Press the **MENU** button and then **▲ / ▼** button to select the **SCREEN** menu.
2. Press the **▶** button and then **▲ / ▼** button to select **Reset**.
3. Press the **▶** button.
  - You can initialize Position, SPLIT ZOOM, PIP size, PIP position, PIP Transparency and sub picture size of twin picture.

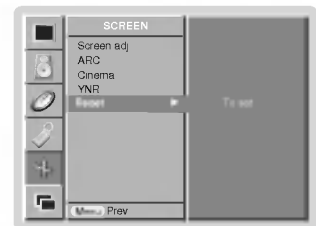

## Split Zoom

- This is the function to enlarge the screen with regular ration.
- It's available to use this function in every input source.
- It's not available to use this function in **Rotate** mode.
- With 2-SPLIT ZOOM, you can only move the screen into upside or downside.
- If a screen is enlarged, a screen can move without selecting a section of screen.

1. Press the **SPLIT ZOOM** button.
  - Each press of **SPLIT ZOOM** button changes the screen display as shown below.



### In case of 9-Split Zoom:

Press the number button to select the section you want to enlarge.  
If you choose No.5, the 5 section is enlarged and also can move the enlarged screen with using the **▲ / ▼** or **◀ / ▶** button.

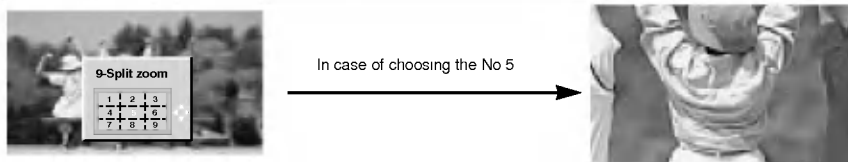

The 5 section is changed to a full screen



# PIP (Picture-in-Picture) Feature

- PIP lets you view 2 different inputs (sources) on your set screen at the same time.

## Watching PIP

Press the **PIP/DW** button to show the sub picture.

- Each press of **PIP/DW** button changes the screen display as shown below.

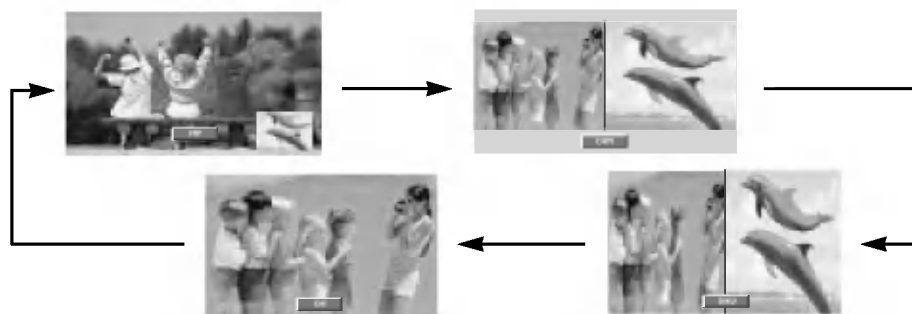

## Moving the PIP (PIP mode only)

Press the **POSITION** button.

Repeatedly press the **▲ / ▼** or **◀ / ▶** button until desired position is achieved. The sub picture moves up/down or left/right.



## Selecting an Input Signal Source for the PIP

Press the **PIP INPUT** button to select the input source for the sub picture.



- In RGB, DVI and COMPONENT 480p/576p/720p/1080i for main picture, you can select AV (or AV1, AV2) and COMPONENT 480i/576i for sub picture.
- In AV (or AV1, AV2) and COMPONENT 480i/576i for main picture, you can select COMPONENT 480p/576p/720p/1080i, RGB and DVI for sub picture.
- You can't select the same modes for main picture and sub picture simultaneously.

## Picture Size

Press the **WIN.SIZE** button and then **◀ / ▶** button to adjust the sub picture size.

With **WIN.SIZE** button in DW1, DW2 modes, main and sub picture is adjusted simultaneously. With **WIN.SIZE** button in PIP mode, sub picture is adjusted.



## Adjusting PIP Transparency (PIP mode only)

1. Press the **MENU** button and then **▲ / ▼** button to select the PIP/DW menu.
2. Press the **▶** button and then **▲ / ▼** button to select **PIP Transparency**.
3. Press the **▶** button and then **◀ / ▶** button to adjust PIP transparency.
  - The adjustment range of **PIP Transparency** is 0 ~ 10.
4. Press the **EXIT** button to return to normal viewing.

# External Control Device Setup

- Connect the RS-232C input jack to an external control device (such as a computer or an A/V control system) and control the set's functions externally.

### How to connect external control equipment

- Connect the serial port of the control device to the RS-232C jack on the Monitor back panel.
- RS-232C connection cables are not supplied with the set.
- The set remote control and front panel controls (except main power) will not be functional if the Monitor is controlled by a PC computer or other external device.
- RS-232C connection cables are used for service.

### Type of connector; D-Sub 9-pin male

No.	Pin name
1	No connection
2	RXD (Receive data)
3	TXD (Transmit data)
4	DTR (DTE side ready)
5	GND
6	DSR (DCE side ready)
7	RTS (Ready to send)
8	CTS (Clear to send)
9	No Connection

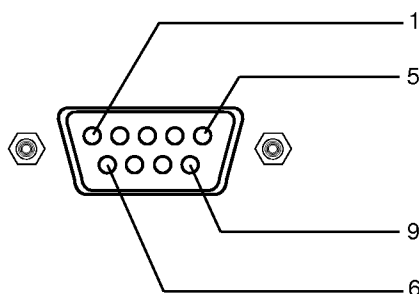

### RS-232C configurations

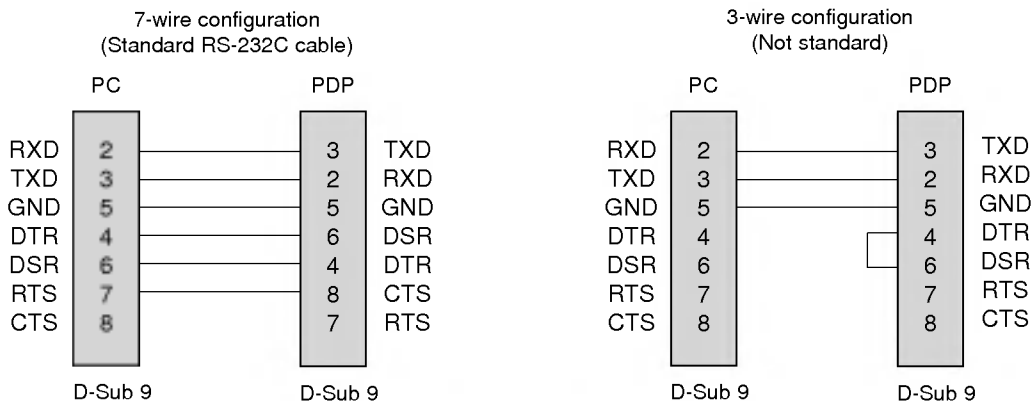

## Set ID

- Use this function to specify a set ID number.
- Refer to 'Real Data Mapping 1'. See page 31.

1. Press the **MENU** button and then use the **▲ / ▼** button to select the **SPECIAL** menu.
2. Press the **▶** button and then use **▲ / ▼** button to select **Set ID**.
3. Press the **▶** button and then use **◀ / ▶** button to adjust **Set ID** to choose the desired monitor ID number.
  - The adjustment range of **Set ID** is 1 ~ 99.
4. Press the **EXIT** button to return to normal viewing.



## Communication Parameters

- Baud rate : 9600 bps (UART)
- Data length : 8 bits
- Parity : None
- \* Use a crossed (reverse) cable.
- Stop bit : 1 bit
- Communication code : ASCII code

## Command Reference List

	COMMAND 1	COMMAND 2	DATA (Hexadecimal)
01. Power	k	a	0 ~ 1
02. Input Select	k	b	0 ~ 5
03. Aspect Ratio	k	c	0 ~ 6
04. Screen Mute	k	d	0 ~ 1
05. Volume Mute	k	e	0 ~ 1
06. Volume Control	k	f	0 ~ 64
07. Contrast	k	g	0 ~ 64
08. Brightness	k	h	0 ~ 64
09. Colour	k	i	0 ~ 64
10. Tint	k	j	0 ~ 64
11. Sharpness	k	k	0 ~ 64
12. OSD Select	k	l	0 ~ 1
13. Remote control lock mode	k	m	0 ~ 1
14. PIP/DW	k	n	0 ~ 3
15. Split Zoom	k	p	0 ~ 99
16. PIP Position	k	q	0 ~ 3
17. Treble	k	r	0 ~ 64
18. Bass	k	s	0 ~ 64
19. Balance	k	t	0 ~ 64
20. Colour Temperature (CSM)	k	u	0 ~ 3
21. Red Adjustment	k	v	0 ~ 3C
22. Green Adjustment	k	w	0 ~ 3C
23. Blue Adjustment	k	\$	0 ~ 3C
24. PIP input select	k	y	0 ~ 5
25. Abnormal State	k	z	0 ~ a
26. ISM Method	j	p	0 ~ 3
27. Low Power	j	q	0 ~ 1
28. Orbiter Time Setting	j	r	1 ~ FE
29. Orbiter Pixel Setting	j	s	1 ~ 9
30. Picture Size Setting for D/W Mode	j	t	0 ~ 14 (or 1E)
31. Auto Configure	j	u	1

- \* When setting the 25 ~ 31, a menu doesn't display on screen.

## Transmission / Receiving Protocol

### Transmission

[Command1][Command2][ ][Set ID][ ][Data][Cr]

- \* [Command 1] : First command to control PDP set. (j or k)
- \* [Command 2] : Second command to control PDP set.
- \* [Set ID] : You can adjust the set ID to choose desired monitor ID number in special menu. See previous page. Adjustment range is 1 ~ 99. When selecting Set ID '0', every connected PDP set is controlled. Set ID is indicated as decimal (1~99) on menu and as Hexa decimal (0x0~0x63) on transmission/receiving protocol.
- \* [DATA] : To transmit command data. Transmit 'FF' data to read status of command.
- \* [Cr] : Carriage Return  
ASCII code '0x0D'
- \* [ ] : ASCII code 'space (0x20)'

### OK Acknowledgement

[Command2][ ][Set ID][ ][OK][Data][x]

- \* The Monitor transmits ACK (acknowledgement) based on this format when receiving normal data. At this time, if the data is data read mode, it indicates present status data. If the data is data write mode, it returns the data of the PC computer.

### Error Acknowledgement

[Command2][ ][Set ID][ ][NG][Data][x]

- \* The Monitor transmits ACK (acknowledgement) based on this format when receiving abnormal data from non-viable functions or communication errors.

- Data 1: Illegal Code  
2: not support function  
3: Wait more time



**09. Colour (Command 2 : i)**

- ▶ To adjust the screen colour.  
You can also adjust colour in the PICTURE menu.

Transmission

```
[k][i][ ][Set ID][ ][Data][Cr]
```

Data Min : 0 ~ Max : 64

\* Refer to 'Real data mapping 1'. See page 31.

Ack

```
[i][ ][Set ID][ ][OK][Data][x]
```

**10. Tint (Command 2 : j) (option)**

- ▶ To adjust the screen tint.  
You can also adjust tint in the PICTURE menu.

Transmission

```
[k][j][ ][Set ID][ ][Data][Cr]
```

Data Red : 0 ~ Green : 64

\* Refer to 'Real data mapping 1'. See page 31.

Ack

```
[j][ ][Set ID][ ][OK][Data][x]
```

**11. Sharpness (Command 2 : k)**

- ▶ To adjust the screen sharpness.  
You can also adjust sharpness in the PICTURE menu.

Transmission

```
[k][k][ ][Set ID][ ][Data][Cr]
```

Data Min : 0 ~ Max : 64

\* Refer to 'Real data mapping 1'. See page 31.

Ack

```
[k][ ][Set ID][ ][OK][Data][x]
```

**12. OSD Select (Command 2 : l)**

- ▶ To select OSD (On Screen Display) on/off when controlling remotely.

Transmission

```
[k][l][ ][Set ID][ ][Data][Cr]
```

Data 0 : OSD off                    1 : OSD on

Ack

```
[l][ ][Set ID][ ][OK][Data][x]
```

**13. Remote control lock mode (Command 2 : m)**

- ▶ To lock the front panel controls on the monitor and remote control.

Transmission

```
[k][m][ ][Set ID][ ][Data][Cr]
```

Data 0 : Lock off                    1 : Lock on

Ack

```
[m][ ][Set ID][ ][OK][Data][x]
```

\* If you're not using the remote control, use this mode.  
When main power is on/off, external control lock is released.

**14. PIP / DW (Command 2 : n)**

- ▶ To control the PIP (Picture In picture)/DW.  
You can also control the PIP/DW using the PIP/DW button on the remote control or in the PIP/DW menu.

Transmission

```
[k][n][ ][Set ID][ ][Data][Cr]
```

Data 0: PIP/DW off

1: PIP

2: DW1

3: DW2

Ack

```
[n][ ][Set ID][ ][OK][Data][x]
```

**15. Split Zoom (Command 2 : p)**

- ▶ To operate split zoom function and select the split zoom section number.

Transmission

```
[k][p][ ][Set ID][ ][Data][Cr]
```

Data Min: 0 ~ Max: 99

ex. Data 21: Selection 1 of 2 split zoom.

• Refer to 'Real data mapping 2'.

Ack

```
[p][ ][Set ID][ ][OK][Data][x]
```

**\* Real data mapping 2**

0 : Reset split zoom  
21: Selection 1 of 2 split zoom  
24: Selection 4 of 2 split zoom  
41: Selection 1 of 4 split zoom  
42: Selection 2 of 4 split zoom  
44: Selection 4 of 4 split zoom  
45: Selection 5 of 4 split zoom  
91: Selection 1 of 9 split zoom  
⋮  
99: Selection 9 of 9 split zoom

**16. PIP Position (Command 2 : q)**

- ▶ To select sub picture position for PIP.  
You can also adjust the sub picture position using WIN.POSITION button on the remote control or in the PIP/DW menu.

Transmission

```
[k][q][ ][Set ID][ ][Data][Cr]
```

Data 0 : Right down on screen

1 : Left down on screen

2 : Left up on screen

3 : Right up on screen

Ack

```
[q][ ][Set ID][ ][OK][Data][x]
```

**17. Treble (Command 2 : r)**

- ▶ To adjust treble.  
You can also adjust treble in the SOUND menu.

Transmission

```
[k][r][ ][Set ID][ ][Data][Cr]
```

Data Min : 0 ~ Max : 64  
\* Refer to 'Real data mapping 1'. See page 31.

Ack

```
[r][ ][Set ID][ ][OK][Data][x]
```

**18. Bass (Command 2 : s)**

- ▶ To adjust bass.  
You can also adjust bass in the SOUND menu.

Transmission

```
[k][s][ ][Set ID][ ][Data][Cr]
```

Data Min : 0 ~ Max : 64  
\* Refer to 'Real data mapping 1'. See page 31.

Ack

```
[s][ ][Set ID][ ][OK][Data][x]
```

**19. Balance (Command 2 : t)**

- ▶ To adjust balance.  
You can also adjust balance in the SOUND menu.

Transmission

```
[k][t][ ][Set ID][ ][Data][Cr]
```

Data Min : 0 ~ Max : 64  
\* Refer to 'Real data mapping 1'. See page 31.

Ack

```
[t][ ][Set ID][ ][OK][Data][x]
```

**20. Colour Temperature (Command 2 : u)**

- ▶ To adjust colour temperature.  
You can also adjust CSM in the PICTURE menu.

Transmission

```
[k][u][ ][Set ID][ ][Data][Cr]
```

Data 0: Cool 1: Normal 2: Warm 3: User

Ack

```
[u][ ][Set ID][ ][OK][Data][x]
```

**21. Red Adjustment (Command 2 : v)**

- ▶ To adjust red in colour temperature.

Transmission

```
[k][v][ ][Set ID][ ][Data][Cr]
```

Data Min : 0 ~ Max : 3C  
\* Refer to 'Real data mapping 3'. See page 31.

Ack

```
[v][ ][Set ID][ ][OK][Data][x]
```

**22. Green Adjustment (Command 2 : w)**

- ▶ To adjust green in colour temperature.

Transmission

```
[k][w][ ][Set ID][ ][Data][Cr]
```

Data Min : 0 ~ Max : 3C  
\* Refer to 'Real data mapping 3'. See page 31.

Ack

```
[w][ ][Set ID][ ][OK][Data][x]
```

**23. Blue Adjustment (Command 2 : \$)**

- ▶ To adjust blue in colour temperature.

Transmission

```
[k][$][ ][Set ID][ ][Data][Cr]
```

Data Min : 0 ~ Max : 3C  
\* Refer to 'Real data mapping 3'. See page 31.

Ack

```
[$][ ][Set ID][ ][OK][Data][x]
```

**24. PIP Input Select (Command 2 : y)**

- ▶ To select input source for sub picture in PIP/Twin picture mode. You can also adjust input source for sub picture using PIP INPUT button on remote control.

Transmission

```
[k][y][ ][Set ID][ ][Data][Cr]
```

Data 0 : RGB 3 : AV (or AV1)  
1 : DVI 4 : S-Video (or AV2)  
2 : Component 5 : S-Video (option)

Ack

```
[y][ ][Set ID][ ][OK][Data][x]
```

**25. Abnormal State (Command 2 : z)**

- ▶ To recognize an abnormal state.

Transmission

```
[k][z][ ][Set ID][ ][FF][ ][Cr]
```

Data FF : Read

Ack

```
[z][ ][Set ID][ ][OK][Data][x]
```

Data 0: Normal (Power on and signal exist)  
1: No signal (Power on)  
2: Turn the monitor off by remote control  
3: Turn the monitor off by sleep time function  
4: Turn the monitor off by RS-232C function  
5: 5V down  
6: AC down  
7: Turn the monitor off by Fan Alarm function  
8: Turn the monitor off by Off time function  
9: Turn the monitor off by Auto sleep function  
a: Turn the monitor off by On time function

\* This function is "read only".

**26. ISM Method****(Command 1 : j, Command 2 : p)**

- ▶ To control the ISM method. You can also adjust ISM Method in SPECIAL menu.

Transmission

```
[j][p][ ][Set ID][ ][Data][Cr]
```

Data 0 : Normal Mode                    2 : Orbiter  
       1 : White Wash                    3 : Inversion

Ack

```
[p][ ][Set ID][ ][OK][Data][x]
```

**27. Low Power****(Command 1 : j, Command 2 : q)**

- ▶ To reduce the power consumption of the monitor. You can also adjust Low Power in SPECIAL menu.

Transmission

```
[j][q][ ][Set ID][ ][Data][ ][Cr]
```

Data 0 : Off  
       1 : On

Ack

```
[q][ ][Set ID][ ][OK][Data][x]
```

**28. Orbiter Time Setting****(Command 1 : j, Command 2 : r)**

- ▶ To adjust orbiter operation time term.

Transmission

```
[j][r][ ][Set ID][ ][Data][ ][Cr]
```

Data Min: 1 ~ Max: FE  
       \* Refer to 'Real data mapping 1'. See page 31.

Ack

```
[r][ ][Set ID][ ][OK][Data][x]
```

**29. Orbiter Pixel Setting****(Command 1 : j, Command 2 : s)**

- ▶ To adjust pixel number in orbiter function.

Transmission

```
[j][s][ ][Set ID][ ][Data][Cr]
```

Data Min: 1 ~ Max: 9  
       \* Refer to 'Real data mapping 1'. See page 31.

Ack

```
[s][ ][Set ID][ ][OK][Data][x]
```

**30. Picture Size Setting for DW Mode****(Command 1 : j, Command 2 : t)**

- ▶ To select the PIP picture format.  
 You can also select the PIP picture format using the WIN.SIZE on the remote control.

Transmission

```
[j][t][ ][Set ID][ ][Data][Cr]
```

Data Min: 0 ~ Max: 14 (or 1E)  
       \* Refer to 'Real data mapping 1'. See page 31.

Ack

```
[t][ ][Set ID][ ][OK][Data][x]
```

**31. Auto Configure****(Command 1 : j, Command 2 : u)**

- ▶ To adjust picture position and minimize image shaking automatically. It works only in RGB (PC) mode.

Transmission

```
[j][u][ ][Set ID][ ][Data][Cr]
```

Data 1: To set

Ack

```
[u][ ][Set ID][ ][OK][Data][x]
```

**\* Real data mapping 1**

```
0 : Step 0
⋮
A : Step 10 (Set ID 10)
⋮
F : Step 15 (Set ID 15)
10 : Step 16 (Set ID 16)
⋮
64 : Step 100
⋮
6E : Step 110
⋮
73 : Step 115
74 : Step 116
⋮
C7 : Step 199
```

**\* Real data mapping 3**

```
0 : -30
1 : -29
2 : -28
⋮
1E : 0
⋮
3A : +28
3B : +29
3C : +30
```

# IR Code (NEC Format)

## How to connect

- ▶ Connect your wired remote control to the Remote Control port on the Monitor.

## Remote Control IR Code (NEC Format)

### ▶ Output waveform

Single pulse, modulated with 37.917KHz signal at 455KHz

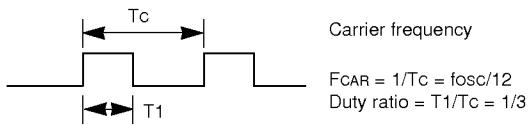

### ▶ Configuration of frame

- 1st frame

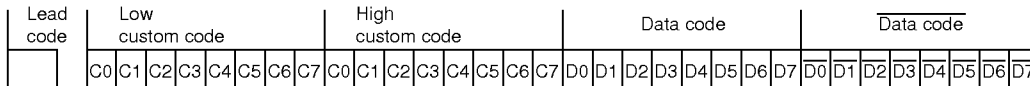

- Repeat frame

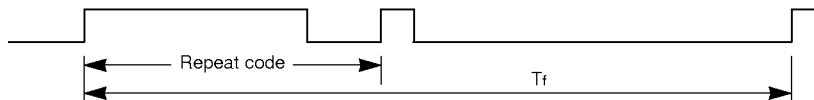

### ▶ Lead code



### ▶ Repeat code

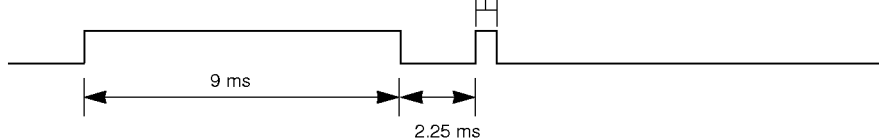

### ▶ Bit description

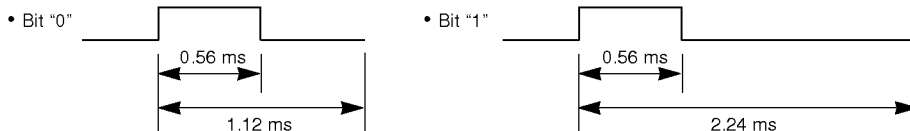

### ▶ Frame interval : Tf

The waveform is transmitted as long as a key is depressed.

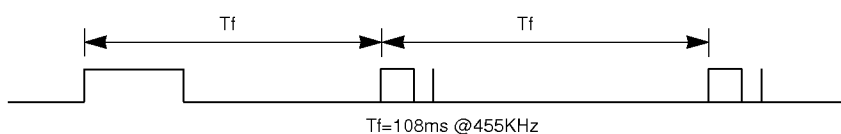



Code (Hexa)	Function	Note
00	UP (▲)	R/C Button
01	DOWN (▼)	R/C Button
02	VOL+ (▶)	R/C Button
03	VOL- (◀)	R/C Button
08	POWER	R/C Button (Power On/Off)
C4	POWER ON	Discrete IR Code (Only Power On)
C5	POWER OFF	Discrete IR Code (Only Power Off)
09	MUTE	R/C Button
10	Number Key 0	R/C Button
11	Number Key 1	R/C Button
12	Number Key 2	R/C Button
13	Number Key 3	R/C Button
14	Number Key 4	R/C Button
15	Number Key 5	R/C Button
16	Number Key 6	R/C Button
17	Number Key 7	R/C Button
18	Number Key 8	R/C Button
19	Number Key 9	R/C Button
0B	INPUT SELECT	R/C Button
98	MULTIMEDIA	R/C Button
BF	COMPONENT	Discrete IR Code (Input COMPONENT Selection)
C6	DVI	Discrete IR Code (Input DVI Selection)
D5	RGB	Discrete IR Code (Input RGB Selection)
5A	AV1	Discrete IR Code (Input AV1 Selection)
D0 (option)	AV2	Discrete IR Code (Input AV2 Selection)
D8	S-VIDEO	Discrete IR Code (Input S-VIDEO Selection)
0E	SLEEP	R/C Button
43	MENU	R/C Button
44	OK(■)	R/C Button
4D	PSM	R/C Button
52	SSM	R/C Button
62	WIN.POSITION	R/C Button
64	WIN.SIZE	R/C Button
60	PIP/DW	R/C Button
61	PIP INPUT	R/C Button
63	SWAP	R/C Button
7B	SPLIT ZOOM	R/C Button
79	ARC	R/C Button
76	ARC (4:3)	Discrete IR Code (Only 4:3 mode)
77	ARC (16:9)	Discrete IR Code (Only 16:9 mode)
AF	ARC (Zoom)	Discrete IR Code (Only Zoom mode)

## Troubleshooting Checklist

<b>No picture &amp; No sound</b>	<ul style="list-style-type: none"><li>• Check whether the set is turned on.</li><li>• Power cord inserted into wall outlet?</li><li>• Plug another product's power cord into the wall outlet where the set's power cord was plugged in.</li></ul>
<b>Picture OK &amp; No sound</b>	<ul style="list-style-type: none"><li>• Press the <b>VOLUME</b> (▶) button.</li><li>• Sound muted? Press <b>MUTE</b> button.</li></ul>
<b>The remote control doesn't work</b>	<ul style="list-style-type: none"><li>• Check to see if there is any object between the set and the remote control causing obstruction.</li><li>• Check to see if the batteries are installed with the correct polarities. (Refer to p.6)</li><li>• Check if the remote control handset is set up to correct mode.</li><li>• Install new batteries. (Refer to p.6)</li></ul>
<b>Picture appears slowly, after switching on</b>	<ul style="list-style-type: none"><li>• This is normal as the image is muted during the startup process of the set. Please contact your service centre, if the picture has not appeared after five minutes.</li></ul>
<b>No or Poor colour or Poor picture</b>	<ul style="list-style-type: none"><li>• Select <b>Colour</b> in the PICTURE menu and press the <b>VOLUME</b> (▶) button. (Refer to p.17)</li><li>• Keep a certain distance between the set and the VCR.</li><li>• Activate any function to restore the brightness of the picture. (If still picture is on the screen for more than 5 minutes, the screen gets dark.)</li></ul>
<b>Horizontal/vertical bars or picture shaking</b>	<ul style="list-style-type: none"><li>• Check for local interference such as an electrical appliance or power tool.</li></ul>
<b>No output from one of the speakers</b>	<ul style="list-style-type: none"><li>• Adjust <b>Balance</b> in the SOUND menu. (Refer to p.18)</li></ul>
<b>Unusual sound from inside the set</b>	<ul style="list-style-type: none"><li>• A change in ambient humidity or temperature may result in an unusual noise at the time of switching off or on of the set and does not indicate a fault with the set.</li></ul>

# Product Specifications

MODEL	MZ-42PM10/H/B/R/S MZ-42PM20/H/B/R/S	MZ-42PM12X/H/B/R/S
Width (inches / mm)	42 / 1066	
Height (inches / mm)	25.6 / 650	
Depth (inches / mm)	3.9 / 97.5	
Weight (pounds / kg)	66 / 30	
Power requirement	AC100-240V, 50/60Hz	
Resolution	852 x 480 (Dot)	1024 x 768 (Dot)
Colour	16,770,000 (256 steps of each R, G and B)	
Operating Temperature Range	32 ~ 104°F (0 ~ 40°C)	
Operating Humidity Range	Less than 80%	

MODEL	MZ-50PM10/H/B/R/S	MZ-50PM20/H/B/R/S
Width (inches / mm)	49.3 / 1253	
Height (inches / mm)	29.3 / 745	
Depth (inches / mm)	4 / 99.5	
Weight (pounds / kg)	90.4 / 41	
Power requirement	AC100-240V, 50/60Hz	
Resolution	1366 x 768 (Dot)	
Colour	16,770,000 (256 steps of each R, G and B)	
Operating Temperature Range	32 ~ 104°F (0 ~ 40°C)	
Operating Humidity Range	Less than 80%	

- The specifications shown above may be changed without notice for quality improvement.

