



Colour Television

OWNER'S MANUAL

Please read this manual carefully before operating your set.
Retain it for future reference.
Record model number and serial number of the set.
See the label attached on the back cover and quote this
information to your dealer when you require service.

Model number :
Serial number :

Contents

Installation	3
Location and function of controls	4
Remote control handset	
Battery installation	
Front panel	
Basic operation	7
On and off / Programme selection	
Volume adjustment / Quick view	
Mute function / Auto Demonstration	
On screen language selection (option)	
On screen menus	8
Menu selection	
Setting up TV stations	9
Auto programme tuning	
Manual programme tuning	
Fine Tuning	
Programme edit / Favourite programme	
Calling the programme table	
Picture adjustment	14
Picture adjustment / Eye (option) / Picture format	
Turbo picture selection (option)	
Sound adjustment	16
Sound adjustment / Turbo sound selection (option)	
Stereo/Dual reception	
NICAM reception (option)	
Sound output selection	
Time setting	18
Time / On/Off time	
On Programme number / Volume / Auto sleep	
Other functions	19
TV and AV modes / Auto AV switching (option)	
Child lock / Blue back	
Degaussing / Tilt (option) / Sleep timer	
Teletext (option)	21
Switch on/off	
SIMPLE text	
TOP text (option)	
FASTEXT mode	
Special teletext functions	
Connection of external equipment	24
Aerial socket	
Euro scart sockets	
Audio/Video in sockets (option)	
Audio out sockets (AUDIO OUT) (option)	
S-video/Audio in sockets (S-AV) (option)	
Headphone socket (option)	
Troubleshooting check list	26

Installation

Power

This set operates on an AC mains supply, the voltage is as indicated on the label on the back cover. Never apply DC power to the set. In the event of thunderstorms or powercuts, please pull out the aerial and mains plugs.

Warning

To prevent fire or shock hazard, do not expose the set to rain or moisture.

Service

Never remove the back cover of the set as this can expose you to very high voltage and other hazards. If the set does not operate properly, unplug it and call your dealer.

Aerial

Connect the aerial cable to the socket marked $75\ \Omega$ on the back cover. For the best reception an outdoor aerial should be used.

Location

Position your set so that no bright light or sunlight falls directly onto the screen. Care should be taken not to expose the set to any unnecessary vibration, moisture, dust or heat. Also ensure that the set is placed in a position to allow a free flow of air. Do not cover the ventilation openings on the back cover.

Location and function of controls

All the functions can be controlled with the remote control handset. Some functions can also be adjusted with the buttons on the front panel of the set.

Remote control handset

Before you use the remote control handset, please install the batteries. See the next page.

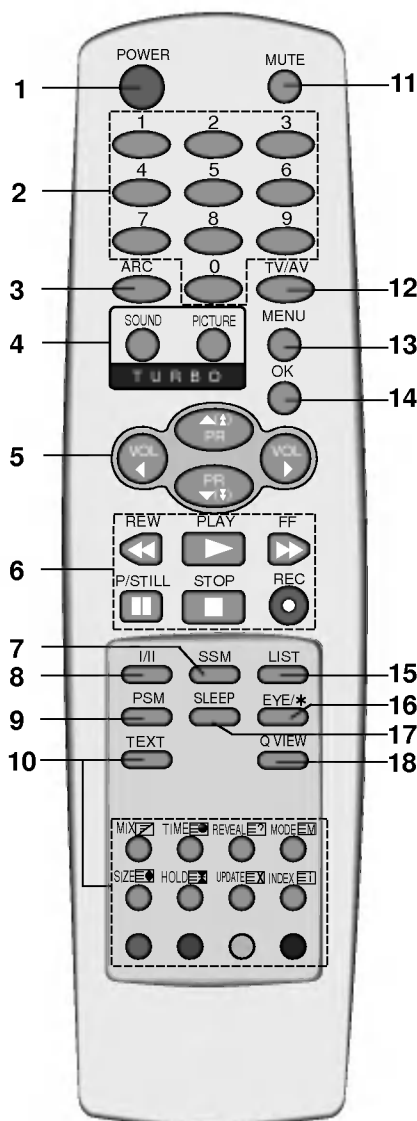

(With TELETEXT)

1. **POWER**
switches the set on from standby or off to standby.
2. **NUMBER BUTTONS**
switches the set on from standby or directly select a number.
3. **ARC (Aspect Ratio Control)**
changes the picture format.
4. **TURBO PICTURE / SOUND BUTTON**
selects Turbo picture / sound.
5. **▲(▲) / ▼(▼) (Programme Up/Down)**
selects a programme or a menu item.
switches the set on from standby.
scans programmes automatically.
- ◀ / ▶ (Volume Up/Down)**
adjusts the volume.
- (Menu)**
adjusts menu settings.
6. **VCR BUTTONS (option)**
control a LG video cassette recorder.
7. **SSM (Sound Status Memory)**
recalls your preferred sound setting.
8. **I/II (option)**
selects the language during dual language broadcast (option).
selects the sound output.
9. **PSM (Picture Status Memory)**
recalls your preferred picture setting.
10. **TELETEXT BUTTONS (option)**
These buttons are used for teletext.
For further details, see the 'Teletext' section.
11. **MUTE**
switches the sound on or off.
12. **TV/AV**
selects TV or AV mode.
switches the set on from standby.

Location and function of controls

- 13. MENU**
selects a menu.
- 14. OK**
accepts your selection or displays the current mode.
- 15. LIST**
displays the programme table.
- 16. EYE/★ (option)**
switches the eye function on or off.
- 17. SLEEP**
sets the sleep timer.
- 18. Q.VIEW**
returns to the previously viewed programme.
selects a favourite programme.

COLOURED BUTTONS

These buttons are used for teletext (only TELETEXT models) or programme edit.

Battery installation

The remote control handset is powered by two AA type batteries. To load the batteries, turn the remote control handset over and open the battery compartment. Install two batteries as indicated by the polarity symbols (⊕ and ⊖) marked inside the compartment.

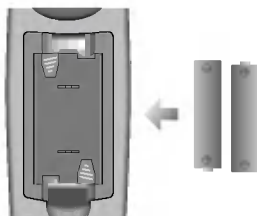

Note : To avoid damage from possible battery leakage, remove the batteries if you do not plan to use the remote control handset for an extended period of time.

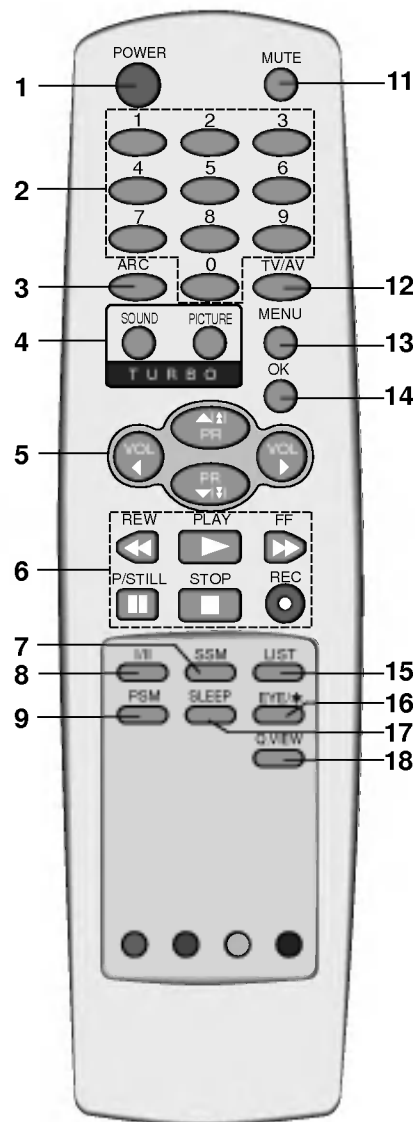

(Without TELETEXT)

Location and function of controls

Front panel

CE/CL-29Q40 series

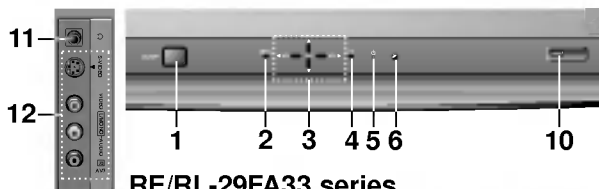

RE/RL-29FA33 series

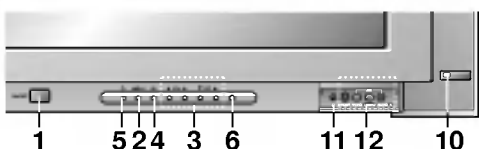

CE/CL-25/29Q20 series

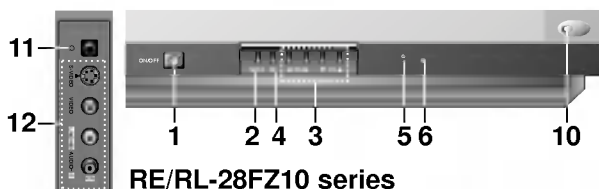

RE/RL-28FZ10 series

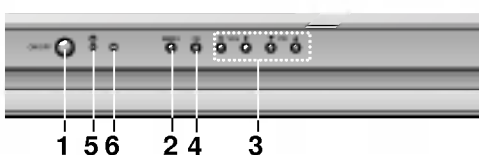

CE/CL-29K30 series

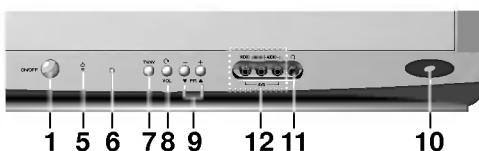

CE/CL-25/29H40 series

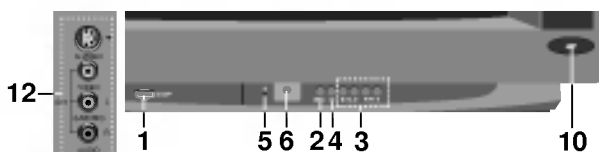

CE/CL-28H80 series

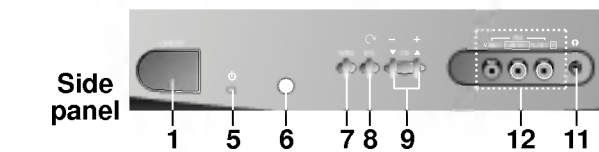

RE/RL-28CB80 series

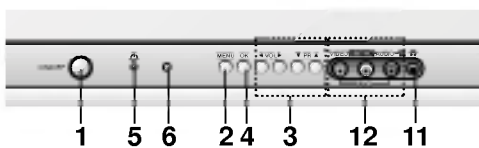

1. **MAIN POWER**
switches the set on or off.
2. **MENU (option)**
selects a menu.
3. **▲ / ▼ (Programme Up/Down) (option)**
selects a programme or a menu item.
switches the set on from standby.
◀ / ▶ (Volume Down/Up) (option)
adjusts the volume.
adjusts menu settings.
4. **OK (option)**
accepts your selection or displays the current mode.
5. **POWER/STANDBY INDICATOR**
illuminates brightly when the set is in standby mode.
dims when the set is switched on.
6. **REMOTE CONTROL SENSOR**
Note : Only use the supplied remote control handset. (When you use others, they'll be not able to function.)
7. **TV/AV (option)**
selects TV or AV mode.
clears the menu from the screen.
switches the set on from standby.
8. **⌂ (Function) (option)**
selects volume, EYE (option), picture items or brief auto programme while the menus not display.
9. **+/- (▲/▼) (option)**
adjusts the function or selects a programme.
switches the set on from standby.
10. **EYE (option)**
adjusts picture according to the surrounding conditions.
11. **HEADPHONE SOCKET (option)**
Connect the headphone plug to this socket.
12. **AUDIO/VIDEO IN SOCKETS (AV3)**
Connect the audio/video out sockets of external equipment to these sockets.
S-VIDEO/AUDIO IN SOCKETS (S-AV) (option)
Connect the video out socket of an S-VIDEO VCR to the **S-VIDEO** socket.
Connect the audio out sockets of the S-VIDEO VCR to the audio sockets as in **AV3**.

Note : Do not place any heavy objects (over 4Kg) on the RE/RL-29FA33 series models.

Basic operation

On and off

1. Press the main power button to switch the set on.
2. If the set is in standby mode, press the **POWER**, **▲ / ▼**, **TV/AV** or **NUMBER** buttons on the remote control handset to switch it on fully.
3. Press the **POWER** button on the remote control handset.
The set reverts to standby mode.
4. Press the main power button again to switch the set off.

Note : If, while the set is switched on, the mains plug is disconnected the set will switch to standby or power on when the mains plug is replaced in the mains power socket.

Programme selection

You can select a programme number with the **▲ / ▼** or **NUMBER** buttons.

Volume adjustment

Press the **◀ / ▶** button to adjust the volume.

Quick view

Press the **Q.VIEW** button to view the last programme you were watching.

Note : This function works only when **Favourite programme** is set to **Off**. Otherwise each press of this button will select a stored favorite programme.

Mute function

Press the **MUTE** button. The sound is switched off and the display  appears.

You can cancel it by pressing the **MUTE**, **◀ / ▶**, **SSM**, **I/II**, **TURBO SOUND** button.

Auto Demonstration

To review all the menus programmed in the set, press the **OK** or  button of the front panel controls for about 10 seconds. To stop auto demonstration, press any button of the front panel controls and the **POWER** button of the remote control.

On screen language selection (option)

The menu can be displayed on the screen in your desired language. First select your language.

1. Press the **MENU** button and then **▲ / ▼** button to select the Special menu.
2. Press the **▶** button and then the **▲ / ▼** button to select **Language**.
3. Press the **▶** button.
4. Press the **▲ / ▼** button to select your desired language.
5. Press the **OK** button.
All the on screen displays will appear in the selected language.
6. Repeatedly press the **MENU** button to return to normal TV viewing.

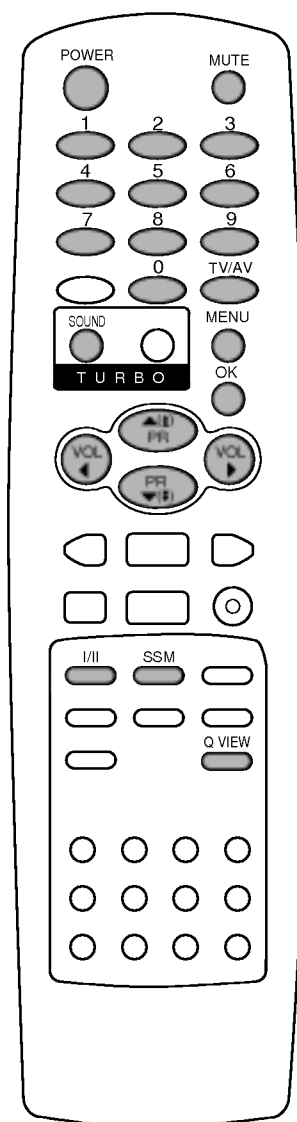

On screen menus

The dialogue between you and your set takes place on screen with an operator menu. The buttons required for the operating steps are also displayed.

Menu selection

1. Press the **MENU** button and then **▲ / ▼** button to display each menu.
2. Press the **▶** button and then **▲ / ▼** button to select a menu item.
3. Press the **▶** button to change the setting of a menu item or **OK** button to display the sub menu.

Note :

- a. In the teletext mode, menus are not displayed.
- b. In some models, the **Normal/Turbo search** will not display, only the **Start** will display in the **Auto programme** menu.
- c. In some models, **Tilt, Game, Degauss** or **Booster** will not display.
- d. In some models, the **BG, L** will display.
- e. In some models, the **Language** will not be display.

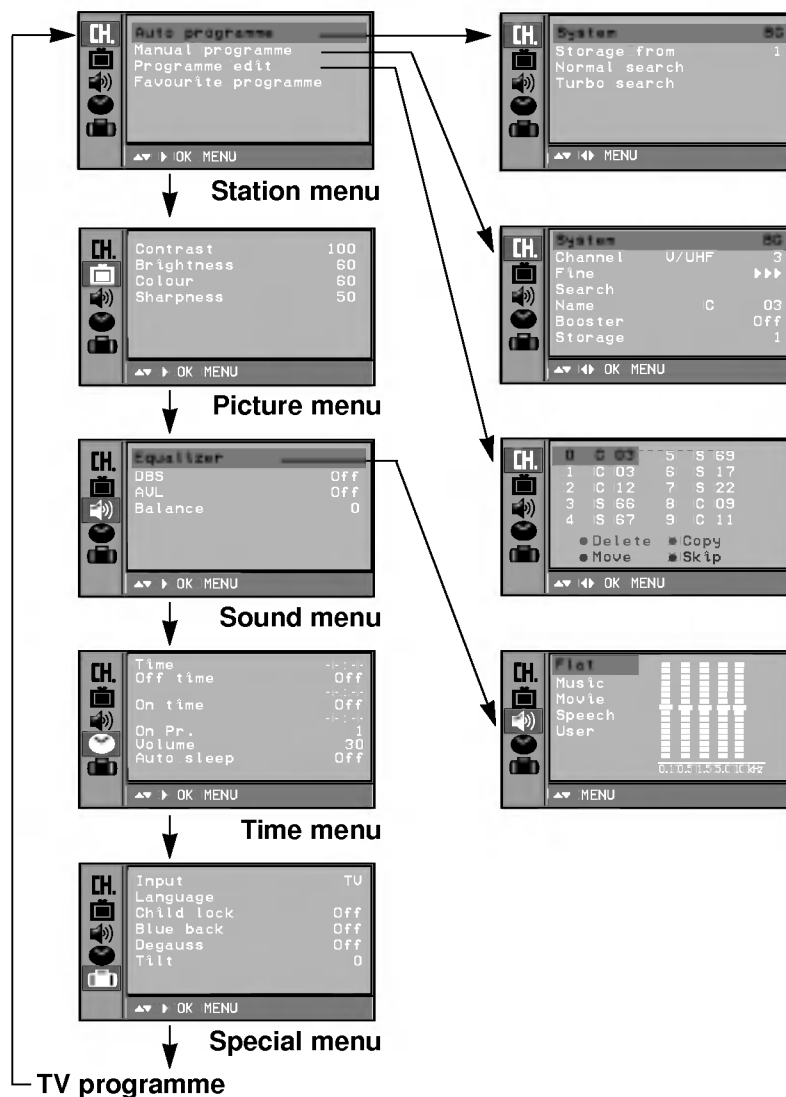
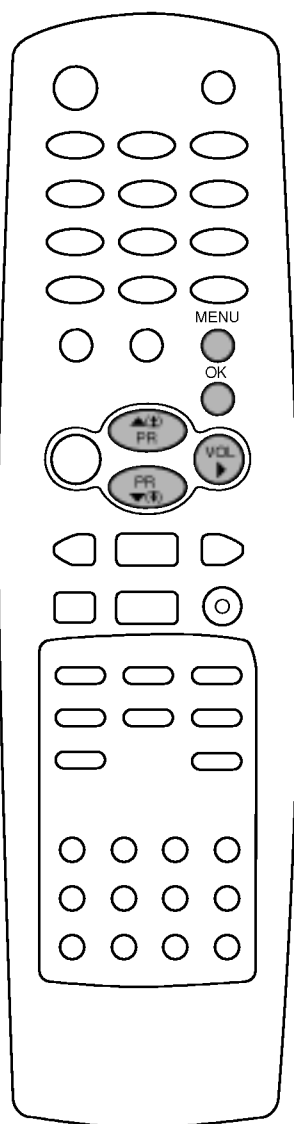

Setting up TV stations

Up to 100 TV stations can be stored in this set by programme numbers (0 to 99). Once you have preset the stations, you will be able to use the ▲ / ▼ or NUMBER buttons to scan the stations you programmed. Stations can be tuned using automatic or manual modes.

Auto programme tuning

All stations that can be received are stored by this method. It is recommended that you use auto programme during installation of this set.

1. Press the **MENU** button and then ▲ / ▼ button to select the Station menu.
2. Press the ► button and then ▲ / ▼ button to select **Auto programme**.
3. Press the ► button to display the **Auto programme** menu.



Station Menu

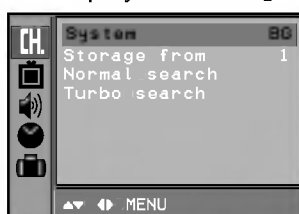

4. Press the ▲ / ▼ button to select **System**. Select a TV system with the ◀ / ▶ button;
 - L** : SECAM L/L' (France: SECAM-L models only)
 - BG** : PAL B/G, SECAM B/G (Europe/East Europe)
 - I** : PAL I/II (U.K./Ireland)
 - DK** : PAL D/K, SECAM D/K (East Europe)
5. Press the ▲ / ▼ button to select **Storage from**.
6. Select the beginning programme number with the ◀ / ▶ button or NUMBER buttons. Any number under 10 is entered with a numeric '0' in front of it, i.e. '05' for 5.
7. Press the ▲ / ▼ button to select **Normal** or **Turbo search**.

Option: In some models, you can only select **Start**.

Note :

- Turbo search** is faster than **Normal search** and in some models, these searches will automatically store all receivable stations.
 - If the programmed station has poor quality sound, select the system again in the **Manual programme** menu.
8. Press the **OK** button to begin auto programming.

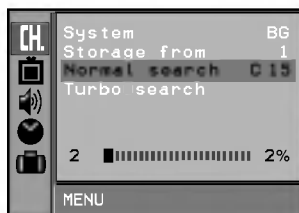

(Normal search)



(Turbo search)

All receivable stations are stored. The station name is stored for stations which broadcast VPS (Video Programme Service), PDC (Programme Delivery Control) or TELETEXT data. If no station name can be assigned to a station, the channel number is assigned and stored as **C** (V/UHF 01-69) or **S** (Cable 01-47), followed by a number.

To stop auto programming, press the **MENU** button.

When auto programming is completed, the **Programme edit** menu appears on the screen. See the 'Programme edit' section to edit the stored programme.

9. Repeatedly press the **MENU** button to return to normal TV viewing.

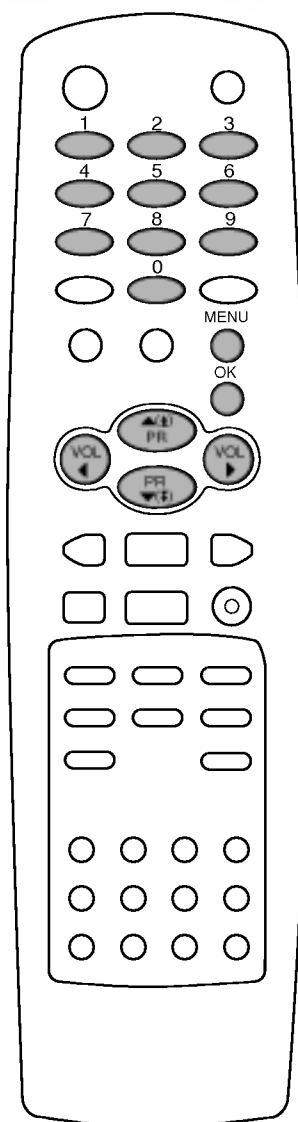

Setting up TV stations

Station Menu



Auto programme scan

To automatically scan the pictures of stored programmes, press the ▲(▲) or ▼(▼) button for about 3 seconds. The picture of stored programmes appears on the screen one by one.

To stop auto programme scanning, press any button except VCR buttons.

Manual programme tuning

Manual programme lets you manually tune and arrange the stations in whatever order you desire. Also you can assign a station name with five characters to each programme number.

1. Press the **MENU** button and then ▲ / ▼ button to select the Station menu.
2. Press the ► button and then ▲ / ▼ button to select **Manual programme**.
3. Press the ► button to display the **Manual programme** menu.

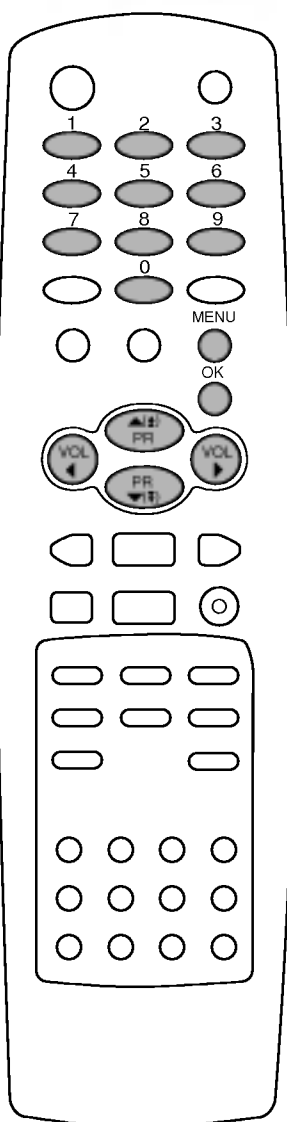

4. Press the ▲ / ▼ button to select **System**. Select a TV system with the ◀ / ▶ button;
 - L** : SECAM L/L' (France: SECAM-L models only)
 - BG** : PAL B/G, SECAM B/G (Europe/East Europe)
 - I** : PAL I/II (U.K./Ireland)
 - DK** : PAL D/K, SECAM D/K (East Europe)
5. Press the ▲ / ▼ button to select **Channel**. Press the ◀ / ▶ button to select **V/UHF** or **Cable** as required. If possible, select the channel number directly with the number buttons. Any number under 10 is entered with a numeric '0' in front of it, i.e. '05' for 5.
6. Press the ▲ / ▼ button to select **Search**. Press the ◀ / ▶ button to commence searching. If a station is found the search will stop.
7. If this station is the one required, press the ▲ / ▼ button to select **Storage**. Select the desired programme number (0 to 99) with the ◀ / ▶ button or NUMBER buttons. Any number under 10 is entered with a numeric '0' in front of it, i.e. '05' for 5.
8. Press the **OK** button to store it. The display **Stored** will appear.



9. To store another station, repeat steps 4 to 8.
10. Repeatedly press the **MENU** button to return to normal TV viewing.

Setting up TV stations

Assigning a station name

1. Repeat the 'Manual programme tuning' steps 1 to 3.
2. Press the ▲ / ▼ button to select **Name**.
3. Press the ► button. You can use a blank, +, -, the numeric **0** to **9** and the alphabet **A** to **Z**.
With the ◀ button you can select in the opposite direction.
4. Select the next position by pressing the **OK** button and then take your choice of the second character, and so on.
5. Press the ▲ / ▼ button and then **OK** button.
6. Repeatedly press the **MENU** button to return to normal TV viewing.



Booster (option)

In some models, **Booster** is an optional function. Only a set with **Booster** can perform this function.

If the reception is poor at the fringe area of TV signal, select **Booster** to **On**. When the picture condition is good, do not select **Booster** to **On**.

1. Repeat the 'Manual programme tuning' steps 1 to 3.
2. Press the ▲ / ▼ button to select **Booster**.
3. Press the ◀ / ► button to select **On** or **Off**.
4. Repeatedly press the **MENU** button to return to normal TV viewing.

Fine tuning

Normally fine tuning is only necessary if reception is poor.

1. Repeat the 'Manual programme tuning' steps 1 to 3.
2. Press the ▲ / ▼ button to select **Fine**.
3. Press the ◀ / ► button to fine tune for the best picture and sound.



4. Press the **OK** button.
5. Repeatedly press the **MENU** button to return to normal TV viewing.
The finely tuned programme will be indicated by yellow number during programme selection.

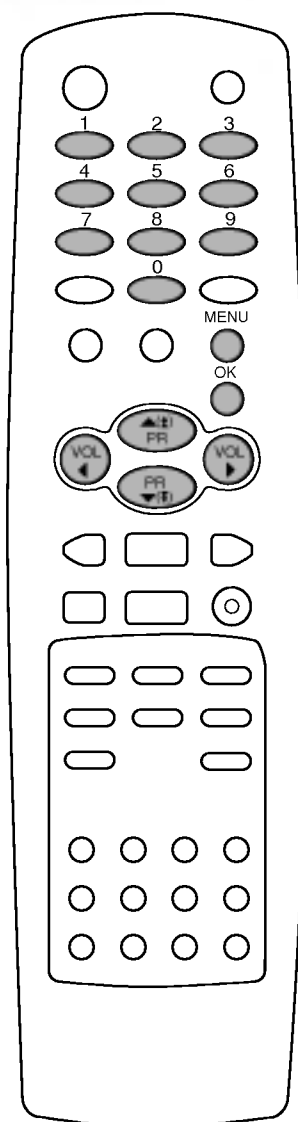

Setting up TV stations

Station Menu



Programme edit

This function enables you to delete or skip the stored programmes. Also you can move some stations to other programme numbers or insert a blank station data into the selected programme number.

1. Press the **MENU** button and then **▲ / ▼** button to select the Station menu.
2. Press the **▶** button and then **▲ / ▼** button to select **Programme edit**.
3. Press the **▶** button to display the **Programme edit** menu.



Deleting a programme

1. Select a programme to be deleted with the **▲ / ▼** or **◀ / ▶** button.
2. Press the RED button twice.
The selected programme is deleted, all the following programmes are shifted up one position.

Copying a programme

1. Select a programme to be copied with the **▲ / ▼** or **◀ / ▶** button.
2. Press the GREEN button.
All the following programmes are shifted down one position.

Moving a programme

1. Select a programme to be moved with the **▲ / ▼** or **◀ / ▶** button.
2. Press the YELLOW button.
3. Move the programme to the desired programme number with the **▲ / ▼** or **◀ / ▶** button.
4. Press the YELLOW button again to release this function.

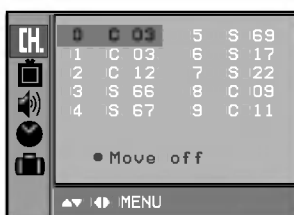

Skipping a programme number

1. Select a programme number to be skipped with the **▲ / ▼** or **◀ / ▶** button.
2. Press the BLUE button. The skipped programme turns to blue.
3. Press the BLUE button again to release the skipped programme.

When a programme number is skipped it means that you will be unable to select it using the **▲ / ▼** button during normal TV viewing. If you want to select the skipped programme, directly enter the programme number with the NUMBER buttons or select it in the programme edit or table menu.

Repeatedly press the **MENU** button to return to normal TV viewing.

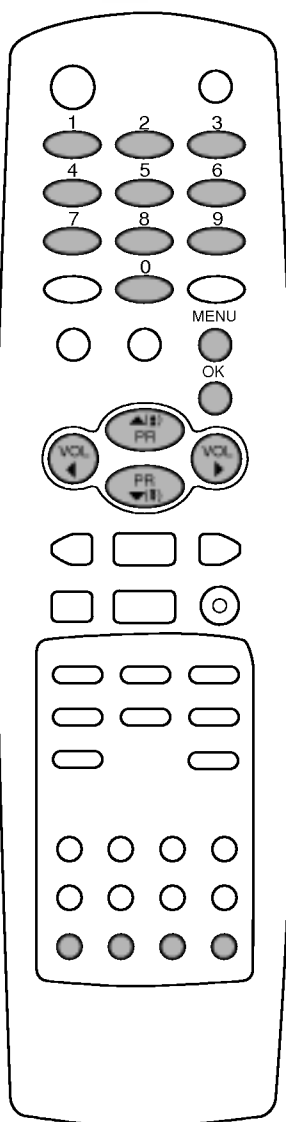

Setting up TV stations

Favourite programme

This function lets you select your favourite programmes directly.

1. Press the **MENU** button and then **▲ / ▼** button to select the Station menu.
2. Press the **▶** button and then **▲ / ▼** button to select **Favourite programme**.
3. Press the **OK** button to display the **Favourite programme** menu.



Station Menu



4. Press the **◀ / ▶** button to select **On** or **Off**.
5. Press the **▲ / ▼** button to select **--**.
6. Select a desired programme with the **◀ / ▶** button or NUMBER buttons. Any number under 10 is entered with a numeric '0' in front of it, i.e. '05' for 5.
7. To store another programme, repeat steps 5 to 6. You can store up to 5 programmes.
8. Repeatedly press the **MENU** button to return to normal TV viewing.

Repeatedly press the **Q.VIEW** button to select stored favourite programmes.

Calling the programme table

You can check the programmes stored in the memory by displaying the programme table.

Displaying programme table

Press the **LIST** button to display the **Programme table** menu.

The programme table appears on the screen. One programme table contains ten programmes as below.

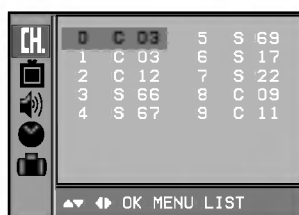

Note :

- a. You may find some blue programmes. They have been set up to be skipped by auto programming or in the programme edit mode.
- b. Some programmes with the channel number shown in the programme table indicate there is no station name assigned.

Selecting a programme in the programme table

Select a programme with the **▲ / ▼** or **◀ / ▶** button.

Then press the **OK** button.

The set switches to the chosen programme number.

Paging through a programme table

There are 10 programme table pages which contain 100 programmes.

Pressing the **▲ / ▼** or **◀ / ▶** button repeatedly turns the pages.

Repeatedly press the **MENU** button to return to normal TV viewing.

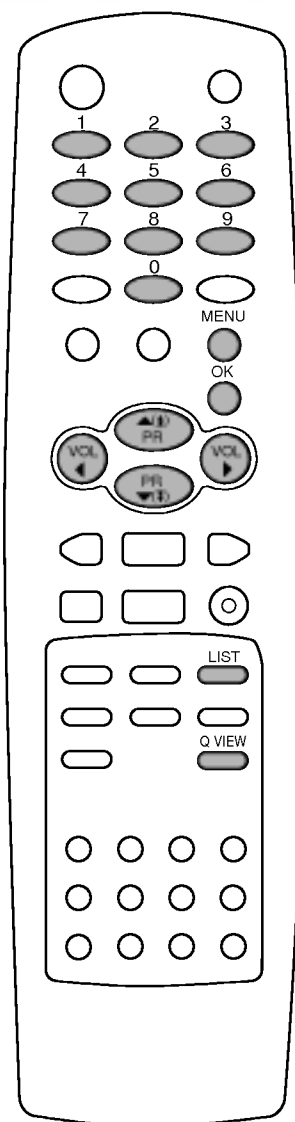

Picture adjustment

Picture Menu



Picture adjustment

You can adjust picture contrast, brightness, colour intensity, sharpness and tint (NTSC AV only) to the levels you prefer.

1. Press the **MENU** button and then **▲ / ▼** button to select the Picture menu.
2. Press the **▶** button and then **▲ / ▼** button to select the desired picture item.
3. Press the **◀ / ▶** button to make appropriate adjustments, then it will be stored for the picture **User**.



4. Repeatedly press the **MENU** button to return to normal TV viewing.

To recall your preferred setting, press the **PSM** button until the desired picture (**Dynamic**, **Standard**, **Mild**, **Game** or **User**) appears. The picture **Dynamic**, **Standard**, **Mild** and **Game** are programmed for good picture reproduction at the factory and cannot be changed.

Eye (option)

Eye is an optional function. Only a set with eye option can perform this function.

In some models, the set will automatically adjust the picture according to the surrounding conditions. This will enable you to enjoy the most suitable picture according to the surroundings.

Press the **EYE/★** button to switch the eye function on or off.

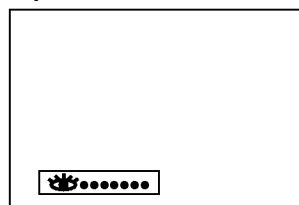
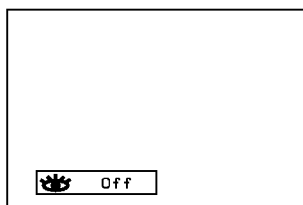

When the eye function is on, the most suitable picture is automatically adjusted according to the surrounding conditions.

At this time the display **●●●●●** in green does not appear continuously but the display **●●●●●** in yellow appears each time the picture condition changes.

Note : If you press the **PSM** or **TURBO PICTURE** button with the eye function, the eye function is automatically switched off.

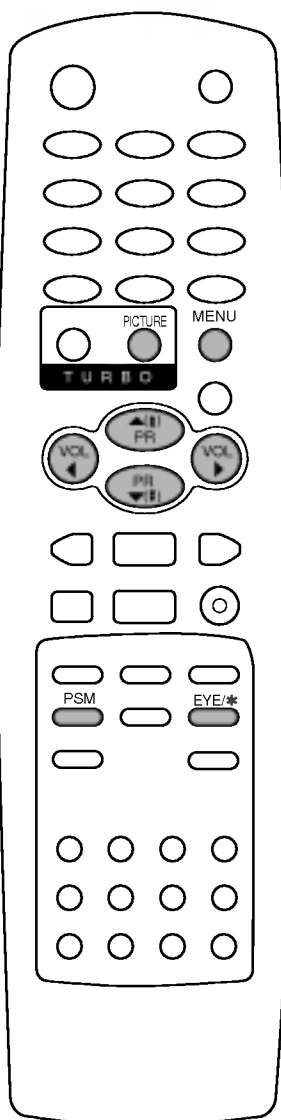

Picture adjustment

Picture format

You can watch TV in various picture formats; Standard, 16:9 (Wide), Zoom.

RE/RL-28/32FZ10 series picture formats; 4:3, Auto, 16:9, 14:9 and Zoom.

Repeatedly press the **ARC** button to select your desired picture format.

Standard (or 4:3)

This picture format is 4 to 3 of general TV.

Auto

When your TV receives the wide screen signal, it will be automatically changed to the picture format to be sent.

16:9

You can enjoy the cinema (the picture format of 16:9) or general TV programme through the 16:9 mode.

The screen 16:9 is viewed just like that but the screen 4:3 is magnified to the left and right so that the screen 16:9 is full.

14:9

The screen 14:9 is viewed just like that but the screen 4:3 is magnified to the upper / lower and left / right so that the screen 14:9 is full.

You can move the screen up or down with ▲ / ▼ button.

Zoom

You can enjoy the cinema in a vast screen through the Zoom mode. The screen 4:3 is magnified to the upper/lower and left/right sides so that the screen 16:9 is full. The bottom and top of the picture may be lost. (option : RE/RL-28/32FZ10 series - You can move the screen up or down with ▲ / ▼ button.)

Note :

- When you switch the set to standby or off, the **16:9** or **Zoom** picture format is reset to the **Standard** (4:3).
- In the 1/2 size sub picture and vertical four sub pictures of PIP mode the picture format is not available.

Turbo picture selection (option)

When this function is on, the picture will be more brilliant and distinct picture than normal picture.

Repeatedly press the **TURBO PICTURE** button to switch on or off.



(Turbo Picture off)



(Turbo Picture on)

Note : If you press the **PSM** or **EYE/★** button with the Turbo picture function, the Turbo picture function is automatically switched off.

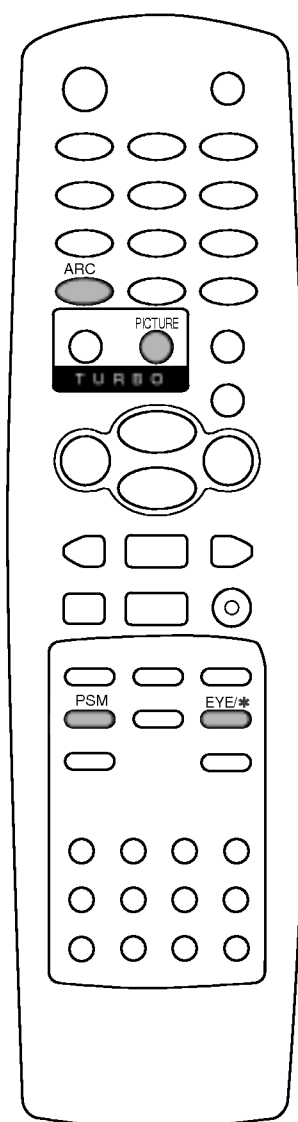

Sound adjustment

Sound Menu



Sound adjustment

You can select your preferred sound setting; Flat, Music, Movie or Speech and you can also adjust the sound frequency of equalizer, balance. If you switch DBS to on, the set creates a dynamic bass sound. If you switch AVL to on, the set automatically keeps on an equal volume level even if you change programmes.

1. Press the **MENU** button and then **▲ / ▼** button to select the Sound menu.
2. Press the **▶** button and then **▲ / ▼** button to select the desired sound item; **Equalizer**, **DBS**, **AVL** or **Balance**.
3. Press the **◀ / ▶** button to make desired adjustment. Press the **OK** button in **Equalizer** to set the **Equalizer User**.



- a. Select **User** by pressing the **▲ / ▼** button.
- b. Select a sound band by pressing the **◀ / ▶** button.
- c. Make appropriate sound level with the **▲ / ▼** button.
- d. Press the **OK** button to store it for the sound **User**. The display **Stored** appears.

4. Repeatedly press the **MENU** button to return to normal TV viewing.

To recall your preferred setting, press the **SSM** button until the desired sound (**Flat**, **Music**, **Movie**, **Speech** or **User**) appears. The sound **Flat**, **Music**, **Movie** and **Speech** are programmed for good sound reproduction at the factory and cannot be changed.

Note : If you press the **SSM** button after making appropriate adjustment in Sound menu, the display **User** automatically appears even though you have already set a factory preset setting; **Flat**, **Music**, **Movie** or **Speech**.

Turbo sound selection (option)

When this function is on, the sound will be more emphasized and amplified than normal sound. Repeatedly press the **TURBO SOUND** button to switch on or off.



(Turbo Sound off)



(Turbo Sound on)

Sound adjustment

Stereo/Dual reception

When a programme is selected, the sound information for the station appears after the programme number and station name disappear.

Broadcast	On Screen Display
Mono	MONO
Stereo	STEREO
Dual	DUAL I

Mono sound selection

In stereo reception if the stereo signal is weak, you can switch to mono by pressing the **I/II** button twice. In mono reception the depth of sound is improved. To switch back to stereo, press the **I/II** button twice again.

Language selection for dual language broadcast

If a programme received in two languages (dual language), you can switch to **DUAL I**, **DUAL II** or **DUAL I+II** by pressing the **I/II** button repeatedly.

DUAL I sends the primary broadcast language to the loudspeakers.

DUAL II sends the secondary broadcast language to the loudspeakers.

DUAL I+II sends a separate language to each loudspeaker.

NICAM reception (option)

If your set is equipped with the receiver for NICAM reception, the high quality NICAM (Near Instantaneous Companding Audio Multiplex) digital sound can be received.

Sound output can be selected according to the type of received broadcast as follows by pressing the **I/II** button repeatedly.

1. When NICAM mono is received, you can select **NICAM MONO** or FM MONO.
2. When NICAM stereo is received, you can select **NICAM STEREO** or FM MONO. If the stereo signal is weak, switch to FM mono.
3. When NICAM dual is received, you can select **NICAM DUAL I**, **NICAM DUAL II** or **NICAM DUAL I+II** or **MONO**. When FM mono is selected the display **MONO** appears on the screen.

Sound output selection

In AV mode, you can select output sound for the left and right loudspeakers.

Repeatedly press the **I/II** button to select the sound output.

L+R : Audio signal from audio L input is sent to left loud-speaker and audio signal from audio R input is sent to right loud-speaker.

L+L : Audio signal from audio L input is sent to left and right loudspeakers.

R+R : Audio signal from audio R input is sent to left and right loudspeakers.

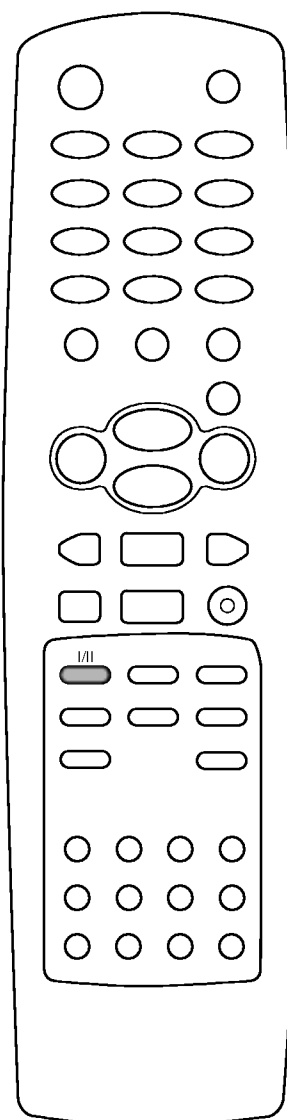

Time setting

Time Menu



Time

The time uses the 24 hour system and must be set to the correct time before operating the set.

1. Press the **MENU** button and then **▲ / ▼** button to select the Time menu.
2. Press the **▶** button and then **▲ / ▼** button to select **Time**.
3. Select and adjust hour and minute by pressing the **◀ / ▶** button or number buttons.
4. Repeatedly press the **MENU** button to return to normal TV viewing.

On/off time

By using this function in **On** mode, the set automatically switches on or off at a preset time. You must set the time correctly before using on/off time function.

1. Press the **MENU** button and then **▲ / ▼** button to select the Time menu.
2. Press the **▶** button and then **▲ / ▼** button to select **On time** or **Off time**.
3. Press the **◀ / ▶** button to select **On** or **Off**.
4. Press the **▼** button.
5. Select and adjust hour and minute by pressing the **◀ / ▶** button or number buttons.
6. Repeatedly press the **MENU** button to return to normal TV viewing.

On Programme number

By using this function, the set automatically switches on at a preset programme.

1. Press the **MENU** button and then **▲ / ▼** button to select the Time menu.
2. Press the **▶** button and then **▲ / ▼** button to select **On Pr.**
3. Select and adjust programme number by pressing the **◀ / ▶** button or number buttons.
4. Repeatedly press the **MENU** button to return to normal TV viewing.

Volume

By using this function, the set automatically switches on at a preset volume size.

1. Press the **MENU** button and then **▲ / ▼** button to select the Time menu.
2. Press the **▶** button and then **▲ / ▼** button to select **Volume**.
3. Select and adjust volume by pressing the **◀ / ▶** button or number buttons.
4. Repeatedly press the **MENU** button to return to normal TV viewing.

Auto sleep

If you select **Auto sleep On** the set will automatically switch itself to standby mode approximately ten minutes after a TV station stops broadcasting.

1. Press the **MENU** button and then **▲ / ▼** button to select the Time menu.
2. Press the **▶** button and then **▲ / ▼** button to select **Auto sleep**.
3. Press the **◀ / ▶** button to select **On**.
4. Repeatedly press the **MENU** button to return to normal TV viewing.

Note :

- a. This function works only in standby mode.
- b. To cancel the set on/off time, set the on/off timer to --:--.
- c. To view the remaining on/off time, select the Time menu.
- d. When you switch the main power off, the **Time** is reset and the **On/Off time** is off.
- e. Two hours after the set is switched on by the on time function it will automatically switch back to standby mode unless a button has been pressed.
- f. Once the on or off time is set, these functions operate daily at the preset time.

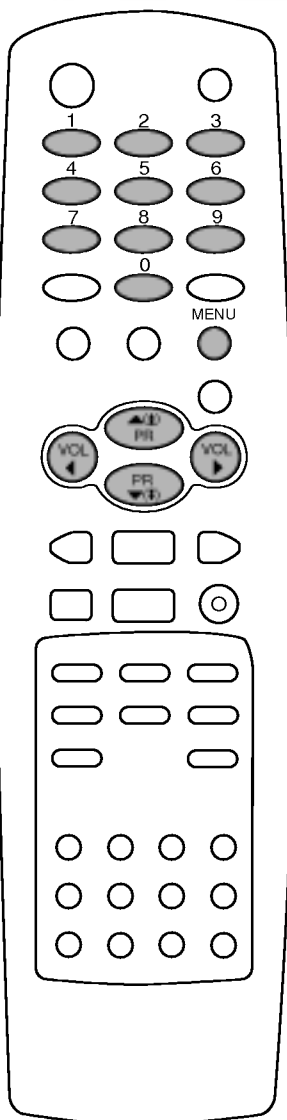

Other functions

TV and AV modes

Inputs can be set for TV or AV mode. AV mode is used when a video cassette recorder (VCR), or other equipment is connected to the set.

Note : When a VCR is connected via the aerial socket the set is used in TV mode. See the 'Connection of external equipment' section.

1. Press the **MENU** button and then **▲ / ▼** button to select the Special menu.
2. Press the **▶** button and then **▲ / ▼** button to select **Input**.
3. Press the **◀ / ▶** button to select **TV**, **AV 1**, **AV 2**, **AV 3** (or **S-Video**), **Component** (option).

The AV modes are :

AV1 : VCR connected to the Euro scart socket 1 of the set

AV2 : VCR connected to the Euro scart socket 2 of the set

AV3 : VCR connected to the **AV3** sockets of the set

S-Video : S-VIDEO VCR connected to the **S-VIDEO** sockets of the set (option).

COMPONENT : COMPONENT connected to the **COMPONENT INPUT** sockets on the set (option).

To return to TV mode, press the **▲ / ▼** or **NUMBER** buttons.

Alternatively you can select the TV or AV mode by pressing the **TV/AV** button.

Auto AV switching (option)

If your VCR outputs an AV switching voltage when connected to the Euro scart socket, the set will switch to **AV 1** or **AV 2** mode automatically. But if you want to keep on watching in TV mode, press the **▲ / ▼** or **NUMBER** buttons. Press the **TV/AV** button to return to AV modes.

Child lock

The TV can be set so that the remote control handset is needed to control it. This feature can be used to prevent unauthorized viewing.

1. Press the **MENU** button and then **▲ / ▼** button to select the Special menu.
2. Press the **▶** button and then **▲ / ▼** button to select **Child lock**.
3. Press the **◀ / ▶** button on the remote control handset to select **On**.
4. Repeatedly press the **MENU** button to return to normal TV viewing.

With the lock on, the display **Child lock on** appears on the screen if any button on the front panel is pressed while viewing the TV.

Note : The display **Child lock on** will not appear on the screen if any button on the front panel is pressed while displaying the menus.

Blue back

If you select **Blue back On**, the blue background appears on the screen when there is no or poor signal.

1. Press the **MENU** button and then **▲ / ▼** button to select the Special menu.
2. Press the **▶** button and then **▲ / ▼** button to select **Blue back**.
3. Press the **◀ / ▶** button to select **On** or **Off**.
4. Repeatedly press the **MENU** button to return to normal TV viewing.



Special Menu

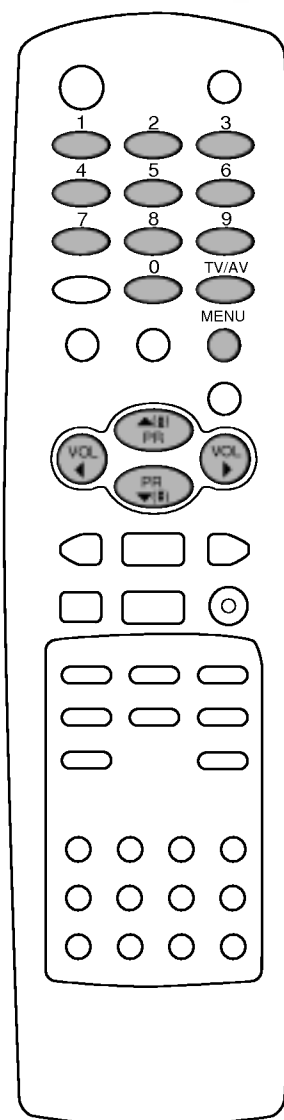

Other functions

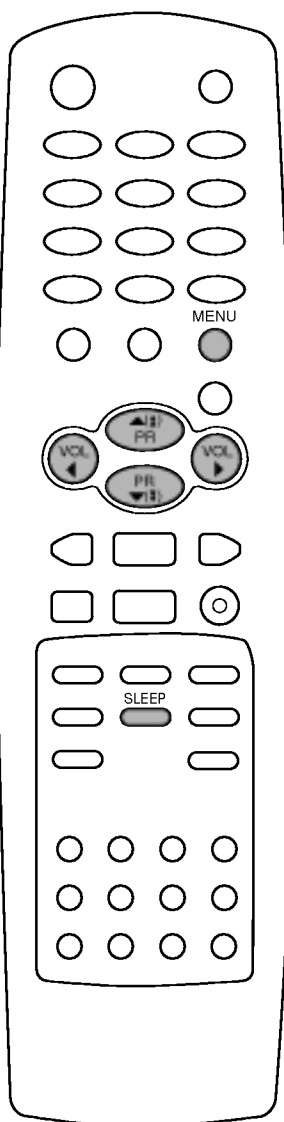

Degaussing

Owing to the super large Tube used in the set. The colour purity of the picture may be affected by other magnetic influences such as speakers. Stripes may appear on the screen or there may be colour patches.

You can restore high colour quality by operating the Degaussing function.

1. Press the **MENU** button and then **▲ / ▼** button to select the Special menu.
2. Press the **▶** button and then **▲ / ▼** button to select **Degauss**.
3. Press the **◀ / ▶** button to select **On**. After the degauss function works, **On** mode switches to **Off** mode.
4. Repeatedly press the **MENU** button to return to normal TV viewing.

Note : If you cannot adjust the screen condition by degaussing, try it again after about 4 minutes.

Tilt (option)

The TV picture may tilt to the left or right if the TV set moves to another position. This function can be used to compensate the tilt.

1. Press the **MENU** button and then **▲ / ▼** button to select the Special menu.
2. Press the **▶** button and then **▲ / ▼** button to select **Tilt**.
3. Press the **◀ / ▶** button to adjust the tilt.
4. Repeatedly press the **MENU** button to return to normal TV viewing.

Sleep timer

You don't have to remember to switch the set off before you go to sleep. The sleep timer automatically switches the set to standby after the preset time has elapsed.

Press the **SLEEP** button to select the number of minutes. The display **⌚ 0** will appear on the screen, followed by **10, 20, 30, 60, 90, 120, 180** and **240**. The timer begins to count down from the number of minutes selected.

Note :

- a. To view the remaining sleep time, press the **SLEEP** button once.
- b. To cancel the sleep time, repeatedly press the **SLEEP** button until the display **⌚ 0** appears.
- c. When you switch the set off, the set releases the preset sleep time.

Teletext (option)

Teletext (or TOP text) is an optional function, therefore only a set with the teletext system can receive the teletext broadcast.

Teletext is a free service broadcast by most TV stations which gives up-to-the-minute information on news, weather, television programmes, share prices and many other topics.

The teletext decoder of this TV can support the SIMPLE, TOP and FASTEXT systems. SIMPLE (standard teletext) consists of a number of pages which are selected by directly entering the corresponding page number. TOP and FASTEXT are more modern methods allowing quick and easy selection of teletext information.

Switch on/off

Press the **TEXT** button to switch to teletext.

If TV and text picture are displayed half and half of the screen, press the **TEXT** button again to display text picture fully.

The initial page or last page appears on the screen.

Two page numbers, TV station name, date and time are displayed on the screen headline. The first page number indicates your selection, while the second shows the current page displayed.

Press the **TEXT** or **TV/AV** button to switch off teletext. The previous mode reappears.

SIMPLE text

Page selection

1. Enter the desired page number as a three digit number with the **NUMBER** buttons. If during selection you press a wrong number, you must complete the three digit number and then re-enter the correct page number.
2. The **▲ / ▼** button can be used to select the preceding or following page.

Programming a colour button in LIST mode

If the TV is in SIMPLE text, TOP text or FASTEXT mode, press the **≡M** button to switch to LIST mode.

Four teletext page numbers of your choice can be colour coded and easily selected by pressing the corresponding coloured button on the remote control handset.

1. Using the **NUMBER** buttons, select the page you wish to programme.
2. Wait until the page is displayed on the screen and press the **OK** button. The page numbers in the colour boxes along the bottom of the screen change to "000?".
3. Press a colour button to store the page number. From now on, you can select this page with the same coloured button.
4. The three other coloured buttons are programmed in the same way.

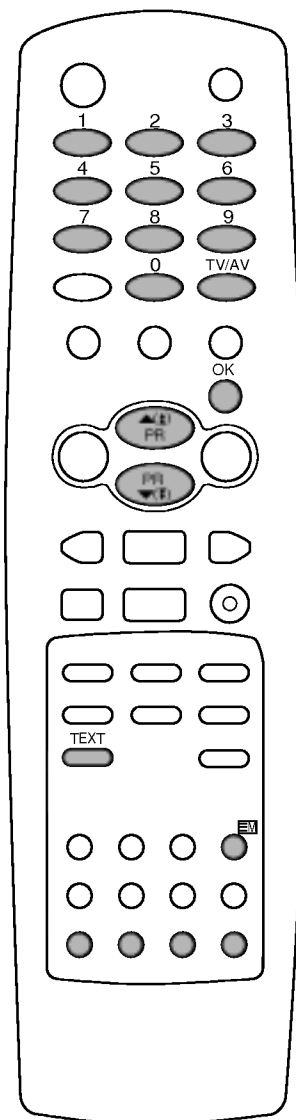

Teletext (option)

TOP text (option)

The user guide displays four fields-red, green, yellow and blue at the bottom of the screen. The yellow field denotes the next group and the blue field indicates the next block.

Block / group / page selection

1. With the blue button you can progress from block to block.
2. Use the yellow button to proceed to the next group with automatic overflow to the next block.
3. With the green button you can proceed to the next existing page with automatic overflow to the next group.
Alternatively the ▲ button can be used.
4. The red button permits to return to previous selection.
Alternatively the ▼ button can be used.

Direct page selection

Corresponding to the SIMPLE teletext mode, you can select a page by entering it as a three digit number using the NUMBER buttons in TOP mode.

FASTEXT

The teletext pages are colour coded along the bottom of the screen and are selected by pressing the corresponding coloured button.

Page selection

1. Press the  button to select the index page.
2. You can select the pages which are colour coded along the bottom line with the same coloured buttons.
3. Corresponding to the SIMPLE teletext mode, you can select a page by entering its three digit page number with the NUMBER buttons in FASTEXT mode.
4. The ▲ / ▼ button can be used to select the preceding or following page.

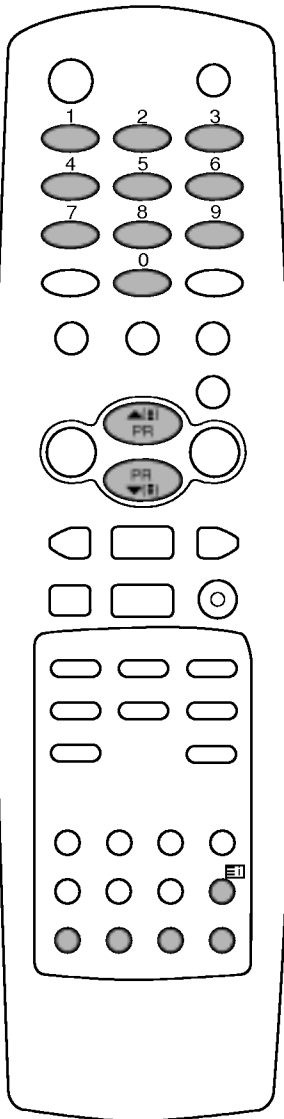

Teletext (option)

Special teletext functions



REVEAL

Press this button to display concealed information, such as solutions of riddles or puzzles.

Press this button again to remove the information from the display.



SIZE

Selects double height text.

Press this button to enlarge the top half of the page.

Press this button again to enlarge the bottom half of the page.

Press this button again to return to the normal display.



UPDATE

Displays the TV picture on the screen while waiting for the new teletext page. The display **TEXT** will appear at the top left hand corner of the screen. When the updated page is available then display **TEXT** will change to the page number.

Press this button to view the updated teletext page.



HOLD

Stops the automatic page change which will occur if a teletext page consists of 2 or more sub pages. The number of sub pages and the sub page displayed is, usually, shown on the screen below the time. When this button is pressed the stop symbol is displayed at the top left-hand corner of the screen and the automatic page change is inhibited.

To continue press this button again.



MIX

Displays the teletext pages superimposed on the TV picture.

To switch the TV picture off press this button again.

Note : When TV and text picture are displayed half and half of the screen, MIX function is not available.



TIME

When viewing a TV programme, press this button to display the time at the top right hand corner of the screen. Press this button again to remove the display. In the teletext mode, press this button to select a sub page number. The sub page number is displayed at the bottom of the screen. To hold or change the sub page, press the RED/GREEN, ▲ / ▼ or NUMBER buttons.

Press again to exit this function.

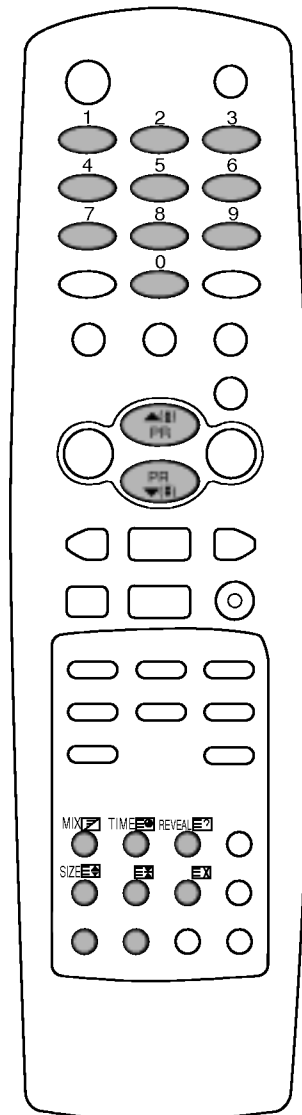

Connection of external equipment

You can connect additional equipment, such as VCRs, camcorders etc. to your set.

Here shown may be somewhat different from your set.

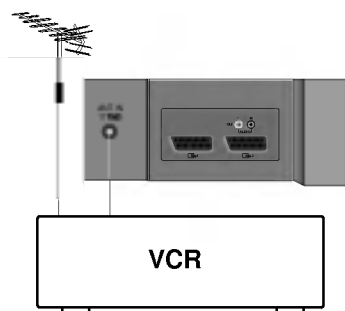

Aerial socket

1. Connect the RF out socket of the VCR to the aerial socket on the back of the set.
2. Connect the aerial cable to the RF aerial in socket of the VCR.
3. Store the VCR channel on the programme number 0 using the 'Manual programme tuning' section.
4. Select the programme number where the VCR channel is stored.
5. Press the **PLAY** button on the VCR.

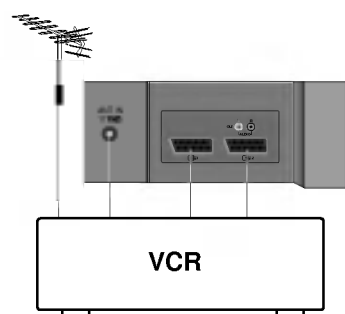

Euro scart sockets

1. Connect the Euro scart socket of the VCR to the Euro scart socket 1 or 2 of the set.
2. Press the **PLAY** button on the VCR.
If your VCR outputs a switching voltage when connected to Euro scart socket 1 or 2, the set will switch to **AV 1** or **AV 2** mode automatically. But if you want to keep on watching TV mode, press the **▲ / ▼** or **NUMBER** buttons.

Otherwise press the **TV/AV** button on the remote control handset to select **AV 1** or **AV 2**. The VCR playback picture appears on the screen.

You can also record programmes received by the TV on video tape.

Note :

- a. Signal type RGB, i.e. the signals red, green and blue can only be selected for the Euro scart socket 1. These signals are transmitted, for example, pay TV decoder, game machine or photo CD unit, etc.
- b. If both Euro scart 1 and 2 sockets have been connected to the VCRs simultaneously, only the **AV 2** can be received.

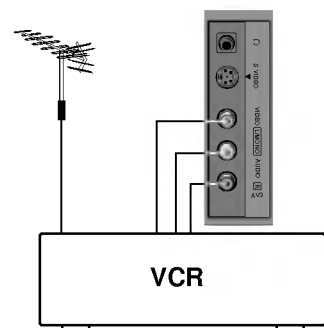

Audio/Video in sockets (option)

1. Connect the audio/video out sockets of the VCR to audio/video in sockets of the set.
2. Press the **TV/AV** button to select **AV 3**.
3. Press the **PLAY** button on the VCR.
The VCR playback picture appears on the screen.

Note : If you have a mono VCR, connect the audio cable from the VCR to the **AUDIO L/MONO** socket of the set.

Connection of external equipment

Audio out sockets (AUDIO OUT) (option)

The phono sockets for a Hi-Fi amplifier system are on the back of the set; L=left sound channel, R=right sound channel.

If you connect an amplifier system, you can also play the TV sound through the stereo amplifier system. If you press the **MUTE** button, only the sound of the TV's speakers are switched off.

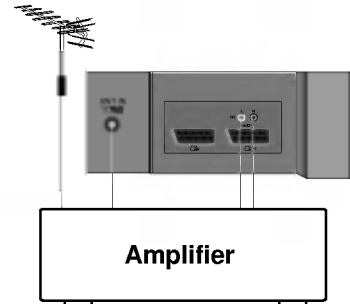

S-video / Audio in sockets (S-AV) (option)

When connecting an S-VIDEO VCR to the S-VIDEO socket, the picture quality will be further improved.

1. Connect the S-video socket of the VCR to the S-VIDEO socket of the set.
2. Connect the audio cable from the S-VIDEO VCR to the AUDIO sockets of the set.
3. Select **AV3** by pressing the **TV/AV** button repeatedly.
4. Press the **PLAY** button on the VCR.
The VCR playback picture appears on the screen.

Note : If both *S-VIDEO* and *VIDEO* sockets have been connected to the *S-VHS* VCR simultaneously, only the *S-VIDEO* can be received.

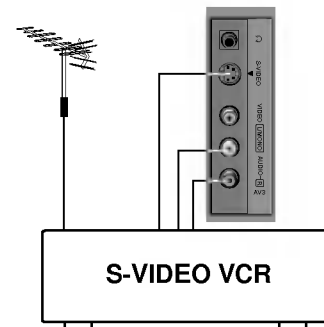

Headphone socket (option)

Only models which have a headphone socket can perform this function.

Insert the headphone plug to the headphone socket of the set.

You can listen to the sound through the headphones. To adjust the headphone volume, press the ◀ / ▶ button.

If you press the **MUTE** button, the sound from the headphone's is switched off.

