



website <http://www.lgservice.com>

LG

LG Room Air Conditioner

OWNER'S MANUAL

MODELS: SP2 Chassis

Prior to installation, this air-conditioning unit must be submitted for approval by the utility service which provides electricity (EN 61000-2, EN 61000-3 Norm).

ENGLISH

ITALIANO

ESPAÑOL

FRANÇAIS

DEUTSCH

GREEK

IMPORTANT

- Please read this owner's manual carefully and thoroughly before installing and operating your room air conditioner.
- Please retain this owner's manual for future reference after reading it thoroughly.

TABLE OF CONTENTS

Safety Precautions	3
Prior to Operation	9
Introduction	10
Electrical Safety	11
Operating Instructions.....	13
Maintenance and Service	27



FOR YOUR RECORDS

Write the model and serial numbers here:

Model # _____

Serial # _____

You can find them on a label on the side of each unit.

Dealer's Name _____

Date Purchased _____

■ Staple your receipt to this page in the event you need it to prove date of purchase or for warranty issues.



READ THIS MANUAL

Inside you will find many helpful hints on how to use and maintain your air conditioner properly. Just a little preventive care on your part can save you a great deal of time and money over the life of your air conditioner.

You'll find many answers to common problems in the chart of troubleshooting tips. If you review our chart of

Troubleshooting Tips first, you may not need to call for service at all.



PRECAUTION

- Contact the authorized service technician for repair or maintenance of this unit.
- Contact the installer for installation of this unit.
- The air conditioner is not intended for use by young children or invalids without supervision.
- Young children should be supervised to ensure that they do not play with the air conditioner.
- When the power cord is to be replaced, replacement work shall be performed by authorized personnel only using only genuine replacement parts.
- Installation work must be performed in accordance with the National Electric Code by qualified and authorized personnel only.



Safety Precautions



To prevent the injury of the user or other people and property damage, the following instructions must be followed.

- Incorrect operation due to ignoring instruction will cause harm or damage. The seriousness is classified by the following indications.

⚠ WARNING This symbol indicates the possibility of death or serious injury.

⚠ CAUTION This symbol indicates the possibility of injury or damage to properties only.

- The meanings of the symbols used in this manual are as shown below.

	Be sure not to do.
	Be sure to follow the instruction.

⚠ WARNING

■ Installation

Do not use damaged power cords, plugs, or a loose socket.

- There is risk of fire or electric shock.

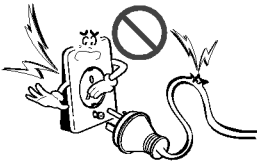

For electrical work, contact the dealer, seller, a qualified electrician, or an Authorized Service Center.

- There is risk of fire or electric shock.

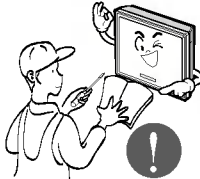

Always use the power plug and socket with the ground terminal.

- There is risk of electric shock.

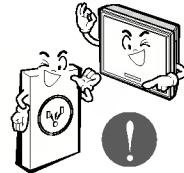

Install the panel and the cover of control box securely.

- There is risk of fire or electric shock.

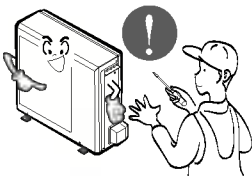

Do not modify or extend the power cord.

- There is risk of fire or electric shock.

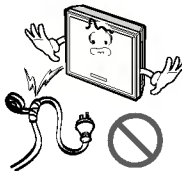

Do not install, remove, or re-install the unit by yourself (customer).

- There is risk of fire, electric shock, explosion, or injury.

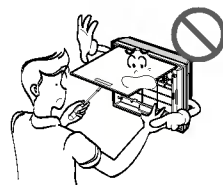

Be cautious when unpacking and installing the product.

- Sharp edges could cause injury. Be especially careful of the case edges and the fins on the condenser and evaporator.

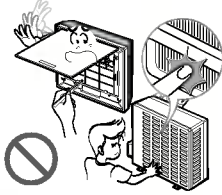

For installation, always contact the dealer or an Authorized Service Center.

- There is risk of fire, electric shock, explosion, or injury.



Do not install the product on a defective installation stand.

- It may cause injury, accident, or damage to the product.

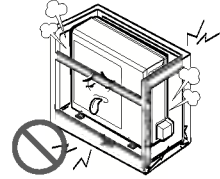

Be sure the installation area does not deteriorate with age.

- If the base collapses, the air conditioner could fall with it, causing property damage, product failure, and personal injury.

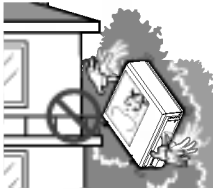

Do not let the air conditioner run for a long time when the humidity is very high and a door or a window is left open.

- Moisture may condense and wet or damage furnishings.



■ Operation

Take care to ensure that power cords could not be pulled out or damaged during operation.

- There is risk of fire or electrical shock.

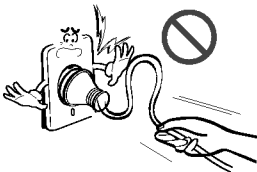

Do not place anything on the power cord.

- There is risk of fire or electric shock.

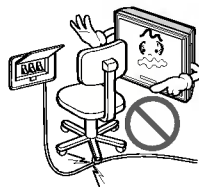

Do not turn the air-conditioner ON or OFF by plugging or unplugging the power plug.

- There is risk of fire or electrical shock.

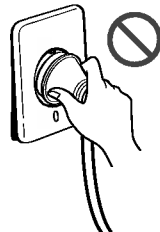

Use a dedicated outlet for this appliance.

- There is risk of fire or electrical shock.

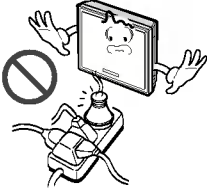

Grasp the plug to remove the cord from the outlet. Do not touch it with wet hands.

- There is risk of fire or electrical shock.



Do not place a heater or other appliances near the power cable.

- There is risk of fire and electric shock.

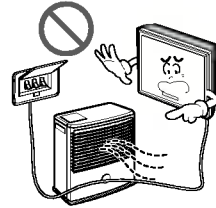

Do not allow water to run into electric parts.

- It may cause There is risk of fire, failure of the product, or electric shock.

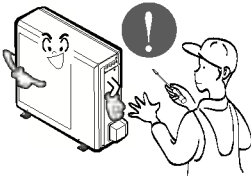

Do not store or use flammable gas or combustibles near the air conditioner.

- There is risk of fire or failure of product.

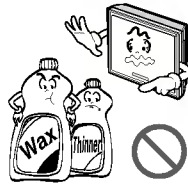

Do not use the product in a tightly closed space for a long time.

- Oxygen deficiency could occur.

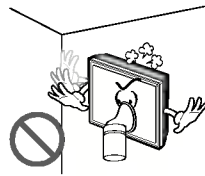

When flammable gas leaks, turn off the gas and open a window for ventilation before turn the product on. DO NOT use the telephone or turn switches on or off.

- There is risk of explosion or fire.

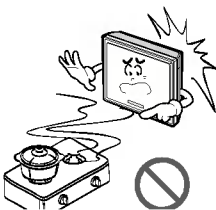

Unplug the unit if strange sounds, odors, or smoke comes from it.

- There is risk of electrical shock or fire



Stop operation and close the window in storm or hurricane. If possible, remove the air conditioner from the window before the hurricane arrives.

- There is risk of property damage, failure of product, or electric shock.

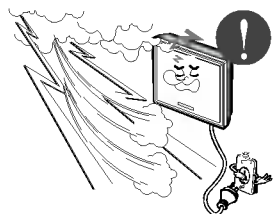

Do not open the inlet grill of the product during operation. (Do not touch the electrostatic filter, if the unit is so equipped.)

- There is risk of physical injury, electric shock, or product failure.

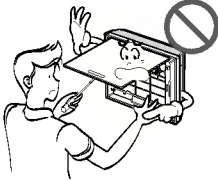

When the product is soaked (flooded or submerged), contact an Authorized Service Center.

- There is risk of fire or electric shock.



Ventilate the product from time to time when operating it together with a stove, etc.

- There is risk of fire or electrical shock.

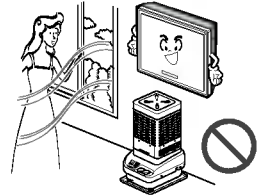

Unplug the appliance before performing cleaning or maintenance.

- There is risk of electrical shock.

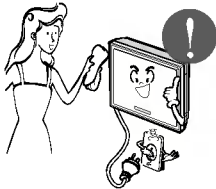

When the product is not be used for a long time, disconnect the power supply plug or turn off the breaker.

- There is risk of product damage or failure, or unintended operation.

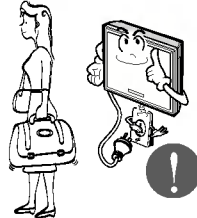

Take care to ensure that nobody could step on or fall onto the outdoor unit.

- This could result in personal injury and product damage.

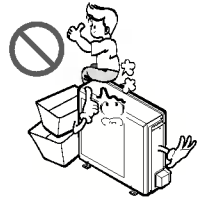

⚠ CAUTION

■ Installation

Always check for gas (refrigerant) leakage after installation or repair of product.

- Low refrigerant levels may cause failure of product.

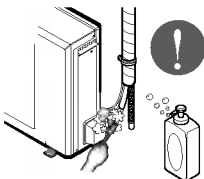

Install the drain hose to ensure that water is drained away properly.

- A bad connection may cause water leakage.

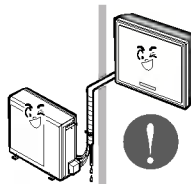

Keep level even when installing the product.

- To avoid vibration or water leakage.

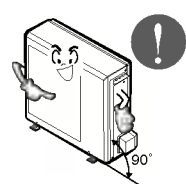

Do not install the product where the noise or hot air from the outdoor unit could damage the neighborhoods.

- It may cause a problem for your neighbors.

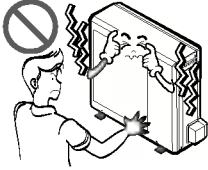

Use two or more people to lift and transport the air conditioner.

- Avoid personal injury.

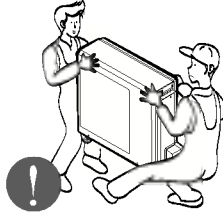

Do not install the product where it will be exposed to sea wind (salt spray) directly.

- It may cause corrosion on the product. Corrosion, particularly on the condenser and evaporator fins, could cause product malfunction or inefficient operation.

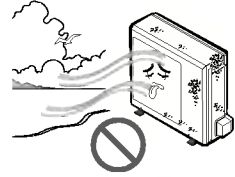

■ Operation

Do not direct airflow at room occupants. (Don't sit in the draft.)

- This could damage your health.



Do not use the product for special purposes, such as preserving foods, works of art, etc. It is a consumer air conditioner, not a precision refrigeration system.

- There is risk of damage or loss of property.

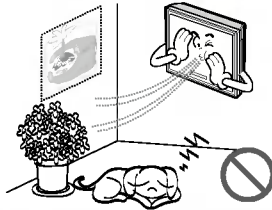

Do not block the inlet or outlet of air flow.

- It may cause product failure.

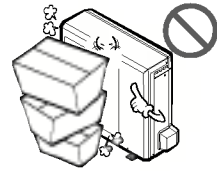

Use a soft cloth to clean. Do not use harsh detergents, solvents, etc.

- There is risk of fire, electric shock, or damage to the plastic parts of the product.

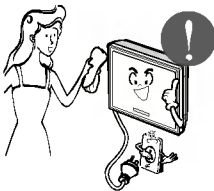

Do not touch the metal parts of the product when removing the air filter. They are very sharp!

- There is risk of personal injury.

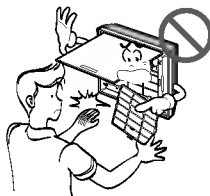

Do not step on or put anything on the product. (outdoor units)

- There is risk of personal injury and failure of product.

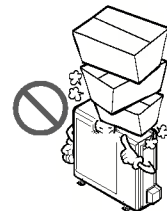

Always insert the filter securely. Clean the filter every two weeks or more often if necessary.

- A dirty filter reduces the efficiency of the air conditioner and could cause product malfunction or damage.

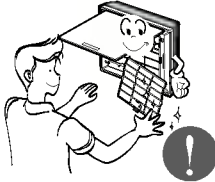

Do not insert hands or other objects through the air inlet or outlet while the air conditioner is plugged in.

- There are sharp and moving parts that could cause personal injury.

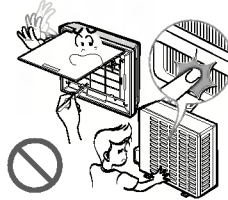

Do not drink the water drained from the unit.

- It is not sanitary and could cause serious health issues.



Use a firm stool or ladder when cleaning or maintaining the air conditioner.

- Be careful and avoid personal injury.



Replace the all batteries in the remote control with new ones of the same type. Do not mix old and new batteries or different types of batteries.

- There is risk of fire or explosion

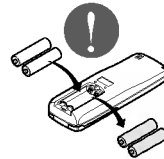

■ Disuse

Do not recharge or disassemble the batteries. Do not dispose of batteries in a fire.

- They may burn or explode.

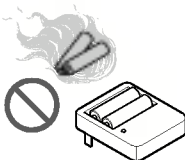

If the liquid from the batteries gets onto your skin or clothes, wash it well with clean water. Do not use the remote if the batteries have leaked.

- The chemicals in batteries could cause burns or other health hazards.



Prior to Operation

Preparing for Operation

1. Contact an installation specialist for installation.
2. Plug in the power plug properly.
3. Use a dedicated circuit.
4. Do not use an extension cord.
5. Do not start/stop operation by plugging/unplugging the power cord.
6. If the cord/plug is damaged, replace it with only an authorized replacement part.

Usage

1. Being exposed to direct airflow for a long time may be hazardous to your health. Do not expose occupants, pets, or plants to direct airflow for a long time.
2. Due to the possibility of oxygen deficiency, ventilate the room when using the appliance together with stoves or other heating devices.
3. Do not use this air conditioner for non-specified special purpose (e.g. preserving precision devices, food, pets, plants, or art objects). Such use may damage your properties.

Cleaning and Maintenance

1. Do not touch the metal parts of the unit when removing the filter. Injury can occur.
2. Do not use water to clean inside the air conditioner. Exposure to water can destroy the insulation, leading to electric shock.
3. When cleaning the unit, first make sure that the power and breaker are turned off. The fan rotates at a very high speed during operation. There is a possibility of injury if the unit's power is triggered while cleaning inner parts of the unit.

Service

For repair and maintenance, contact your authorized service dealer.

Introduction

Symbols used in this Manual



This symbol alerts you to the risk of electric shock.



This symbol alerts you to hazards that may cause harm to the air conditioner.

NOTICE

This symbol indicates special notes.

Features



WARNING: This appliance should be installed in accordance with national wiring regulations. This guide acts as a guide to help to explain product features.

Indoor

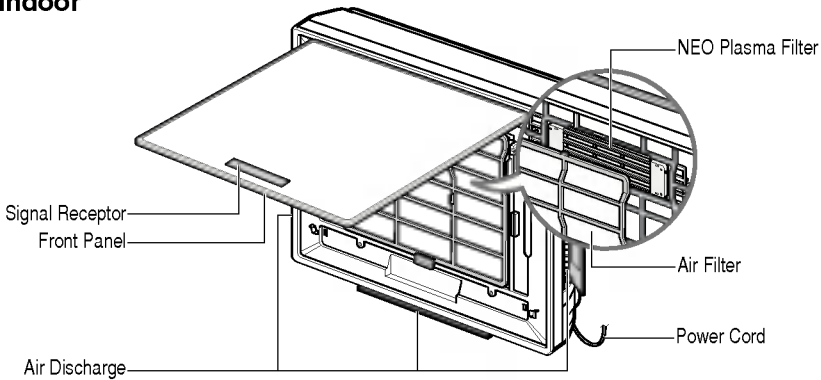

Outdoor

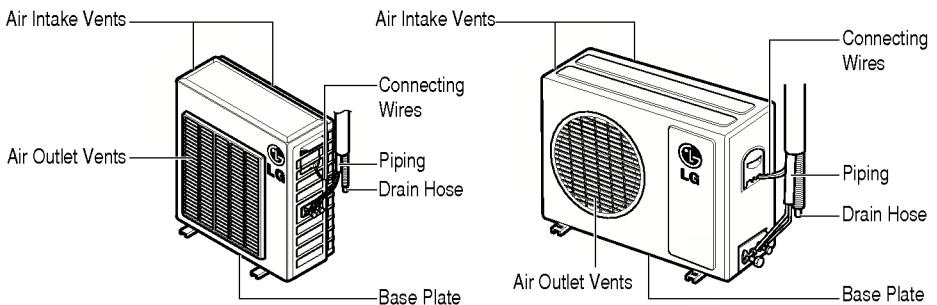

Electrical Safety



WARNING: This appliance must be properly grounded.

To minimize the risk of electric shock, you must always plug into a grounded outlet.

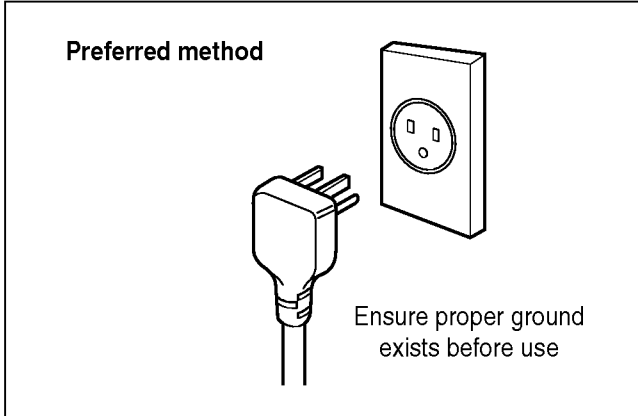

WARNING: Do not cut or remove the grounding prong from the power plug.



WARNING: Attaching the adapter ground terminal to the wall receptacle cover screw does not ground the appliance unless the cover screw is metal and not insulated, and the wall receptacle is grounded through the house wiring.



WARNING: If you have any doubt whether the air conditioner is properly grounded, have the wall receptacle and circuit checked by a qualified electrician.

Temporary Use of an Adapter

We **strongly discourage** the use of an adapter due to potential safety hazards. For temporary connections, use only a UL-listed adapter, available from most local hardware stores. Ensure that the large slot in the adapter is aligned with the large slot in the receptacle for a proper polarity connection. To disconnect the power cord from the adapter, use one hand on each to avoid damaging the ground terminal. Avoid frequently unplugging the power cord as this can lead to eventual ground terminal damage.

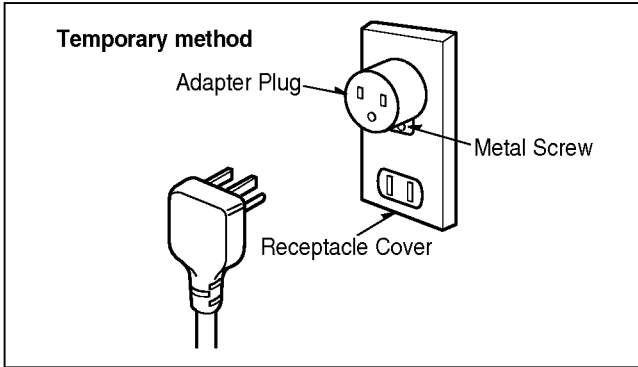

WARNING: Never use the appliance with a broken adapter.

Temporary Use of an Extension Cord

We strongly discourage the use of an extension cord due to potential safety hazards. For temporary situations, use only CSA certified and UL listed 3-wire grounded extension cords, rated 15 A, 125 V.

Operating Instructions

How to insert the Batteries

1. Remove the battery cover by pulling it according to the arrow direction.
2. Insert new batteries making sure that the (+) and (-) of battery are installed correctly.
3. Reattach the cover by sliding it back into position.

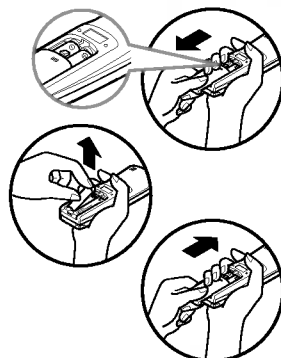

NOTICE Use 2 AAA(1.5volt) batteries.
Do not use rechargeable batteries.

Storage and Tips for using the Remote Controller

- The remote controller may be stored by mounting it on a wall.
- To operate the room air conditioner, aim the remote controller at the signal receptor.

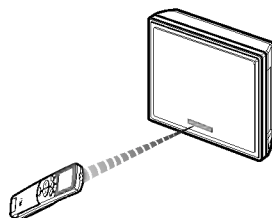
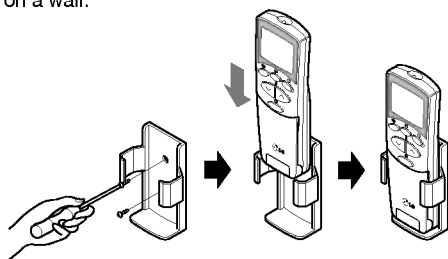

Signal receptor

Receives the signals from the remote controller.(Signal receiving sound: two short beeps or one long beep.)

Operation indicating lamps

- ① On/Off : Lights up during the system operation.
- ☆ Sleep Mode : Lights up during Sleep Mode Auto operation.
- 🕒 Timer : Lights up during Timer operation.
- ❄️ Defrost Mode : Lights up during Defrost Mode or ***Hot Start operation** (Heat pump model only)
- 🌀 Outdoor Unit Operation : Lights up during outdoor unit operation. (Cooling model only)
- ☾ NEO Plasma : The function illustrates its dynamic mode by using a multiple lighting system.

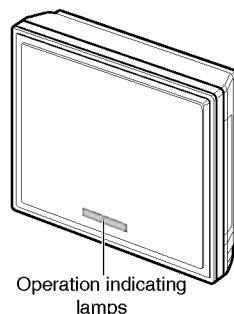





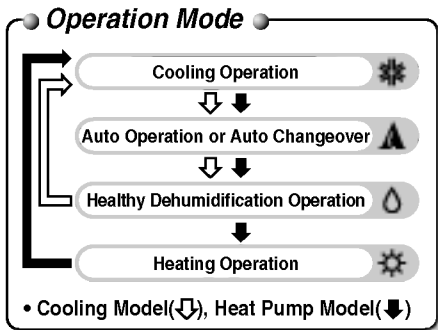
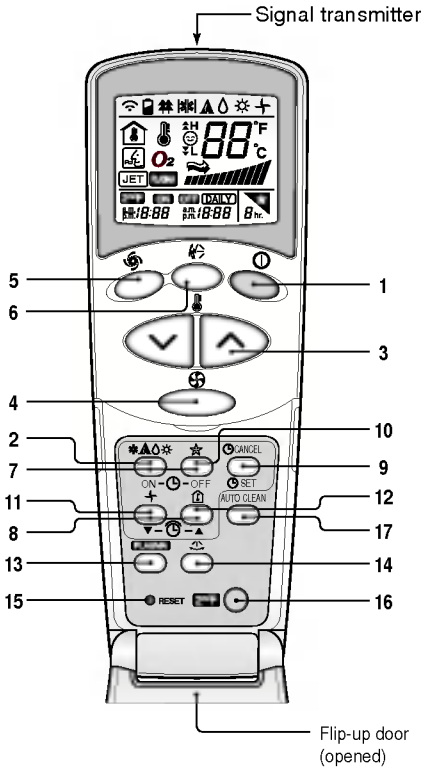

***Hot Start operation:** Stops the indoor fan in Heating Operation to prevent cold air from blowing out from unit.

Remote Control Operations

The controls will look like the following.

Controls



1. **START/STOP BUTTON**
Operation starts when this button is pressed and stops when the button is pressed again. 
2. **OPERATION MODE SELECTION BUTTON**
Used to select the operation mode. 
3. **ROOM TEMPERATURE SETTING BUTTONS**
Used to select the room temperature. 
4. **INDOOR FAN SPEED SELECTOR**
Used to select fan speed in four steps low, medium, high and CHAOS. 
5. **JET COOL/HEATING(OPTIONAL)**
Used to start or stop the speed cooling/heating.(speed cooling/heating operates super high fan speed in cooling/heating mode.) 
6. **CHAOS SWING BUTTON**
Used to stop or start louver movement and set the desired up/down airflow direction. 
7. **ON/OFF TIMER BUTTONS**
Used to set the time of starting and stopping operation. (See page 24)
8. **TIME SETTING BUTTONS**
Used to adjust the time. (See page 24)
9. **TIMER SET/CANCEL BUTTON**
Used to set the timer when the desired time is obtained and to cancel the Timer operation. (See page 24)
10. **SLEEP MODE AUTO BUTTON**
Used to set Sleep Mode Auto operation. (See page 24)
11. **AIR CIRCULATION BUTTON**
Used to circulate the room air without cooling or heating. (See page 25)
12. **ROOM TEMPERATURE CHECKING BUTTON**
Used to check the room temperature.
13. **NEO PLASMA(OPTIONAL)**
Used to start or stop the plasma-purification function. (See page 22)
14. **HORIZONTAL AIRFLOW DIRECTION CONTROL BUTTON (OPTIONAL)**
Used to set the desired vertical airflow direction.
15. **RESET BUTTON**
Used prior to resetting time.
16. **2nd F Button**
Used prior to using modes printed in blue at the bottom of buttons. (See page 23)
17. **AUTO CLEAN (OPTIONAL)**
Used to set Auto Clean mode.

 **Cooling operation**

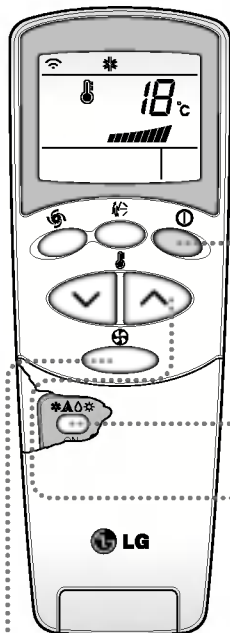

1 Press the Start/Stop button.
The unit will respond with a beep.



2 Open the door of the remote controller. To select **Cooling Operation**, press the Operation Mode Selection button. Each time the button is pressed, the operation mode is shifted in the direction of the arrow.

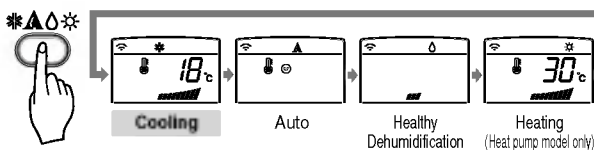

3 Close the door of the remote controller. Set the temperature lower than the room temperature. The temperature can be set within a range of 18°C~30°C at intervals of 1°C.

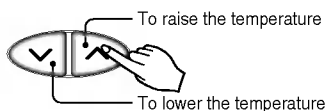

4 Set the fan speed again with the door of the remote controller still closed. You can select the fan speed in four steps-low, medium, high and CHAOS. Each time the button is pressed, the fan speed mode is shifted.



Natural wind by the CHAOS logic

- For fresher feeling, press the Indoor fan speed selector and set to CHAOS mode. In this mode, the wind blows like a natural breeze by automatically changing fan speed according to the CHAOS logic.

A Auto operation (Cooling model only)

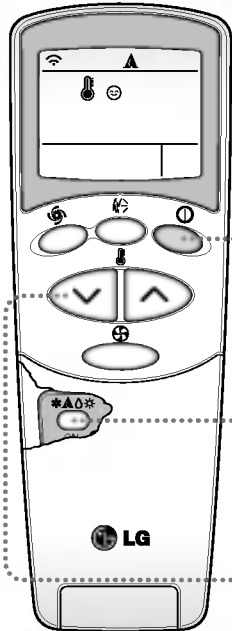

1 Press the Start/Stop button.
The unit will respond with a beep.



2 Open the door of the remote controller. To select **Auto Operation**, press the operation mode selection button. Each time the button is pressed, the operation mode is shifted in the direction of the arrow.

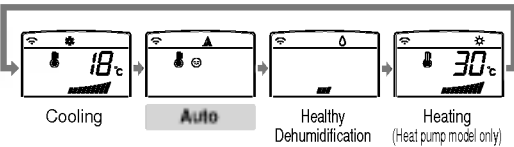

3 The temperature and fan speed are automatically set by the electronic controls based on the actual room temperature. If you want to change the set temperature, press the Room Temperature Setting buttons. The cooler or warmer you feel, the more times (up to two times) you should press the button. The set temperature will be changed automatically.

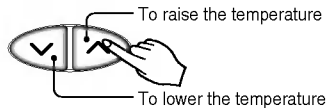

During Auto Operation

- You cannot control the indoor fan speed. It has already been set by the Fuzzy rule.
- If the system is not operating as desired, manually switch to another mode. The system will not automatically switch from the cooling mode to the heating mode, or from heating mode to cooling mode, it must be done by manually resetting.
- During Auto Operation, pressing the chaos swing button makes the horizontal louvers swing up and down automatically. If you want to stop auto-swing, press the chaos swing button again.

A Auto changeover operation(Heat pump model only)

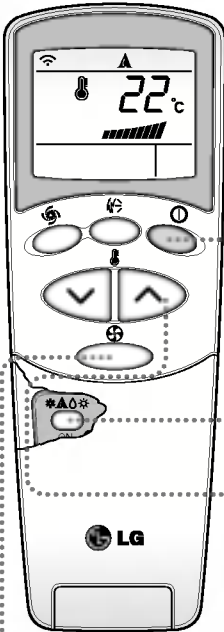

1 Press the Start/Stop button.
The unit will respond with a beep.



2 Open the door of the remote controller. To select **Auto Changeover Operation**, press the Operation Mode Selection button. Each time the button is pressed, the operation mode is shifted in the direction of the arrow.

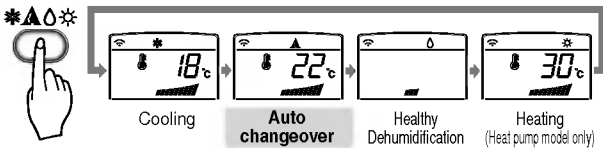

3 Close the door of the remote controller. Set the temperature lower than the room temperature. The temperature can be set within a range of 18°C~30°C at intervals of 1°C.

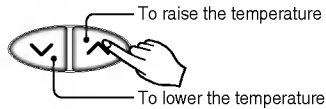

4 Set the fan speed again with the door of the remote controller still closed. You can select the fan speed in four steps-low, medium, high and CHAOS. Each time the button is pressed, the fan speed mode is shifted.



During Auto changeover Operation

The air conditioner changes the operation mode automatically to keep indoor temperature. When room temperature vary over $\pm 2^{\circ}\text{C}$ with respect to setting temperature, air conditioner keeps the room temperature within $\pm 2^{\circ}\text{C}$ with respect to setting temperature by auto changeover mode.

Healthy dehumidification operation

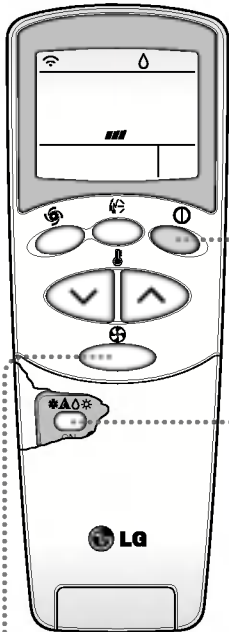

- 1** Press the Start/Stop button.
The unit will respond with a beep.

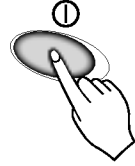

- 2** Open the door of the remote controller. To select **Healthy Dehumidification Operation**, press the Operation Mode Selection button.
Each time the button is pressed, the operation mode is shifted in the direction of the arrow.

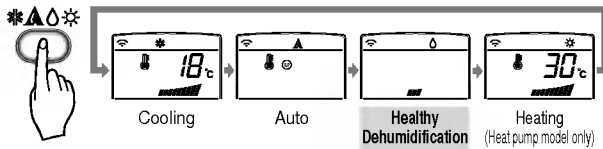

- 3** Set the fan speed again with the door of the remote controller still closed.
You can select the fan speed in four steps-low, medium, high, or CHAOS.
Each time the button is pressed, the fan speed mode is shifted.



Natural wind by the CHAOS logic

- For fresher feeling, press the Indoor Fan Speed Selector and set to CHAOS mode. In this mode, the wind blows like a natural breeze by automatically changing fan speed according to the CHAOS logic.

During Healthy Dehumidification Operation

- If you select the dehumidification mode on the operation selection button, the A/C starts to run the dehumidification function. It automatically sets the room temp. and airflow volume to the best condition for dehumidification, based on the sensed current room temp.
- In this case, however, the setting temp. is not displayed on the remote controller and you are not able to control the room temp. either.
- During the healthy dehumidification function, the airflow volume is automatically set according to the optimization algorithm responding to the current room temp. status, so that the room condition is kept healthy and comfortable even in the very humid season.

 Heating operation (Heat pump model only)

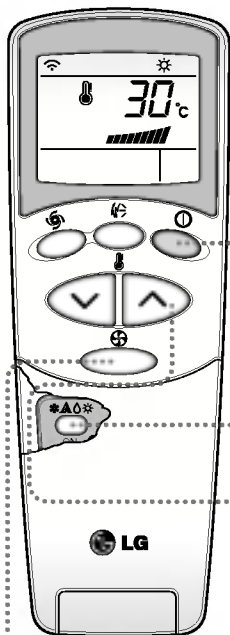

1 Press the Start/Stop button. The unit will respond with a beep.



2 Open the door of the remote controller. To select **Heating Operation**, press the Operation Mode Selection button. Each time the button is pressed, the operation mode is shifted in the direction of the arrow.

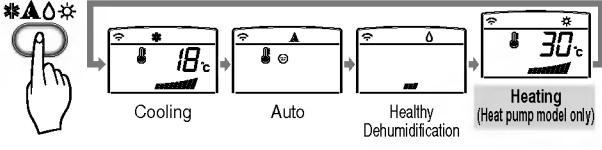

3 Close the door of the remote controller. Set the temperature higher than the room temperature. The temperature can be set within a range of 16°C~30°C at intervals of 1°C.

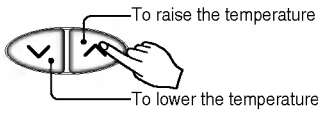

4 Set the fan speed again with the door of the remote controller still closed. You can select the fan speed in four steps—low, medium, high and CHAOS. Each time the button is pressed, the fan speed mode is shifted.



Natural wind by the CHAOS logic

For fresher feeling, press the Indoor Fan Speed Selector and set to CHAOS mode. In this mode, the wind blows like a natural breeze by automatically changing fan speed according to the CHAOS logic.

 **Jet cool operation**

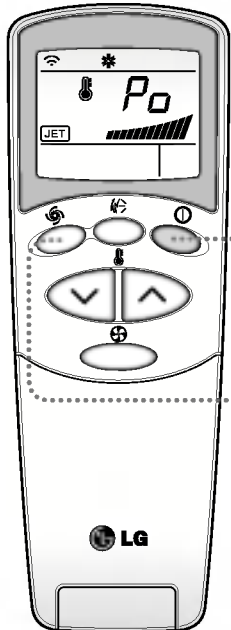

1 Press the Start/Stop button.
The unit will respond with a beep.

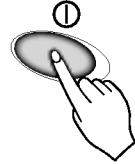

2 Press the Jet Cool button to operate the speed cooling mode and the unit will operate at super high fan speed on cooling mode for 30 minutes.



3 To cancel the Jet Cool mode, press the Jet Cool button, the fan speed button or the room temperature setting button again and the unit will operate at high fan speed on cooling mode.

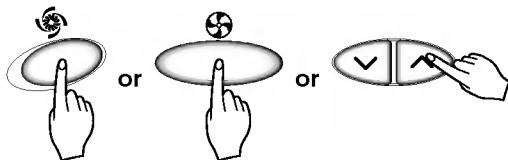

NOTICE

❑ During the JET COOL function at any moment, the A/C starts to blow the cool air at extremely high speed for 30 minutes setting the room temp. automatically to 18°C. It is especially used to cool the room temp. quickly in a hot summer.

In heat pump mode, neuro fuzzy mode, or auto changeover mode however, the JET COOL function is not available.

❑ In order to return to the normal cooling mode from the JET COOL mode, just press the operation mode selection button, airflow volume selection, temp. setting button or the JET COOL button again.

Jet heat operation (Optional)

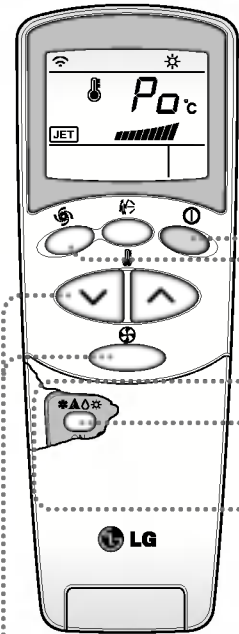

1 Press the Start/Stop button.
The unit will respond with a beep.

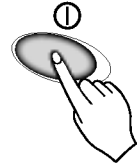

2 Open the door of the remote controller.
To select Heating Operation.

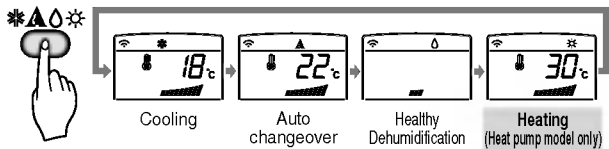

3 Press the Jet Heat button to operate the speed heating mode and the unit will operate at super high fan speed on heating mode for 60 minutes.



4 To cancel the Jet Heat mode, press the Jet Heat button, the fan speed button or the room temperature setting button again and the unit will operate at high fan speed on heating mode.

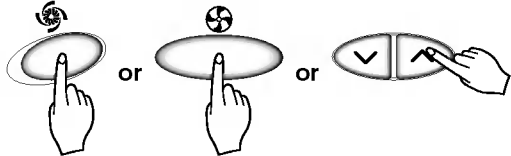

NOTICE

- During the JET HEAT function at any moment, the A/C starts to blow the heat air at extremely high speed for 60 minutes setting the room temp. automatically to 30°C. It is especially used to heat the room temp. quickly in a cool winter.
On cooling, healthy dehumidification mode or auto changeover mode, however, the JET HEAT function is not available.
- In order to return to the normal heating mode from the JET HEAT mode, just press the operation mode selection button, airflow volume selection, temp. setting button or the JET HEAT button again.

NEO PLASMA purification operation(Optional)

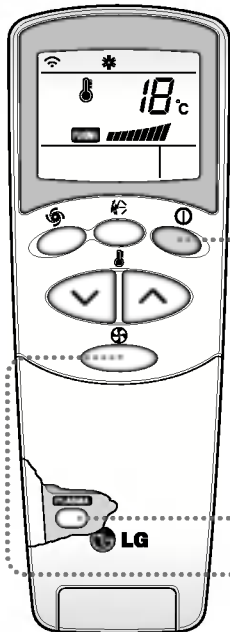

1 Press the Start/Stop button.
The unit will respond with a beep.



2 Open the door of the remote controller. Press the PLASMA button.
Operation will start when the button is pressed and stop when the button is pressed again.





3 Set the fan speed again with the door of the remote controller closed. You can select the fan speed in four steps-low, medium, high or CHAOS.
Each time the button is pressed, the fan speed mode is shifted.

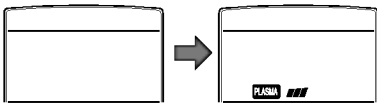

* Air purifying operation (PLASMA) can be with cooling, Heating or any other operations.

NEO PLASMA Air Purifying Operation only



If you press the only PLASMA button, only PLASMA purification function operates.
Then, fan speed is low. You can select the fan speed in four steps-low, medium, high or CHAOS.
Each time the button () is pressed, the fan speed mode is shifted.

2nd F operation

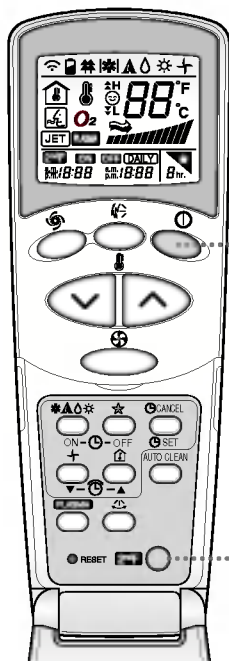

1 Press the Start/Stop button.
The unit will respond with a beep.

2 Open the door of the remote control and press the 2nd Function button to operate functions printed in blue under buttons.
(Check the indication of 2nd function on the display of the remote controller.)
These buttons can set the timer as follows:

3 2nd function disappears in a short time automatically or when the button is pressed again.

For more details, refer to functions next pages.

Additional Features

★ Sleep mode

1. Press the Sleep Mode Auto button to set the time you want the unit to stop automatically.
2. The Timer is programmed in one-hour increments by pressing the Sleep Mode Auto button 1 to 7 times. The sleep mode is available for 1 to 7 times. To alter the time period in steps of 1 hour, press the Sleep Mode Button while aiming at air conditioner.
3. Make sure the Sleep Mode Auto LED lights up.
To cancel the Sleep Mode, press the sleep Mode Auto button several times until the star (★) disappears from the operation display.



NOTICE The Sleep Mode will be operated at slow fan speed (cooling) or medium fan speed (heat pump only) for a comfortable sleep.

In cooling mode or healthydehumidification mode:

The temperature will automatically rise by 1°C over the next 30 minutes and by 2°C in 1 hour for a comfortable sleep.

🕒 Setting the time

1. Time can be set only when you press the Reset button. Having replacing the batteries, you should press the reset buttons to reset the time. Press the Start/Stop button.
2. Press 2nd F button and check if 2nd F icon is on.
3. Press the Time Setting buttons until the desired time is set.
4. Press the Timer SET button.



NOTICE Check the indicator for A.M. and P.M.

🕒 Delay start/Pre-set stop

1. Make sure the time is set correctly on the display of the remote controller.
2. Press 2nd F button.
3. Press the ON/OFF Timer buttons to turn Timer on or off.
4. Press the Time Setting buttons until the desired time is set.
5. To set the selected time, press the Timer setting button aiming the remote controller at the signal receptor.



To cancel the timer setting

Check if 2nd F icon is off.

Press the Timer Cancel button aiming the remote controller at the signal receptor.
(The timer lamp on the air conditioner and the display will go out.)



NOTICE Select one of the following four types of operation.

with the unit running



Delay OFF Timer



Delay ON Timer



Delay OFF and ON Timer



Delay ON and OFF Timer

Airflow direction control

The up/down and right/left airflow can be adjusted by using the remote control.



Press the Start/Stop button to start the unit.

Press Chaos Swing button and the louvers will swing.

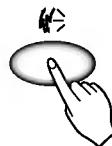

Press the button again and the louvers will stop. After 30 minutes, the louvers return to the maximum airflow position automatically.

Air circulation mode

Circulates the room air without cooling or heating.

1. Press the Start/Stop button. the unit will respond with a beep.
2. Open the door on the remote control. Press the Air Circulation button. Close the door on the remote control. Now each time that you press the Indoor Fan Speed Selector, the fan speed is shifted from low to CHAOS and back to low again.

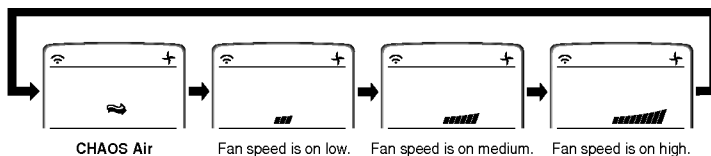

NOTICE CHAOS Air economizes power consumption and prevents overcooling. The fan speed is automatically changed from high to low or vice versa, depending on the ambient temperature.

Auto clean

AUTO CLEAN



1. Whenever you press the Auto Clean button, Auto Clean Function will be reserved and cancelled.
2. Auto Clean function works before and after cooling or dehumidification mode. For details, refer to the below points.
3. When the unit is started after the reservation of Auto Clean, the Cool Start function operates and indoor Fan is started after 20 seconds.
4. When you press Start/Stop button to turn off the unit after the you have reserved Auto Clean function, the air-conditioner circulates the indoor air in the Auto Clean mode with no more Cooling or Dehumidification operation. For Cooling only model, it lasts for 30 minutes for Heat pump model, for 16 minutes.
5. If you press the auto clean button again during the product operation, Auto Clean function will be cancelled.

NOTICE

- ❑ During Auto Clean function, moistures left in indoor units after Cooling Operation or Healthy Dehumidification Operation can be removed.
- ❑ During Auto Clean function, only Start/Stop button, Plasma button and Auto Clean button are available.

Forced operation

Operation procedures when the remote control can't be used.
The operation will be started if the power button is pressed.
If you want to stop operation, re-press the button.

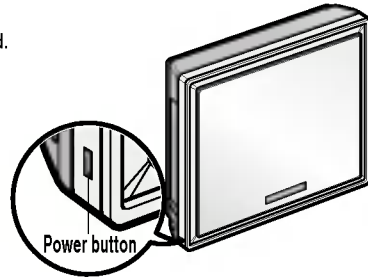

	Cooling Model	Heat pump Model		
		Room Temp. $\geq 24^{\circ}\text{C}$	$21^{\circ}\text{C} \leq$ Room Temp. $< 24^{\circ}\text{C}$	Room Temp. $< 21^{\circ}\text{C}$
Operating mode	Cooling	Cooling	Healthy Dehumidification	Heating
Indoor FAN Speed	High	High	High	High
Setting Temperature	22°C	22°C	23°C	24°C

Test operation

During the TEST OPERATION, the unit operates in cooling mode at high speed fan, regardless of room temperature and resets in 18 minutes.

During test operation, if remote controller signal is received, the unit operates as remote controller sets.

If you want to use this operation, Press and hold the ON/OFF button for 3-5 seconds, then the buzzer sound 1 "beep".

If you want to stop the operation, re-press the button.

Auto restart

In case the power comes on again after a power failure, Auto Restarting Operation is the function to operate procedures automatically to the previous operating conditions.

So there is no need of activating this function by pressing any key or button.

In the initial mode, the fan operates at a low speed and the compressor starts 2.5~3 minutes later.

As the compressor starts, the fan speed also resumes its previous setting mode.

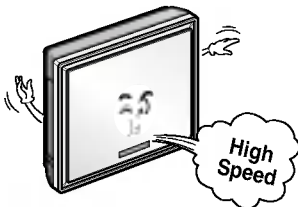

Helpful information

Fan speed and cooling capacity.

The cooling capacity indicated in the specification is the value when the fan speed is set to high, and the capacity will be lower at low or medium fan speed.

High fan speed is recommended when you wish to cool the room quickly.

NOTICE

Auto restart function has set enable as factory default.

But customer can set up by following this instruction.

To be disable function

- Press and hold the ON/OFF button for 6 seconds, then the buzzer sound 2 "beep" and the indicator lamp (1) blinks 4 times.

To be enable function

- Press and hold the ON/OFF button for 6 seconds, then the buzzer sound 2 "beep" and the indicator lamp (1) brights 4 times.

Maintenance and Service

Indoor Unit



WARNING: Turn the system off before cleaning. To clean, wipe with a soft, dry cloth. Do not use bleach or abrasives.

NOTICE Supply power must be disconnected before cleaning the indoor unit.

Air filter

The air filters behind the front grill should be checked and cleaned once every 2 weeks or more often if necessary.

1. Lift the front panel. After lifting up the filter tab a bit, take the filter out slowly

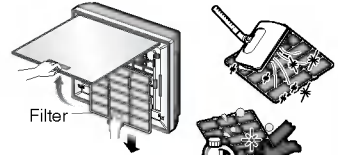

NOTICE Clean the filter after stopping the product.

- Clean the filter with a vacuum or warm, soapy water.
 - If dirt is conspicuous, wash with a solution of detergent in lukewarm water.
 - If hot water (40°C or more) is used, it may be deformed.
- After washing with water, dry well in the shade.
- Re-install the air filter.

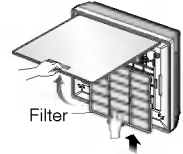

Never use any of the followings:

- Water hotter than 40°C.
Could cause deformation and/or discoloration.
- Volatile substances
Could damage the surfaces of the air conditioner.



Outdoor Unit

The heat exchanger coils and panel vents of the outdoor unit should be checked regularly. If clogged with dirt or soot, the heat exchanger and panel vents may be professionally steam cleaned.

NOTICE Dirty or clogged coils will reduce the operating efficiency of the system and cause higher operating costs.

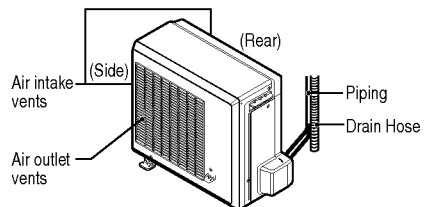
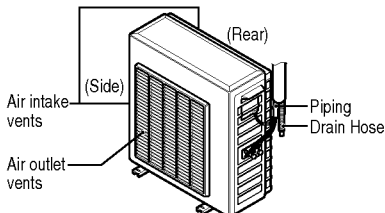
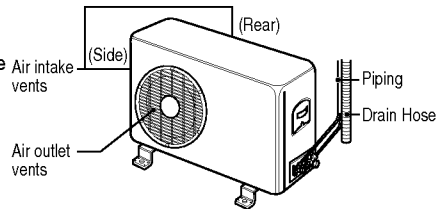

Cleaning Filter

- Recommended use period : About 3 months

1. Lift the front panel, hold it up and pull the Air filter.

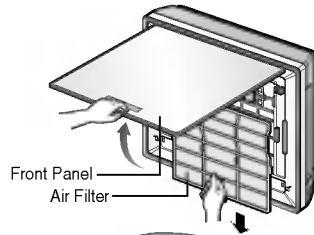

2. Remove the Plasma Filter.



WARNING: Don't touch the PLASMA Filter within 10 seconds after opening the inlet grille, it may cause electric shock.

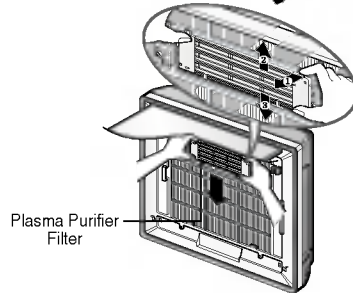

3. Put the Plasma Filter into the neutral detergent for 1~2 hours and then raise it.

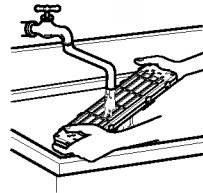

4. Insert the Plasma Filter after perfectly drying it in shade. Now insert Air Filter and close the front panel completely by matching the hook.

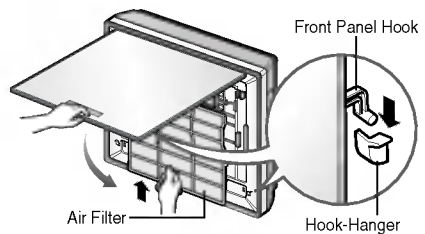
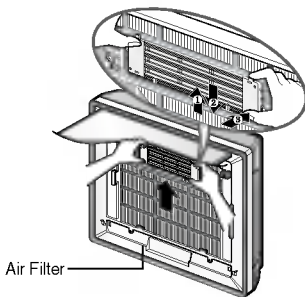

Common Problems and Solutions

Before calling for service

If you have problems with your air conditioner, read the following information and try to solve the problem. If you cannot find a solution, turn off the air conditioner and contact your dealer.

Air conditioner does not operate

1. Ensure that the air conditioner is plugged into a proper outlet.
2. Check the fuse or circuit breaker.
3. Check whether the voltage is unusually high or low.

Air does not feel cold enough on the cooling setting

1. Ensure that the temperature settings are correct.
2. Check to see if the air filter is clogged with dust. If so, replace the filter.
3. Ensure that the air flow from the outside is not obstructed and that there is a clearance of over 20" between the back of the air conditioner and the wall or fence behind it.
4. Close all doors and windows and check for any source of heat in the room.



Before calling for service, please review the following list of common problems and solutions.

The air conditioner is operating normally when:

- You hear a pinging noise. This is caused by water being picked up by the fan on rainy days or in highly humid conditions. This feature is designed to help remove moisture in the air and improve cooling efficiency.
- You hear the thermostat click. This is caused by the compressor cycle starting and stopping.
- You see water dripping from the rear of the unit. Water may be collected in the base pan in highly humid conditions or on rainy days. This water overflows and drips from the rear of the unit.
- You hear the fan running while the compressor is silent. This is a normal operational feature.

Troubleshooting

The air conditioner may be operating abnormally when:

Problem	Possible Causes	What To Do
Air conditioner does not start	<ul style="list-style-type: none"> ■ The air conditioner is unplugged. 	<ul style="list-style-type: none"> • Make sure the air conditioner plug is pushed completely into the outlet.
	<ul style="list-style-type: none"> ■ The fuse is blown/circuit breaker is tripped. 	<ul style="list-style-type: none"> • Check the house fuse/circuit breaker box and replace the fuse or reset the breaker.
	<ul style="list-style-type: none"> ■ Power failure. 	<ul style="list-style-type: none"> • If power failure occurs, turn the mode control to Off. When power is restored, wait 3 minutes to restart the air conditioner to prevent tripping of the compressor overload.
Air conditioner does not cool as it should	<ul style="list-style-type: none"> ■ Airflow is restricted. 	<ul style="list-style-type: none"> • Make sure there are no curtains, blinds, or furniture blocking the front of the air conditioner.
	<ul style="list-style-type: none"> ■ The thermostat may not be set high enough. 	<ul style="list-style-type: none"> • Turn the knob to a higher number. The highest setting provides maximum cooling.
	<ul style="list-style-type: none"> ■ The air filter is dirty. 	<ul style="list-style-type: none"> • Clean the filter at least every 2 weeks. See the care and Maintenance section.
	<ul style="list-style-type: none"> ■ The room may have been hot. 	<ul style="list-style-type: none"> • When the air conditioner is first turned on, you need to allow time for the room to cool down.
	<ul style="list-style-type: none"> ■ Cold air is escaping. 	<ul style="list-style-type: none"> • Check for open furnace floor registers and cold air returns.
	<ul style="list-style-type: none"> ■ Cooling coils have iced up. 	<ul style="list-style-type: none"> • See Air Conditioner Freezing Up below.
Air conditioner freezing up	<ul style="list-style-type: none"> ■ Ice blocks the air flow and stops the air conditioner from cooling the room. 	<ul style="list-style-type: none"> • Set the mode control at High Fan or High Cool with thermostat at 1 or 2.

* You can refer to the Energy Star program in detail at www.energystar.gov.