



website <http://www.lgservice.com>  
e-mail <http://www.lgservice.com/techsup.html>

LG

ENGLISH

ESPAÑOL

# LG ROOM AIR CONDITIONER

## **OWNER'S MANUAL**

Please read the operating instructions and safety precautions carefully and thoroughly before installing and operating your room air conditioner.

# ACONDICIONADOR DE AIRE DE VENTANA

## **MANUAL DEL PROPIETARIO**

Por favor lea las instrucciones de operación y las precauciones de seguridad cuidadosa y totalmente antes de instalar y operar su acondicionador de aire de ventana.

**MODELS, MODELOS: LT1030H  
LT1230H**



# TABLE OF CONTENTS

Safety Precautions.....	3
Prior to Operation .....	7
Introduction .....	8
Electrical Safety .....	9
Installation .....	11
Operating Instructions .....	18
Maintenance and Service .....	20



## FOR YOUR RECORDS

Write the model and serial numbers here:

**Model #** \_\_\_\_\_

**Serial #** \_\_\_\_\_

You can find them on a label on the side of each unit.

**Dealer's Name** \_\_\_\_\_

**Date Purchased** \_\_\_\_\_

■ Staple your receipt to this page in the event you need it to prove date of purchase or for warranty issues.



## READ THIS MANUAL

Inside you will find many helpful hints on how to use and maintain your air conditioner properly. Just a little preventive care on your part can save you a great deal of time and money over the life of your air conditioner.

You'll find many answers to common problems in the chart of troubleshooting tips. If you review our chart of

**Troubleshooting Tips** first, you may not need to call for service at all.



## PRECAUTION

- Contact the authorized service technician for repair or maintenance of this unit.
- Contact the installer for installation of this unit.
- The air conditioner is not intended for use by young children or invalids without supervision.
- Young children should be supervised to ensure that they do not play with the air conditioner.
- When the power cord is to be replaced, replacement work shall be performed by authorized personnel only using only genuine replacement parts.
- Installation work must be performed in accordance with the National Electric Code by qualified and authorized personnel only.



# Safety Precautions



To prevent injury to the user or other people and property damage, the following instructions must be followed.

■ Incorrect operation due to ignoring instruction will cause harm or damage. The seriousness is classified by the following indications.

**⚠ WARNING** This symbol indicates the possibility of death or serious injury.

**⚠ CAUTION** This symbol indicates the possibility of injury or damage to properties only.

■ Meanings of symbols used in this manual are as shown below.

	<b>Be sure not to do.</b>
	<b>Be sure to follow the instruction.</b>

## ⚠ WARNING

### ■ Installation

**Don't use a power cord, a plug or a loose socket which is damaged.**

- Otherwise, it may cause a fire or electrical shock.

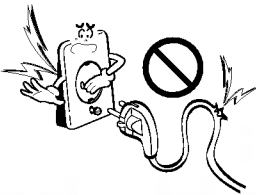

**Always plug into a grounded outlet.**

- Otherwise, it may cause a fire or electrical shock.

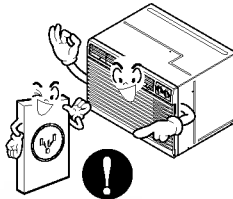

**Do not modify or extend the power cord length.**

- It will cause electric shock or fire due to heat generation.

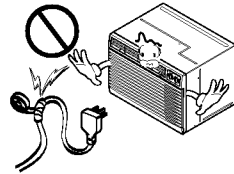

**Do not disassemble or modify products.**

- It may cause failure and electric shock.



**Be caution when unpacking and installing.**

- Sharp edges may cause injury.

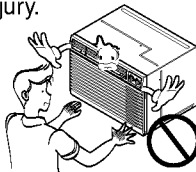

**Do not use the power cord near flammable gas or combustibles such as gasoline, benzene, thinner, etc.**

- It may cause explosion or fire.

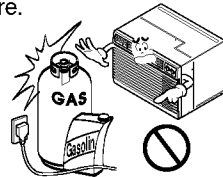

## ■ Operation

**Do not place heavy object on the power cord and take care so that the cord should not be pressed.**

- There is danger of fire or electric shock.

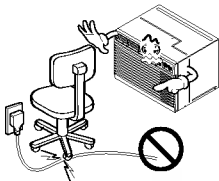

**Do not share the outlet with other appliances.**

- It will cause electric shock or fire due to heat generation.

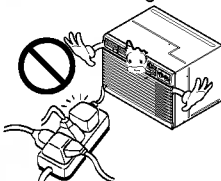

**Take the power plug out if necessary, holding the head of the plug and do not touch it with wet hands.**

- Otherwise, it may cause a fire or electrical shock.

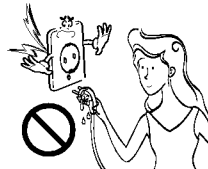

**Do not place the power cord near a heater.**

- It may cause fire and electric shock.

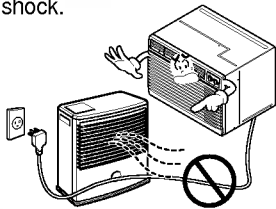

**Do not allow water to run into electric parts.**

- It will cause failure of machine or electric shock.



**Use a soft cloth to clean. Do not use wax, thinner, or a strong detergent.**

- The appearance of the air conditioner may deteriorate, change color, or develop surface flaws.

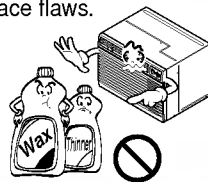

**Unplug the unit if strange sounds, odors, or smoke come from it.**

- Otherwise it may cause fire and electric shock accident.



**Do not open the suction inlet grill of the product during operation.**

- Otherwise, it may electrical shock and failure.

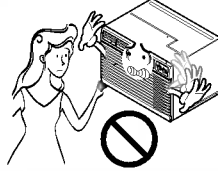

**If water enters the product, turn off the power switch of the main body of appliance. Contact service center after taking the power-plug out from the socket.**



**Ventilate the room well when using this appliance together with a stove, etc.**

- An oxygen shortage may occur.

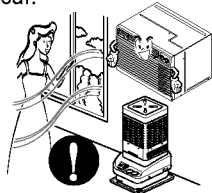

**Turn off the power and breaker firstly when cleansing the unit.**

- Since the fan rotates at high speed during operation, it may cause injury.

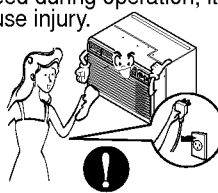

**Turn off the main power switch when not using it for a long time.**

- Prevent accidental startup and the possibility of injury.



**Do not operate or stop the unit by inserting or pulling out the power plug.**

- It will cause electric shock or fire due to heat generation.

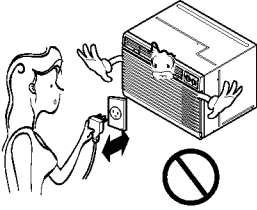

**Do not damage or use an unspecified power cord.**

- It will cause electric shock or fire.

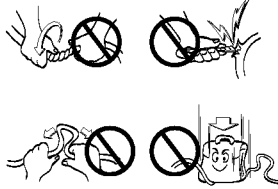

**Do not operate with wet hands or in damp environment.**

- It will cause electric shock.

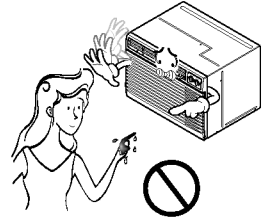

**Hold the plug by the head when taking it out.**

- It may cause electric shock and damage.

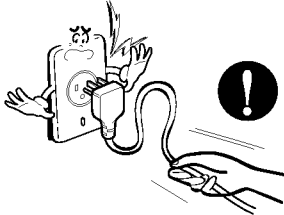

**When gas leaks, open the window for ventilation before operating the unit.**

- Otherwise, it may cause explosion, and a fire.

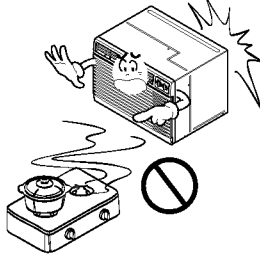

**Never touch the metal parts of the unit when removing the filter.**

- They are sharp and may cause injury.

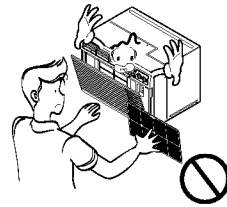

**CAUTION**

**Installation**

**Install the product so that the noise or hot wind from the outdoor unit may not cause any damage to the neighbors.**

- Otherwise, it may cause dispute with the neighbors.

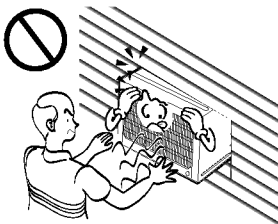

**Keep level parallel in installing the product.**

- Otherwise, it may cause vibration or water leakage.

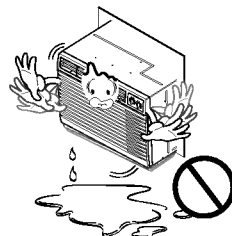

## ■ Operation

**Do not put a pet or house plant where it will be exposed to direct air flow.**

- It may cause injury.

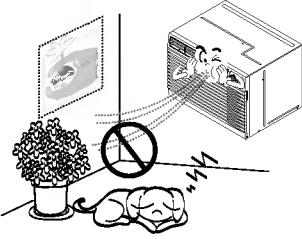

**Do not block the inlet or outlet of air flow.**

- It may cause product failure.

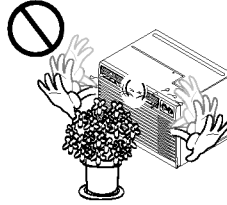

**Use a soft cloth to clean. Do not use wax, thinner, or a strong detergent.**

- The appearance of the air conditioner may deteriorate, change color, or develop surface flaws.

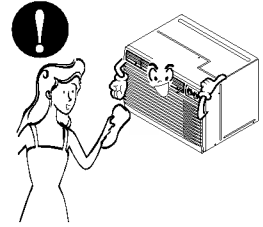

**Do not step on the indoor/outdoor unit and do not put anything on it.**

- It may cause an injury through dropping of the unit or falling down.

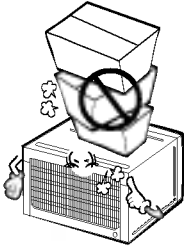

**Always insert the filter securely. Clean it every two weeks.**

- Operation without filters will cause failure.

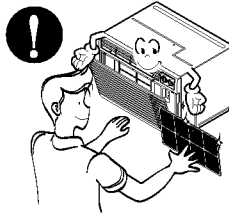

**Do not drink water drained from air conditioner.**

- It contains contaminants and will make you sick.

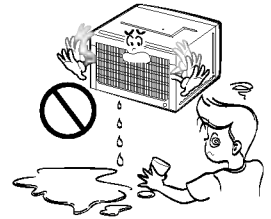

**Be cautious not to touch the sharp edges when installing.**

- It may cause injury.

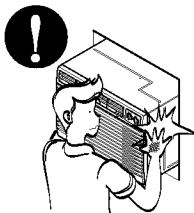

**Avoid excessive cooling and perform ventilation sometimes.**

- Otherwise, it may do harm to your health.

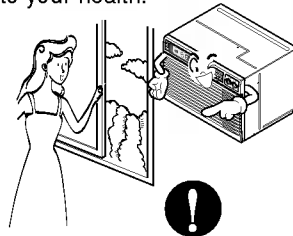

**Do not insert the hands or bars through the air inlet or outlet during operation.**

- Otherwise, it may cause personal injury.

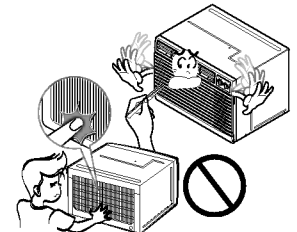

# Prior to Operation

## Preparing for Operation

1. Contact an installation specialist for installation.
2. Plug in the power plug properly.
3. Use a dedicated circuit.
4. Do not use an extension cord.
5. Do not start/stop operation by plugging/unplugging the power cord.
6. If the cord/plug is damaged, replace it with only an authorized replacement part.

## Usage

1. Being exposed to direct airflow for an extended period of time could be hazardous to your health. Do not expose occupants, pets, or plants to direct airflow for extended periods of time.
2. Due to the possibility of oxygen deficiency, ventilate the room when used together with stoves or other heating devices.
3. Do not use this air conditioner for non-specified special purposes (e.g. preserving precision devices, food, pets, plants, and art objects). Such usage could damage the items.

## Cleaning and Maintenance

1. Do not touch the metal parts of the unit when removing the filter. Injuries can occur when handling sharp metal edges.
2. Do not use water to clean inside the air conditioner. Exposure to water can destroy the insulation, leading to possible electric shock.
3. When cleaning the unit, first make sure that the power and breaker are turned off. The fan rotates at a very high speed during operation. There is a possibility of injury if the unit's power is accidentally triggered on while cleaning inner parts of the unit.

## Service

For repair and maintenance, contact your authorized service dealer.

# Introduction

## Symbols Used in this Manual



This symbol alerts you to the risk of electric shock.



This symbol alerts you to hazards that could cause harm to the air conditioner.

### **NOTICE**

This symbol indicates special notes.

## Features

### **⚠ WARNING**

This appliance should be installed in accordance with the National Electric Code.

### THE SLEEVE AND THE REAR GRILLE

(optionally supplied with your unit)

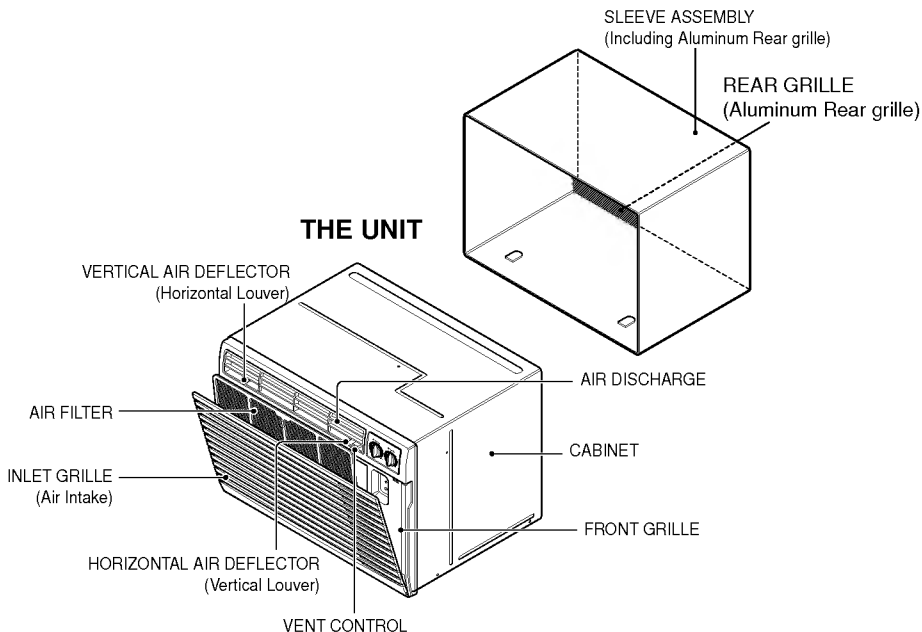



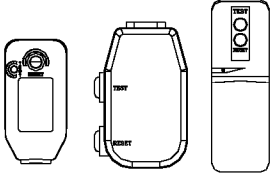
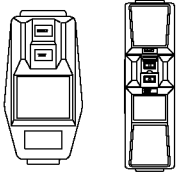

# Electrical Safety

## Electrical Data

115V~	230V~	
		<p>Power cord may include a current interrupter device. A test and reset button is provided on the plug case. The device should be tested on a periodic basis by first pressing the TEST button and then the RESET button. If the TEST button does not trip or if the RESET button will not stay engaged, discontinue use of the air conditioner and contact a qualified service technician.</p>

### NOTICE

The shape may be different according to its model.

Use Wall Receptacle	Power Supply
 <p>Standard 125V, 3-wire grounding receptacle rated 15A, 125V AC</p>	<p>Use 15 AMP, time delay fuse or 15 AMP, circuit breaker.</p>
 <p>Standard 250V, 3-wire grounding receptacle rated 15A, 250V AC</p>	
 <p>Standard 250V, 3-wire grounding receptacle rated 20A, 250V AC</p>	

### ⚠ WARNING

**Never push the test button during operation  
Otherwise this plug can damaged.**

This device contains chemical, including lead, known to the State of California to cause cancer, and birth defects or other reproductive harm.

Wash hands after handling.

Do not remove, modify or immerse this plug. If this device trips, the cause it to be corrected before further use.

### ⚠ CAUTION

The conductors inside this cord are surrounded by shields, which monitor leakage current.

These shields are not grounded.

<Made in Tower>

Periodically examine the cord for any damage. Do not use this product in the event the shields become exposed.

Avoid shock hazard, this unit can not be user serviced opening the tamper resistant. Sealed portion of the unit voids all warranties and performance claims. This unit not intended for use as an on-off switch.

### NOTICE

DO NOT USE AN EXTENSION CORD on 230, 208, and 230/208 Volt units.

All wiring should be made in accordance with local electrical codes and regulations.

Aluminum house wiring may pose special problems. Consult a qualified electrician.

## Electrical Safety

### **IMPORTANT (PLEASE READ CAREFULLY)**

#### **FOR THE USER'S PERSONAL SAFETY, THIS APPLIANCE MUST BE PROPERLY GROUNDED**

The power cord of this appliance is equipped with a three-prong (grounding) plug. Use this with a standard three-slot (grounding) wall power outlet to minimize the hazard of electric shock. The customer should have the wall receptacle and circuit checked by a qualified electrician to make sure the receptacle is properly grounded.

#### **DO NOT CUT OR REMOVE THE THIRD (GROUND) PRONG FROM THE POWER PLUG.**

#### **A. SITUATIONS WHEN THE APPLIANCE WILL BE DISCONNECTED OCCASIONALLY:**

Because of potential safety hazards, we strongly discourage the use of an adapter plug. However, if you wish to use an adapter, a TEMPORARY CONNECTION may be made. Use UL-listed adapter, available from most local hardware stores.

The large slot in the adapter must be aligned with the large slot in the receptacle to assure a proper polarity connection.

### **▲ CAUTION**

**: Attaching the adapter ground terminal to the wall receptacle cover screw does not ground the appliance unless the cover screw is metal, and not insulated, and the wall receptacle is grounded through the house wiring. The customer should have the circuit checked by a qualified electrician to make sure the receptacle is properly grounded.**

Disconnect the power cord from the adapter, using one hand on each. Otherwise, the adapter ground terminal might break. DO NOT USE the appliance with a broken adapter plug.

#### **B. SITUATIONS WHEN THE APPLIANCE WILL BE DISCONNECTED OFTEN.**

Do not use an adapter plug in these situations. Unplugging the power cord frequently can lead to an eventual breakage of the ground terminal. The wall power outlet should be replaced by a three-slot (grounding) outlet instead.

#### **USE OF EXTENSION CORDS**

Because of potential safety hazards, we strongly discourage the use of an extension cord. However, if you wish to use an extension cord, use a CSA certified/UL-listed 3-wire (grounding) extension cord, rated at 15A, 125V.

# Installation

Remove packing sheet from the back of the sleeve, and packing corner and blue tape from the air conditioner.

## INSTALLATION REQUIREMENTS

If you use an existing wall sleeve, you should measure its dimensions.

Install the new air conditioner according to these installation instructions to achieve the best performance. All wall sleeves used to mount the new air conditioner must be in good structural condition and have a rear grille to securely attach the new air conditioner. (FIG. 1)

With the LGE sleeve (optionally supplied with your unit), you can maintain the best performance of the new air conditioner. (FIG. 2)

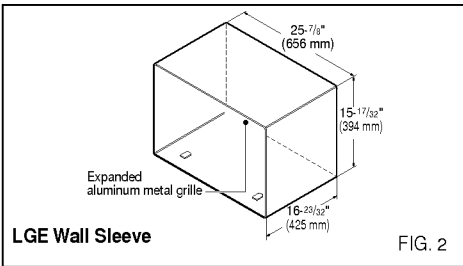
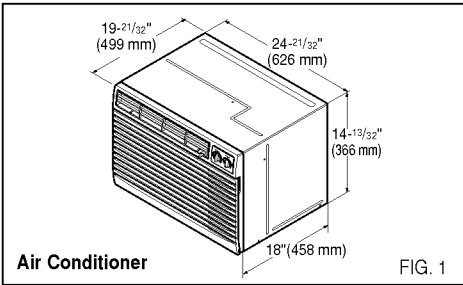

## ELECTRICAL SERVICE

Check your available electrical service. The power supply available must be the same as that shown on the unit nameplate (found on left side of cabinet).

All models are equipped with a 3-prong service plug to provide proper service and safe positive grounding. Do not change plug in any way. Do not use an adapter plug. If your present wall outlet does not match your plug, call a qualified electrician to make the necessary corrections. SAVE CARTON for storage and this OWNER'S MANUAL for future reference. The carton is the best way to store unit during winter or when not in use.

## INSTALLATION HARDWARE

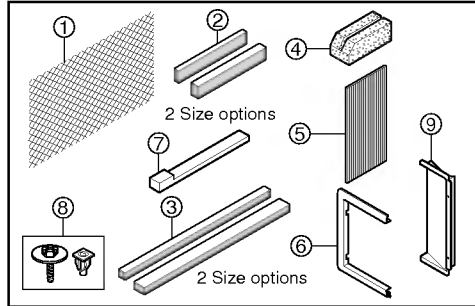

ITEM	NAME OF PARTS	QTY
①	PLASTIC GRILLE	1
②	HORIZONTAL INSULATION STRIPS	2
③	AROUND INSULATION STRIPS	2
④	SUPPORT BLOCK	2
⑤	BAFFLE	1
⑥	TRIM FRAME	2
⑦	SHIM	2
⑧	PLASTIC NUTS AND WASHER SCREWS	4
⑨	GRILLE REAR	1

## ⚠ CAUTION

To avoid risk of personal injury, property damage, or product damage due to the weight of this device and sharp edges that may be exposed:

- Air conditioners covered in this manual pose an excessive weight hazard. Two or more people are needed to move and install the unit.

To prevent injury or strain, use proper lifting and carrying techniques when moving unit.

- Carefully inspect location where air conditioner will be installed. Be sure it will support the weight of the unit over an extended period of time.
- Handle air conditioner with care. Wear protective gloves whenever lifting or carrying the unit. AVOID the sharp metal fins of front and rear coils.
- Make sure air conditioner does not fall during installation.

## REQUIRED TOOLS:

- Tight Fitting gloves
- Standard screwdriver
- Phillips screwdriver
- Pliers
- Sharp knife
- 3/8-inch open end wrench or adjustable wrench
- 1/4-inch hex socket and ratchet
- Tape measure
- Electric drill
- 1/4-inch drill bit

# INSTALLATION

## ⚠ CAUTION

We strongly recommend the removal of the old wall sleeve and the installation of a new LGE Wall Sleeve.

If you decide to keep the existing wall sleeve, you have to redirect the louvers at the back of the wall sleeve illustration. The use of pliers is recommended. If you DO NOT redirect, you run the risk of poor performance or product failure. This is not covered under the terms of the LGE warranty.

- Pick a location which will allow the conditioned air to blow into the area you want. Good installation with special attention to the proper position of the unit will lessen the chance that service will be needed.

## ITEMS IN INSTALLATION HARDWARE

You may not need all parts in the kit. Discard unused parts

ITEM (inches)		Qty.
Plastic grille	26 <sup>3</sup> / <sub>4</sub> x 16 <sup>1</sup> / <sub>2</sub>	1
Horizontal Insulation Strips	1 <sup>3</sup> / <sub>8</sub> x 5 <sup>5</sup> / <sub>8</sub> x 27 <sup>3</sup> / <sub>16</sub>	1
Around Insulation Strips	1 <sup>3</sup> / <sub>8</sub> x 1 <sup>3</sup> / <sub>8</sub> x 27 <sup>3</sup> / <sub>16</sub>	1
	1 <sup>3</sup> / <sub>8</sub> x 3 <sup>3</sup> / <sub>4</sub> x 61 <sup>1</sup> / <sub>2</sub>	1
Support Block	1 <sup>3</sup> / <sub>8</sub> x 1 <sup>3</sup> / <sub>8</sub> x 61 <sup>1</sup> / <sub>2</sub>	1
	1 <sup>3</sup> / <sub>4</sub> x 1 <sup>3</sup> / <sub>8</sub> x 4 <sup>5</sup> / <sub>16</sub>	2
Baffle	14 x 4 <sup>1</sup> / <sub>2</sub> x 1 <sup>1</sup> / <sub>8</sub>	1
Shim	13 x 1 x 3 <sup>3</sup> / <sub>4</sub>	2
Trim Frame		2
Washer Screw		4
Nuts(Plastic)		4
Grille Rear		1

## HOW TO INSTALL

- 1 Identify the existing wall sleeve before installing the unit from the listed below.

Brand	Wall Sleeve Dimensions (inches)		
	Width	Height	Depth
White-Westinghouse Frigidaire Carrier (52F series)	25-1/2	15-1/4	16, 17-1/2 or 22
General Electric /Hotpoint	26	15-5/8	16-7/8
Whirlpool	25-7/8	16-1/2	17-1/8 or 23
Fedders/Emerson	27	16-3/4	16-3/4 or 19-3/4
LGE	25-7/8	15-17/32	16-23/32
Emerson/Fedders	26-3/4	15-3/4	15
Carrier (51S Series)	25-3/4	16-7/8	18-5/8
Friedrich	27	16-3/4	16-3/4

## NOTICE

All wall sleeves used to mount the new Air Conditioner must be in sound structural condition and have a rear grille that securely attaches to sleeve, or rear flange that serves as a stop for the Air Conditioner,

- 2 Remove old air conditioner from existing wall sleeve.
- 3 Clean the interior of an existing sleeve. (Do not disturb seals.)
- 4 Wall sleeve must be securely fastened in wall before installing the air conditioner. Use the nails or screws through sleeve into wall, if needed. Repaint sleeve if needed.
- 5 Prepare the wall sleeve for installation of the unit. If you plan to use your existing wall sleeve, and it is not LGE, use procedure B or C below.

Procedure	Brand	Depth(inches)
A	LGE	16-23/32
B	White-Westinghouse Frigidaire Carrier (52F series)	16, 17-1/2 or 22
	General Electric /Hotpoint	16-7/8
	Whirlpool Carrier (51S series)	17-1/8 or 23 18-5/8
C	Fedders/Emerson	16-3/4 or 19-3/4
	Emerson/Fedders	15
	Friedrich	16-3/4

- 6 Install new unit into wall sleeve.

## ⚠ CAUTION

When installation is completed, replacement unit MUST have a rearward slope as shown. To achieve 1/4" slope, remove the backing from the 11-13/16" shim strips and attach them as shown below in Fig. 3. Place the higher portion of shim to the front of the rib on base of wall sleeve.

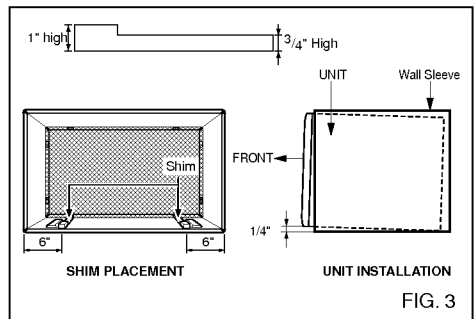

FIG. 3

## PROCEDURE A

- 1** If you are using the new sleeve (optionally supplied with your unit), skip to step 3. Otherwise, install the plastic grille from the kit. Cut the plastic grille to 25-1/2" wide and 15-1/4" high. Place the plastic grille to the inside of the wall sleeve at the rear flange.

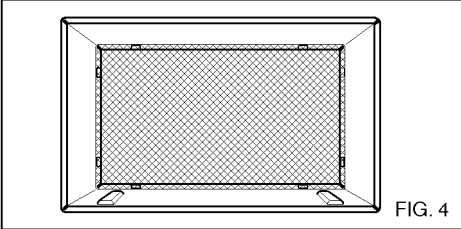

FIG. 4

- 2** Fasten the 4 washer screws to secure the grille to the wall sleeve. If you need plastic nuts to mount plastic grille to the inside of the wall sleeve, there are plastic nuts in the installation kit. The nuts are installed from the inside of the sleeve and are pressed into the square holes of the rear flanges.

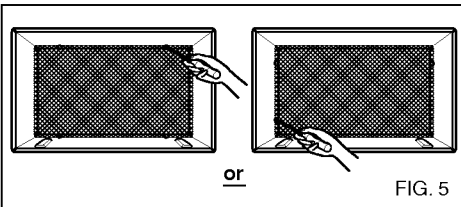

FIG. 5

- 3** Remove the backing from the Horizontal Insulation strip  $1\frac{3}{8} \times \frac{3}{8} \times 27\frac{3}{16}$  and attach that to the inside bottom of the sleeve as shown below. Remove the backing from the Around Insulation strip  $1\frac{3}{8} \times \frac{3}{4} \times 61\frac{1}{2}$  and attach that to the inside front of the sleeve as shown below.

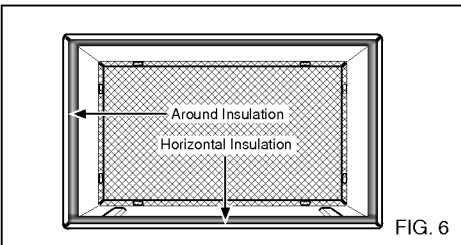

FIG. 6

- 4** Remove the metal rear grille and replace it with the plastic rear grille to improve unit energy efficiency. The plastic grille reduces the amount of hot air discharge that recirculates through the unit.

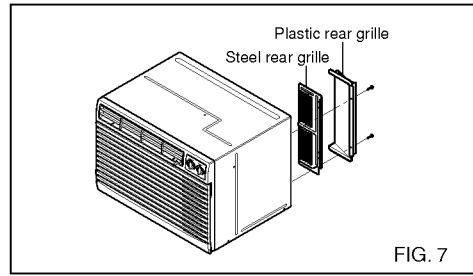

FIG. 7

- 5** Install the new unit into the wall sleeve.
- 6** To assemble trim, snap the tab of each piece into the slot of the other piece as shown below. Slide trim over the front of the air conditioner until trim is flush with sleeve as shown below.

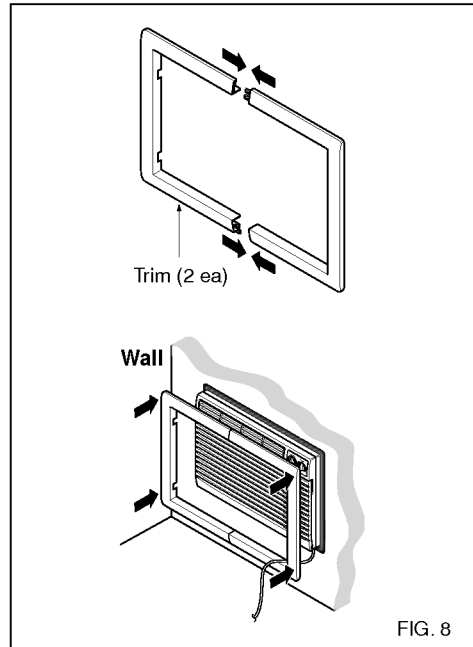

FIG. 8

### ▲ CAUTION

- Air conditioners covered in this manual pose an excessive weight hazard. Two or more people are needed to move and install the unit. To prevent injury or strain, use proper lifting and carrying techniques when moving unit.
- When handling the air conditioner, be careful to avoid cuts from sharp metal fins on front and rear coils.
- Make sure air conditioner does not fall during removal.

## PROCEDURE B

- 1** Redirect the louvers at the back of the wall sleeve to 60° angle as shown in the FIG. 9. The use of pliers is recommended.

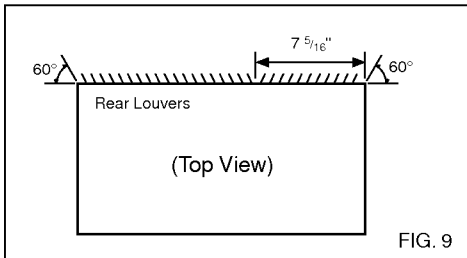

FIG. 9

- 2** If the wall sleeve already has a rear grille, skip to step 4. If the wall sleeve does not have a rear grille or louvered panel, install the plastic grille from the kit. Cut the plastic grille to 25-1/2" wide and 15-1/4" high. Place the plastic grille to the inside of the wall sleeve at the rear flange.

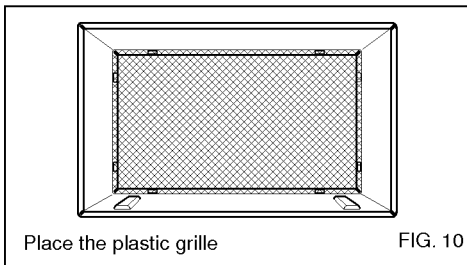

FIG. 10

- 3** Fasten the 4 washer screws to secure the grille to the wall sleeve. If you need plastic nuts to mount plastic grille to the inside of the wall sleeve, there are plastic nuts in the installation kit. The nuts are installed from the inside of the sleeve and are pressed into the square holes of the rear flanges.

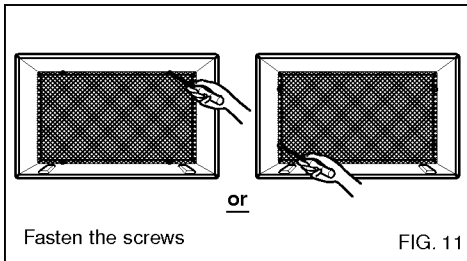

FIG. 11

- 4** Remove the backing from the Horizontal Insulation strip  $1\frac{3}{8} \times \frac{5}{8} \times 27\frac{3}{16}$  and attach that to the inside bottom of the sleeve as shown below. Remove the backing from the Around Insulation strip  $1\frac{3}{8} \times \frac{3}{4} \times 61\frac{1}{2}$  and attach that to the inside front of the sleeve as shown below.

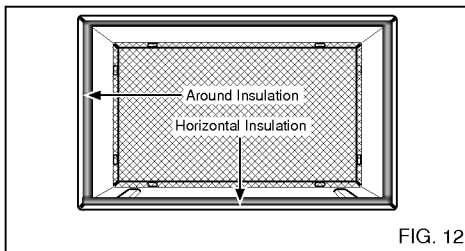

FIG. 12

- 5** Remove the metal rear grille and replace it with the plastic rear grille to improve unit energy efficiency. The plastic grille reduces the amount of hot air discharge that recirculates through the unit.

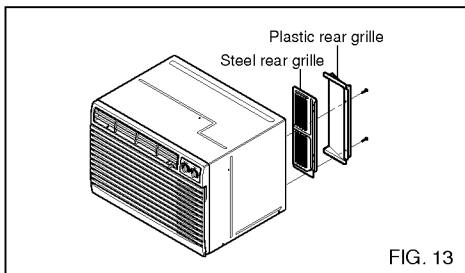

FIG. 13

- 6** If the depth of your existing wall sleeve is less than or equal to 18", skip to step 7. Otherwise, cut the baffles and the support blocks according to length "A" in the table below.

Depth "D" of the existing wall sleeve (inches)	Length "A" (inches)	
$18 < D \leq 18\text{-}\frac{5}{8}$	$\frac{3}{4}$	
$18\text{-}\frac{5}{8} < D \leq 19\text{-}\frac{3}{4}$	$1\text{-}\frac{3}{4}$	
$19\text{-}\frac{3}{4} < D \leq 22$	4	

FIG. 14

## PROCEDURE B

- 7** Remove the backing from the support blocks and attach them to the inside of the wall sleeve as shown FIG 15. Slide the baffle into slots of the support blocks.

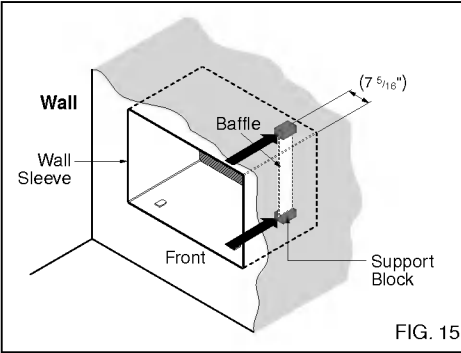

- 8** Install the new unit into the wall sleeve.

- 9** To assemble trim, snap the tab of each piece into the slot of the other piece as shown below. Slide trim over the front of the air conditioner until trim is flush with sleeve as shown below.

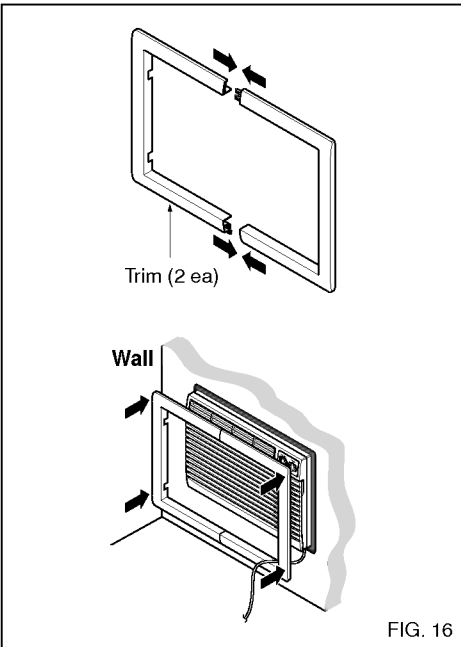

## ⚠ CAUTION

- Air conditioners covered in this manual pose an excessive weight hazard. Two or more people are needed to move and install the unit.  
To prevent injury or strain, use proper lifting and carrying techniques when moving unit.
- When handling the air conditioner, be careful to avoid cuts from sharp metal fins on front and rear coils.
- Make sure air conditioner does not fall during removal.

## PROCEDURE C

- 1** Redirect the louvers at the back of the wall sleeve to 60° angle as shown in the FIG 17. The use of pliers is recommended.

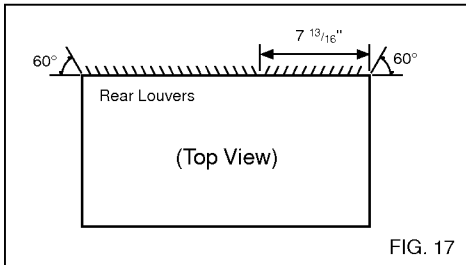

- 2** If the wall sleeve already has a rear grille, skip to step 4. If the wall sleeve does not have a rear grille or louvered panel, install the plastic grille from the kit. Cut the plastic grille to 26-1/2" wide and 15-1/2" high. Place the plastic grille to the inside of the wall sleeve at the rear flange.

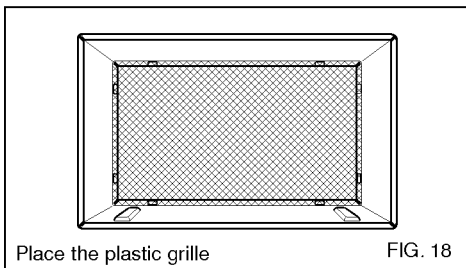

- 3** Fasten the 4 washer screws to secure the grille to the wall sleeve. If you need plastic nuts to mount plastic grille to the inside of the wall sleeve, there are plastic nuts in the installation kit. The nuts are installed from the inside of the sleeve and are pressed into the square holes of the rear flanges.

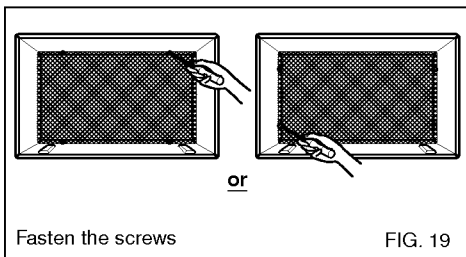

- 4** Remove the backing from the Horizontal Insulation strip  $1\frac{3}{8} \times 1\frac{3}{8} \times 27\frac{3}{16}$  and attach that to the inside bottom of the sleeve as shown below. Remove the backing from the Around Insulation strip  $1\frac{3}{8} \times 1\frac{3}{8} \times 61\frac{1}{2}$  and attach that to the inside front of the sleeve as shown below.

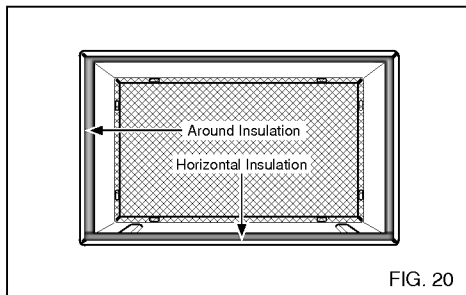

- 5** If the depth of your existing sleeve is less than or equal to 18", skip to step 7. Otherwise, cut the baffles and the support blocks according to Length "A" in the table below.

Depth "D" of the existing wall sleeve (inches)	Length "A" (inches)
$18 < D \leq 18\text{-}\frac{5}{8}$	$\frac{3}{4}$
$18\text{-}\frac{5}{8} < D \leq 19\text{-}\frac{3}{4}$	$1\text{-}\frac{3}{4}$
$19\text{-}\frac{3}{4} < D \leq 22$	4

FIG. 21

- 6** Remove the backing from the support blocks and attach them to the inside of the wall sleeve as shown FIG 22. Slide the baffles into slots of the support blocks

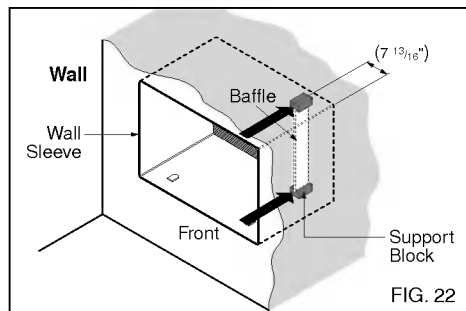



## PROCEDURE C

- 7** Remove the backing from the 13" shim strips and attach them as shown below in Fig. 24. The higher portion of shim is to be placed in front of the rib on the base of wall sleeve.

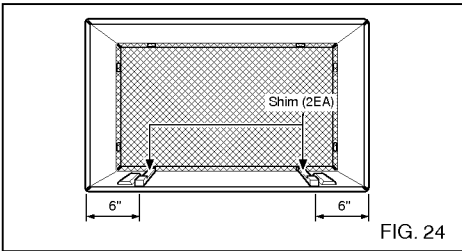
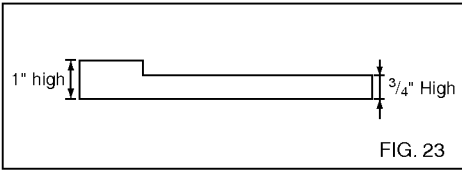

- 8** Remove the metal rear grille and replace it with the plastic rear grille to improve unit energy efficiency. The plastic grille reduces the amount of hot air discharge that recirculates through the unit.

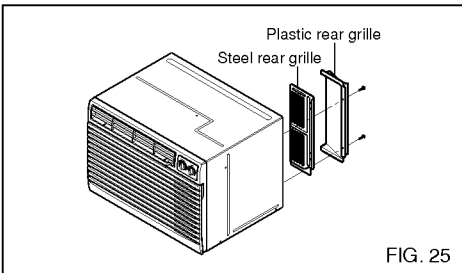

- 9** Install the new unit into the wall sleeve

- 10** To assemble trim, snap the tab of each piece into the slot of the other piece as shown below. Slide trim over the front of the air conditioner until trim is flush with sleeve as shown below.

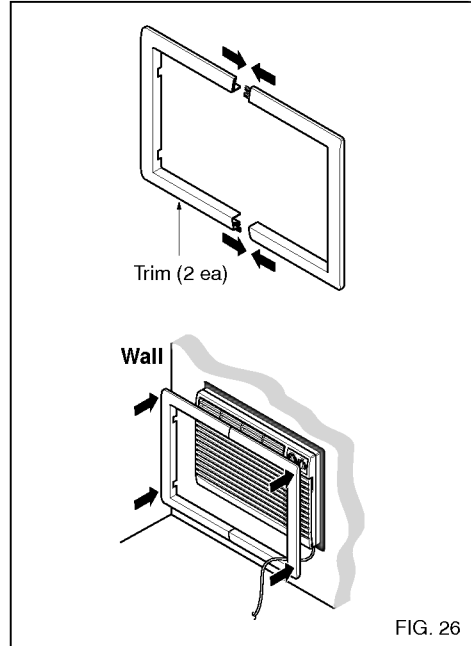

### ⚠ CAUTION

- Air conditioners covered in this manual pose an excessive weight hazard. Two or more people are needed to move and install the unit. To prevent injury or strain, use proper lifting and carrying techniques when moving unit.
- When handling the air conditioner, be careful to avoid cuts from sharp metal fins on front and rear coils.
- Make sure air conditioner does not fall during removal.

# Operating Instructions

The controls will look like one of the following:

## Controls – Cooling & Heating

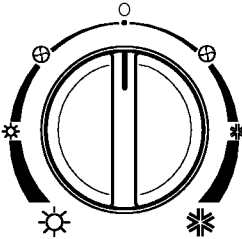
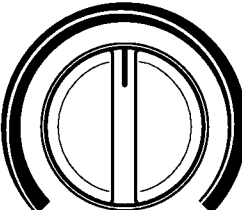
<p style="text-align: center;"><b>Operation</b></p> 	<p>Off ( ○ ) : Turns the air conditioner off.</p> <p>Fan ( ⊕ ) : The low fan speed operation without cooling (heating).</p> <p>Low Cool ( * ) : Cooling with the low speed fan operation.</p> <p>High Cool ( * ) : Cooling with the high speed fan operation.</p> <p>Low Heat ( * ) : Heating with the low speed fan operation.</p> <p>High Heat ( * ) : Heating with the high speed fan operation.</p>
<p style="text-align: center;"><b>Thermostat</b></p>  <p style="text-align: center;">Warmer                      Cooler</p>	<p>Turn the thermostat control to the desired setting. The central position is a normal setting for average conditions. You can change this setting, if necessary, in accordance with your temperature preference.</p> <p>The thermostat automatically controls cooling or heating, but the fan runs continuously whenever the air conditioner is in operation. If the room is too warm, turn the thermostat control clockwise. If the room is too cool, turn the thermostat control counterclockwise.</p>

### • THE AIR CONDITIONER

This automatically controls the temperature of the indoor air.

The compressor will turn on and off to keep the room at the setting temperature.

In the heating operation, the electric heater will turn on and off to keep the room at the setting temperature.

### ▲ CAUTION

When the air conditioner has been performed its cooling or heating operation and is turned off or set to the fan position, wait at least 3 minutes before resetting to the cooling operation again.

### • HEAT PUMP MODELS

When the outdoor temperature is lower than -4°C (24°F), the electric heater will turn on instead of the heat pump.

A slight heat odor may come from the unit when first switching to HEAT after the cooling season is over. This odor, caused by fine dust particles on the heater, will disappear quickly. This is harmless.

Additional controls and important information.

## Ventilation Control

Push the lever to the "CLOSE" position to cool, heat or recirculate room air only.

Pull the lever to the "OPEN" position to exhaust smoke or stale air from the room.

This feature is best used in conjunction with the FAN ONLY position.

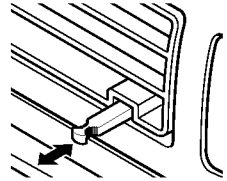

PULL OPEN / PUSH CLOSE

## Air Direction

The direction of air can be controlled by adjusting the horizontal and vertical louvers.

### • HORIZONTAL AIR-DIRECTION CONTROL

The horizontal air direction is adjusted by moving the vertical louver.

The lever for the vertical louver is located in the right and left side of the air discharge.

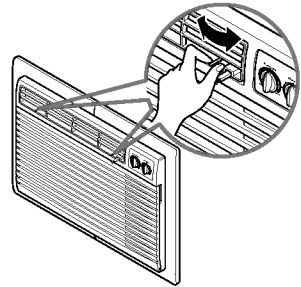

### • VERTICAL AIR-DIRECTION CONTROL

The vertical air direction is adjusted by moving the horizontal louver.

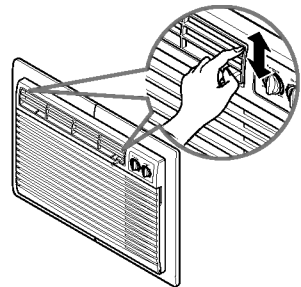

## Maintenance and Service

TURN THE AIR CONDITIONER OFF AND REMOVE THE PLUG FROM THE POWER OUTLET.

### Air Filter Cleaning

The air filter should be checked at least twice a month to see if cleaning is necessary. Trapped particles in the filter will build up and block the airflow. This reduces the cooling capacity and also causes an accumulation of frost on the cooling coils.

If the filter becomes worn or damaged you should replace immediately. Replacement filters are available from your salesperson, dealer, and the authorized customer service centers.

1. Open the inlet grille downward by pulling out the top of the inlet grille.
2. Remove the air filter from the front grille assembly by pulling the air filter up slightly.
3. Wash the filter using lukewarm water below 40 °C (104 °F).
4. Gently shake the excess water from the filter completely. Replace the filter.

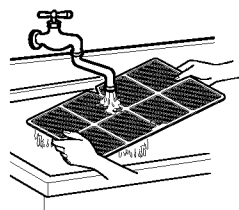
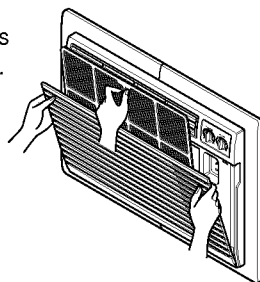

### How to Attach Front Grille to Cabinet

The front grille can be removed for cleaning or to check the model and serial numbers. For your safety, you should attach the front grille as the following procedures.

1. Pull down front grille from the cabinet top.
2. Push front grille's tips toward the cabinet in order to insert front grille's tabs into the cabinet.
3. Open the inlet grille.
4. Tighten the screw through the front grille into the plate of control box.
5. Close inlet grille.

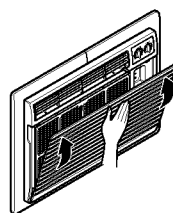
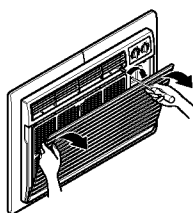
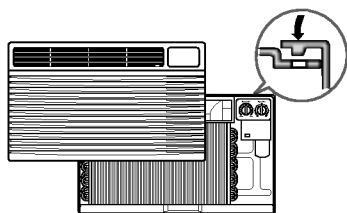

## Normal Operation

- You may hear a pinging noise caused by water being picked up and thrown against the condenser on rainy days or when the humidity is high. This design feature helps remove moisture and improve efficiency.
- You may hear the thermostat click when the compressor cycles on and off.
- Water will collect in the base pan during high humidity or on rainy days. The water may overflow and drip from the outdoor side of the unit.
- The fan will run even when the compressor does not.

## Services

To save time and expense, check the following before calling for an authorized service center

**For Models installed in North America-**If service or parts are required first make the check recommended below.

## Abnormal Operation

Problem	Possible Causes	What To Do
<b>Air conditioner does not start</b>	■ <i>The air conditioner is unplugged.</i>	• Make sure the air conditioner plug is pushed completely into the outlet.
	■ <i>The fuse is blown/circuit breaker is tripped.</i>	• Check the house fuse/circuit breaker box and replace the fuse or reset the breaker.
	■ <i>Power failure.</i>	• If power failure occurs, turn the mode control to <b>OFF</b> . When power is restored, wait 3 minutes to restart the air conditioner to prevent tripping of the compressor overload.
	■ <i>The current interrupter device is tripped.</i>	• Press the RESET button located on the power cord plug. If the RESET button will not stay engaged, discontinue use of the air conditioner and contact a qualified service technician.
<b>Air conditioner does not cool as it should</b>	■ <i>Airflow is restricted.</i>	• Make sure there are no curtains, blinds, or furniture blocking the front of the air conditioner.
	■ <i>The THERMOSTAT may not be set high enough.</i>	• Turn the knob to cooler. The highest setting provides maximum cooling.
	■ <i>The air filter is dirty.</i>	• Clean the filter at least every 2 weeks. See the operating instructions section.
	■ <i>The room may have been hot.</i>	• When the air conditioner is first turned on, you need to allow time for the room to cool down.
	■ <i>Cold air is escaping.</i>	• Check for open furnace floor registers and cold air returns. • Set the air conditioner's vent to the closed position.
<b>Air conditioner freezing up</b>	■ <i>Cooling coils have iced up.</i>	• See Air Conditioner Freezing Up below.
	■ <i>Ice blocks the air flow and stops the air conditioner from cooling the room.</i>	• Set the mode control at <b>FAN ONLY</b> or <b>HIGH COOL</b> with the thermostat towards the left.