



# LCD Colour Television OWNER'S MANUAL



BZ03

Please read this manual carefully before operating your set.  
Retain it for future reference.  
Record model number and serial number of the set.  
See the label attached on the back cover and quote this information to your dealer when you require service.

Model number :  
Serial number :



---

# Contents

---

<b>Installation</b>	<b>3</b>
<b>Location and function of controls</b>	<b>4</b>
Remote control handset	
Battery installation / Side panel	
<b>Basic operation</b>	<b>7</b>
On and off / Programme selection	
Volume adjustment / Quick view	
Mute function / Auto Demonstration	
TV Swivel function	
On screen language selection (option)	
<b>On screen menus</b>	<b>8</b>
Menu selection	
<b>Setting up TV stations</b>	<b>9</b>
Auto programme tuning	
Manual programme tuning	
Fine Tuning / Programme edit	
Favourite programme	
Calling the programme table	
<b>Picture adjustment</b>	<b>14</b>
PSM (Picture Status Memory)	
Picture adjustment / DRP (Digital Reality Picture)	
CSM (Colour Status Memory) / Picture format	
<b>Sound adjustment</b>	<b>16</b>
SSM (Sound Status Memory)	
Sound adjustment / Stereo/Dual reception	
NICAM reception (option) / Sound output selection	
<b>Other functions</b>	<b>18</b>
TV, AV and PC modes	
Auto AV switching / Child lock	
Auto sleep / Sleep timer	
<b>PIP operation (option)</b>	<b>20</b>
On and off / Input mode selection for sub picture	
Swapping between main and sub picture	
Programme selection for sub picture	
Sub picture size / Sub picture freeze	
Sub picture position change / Programme scan	
<b>Teletext (option)</b>	<b>22</b>
Switch on/off	
SIMPLE text / TOP text (option)	
FASTEXT / Special teletext functions	
<b>Connection of external equipment</b>	<b>25</b>
Aerial socket	
Euro scart socket	
Audio/Video in sockets	
S-Video/Audio in sockets (S-Video) (option)	
Headphone socket	
<b>Connection of PC</b>	<b>27</b>
PC in socket (D-Sub jack)	
Menu selection / PC Setup	
<b>Troubleshooting check list</b>	<b>30</b>

---

## Installation

---

### Power

This set operates on an AC mains supply, the voltage is as indicated on the label on the back cover. Never apply DC power to the set. In the event of thunderstorms or powercuts, please pull out the aerial and mains plugs.

- Open the back panel cover.
- After connecting the power cord to the set, connect the power cord to an AC mains.
- Close the back panel cover.

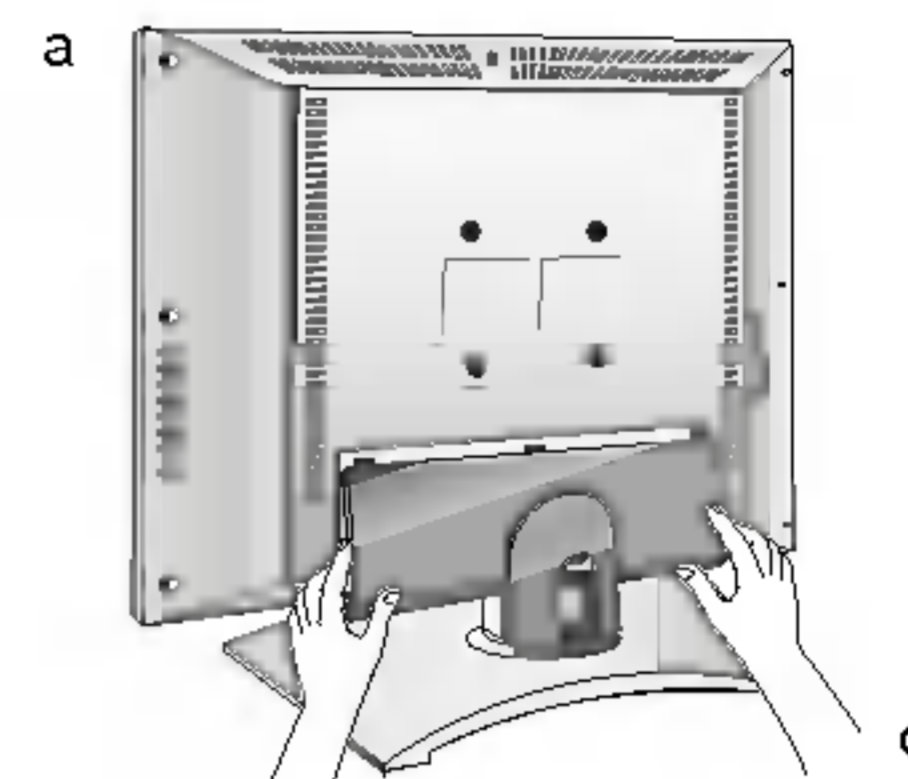

### Warning

To prevent fire or shock hazard, do not expose the set to rain or moisture. Do not rub or strike the Active Matrix LCD with anything hard as this may scratch, mar, or damage the Active Matrix LCD permanently.

The working life of this set is 7 years since the date of delivery to consumer.

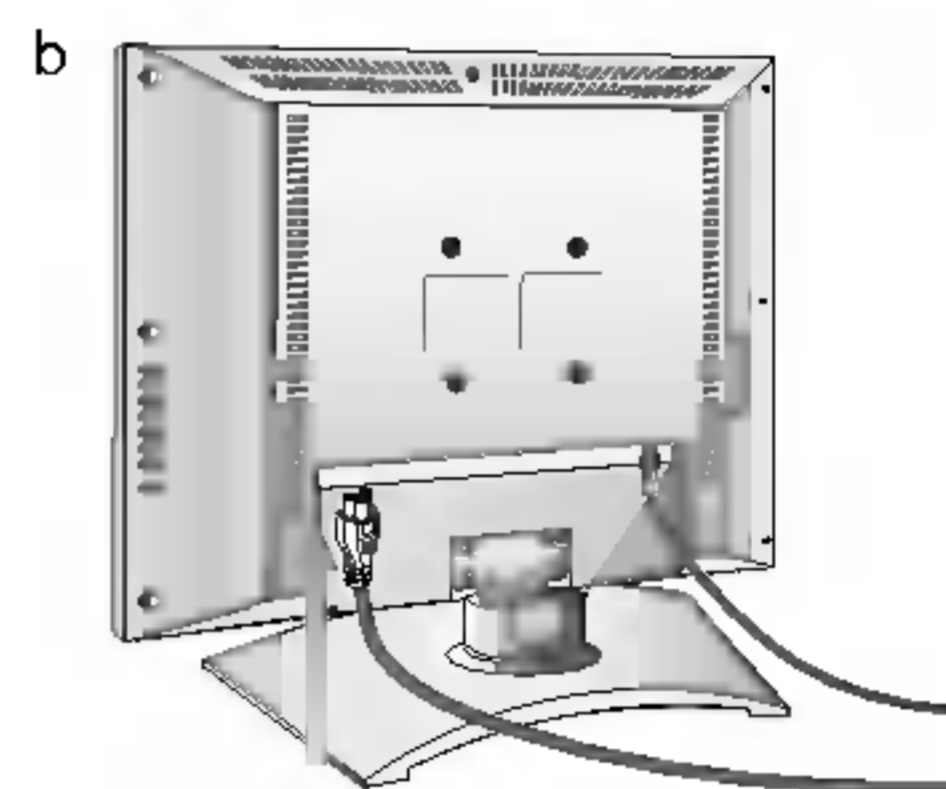

### Service

Never remove the back cover of the set as this can expose you to high voltage and other hazards. If the set does not operate properly, unplug it and call your dealer.

### Aerial

Connect the aerial cable to the socket marked  $75 \Omega$  on the back. For the best reception an outdoor aerial should be used.

### Location

Position your set so that no bright light or sunlight falls directly onto the screen. Care should be taken not to expose the set to any unnecessary vibration, moisture, dust or heat. Also ensure that the set is placed in a position to allow a free flow of air. Do not cover the ventilation openings on the back cover.

This standing angle can be adjusted as shown in pictures.

When you install the set to use the wall mounting bracket (optional parts), fix it carefully so as not to drop. The set has Kensington Security System Connector on the back panel. Connect the Kensington Security system cable (not supplied).

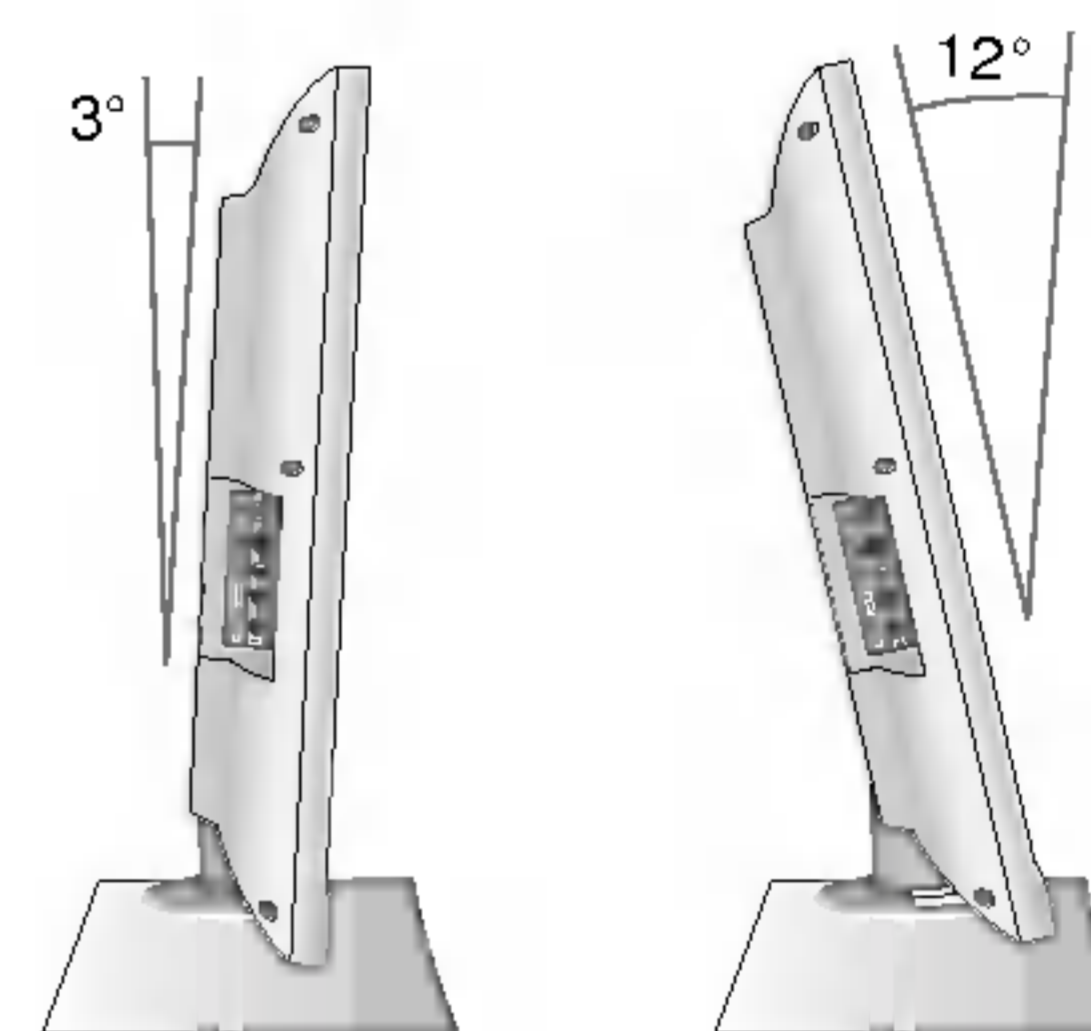

### Cleaning

Unplug the set before cleaning the face of the LCD Screen. Dust the set by wiping the screen and the cabinet with a soft, clean cloth. If the screen requires additional cleaning, use a clean, damp cloth. Do not use liquid cleaners or aerosol cleaners.

**Manufactured under license from Dolby Laboratories. "Dolby" "Pro Logic" and the double-D symbol are trademarks of Dolby Laboratories.**

## Location and function of controls

All the functions can be controlled with the remote control handset. Some functions can also be adjusted with the buttons on the side panel of the set. Only the remote control handset supplied will operate this set.

### Remote control handset

Before you use the remote control handset, please install the batteries. See the next page.

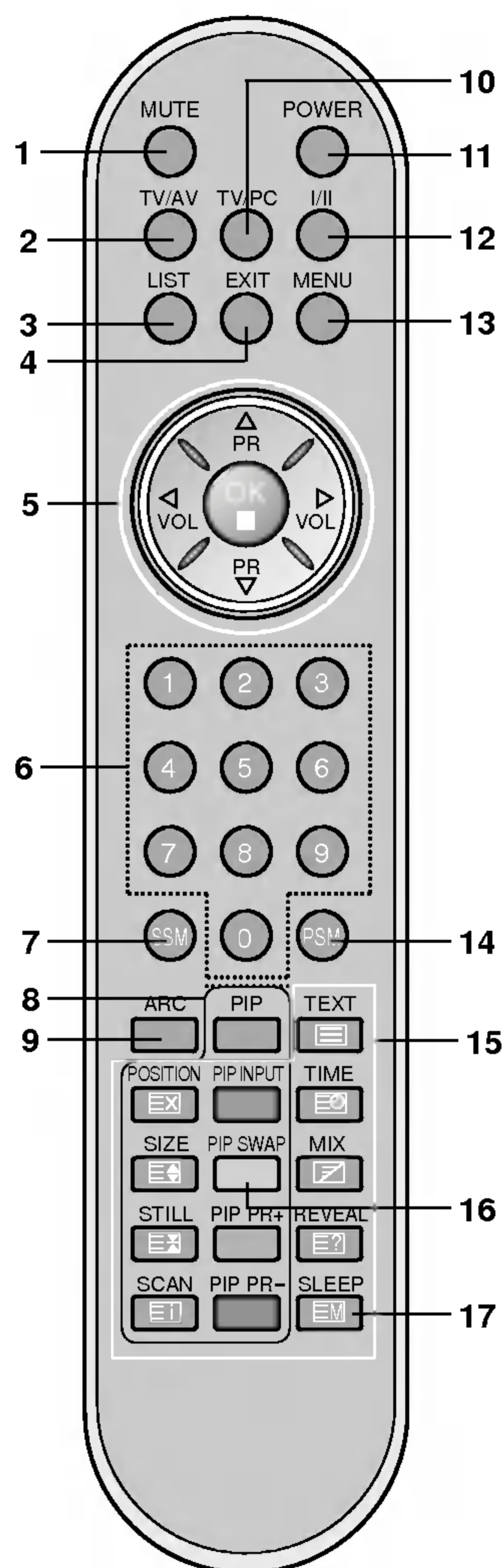

1. **MUTE**  
switches the sound on or off.
2. **TV/AV**  
selects TV or AV monitor mode.
3. **LIST**  
displays the programme table.
4. **EXIT**  
exits from each mode.
5. **▲ / ▼ (Programme Up/Down)**  
selects a programme or a menu item.  
switches the set on from standby.
6. **NUMBER BUTTONS**  
switches the set on from standby and selects a programme.
7. **SSM (Sound Status Memory)**  
recalls your preferred sound setting.
8. **PIP BUTTONS (option)**  
**PIP**  
switches the sub picture on or off.  
**PIP PR +/-**  
selects a programme for the sub picture.  
**PIP SWAP**  
alternates between main and sub picture.  
**PIP INPUT**  
selects the input mode for the sub picture.
9. **ARC**  
select your desired picture format.
10. **POWER**
11. **I/II**
12. **TV/PC**
13. **MENU**
14. **PSM**
15. **TEXT**
16. **MIX**
17. **SLEEP**

## Location and function of controls

- 10. TV/PC**  
selects TV or PC monitor mode.  
clears the menu from the screen.  
switches the set on from standby.
- 11. POWER**  
switches the set on from standby or off to standby.
- 12. I/II**  
selects the language during dual language broadcast.  
selects the sound output (option).
- 13. MENU**  
selects a menu.
- 14. PSM (Picture Status Memory)**  
recalls your preferred picture setting.
- 15. TELETEXT BUTTONS (option)**  
These buttons are used for teletext.  
For further details, see the 'Teletext' section.
- 16. PIP SWAP**  
returns to the previously viewed programme.  
selects a favourite programme.
- 17. SLEEP**  
sets the sleep timer.

**Note :** If you turn on the TXT in PIP, some PIP keys, such as **POSITION**, **PIP INPUT** or **PIP PR +/-** etc. will work as TXT keys.

### Battery installation

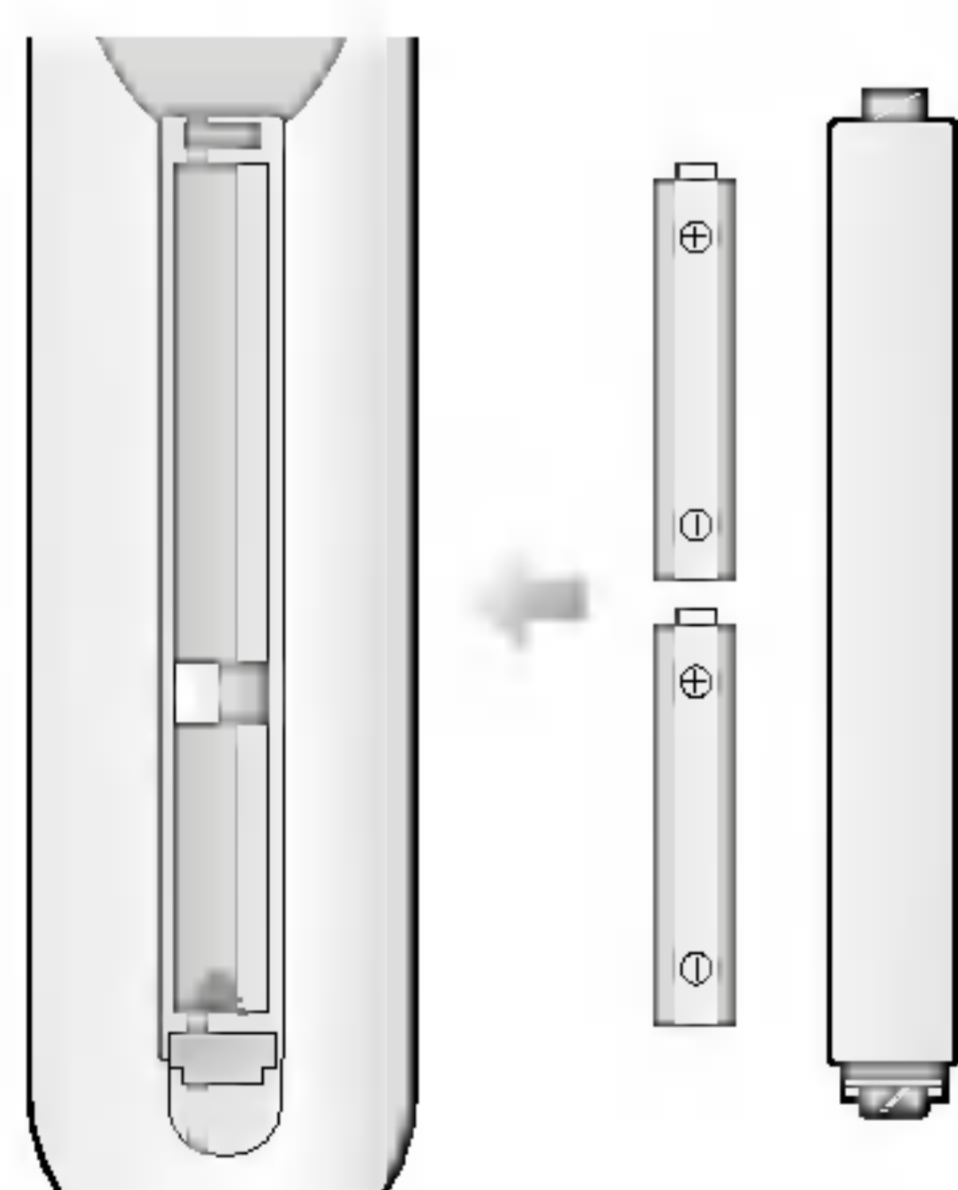

The remote control handset is powered by two AAA/Alkaline type batteries. To load the batteries, turn the remote control handset over and open the battery compartment. Install two batteries as indicated by the polarity symbols (+ and -) marked inside the compartment.

**Note :** To avoid damage from possible battery leakage, remove the batteries if you do not plan to use the remote control handset for an extended period of time.

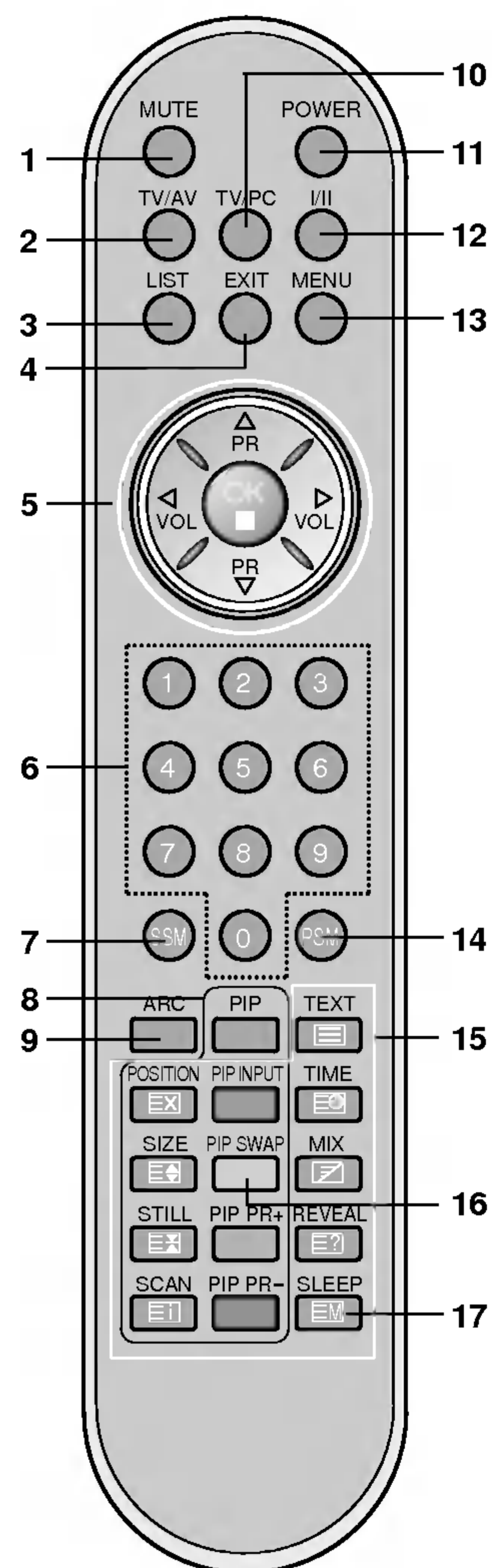

---

## Location and function of controls

---

### Side panel

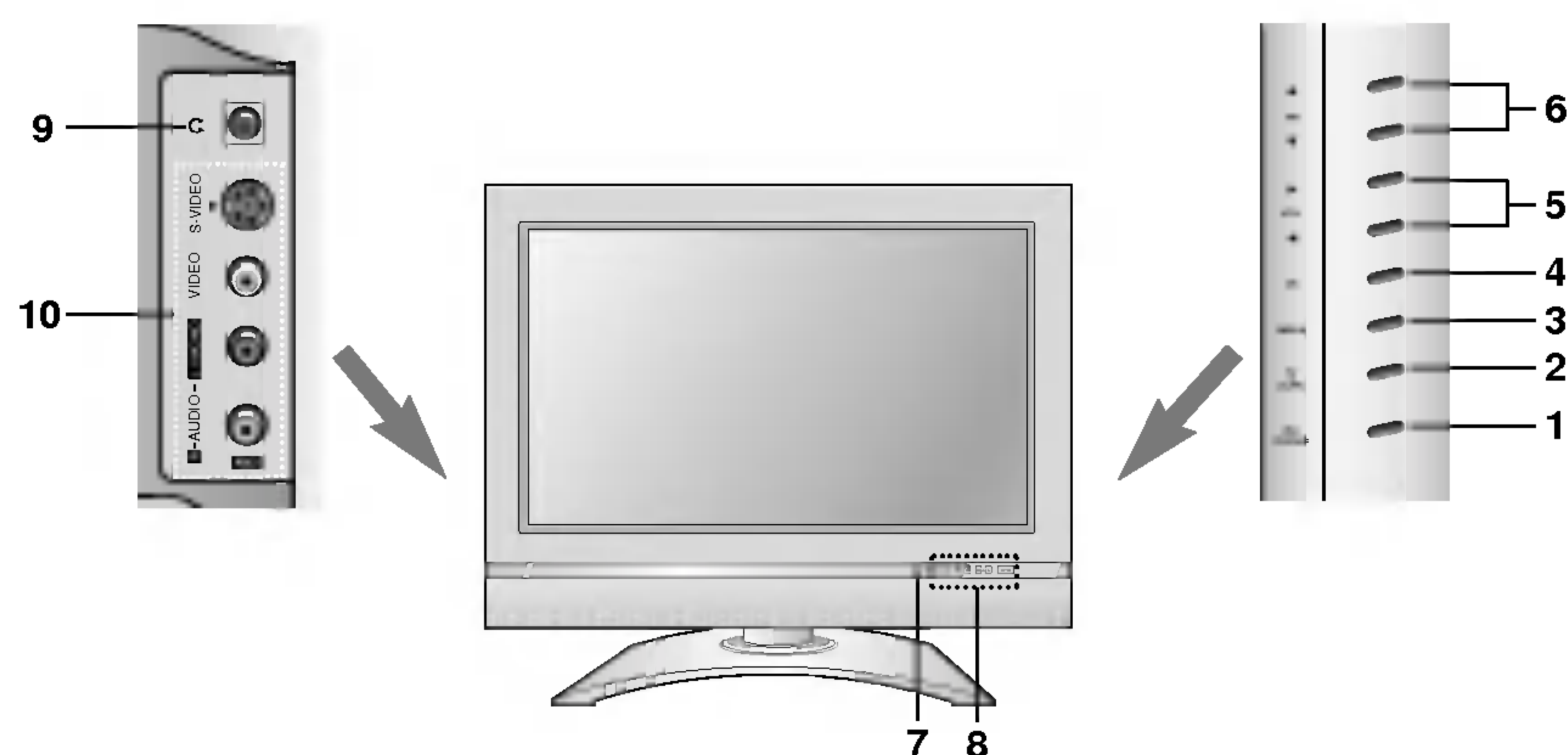

- 1. ON/OFF (⏻/⏻)**  
switches the set on from standby or off to standby.  
**Note :** *Power line lives even when the power is off.*
- 2. TV/AV/PC**  
selects TV, AV or PC monitor mode.  
clears the menu from the screen.  
switches the set on from standby.
- 3. MENU**  
selects a menu.
- 4. OK**  
accepts your selection or displays the current mode.
- 5. ◀ / ▶ (Volume Up/Down)**  
adjusts the volume.  
adjusts menu settings.
- 6. ▲ / ▼ (Programme Up/Down)**  
selects a programme or a menu item.  
switches the set on from standby.
- 7. REMOTE CONTROL SENSOR**
- 8. LED (Light Emitting Diode) DISPLAY**  
illuminates brightly when the set is switched on.  
⏻ : POWER/STANDBY indicator  
MONO : MONO indicator  
STEREO : STEREO indicator  
DUAL : DUAL indicator  
DPM : DPM indicator
- 9. HEADPHONE SOCKET**  
Connect the headphone plug to this socket.
- 10. AUDIO/VIDEO IN SOCKETS (AV3)**  
Connect the audio/video out sockets of external equipment to these sockets.  
**S-VIDEO/AUDIO IN SOCKETS (S-VIDEO)**  
Connect the video out socket of an S-VIDEO VCR to the **S-VIDEO** socket.  
Connects the audio out sockets of the S-VIDEO VCR to the audio sockets as in **AV3**.

---

## Basic operation

---

### On and off

1. Press the **POWER**, ▲ / ▼, **TV/AV**, **TV/PC** or **NUMBER** buttons to switch it on fully.
2. Press the **POWER** button. The set reverts to standby mode.
3. Pull out mains plugs to switch the set off.

**Note :** If, while the set is switched on, the mains plug is disconnected the set will switch to standby or power on when the mains plug is replaced in the mains power socket.

### Programme selection

You can select a programme number with the ▲ / ▼ or **NUMBER** buttons.

### Volume adjustment

Press the ◀ / ▶ button to adjust the volume.

### Quick view

Press the **PIP SWAP** button to view the last programme you were watching.

**Note :** This function works only when **Favourite programme** is set to **Off**. Otherwise each press of this button will select a stored favorite programme.

### Mute function

Press the **MUTE** button. The sound is switched off and the display  appears.

You can cancel it by pressing the **MUTE**, ◀ / ▶, **I/II**, or **SSM** button.

### Auto Demonstration

To review all the menus programmed in the set, press the **OK** button of the side panel controls for about 10 seconds. To stop auto demonstration, press any button of the side panel controls and the **POWER** button of the remote control.

### TV Swivel function

You can manually turn TV set at left or right direction by 25 degrees, so that the watching degree is suitable for your position.

### On screen language selection (option)

The menu can be displayed on the screen in your desired language. First select your language.

1. Press the **MENU** button and then ▲ / ▼ button to select the Special menu.
2. Press the **OK** or ▶ button and then ▲ / ▼ button to select **Language**.
3. Press the ◀ / ▶ button to select your desired language. All the on screen displays will appear in the selected language. Press the **OK** button.
4. Press the **EXIT** button to return to normal TV viewing.

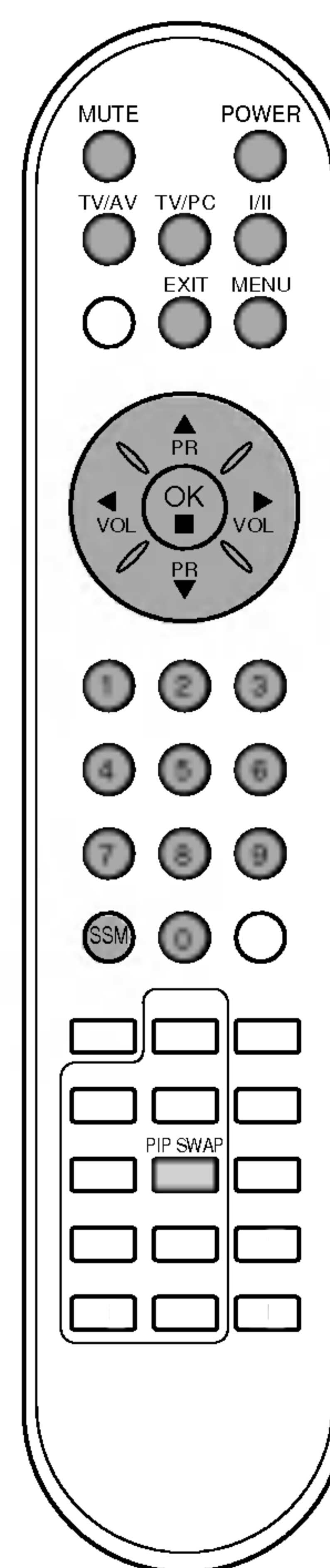

## On screen menus

### Menu selection

1. Press the **MENU** button and then ▲ / ▼ button to display each menu.
2. Press the **OK** or ► button and then ▲ / ▼ button to select a menu item.
3. Change the setting of an item in the sub or pull-down menu with ◀ / ▶ button.

You can move to the higher level menu by pressing the **OK** button and to move to the lower level menu by pressing the **MENU** button.

#### Note :

- a. In the PC mode, the Station menu is not displayed.
- b. In the TV/AV mode, the RGB-PC menu is not displayed.
- c. In the teletext mode, menus are not displayed.
- d. On some models, the **Language** will not be displayed.

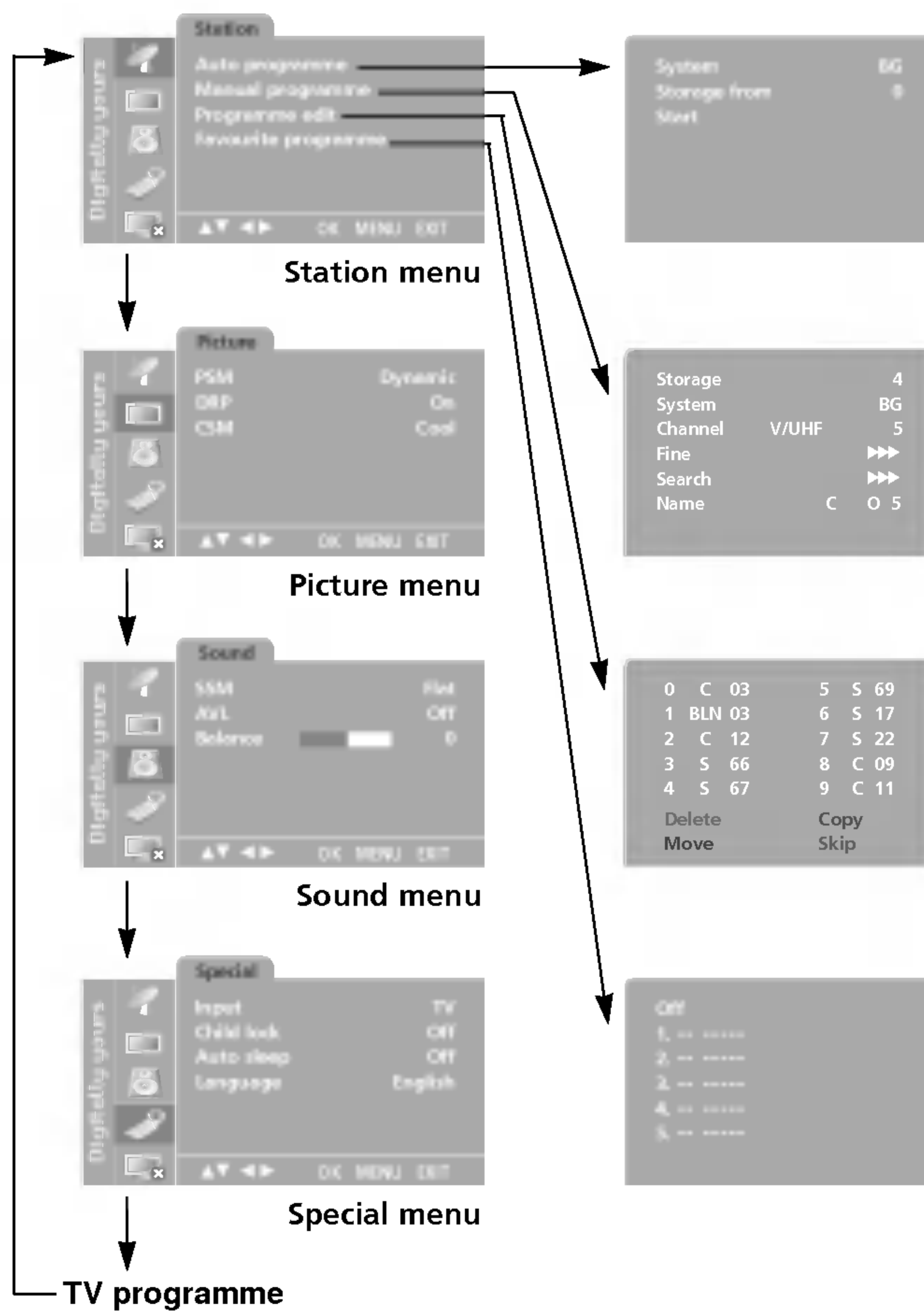
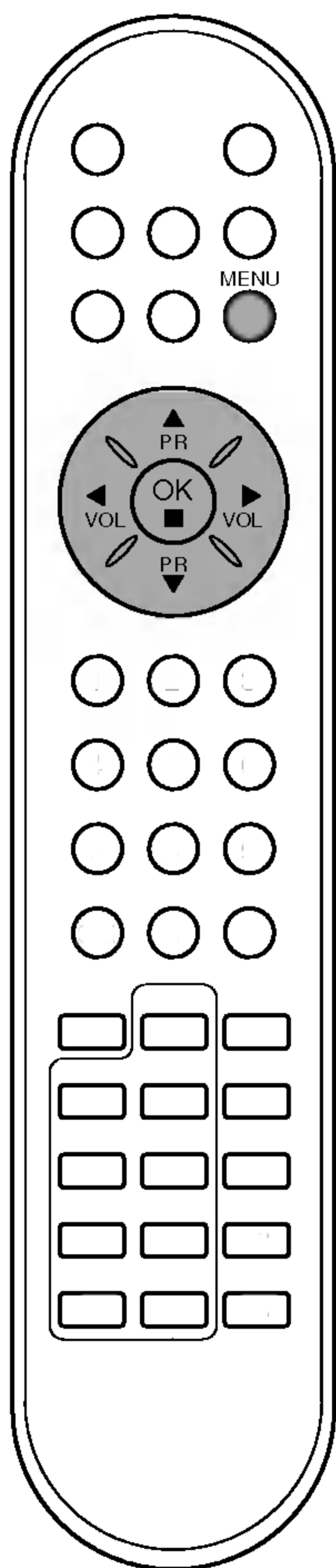



## Setting up TV stations

Up to 100 TV stations can be stored by programme numbers (0 to 99). Once you have preset the stations, you will be able to use the ▲ / ▼ or NUMBER buttons to scan the stations you have programmed. Stations can be tuned using automatic or manual modes.

### Auto programme tuning

All stations that can be received are stored by this method. It is recommended that you use auto programme during installation of this set.

1. Press the **MENU** button and then ▲ / ▼ button to select the Station menu.
2. Press the **OK** or ► button and then ▲ / ▼ button to select **Auto programme**.

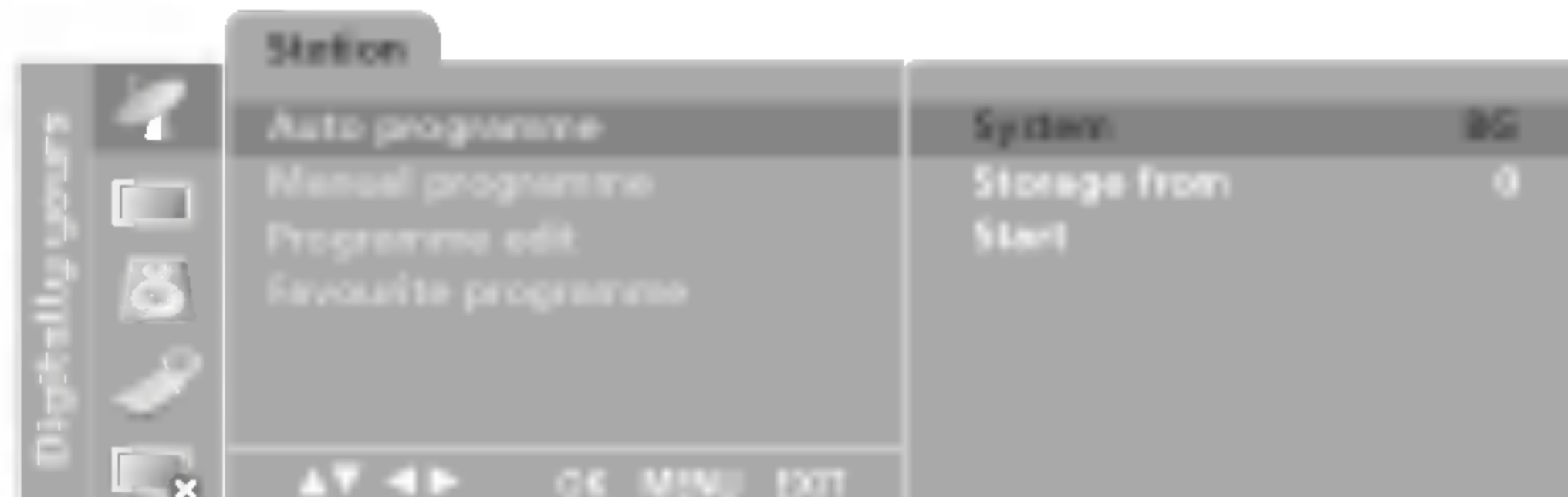

3. Press the **OK** or ► button. Select a TV system with the ◀ / ▶ button on the **System** menu;
  - L** : SECAM L/L' (France)
  - BG** : PAL B/G, SECAM B/G (Europe/East Europe)
  - I** : PAL I/II (U.K./Ireland)
  - DK** : PAL D/K, SECAM D/K (East Europe)
4. Press the ▲ / ▼ button to select **Storage from**.
5. Select the beginning programme number with the ◀ / ▶ button or NUMBER buttons on the **Storage from** pull-down menu. Any number under 10 is entered with a numeric '0' in front of it, i.e. '05' for 5.
6. Press the ▲ / ▼ button to select **Start**.
7. Press the ► button to begin auto programming.

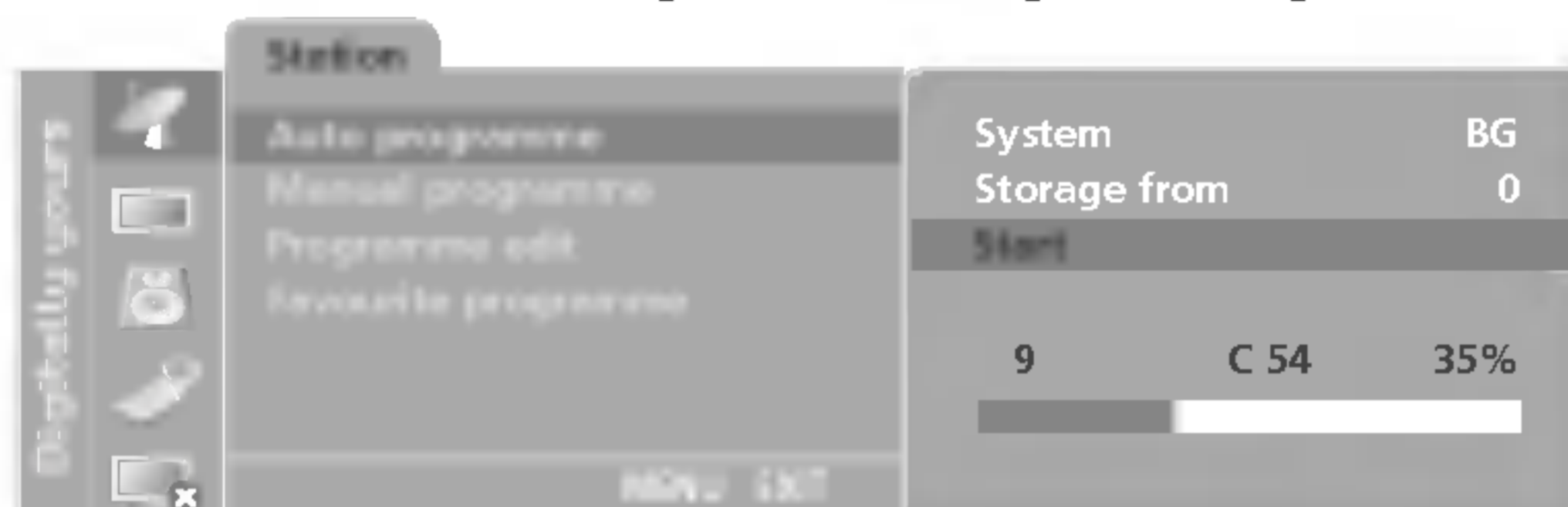

All receivable stations are stored. The station name is stored for stations which broadcast VPS (Video Programme Service), PDC (Programme Delivery Control) or TELETEXT data. If no station name can be assigned to a station, the channel number is assigned and stored as **C** (V/UHF 01-69) or **S** (Cable 01-47), followed by a number.

To stop auto programming, press the **MENU** button. When auto programming is completed, the **Programme edit** menu appears on the screen. See the 'Programme edit' section to edit the stored programme.

8. Press the **EXIT** button to return to normal TV viewing.



Station menu

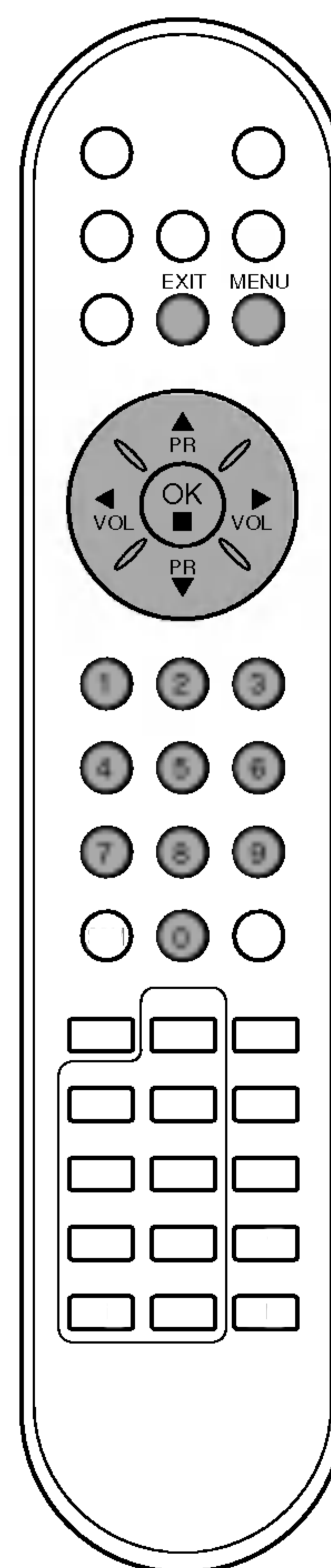

## Setting up TV stations



Station menu

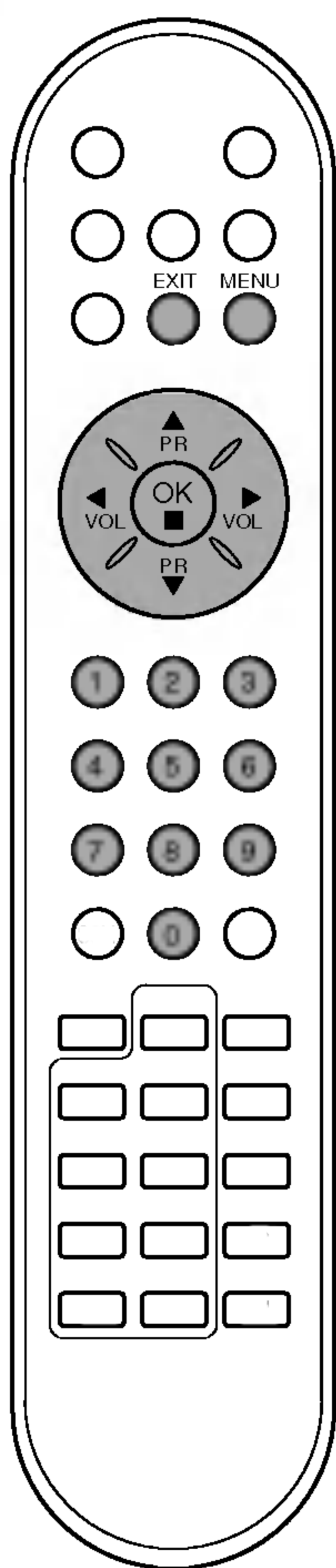

### Manual programme tuning

Manual programme lets you manually tune and arrange the stations in whatever order you desire. Also you can assign a station name with five characters to each programme number.

1. Press the **MENU** button and then **▲ / ▼** button to select the Station menu.
2. Press the **OK** or **▶** button and then **▲ / ▼** button to select **Manual programme**.
3. Press the **OK** or **▶** button and then **▲ / ▼** button to select **Storage**.

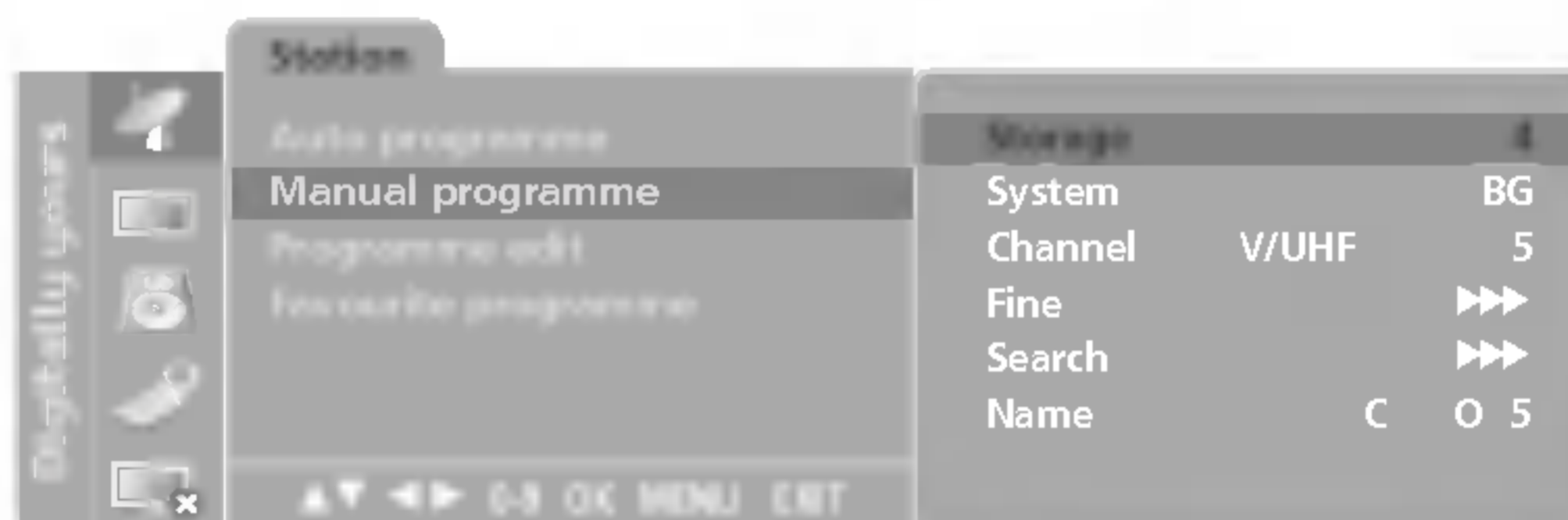

4. Select the desired programme number (0 to 99) with the **◀ / ▶** button or **NUMBER** buttons on the **Storage** menu. Any number under 10 is entered with a numeric '0' in front of it, i.e. '05' for 5.
5. Press the **▲ / ▼** button to select **System**.
6. Select a TV system with the **◀ / ▶** button on the **System** menu;
  - L** : SECAM L/L' (France)
  - BG** : PAL B/G, SECAM B/G (Europe/East Europe)
  - I** : PAL I/II (U.K./Ireland)
  - DK** : PAL D/K, SECAM D/K (East Europe)
7. Press the **▲ / ▼** button to select **Channel**.
8. Press the **◀ / ▶** button to select **V/UHF** or **Cable** on the **Channel** menu.
 

If possible, select the channel number directly with the number buttons. Any number under 10 is entered with a numeric '0' in front of it, i.e. '05' for 5.
9. Press the **▲ / ▼** button to select **Search**.
10. Press the **◀ / ▶** button to commence searching on the **Search** pull-down menu. If a station is found the search will stop.
11. Press the **OK** button to store it.
 

The display **Stored** will appear.



12. To store another station, repeat steps 3 to 11.
13. Press the **EXIT** button to return to normal TV viewing.

## Setting up TV stations

### Assigning a station name

1. Repeat the 'Manual programme tuning' steps 1 to 2.
2. Press the **OK** or **▶** button and then **▲** / **▼** button to select **Name**.
3. Press the **▶** button. You can use a blank, +, -, the numeric **0** to **9** and the alphabet **A** to **Z**.  
With the **◀** button you can select in the opposite direction.
4. Select the position by pressing the **◀** / **▶** button and then make your choice of the second character, and so on.
5. Press the **OK** button to store it.  
The display **Stored** will appear.
6. Press the **EXIT** button to return to normal TV viewing.



Station menu

### Fine tuning

Normally fine tuning is only necessary if reception is poor.

1. Repeat the 'Manual programme tuning' steps 1 to 2.
2. Press the **OK** or **▶** button and then **▲** / **▼** button to select **Fine**.
3. Press the **◀** / **▶** button to fine tune for the best picture and sound on the **Fine** menu.

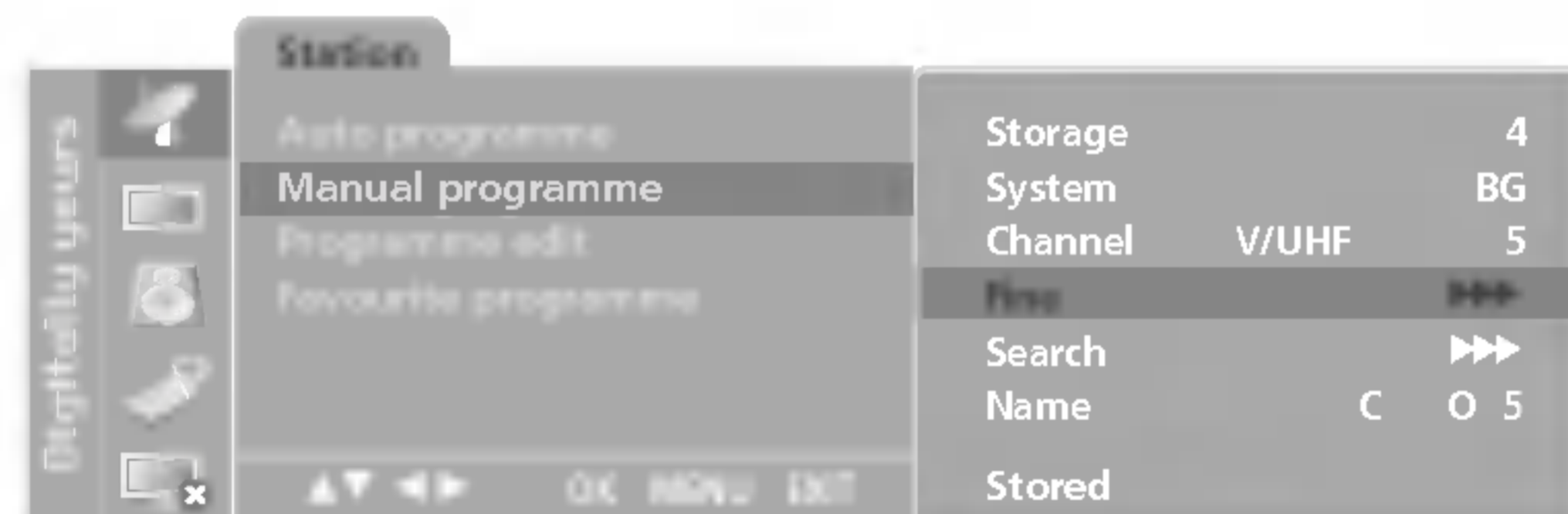

4. Press the **OK** button to store it.  
The display **Stored** will appear.
5. Press the **EXIT** button to return to normal TV viewing.  
The finely tuned programme will be indicated by a yellow number during programme selection.

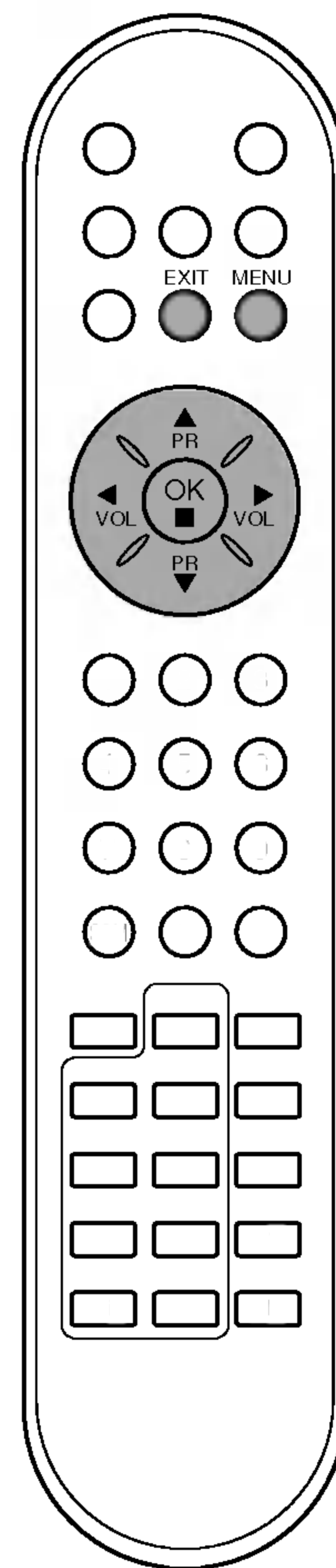

## Setting up TV stations



Station menu

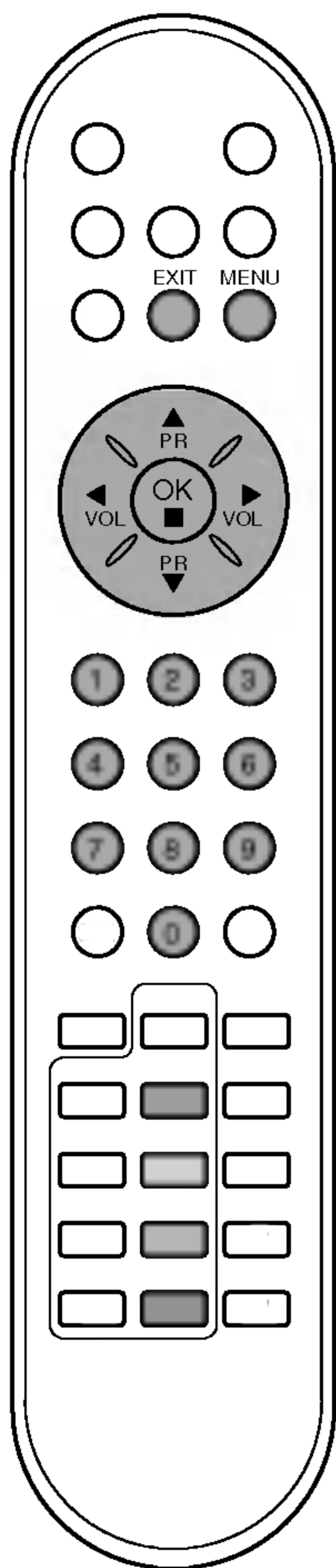

### Programme edit

This function enables you to delete or skip the stored programmes. Also you can move some stations to other programme numbers or insert a blank station data into the selected programme number.

1. Press the **MENU** button and then **▲ / ▼** button to select the Station menu.
2. Press the **OK** or **▶** button and then **▲ / ▼** button to select **Programme edit**.
3. Press the **OK** or **▶** button.



### Deleting a programme

1. Select a programme to be deleted with the **▲ / ▼** or **◀ / ▶** button.
2. Press the **RED** button twice.  
The selected programme is deleted, all the following programmes are shifted up one position.

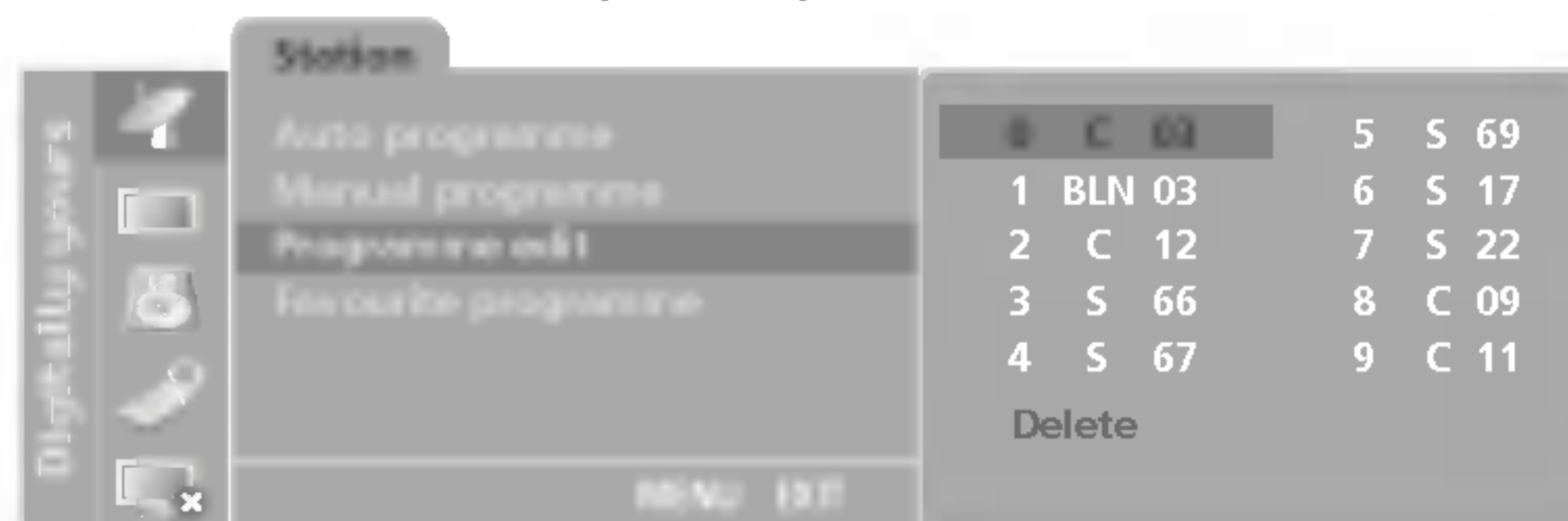

### Copying a programme

1. Select a programme to be copied with the **▲ / ▼** or **◀ / ▶** button.
2. Press the **GREEN** button.  
All the following programmes are shifted down one position.

### Moving a programme

1. Select a programme to be moved with the **▲ / ▼** or **◀ / ▶** button.
2. Press the **YELLOW** button.
3. Move the programme to the desired programme number with the **▲ / ▼** or **◀ / ▶** button.
4. Press the **YELLOW** button again to release this function.

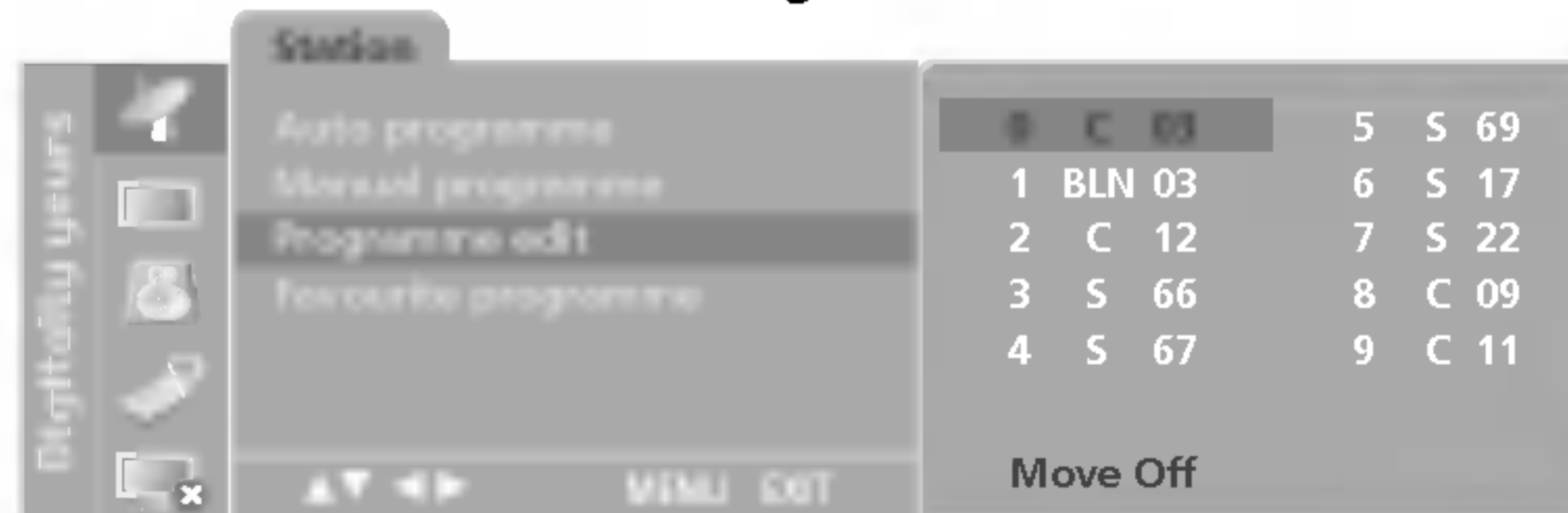

### Skipping a programme number

1. Select a programme number to be skipped with the **▲ / ▼** or **◀ / ▶** button.
2. Press the **BLUE** button. The skipped programme turns to blue.
3. Press the **BLUE** button again to release the skipped programme.  
When a programme number is skipped it means that you will be unable to select it using the **▲ / ▼** button during normal TV viewing. If you want to select the skipped programme, directly enter the programme number with the **NUMBER** buttons or select it in the programme edit or table menu.

Press the **EXIT** button to return to normal TV viewing.

## Setting up TV stations

### Favourite programme

This function lets you select your favourite programmes directly.

1. Press the **MENU** button and then **▲ / ▼** to select the Station menu.
2. Press the **OK** or **▶** button and then **▲ / ▼** to select **Favourite programme**.

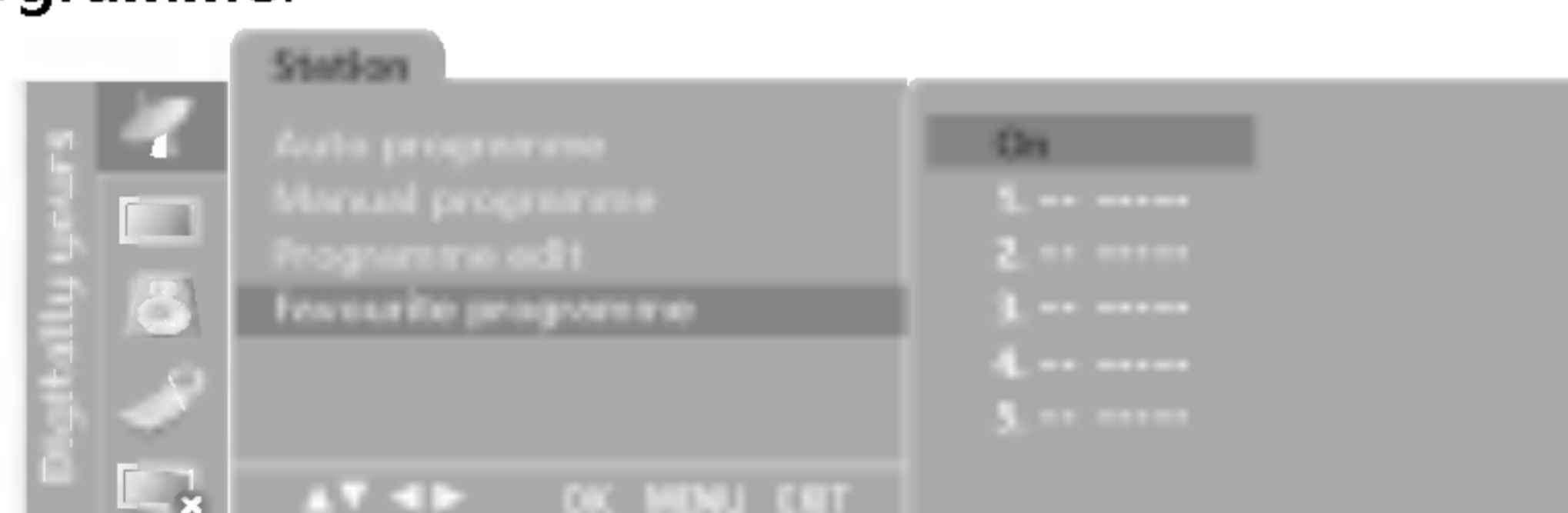

Station menu

3. Press the **OK** or **▶** button and then **◀ / ▶** button to select **On** or **Off**.
4. Press the **▲ / ▼** button to select -- ----.
5. Select a desired programme with the **◀ / ▶** button or **NUMBER** buttons. Any number under 10 is entered with a numeric '0' in front of it, i.e. '05' for 5.
6. To store another programme, repeat steps 4 to 5. You can store up to 5 programmes.
7. Press the **EXIT** button to return to normal TV viewing.

Repeatedly press the **PIP SWAP** button to select stored favourite programmes.

### Calling the programme table

You can check the programmes stored in the memory by displaying the programme table.

#### Displaying programme table

Press the **LIST** button to display the **Programme table** menu. The programme table appears on the screen. One programme table contains ten programmes as below.

	B	C	00		S	
				5	S	69
1	BLN	03		6	S	17
2	C	12		7	S	22
3	S	66		8	C	09
4	S	67		9	C	11

#### Note :

- a. You may find some blue programmes. They have been set up to be skipped by auto programming or in the programme edit mode.
- b. Some programmes with the channel number shown in the programme table indicate there is no station name assigned.

#### Selecting a programme in the programme table

Select a programme with the **▲ / ▼** or **◀ / ▶** button. Then press the **OK** button. The set switches to the chosen programme number.

#### Paging through a programme table

There are 10 programme table pages in which contain 100 programmes.

Pressing the **▲ / ▼** or **◀ / ▶** button repeatedly turns the pages.

Press the **EXIT** button to return to normal TV viewing.

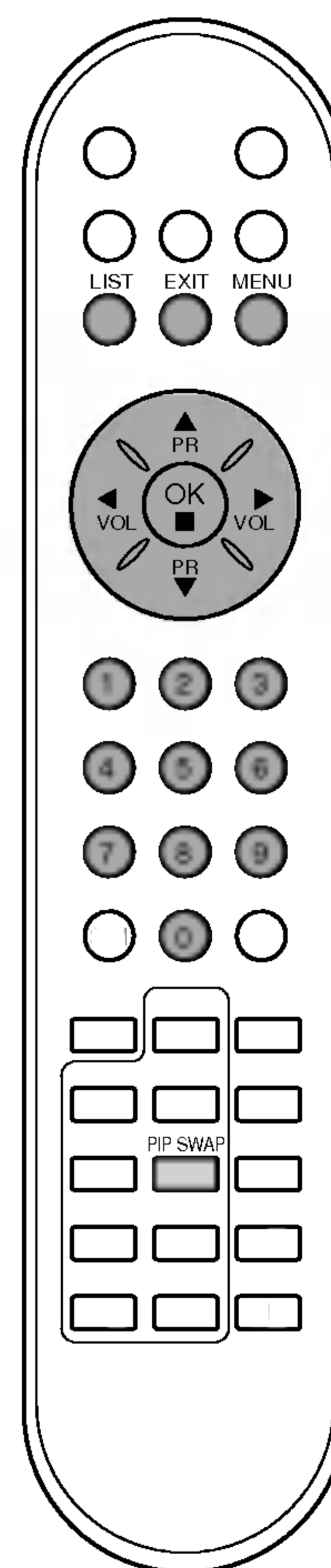

## Picture adjustment



Picture menu

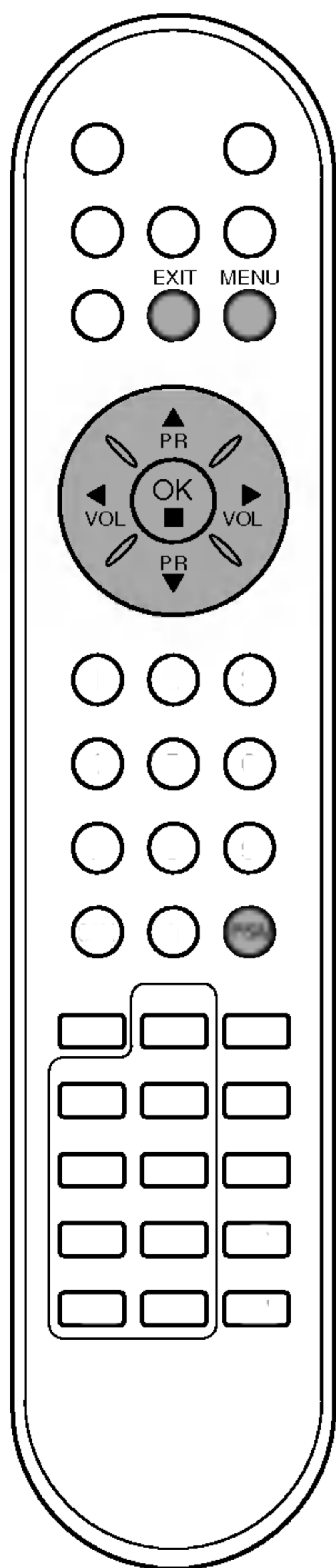

### PSM (Picture Status Memory)

1. Press the **MENU** button and then **▲ / ▼** button to select the Picture menu.
2. Press the **OK** or **▶** button and then **▲ / ▼** button to select **PSM**.
3. Press the **◀ / ▶** button to select a picture setting on the **PSM** menu.

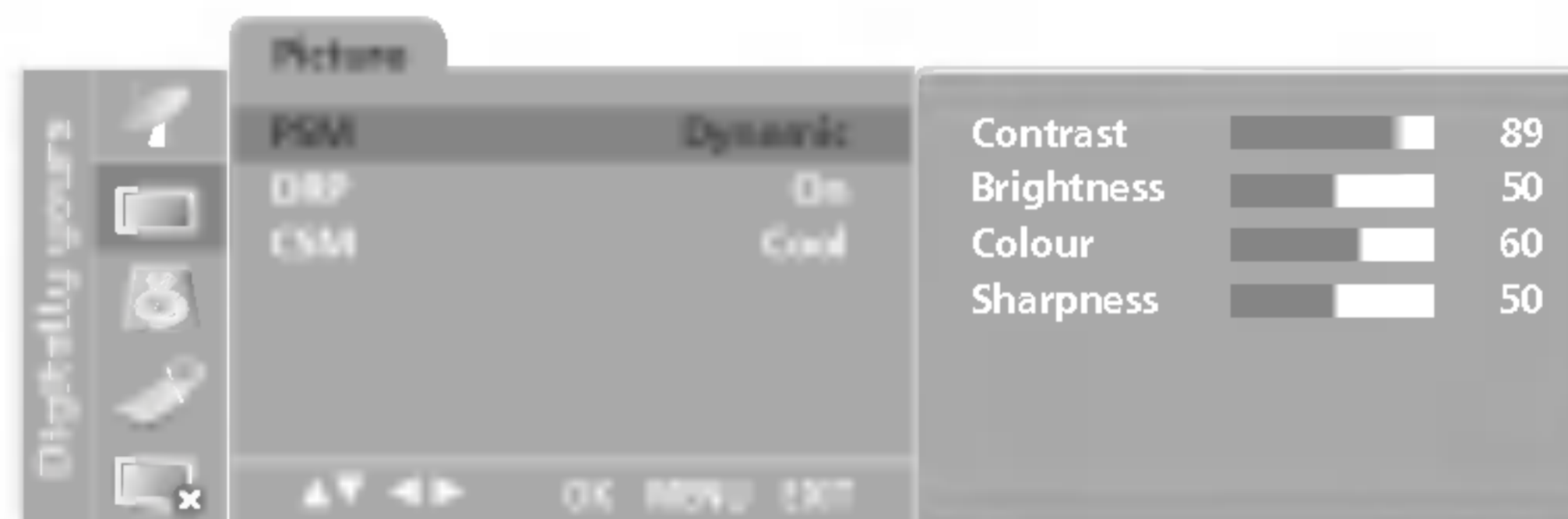

4. Press the **OK** button.
5. Press the **EXIT** button to return to normal TV viewing.

You can also recall a desired picture (**Dynamic**, **Standard**, **Mild**, **Game** or **User**) with **PSM** button on the remote control. The picture **Dynamic**, **Standard**, **Mild** and **Game** are programmed for optimum picture reproduction at the factory and cannot be changed.

### Picture adjustment

You can adjust picture contrast, brightness, colour intensity, sharpness and tint (NTSC AV only) to the levels you prefer.

1. Press the **MENU** button and then **▲ / ▼** button to select the Picture menu.
2. Press the **OK** or **▶** button and then **▲ / ▼** button to select **PSM**.
3. Press the **OK** button.

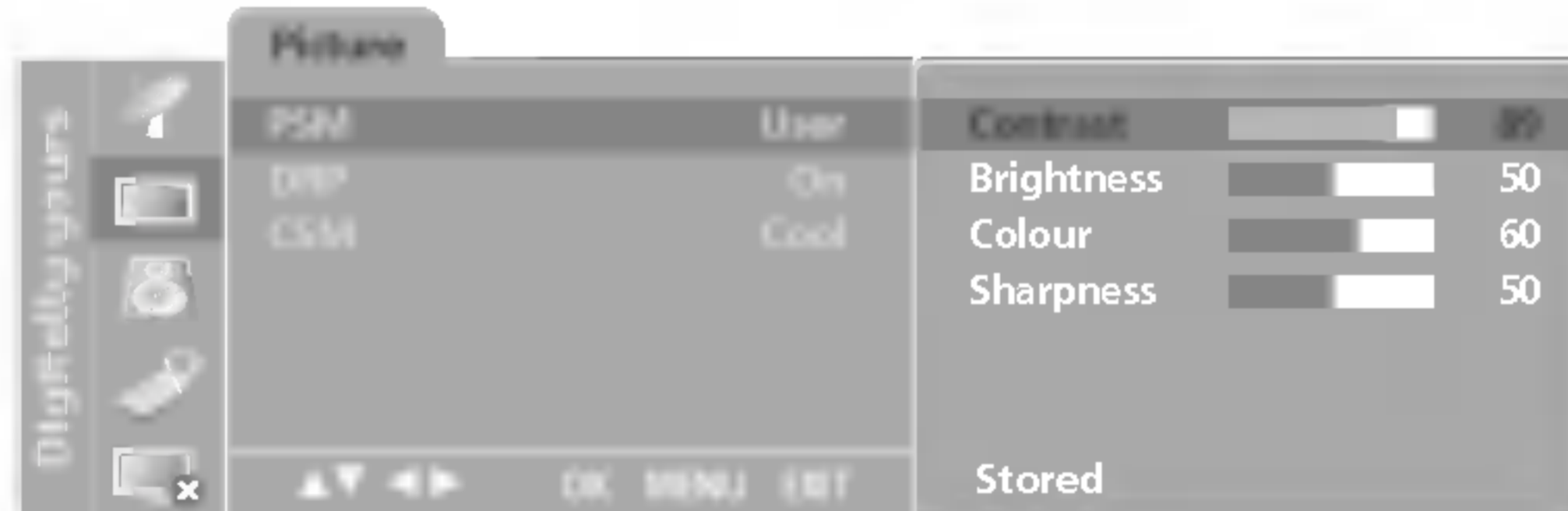

4. Press the **◀ / ▶** button to make appropriate adjustments on each sub menu.  
You can also select other **User** items directly with **▲ / ▼** button and adjust them with **◀ / ▶** button.
5. Press the **OK** button to store it for the picture **User**.  
The display **Stored** will appear.
6. Press the **EXIT** button to return to normal TV viewing.

**Note :** Only **Contrast** and **Brightness** are displayed in **PC mode**.

### DRP (Digital Reality Picture)

DRP improves image outlines in dark screens.

1. Press the **MENU** button and then **▲ / ▼** button to select the Picture menu.
2. Press the **OK** or **▶** button and then **▲ / ▼** button to select **DRP**.
3. Press **◀ / ▶** button to select **On** or **Off** on the **DRP** menu.
4. Press the **OK** button.
5. Press the **EXIT** button to return to normal TV viewing.

## Picture adjustment

### CSM (Colour Status Memory)

You can adjust the temperature of R, G, B (Red, Green, Blue) to the levels you prefer.

1. Press the **MENU** button and then **▲** / **▼** button to select the Picture menu.
2. Press the **OK** or **▶** button and then **▲** / **▼** button to select **CSM**.
3. Press the **OK** button.



Picture menu



4. Repeat the 'Picture adjustment' steps 4 to 6.

The temperature **Cool**, **Normal** and **Warm** are programmed for optimum picture reproduction at the factory and can not be changed.

### Picture format

You can watch TV in various picture formats; Wide, 14:9, Zoom, Auto, 4:3.

Repeatedly press the **ARC** button to select your desired picture format.

#### Wide

You can enjoy the cinema (the picture format of 16:9) or general TV programme through the 16:9 mode.

The screen 16:9 is viewed just like that but the screen 4:3 is magnified to the left and right so that the screen 16:9 is full.

#### 14:9

You can enjoy the picture format of 14:9 or general TV programme through the 14:9 mode.

The screen 14:9 is viewed just like that the screen 4:3 is magnified to the upper / lower and left / right.

#### Zoom

You can enjoy the cinema in a vast screen through the Zoom mode. The screen 4:3 is magnified to the upper / lower and left / right sides so that the screen 16:9 is full. The bottom and top of the picture may be lost.

#### Auto

When your set receives the wide screen signal, it will be automatically changed to the picture format to be sent.

#### 4:3

This picture format is 4 to 3 of general TV.

#### Note :

- a. In the double window and scan mode, ARC function isn't available.
- b. You are available to Wide and 4:3 in PC mode.

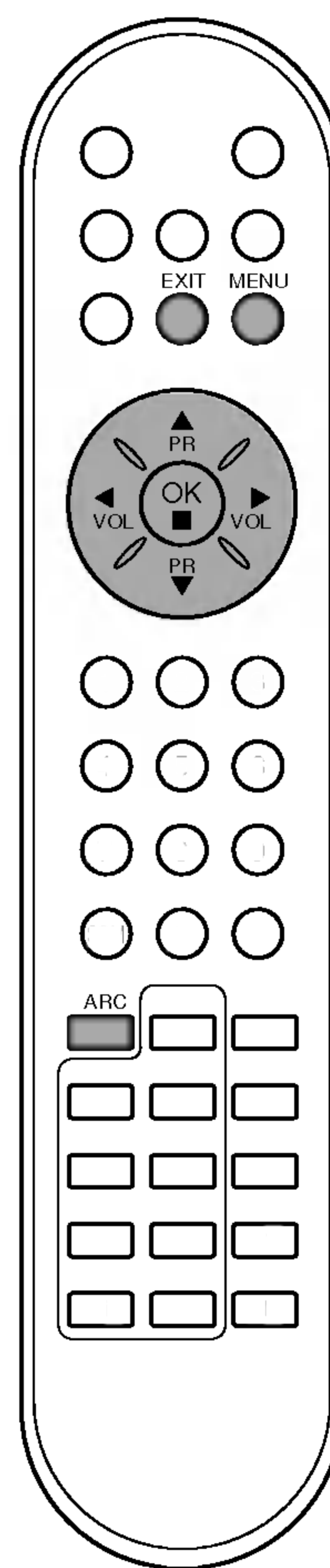

## Sound adjustment



Sound menu

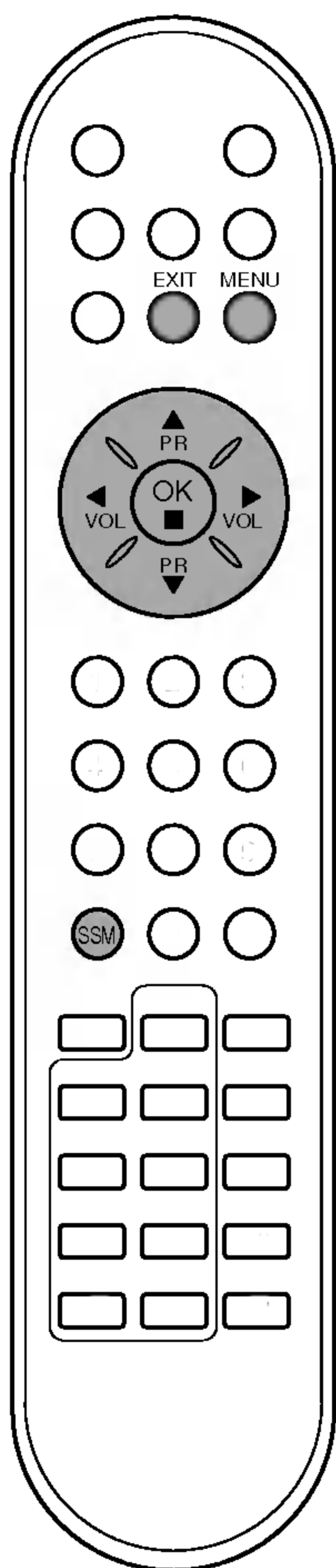

### SSM (Sound Status Memory)

You can select your preferred sound setting; Virtual, Flat, Music, Movie or Speech and you can also adjust the sound frequency of the equalizer.

1. Press the **MENU** button and then **▲ / ▼** button to select the Sound menu.
2. Press the **OK** or **▶** button and then **▲ / ▼** button to select **SSM**.



3. Press the **◀ / ▶** button to select a sound setting on the **SSM** menu.
  - Sound Frequency Adjustment**
  - a. Press the **OK** button in **SSM**.



- b. Select a sound band by pressing the **◀ / ▶** button.
- c. Make appropriate sound level with the **▲ / ▼** button.
- d. Press the **OK** button to store it for the sound **User**.  
The display **Stored** will appear.

Press the **EXIT** button to return to normal TV viewing.

You can also recall a desired sound setting (Virtual, Flat, Music, Movie, Speech or User) with **SSM** button on the remote control. The sound settings (Virtual, Flat, Music, Movie and Speech) are programmed for optimum sound reproduction at the factory and cannot be changed.

**Note :** If you press the **SSM** button after making appropriate adjustment on the **User** sub menu, the display **User** automatically appears even though you have already set a factory preset setting; (Virtual, Flat, Music, Movie or Speech).

### Sound adjustment

You can adjust balance, AVL (Auto Volume Leveler). AVL automatically keeps on an equal volume level even if you change programmes.

1. Press the **MENU** button and then **▲ / ▼** button to select the Sound menu.
2. Press the **OK** or **▶** button and then **▲ / ▼** button to select the desired sound item; **AVL** or **Balance**.



3. Make desired adjustment with the **◀ / ▶** and then press the **OK** button.
4. Press the **EXIT** button to return to normal TV viewing.

#### **Note :**

- a. In **PC** mode, you can select Sound select menu in **PIP**, **DW1**, **DW2**, **POP1** mode.
- b. In the **Virtual** mode, **AVL** function isn't available.



---

## Sound adjustment

---

### Stereo/Dual reception

When a programme is selected, the sound information for the station appears after the programme number and station name disappear.

Broadcast	On Screen Display
Mono	<b>MONO</b>
Stereo	<b>STEREO</b>
Dual	<b>DUAL I</b>

### Mono sound selection

In stereo reception if the stereo signal is weak, you can switch to mono by pressing the **I/II** button twice. In mono reception the depth of sound is improved. To switch back to stereo, press the **I/II** button twice again.

### Language selection for dual language broadcast

If a programme is received in two languages (dual language), you can switch to **DUAL I**, **DUAL II** or **DUAL I+II** by pressing the **I/II** button repeatedly.

**DUAL I** sends the primary broadcast language to the loudspeakers.  
**DUAL II** sends the secondary broadcast language to the loudspeakers.

**DUAL I+II** sends a separate language to each loudspeaker.

### NICAM reception (option)

If your set is equipped with the receiver for NICAM reception, the high quality NICAM (Near Instantaneous Companding Audio Multiplex) digital sound can be received.

Sound output can be selected according to the type of received broadcast as follows by pressing the **I/II** button repeatedly.

1. When NICAM mono is received, you can select **NICAM MONO** or **FM MONO**.
2. When NICAM stereo is received, you can select **NICAM STEREO** or **FM MONO**. If the stereo signal is weak, switch to **FM mono**.
3. When NICAM dual is received, you can select **NICAM DUAL I**, **NICAM DUAL II** or **NICAM DUAL I+II** or **MONO**. When **FM mono** is selected the display **MONO** appears on the screen.

### Sound output selection

In AV mode, you can select output sound for the left and right loudspeakers.

Repeatedly press the **I/II** button to select the sound output.

**L+R** : Audio signal from audio L input is sent to left loud-speaker and audio signal from audio R input is sent to right loud-speaker.

**L+L** : Audio signal from audio L input is sent to left and right loudspeakers.

**R+R** : Audio signal from audio R input is sent to left and right loudspeakers.

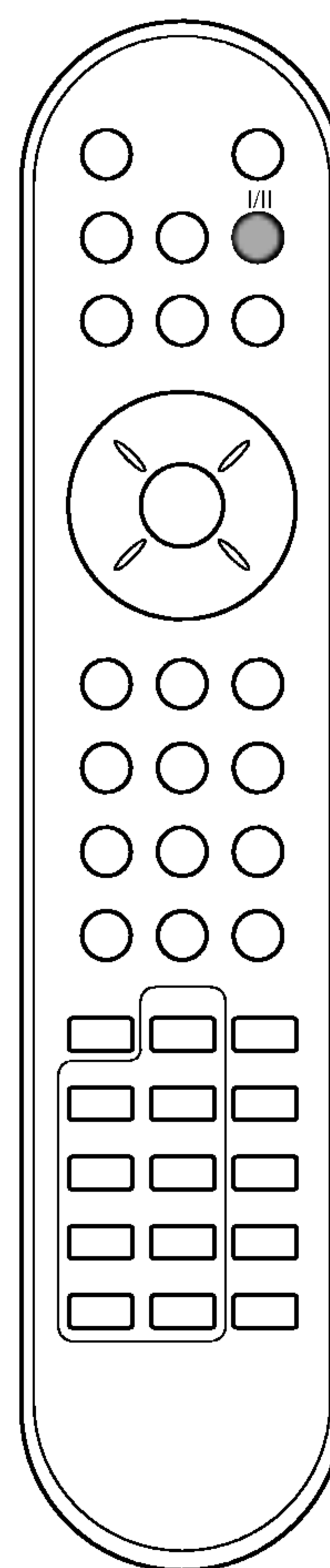

## Other functions



Special menu

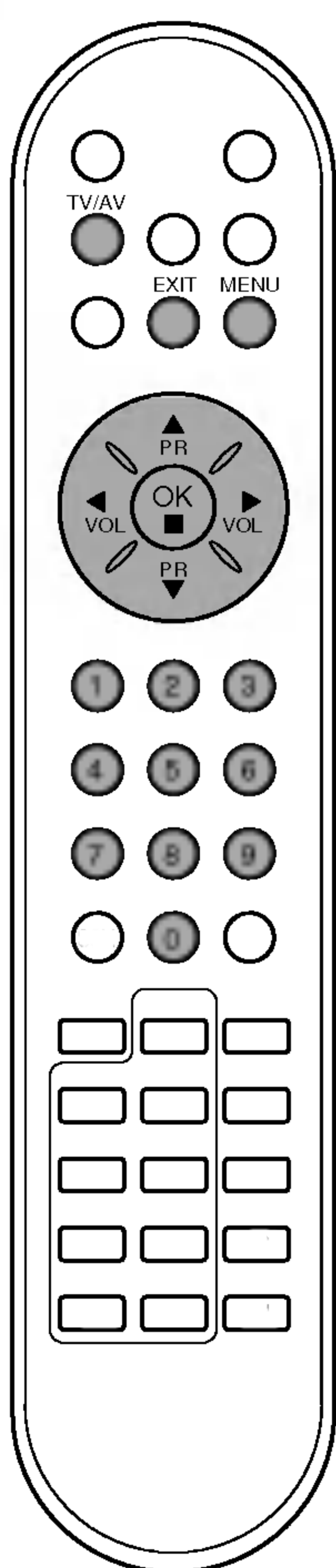

### TV, AV and PC modes

Inputs can be set for TV, AV or PC mode. AV mode is used when a video cassette recorder (VCR), or other equipment is connected to the set.

**Note :** When a VCR is connected via the aerial socket the set is used in TV mode. See the 'Connection of external equipment' section.

1. Press the **MENU** button and then **▲ / ▼** button to select the Special menu.
2. Press the **OK** or **▶** button and then **▲ / ▼** button to select **Input**.
3. Press the **◀ / ▶** button to select **TV**, **AV1**, **AV2**, **AV3**, **S-Video** or **RGB-PC**.



The AV and RGB-PC modes are :

AV 1 : VCR connected to the Euro scart socket of the set

AV 2 : VCR connected to the **AV2** of the set

AV 3 : VCR connected to the **AV3** of the set

S-Video : VCR connected to the **S-Video** of the set

RGB-PC : PERSONAL COMPUTER connected to the PC socket of the set

4. Press the **EXIT** button to return to normal TV viewing.

Alternatively you can select the TV or AV mode by pressing the **TV/AV** button.

In AV mode, to return to TV mode, press the **▲ / ▼** or **NUMBER** buttons.

### Auto AV switching

If your VCR outputs an AV switching voltage when connected to the Euro scart socket, the set will switch to **AV1** mode automatically. But if you want to keep on watching TV mode, press the **▲ / ▼** or **NUMBER** buttons.

Press the **TV/AV** button to return to AV modes.

## Other functions

### Child lock

The TV can be set so that the remote control handset is needed to control it. This feature can be used to prevent unauthorized viewing.

1. Press the **MENU** button and then ▲ / ▼ button to select the Special menu.
2. Press the **OK** or ► button and then ▲ / ▼ button to select **Child lock**.
3. Press the ◀ / ▶ button to select **On** or **Off** on the **Child lock** menu.
4. Press the **EXIT** button to return to normal TV viewing.

With the lock on, the display **Child lock on** appears on the screen if any button on the side panel is pressed while viewing the TV.

**Note :** The display **Child lock on** will not appear on the screen if any button on the side panel is pressed while displaying the menus.

### Auto sleep

If you select **On** on the **Auto sleep** menu, the set will automatically switch itself to standby mode approximately ten minutes after a TV station stops broadcasting.

1. Press the **MENU** button and then ▲ / ▼ button to select the Special menu.
2. Press the **OK** or ► button and then ▲ / ▼ button to select **Auto sleep**.
3. Press the ◀ / ▶ to select **On** or **Off** on the **Auto sleep** menu.
4. Press the **EXIT** button to return to normal TV viewing.

### Sleep timer

You don't have to remember to switch the set off before you go to sleep. The sleep timer automatically switches the set to standby after the preset time has elapsed.

Press the **SLEEP** button to select the number of minutes. The display 'Ⓢz---' will appear on the screen, followed by **10, 20, 30, 60, 90, 120, 180** and **240**. The timer begins to count down from the number of minutes selected.

**Note :**

- a. To view the remaining sleep time, press the **SLEEP** button once.
- b. To cancel the sleep time, repeatedly press the **SLEEP** button until the display 'Ⓢz ---' appears.
- c. When you switch the set off, the set releases the preset sleep time.

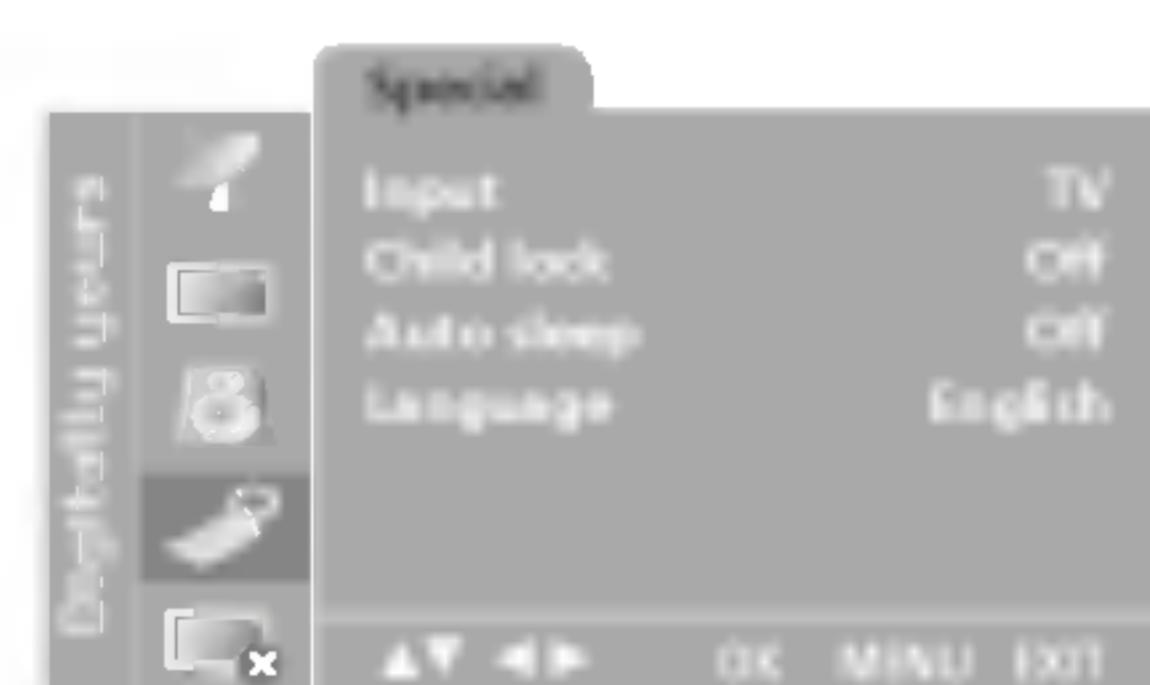

Special menu

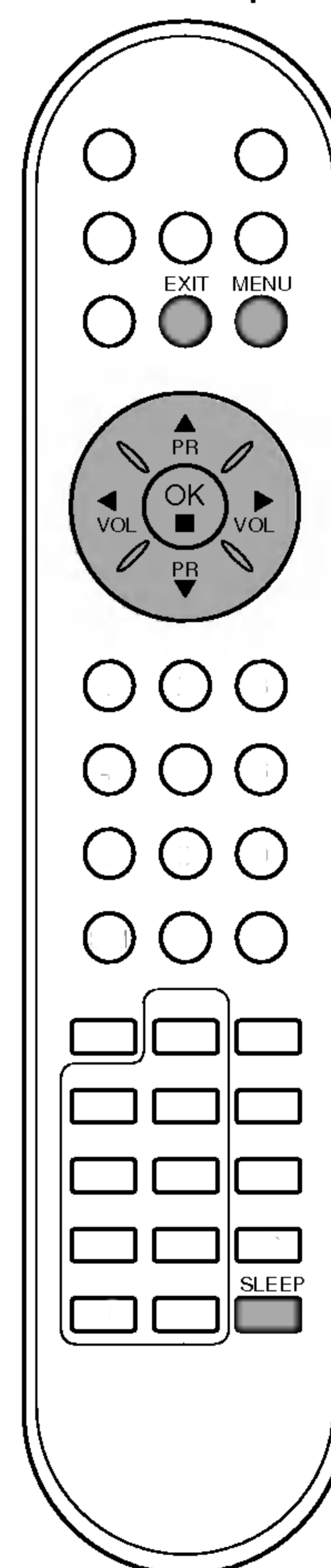

---

## PIP operation (option)

---

### Option :

PIP is an optional function, so that only the set with PIP function can operate.

PIP (Picture in Picture) displays a picture within a picture.

Select TV, AV or PC mode to operate PIP function.

### On and off

Press the **PIP** button to switch on the sub picture.

Each time this button is pressed, each mode for the sub picture is displayed as shown below.

→ Off → PIP → DW1 → DW2 → POP1 (PC mode only)

Repeatedly press this button to switch it off.

### Input mode selection for sub picture (PC mode only)

Press the **PIP INPUT** button to select the input mode for the sub picture.

Each time this button is pressed, each input mode for the sub picture is displayed as shown below.

→ Programme number → AV1 → AV2 → AV3 → S-Video

### Swapping between main and sub pictures

Press the **PIP SWAP** button to exchange the main and sub pictures.

### Programme selection for sub picture

Press the **PIP PR +/-** buttons to select a programme for the sub picture. The selected programme number is displayed just below the programme number of main picture.

### Sub picture size

Press the **SIZE** button and then press the ◀ / ▶ button until desired size is achieved. The **SIZE** button doesn't work in DW1, DW2 and POP1 mode.

### Sub picture freeze

Press the **STILL** button to freeze motion of the sub picture.  
Press any button to restore motion.

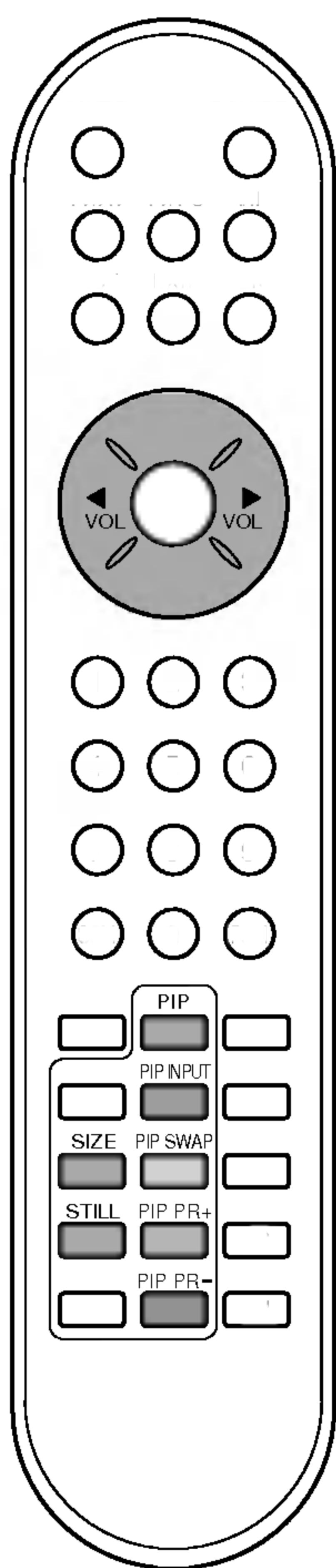

## PIP operation (option)

### Sub picture position change

Press the **POSITION** button and then press the ▲ / ▼ or ◀ / ▶ button until desired position is achieved. The sub pictures moves up/down or left/right. The **POSITION** button doesn't work in DW1, DW2 and POP1 mode.

### Programme scan

This function enables you to search all the stored stations on 3/12 sub pictures and 9 main pictures and see your favourite station by exchanging the main and sub pictures.

Press the **SCAN** button repeatedly to select POP3/POP12/POP9. The selected sub or main pictures search all the stored stations. Press the **EXIT** button to switch off sub or main pictures.

#### <PIP/POP Specification>

Condition		PIP mode				
Main picture	PIP	PIP	POP3	POP12	POP9	POP1
PC	RF (TV)	RF (TV)	RF (TV) channel scan	RF (TV) channel scan	PC strobe	RF (TV)
PC	AV	AV	AV strobe	AV strobe	PC strobe	AV
RF (TV)	PC	PC	PC strobe	PC strobe	RF (TV) strobe	x
AV	PC	PC	PC strobe	PC strobe	AV strobe	x

**Note :** The PIP picture resolution will be decreased by the PIP size.

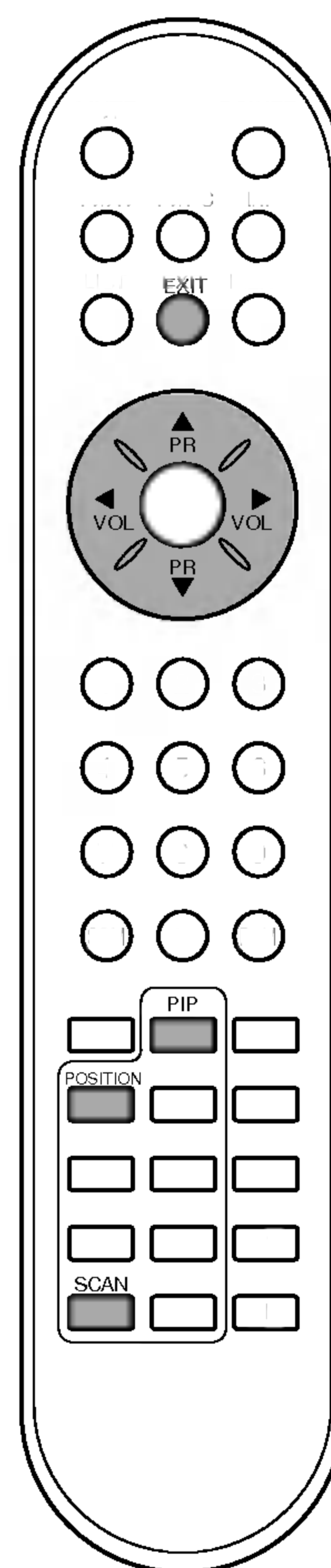

---

## Teletext (option)

---

Teletext (or TOP text) is an optional function, therefore only a set with the teletext system can receive the teletext broadcast.

Teletext is a free service broadcast by most TV stations which gives up-to-the-minute information on news, weather, television programmes, share prices and many other topics.

The teletext decoder of this TV can support the SIMPLE, TOP and FASTEXT systems. SIMPLE (standard teletext) consists of a number of pages which are selected by directly entering the corresponding page number. TOP and FASTEXT are more modern methods allowing quick and easy selection of teletext information.

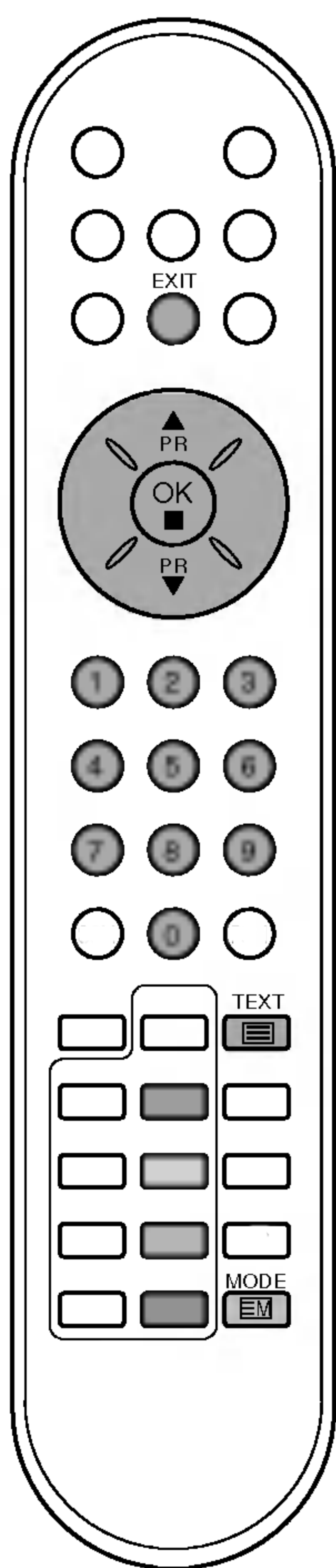

### Switch on/off

Press the **TEXT** button to switch to teletext. The initial page or last page appears on the screen.

Two page numbers, TV station name, date and time are displayed on the screen headline. The first page number indicates your selection, while the second shows the current page displayed.

Press the **TEXT** or **EXIT** button to switch off teletext. The previous mode reappears.

### SIMPLE text

#### Page selection

1. Enter the desired page number as a three digit number with the **NUMBER** buttons. If during selection you press a wrong number, you must complete the three digit number and then re-enter the correct page number.
2. The **▲ / ▼** button can be used to select the preceding or following page.

#### Programming a colour button in LIST mode

If the TV is in SIMPLE text, TOP text or FASTEXT mode, press the **EM** button to switch to LIST mode.

Four teletext page numbers of your choice can be colour coded and easily selected by pressing the corresponding coloured button on the remote control handset.

1. Press a coloured button.
2. Using the **NUMBER** buttons, select the page you wish to programme.
3. Press the **OK** button. Then the selected page is stored as the selected page number by blinking once. From now on, you can select this page with the same coloured button.
4. The three other coloured buttons are programmed in this way.

**Note :** In PIP of the PC mode, select the sub picture size is **PIP**, **DW1**, **DW2**, **POP1**.

In **PIP** of the PC mode, the text on the screen may be unstable.

---

## Teletext (option)

---

### TOP text (option)

The user guide displays four fields-red, green, yellow and blue at the bottom of the screen. The yellow field denotes the next group and the blue field indicates the next block.

#### Block / group / page selection

1. With the blue button you can progress from block to block.
2. Use the yellow button to proceed to the next group with automatic overflow to the next block.
3. With the green button you can proceed to the next existing page with automatic overflow to the next group.  
Alternatively the ▲ button can be used.
4. The red button permits to return to previous selection.  
Alternatively the ▼ button can be used.

#### Direct page selection

Corresponding to the SIMPLE teletext mode, you can select a page by entering it as a three digit number using the NUMBER buttons in TOP mode.

### FASTEXT

The teletext pages are colour coded along the bottom of the screen and are selected by pressing the corresponding coloured button.

#### Page selection

1. Press the  button to select the index page.
2. You can select the pages which are colour coded along the bottom line with the same coloured buttons.
3. Corresponding to the SIMPLE teletext mode, you can select a page by entering its three digit page number with the NUMBER buttons in FASTEXT mode.
4. The ▲ / ▼ button can be used to select the preceding or following page.

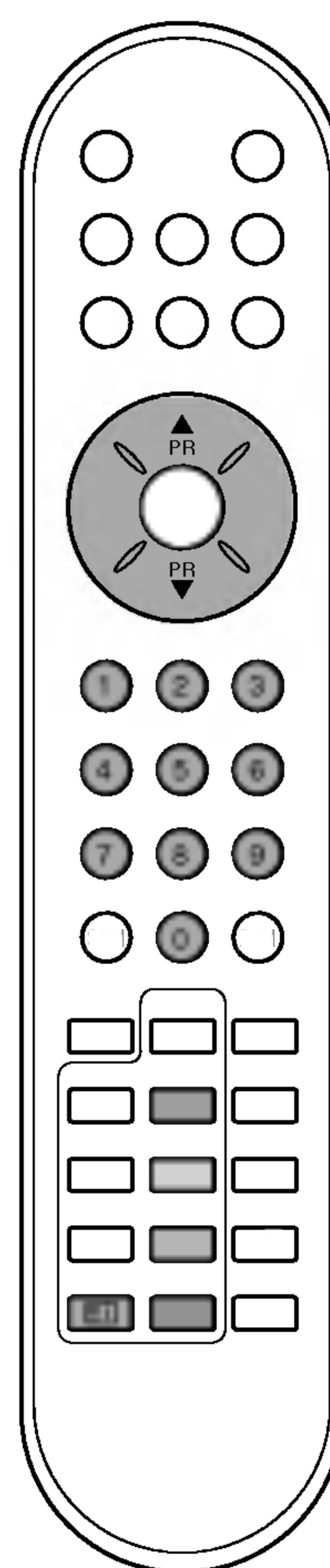

---

## Teletext (option)

---

### Special teletext functions

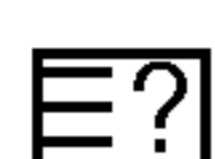
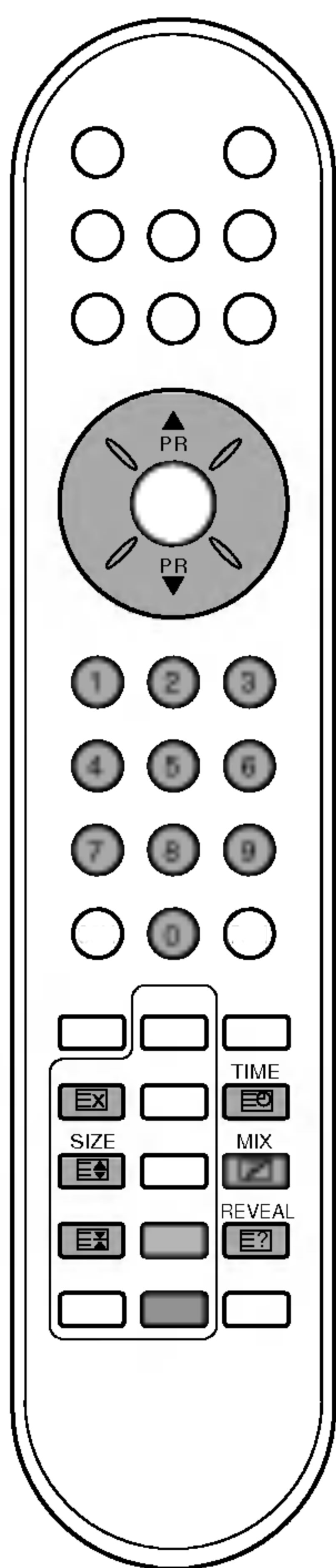

#### REVEAL

Press this button to display concealed information, such as solutions of riddles or puzzles.

Press this button again to remove the information from the display.



#### SIZE

Selects double height text.

Press this button to enlarge the top half of the page.

Press this button again to enlarge the bottom half of the page.

Press this button again to return to the normal display.



#### UPDATE

Displays the TV picture on the screen while waiting for the new teletext page. The display (EX) will appear at the top left hand corner of the screen. When the updated page is available then display (EX) will change to the page number.

Press this button to view the updated teletext page.



#### HOLD

Stops the automatic page change which will occur if a teletext page consists of 2 or more sub pages. The number of sub pages and the sub page displayed is, usually, shown on the screen below the time. When this button is pressed the stop symbol is displayed at the top left-hand corner of the screen and the automatic page change is inhibited.

To continue press this button again.



#### MIX

Displays the teletext pages superimposed on the TV picture.

To switch the TV picture off press this button again.



#### TIME

When viewing a TV programme, press this button to display the time at the top right hand corner of the screen. Press this button again to remove the display. In the teletext mode, press this button to select a sub page number. The sub page number is displayed at the bottom of the screen. To hold or change the sub page, press the RED/GREEN, ▲ / ▼ or NUMBER buttons.

Press again to exit this function.



---

## Connection of external equipment

---

You can connect additional equipment, such as VCRs, camcorders etc. to your set. Examples are shown below.

### Aerial socket

1. Connect the RF out socket of the VCR to the aerial socket of the set.
2. Connect the aerial cable to the RF aerial in socket of the VCR.
3. Store the VCR channel on a desired programme number using the 'Manual programme tuning' section.
4. Select the programme number where the VCR channel is stored.
5. Press the **PLAY** button on the VCR.

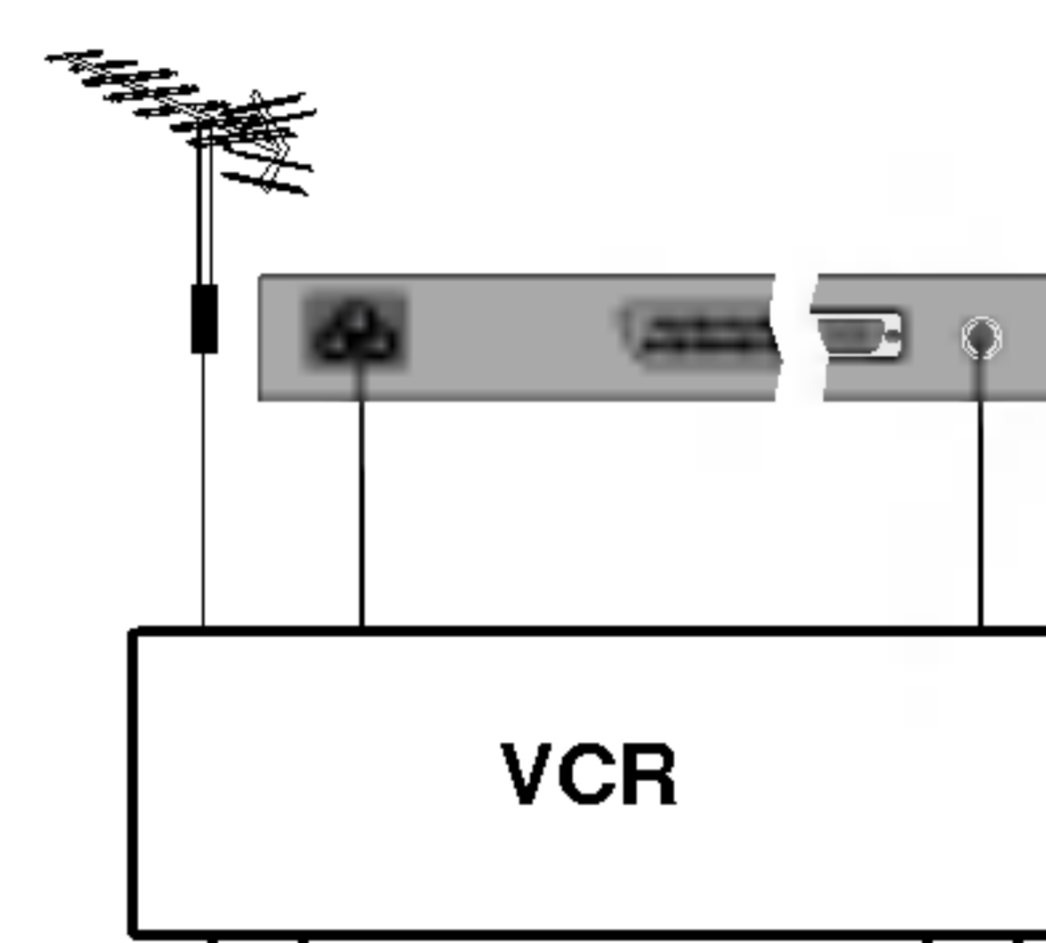

### Euro scart socket

1. Connect the Euro scart socket of the VCR to the Euro scart socket of the set.
2. Press the **PLAY** button on the VCR.  
If your VCR outputs an AV switching signal via the Scart lead the set will auto switch to **AV 1** mode on start of playback, but if you want to keep on watching in TV mode, press the **▲ / ▼** or **NUMBER** buttons.

Otherwise press the **TV/AV** button on the remote control handset to select **AV1**. The VCR playback picture appears on the screen.

You can also record programmes received by the TV on video tape.

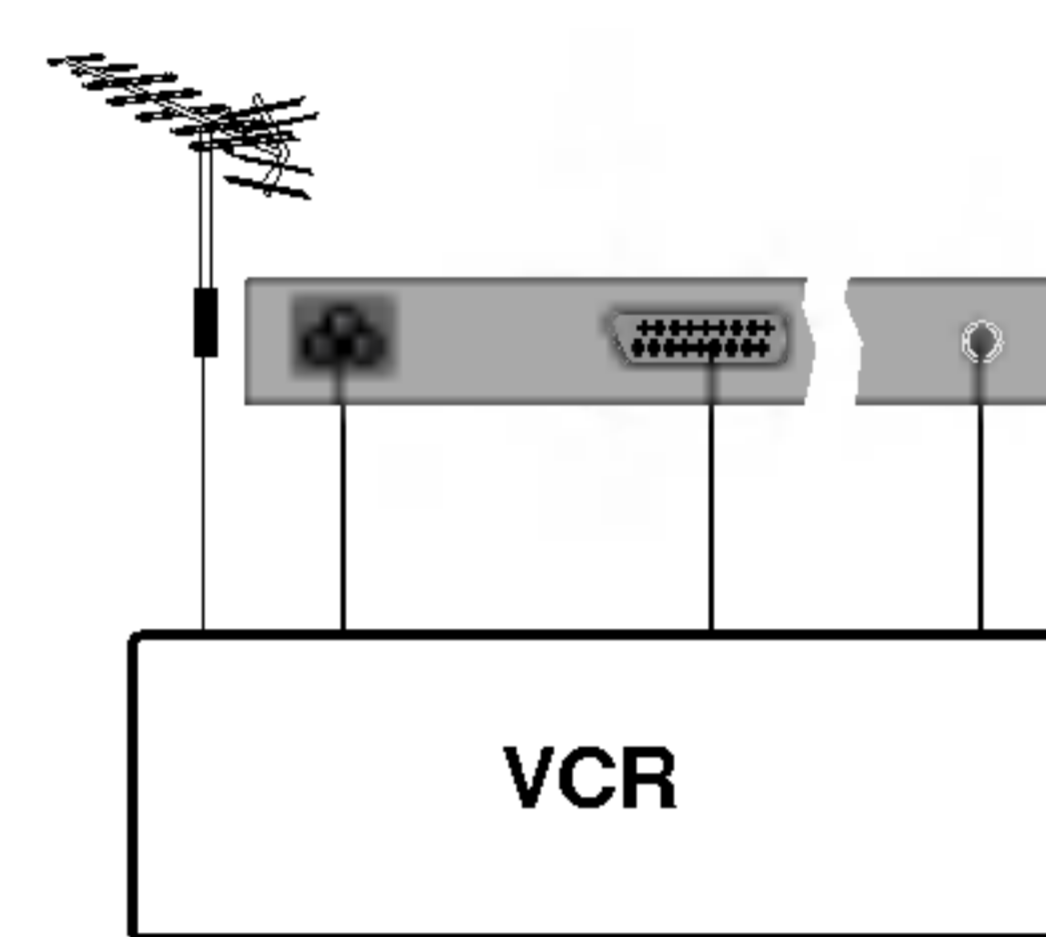

### Audio/Video in sockets

1. Connect the audio/video out sockets of the VCR to audio/video in sockets of the set.
2. Press the **TV/AV** button to select **AV2** or **AV3**.
3. Press the **PLAY** button on the VCR.  
The VCR playback picture appears on the screen.

**Note :** If you have a mono VCR, connect the audio cable from the VCR to the **AUDIO L/MONO** socket of the set.

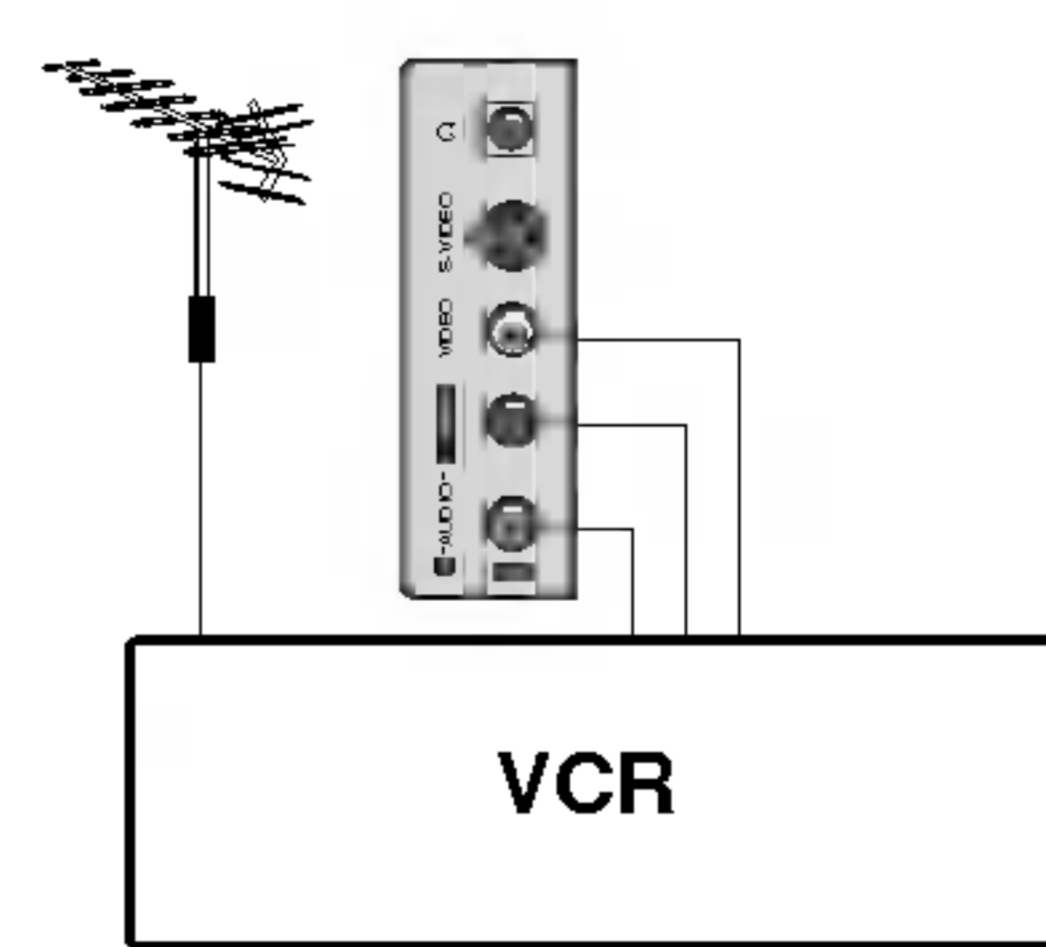
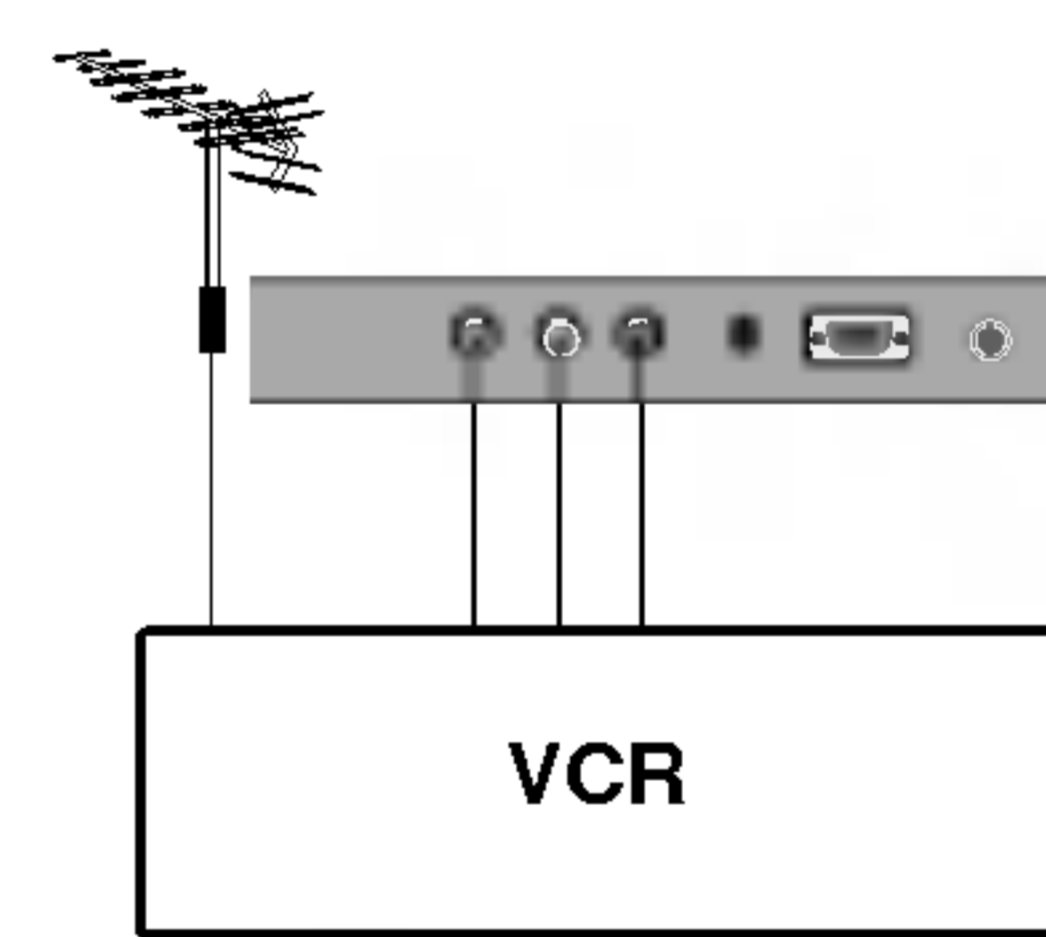

---

## Connection of external equipment

---

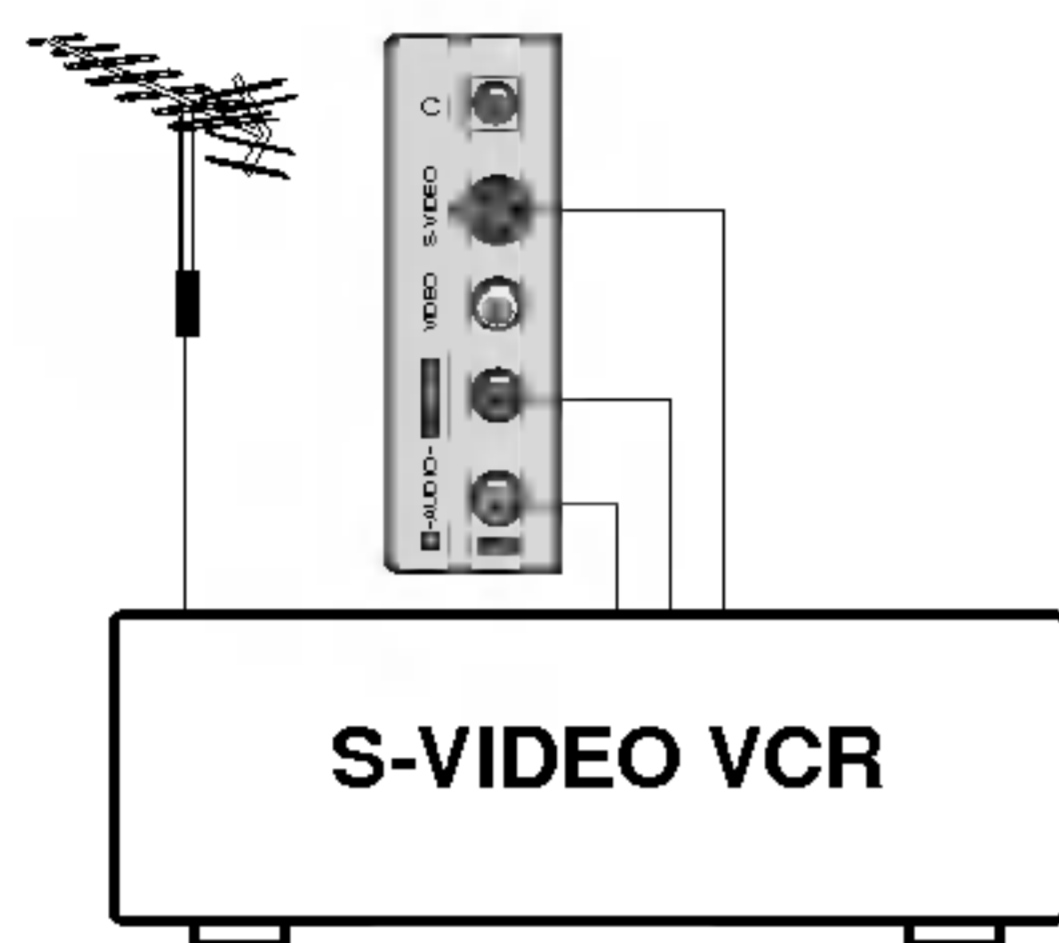

### S-Video/Audio in sockets (S-Video) (option)

When connecting an S-VIDEO VCR to the **S-VIDEO** socket, the picture quality will be further improved.

1. Connect the S-Video socket of the VCR to the **S-VIDEO** socket of the set.
2. Connect the audio cable from the S-VIDEO VCR to the **AUDIO** sockets of the set.
3. Select **S-Video** by pressing the **TV/AV** button repeatedly.
4. Press the **PLAY** button on the VCR.  
The VCR playback picture appears on the screen.

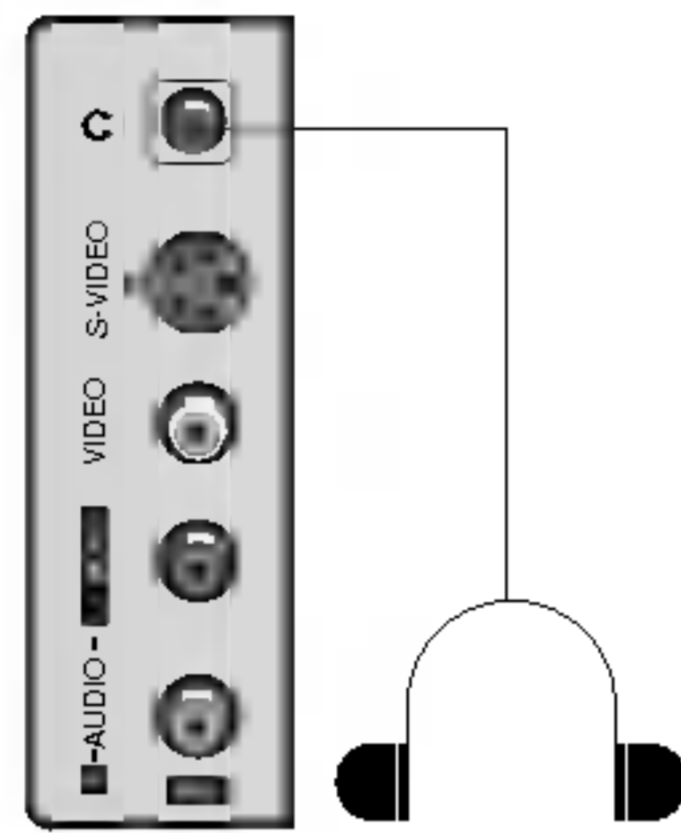

### Headphone socket

Insert the headphone plug to the headphone socket of the set. You can listen to the sound through the headphone. To adjust the headphone volume, press the ◀ / ▶ button. If you press the **MUTE** button, the sound from the headphone is switched off.

## Connection of PC

### PC in socket (D-Sub jack)

1. Connect the signal cable from the monitor output socket of the PERSONAL COMPUTER to the PC input socket of the set.
2. Connect the audio cable from the PC to the **PC SOUND** sockets of the set.
3. Press the **TV/PC** button to select **PC**.
4. Switch on the PC, and the PC screen appears on the set.  
The set can be operated as the PC monitor.

**Note :** If you have an Apple macintosh, connect the VGA desktop block (not supplied) from the 3 row 15 pin to 2 row 15 pin with the signal cable and connect the VGA desktop block to the Macintosh.

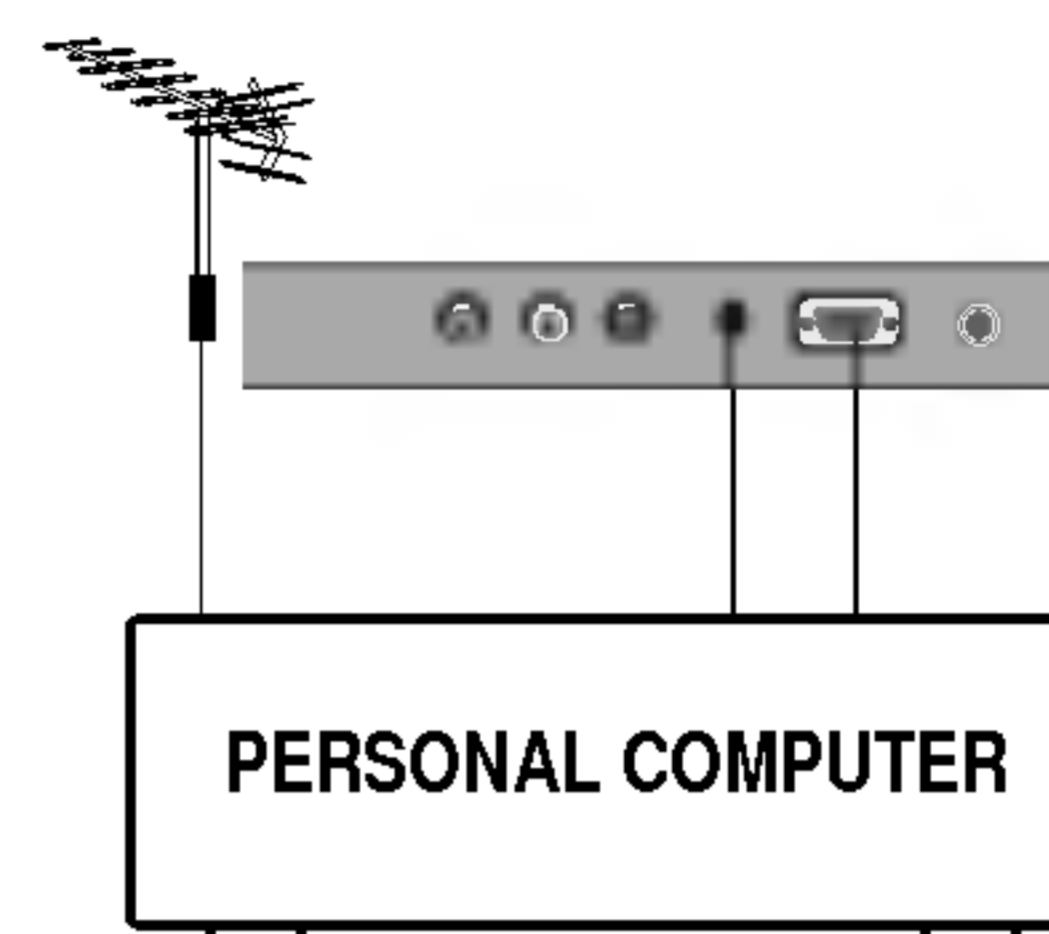

### Displayable Monitor Specification

MODE	Resolution	Horizontal Frequency(KHz)	Vertical Frequency(Hz)
VGA	640x480	31.4KHz	60Hz
	640x480	35KHz	67Hz
	640x480	37.5KHz	75Hz
	640x480	43.2KHz	85Hz
SVGA	800x600	35.1KHz	56Hz
	800x600	37.8KHz	60Hz
	800x600	48KHz	72Hz
	800x600	46.8KHz	75Hz
(MAC)	800x600	53.6KHz	85Hz
	832x624	49.7KHz	75Hz
XGA	1024x768	48.3KHz	60Hz
	1024x768	56.4KHz	70Hz
	1024x768	60KHz	75Hz
	1024x768	68.6KHz	85Hz
WXGA	1280x768	39.5KHz	50Hz
	1280x768	47.6KHz	60Hz

(Synchronization input form : separate)

### Note :

- a. If the set is cold, there may be a small "flicker" when the set is switched on. This is normal, there is nothing wrong with the set.
- b. If possible, use the VESA 1,024x768@60Hz video mode to obtain the best image quality for your LCD monitor. If used under the other resolutions, some scaled or processed pictures may appear on the screen. If used to PC vertical frequency 85Hz, some noise can be seen when PIP is on. In this case, set the PC vertical frequency to 60Hz. The set has been pre-adjusted to the mode VESA 1,024x768@60Hz.
- c. Some dot defects may appear on the screen, like Red, Green or Blue spots. However, this will have no impact or effect on the monitor performance.
- d. Do not press the LCD screen with your finger for a long time as this may produce some temporary distortion effects on the screen.
- e. When the PC screen appears on the set, a message may appear on the screen, and the message will differ according to the Window system version (Win98, 2000). If a message appears click "Next" until the message finishes.
- f. If the message "out of Range" appears on the screen, adjust the PC as in the 'Displayable Monitor Specification' section.

### DPM (Display Power Management) mode

When the PC is in the power saving mode, automatically the monitor goes into DPM mode to save the energy.

**Note :** Use the supplied signal cable with the set. Otherwise, **DPM** mode may not work.

## Connection of PC

### Menu selection

1. Press the **MENU** button and then **▲** / **▼** button to display each menu.
2. Press the **OK** or **▶** button and then **▲** / **▼** button to select a menu item.
3. Change the setting of an item in the sub menu or the pull-down menu with **◀** / **▶**.

You can move to the higher level menu by pressing the **OK** button and to move to the lower level menu by pressing the **MENU** button.

### Note :

- a. See 'Picture adjustment' section to adjust the picture.
- b. See 'Sound adjustment' section to adjust the sound.
- c. See 'TV, AV and PC modes' section to select TV, AV1, AV2, AV3, S-Video or RGB-PC.

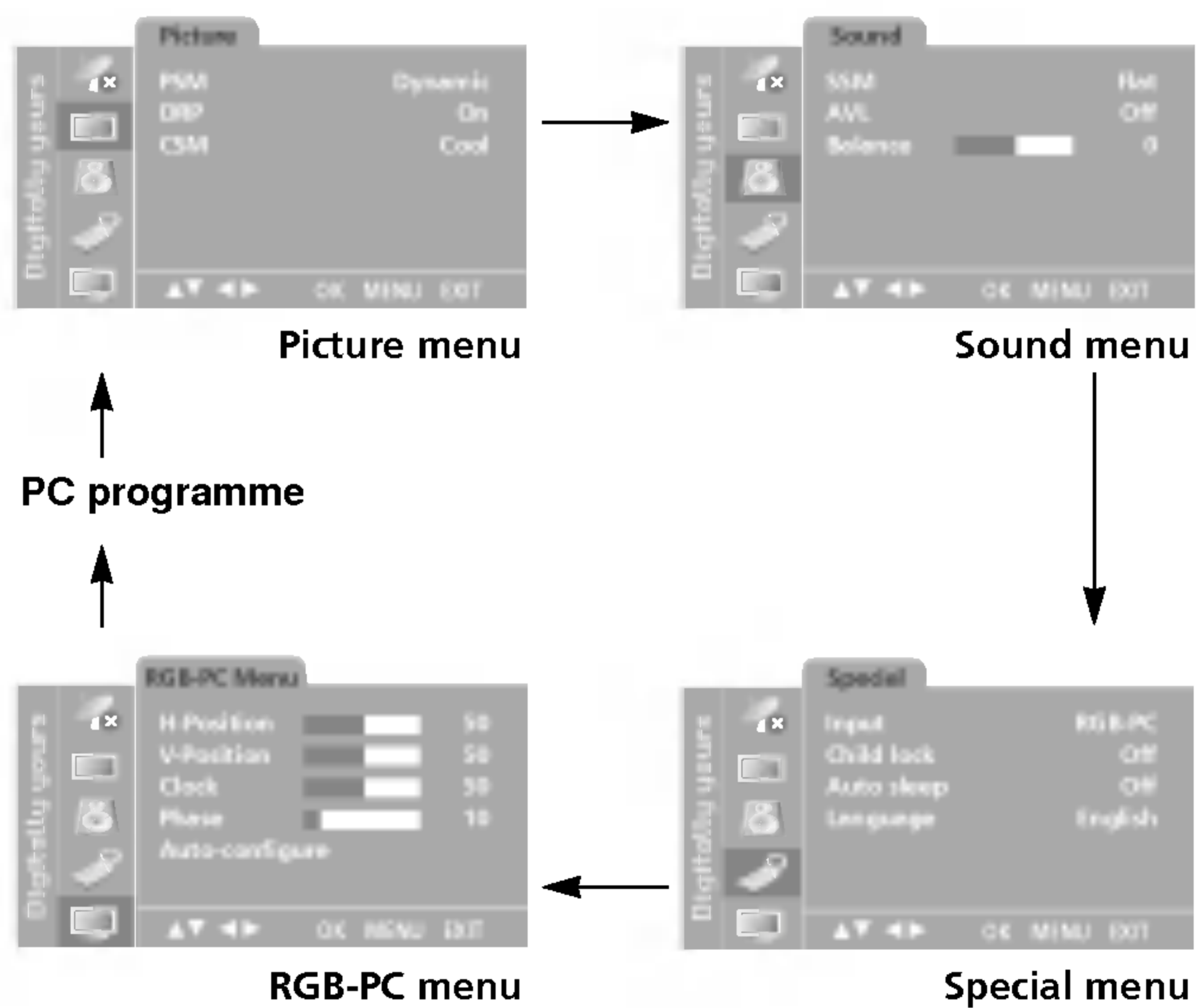
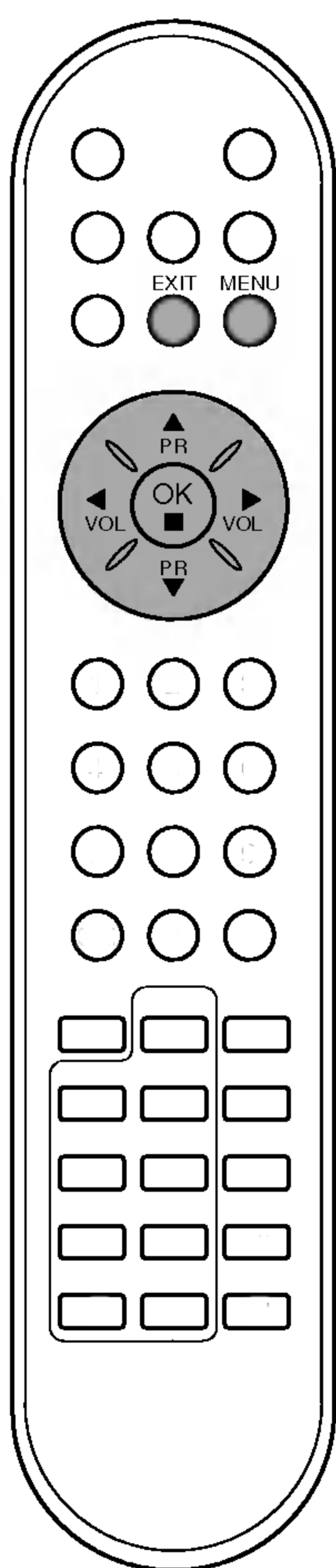

---

## Connection of PC

---

### PC Setup

You can adjust horizontal/vertical position, clock, phase, and auto-configure as you prefer.

1. Press the **MENU** button and then **▲** / **▼** button to select the RGB-PC menu.
2. Press the **OK** or **▶** button and then **▲** / **▼** button to select the desired picture item.



RGB-PC menu



3. Press the **◀** / **▶** button to make appropriate adjustments.

#### H-Position / V-Position

This function is to adjust picture to left/right and up/down as you prefer.

#### Clock

This function is to minimize any vertical bars or stripes visible on the screen background. And the horizontal screen size will also change.

#### Phase

This function allows you to remove any horizontal noise and clear or sharpen the image of characters.

#### Auto-configure

This function is for the automatic adjustment of the screen position, clock and phase. The displayed image will disappear for a few seconds while the Auto-configuration is in progress.

**Note :** Some signal from some graphics boards may not function properly. If the results are unsatisfactory, adjust your monitor's position, clock and phase manually.

4. Press the **OK** button to store it for the PC monitor picture.
5. Press the **EXIT** button to return to PC mode.

