



# LCD Colour Television OWNER'S MANUAL

Please read this manual carefully before operating your set.  
Retain it for future reference.  
Record model number and serial number of the set.  
See the label attached on the back cover and quote this information to your dealer when you require service.

Model number :  
Serial number :

---

# Contents

---

<b>Installation</b>	<b>3</b>
<b>Location and function of controls</b>	<b>4</b>
Remote control handset	
Battery installation / Side panel	
<b>Basic operation</b>	<b>9</b>
On and off / Programme selection	
Volume adjustment / Quick view	
Mute function	
On screen language selection (option)	
<b>On screen menus</b>	<b>10</b>
Menu selection	
<b>Setting up TV stations</b>	<b>11</b>
Auto programme tuning	
Manual programme tuning	
Programme edit	
Favourite programme	
Calling the programme table	
<b>Picture adjustment</b>	<b>16</b>
PSM (Picture Status Memory)	
Picture adjustment	
Picture format (option)	
<b>Sound adjustment</b>	<b>18</b>
SSM (Sound Status Memory)	
Sound adjustment / Stereo/Dual reception	
NICAM reception (option) / Sound output selection	
<b>Time Menu</b>	<b>20</b>
Clock / On/Off time	
Auto off / Sleep timer	
<b>Other functions</b>	<b>22</b>
TV, AV and PC (option) modes	
Child lock	
<b>Teletext (option)</b>	<b>24</b>
Switch on/off	
SIMPLE text / TOP text (option)	
FASTEXT / Special teletext functions	
<b>Connection of external equipment</b>	<b>27</b>
Aerial socket	
Audio/Video in sockets	
S-Video/Audio in sockets (S-Video) (option)	
DVD input sockets (option)	
DTV in sockets	
<b>Connection of PC (option)</b>	<b>29</b>
PC in socket (option)	
PC Setup (only DVI-Analogue mode) (option)	
<b>External Control Device Setup ; RS-232C (option)</b>	<b>31</b>
<b>Troubleshooting check list</b>	<b>35</b>

---

---

# Installation

---

## Power

This set operates on an AC mains supply, the voltage is as indicated on the label on the back cover. Never apply DC power to the set. In the event of thunderstorms or powercuts, please pull out the aerial and mains plugs.

- Open the back panel cover.
- After connecting the power cord to the set, connect the power cord to an AC mains.
- Fix cables with the supplied cable tie after arranging connected cables.
- Pull the cables through the hole on the set.
- Close the back panel cover.

## Warning

To prevent fire or shock hazard, do not expose the set to rain or moisture. Do not rub or strike the Active Matrix LCD with anything hard as this may scratch, mar, or damage the Active Matrix LCD permanently.

## Service

Never remove the back cover of the set as this can expose you to high voltage and other hazards. If the set does not operate properly, unplug it and call your dealer.

## Aerial

Connect the aerial cable to the socket marked  $75 \Omega$  on the back. For the best reception an outdoor aerial should be used.

## Location

Position your set so that no bright light or sunlight falls directly onto the screen. Care should be taken not to expose the set to any unnecessary vibration, moisture, dust or heat. Also ensure that the set is placed in a position to allow a free flow of air. Do not cover the ventilation openings on the back cover.

This standing angle can be adjusted as shown in pictures.

If you intend to mount the TV to a wall, attach VESA standard mounting interface (optional parts) to the back of the TV.

When you install the set to use the wall mounting bracket (optional parts), fix it carefully so as not to drop.

## Cleaning

Unplug the set before cleaning the face of the LCD Screen. Dust the set by wiping the screen and the cabinet with a soft, clean cloth. If the screen requires additional cleaning, use a clean, damp cloth. Do not use liquid cleaners or aerosol cleaners.

## On Disposal

The fluorescent lamp used in this product contains a small amount of mercury.

Do not dispose of this product with general household waste.

Disposal of this product must be carried out in accordance to the regulations of your local authority.

- Here shown may be somewhat different from your set.

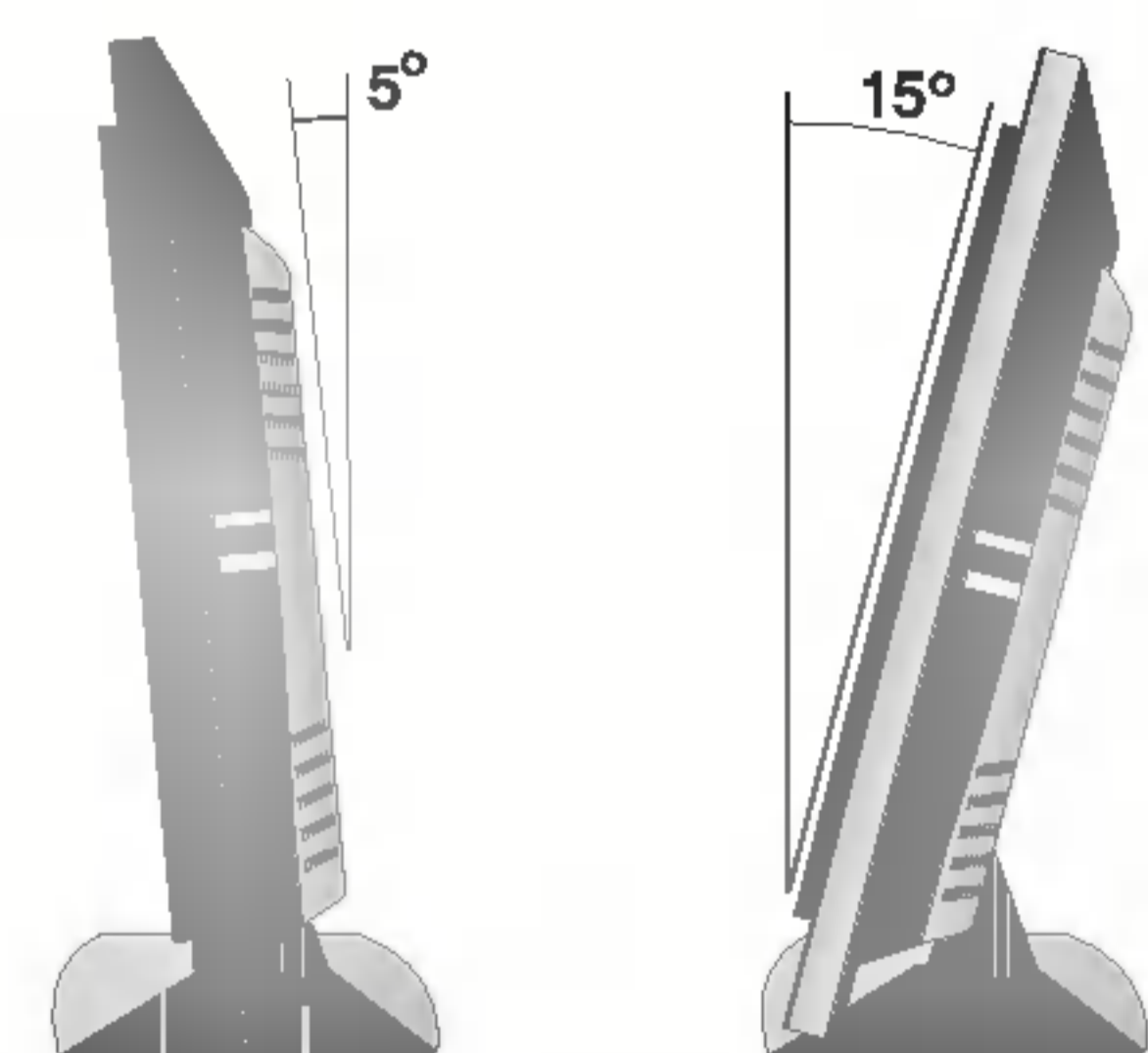
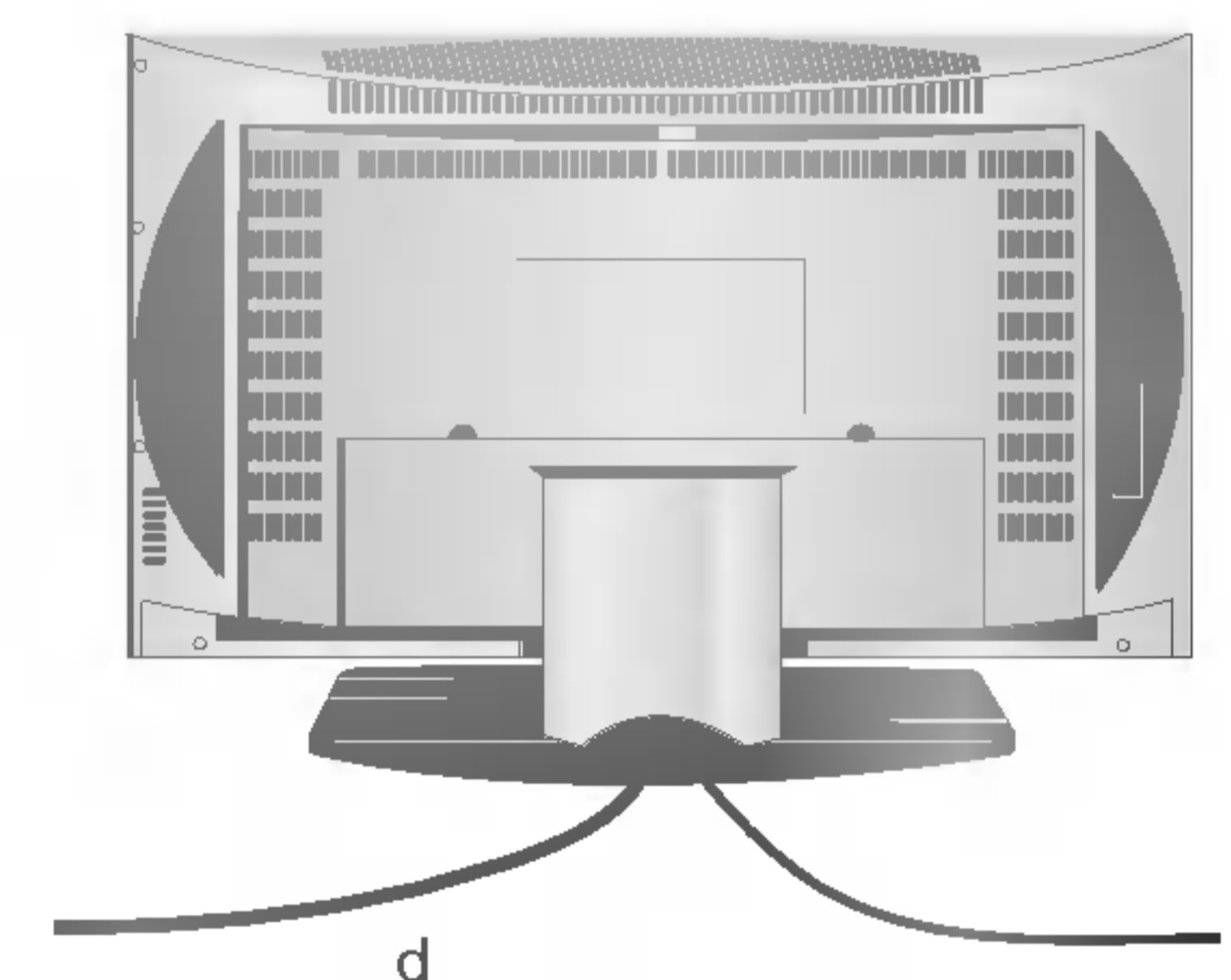
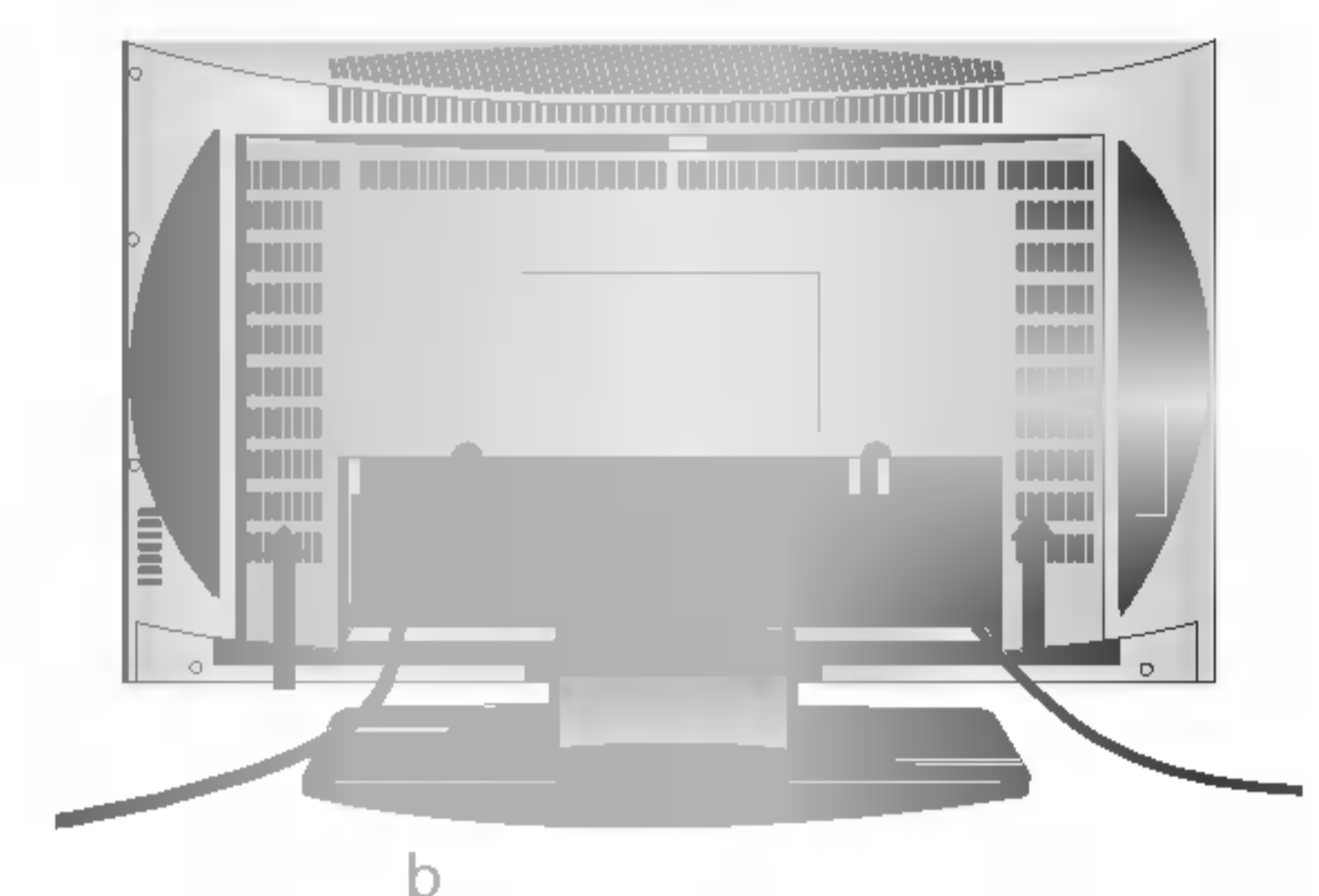
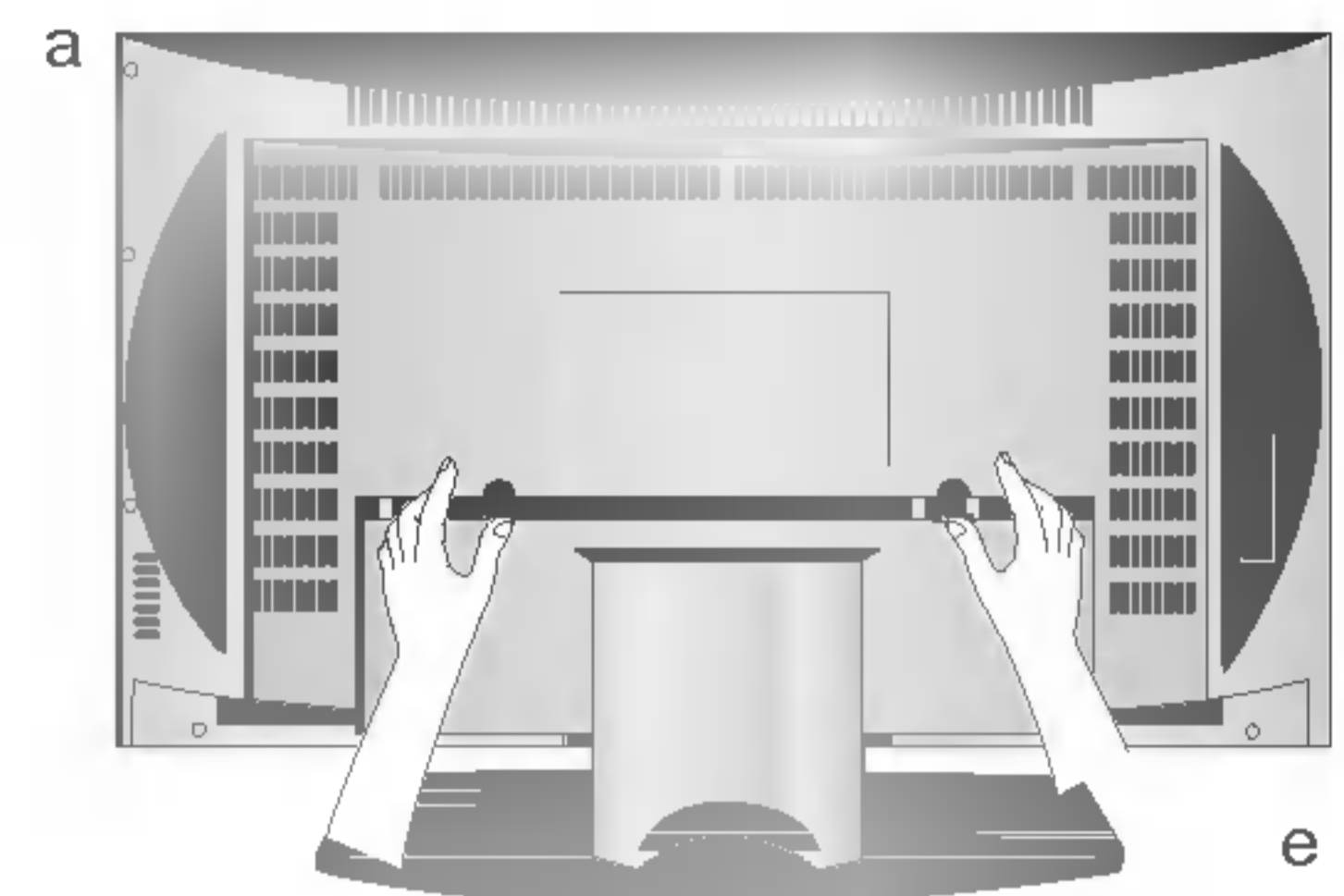



# Location and function of controls

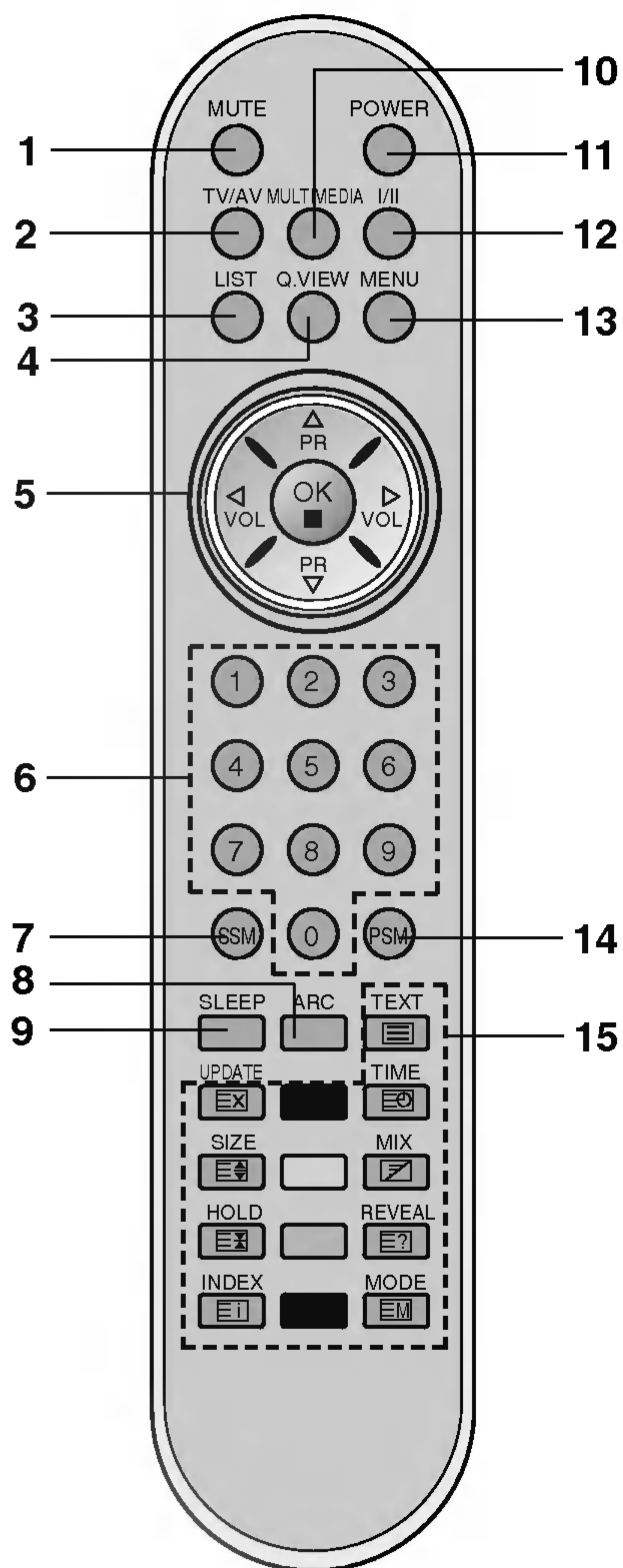

(With TELETEXT/ARC)



(Without ARC)  
(With TELETEXT)

All the functions can be controlled with the remote control handset. Some functions can also be adjusted with the buttons on the side panel of the set. Only the remote control handset supplied will operate this set.

## Remote control handset

Before you use the remote control handset, please install the batteries. See the next page.

1. **MUTE**  
switches the sound on or off.
2. **TV/AV**  
selects TV or AV monitor mode.  
clears the menu from the screen.  
switches the set on from standby.
3. **LIST**  
displays the programme table.
4. **Q.VIEW**  
returns to the previously viewed programme.  
selects a favourite programme.
5. **▲ / ▼ (Programme Up/Down)**  
selects a programme or a menu item.  
switches the set on from standby.  
**◀ / ▶ (Volume Down/up)**  
adjusts the volume.  
adjusts menu settings.  
**OK**  
accepts your selection or displays the current mode.
6. **NUMBER BUTTONS**  
switches the set on from standby and selects a programme.
7. **SSM (Sound Status Memory)**  
recalls your preferred sound setting.
8. **ARC (option)**  
select your desired picture format.
9. **SLEEP**  
sets the sleep timer.
10. **MULTIMEDIA (option)**  
selects **COMPONENT** or **PC** monitor mode.

# Location and function of controls

## 11. POWER

switches the set on from standby or off to standby.

## 12. I/II

selects the language during dual language broadcast.  
selects the sound output (option).

## 13. MENU

selects a menu.

## 14. PSM (Picture Status Memory)

recalls your preferred picture setting.

## 15. TELETEXT BUTTONS (option)

These buttons are used for teletext.  
For further details, see the 'Teletext' section.

**\* : No function**

**COLOURED BUTTONS :** These buttons are used for teletext (only TELETEXT models) or programme edit.

## Battery installation

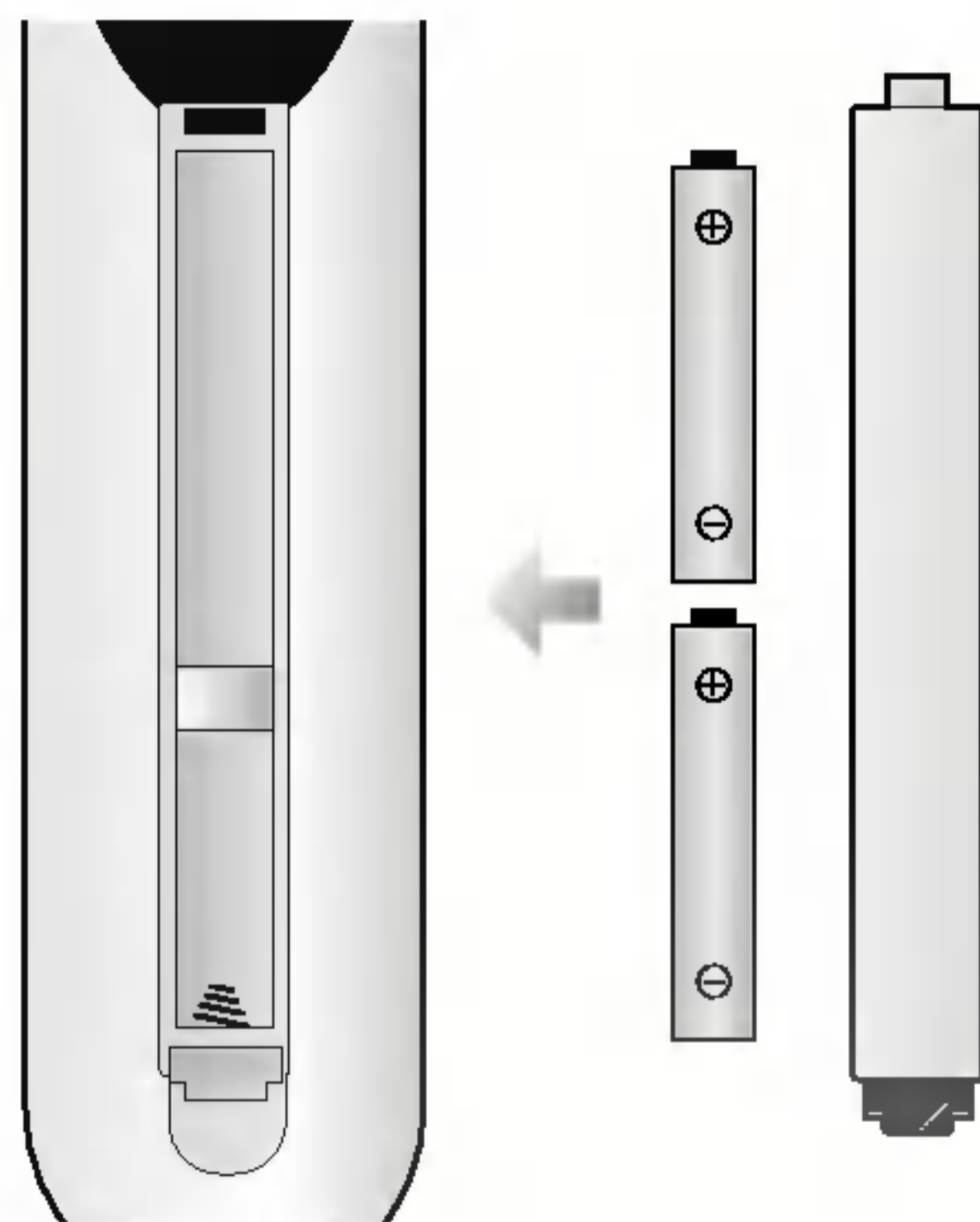

The remote control handset is powered by two AAA/Alkaline type batteries. To load the batteries, turn the remote control handset over and open the battery compartment. Install two batteries as indicated by the polarity symbols (+ and -) marked inside the compartment.

**Note :** To avoid damage from possible battery leakage, remove the batteries if you do not plan to use the remote control handset for an extended period of time.

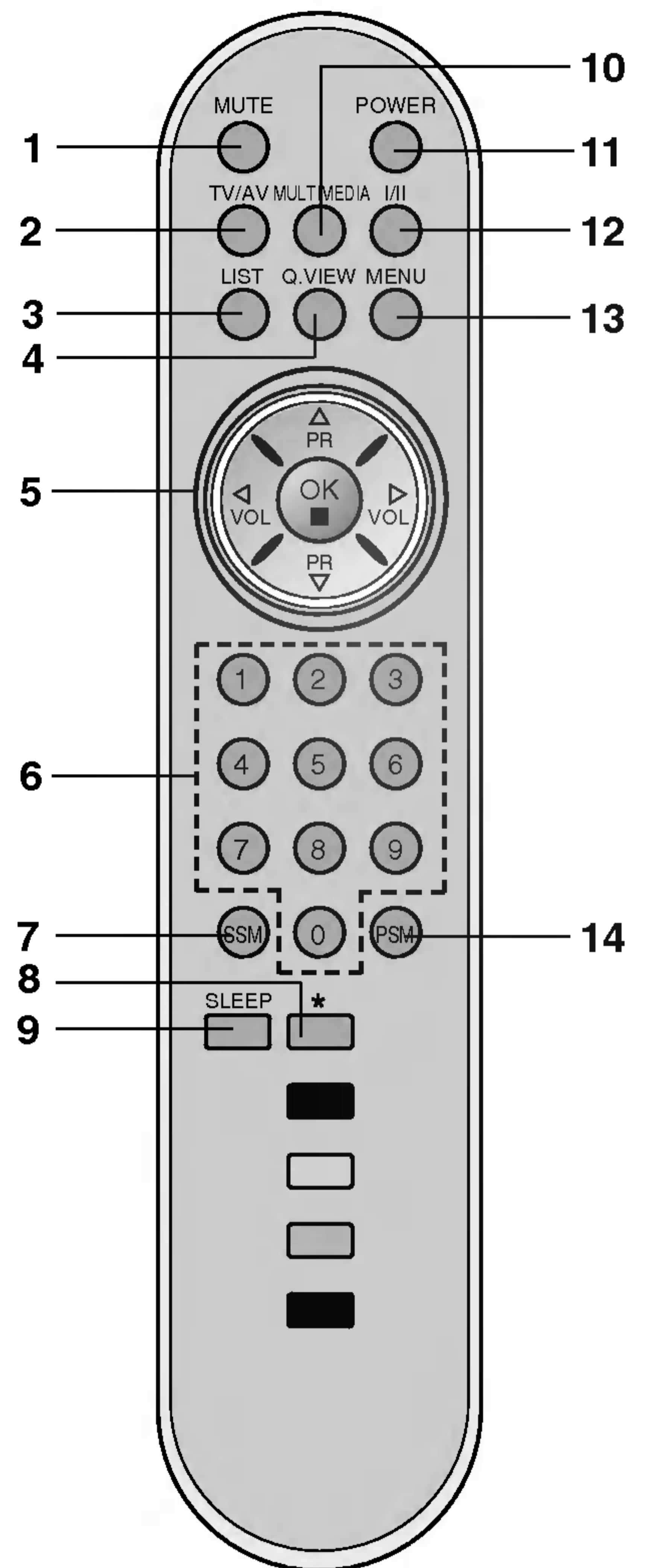

(Without TELETEXT/ARC)

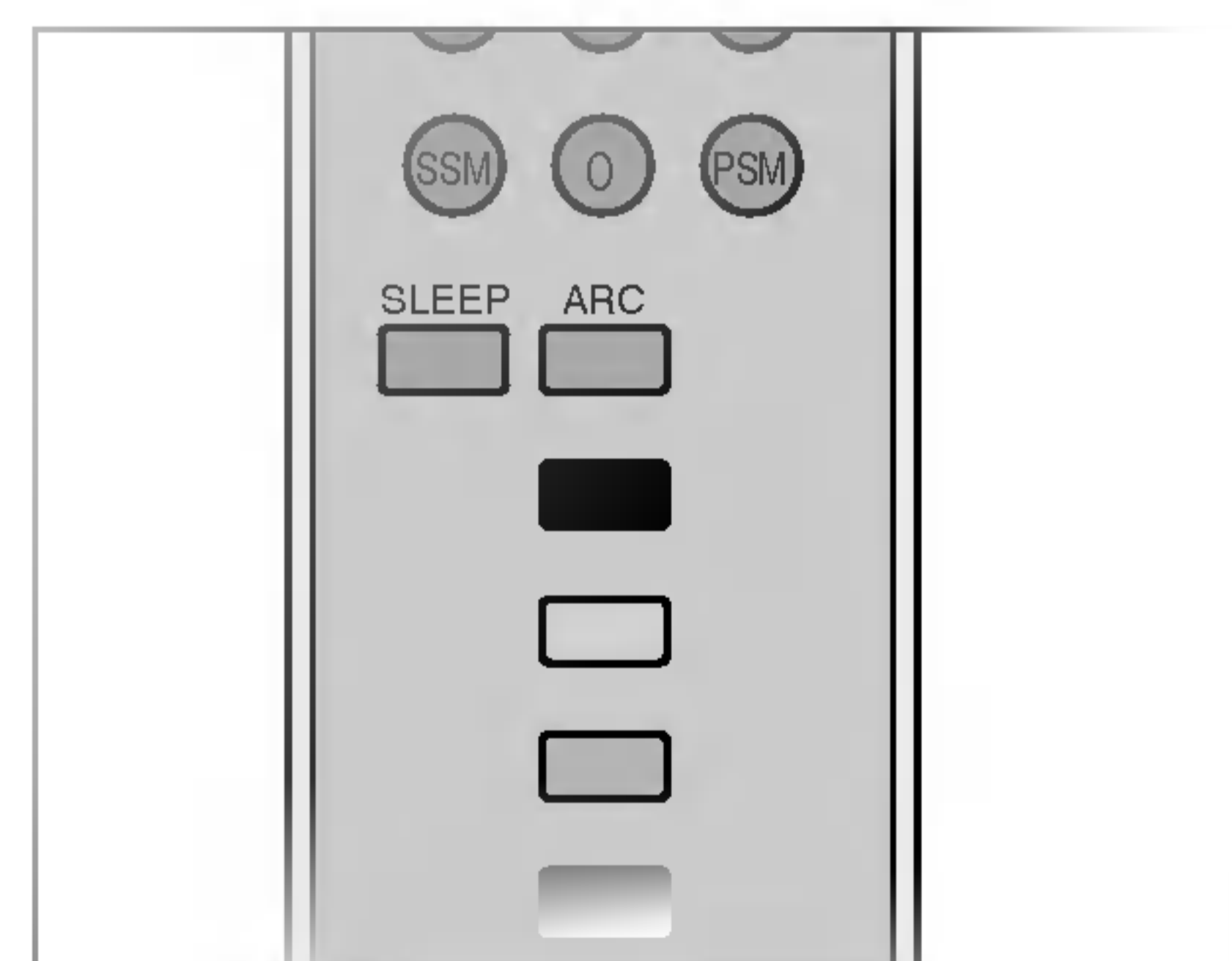

(With ARC)  
(Without TELETEXT)



# Location and function of controls

\* : The mark consists of blank or alphabet.

RT-23 / 26 / 27 / 30 / 32LZ50 \*\*\*

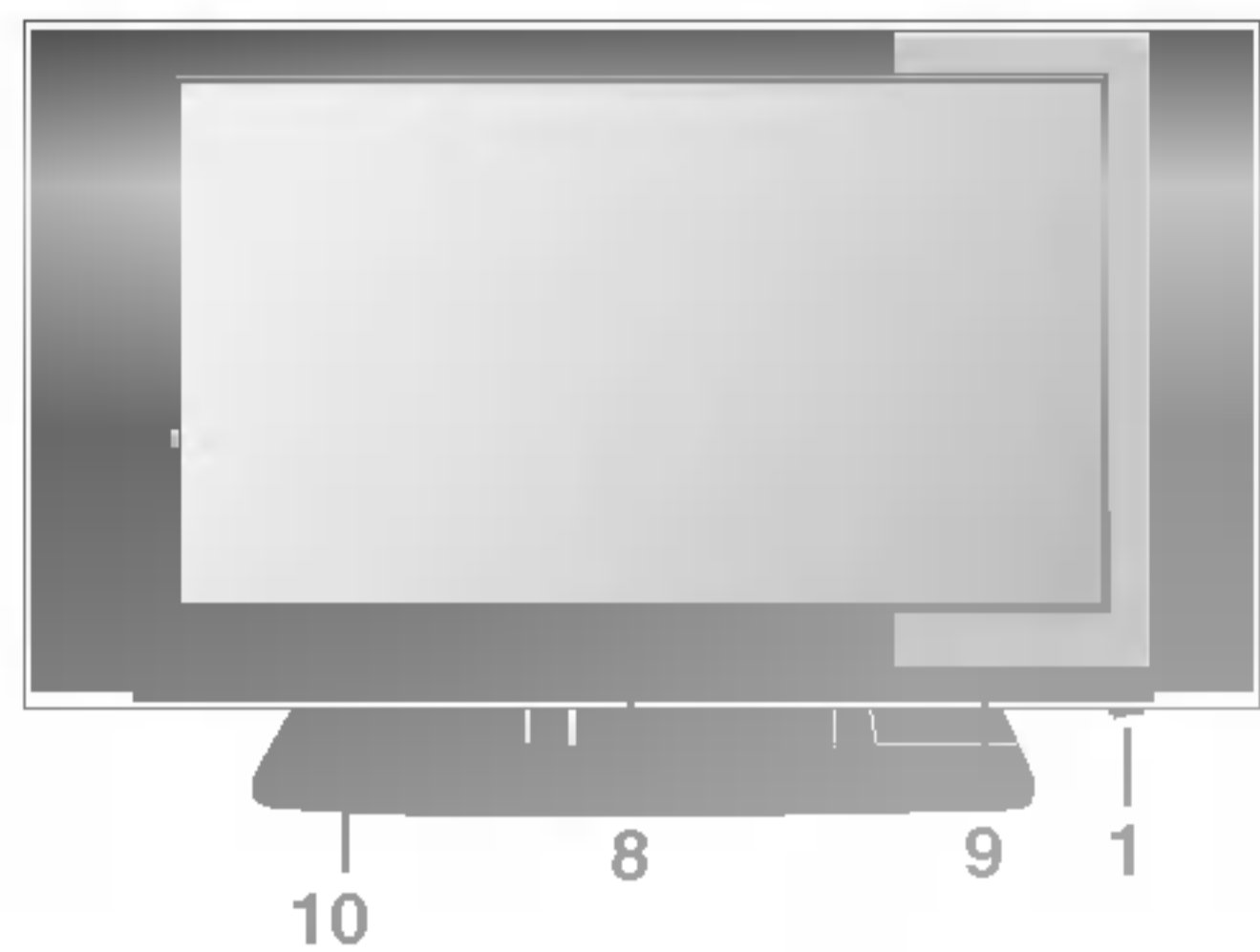

Side panel

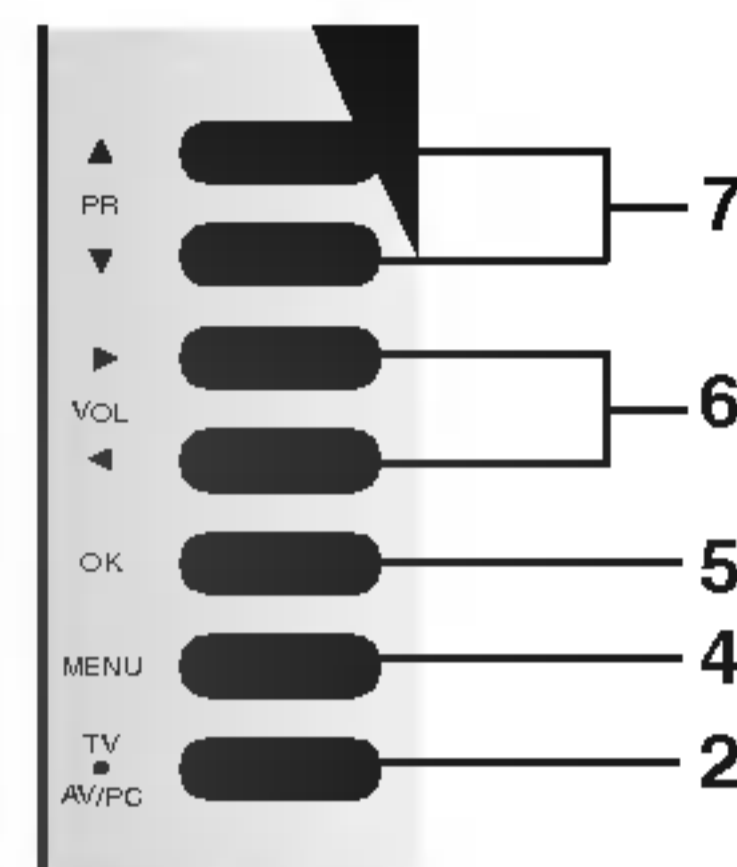

RT-26LZ30 \*\*\*

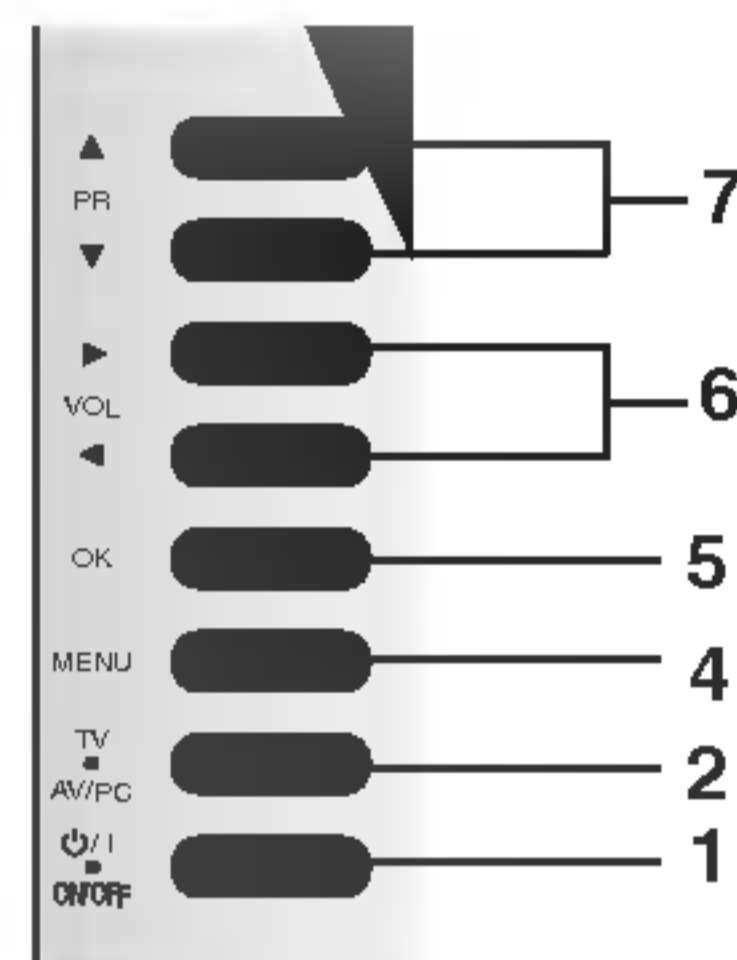
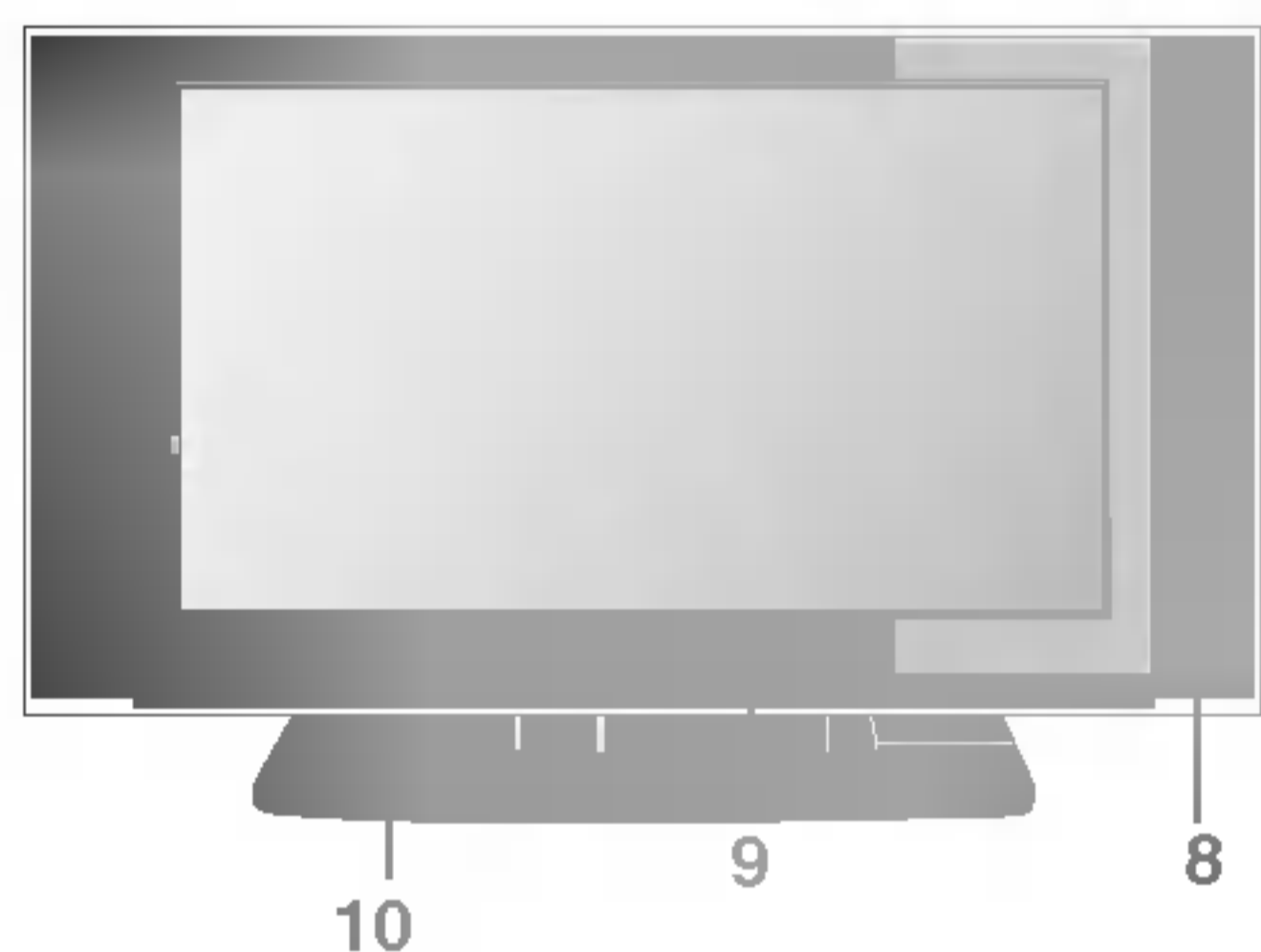

RT-17LZ50 \*\*\*

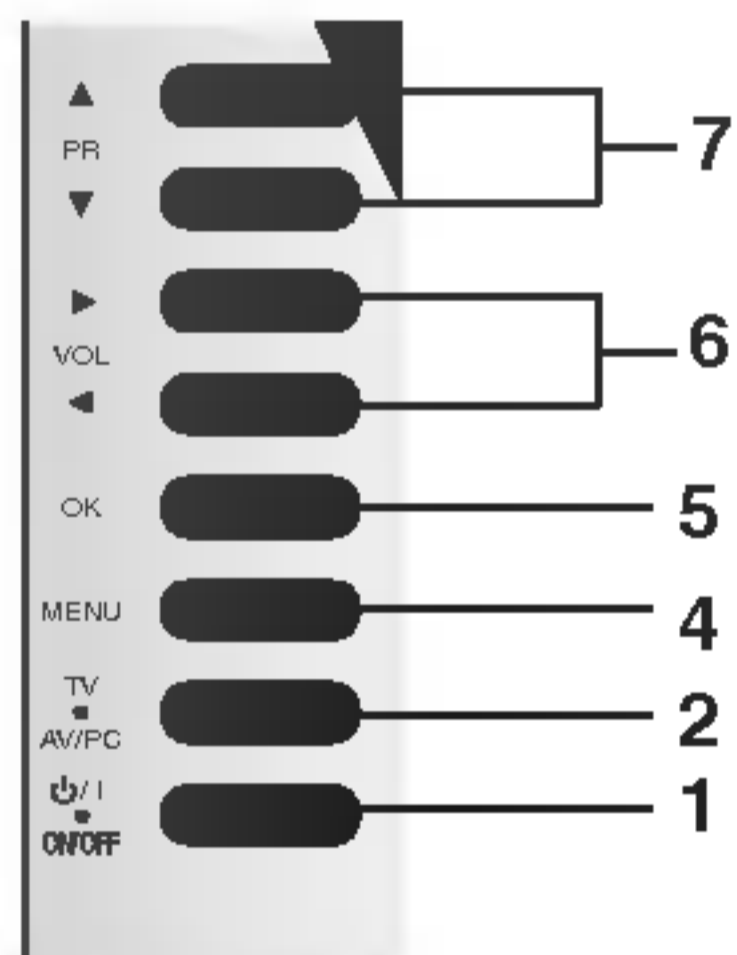
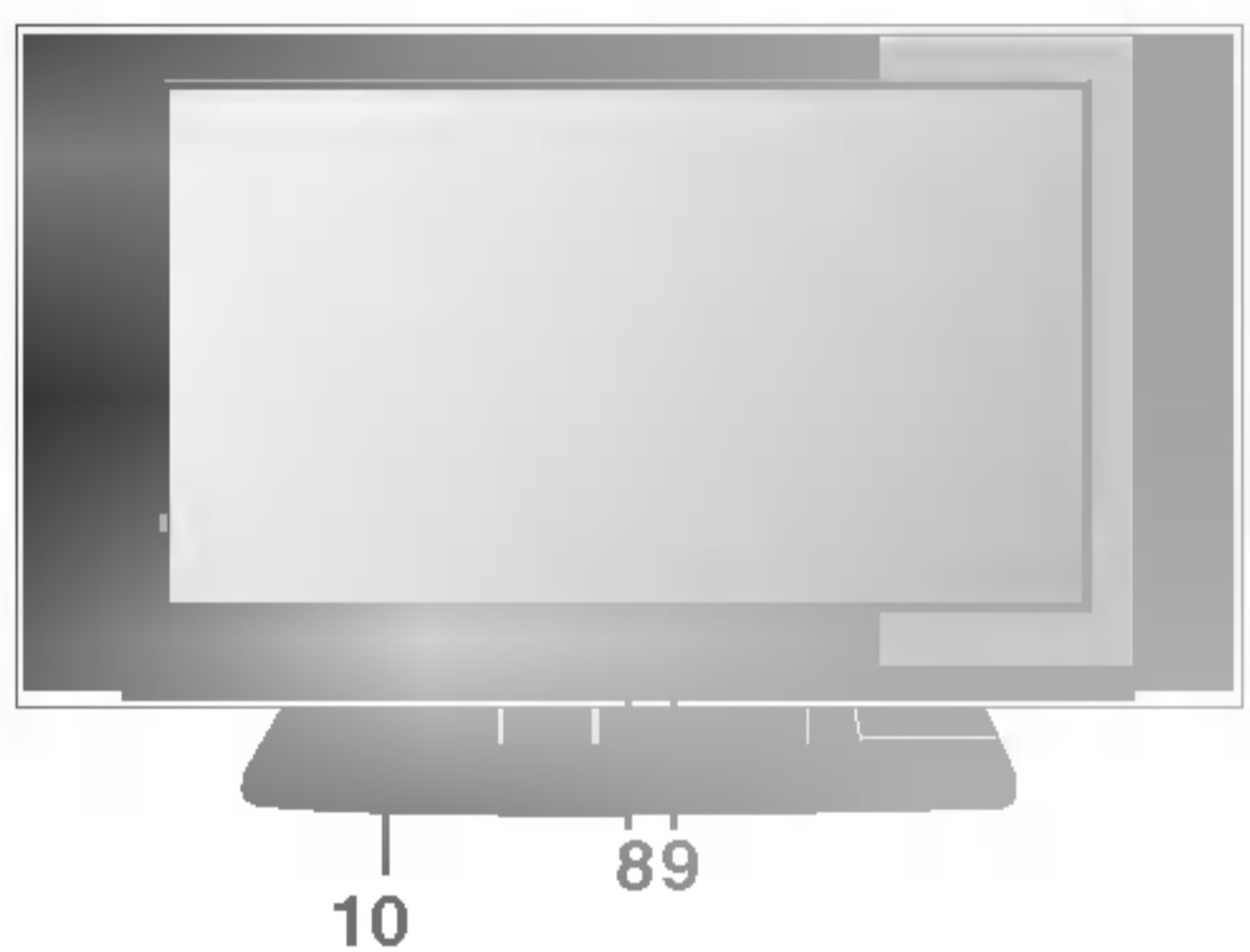

RT-15LA70 \*\*\*

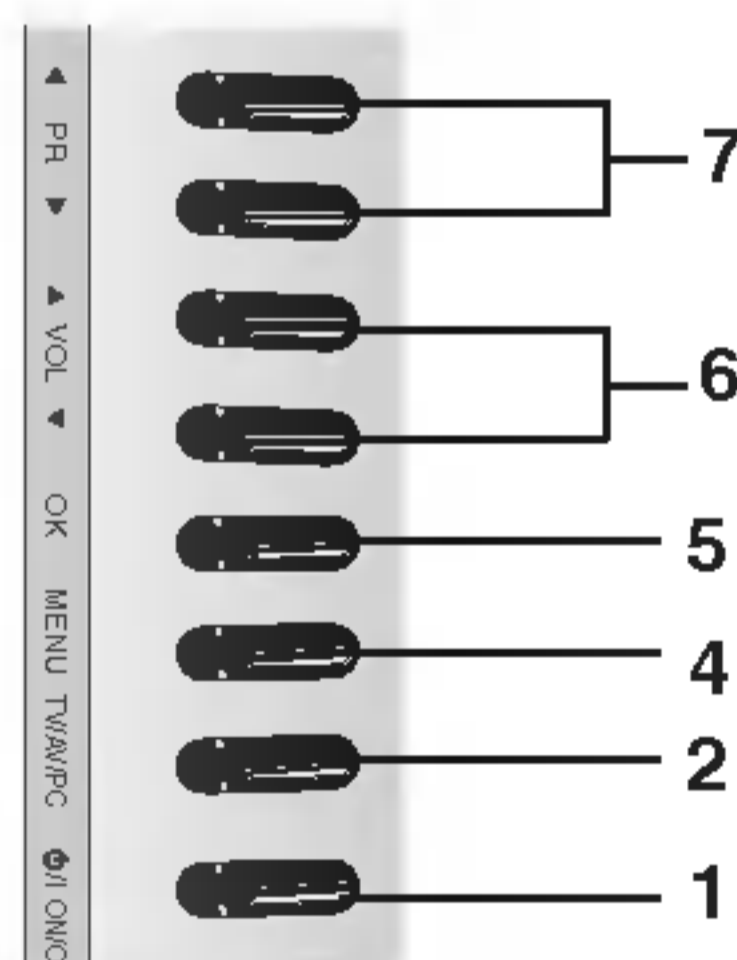
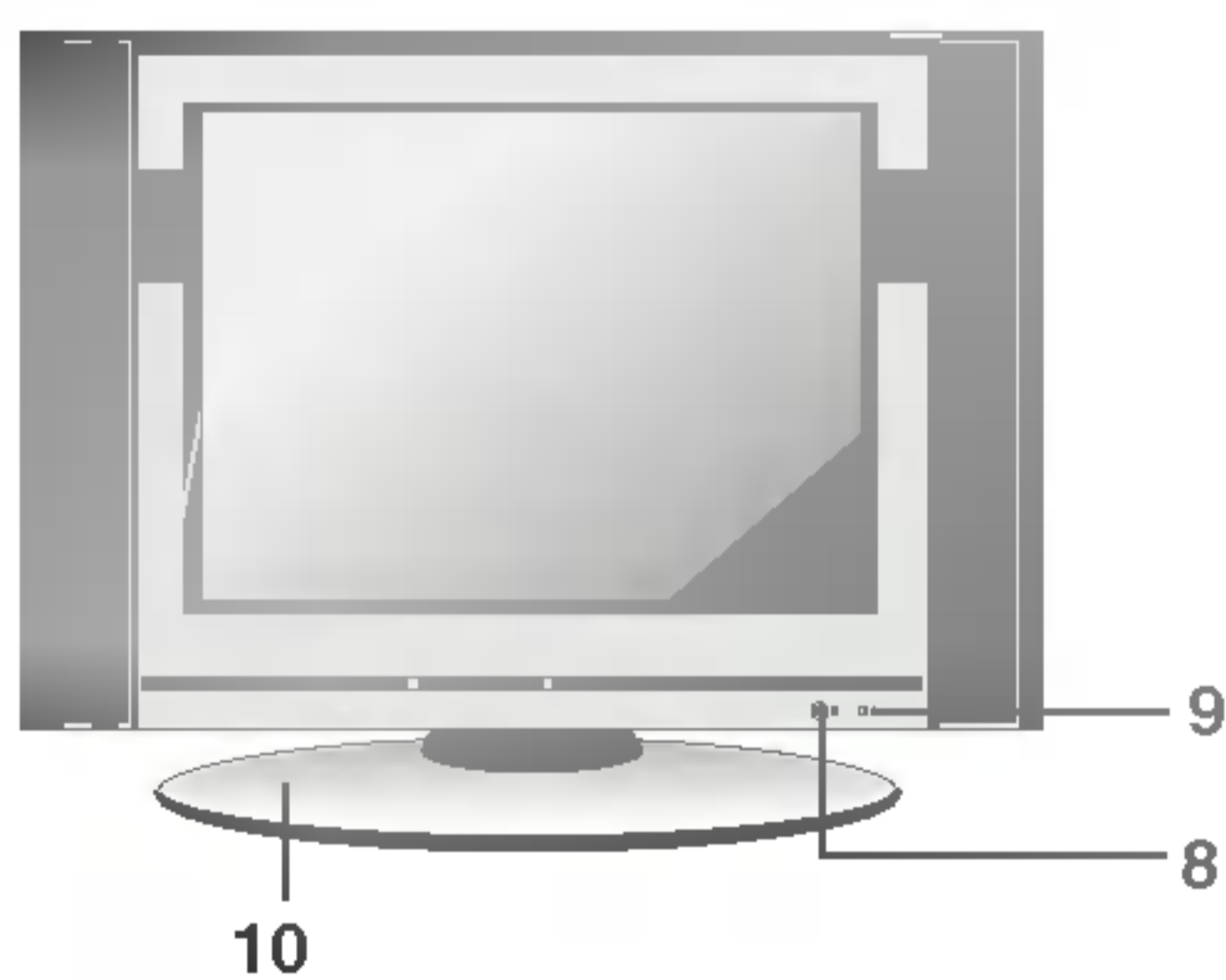

RT-15LA66 \*\*\*

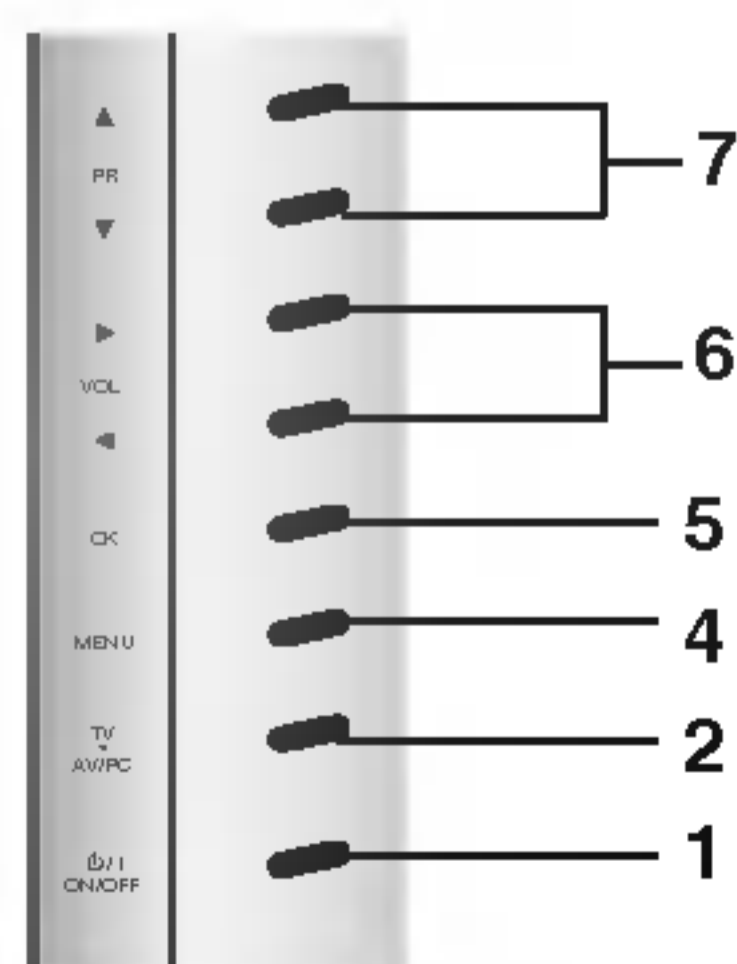
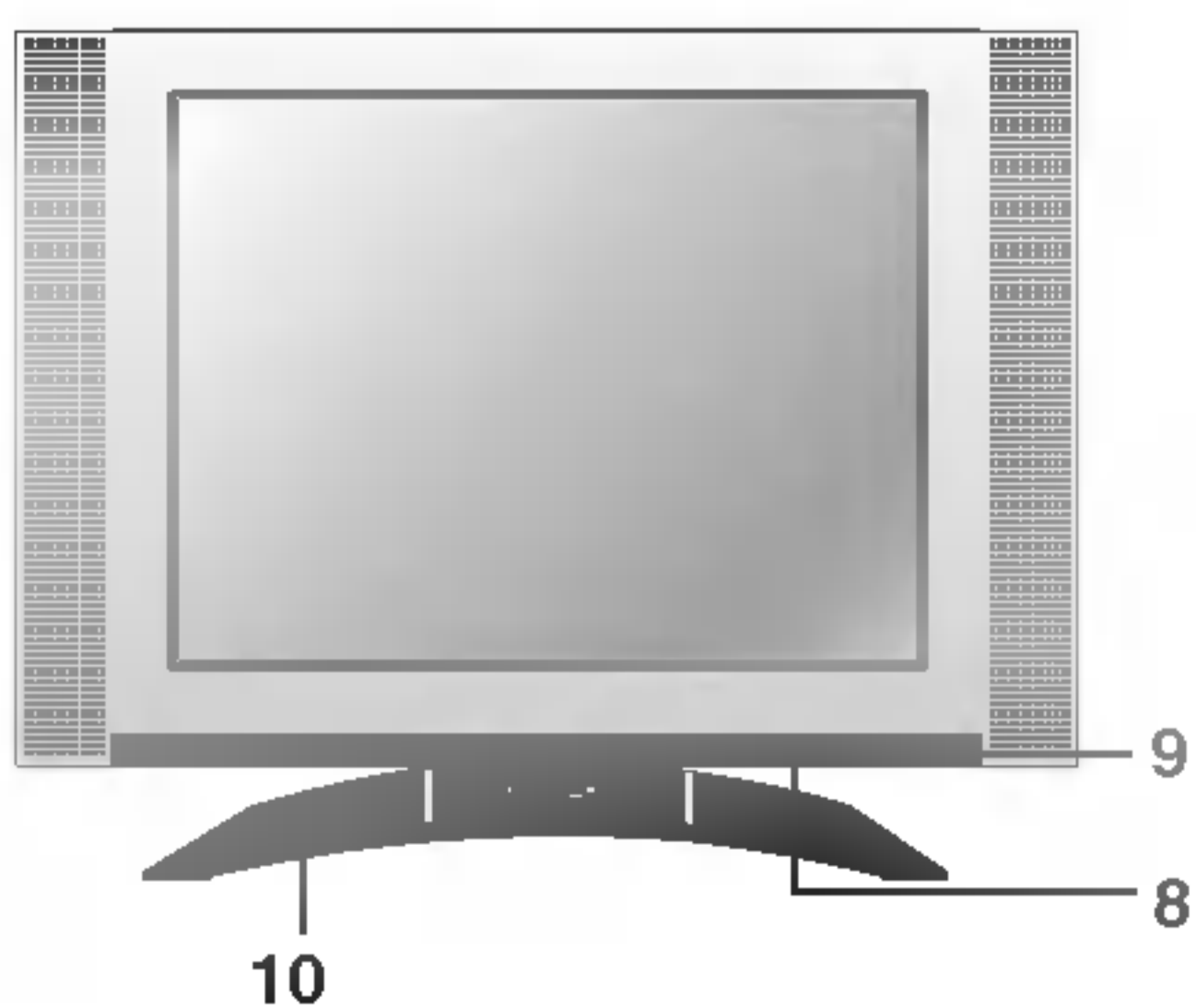

# Location and function of controls

## Side panel

RT-20LA70 \*\*\*

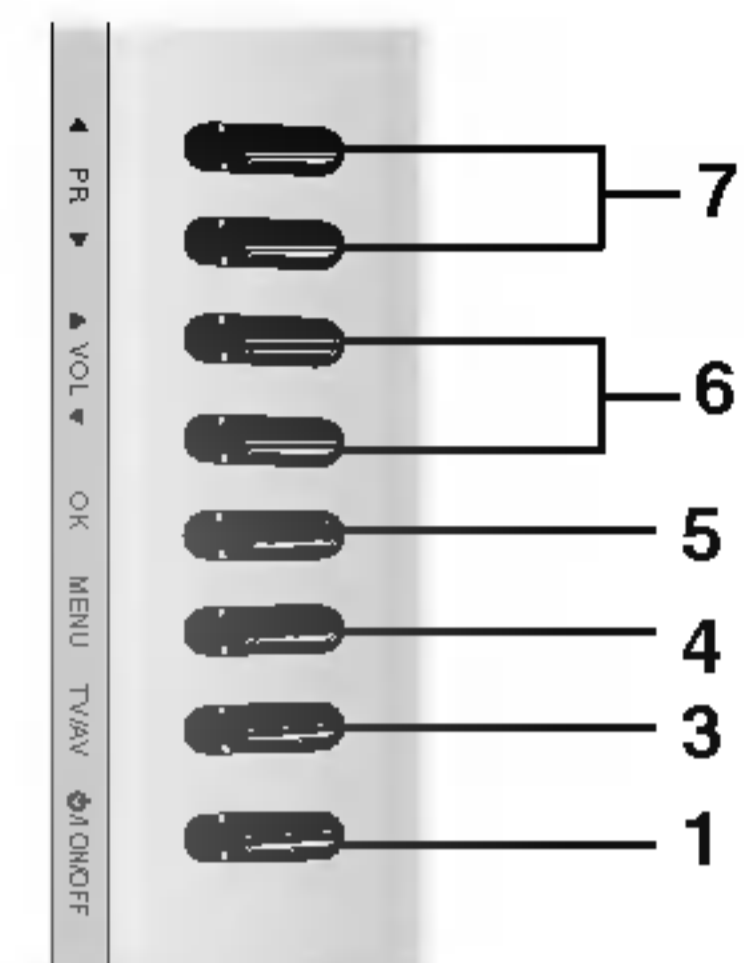
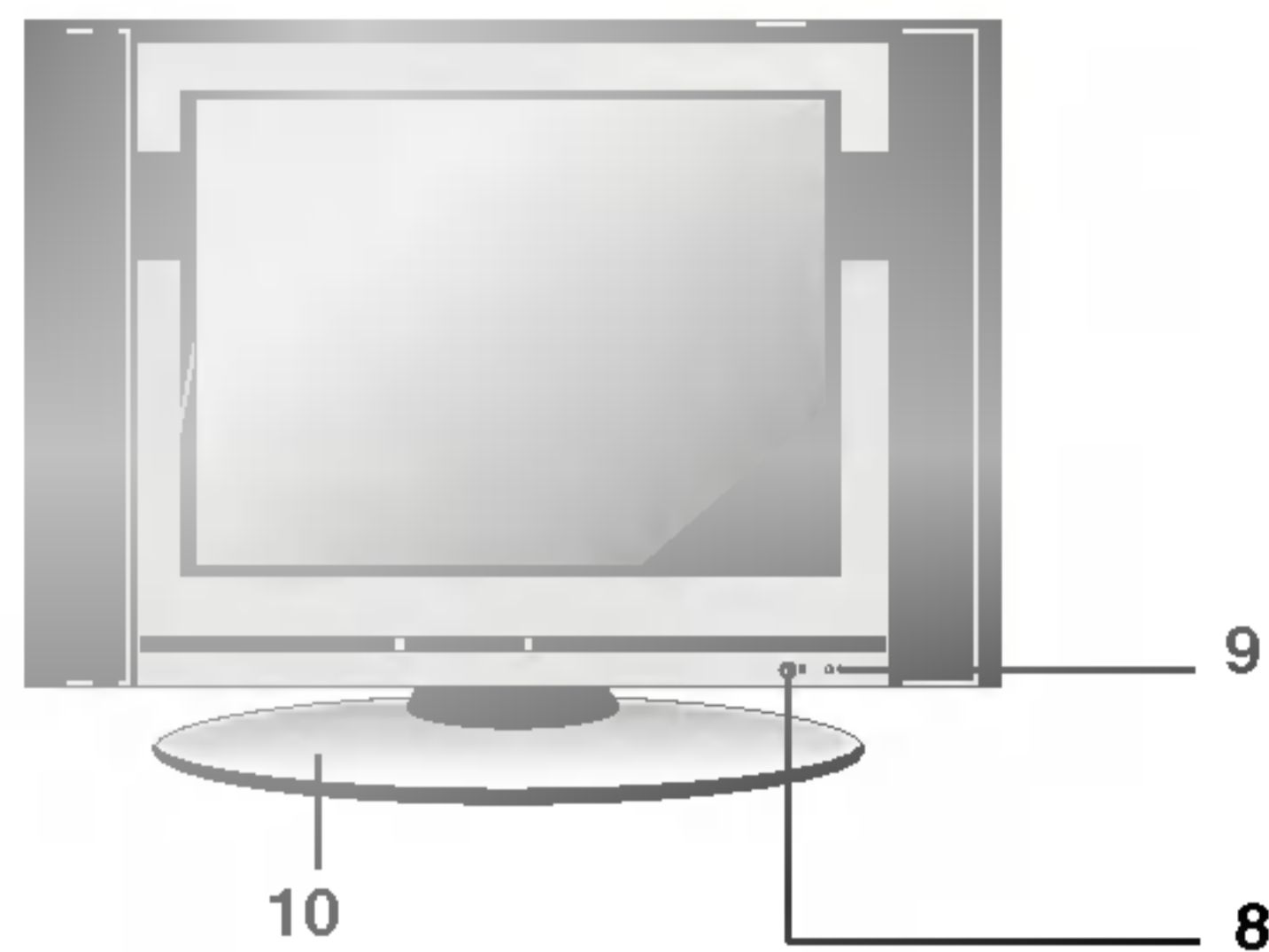

RT-20LA66 \*\*\*

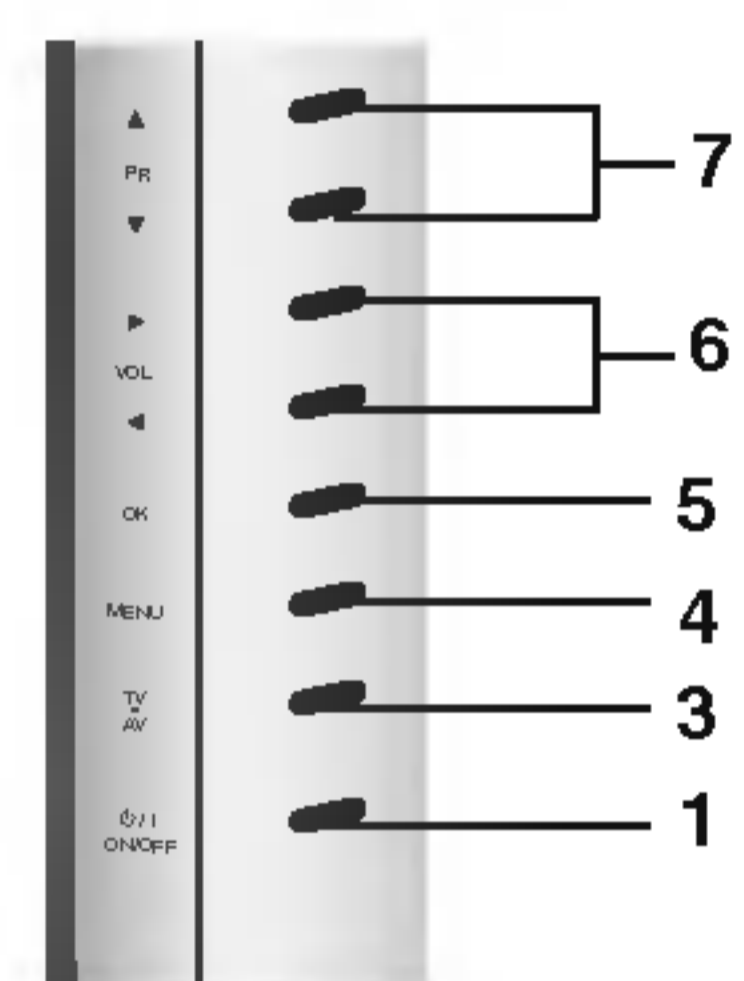
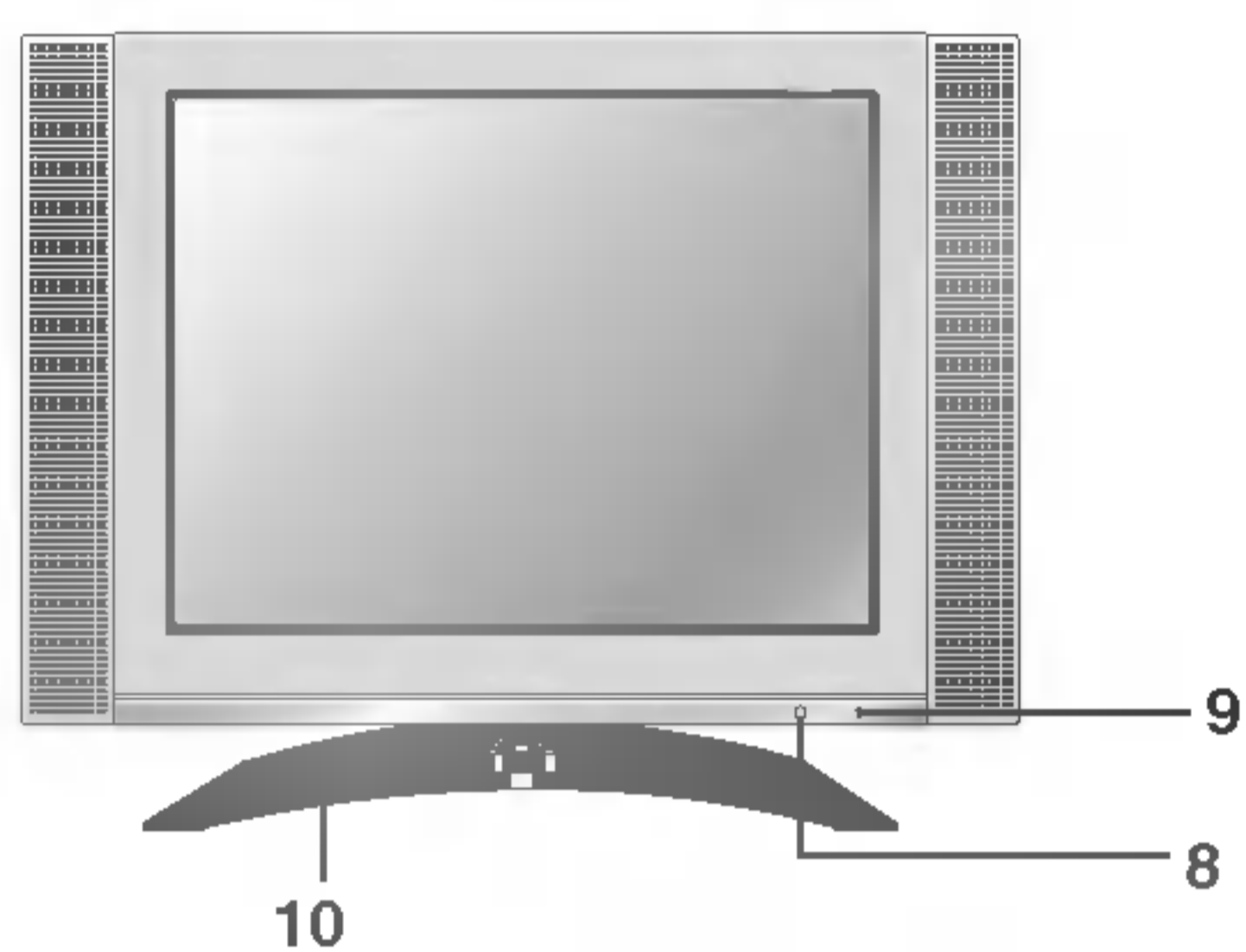

RT-23LZ41 \*\*\*

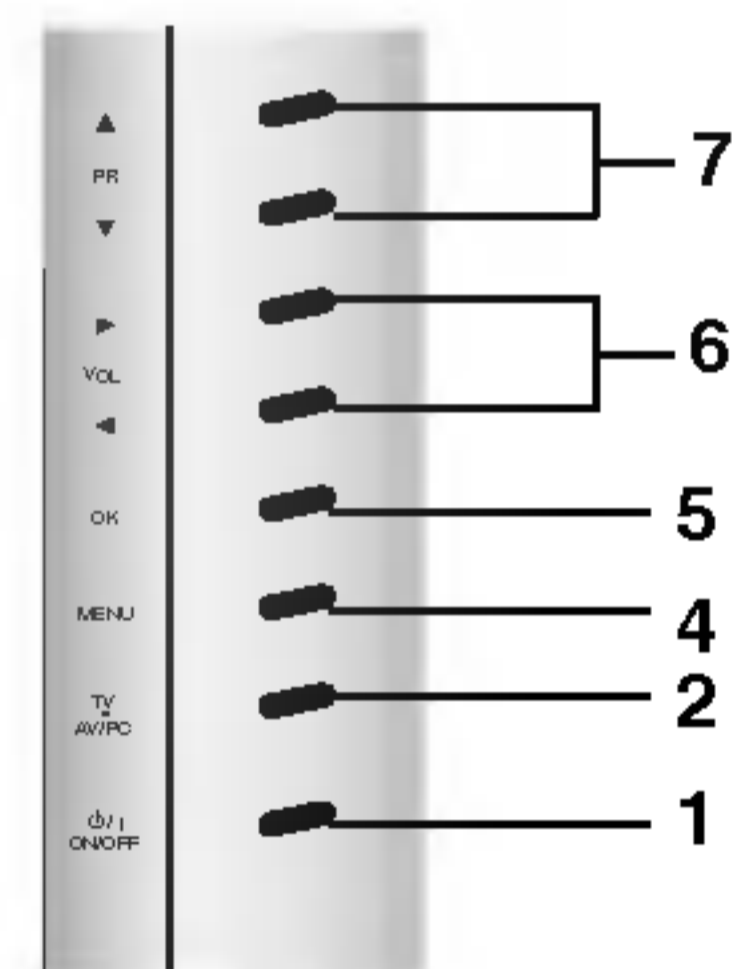
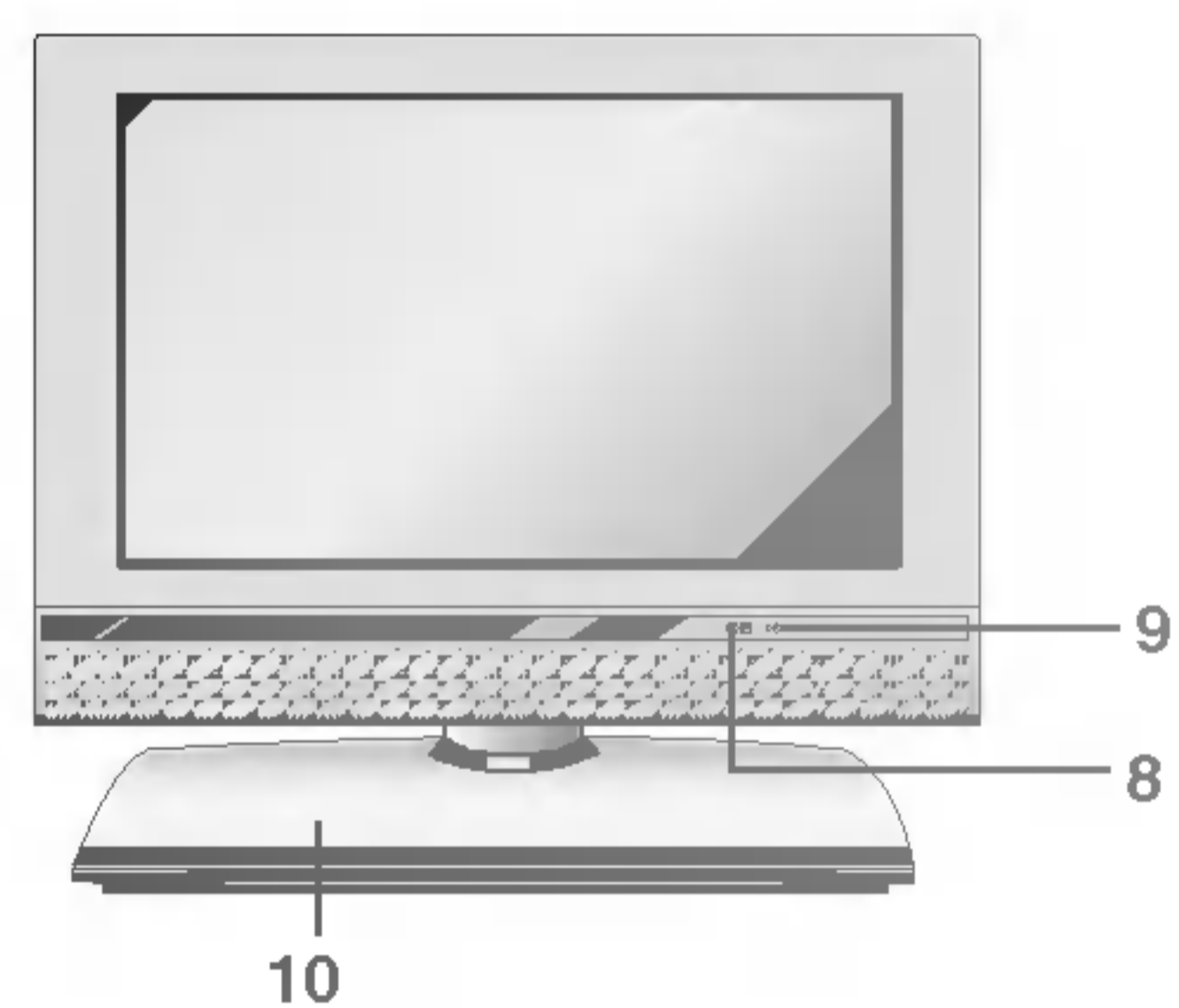

RT-20LZ50 \*\*\*

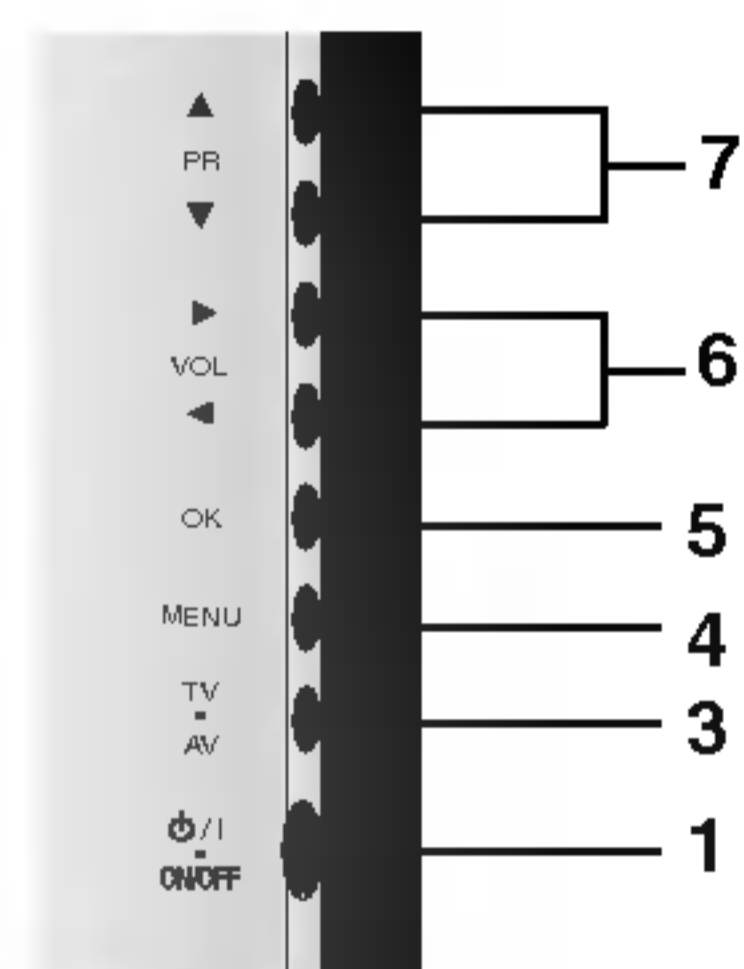

RT-20LA90 \*\*\*

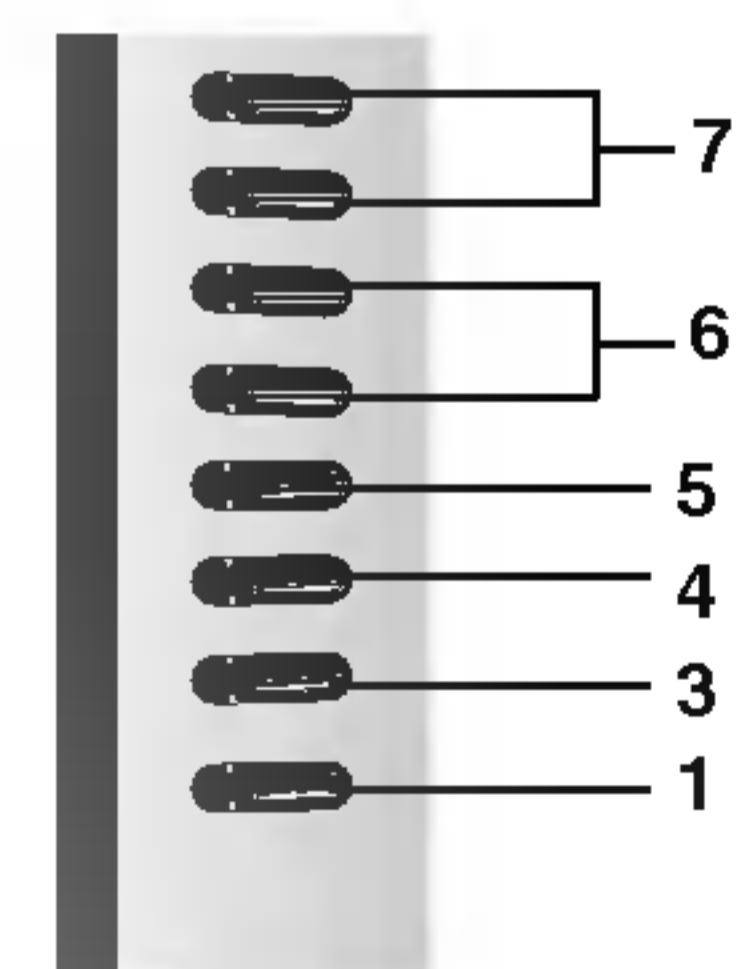
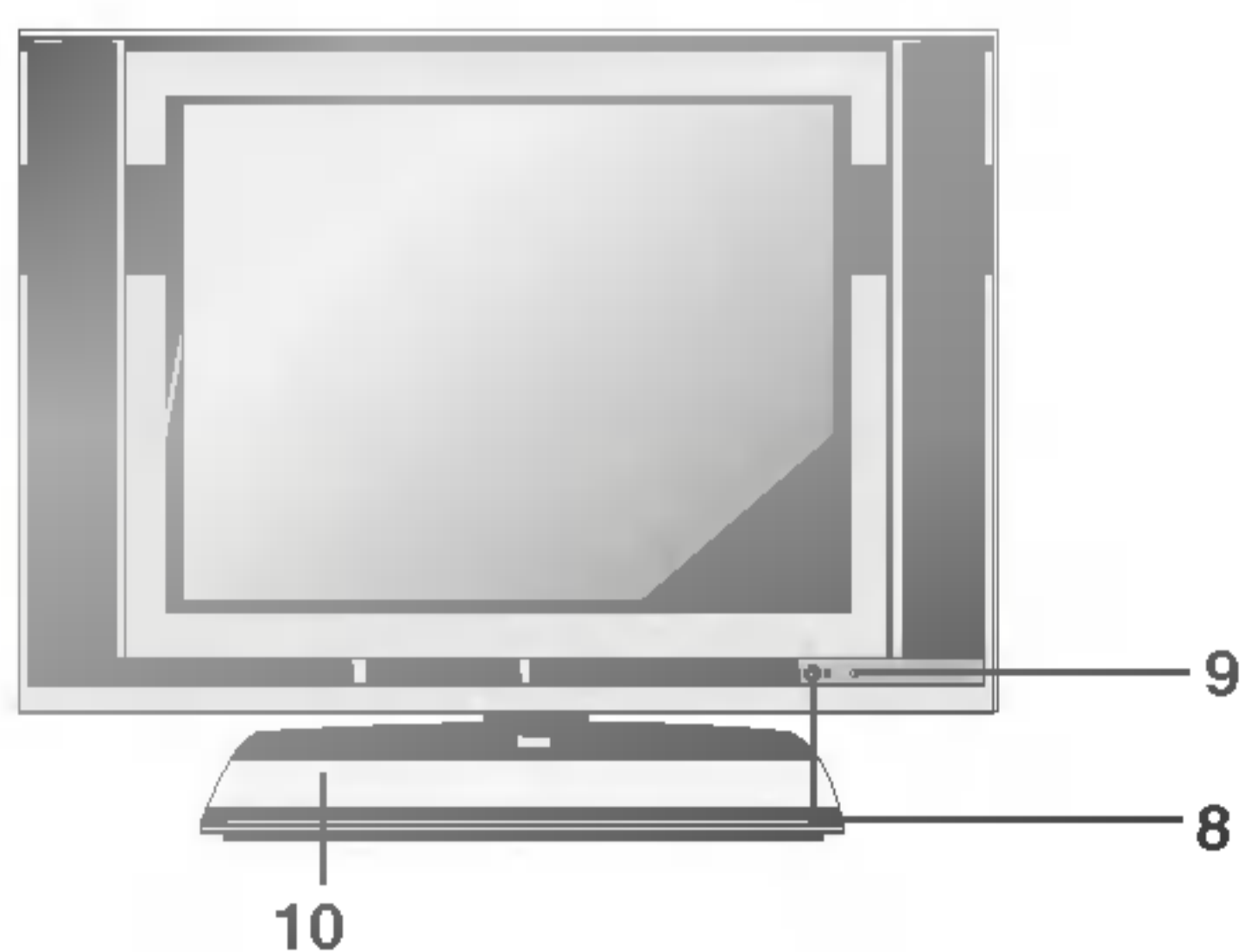

---

# Location and function of controls

---

RT-17LZ40 \*\*\*

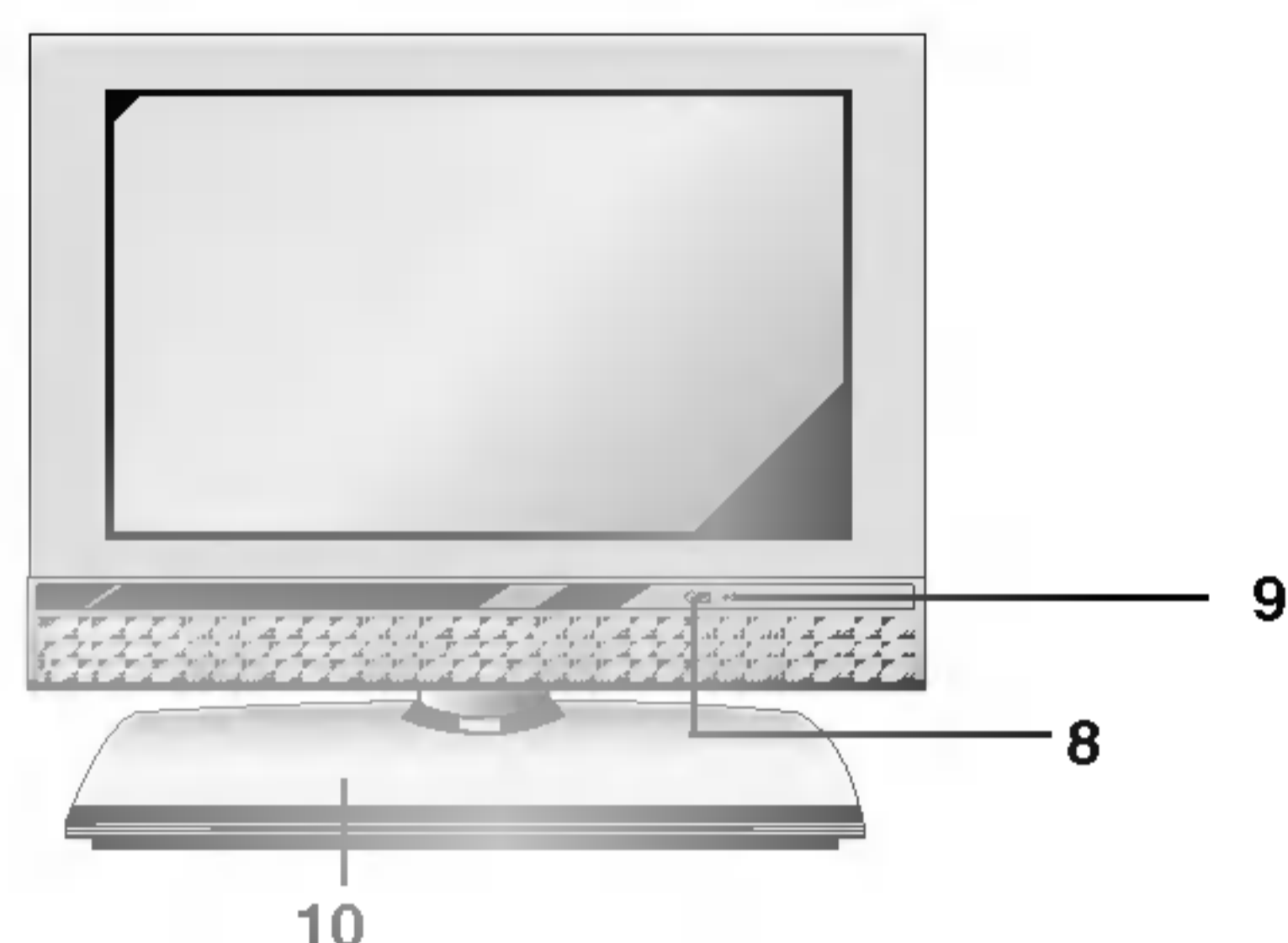

Top panel

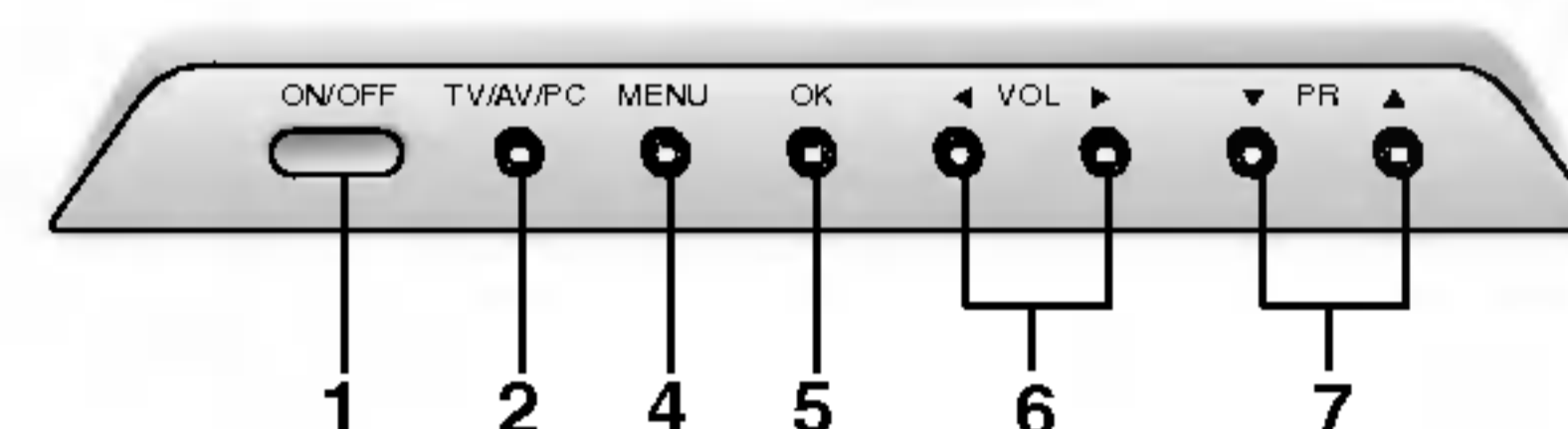

1. **ON/OFF (⏻ / I)**  
switches the set on from standby or off to standby.
2. **TV/AV/PC**  
selects TV, AV or PC monitor mode.  
clears the menu from the screen.  
switches the set on from standby.
3. **TV/AV**  
selects TV or AV mode.  
clears the menu from the screen.  
switches the set on from standby.
4. **MENU**  
selects a menu.
5. **OK**  
accepts your selection or displays the current mode.
6. **◀ / ▶ (Volume Down/Up)**  
adjusts the volume.  
adjusts menu settings.
7. **▲ / ▼ (Programme Up/Down)**  
selects a programme or a menu item.  
switches the set on from standby.
8. **REMOTE CONTROL SENSOR**
9. **POWER/STANDBY INDICATOR (⏻)**  
illuminates red in standby mode.  
illuminates green when the set is switched on.
10. **Stand (option)**



---

# Basic operation

---

## On and off

1. Press the **POWER**, **▲ / ▼**, **TV/AV**, **MULTIMEDIA (option)** or **NUMBER** buttons to switch it on fully.
2. Press the **POWER** button. The set reverts to standby mode.
3. Pull out mains plugs to switch the set off.

**Note :** If, while the set is switched on, the mains plug is disconnected the set will switch to standby or power on when the mains plug is replaced in the mains power socket.

## Programme selection

You can select a programme number with the **▲ / ▼** or **NUMBER** buttons.

## Volume adjustment

Press the **◀ / ▶** button to adjust the volume.

## Quick view

Press the **Q.VIEW** button to view the last programme you were watching.

**Note :** This function works only when **Favourite programme** is set to **Off**. Otherwise each press of this button will select a stored favorite programme.

## Mute function

Press the **MUTE** button. The sound is switched off and the display  appears.

You can cancel it by pressing the **MUTE**, **◀ / ▶**, **I/II**, or **SSM** button.

## On screen language selection (option)

The menu can be displayed on the screen in your desired language. First select your language.

1. Press the **MENU** button and then **▲ / ▼** button to select the Setup menu.
2. Press the **▶** button and then **▲ / ▼** button to select **Language**.
3. Press the **▶** button and then **▲ / ▼** button to select your desired language.  
All the on screen displays will appear in the selected language.
4. Press the **OK** button.
5. Press the **TV/AV** button to return to normal TV viewing.

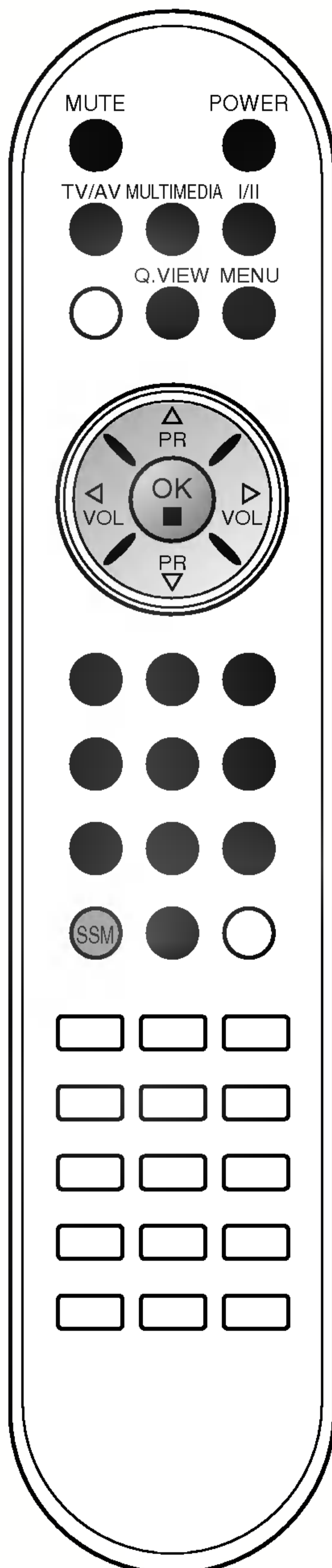

# On screen menus

## Menu selection

1. Press the **MENU** button and then **▲ / ▼** button to display each menu.
2. Press the **▶** button and then **▲ / ▼** button to select a menu item.
3. Change the setting of an item in the sub or pull-down menu with **◀ / ▶** button.

You can move to the higher level menu by pressing the **OK** button and to move to the lower level menu by pressing the **MENU** button.

### Note :

- a. In the TV/AV, COMPONENT (option) mode, the PC menu is not displayed.
- b. In the teletext mode, menus are not displayed.
- c. On some models, the Language will not be displayed.

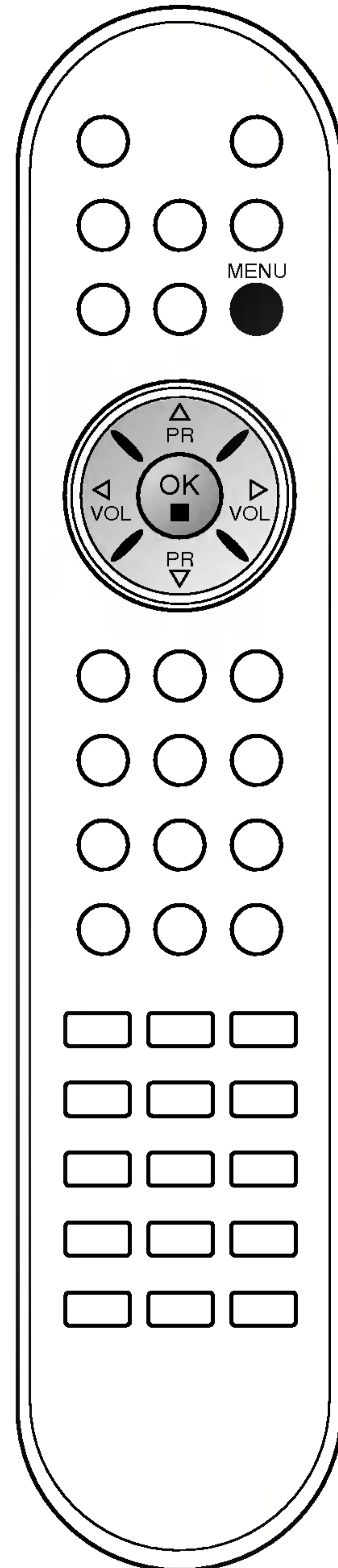
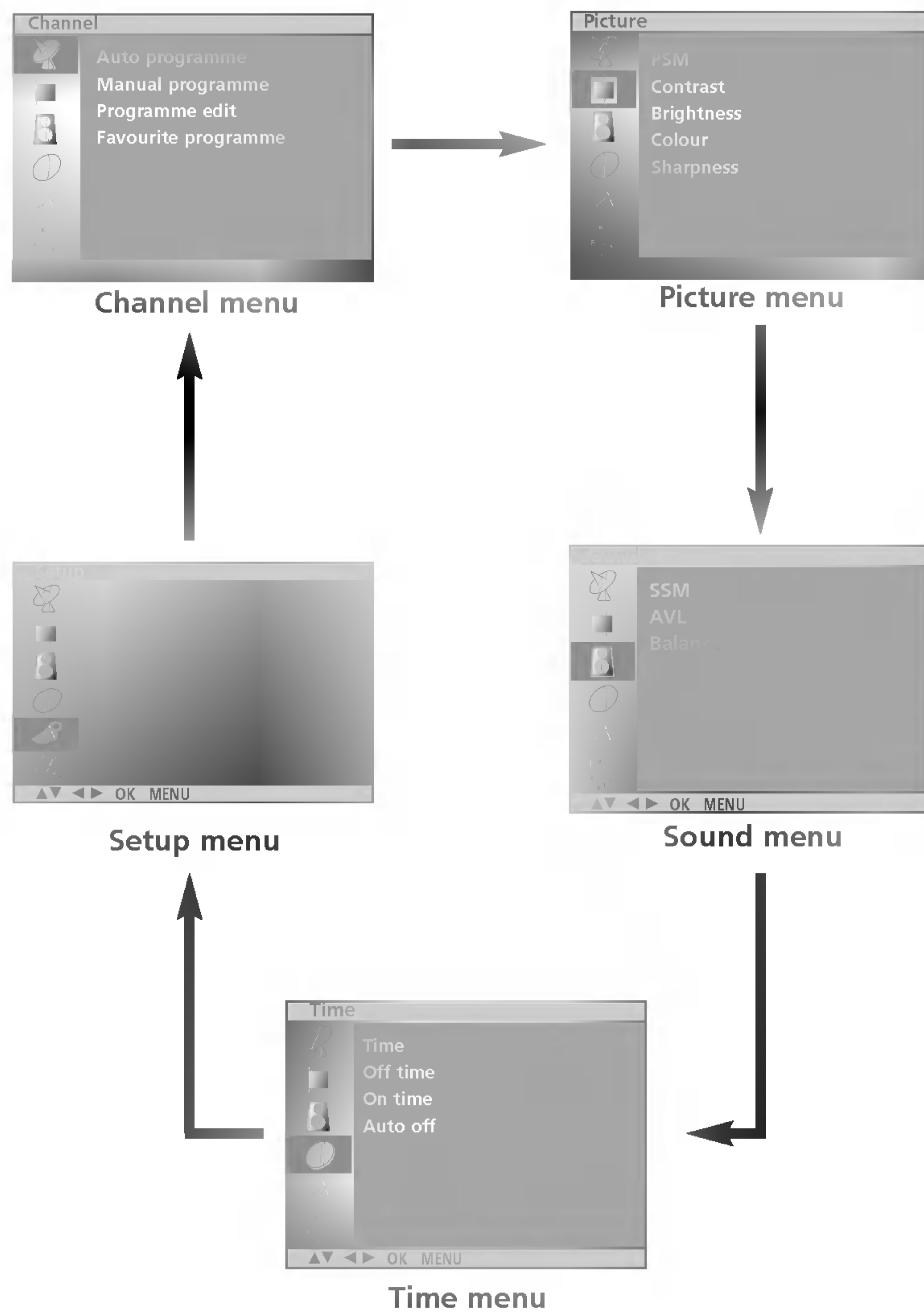



# Setting up TV stations

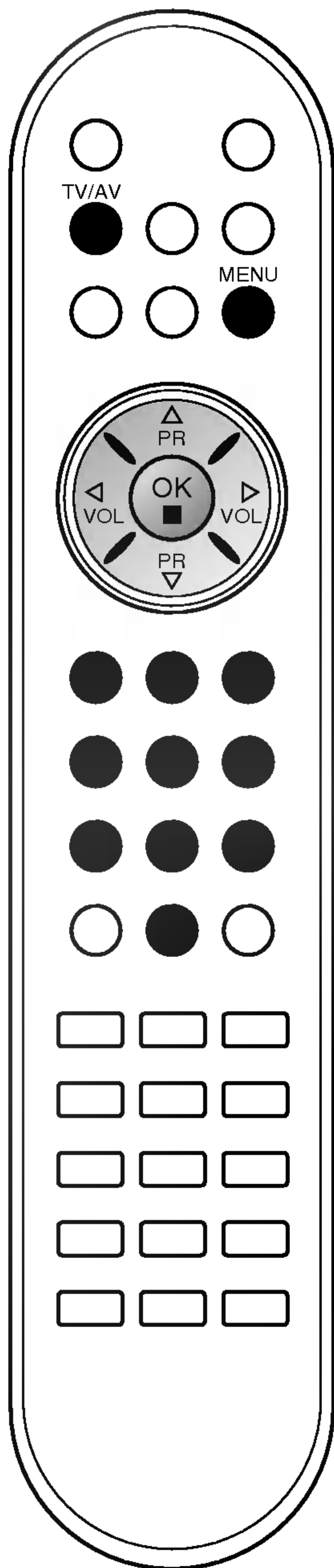

Up to 100 TV stations can be stored by programme numbers (0 to 99). Once you have preset the stations, you will be able to use the ▲ / ▼ or NUMBER buttons to scan the stations you have programmed. Stations can be tuned using automatic or manual modes.

## Auto programme tuning

All stations that can be received are stored by this method. It is recommended that you use auto programme during installation of this set.

1. Press the **MENU** button and then ▲ / ▼ button to select the Channel menu.
2. Press the ► button and then ▲ / ▼ button to select **Auto programme**.

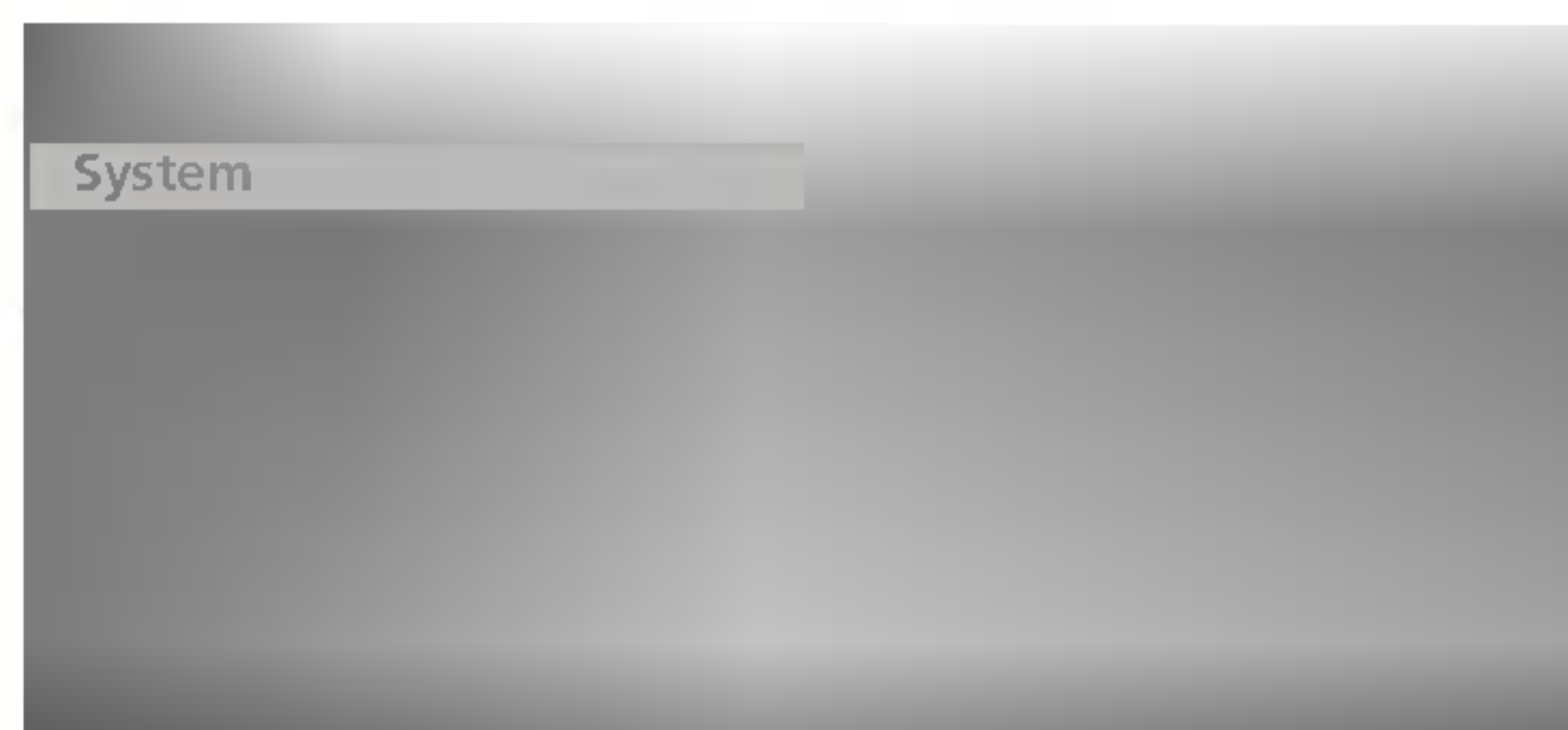

3. Press the ► button. Select a TV system with the ► button and then ▲ / ▼ button on the **System** menu;
  - BG** : PAL B/G, SECAM B/G (Europe/East Europe)
  - I** : PAL I/II (U.K./Ireland)
  - DK** : PAL D/K, SECAM D/K (East Europe)
  - L** : SECAM L/L' (France)
  - M** : (USA/Korea/Philippines)
4. Press the **OK** button.
5. Press the ▲ / ▼ button to select **Storage from**.
6. Select the beginning programme number with the ◀ / ▶ button or NUMBER buttons on the **Storage from** pull-down menu. Any number under 10 is entered with a numeric '0' in front of it, i.e. '05' for 5.
7. Press the ▲ / ▼ button to select **Search**.
8. Press the ► button to begin auto programming.



All receivable stations are stored.

**Option:** In Australia, if no station name can be assigned to a station, the channel number is assigned and stored as ----- followed by a number see 'Assigning a station name' section to assign the station name.

To stop auto programming, press the **MENU** button. When auto programming is completed, the **Programme edit** menu appears on the screen. See the 'Programme edit' section to edit the stored programme.

9. Press the **TV/AV** button to return to normal TV viewing.



# Setting up TV stations

## Manual programme tuning

Manual programme lets you manually tune and arrange the stations in whatever order you desire. Also you can assign a station name with five characters to each programme number.

1. Press the **MENU** button and then **▲ / ▼** button to select the Channel menu.
2. Press the **▶** button and then **▲ / ▼** button to select **Manual programme**.
3. Press the **▶** button and then **▲ / ▼** button to select **Storage**.



4. Select the desired programme number (0 to 99) with the **◀ / ▶** button or **NUMBER** buttons on the **Storage** menu. Any number under 10 is entered with a numeric '0' in front of it, i.e. '05' for 5.
5. Press the **▲ / ▼** button to select **System**.
6. Select a TV system with the **▶** button and then **◀ / ▶** button on the **System** menu;
  - BG** : PAL B/G, SECAM B/G (Europe/East Europe)
  - I** : PAL I/II (U.K./Ireland)
  - DK** : PAL D/K, SECAM D/K (East Europe)
  - L** : SECAM L/L' (France)
  - M** : (USA/Korea/Philippines)
7. Press the **OK** button.
8. Press the **▲ / ▼** button to select **Channel**.
9. Press the **▶** button and then **▲ / ▼** button to select **VHF/UHF** or **Cable** on the **Channel** menu.
 

If possible, select the channel number directly with the number buttons. Any number under 10 is entered with a numeric '0' in front of it, i.e. '05' for 5.
10. Press the **OK** button.
11. Press the **▲ / ▼** button to select **Search**.
12. Press the **▶** button and then **◀ / ▶** button to commence searching on the **Search** pull-down menu. If a station is found the search will stop.



13. Press the **OK** button to store it.
14. To store another station, repeat steps 3 to 13.
15. Press the **TV/AV** button to return to normal TV viewing.

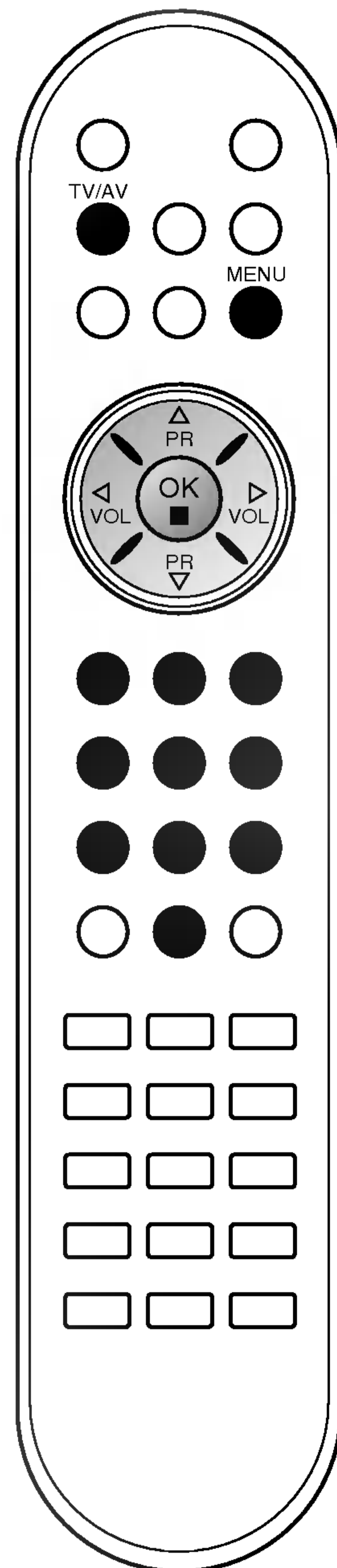

---

# Setting up TV stations

---



## Assigning a station name

1. Repeat the 'Manual programme tuning' steps 1 to 2.
2. Press the ► button and then ▲ / ▼ button to select **Name**.
3. Press the ► button and then use the ▲ / ▼. You can use a blank, +, -, the number **0** to **9** and the alphabet **A** to **Z**.  
With the ◀ button you can select in the opposite direction.
4. Select the position by pressing the ◀ / ► button and then make your choice of the second character, and so on.
5. Press the **OK** button to store it.
6. Press the **TV/AV** button to return to normal TV viewing.

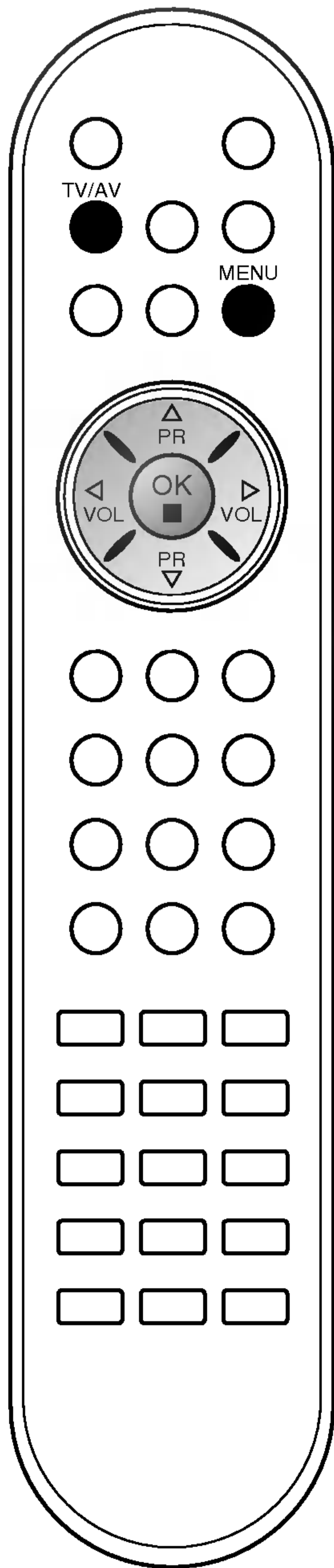



# Setting up TV stations

## Programme edit

This function enables you to delete or skip the stored programmes. Also you can move some stations to other programme numbers or insert a blank station data into the selected programme number.

1. Press the **MENU** button and then **▲ / ▼** button to select the Channel menu.
2. Press the **▶** button and then **▲ / ▼** button to select **Programme edit**.
3. Press the **▶** button to display the **Programme edit** Menu.

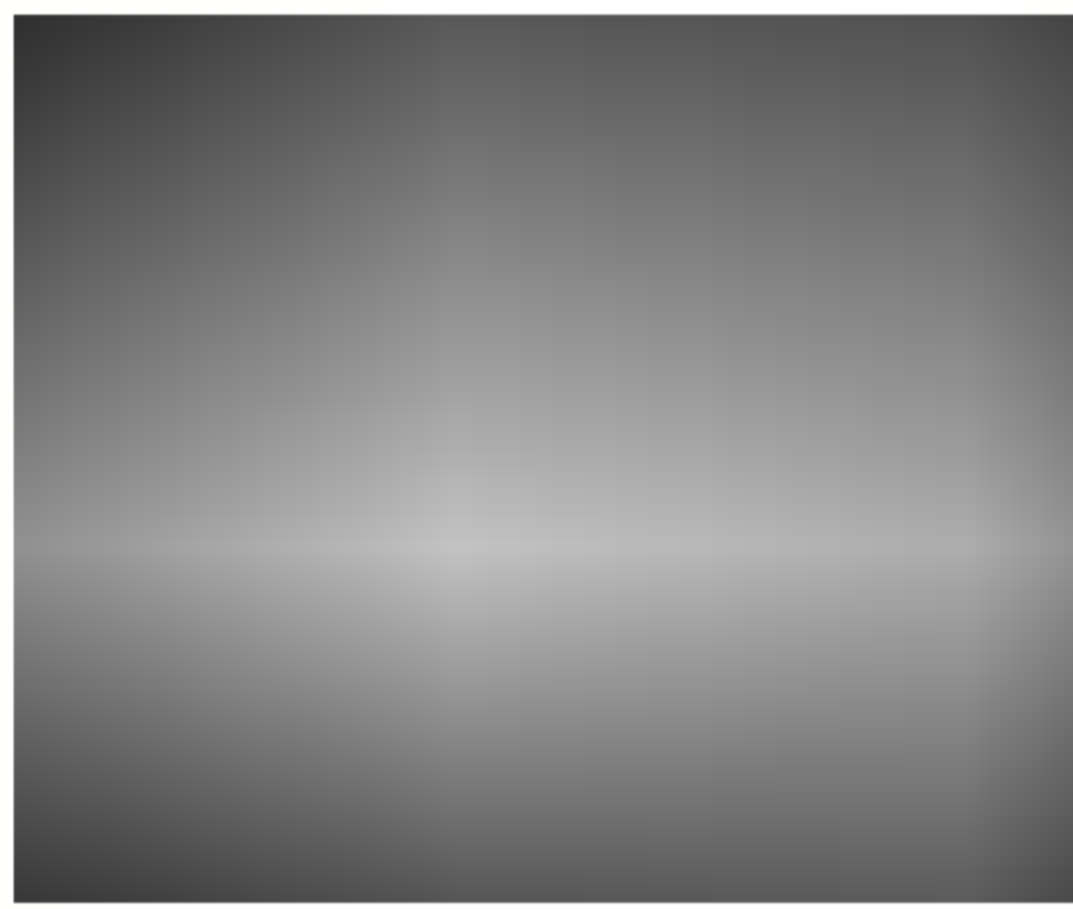

## Deleting a programme

1. Select a programme to be deleted with the **▲ / ▼** or **◀ / ▶** button.
2. Press the **RED** button twice.  
The selected programme is deleted, all the following programmes are shifted up one position.

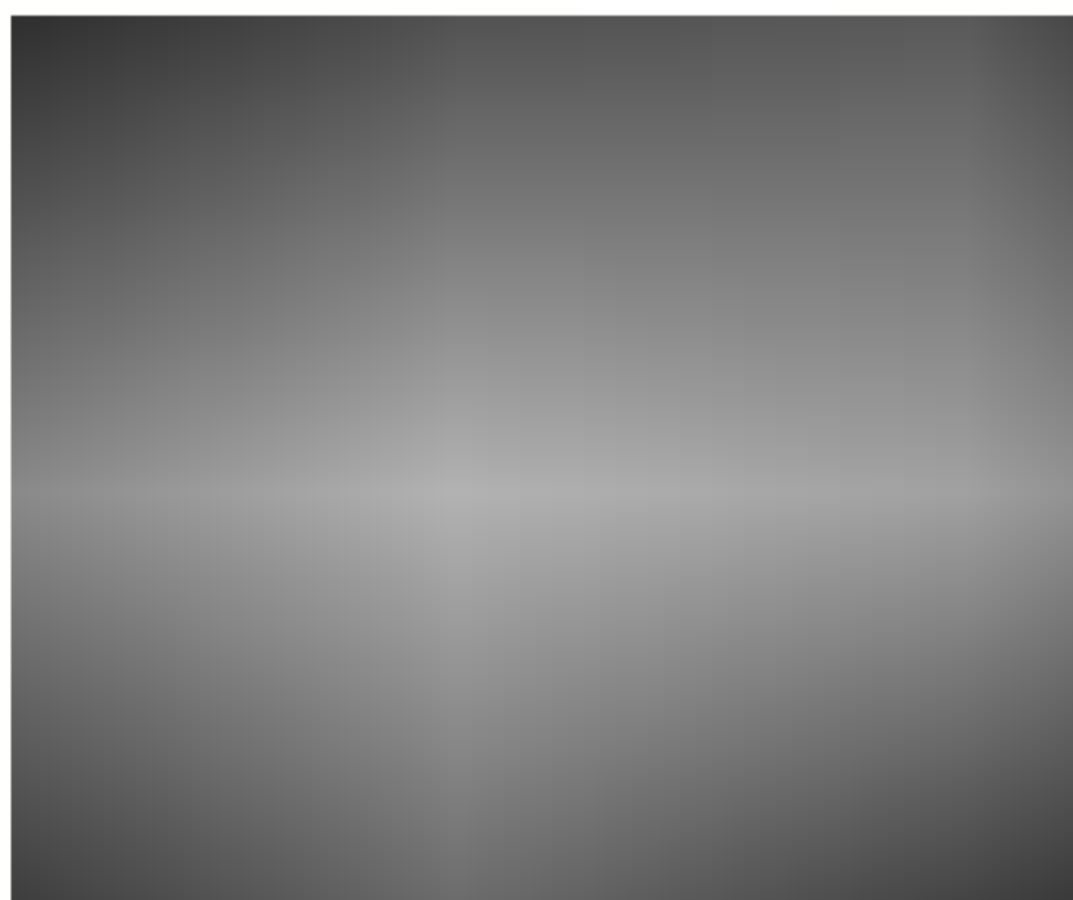

## Copying a programme

1. Select a programme to be copied with the **▲ / ▼** or **◀ / ▶** button.
2. Press the **GREEN** button.  
All the following programmes are shifted down one position.

## Moving a programme

1. Select a programme to be moved with the **▲ / ▼** or **◀ / ▶** button.
2. Press the **YELLOW** button.
3. Move the programme to the desired programme number with the **▲ / ▼** or **◀ / ▶** button.
4. Press the **YELLOW** button again to release this function.

## Skipping a programme number

1. Select a programme number to be skipped with the **▲ / ▼** or **◀ / ▶** button.
2. Press the **BLUE** button. The skipped programme turns to blue.
3. Press the **BLUE** button again to release the skipped programme.  
When a programme number is skipped it means that you will be unable to select it using the **▲ / ▼** button during normal TV viewing. If you want to select the skipped programme, directly enter the programme number with the **NUMBER** buttons or select it in the programme edit or table menu.

Press the **TV/AV** button to return to normal TV viewing.

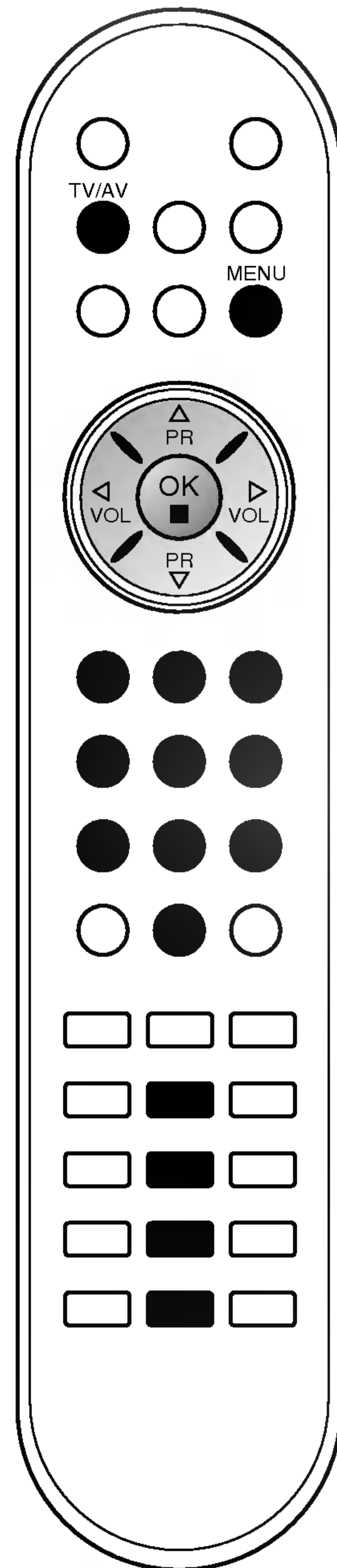



# Setting up TV stations

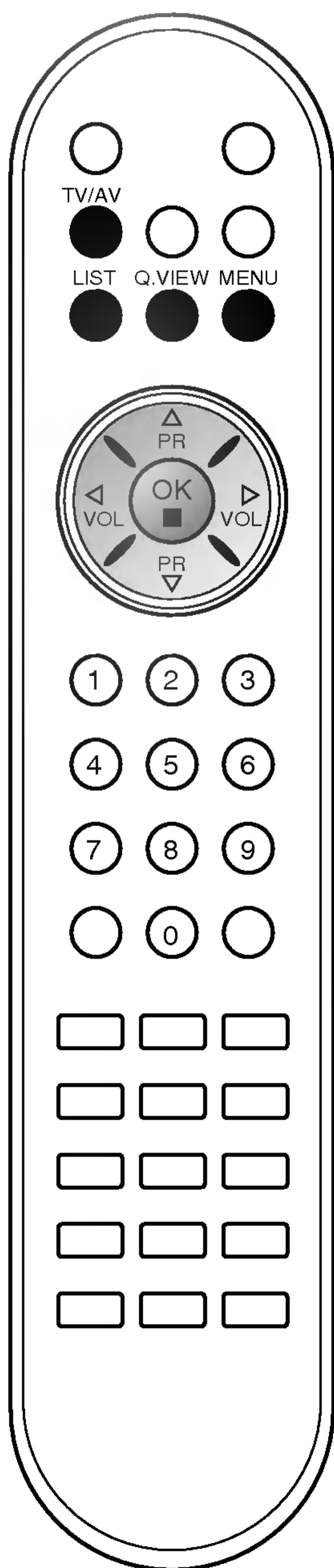

## Favourite programme

This function lets you select your favourite programmes directly.

1. Press the **MENU** button and then **▲ / ▼** button to select the Channel menu.
2. Press the **▶** button and then **▲ / ▼** to select **Favourite programme**.

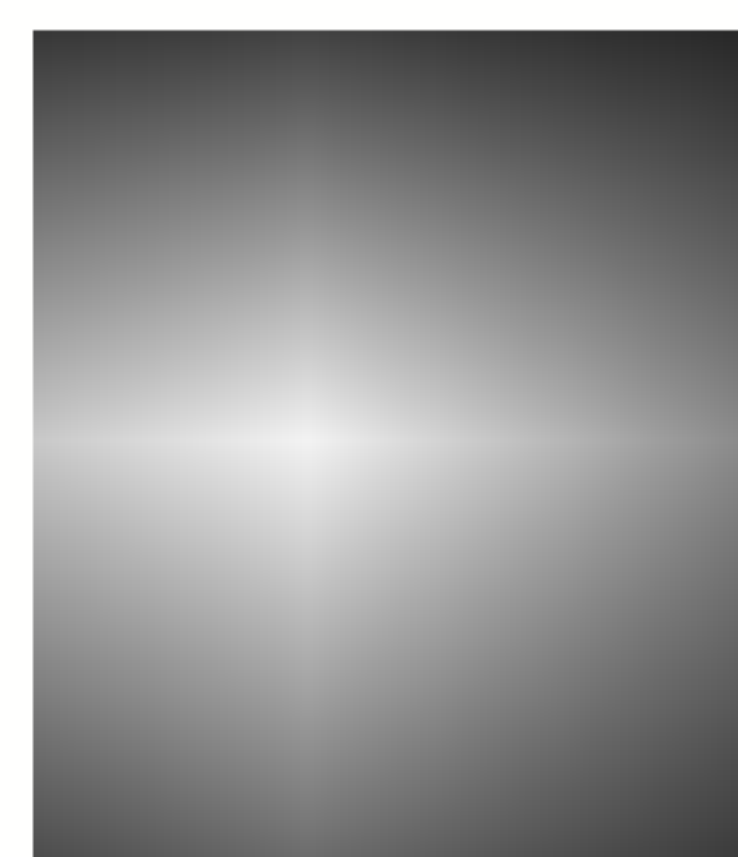

3. Press the **▶** button and then **◀ / ▶** button to select **On** or **Off**.
4. Press the **▲ / ▼** button to select -- -----.
5. Select a desired programme with the **◀ / ▶** button.
6. To store another programme, repeat steps 4 to 5.  
You can store up to 8 programmes.
7. Press the **TV/AV** button to return to normal TV viewing.

Repeatedly press the **Q.VIEW** button to select stored favourite programmes.

## Calling the programme table

You can check the programmes stored in the memory by displaying the programme table.

### Displaying programme table

Press the **LIST** button to display the **Programme table** menu.

The programme table appears on the screen. One programme table contains ten programmes as below.

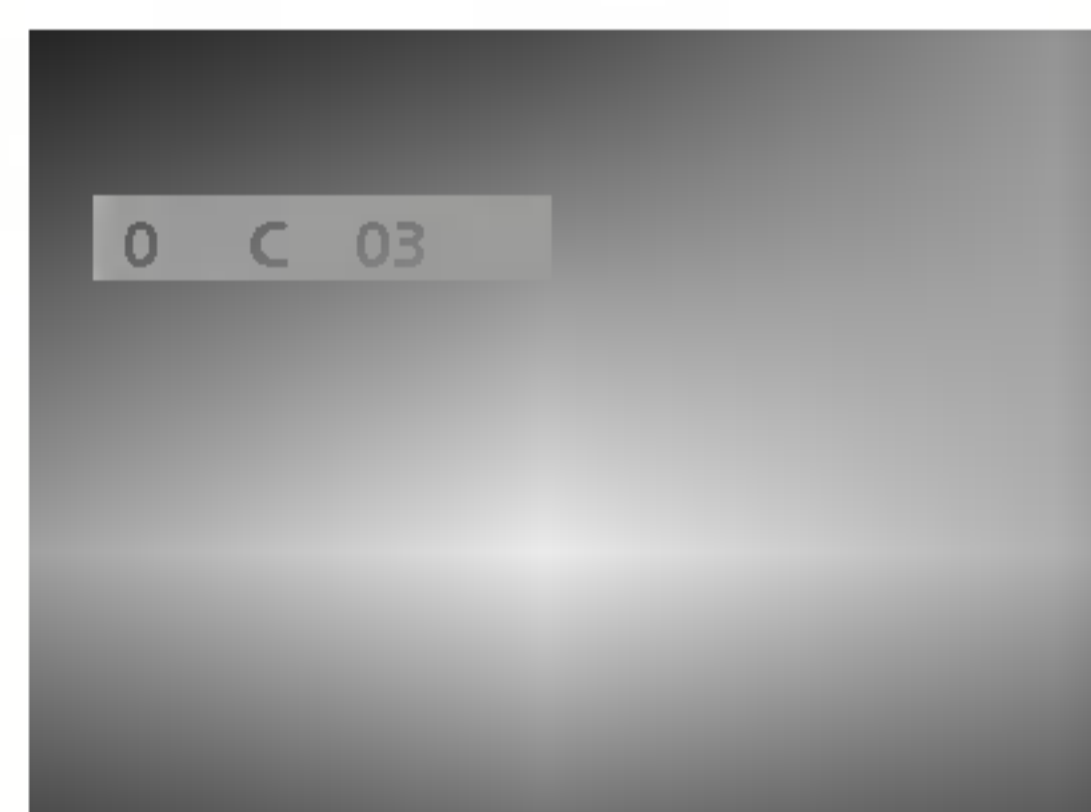

### Note :

- a. You may find some blue programmes. They have been set up to be skipped by auto programming or in the programme edit mode.
- b. Some programmes with the channel number shown in the programme table indicate there is no station name assigned.

### Selecting a programme in the programme table

Select a programme with the **▲ / ▼** or **◀ / ▶** button.

Then press the **OK** button.

The set switches to the chosen programme number.

### Paging through a programme table

There are 10 programme table pages in which contain 100 programmes.

Pressing the **▲ / ▼** or **◀ / ▶** button repeatedly turns the pages.

Press the **TV/AV** button to return to normal TV viewing.

# Picture adjustment

## PSM (Picture Status Memory)

1. Press the **MENU** button and then **▲ / ▼** button to select the Picture menu.
2. Press the **▶** button and then **▲ / ▼** button to select **PSM**.
3. Press the **▶** button and then **▲ / ▼** button to select a picture setting on the **PSM** menu.
4. Press the **OK** button.



5. Press the **TV/AV** button to return to normal TV viewing.

You can also recall a desired picture (**Dynamic, Standard, Mild, Game** or **User**) with **PSM** button on the remote control. The picture **Dynamic, Standard, Mild** and **Game** are programmed for optimum picture reproduction at the factory and cannot be changed.

## Picture adjustment

You can adjust picture contrast, brightness, colour intensity, sharpness and tint (NTSC input only) to the levels you prefer.

1. Press the **MENU** button and then **▲ / ▼** button to select the Picture menu.



2. Press the **▲ / ▼** button to select the desired picture item.
3. Press the **◀ / ▶** button to make appropriate adjustments, then it will be stored for the picture **User**.
4. Press the **TV/AV** button to return to normal TV viewing.

**Note :** Only **Contrast** and **Brightness** are displayed in **PC** mode.

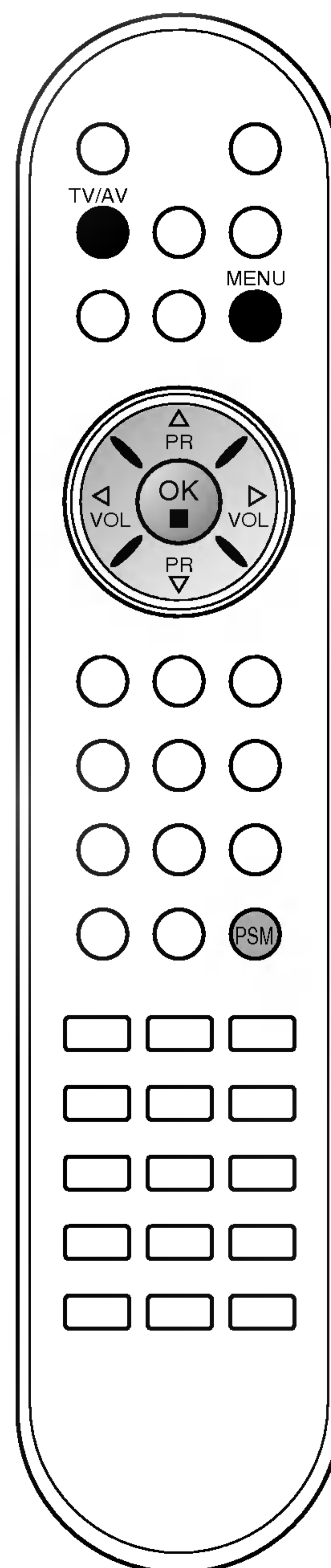



---

# Picture adjustment

---

## Picture format (option)

You can watch TV in various picture formats; 16:9, 14:9, Zoom, Auto, 4:3.

Repeatedly press the **ARC** button to select your desired picture format.

### 16:9

You can enjoy the cinema (the picture format of 16:9) or general TV programme through the 16:9 mode.

The screen 16:9 is viewed just like that but the screen 4:3 is magnified to the left and right so that the screen 16:9 is full.

### 14:9

You can enjoy the picture format of 14:9 or general TV programme through the 14:9 mode.

The screen 14:9 is viewed just like that the screen 4:3 is magnified to the upper / lower and left / right.

### Zoom

You can enjoy the cinema in a vast screen through the Zoom mode. The screen 4:3 is magnified to the upper / lower and left / right sides so that the screen 16:9 is full. The bottom and top of the picture may be lost.

### Auto

When your set receives the wide screen signal, it will be automatically changed to the picture format to be sent. (Not available in all countries)

### 4:3

This picture format is 4 to 3 of general TV.

**Note :** In **PC** mode only **16:9** and **4:3** aspect ratios are available.

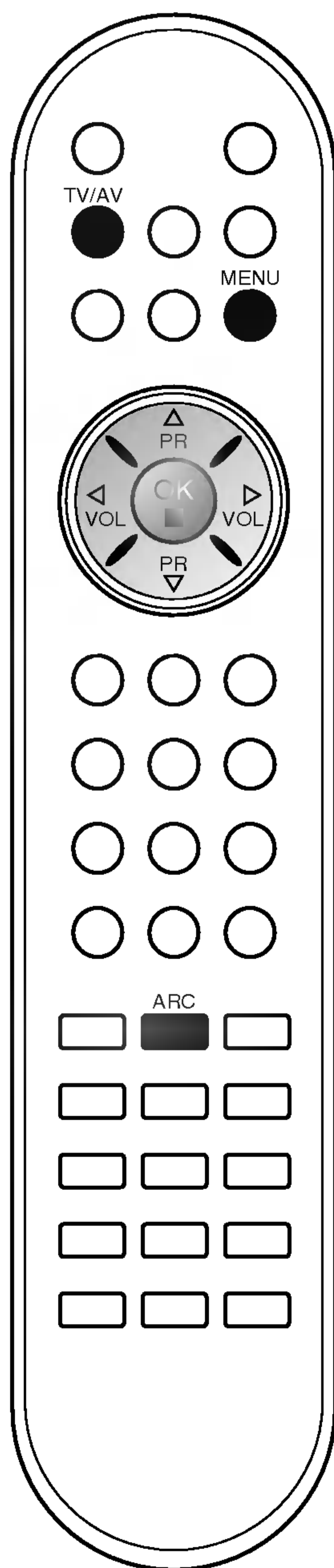



# Sound adjustment

## SSM (Sound Status Memory)

You can select your preferred sound setting; Flat, Music, Movie or Speech and you can also adjust the sound frequency of the equalizer.

1. Press the **MENU** button and then **▲ / ▼** button to select the Sound menu.



2. Press the **▶** button and then **▲ / ▼** button to select **SSM**.
3. Press the **▶** button and then **▲ / ▼** button to select a sound setting on the **SSM** menu.

### Sound Frequency Adjustment

- a. Press the **OK** button in **User**.
- b. Select a sound band by pressing the **◀ / ▶** button.
- c. Make appropriate sound level with the **▲ / ▼** button.
- d. Press the **OK** button to store it for the sound **User**.

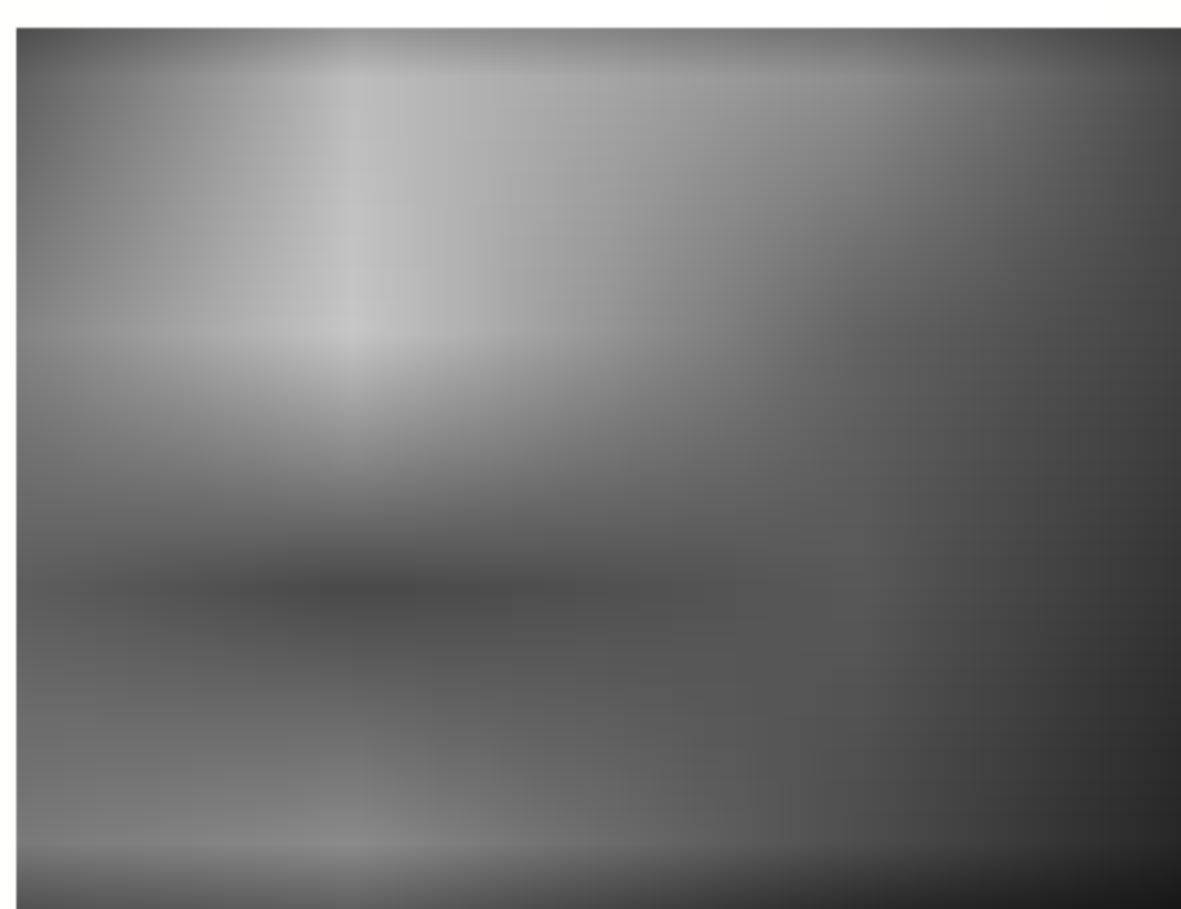

Press the **TV/AV** button to return to normal TV viewing.

You can also recall a desired sound setting (**Flat**, **Music**, **Movie**, **Speech** or **User**) with **SSM** button on the remote control. The sound settings **Flat**, **Music**, **Movie** and **Speech** are programmed for optimum sound reproduction at the factory and cannot be changed.

**Note :** If you press the **SSM** button after making appropriate adjustment on the **User** sub menu, the display **User** automatically appears even though you have already set a factory preset setting; **Flat**, **Music**, **Movie** or **Speech**.



## Sound adjustment

You can adjust balance, AVL (Auto Volume Leveler). AVL automatically keeps on an equal volume level even if you change programmes.

1. Press the **MENU** button and then **▲ / ▼** button to select the Sound menu.
2. Press the **▶** button and then **▲ / ▼** button to select the desired sound item; **AVL** or **Balance**.
3. Make desired adjustment with the **◀ / ▶**, **▲ / ▼** and then press the **OK** button.
4. Press the **TV/AV** button to return to normal TV viewing.

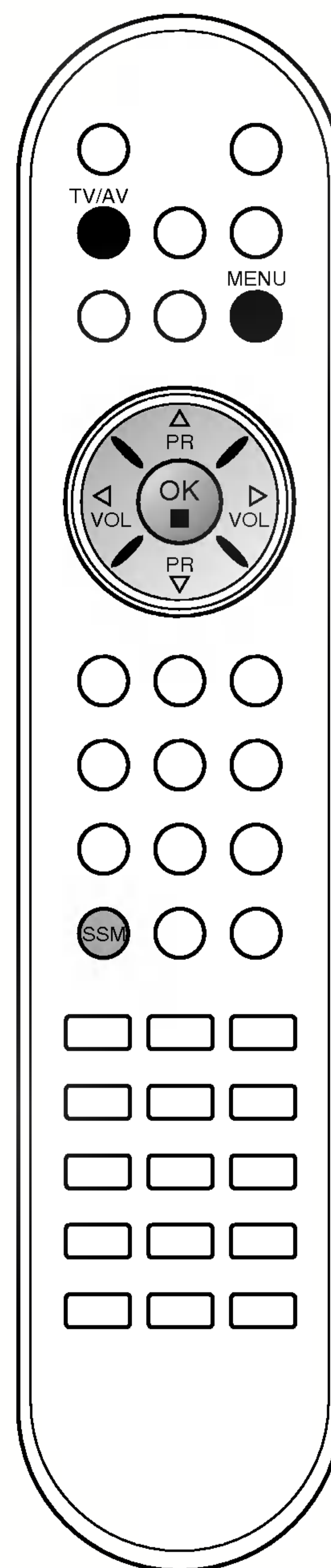
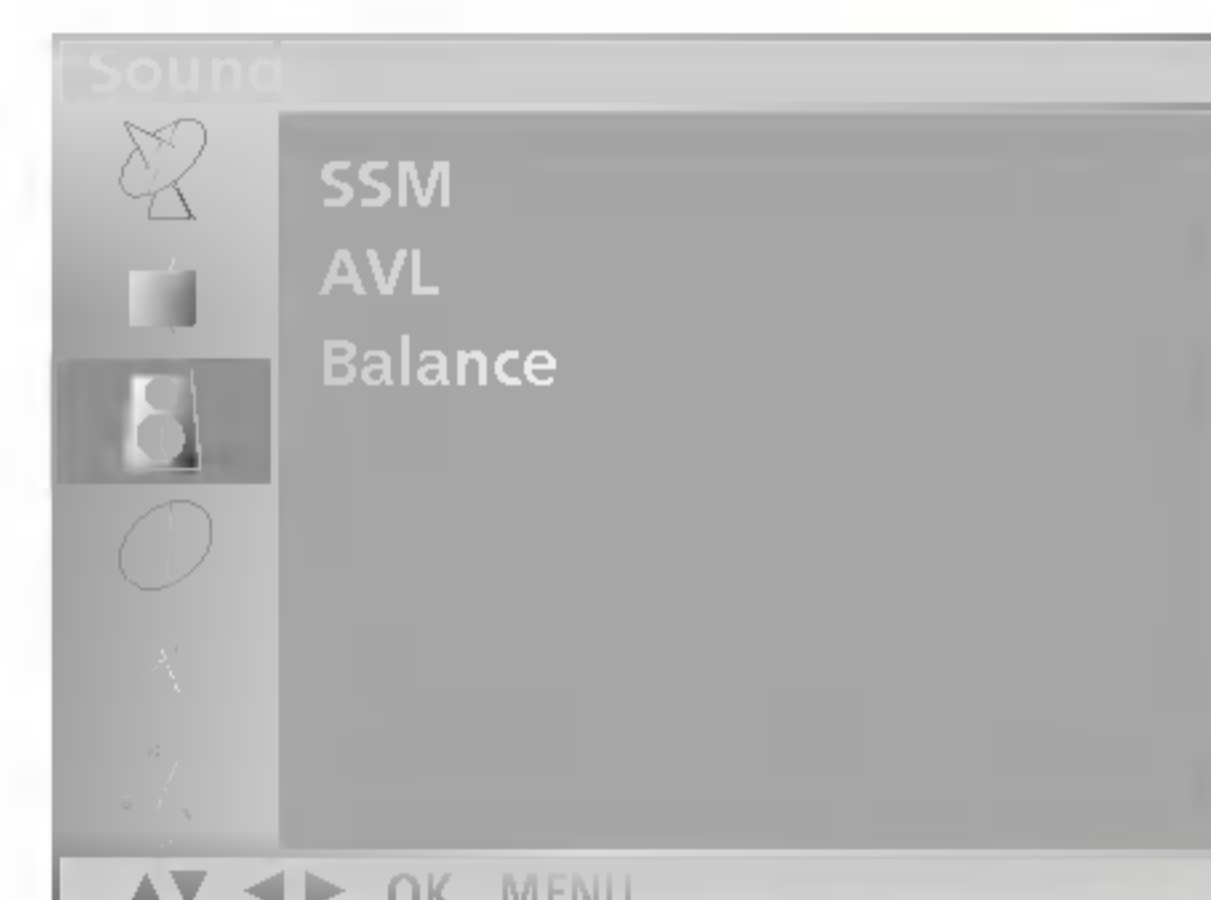

---

# Sound adjustment

---

## Stereo/Dual reception

When a programme is selected, the sound information for the station appears after the programme number and station name disappear.

Broadcast	On Screen Display
Mono	<b>MONO</b>
Stereo	<b>STEREO</b>
Dual	<b>DUAL I</b>

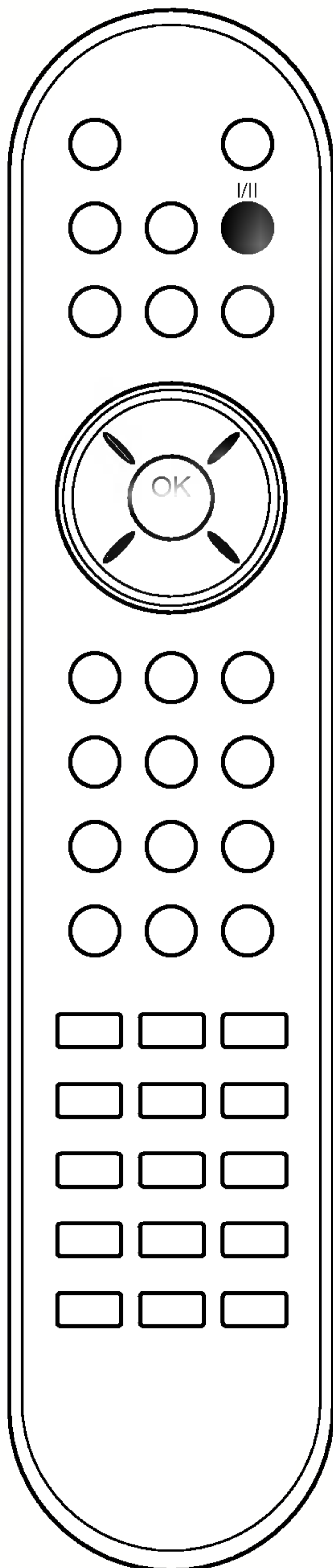

### Mono sound selection

In stereo reception if the stereo signal is weak, you can switch to mono by pressing the **I/II** button twice. In mono reception the depth of sound is improved. To switch back to stereo, press the **I/II** button twice again.

### Language selection for dual language broadcast

If a programme is received in two languages (dual language), you can switch to **DUAL I**, **DUAL II** or **DUAL I+II** by pressing the **I/II** button repeatedly.

**DUAL I** sends the primary broadcast language to the loudspeakers.

**DUAL II** sends the secondary broadcast language to the loudspeakers.

**DUAL I+II** sends a separate language to each loudspeaker.

### NICAM reception (option)

If your set is equipped with the receiver for NICAM reception, the high quality NICAM (Near Instantaneous Companding Audio Multiplex) digital sound can be received.

Sound output can be selected according to the type of received broadcast as follows by pressing the **I/II** button repeatedly.

1. When NICAM mono is received, you can select **NICAM MONO** or **FM MONO**.
2. When NICAM stereo is received, you can select **NICAM STEREO** or **FM MONO**. If the stereo signal is weak, switch to **FM mono**.
3. When NICAM dual is received, you can select **NICAM DUAL I**, **NICAM DUAL II** or **NICAM DUAL I+II** or **MONO**. When **FM mono** is selected the display **MONO** appears on the screen.

### Sound output selection

In AV mode, you can select output sound for the left and right loudspeakers.

Repeatedly press the **I/II** button to select the sound output.

**L+R** : Audio signal from audio L input is sent to left loud-speaker and audio signal from audio R input is sent to right loud-speaker.

**L+L** : Audio signal from audio L input is sent to left and right loudspeakers.



# TIME Menu

## Clock

You must set the time correctly before using on/off time function.

1. Press the **MENU** button and then ▲ / ▼ button to select the TIME menu.
2. Press the ► button and then ▲ / ▼ button to select TIME.



3. Press the ► button and then ▲ / ▼ button to adjust the hour.
4. Press the ► button and then ▲ / ▼ button to adjust the minute.
5. Press the **MENU** button to save.

## On/Off Time

The off timer automatically switches the set to standby at the pre-set time.

1. Press the **MENU** button and then ▲ / ▼ button to select the TIME menu.
2. Press the ► button and then ▲ / ▼ button to select **Off Time** or **On Time**.
3. Press the ► button and then ▲ / ▼ button to select **On**.  
To cancel **Off/On Time** function, press the ▲ / ▼ button to select **Off**.



4. Press the ► button and then ▲ / ▼ button to adjust the hour.
5. Press the ► button and then ▲ / ▼ button to adjust the minute.
6. **Only On Time function;** Press the ► button and then ▲ / ▼ button to adjust volume level and programe number.
7. Press the **MENU** button to save.

### Note :

- a. In the event of power interruption (disconnection or power failure), the clock must be reset.
- b. Two hours after the set is switched on by the on time function it will automatically switch back to standby mode unless a button has been pressed.
- c. Once the on or off time is set, these functions operate daily at the preset time.
- d. Off Timer function overrides On Timer function if they are set to the same time.
- e. The set must be in standby mode for the On Timer to work.

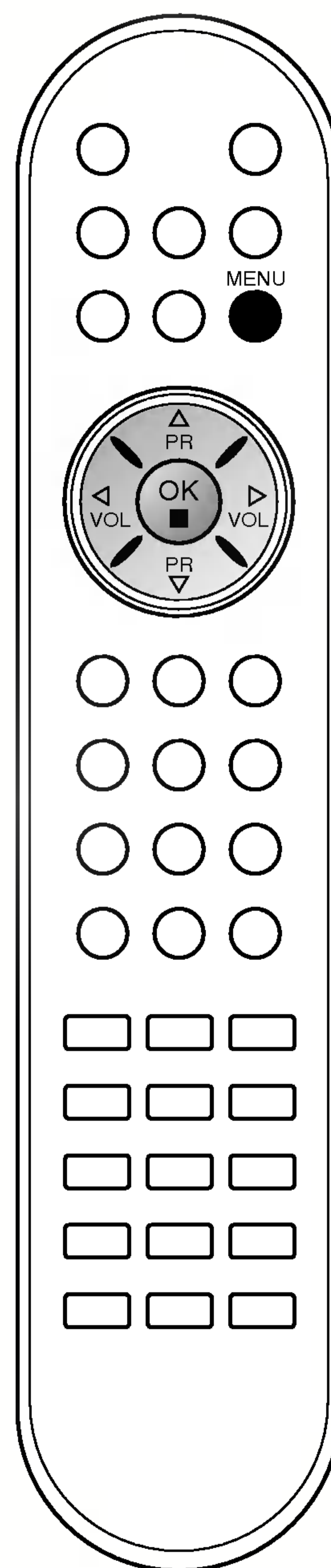

---

# TIME Menu

---

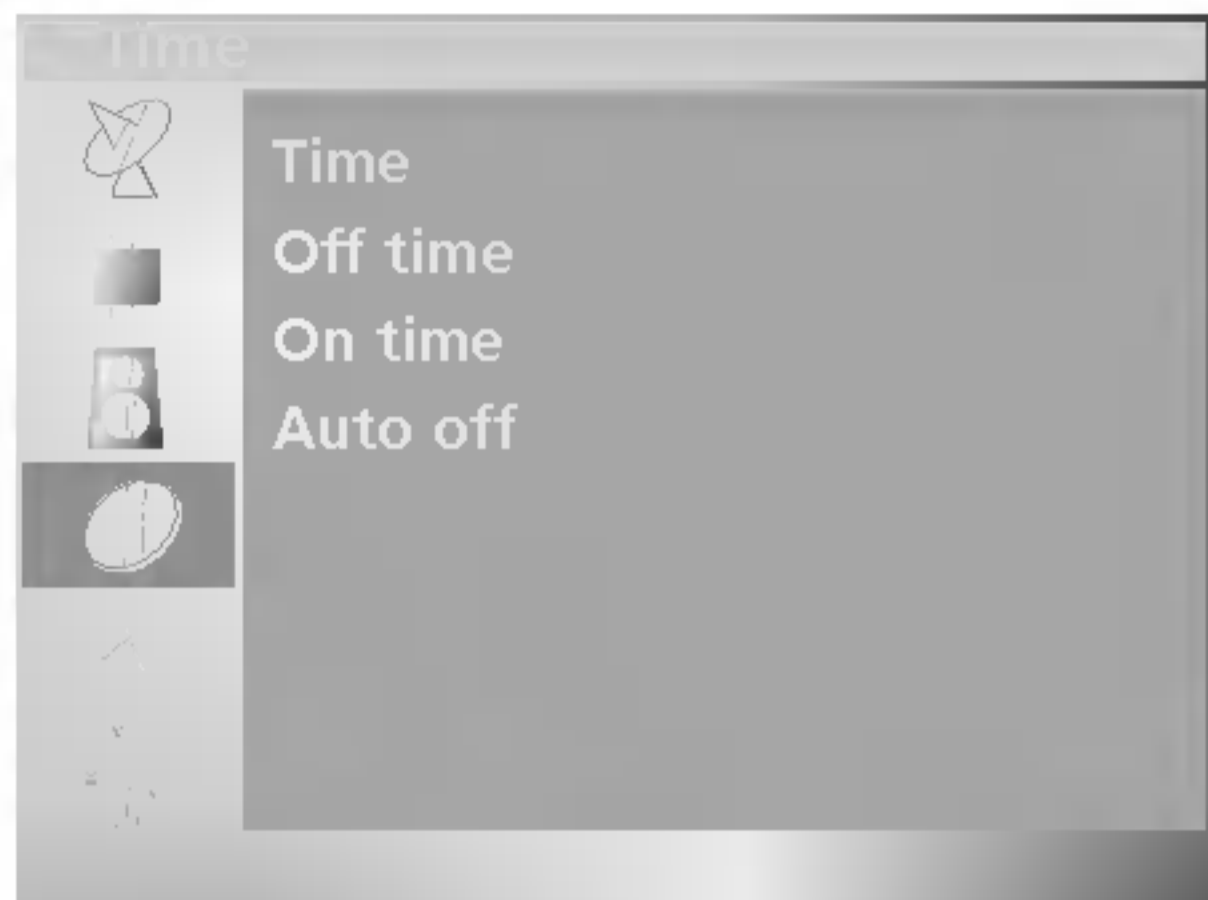

## Auto off

If you select **On** on the **Auto Off** menu, the set will automatically switch itself to standby mode approximately ten minutes after a TV station stops broadcasting.

1. Press the **MENU** button and then **▲ / ▼** button to select the **TIME** menu.
2. Press the **▶** button and then **▲ / ▼** button to select **Auto Off**.
3. Press the **▶** button and then **▲ / ▼** button to select **On** or **Off**.

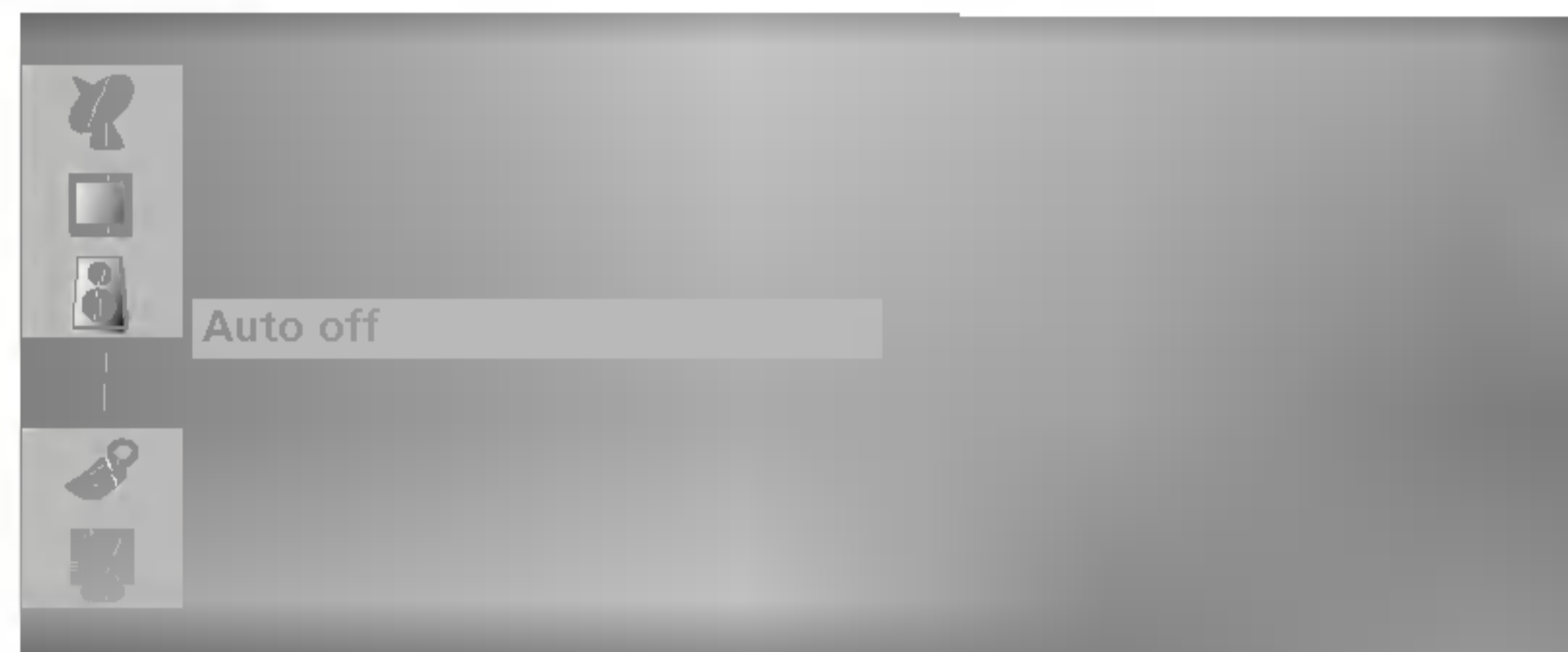

4. Press the **MENU** button to save.

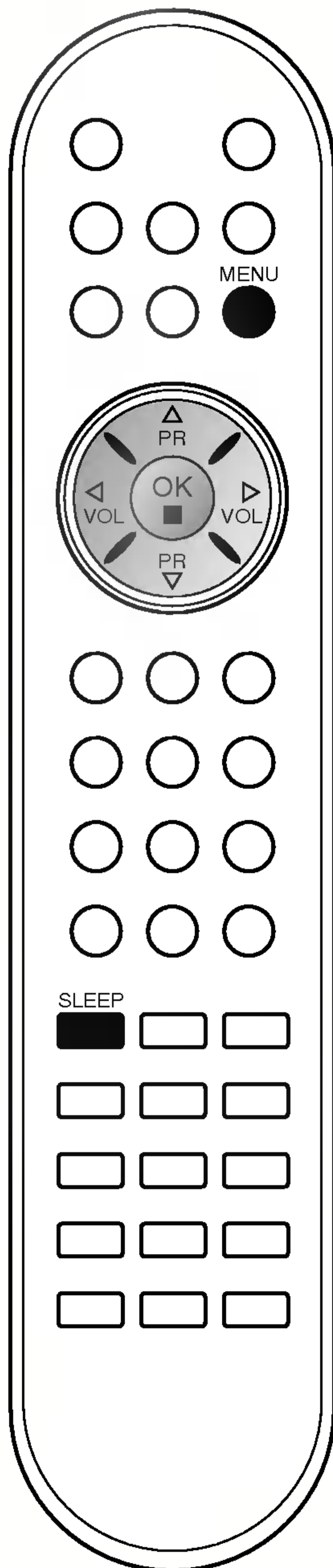

## Sleep timer

You don't have to remember to switch the set off before you go to sleep. The sleep timer automatically switches the set to standby after the preset time has elapsed.

Press the **SLEEP** button to select the number of minutes. The display '**zz Off**' will appear on the screen, followed by **10, 20, 30, 60, 90, 120, 180** and **240**. The timer begins to count down from the number of minutes selected.

### Note :

- a. To view the remaining sleep time, press the **SLEEP** button once.
- b. To cancel the sleep time, repeatedly press the **SLEEP** button until the display '**zz Off**' appears.
- c. When you switch the set off, the set releases the preset sleep time.



## Other functions

### TV, AV and PC (option) modes

Inputs can be set for TV, AV or PC mode. AV mode is used when a video cassette recorder (VCR), or other equipment is connected to the set.

**Note :** When a VCR is connected via the aerial socket the set is used in TV mode. See the 'Connection of external equipment' section.

1. Press the **MENU** button and then **▲ / ▼** button to select the Setup menu.
2. Press the **▶** button and then **▲ / ▼** button to select **Input**.
3. Press the **▶** button and then **▲ / ▼** button to select **TV, AV1, AV2** (option), **S-Video**, **Component** (or **Component 1, Component 2**) or **PC** (option).

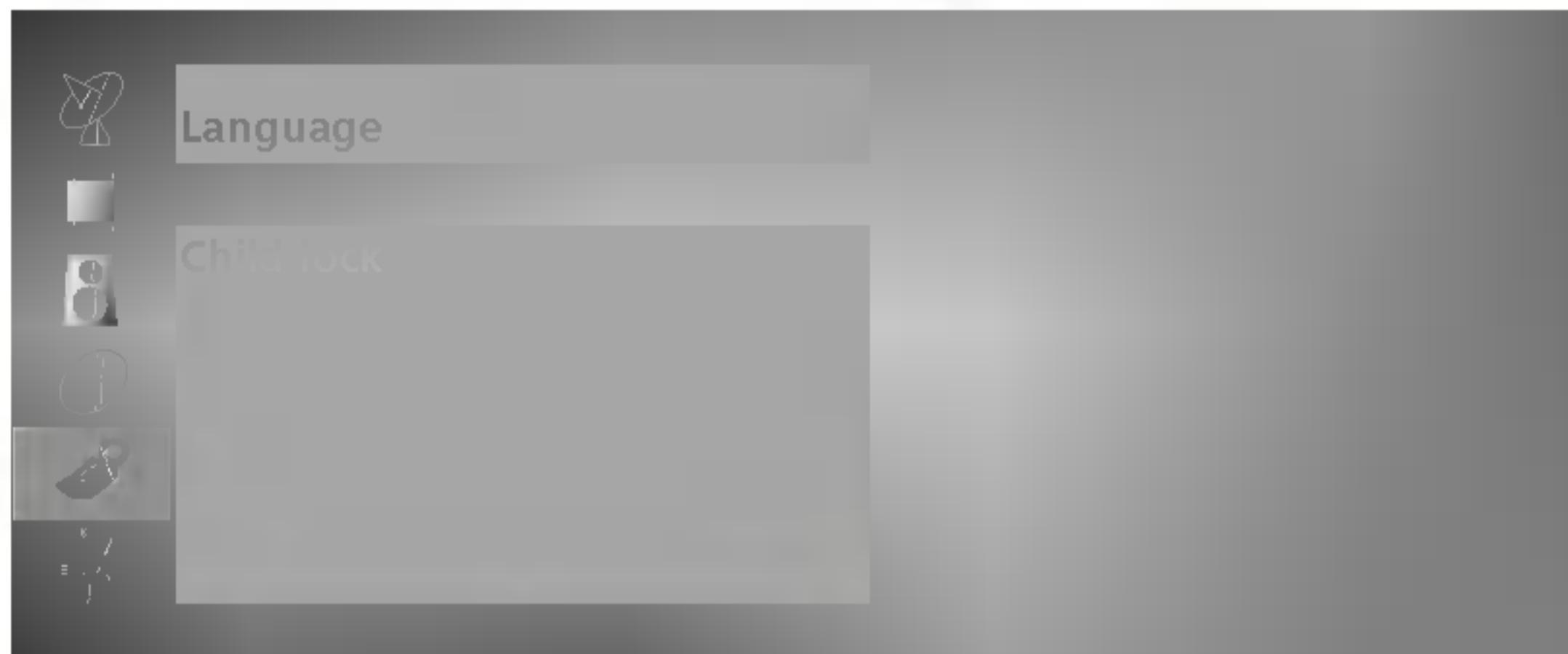

The AV and PC modes are :

AV 1 : VCR connected to the **AV1** socket of the set.

AV 2 : VCR connected to the **AV2** socket of the set.(option)

S-Video : VCR connected to the **S-Video** of the set.

Component (or Component 1) : DVD/DTV connected to the **DVD/DTV IN** sockets of the set.

Component 2 : DVD connected to the **DVD IN** sockets on the back of set. (option)

PC : PERSONAL COMPUTER connected to the PC socket of the set. (option)

4. Press the **TV/AV** button to return to normal TV viewing.

Alternatively you can select the TV or AV mode by pressing the **TV/AV** button.

In AV mode, to return to TV mode, press the **▲ / ▼** or **NUMBER** buttons.

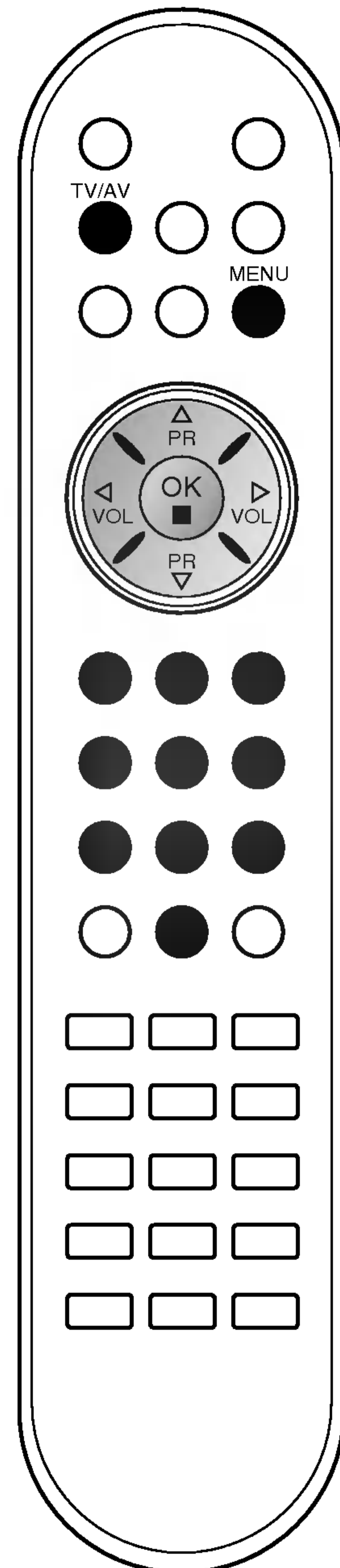
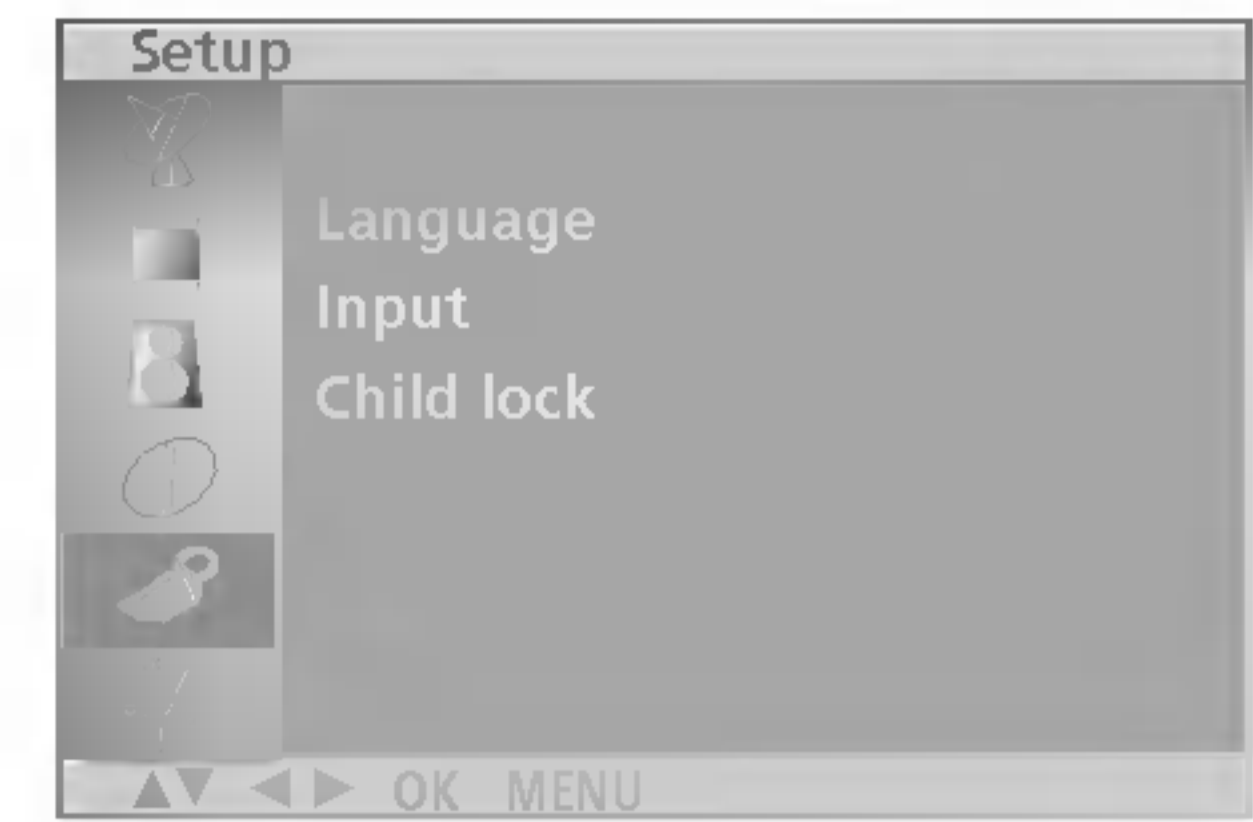

---

## Other functions

---

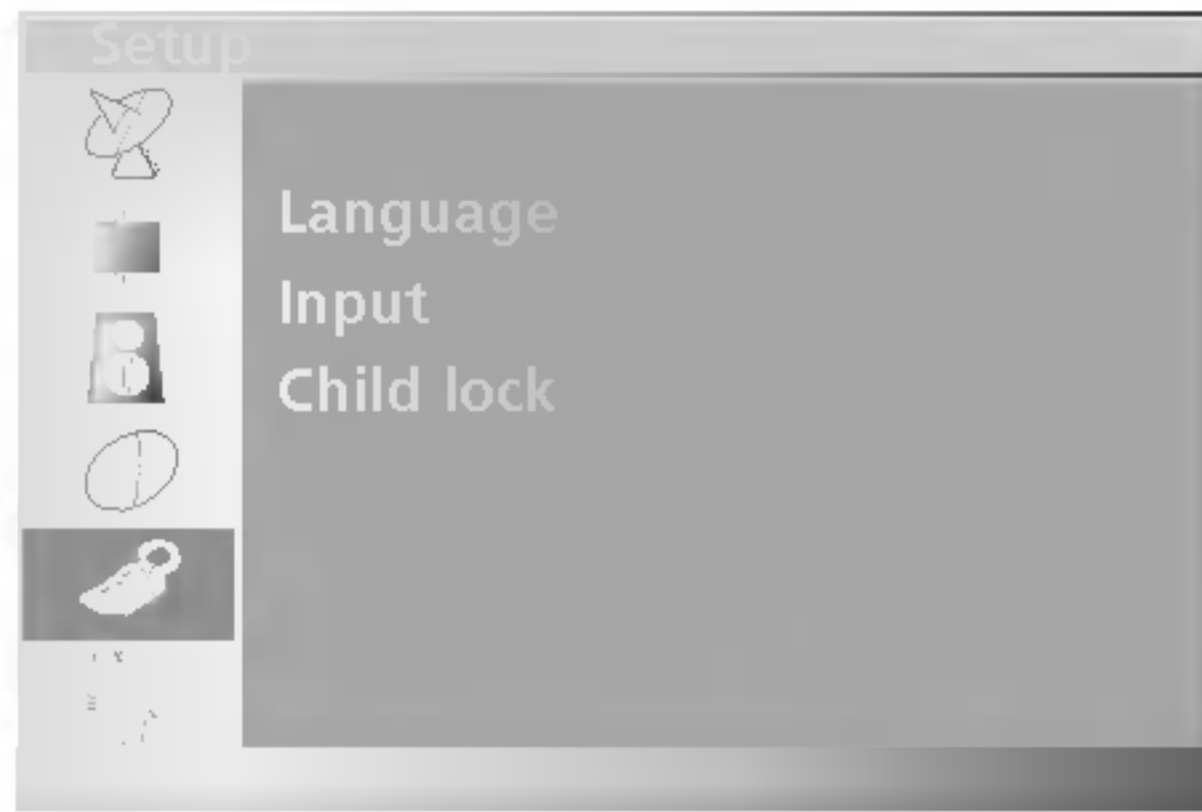

### Child lock

The TV can be set so that the remote control handset is needed to control it. This feature can be used to prevent unauthorized viewing.

1. Press the **MENU** button and then ▲ / ▼ button to select the Setup menu.
2. Press the ► button and then ▲ / ▼ button to select **Child lock**.
3. Press the ► button and then ▲ / ▼ button to select **On** or **Off** on the **Child lock** menu.

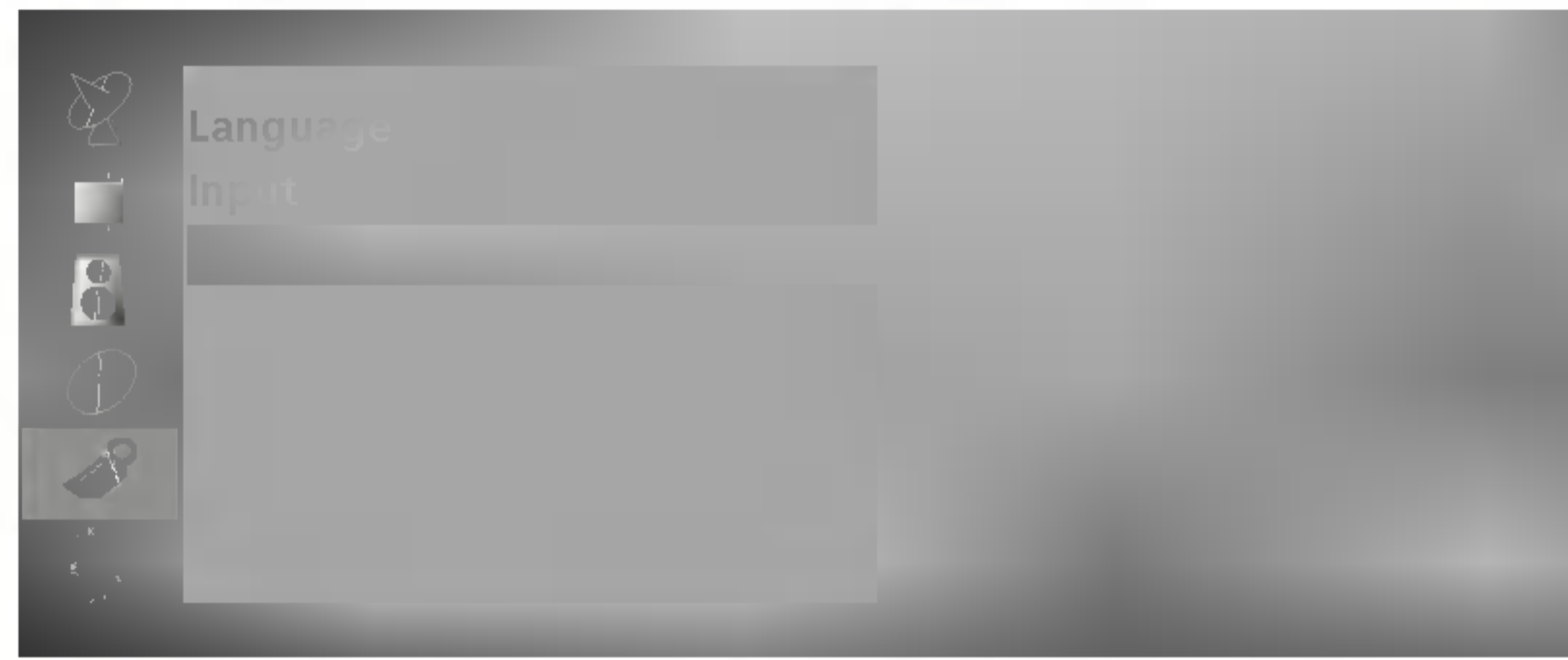

4. Press the **TV/AV** button to return to normal TV viewing.

With the lock on, the display **Child lock** appears on the screen if any button on the side panel is pressed while viewing the TV.

**Note :** The display **Child lock** will not appear on the screen if any button on the side panel is pressed while displaying the menus.

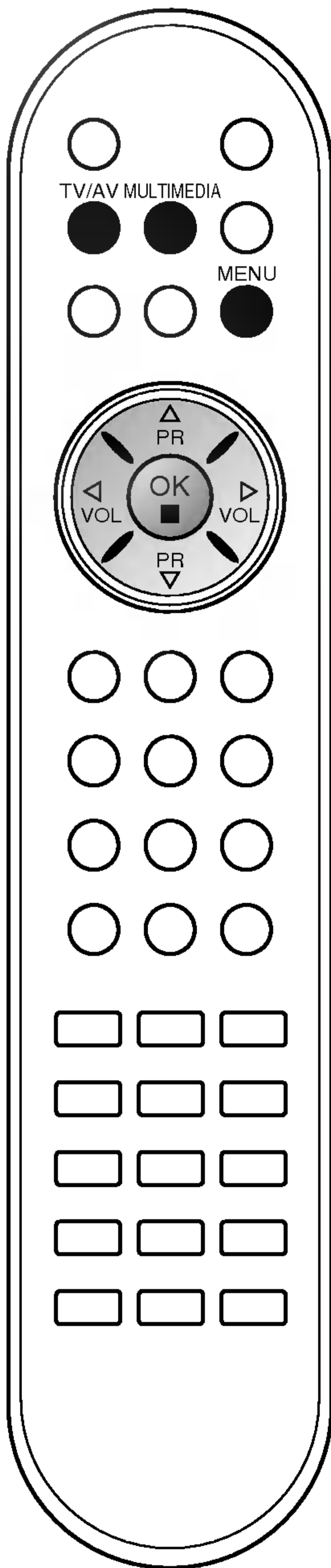



---

## Teletext (option)

---

Teletext (or TOP text) is an optional function, therefore only a set with the teletext system can receive the teletext broadcast.

Teletext is a free service broadcast by most TV stations which gives up-to-the-minute information on news, weather, television programmes, share prices and many other topics.

The teletext decoder of this TV can support the SIMPLE, TOP and FASTEXT systems. SIMPLE (standard teletext) consists of a number of pages which are selected by directly entering the corresponding page number. TOP and FASTEXT are more modern methods allowing quick and easy selection of teletext information.

### Switch on/off

Press the **TEXT** button to switch to teletext. The initial page or last page appears on the screen.

Two page numbers, TV station name, date and time are displayed on the screen headline. The first page number indicates your selection, while the second shows the current page displayed.

Press the **TEXT** button to switch off teletext. The previous mode reappears.

### SIMPLE text

#### Page selection

1. Enter the desired page number as a three digit number with the **NUMBER** buttons. If during selection you press a wrong number, you must complete the three digit number and then re-enter the correct page number.
2. The **▲ / ▼** button can be used to select the preceding or following page.

#### Programming a colour button in LIST mode

If the TV is in SIMPLE text, TOP text or FASTEXT mode, press the **EM** button to switch to LIST mode.

Four teletext page numbers of your choice can be colour coded and easily selected by pressing the corresponding coloured button on the remote control handset.

1. Press a coloured button.
2. Using the **NUMBER** buttons, select the page you wish to programme.
3. Press the **OK** button. Then the selected page is stored as the selected page number by blinking once. From now on, you can select this page with the same coloured button.
4. The three other coloured buttons are programmed in this way.

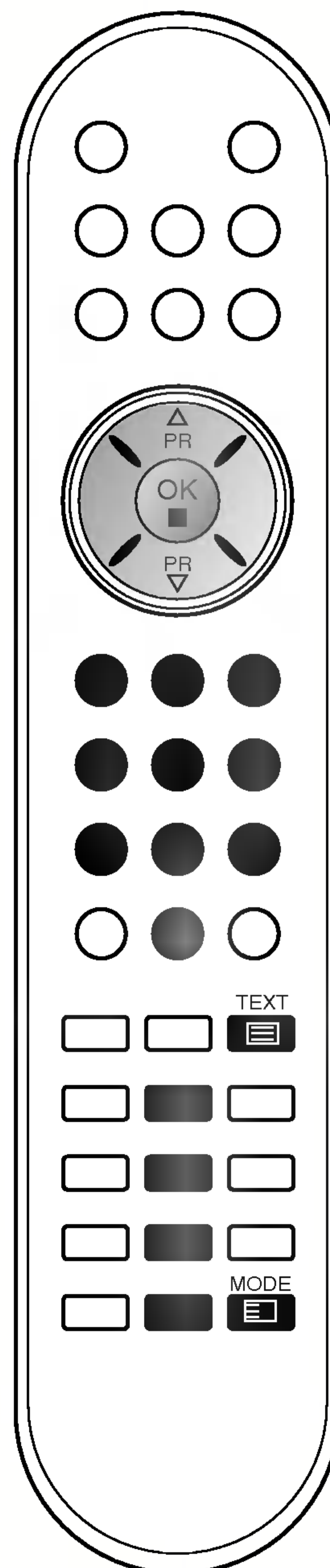





---

# Teletext (option)

---

## Special teletext functions

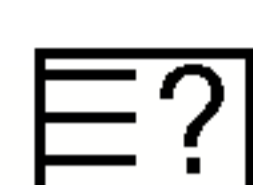

### REVEAL

Press this button to display concealed information, such as solutions of riddles or puzzles.

Press this button again to remove the information from the display.



### SIZE

Selects double height text.



Press this button to enlarge the top half of the page.

Press this button again to enlarge the bottom half of the page.

Press this button again to return to the normal display.

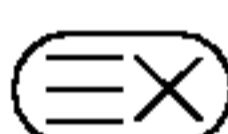

### UPDATE

Displays the TV picture on the screen while waiting for the new teletext page. The display  will appear at the top left hand corner of the screen. When the updated page is available then display  will change to the page number.

Press this button to view the updated teletext page.



### HOLD

Stops the automatic page change which will occur if a teletext page consists of 2 or more sub pages. The number of sub pages and the sub page displayed is, usually, shown on the screen below the time. When this button is pressed the stop symbol is displayed at the top left-hand corner of the screen and the automatic page change is inhibited.

To continue press this button again.





### MIX

Displays the teletext pages superimposed on the TV picture.

To switch the TV picture off press this button again.



### TIME

When viewing a TV programme, press this button to display the time at the top right hand corner of the screen. Press this button again to remove the display. In the teletext mode, press this button to select a sub page number. The sub page number is displayed at the bottom of the screen. To hold or change the sub page, press the RED/GREEN,  /  or NUMBER buttons.

Press again to exit this function.

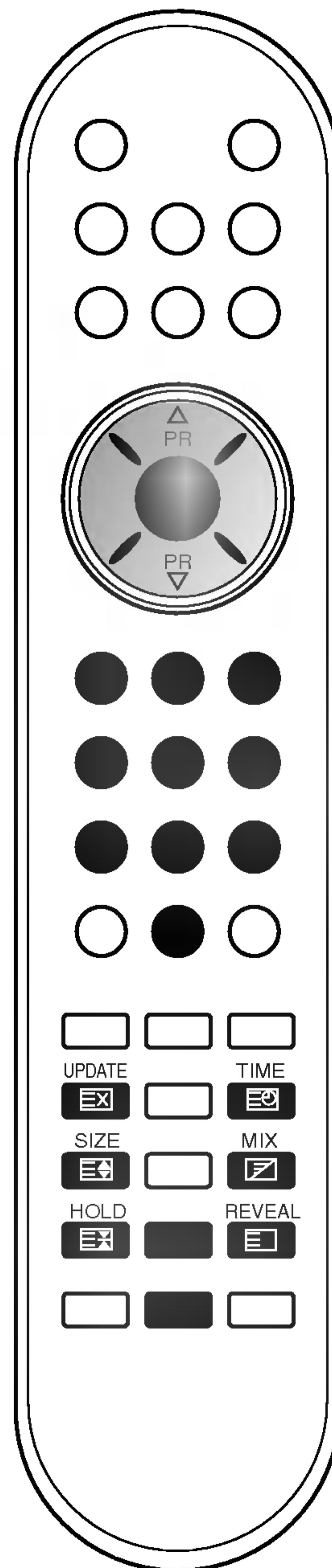

---

# Connection of external equipment

---

You can connect additional equipment, such as VCRs, camcorders etc. to your set. Examples are shown below.

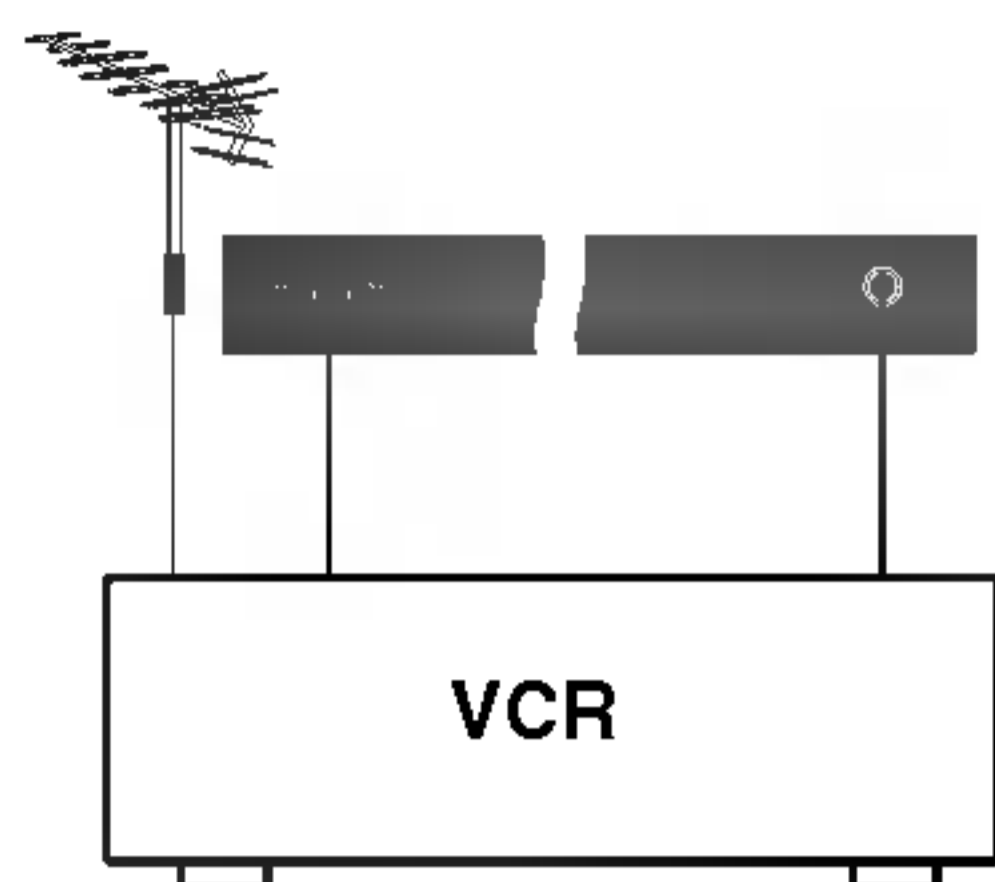

## Aerial socket

1. Connect the RF out socket of the VCR to the aerial socket of the set.
2. Connect the aerial cable to the RF aerial in socket of the VCR.
3. Store the VCR channel on a desired programme number using the 'Manual programme tuning' section.
4. Select the programme number where the VCR channel is stored.
5. Press the **PLAY** button on the VCR.

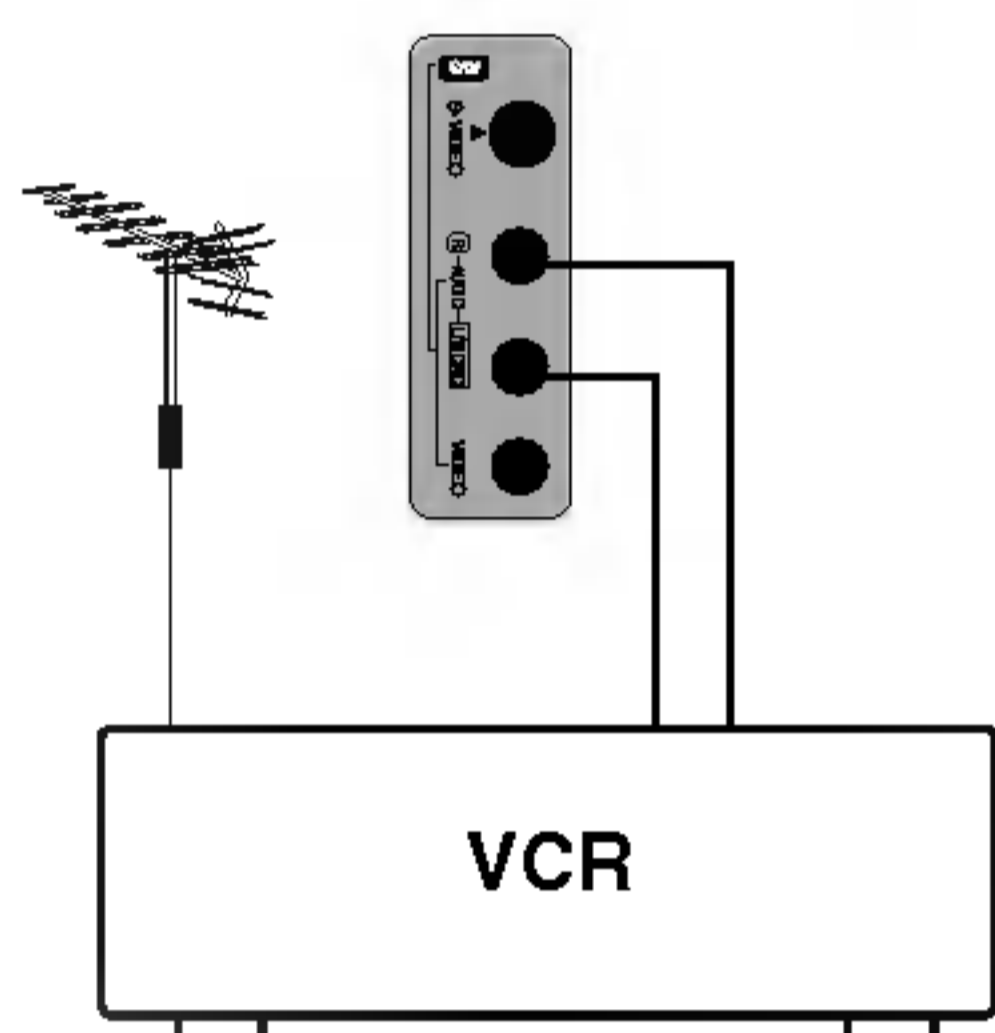
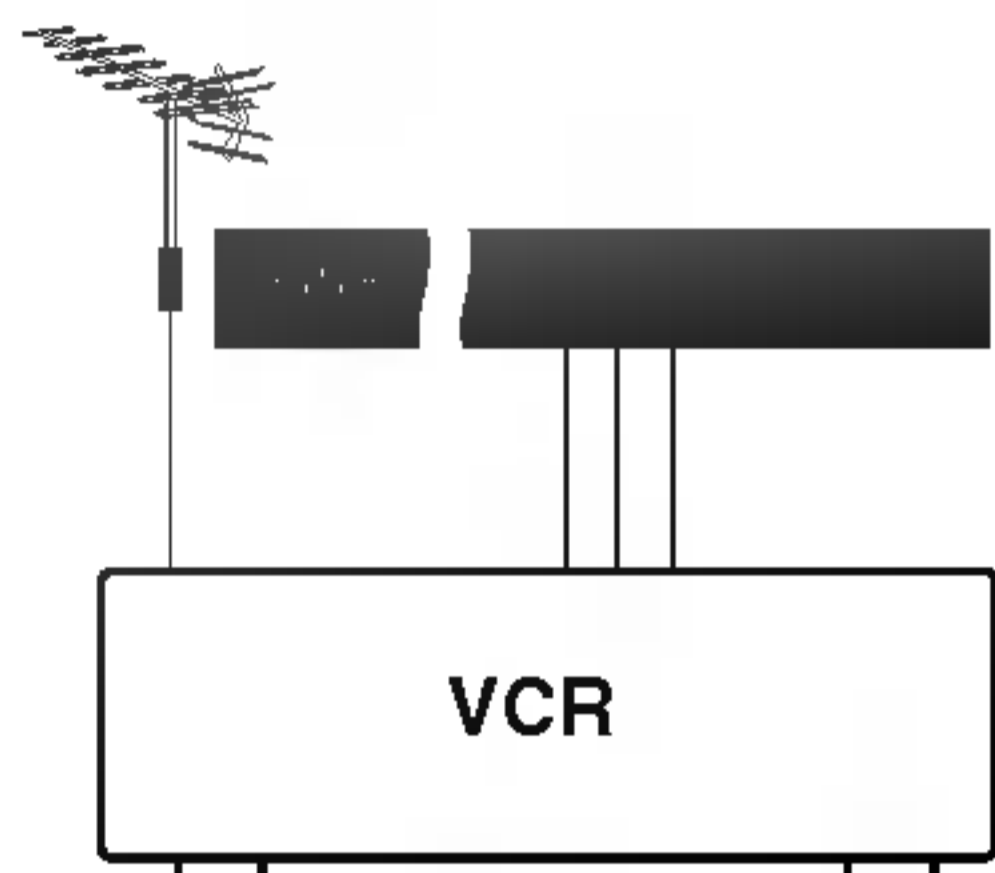

## Audio/Video in sockets

1. Connect the audio/video out sockets of the VCR to audio/video in sockets of the set.
2. Press the **TV/AV** button to select **AV1** (or **AV2**).
3. Press the **PLAY** button on the VCR.  
The VCR playback picture appears on the screen.

**Note :** If you have a mono VCR, connect the audio cable from the VCR to the **AUDIO L/MONO** socket of the set.

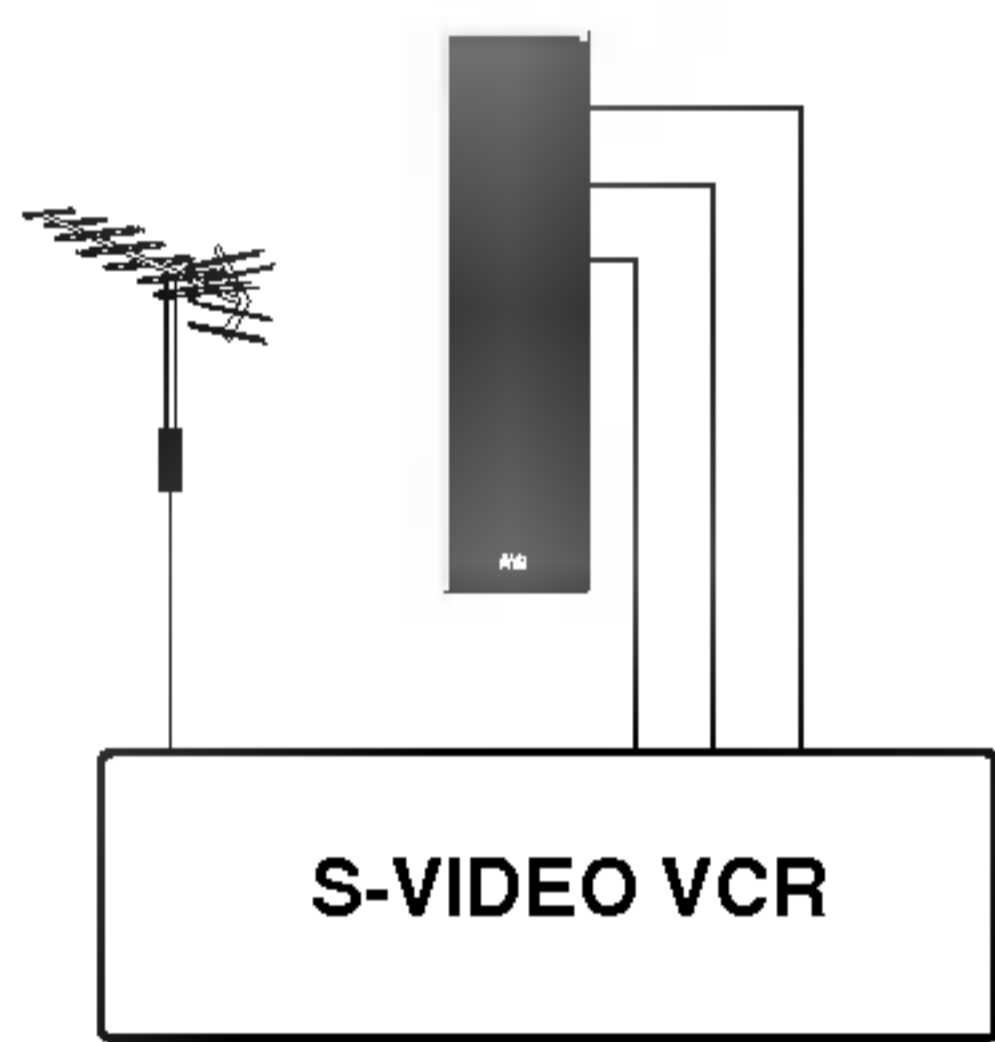

## S-Video/Audio in sockets (S-Video) (option)

When connecting an S-VIDEO VCR to the **S-VIDEO** socket, the picture quality will be further improved.

1. Connect the S-Video socket of the VCR to the **S-VIDEO** socket of the set.
2. Connect the audio cable from the S-VIDEO VCR to the **AUDIO** sockets of the set.
3. Select **S-Video** by pressing the **TV/AV** button repeatedly.
4. Press the **PLAY** button on the VCR.  
The VCR playback picture appears on the screen.

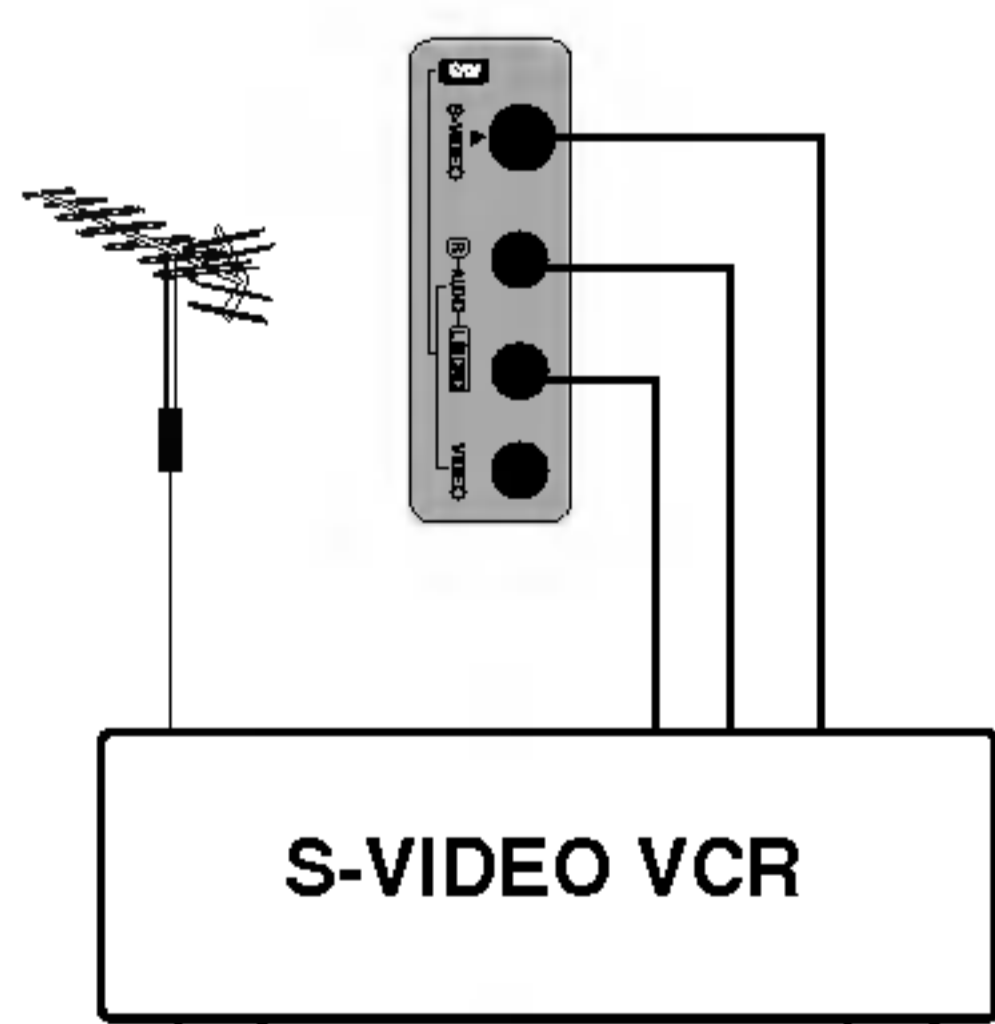
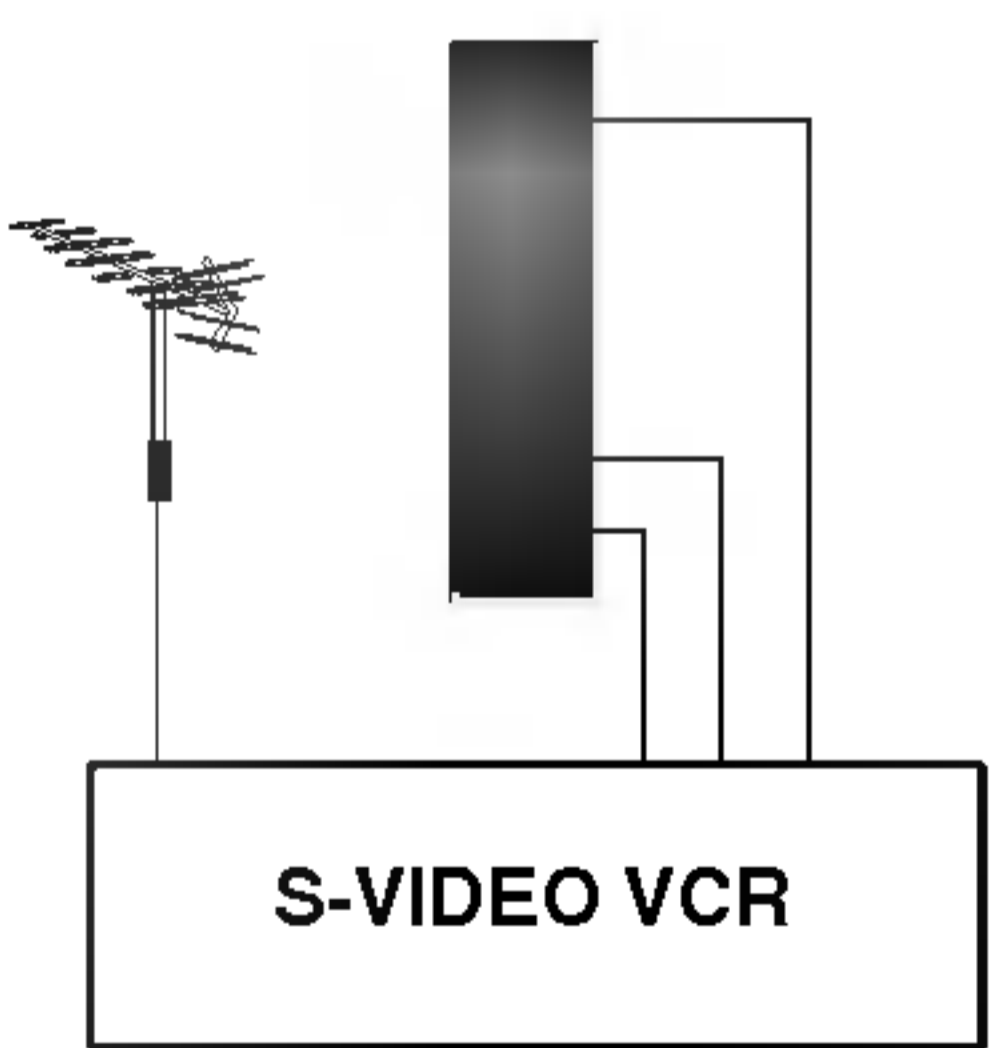



---

# Connection of external equipment

---

## DVD input sockets (option)

1. Connect the DVD output sockets (Y Cb Cr, Y Pb Pr, Y B-Y R-Y or Y P<sub>B</sub> P<sub>R</sub>) of the DVD to the **DVD/DTV IN** sockets (Y P<sub>B</sub> P<sub>R</sub>) of the set.
2. Connect the audio cable from the DVD to **DVD/DTV IN AUDIO** sockets of the set.
3. Press the **TV/AV** or **MULTIMEDIA** button to select **Component** (or **Component 2**)
4. Press the **PLAY** button on the DVD.  
The DVD playback picture appears on the screen.

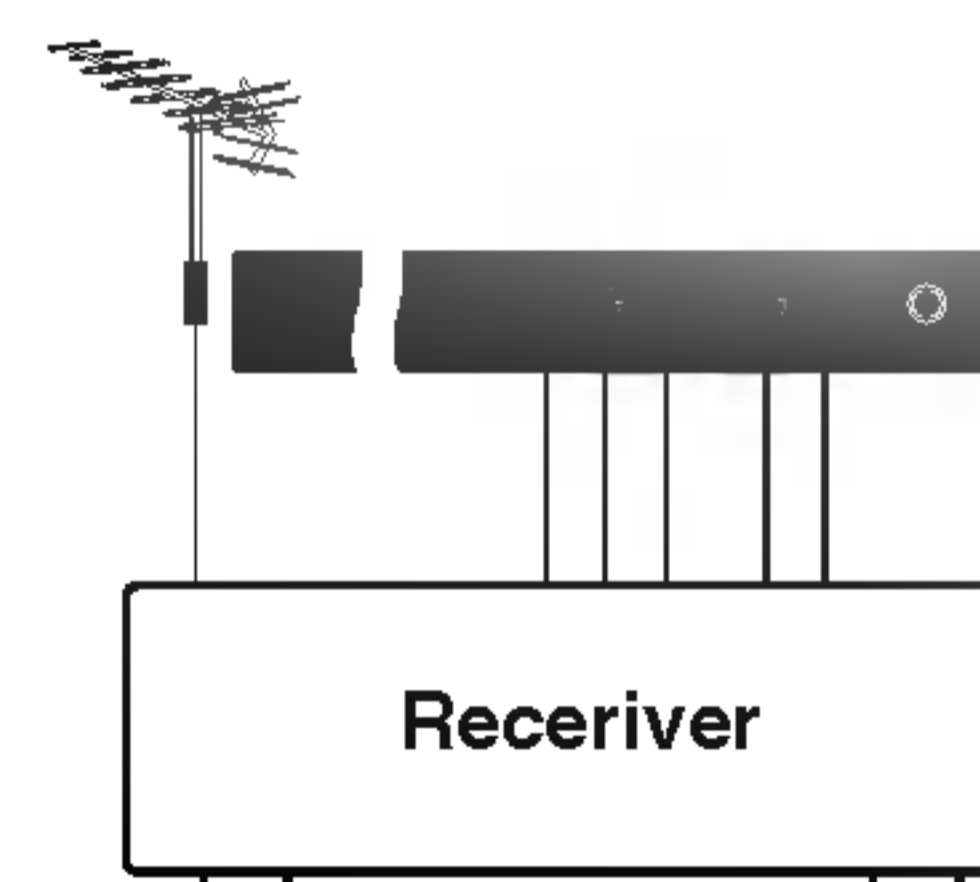
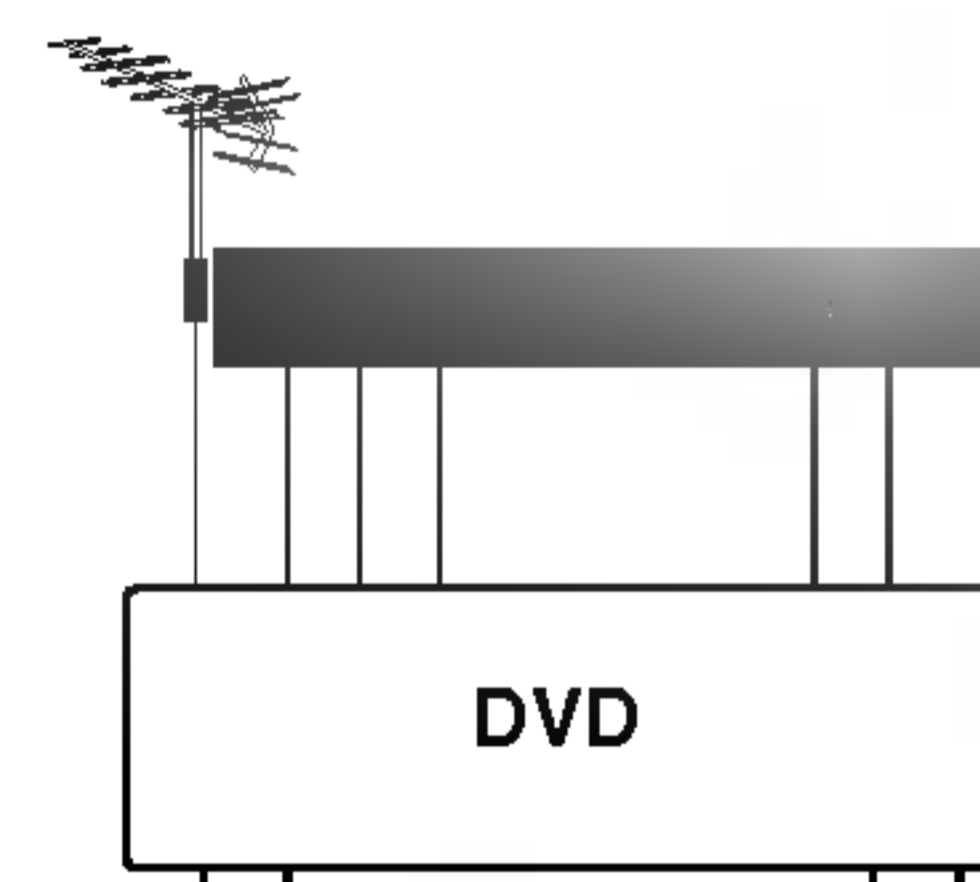
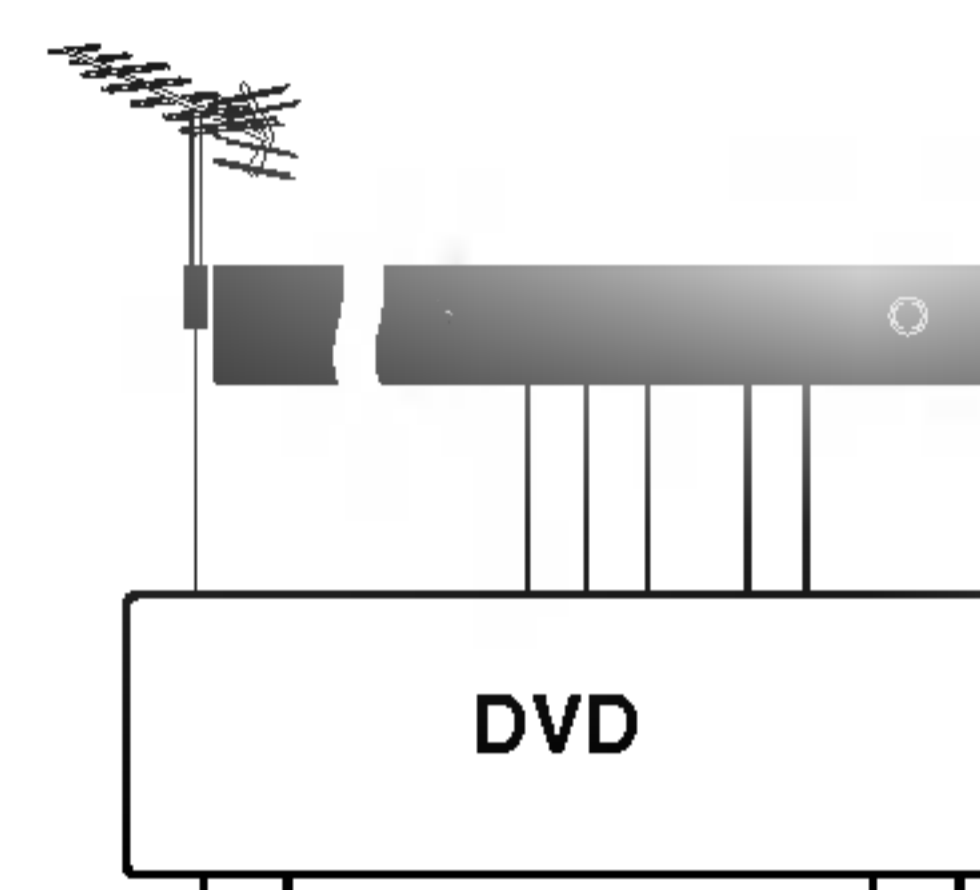
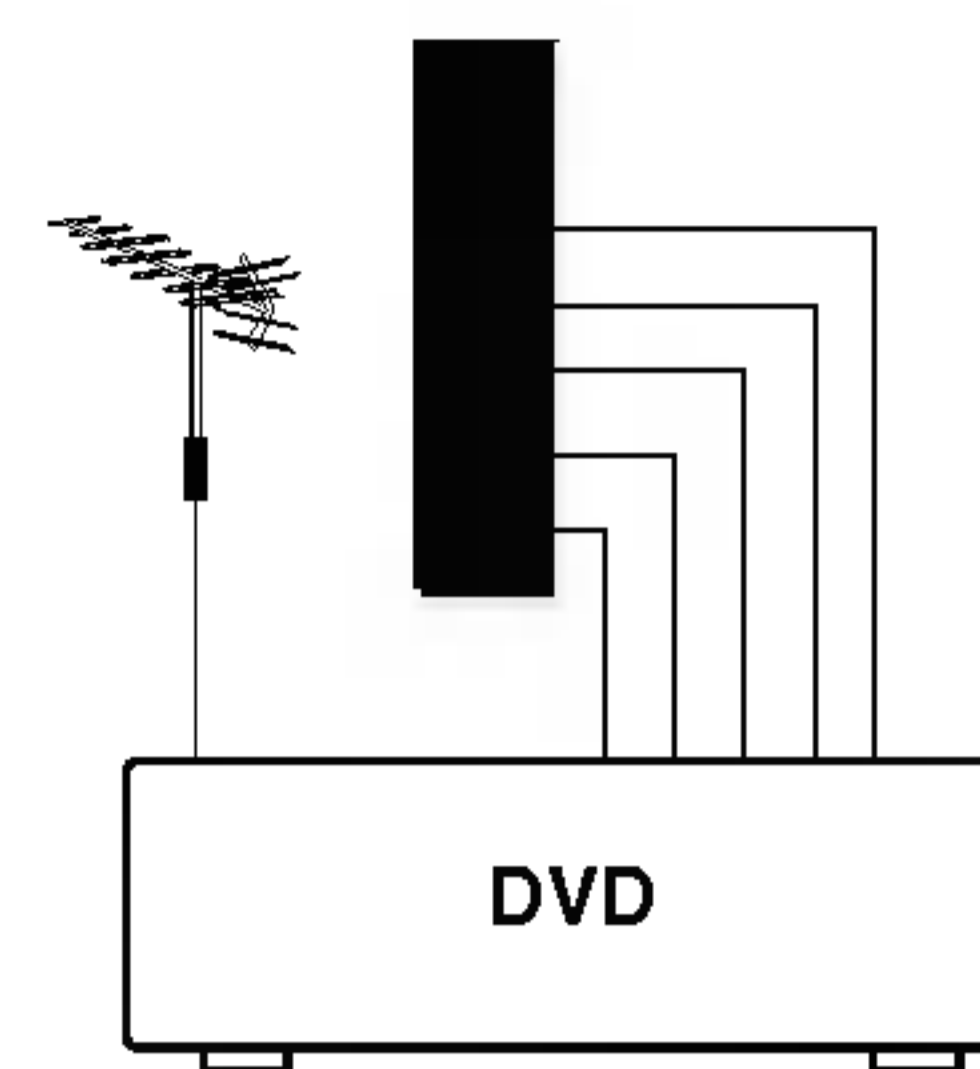

## DTV in sockets

1. Connect the SET TOP outputs to the **DVD/DTV IN** sockets (Y P<sub>B</sub> P<sub>R</sub>) of the set.
2. Connect the audio cable from the SET TOP to the **AUDIO** sockets of the set.
3. Press the **TV/AV** or **MULTIMEDIA** button to select **Component** (or **Component 1**).

## Headphone socket (option)

Insert the headphone plug to the headphone socket of the set. You can listen to the sound through the headphone. To adjust the headphone volume, press the ◀ / ▶ button. If you press the **MUTE** button, the sound from the headphone is switched off.

# Connection of PC (option)

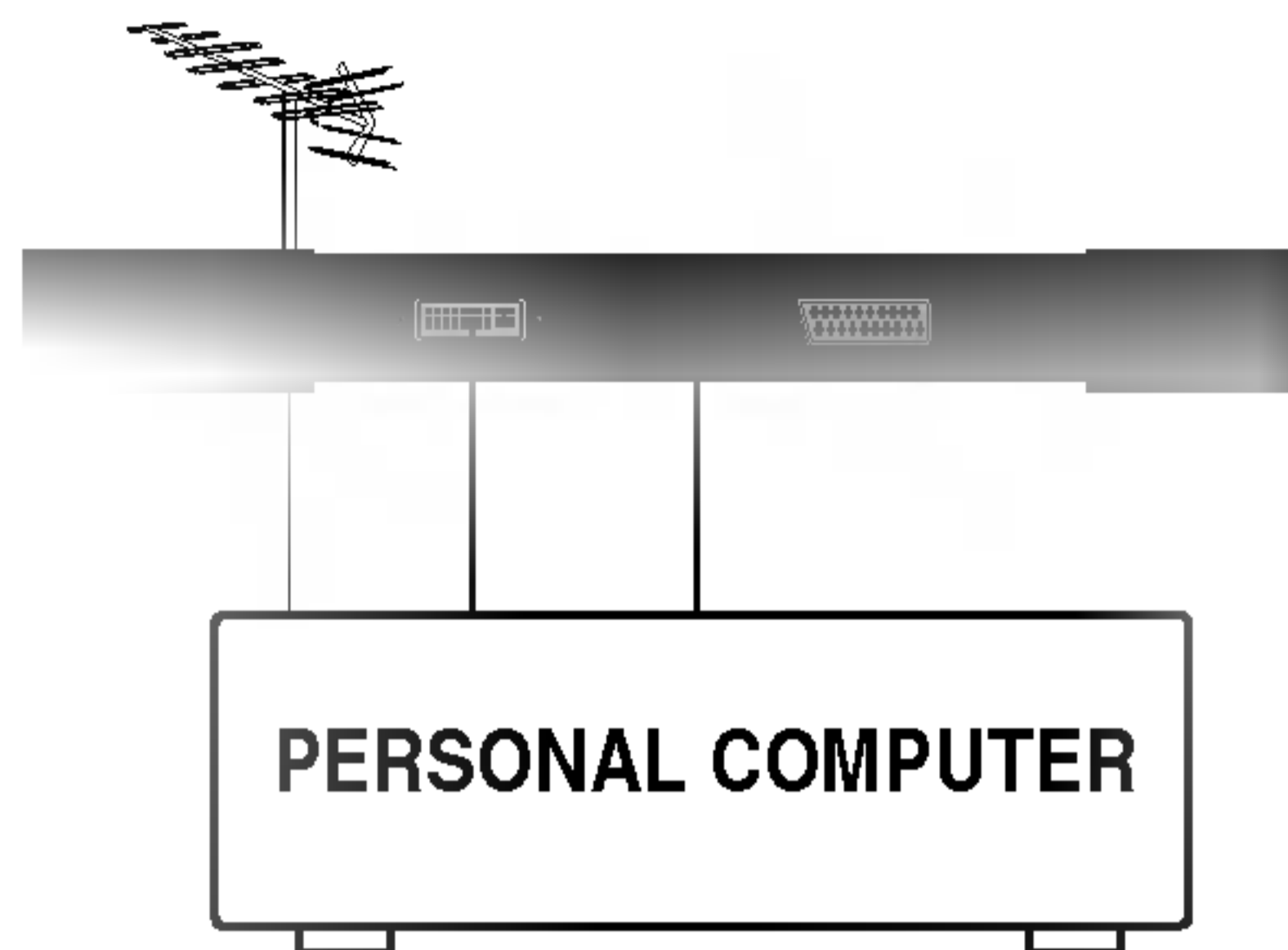

## PC in socket (option)

1. Connect the signal cable from the monitor output socket of the PERSONAL COMPUTER to the PC input socket of the set.
2. Connect the audio cable from the PC to the **PC SOUND** sockets of the set.
3. Press the **TV/AV** or **MULTIMEDIA** button to select **PC**.
4. Switch on the PC, and the PC screen appears on the set.  
The set can be operated as the PC monitor.

**Note :** Connect the signal cable (DVI-D cable, Not DVI to D-Sub cable) from the DVI output socket of the PC to the DVI input socket of the set when using a PC with DVI output.  
In some video cards, DVI-Analogue output may not be supported.

## Displayable Monitor Specification

### ★ 15"~30"

MODE	Resolution	Horizontal Frequency(kHz)	Vertical Frequency(Hz)
VGA	640x480	31.4	60
	640x480	35.0	67
	640x480	37.5	75
SVGA	800x600	35.1	56
	800x600	37.8	60
	800x600	48.0	72
XGA	800x600	46.8	75
	1024x768	48.3	60
	1024x768	56.4	70
WXGA	1024x768	60.0	75
	1280x768	47.6 (option)	60
	1280x720	44.7 (option)	60

### ★ 32"

MODE	Resolution	Horizontal Frequency(kHz)	Vertical Frequency(Hz)
VGA	640x480	31.4	60
SVGA	800x600	37.8	60
XGA	1024x768	48.3	60
WXGA	1280x768	47.6	60
	1360x768	47.6	60

(Synchronization input form : separate)

### Note :

- a. If the set is cold, there may be a small "flicker" when the set is switched on. This is normal, there is nothing wrong with the set.
- b. If possible, use the VESA 1024x768@60Hz (15") / 1280x768@60Hz (17", 23"~30") / 1360x768@60Hz (32") video mode (for 27 inch LCD monitor only, VESA 1280x720@60Hz ; In some video cards, this mode may not be supported.) to obtain the best image quality for your LCD monitor. If used under the other resolutions, some scaled or processed pictures may appear on the screen. The set has been pre-adjusted to the mode VESA 1024x768@60Hz (15") / 1280x768@60Hz (17", 23"-30") / 1360x768@60Hz (32") (for 27 inch LCD monitor only, VESA 1280x720@60Hz).
- c. Some dot defects may appear on the screen, like Red, Green or Blue spots. However, this will have no impact or effect on the monitor performance.
- d. Do not press the LCD screen with your finger for a long time as this may produce some temporary distortion effects on the screen.
- e. When the PC screen appears on the set, a message may appear on the screen, and the message will differ according to the Window system version. If a message appears click "Next" until the message finishes.
- f. If the message "out of Range" appears on the screen, adjust the PC as in the 'Displayable Monitor Specification' section.

### DPM (Display Power Management) mode

When the PC is in the power saving mode, automatically the monitor goes into DPM mode to save the energy.

**Note :** Use the supplied signal cable with the set. Otherwise, DPM mode may not work.



# Connection of PC (option)

## PC Setup (only DVI-Analogue mode) (option)

You can adjust horizontal/vertical position, clock, phase, and auto-configure, reset as you prefer.

1. Press the **MENU** button and then **▲ / ▼** button to select the Setup menu.
2. Press the **▶** button and then **▲ / ▼** button to select **Input**.
3. Press the **▶** button and then **▲ / ▼** button to select **PC**.
4. Press the **MENU** button and then **▲ / ▼** button to select the PC menu.

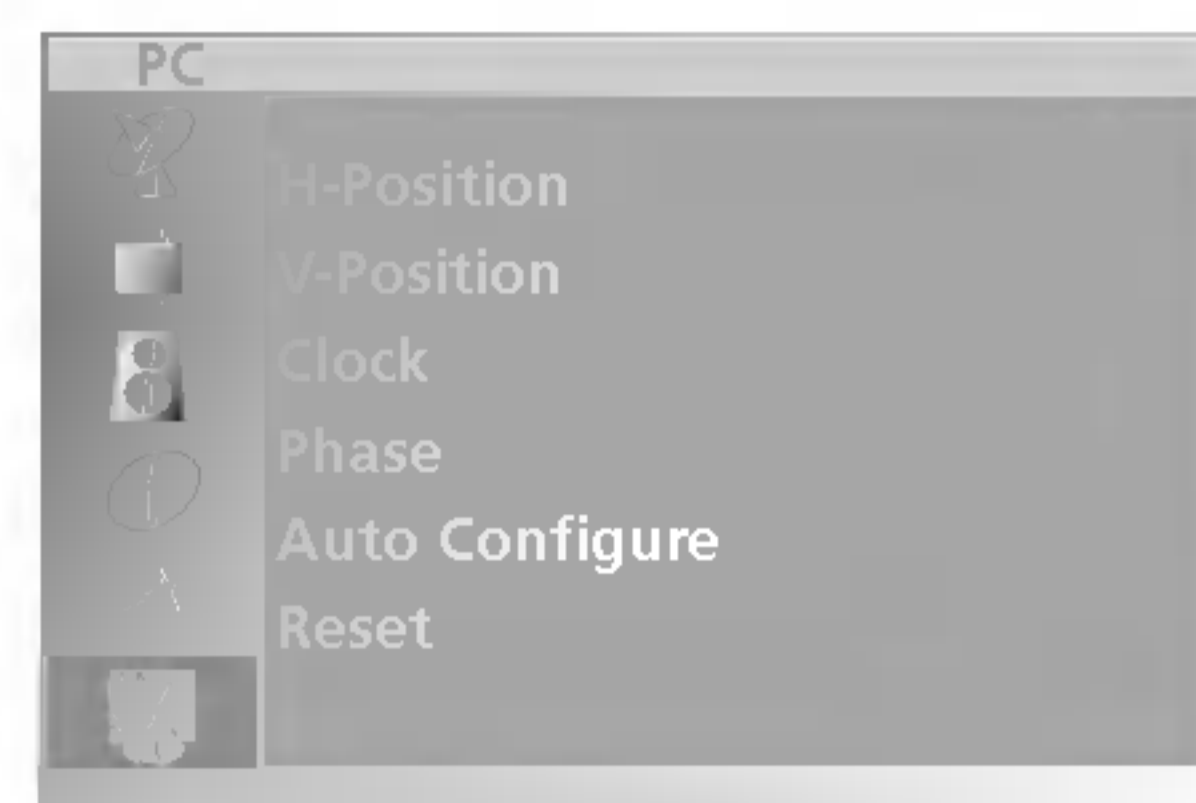

5. Press the **▶** button and then **▲ / ▼** button to select the desired picture item.
6. Press the **◀ / ▶** button to make appropriate adjustments.

### H-Position / V-Position

This function is to adjust picture to left/right and up/down as you prefer.

### Clock

This function is to minimize any vertical bars or stripes visible on the screen background. And the horizontal screen size will also change.

### Phase

This function allows you to remove any horizontal noise and clear or sharpen the image of characters.

### Auto-configure

This function is for the automatic adjustment of the screen position, clock and phase. The displayed image will disappear for a few seconds while the Auto-configuration is in progress.

### Reset

This function allows you to return to the good picture reproduction programmed at the factory and cannot be changed.

**Note :** Some signal from some graphics boards may not function properly. If the results are unsatisfactory, adjust your monitor's position, clock and phase manually.

7. Press the **OK** button to store it for the PC monitor picture.
8. Press the **TV/AV** button to return to PC mode.

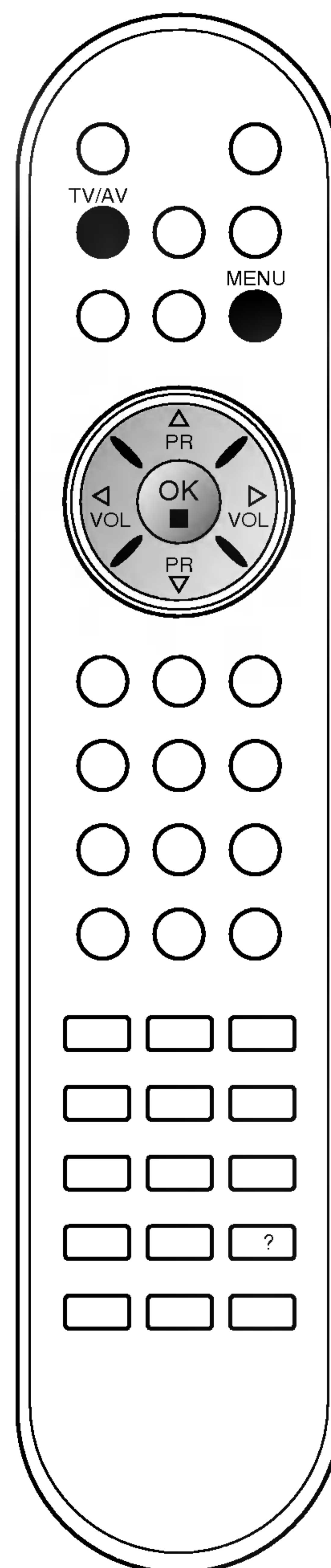

# External Control Device Setup ; RS-232C (option)

- Connect the RS-232C input jack to an external control device (such as a computer or an A/V control system) and control the TV's functions externally.
- Connect the serial port of the control device to the RS-232C jack on the TV back panel.
- RS-232C connection cable is not supplied with the TV.

## RS-232C Setup

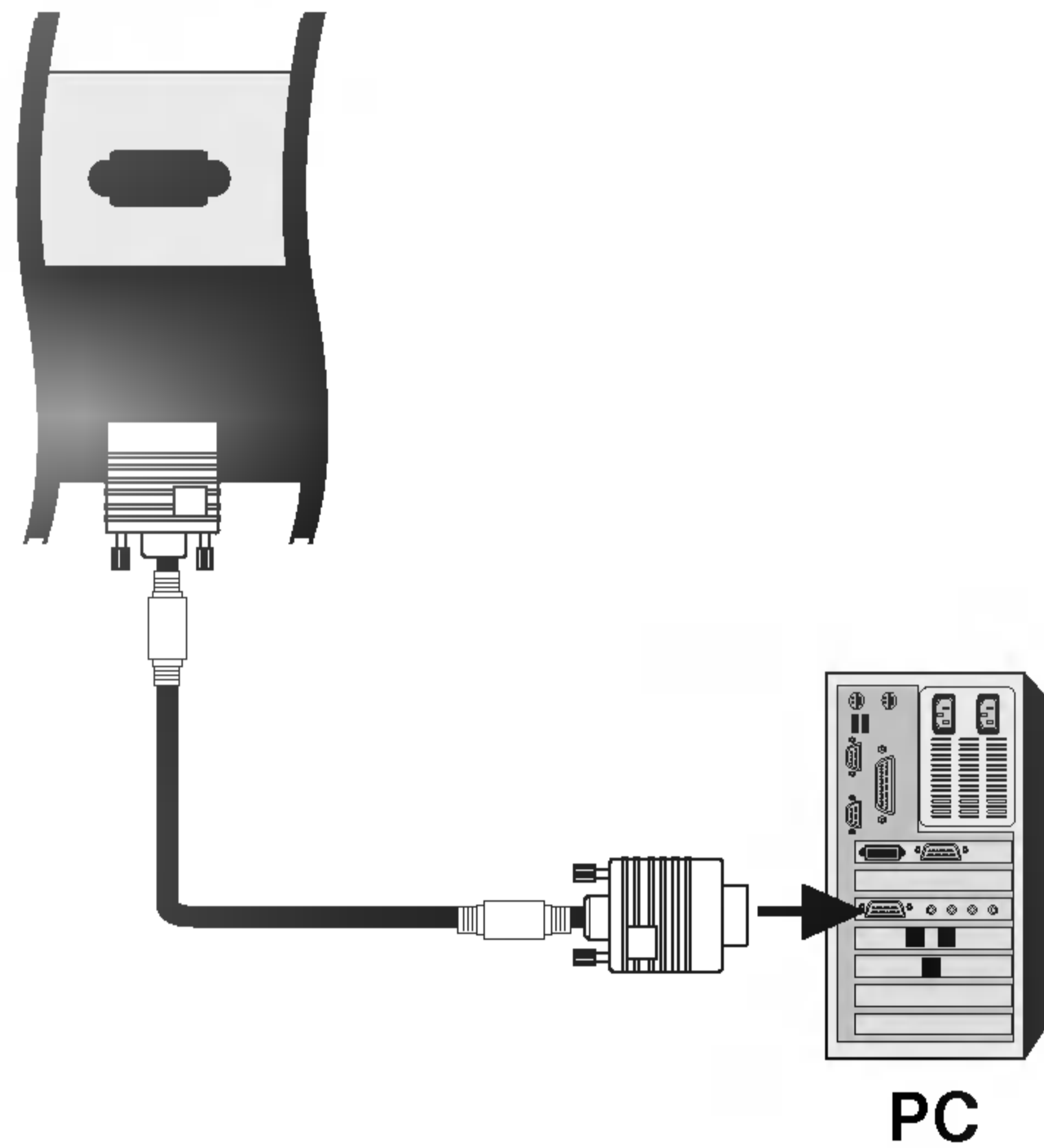

## Type of Connector; D-Sub 9-Pin Male

No.	Pin name
1	No connection
2	RXD (Receive data)
3	TXD (Transmit data)
4	DTR (DTE side ready)
5	GND
6	DSR (DCE side ready)
7	RTS (Ready to send)
8	CTS (Clear to send)
9	No Connection

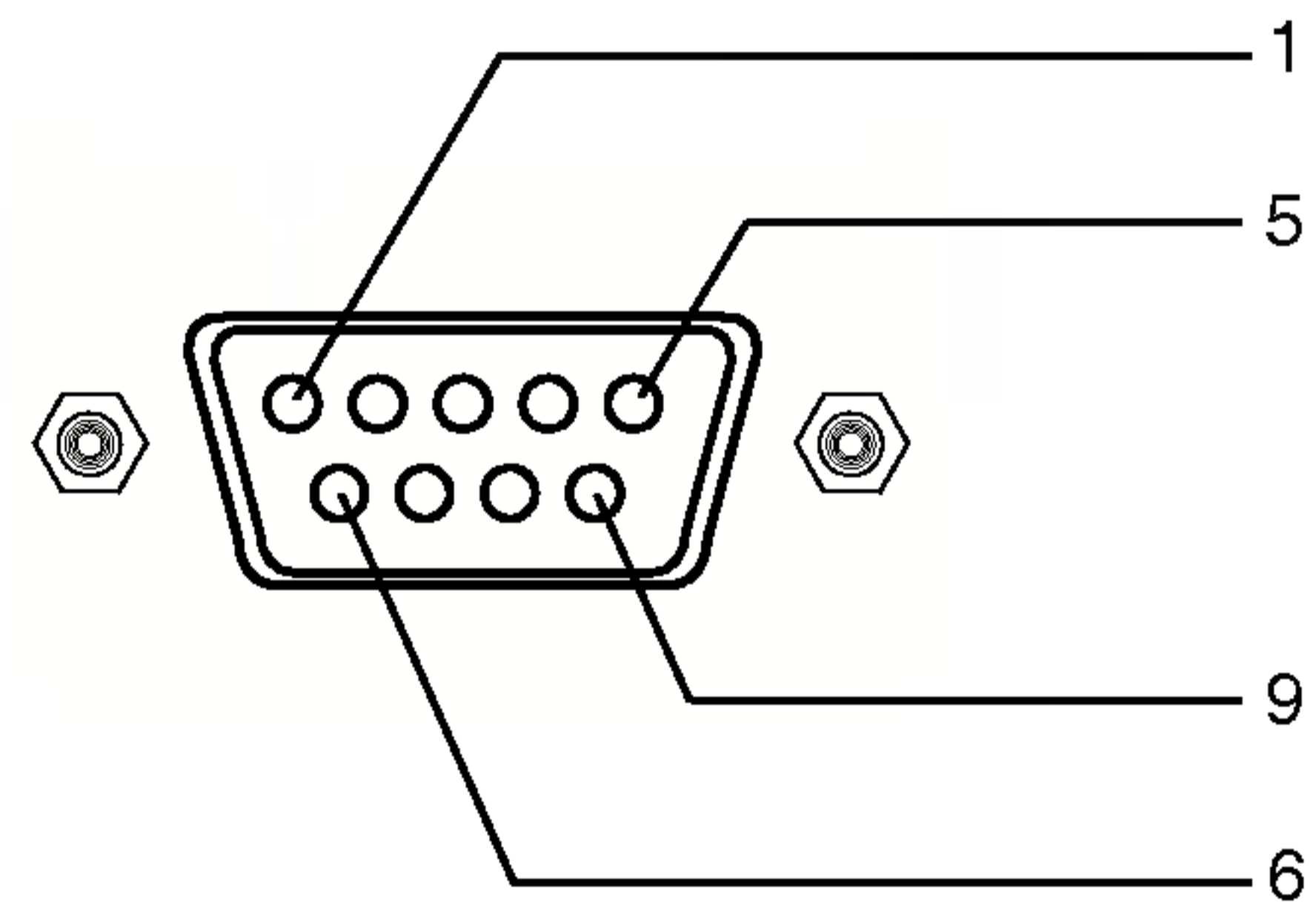

## RS-232C Configurations

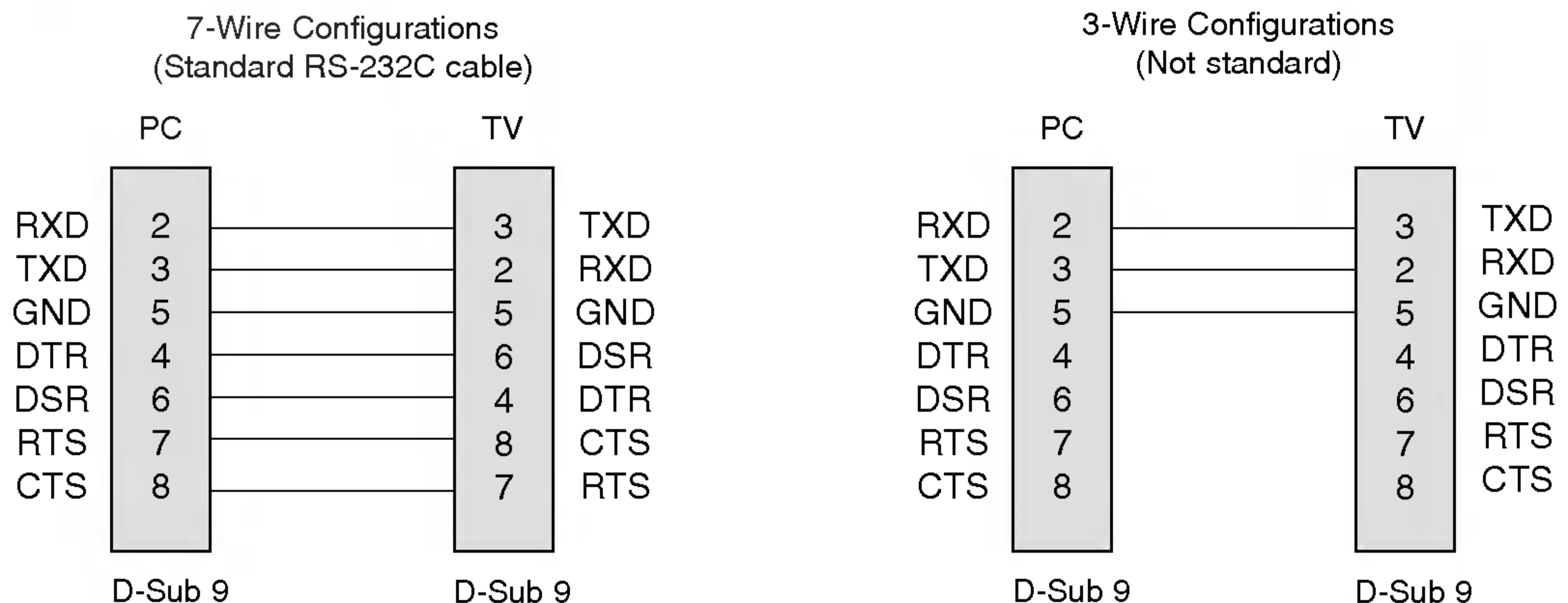



# External Control Device Setup ; RS-232C (option)

## Communication Parameters

- Baud rate : 9600 bps (UART)
- Data length : 8 bits
- Parity : None
- Stop bit : 1 bit
- Communication code : ASCII code

\* Use a crossed (reverse) cable.

## Command Reference List

	COMMAND 1	COMMAND 2	DATA (Hexa)
01. Power	k	a	0 ~ 1
02. Input Select	k	b	*
03. Aspect Ratio	k	c	0 ~ 4
04. Screen Mute	k	d	0 ~ 1
05. Volume Mute	k	e	0 ~ 1
06. Volume Control	k	f	0 ~ 64
07. Contrast	k	g	0 ~ 64
08. Brightness	k	h	0 ~ 64
09. Color	k	i	0 ~ 64
10. Tint	k	j	0 ~ 64
11. Sharpness	k	k	0 ~ 64
12. OSD Select	k	l	0 ~ 1
13. Key Lock	k	m	0 ~ 1
14. Balance	k	t	0 ~ 64
15. Tune Command	m	a	0 ~ 63
16. Add/Delete	m	b	0~1
17. Key	m	c	Key Code

\* : Refer to '02. Input Select' on page 33

## Transmission / Receiving Protocol

### Transmission

[Command1][Command2][ ][Set ID][ ][Data][Cr]

- \* [Command 1]: First command. (j or k)
- \* [Command 2]: Second command.
- \* [Set ID]: You can adjust the set ID to choose desired monitor ID number in Special menu. Adjustment range is 1 ~ 99. When selecting Set ID '0', every connected TV set is controlled. Set ID is indicated as decimal (1~99) on menu and as Hexa decimal (0x0~0x63) on transmission/receiving protocol.
- \* [DATA]: To transmit command data.  
Transmit 'FF' data to read status of command.
- \* [Cr]: Carriage Return  
ASCII code '0x0D'
- \* [ ]: ASCII code 'space (0x20)'

### OK Acknowledgement

[Command2][ ][Set ID][ ][OK][Data][x]

- \* The Monitor transmits ACK (acknowledgement) based on this format when receiving normal data. At this time, if the data is data read mode, it indicates present status data. If the data is data write mode, it returns the data of the PC computer.

### Error Acknowledgement

[Command2][ ][Set ID][ ][NG][Data][x]

- \* The Monitor transmits ACK (acknowledgement) based on this format when receiving abnormal data from non-viable functions or communication errors.

# External Control Device Setup ; RS-232C (option)

## 01. Power On (Command:a)

- ▶ To control Power On/Off of the TV.

### Transmission

[k][a][ ][Set ID][ ][Data][Cr]

Data 0 : Power Off                    1 : Power On

### Acknowledgement

[a][ ][Set ID][ ][OK][Data][x]

- ▶ To show Power On/Off.

### Transmission

[k][a][ ][Set ID][ ][FF][Cr]

### Acknowledgement

[a][ ][Set ID][ ][OK][Data][x]

Data 0 : Power Off                    1 : Power On

## 02. Input Select (Command:b) (Main Picture Input)

- ▶ To select input source for the TV.  
You can also select an input source using the TV/VIDEO button on the TV's remote control.

### Transmission

[k][b][ ][Set ID][ ][Data][Cr]

Data 10 : TV                            40 : Component 1 or  
          20 : AV1 or AV                    Component  
          21 : AV2 (option)                41 : Component 2 (option)  
          30 : S-Video                    60 : PC

### Acknowledgement

[b][ ][Set ID][ ][OK][Data][x]

## 03. Aspect Ratio (Command:c) (Main picture format)

- ▶ To adjust the screen format.  
You can also adjust the screen format using the ARC (Aspect Ratio Control) button on remote control or in the Screen menu.

### Transmission

[k][c][ ][Set ID][ ][Data][Cr]

Data 0 : Normal screen (4:3)            3 : Zoom  
          1 : Wide screen (16:9)        4 : Auto  
          2 : 14:9

\* In PC mode only 16:9 and 4:3 aspect ratios are available.

### Acknowledgement

[c][ ][Set ID][ ][OK][Data][x]

## 04. Screen Mute (Command:d)

- ▶ To select screen mute on/off.

### Transmission

[k][d][ ][Set ID][ ][Data][Cr]

Data 0 : Screen mute off (Picture on)  
          1 : Screen mute on (Picture off)

### Acknowledgement

[d][ ][Set ID][ ][OK][Data][x]

## 05. Volume Mute (Command:e)

- ▶ To control volume mute on/off.  
You can also adjust mute using the MUTE button on remote control.

### Transmission

[k][e][ ][Set ID][ ][Data][Cr]

Data 0 : Volume mute off (Volume on)  
          1 : Volume mute on (Volume off)

### Acknowledgement

[e][ ][Set ID][ ][OK][Data][x]

## 06. Volume Control (Command:f)

- ▶ To adjust volume.  
You can also adjust volume with the volume buttons on remote control.

### Transmission

[k][f][ ][Set ID][ ][Data][Cr]

Data Min : 0 ~ Max : 64

- Refer to 'Real data mapping 1' as shown below.

### Acknowledgement

[f][ ][Set ID][ ][OK][Data][x]

## 07. Contrast (Command:g)

- ▶ To adjust screen contrast.  
You can also adjust contrast in the Picture menu.

### Transmission

[k][g][ ][Set ID][ ][Data][Cr]

Data Min : 0 ~ Max : 64

- Refer to 'Real data mapping 1' as shown below.

### Acknowledgement

[g][ ][Set ID][ ][OK][Data][x]

## 08. Brightness (Command:h)

- ▶ To adjust screen brightness.  
You can also adjust brightness in the Picture menu.

### Transmission

[k][h][ ][Set ID][ ][Data][Cr]

Data Min : 0 ~ Max : 64

- Refer to 'Real data mapping 1' as shown below.

### Acknowledgement

[h][ ][Set ID][ ][OK][Data][x]

#### \* Real data mapping 1

0 : Step 0  
⋮  
A : Step 10  
⋮  
F : Step 15  
10 : Step 16  
⋮  
64 : Step 100

\* Tint : -50 ~ +50



# External Control Device Setup ; RS-232C (option)

## 09. Color (Command:i)

- ▶ To adjust the screen color.  
You can also adjust color in the Picture menu.

### Transmission

[k][i][ ][Set ID][ ][Data][Cr]

Data Min : 0 ~ Max : 64  
• Refer to 'Real data mapping 1'. See page 33.

### Acknowledgement

[i][ ][Set ID][ ][OK][Data][x]

## 10. Tint (Command:j)

- ▶ To adjust the screen tint.(NTSC M input only)  
You can also adjust tint in the Picture menu.

### Transmission

[k][j][ ][Set ID][ ][Data][Cr]

Data :Green 0 ~ Red : 64  
• Refer to 'Real data mapping 1'. See page 33.

### Acknowledgement

[j][ ][Set ID][ ][OK][Data][x]

## 11. Sharpness (Command:k)

- ▶ To adjust the screen sharpness.  
You can also adjust sharpness in the Picture menu.

### Transmission

[k][k][ ][Set ID][ ][Data][Cr]

Data Min: 0 ~ Max: 64  
• Refer to 'Real data mapping 1'. See page 33.

### Acknowledgement

[k][ ][Set ID][ ][OK][Data][x]

## 12. OSD Select (Command:l)

- ▶ To select OSD (On Screen Display) mute on/off.

### Transmission

[k][l][ ][Set ID][ ][Data][Cr]

Data 0: OSD mute on 1: OSD mute off

### Acknowledgement

[l][ ][Set ID][ ][OK][Data][x]

## 13. Key Lock (Command:m)

- ▶ To lock the remote control and the front panel controls on the TV.

### Transmission

[k][m][ ][Set ID][ ][Data][Cr]

Data 0: Lock off 1: Lock on

### Acknowledgement

[m][ ][Set ID][ ][OK][Data][x]

- If you're not using the remote control and front panel controls on the TV, use this mode. When main power is on/off, remote control lock is released.

## 14. Balance (Command:t)

- ▶ To adjust balance.

### Transmission

[k][t][ ][Set ID][ ][Data][Cr]

Data Min: 0 ~ Max: 64 (transmit by Hexadecimal code)

### Acknowledgement

[t][ ][Set ID][ ][OK][Data][x]

## 15. Tune Command (Command:m a)

- ▶ Tune channel to following Physical/major/minor number.

### Transmission

[m][a][ ][Set ID][ ][Data0][ ][Cr]

Data0: Programme Number  
Min : 0 ~ Max : 63(transmit by Hexadecimal code)

### Acknowledgement

[a][ ][Set ID][ ][OK][Data0][x]  
[a][ ][Set ID][ ][NG][Data0][x]

## 16. Skip programme (Command:m b)

- ▶ To skip the current programme.

### Transmission

[m][b][ ][Set ID][ ][Data 0][Cr]

Data0: (Programme)Skip on-0, (Programme)Skip off-1

### Acknowledgement

[b][ ][Set ID][ ][OK][Data0][x]  
[b][ ][Set ID][ ][NG][Data0][x]

## 17. Key (Command:m c)

- ▶ To send IR remote key code.

### Transmission

[m][c][ ][Set ID][ ][Data][Cr]

Data: Key code

### Acknowledgement

[c][ ][Set ID][ ][OK][Data][x]

## Key code

Function	Code	Function	Code
MUTE	09	SSM	52
POWER	08	PSM	4D
LIST	53	SLEEP	0E
Q.VIEW	1A	ARC	79
MENU	43	TEXT	20
PR+	00	UPDATE	62
PR-	01	SIZE	64
VOL+	02	HOLD	65
VOL-	03	INDEX	70
OK	44	TIME	26
1	11	MIX	24
2	12	REVEAL	2A
3	13	MODE	22
4	14	BLUE	61
5	15	YELLOW	63
6	16	GREEN	71
7	17	RED	72
8	18	TV/AV	0B
9	19	TV/PC	98
0	10	I/II	0A

# Troubleshooting check list

## Symptoms

No picture, no sound

Sound OK, poor picture

Picture OK, poor sound

Picture blurred

Lines or streaks in picture

Poor reception on some channels

No colour

Poor colour

Remote control does not work

Incorrect position

Vertical bars or stripes on background

Horizontal noise

Signal Cable message appears

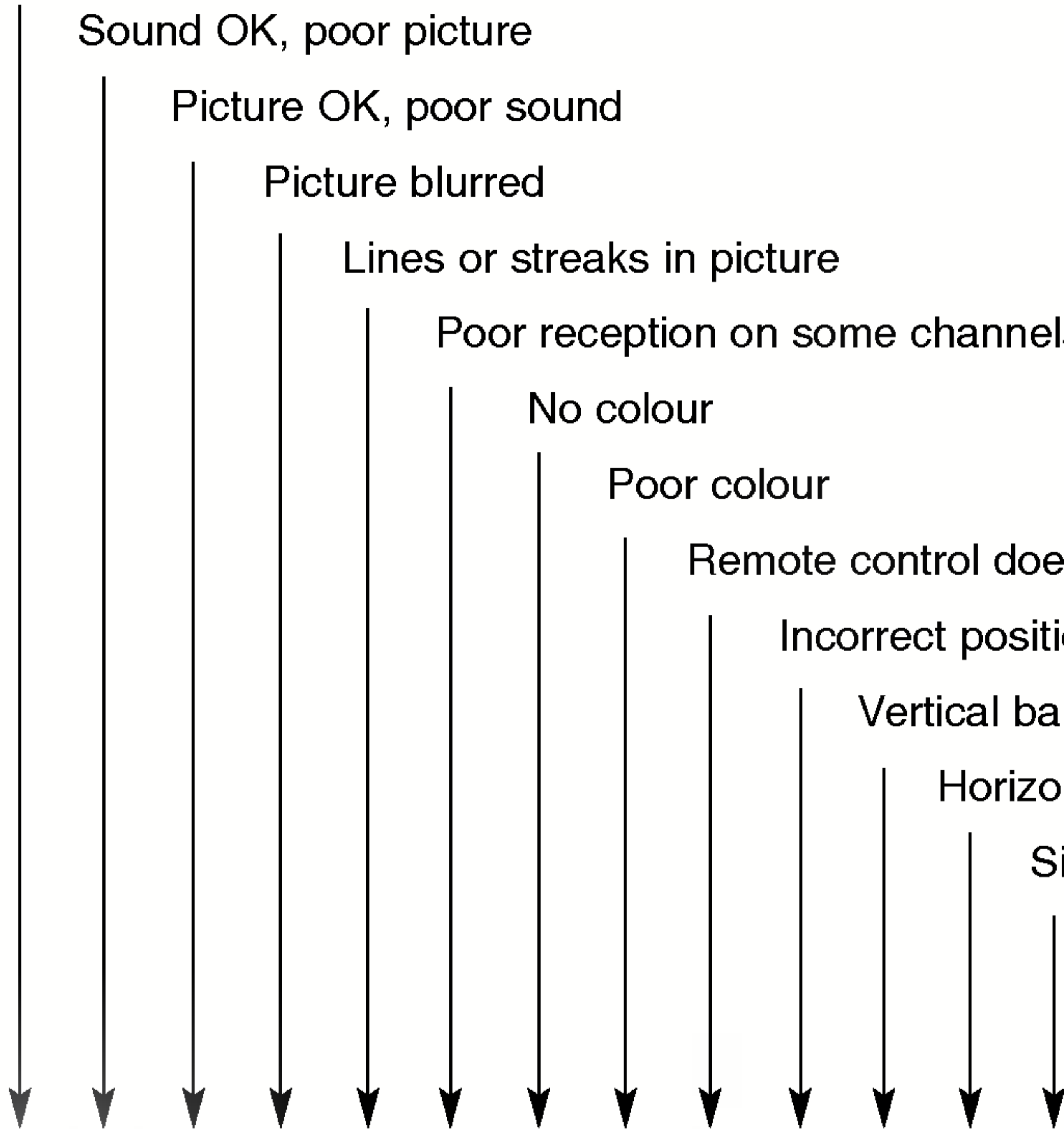

### Check these items and try to adjust these

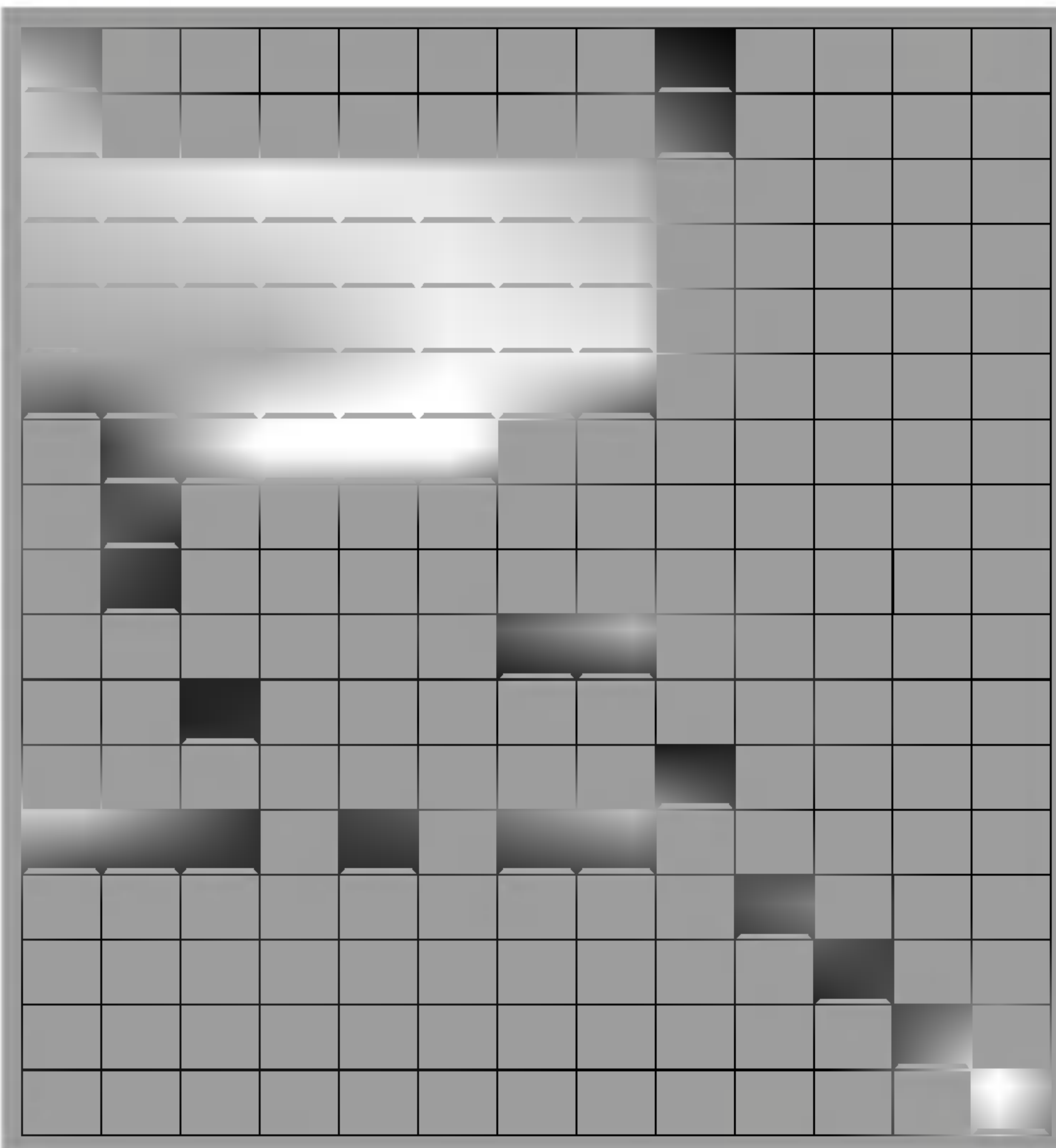

- The mains plug-(plugged in and switched on)
- Is the TV switched on
- Try another channel (weak signal)
- Check aerial (plugged into TV?)
- Check aerial (broken lead?)
- Check aerial
- Check for local interference
- Adjust contrast
- Adjust brightness
- Adjust colour
- Adjust volume
- Check the batteries in remote control
- Check Audio/Video sockets (VCR only)
- Auto-configure or adjust the H/V position
- Auto-configure or adjust Clock
- Auto-configure or adjust Phase
- Is the Signal Cable connected or loose



