



PLASMA TV

OWNER'S MANUAL

MODELS: 42PX4D/42PX5D
42PX4D-UB/42PX5D-UB



Please read this manual carefully and completely before operating your TV.
Retain this manual for future reference.
Record model number and serial number of the TV in the spaces provided below.
See the label attached on the back cover and relate this information to your dealer if you require service.

Model Number :
Serial Number :

Blank lines for recording Model Number and Serial Number.

Warning/Caution

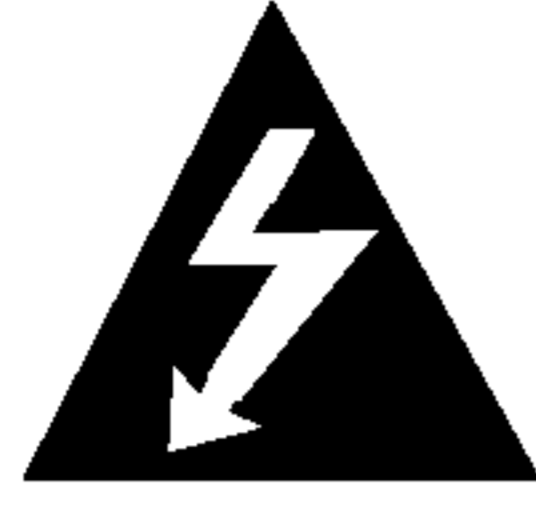

WARNING/CAUTION
RISK OF ELECTRIC SHOCK
DO NOT OPEN



WARNING/CAUTION:

TO REDUCE THE RISK OF ELECTRIC SHOCK DO NOT REMOVE COVER (OR BACK). NO USER SERVICEABLE PARTS INSIDE. REFER TO QUALIFIED SERVICE PERSONNEL.



The lightning flash with arrowhead symbol, within an equilateral triangle, is intended to alert the user to the presence of uninsulated "dangerous voltage" within the product's enclosure that may be of sufficient magnitude to constitute a risk of electric shock to persons.



The exclamation point within an equilateral triangle is intended to alert the user to the presence of important operating and maintenance (servicing) instructions in the literature accompanying the appliance.

WARNING/CAUTION:

TO PREVENT FIRE OR SHOCK HAZARDS, DO NOT EXPOSE THIS PRODUCT TO RAIN OR MOISTURE.

FCC NOTICE

• A Class B digital device

This equipment has been tested and found to comply with the limits for a Class B digital device, pursuant to Part 15 of the FCC Rules. These limits are designed to provide reasonable protection against harmful interference in a residential installation. This equipment generates, uses and can radiate radio frequency energy and, if not installed and used in accordance with the instructions, may cause harmful interference to radio communications. However, there is no guarantee that interference will not occur in a particular installation. If this equipment does cause harmful interference to radio or television reception, which can be determined by turning the equipment off and on, the user is encouraged to try to correct the interference by one or more of the following measures:

- Reorient or relocate the receiving antenna.
- Increase the separation between the equipment and receiver.
- Connect the equipment into an outlet on a circuit different from that to which the receiver is connected.
- Consult the dealer or an experienced radio/TV technician for help.

• Any changes or modifications not expressly approved by the party responsible for compliance could void the user's authority to operate the equipment.

CAUTION:

Do not attempt to modify this product in any way without written authorization from LG Electronics. Unauthorized modification could void the user's authority to operate this product.

COMPLIANCE:

The responsible party for this product's compliance is:
LG Electronics U.S.A., Inc
1000 Sylvan Avenue, Englewood Cliffs, NJ 07632
1-800-243-0000
<http://www.lgusa.com>

WARNING/CAUTION

TO REDUCE THE RISK OF FIRE AND ELECTRIC SHOCK, DO NOT EXPOSE THIS PRODUCT TO RAIN OR MOISTURE.

TV Guide On Screen Notices for U.S.A.

Trademark Notice

In the United States, TV GUIDE and other related marks are registered marks of Gemstar-TV Guide International, Inc. and/or one of its affiliates. In Canada, TV GUIDE is a registered mark of Transcontinental Inc., and is used under license by Gemstar-TV Guide International, Inc.

Aux Etats Unis TV GUIDE et d'autres marques relatives sont des marques déposées de Gemstar-TV Guide International, Inc. et/ou d'une de ses sociétés affiliées. Au Canada TV GUIDE est une marque déposée de Transcontinental Inc., utilisée sous licence de Gemstar-TV Guide International, Inc.

License Notice

The TV Guide On Screen system is manufactured under license from Gemstar-TV Guide International, Inc. and/or one of its affiliates.

Le système TV Guide On Screen est fabriqué sous licence de Gemstar-TV Guide International, Inc. et/ou d'une de ses sociétés affiliées.

Patent Notice

The TV Guide On Screen system is protected by one or more of the following issued United States patents 6,498,895, 6,418,556, 6,331,877; 6,239,794; 6,154,203; 5,940,073; 4,908,713; 4,751,578; 4,706,121.

Le système TV Guide On Screen est protégés par un ou plusieurs brevets émis aux Etats Unis, comme le 6,498,895, 6,418,556, 6,331,877; 6,239,794; 6,154,203; 5,940,073; 4,908,713; 4,751,578; 4,706,121.

Use of the CableCARD™ TradeMark.

“CableCARD™ is a trademark of Cable Television Laboratories, Inc.”

Digital Cable Compatibility

This digital television is capable of receiving basic analog, digital basic and digital premium cable television programming by direct connection to a cable system providing such programming. A security card provided by your cable operator is required to view encrypted digital programming. Cable operator enhanced program (For example, electronic program guide provided by the cable operator), and data enhanced television service may require the use of a set top box. For more information contact your local cable operator.

Safety Instructions

IMPORTANT SAFETY INSTRUCTIONS

Important safety instructions shall be provided with each apparatus. This information shall be given in a separate booklet or sheet, or be located before any operating instructions in an instruction for installation for use and supplied with the apparatus. This information shall be given in a language acceptable to the country where the apparatus is intended to be used. The important safety instructions shall be entitled "Important Safety Instructions". The following safety instructions shall be included where applicable, and, when used, shall be verbatim as follows. Additional safety information may be included by adding statements after the end of the following safety instruction list. At the manufacturer's option, a picture or drawing that illustrates the intent of a specific safety instruction may be placed immediately adjacent to that safety instruction :

1. Read these instructions.
2. Keep these instructions.
3. Heed all warnings.
4. Follow all instructions.
5. Do not use this apparatus near water.
6. Clean only with dry cloth.
7. Do not block any ventilation openings. Install in accordance with the manufacturer's instructions.
8. Do not install near any heat sources such as radiators, heat registers, stoves, or other apparatus (including amplifiers) that produce heat.
9. Do not defeat the safety purpose of the polarized or grounding-type plug. A polarized plug has two blades with one wider than the other. A grounding type plug has two blades and a third grounding prong. The wide blade or the third prong are provided for your safety. If the provided plug does not fit into your outlet, consult an electrician for replacement of the obsolete outlet.
10. Protect the power cord from being walked on or pinched particularly at plugs, convenience receptacles, and the point where they exit from the apparatus.
11. Only use attachments/accessories specified by the manufacturer.
12. Use only with the cart, stand, tripod, bracket, or table specified by the manufacturer, or sold with the apparatus. When a cart is used, use caution when moving the cart/apparatus combination to avoid injury from tip-over.



13. Unplug this apparatus during lightning storms or when unused for long periods of time.

14. Refer all servicing to qualified service personnel. Servicing is required when the apparatus has been damaged in any way, such as power-supply cord or plug is damaged, liquid has been spilled or objects have fallen into the apparatus, the apparatus has exposed to rain or moisture, does not operate normally, or has been dropped.

15. CAUTION concerning the Power Cord :

Most appliances recommend they be placed upon a dedicated circuit; that is, a single outlet circuit which powers only that appliance and has no additional outlets or branch circuits. Check the specification page of this owner's manual to be certain.

Do not overload wall outlets. Overloaded wall outlets, loose or damaged wall outlets, extension cords, frayed power cords, or damaged or cracked wire insulation are dangerous. Any of these conditions could result in electric shock or fire. Periodically examine the cord of your appliance, and if its appearance indicates damage or deterioration, unplug it, discontinue use of the appliance, and have the cord replaced with an exact replacement part by an authorized servicer.

Protect the power cord from physical or mechanical abuse, such as being twisted, kinked, pinched, closed in a door, or walked upon. Pay particular attention to plugs, wall outlets, and the point where the cord exits the appliance.

16. Outdoor Use Marking :

WARNING - To Reduce The Risk Of Fire Or Electric Shock, Do Not Expose This Appliance To Rain Or Moisture.

17. Wet Location Marking :

Apparatus shall not be exposed to dripping or splashing and no objects filled with liquids, such as vases, shall be placed on the apparatus.

Contents

Warning/Caution	2	TV Speakers On/Off Setup	67
Digital Cable Compatibility	3	BBE	68
Safety Instructions	4~5	Stereo/SAP Broadcasts Setup	68
Introduction		Time Menu Options	
Controls	8	Auto Clock Setup	69
Connection Options	9	Manual Clock Setup	69
Remote Control Key Functions	10~11	On/Off Timer Setup	69
Installation		Sleep Timer / Auto Off	70
Accessories	12	Option Menu Features	
Installation Instructions	12~13	Aspect Ratio Control	71
Joining the TV assembly to the wall to protect the set tumbling	12	Cinema 3:2 Mode Setup	71
Swivel function	13	Caption	72
External Equipment Connections	14~19	Caption / Text	72
Antenna or Cable Connection	14~15	Caption Option	73
VCR Setup	15	ISM Method	74
External A/V Source Setup	16	Low Power	75
DVD Setup	16	Auto Demo	75
CableCARD™ Setup	17	Lock Menu Options	
HDSTB Setup	17	Lock Menu Options	76
PC Setup	18	Parental Lock Setup	77
Monitor Out Setup	19	CableCARD™ Function	
Digital Audio Output	19	Cable menu options	78
HDMI	20~22	Scrambled channel	78
TV Guide On Screen Setup	23~32	Cable Channel List	79
IEEE 1394	33~40	Emergency Alert Message	79
TV Guide On Screen™ System	41~59	XSTUDIO	80~85
Operation		Remote Control	
Turning the TV On	60	PIP (Picture-in-Picture)/POP/Twin Picture	86
TV Setup		Watching PIP/POP/Twin Picture	86
On-screen Menus Language Selection	61	Selecting an Input Signal Source for PIP/Twin Picture ..	86
Setup Menu Options		Swapping PIP/Twin Picture	86
EZ Scan (Channel Search)	62	TV Program Selection for PIP	86
Manual Scan	62	Moving the PIP sub picture	87
Channel Edit	63	Adjusting Main and Sub Picture Sizes for Twin Picture ..	87
DTV Signal Strength	63	POP(Picture-out-of-Picture: Channel Scan) ...	87
Channel Label Setup	64	APM(Adaptive Picture Mode)	88
Main Picture Source Selection	64	Brief Info.	89
Input Label	64	EZ Mute	90
Video Menu Options		Freeze & Magnify	90
EZ Picture	65	Screen Setup for PC mode	91
Manual Picture Control (Custom Option)	65	External Control Device Setup	92~97
Color Temperature Control	65	IR Codes	98~99
Video Reset	65	Programming the Remote	100
Audio Menu Options		Programming Codes	101~102
Audio Language	66	Troubleshooting Checklist	103
EZ SoundRite / EZ Sound	66	Maintenance	104
Manual Sound Control (Custom Option)	66	Product Specifications	105
Front Surround	67	Warranty	107~108

Setup and Operation Checklist

Setup and Operation Checklist

(See pages 14~19 for available connection and operational setup options.)

1. Unpack TV and all accessories.
2. Connect all external video and audio equipment.
see pages 15~19.
3. Install batteries in remote control.
See page 11.
4. Turn TV on.
See page 60.
5. Turn video source equipment on.
6. Select viewing source for TV.
See pages 64.
7. Fine-tune source image and sound to your personal preference or as required by source.
See pages 65~ 68.
8. Additional features set up
See Contents above.

After reading this manual, keep it handy for future reference.

Introduction

What is a Plasma Display Panel (PDP)?

A plasma display panel is the latest display technology and the best way to achieve flat panel displays with excellent image quality and large screen sizes that are easily viewable. The PDP can be thought of as a descendant of the neon lamp and it can be also be viewed as a series of fluorescent lamps.

How does it work?

PDP is an array of cells, known as pixels, which are comprised of 3 sub pixels, corresponding to the colors red, green, and blue. Gas in a plasma state is used to react with phosphors in each sub-pixel to produce colored light (red, green, or blue). These phosphors are the same types used in Cathode Ray Tube (CRT) devices such as televisions and common computer monitors.

You get the rich, dynamic colors that you expect. Each sub-pixel is individually controlled by advanced electronics to produce over 16 million different colors. All of these mean that you get perfect images that are easily viewable in a display that is less than 5 inches thick.

160° - Wide angle range of vision

Your flat panel plasma screen offers an exceptionally broad viewing angle -- over 160 degrees. This means that the display is clear and visible to viewers anywhere in the room who can see the screen.

Wide Screen

The screen of the Plasma Display is so wide that your viewing experience is as if you are in a theater.

Multimedia

Connect your plasma display to a PC and you can use it for conferencing, games, and Internet browsing. The Picture-in-Picture feature allows you to view your PC and video images simultaneously.

Versatile

The light weight and thin size makes it easy to install your plasma display in a variety of locations where conventional TVs will not fit.

The PDP Manufacturing Process: a few minute colored dots may be present on the PDP screen

The PDP (Plasma Display Panel), which is the display device of this product, is composed of 0.9 to 2.2 million cells. A few cell defects will normally occur in the PDP manufacturing process. Several tiny, minute colored dots visible on the screen should be acceptable. This also occurs in other PDP manufacturers' products. The tiny dots appearing does not mean that this PDP is defective. Thus a few cell defects are not sufficient cause for the PDP to be exchanged or returned. Our production technology minimizes these cell defects during the manufacture and operation of this product.

Controls

- This is a simplified representation of a front panel.
- Here shown may be somewhat different from your TV.

Front Panel Controls

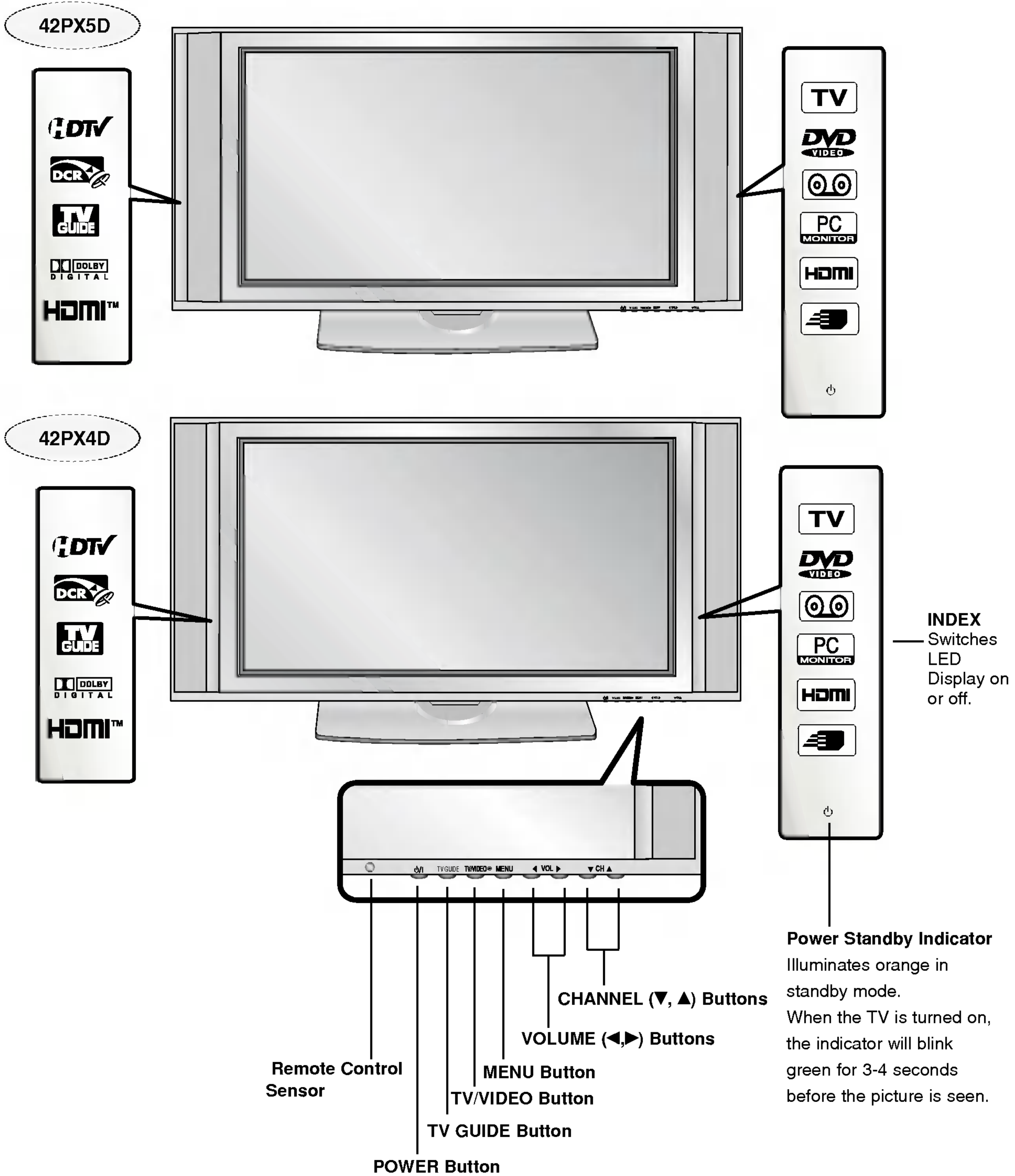

Connection Options

Back Connection Panel

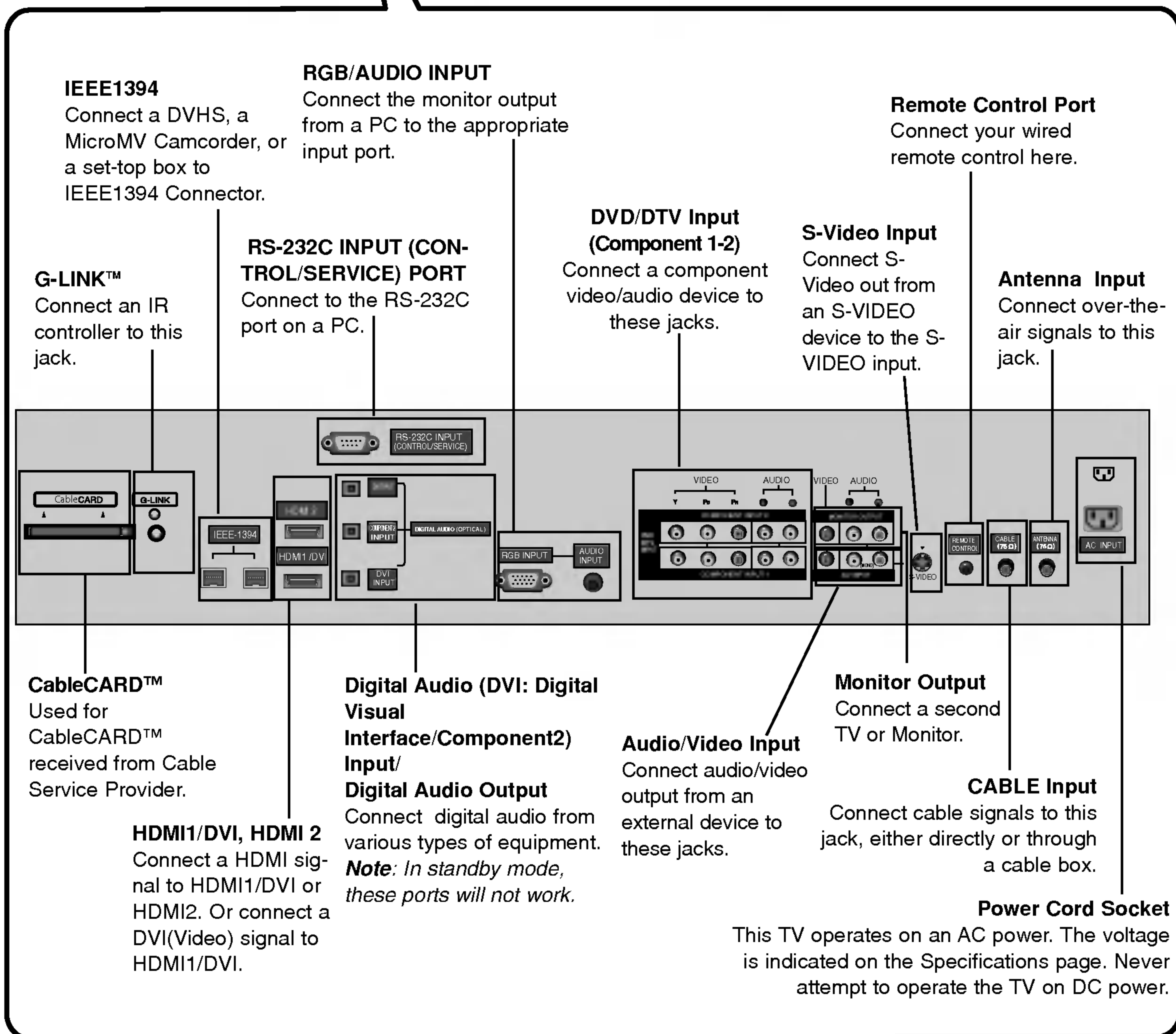
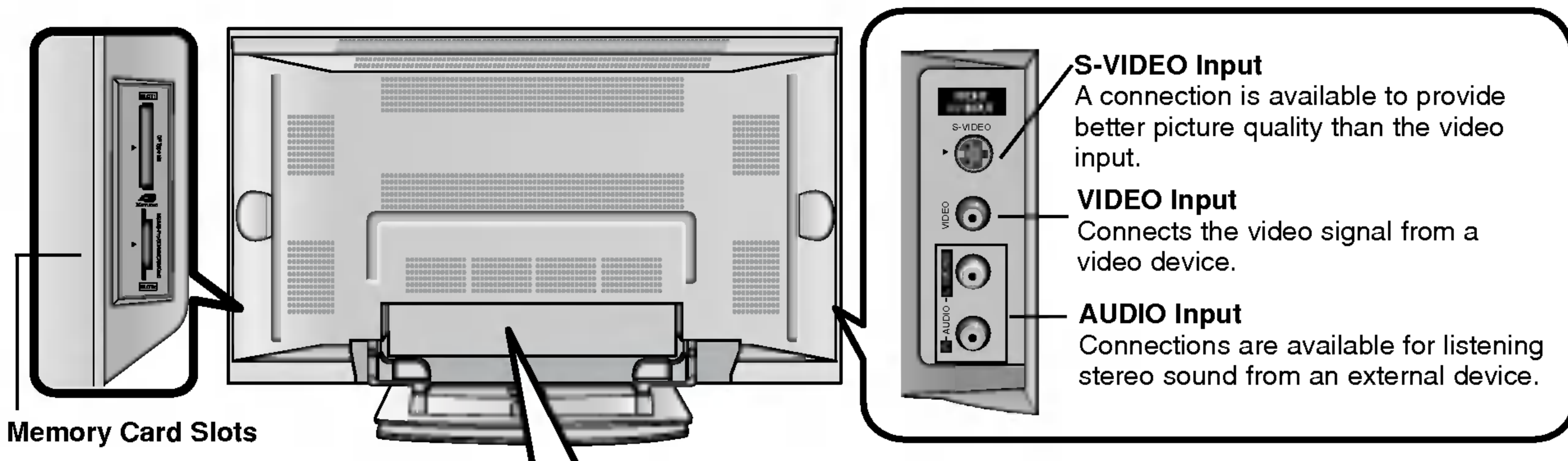

Remote Control Key Functions

- When using the remote control, aim it at the remote control sensor on the TV.

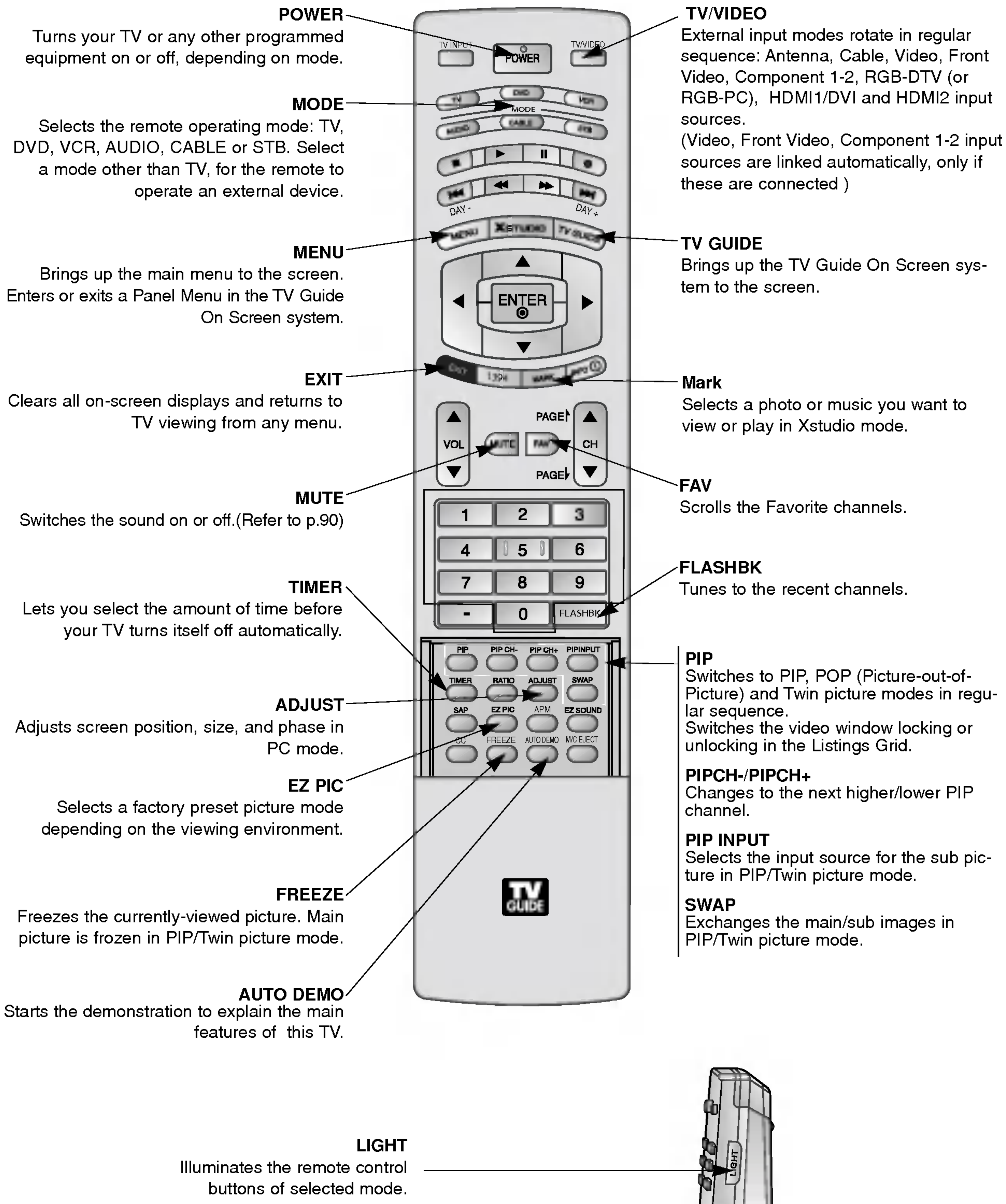

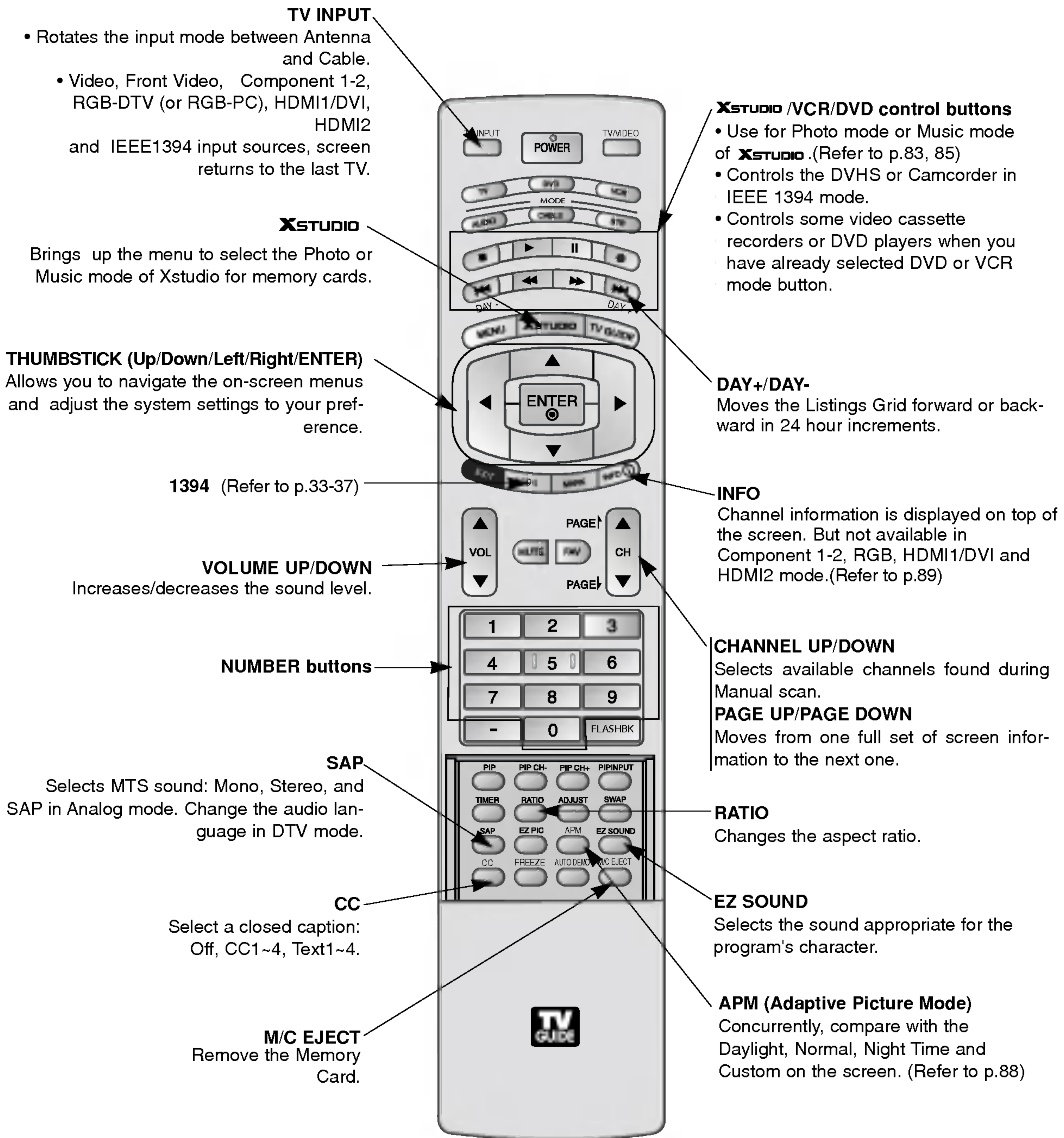

Installing Batteries

- Open the battery compartment cover on the back side and install the batteries matching correct polarity (+ with +, - with -).
- Install two 1.5V AA batteries. Don't mix old or used batteries with new ones. Replace cover.

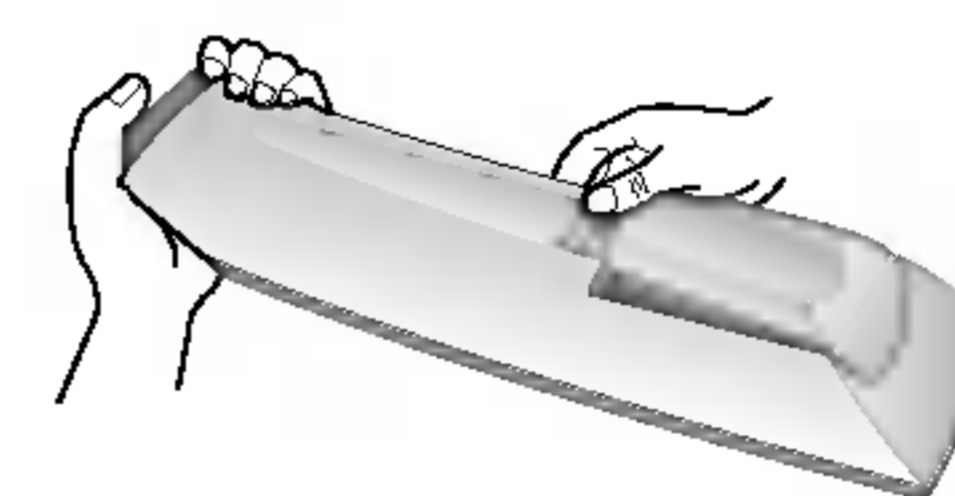

Installation

Accessories

Ensure that the following accessories are included with your plasma display. If an accessory is missing, please contact the dealer where you purchased the product.

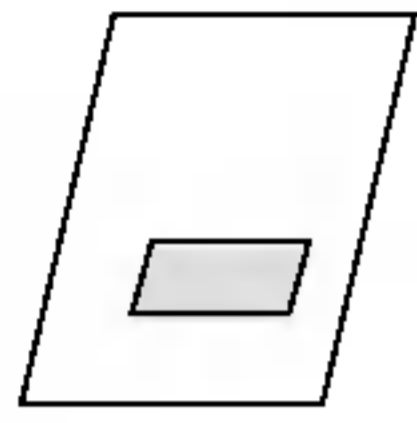

Owner's Manual

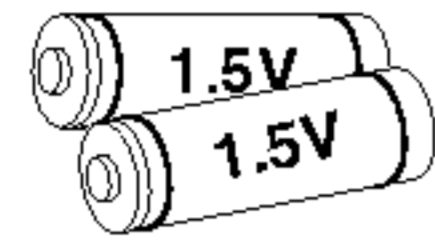

Batteries



Power Cord



Remote Control

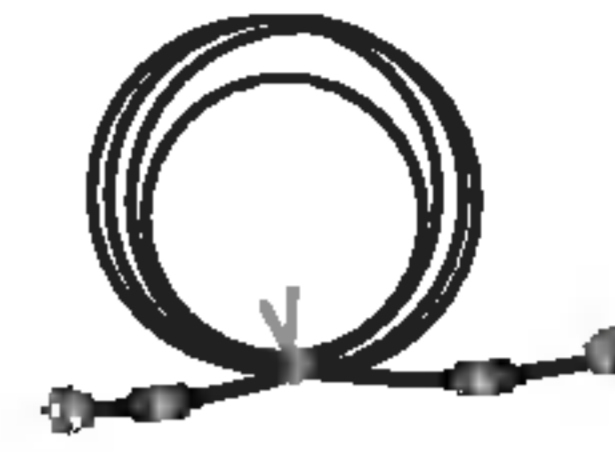

75Ω Round Cable



2-Wall brackets



2-eye-bolts



G-LINK Cable

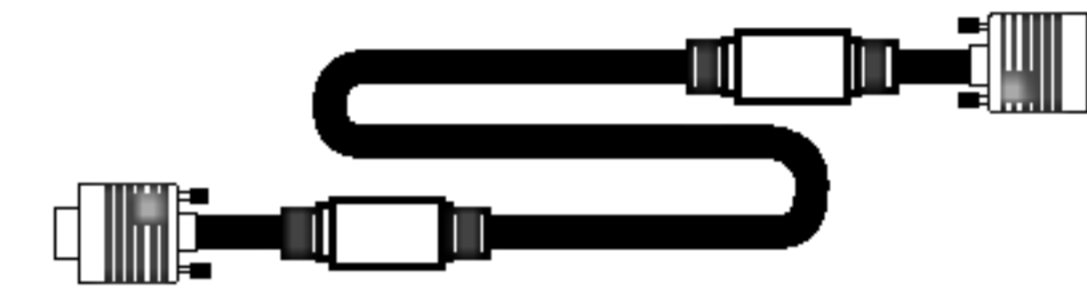

D-sub 15 pin Cable

Installation Instructions

Joining the TV assembly to the wall to protect the set tumbling

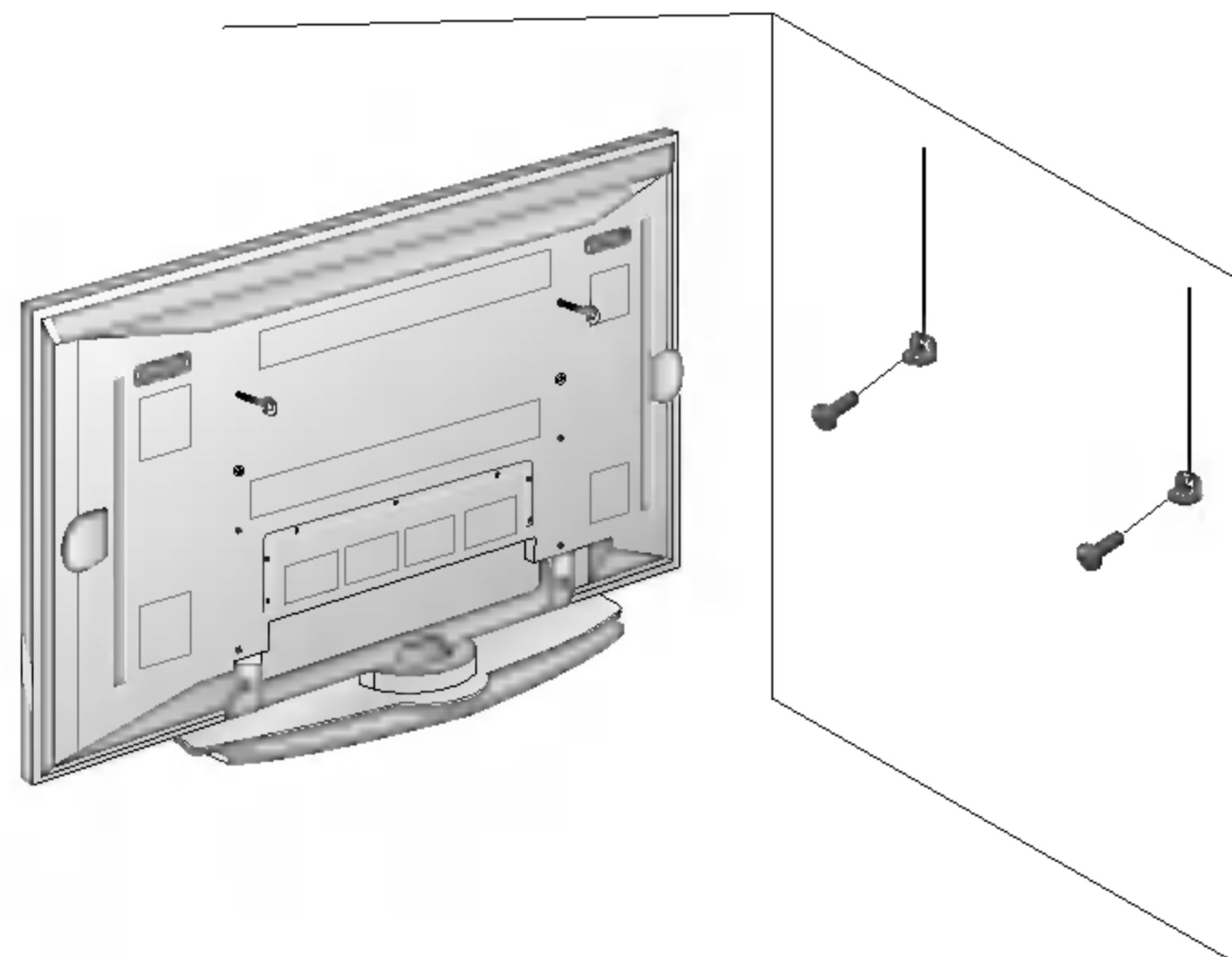

- If the set will be mounted on a desk top, insert the 2 eye-bolts and tighten them securely in the upper holes as shown. Install the wall brackets on the wall with 2 bolts*, (not supplied with the product), as shown. Match the height of the eye-bolts and the wall brackets. Check to be sure the eye-bolts and the brackets are tightened securely.

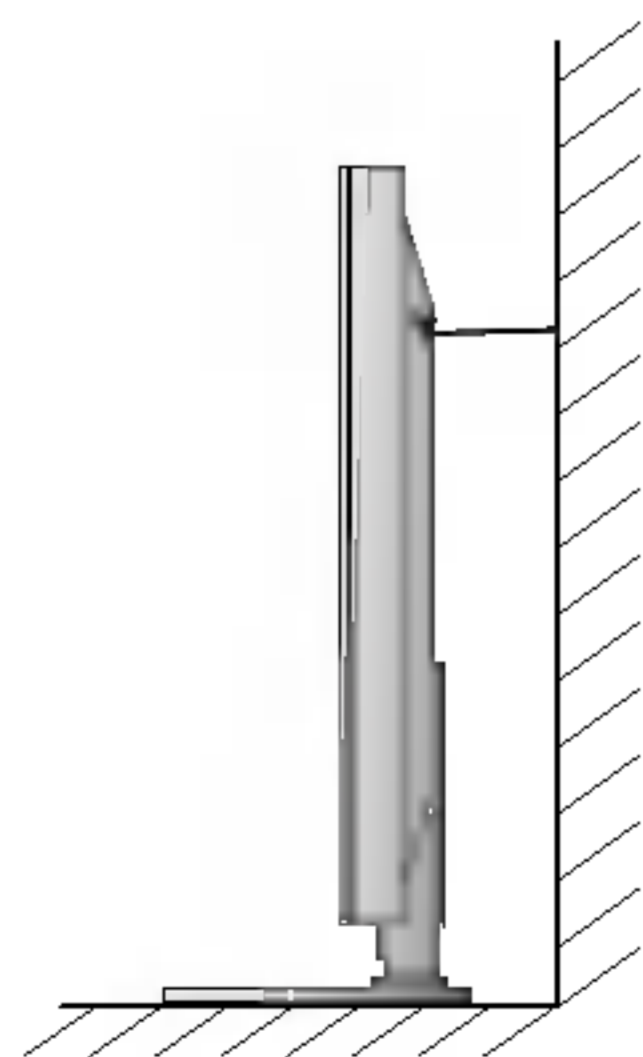

- Secure the TV assembly to the wall with strong strings or wire cables, (not supplied with the product), as shown.

GROUNDING

Ensure that you connect the earth ground wire to prevent possible electric shock. If grounding methods are not possible, have a qualified electrician install a separate circuit breaker. Do not try to ground the unit by connecting it to telephone wires, lightning rods, or gas pipes.

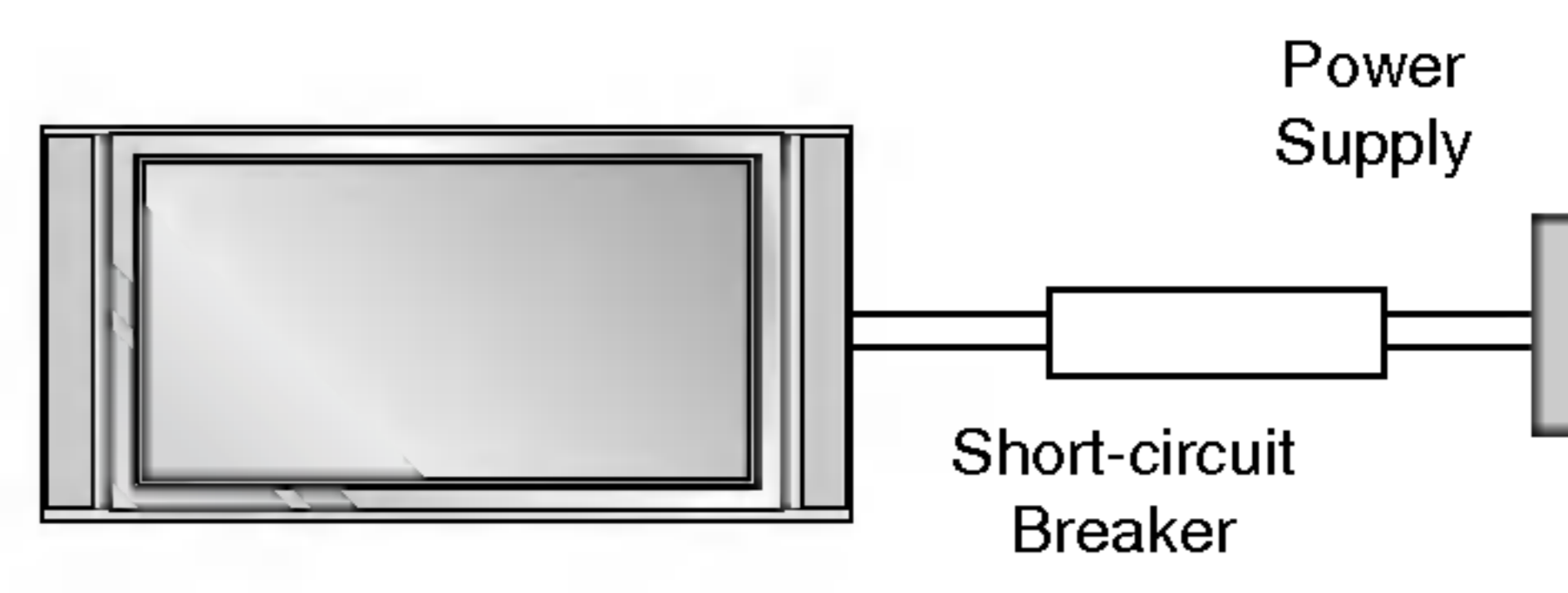

- The TV can be installed in various ways such as on a wall, or on a desktop etc.
- The TV is designed to be mounted horizontally.
- Here shown may be somewhat different from your TV.

Wall Mount: Horizontal installation



For proper ventilation, allow a clearance of 4" on each side and 2" from the wall. Detailed installation instructions are available from your dealer, see the optional Wall Mounting Bracket Installation.

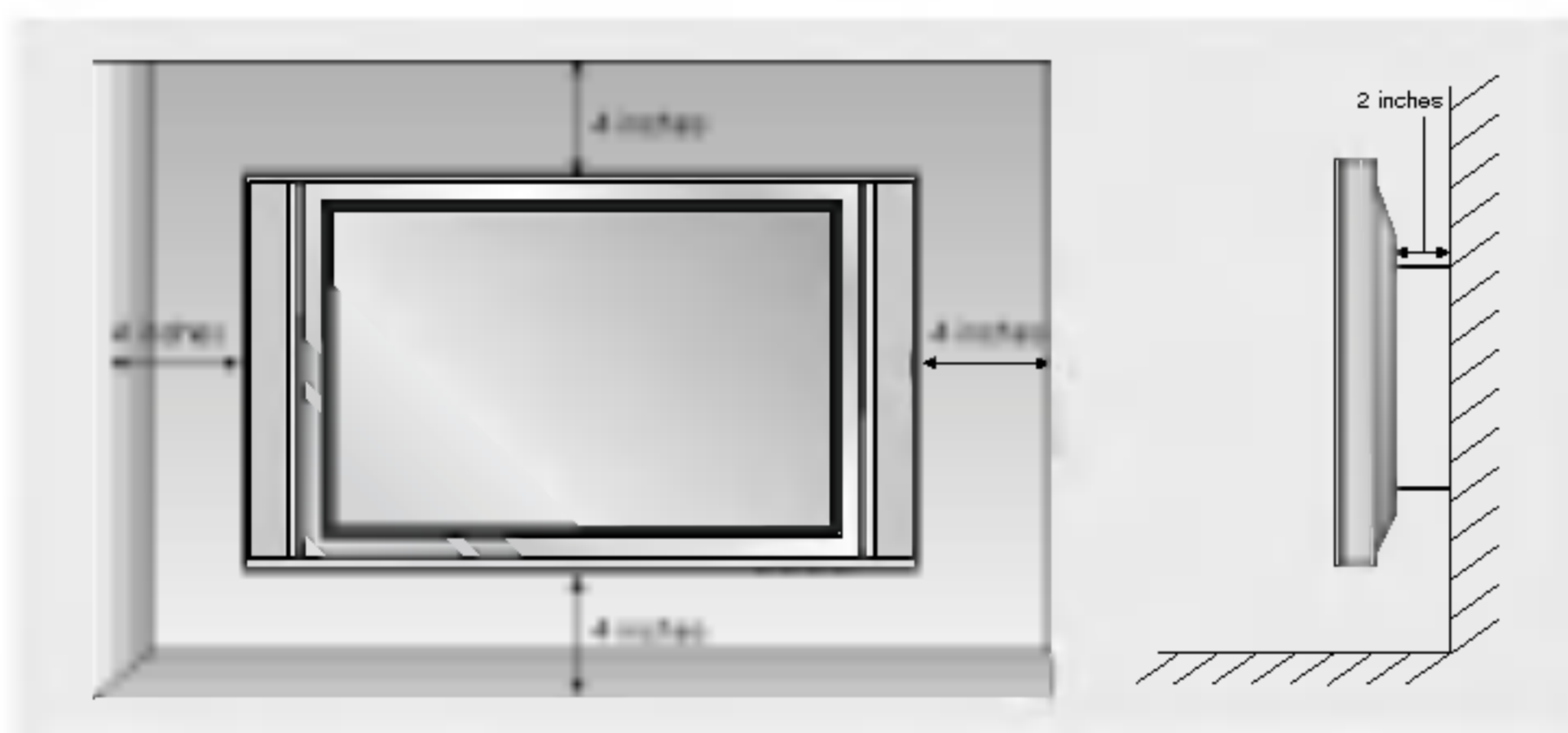

Desktop Pedestal Installation



For proper ventilation, allow a clearance of 4" on each side and the top, 2.36" on the bottom, and 2" from the wall. Detailed installation instructions are included in the optional Desktop Stand Installation.

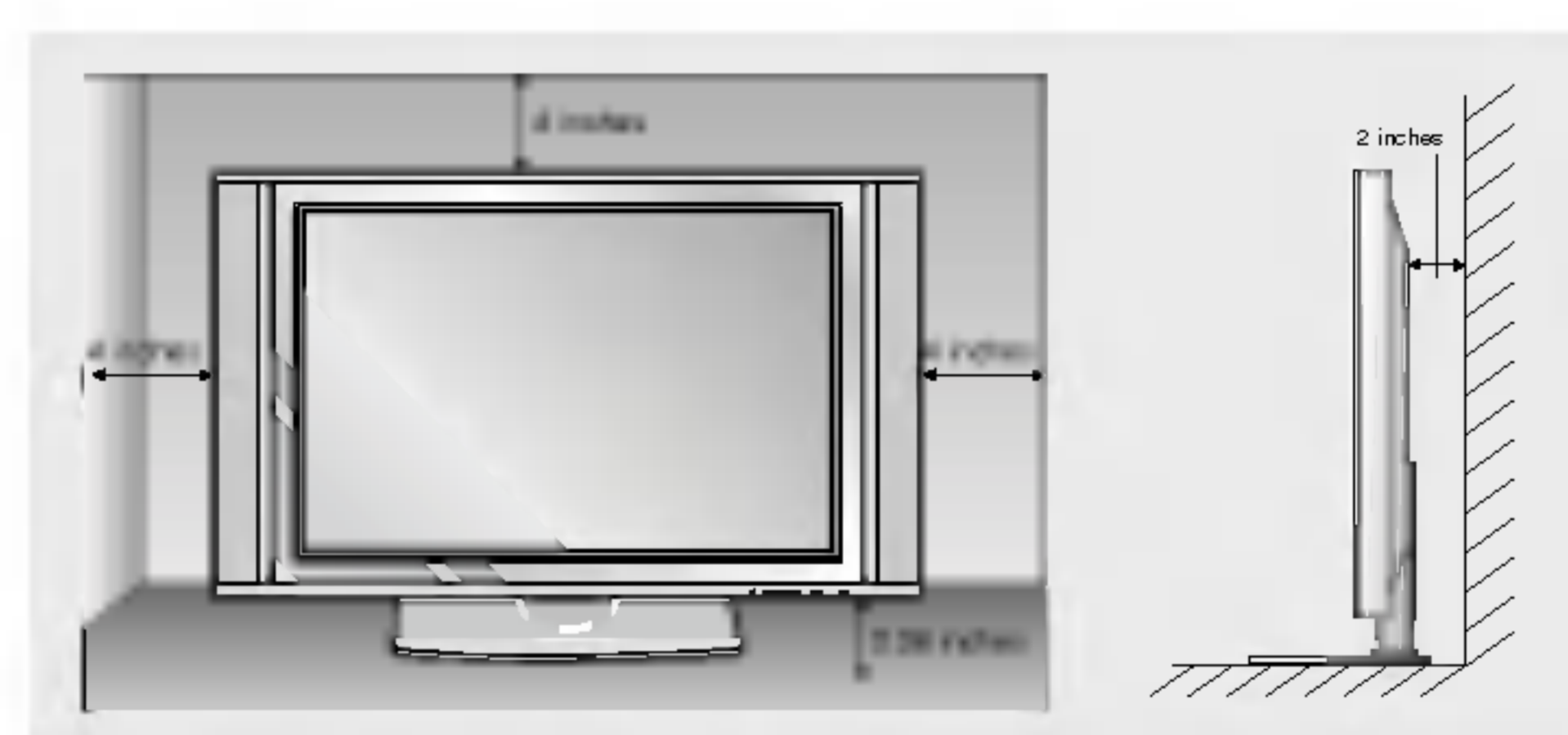

Swivel function

- Swivel stand of 42PX4D/5D models is separately saled.

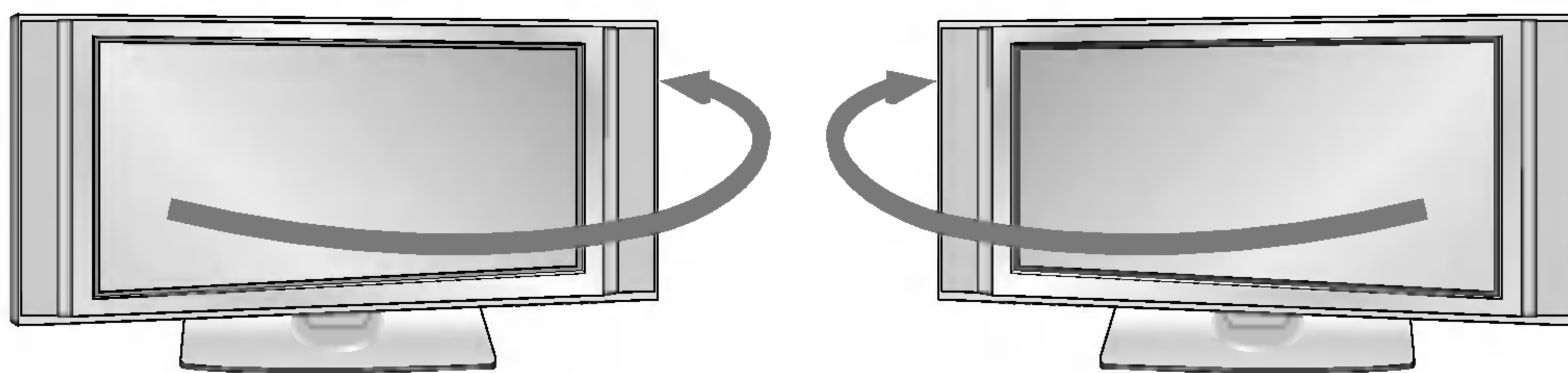

- After installing the TV, you can adjust the the TV set manually to the left or right direction by 20 degrees to suit your viewing position.

Note: Before adjusting the angle, you must loosen (to the left) the shaft bolt on the middle of stand's back. And when stand be level with TV, you must close (to the right) the shaft bolt to set the hole.

External Equipment Connections

Antenna or Cable Connection

1. Analog and Digital TV signals provided on antenna

- Wall Antenna Socket or Outdoor Antenna without a Cable Box Connection
- For optimum picture quality, adjust antenna direction if needed.

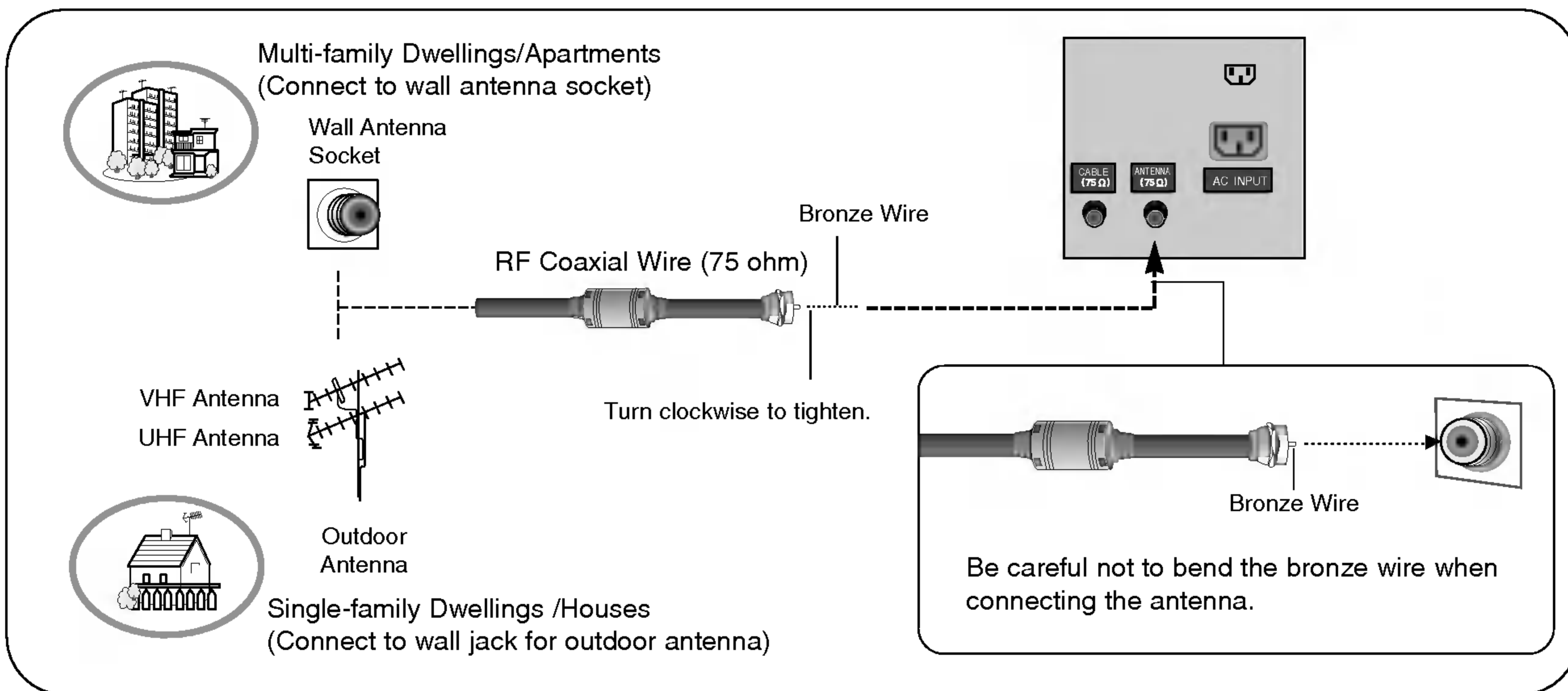

2. Analog and Digital TV signals provided on cable

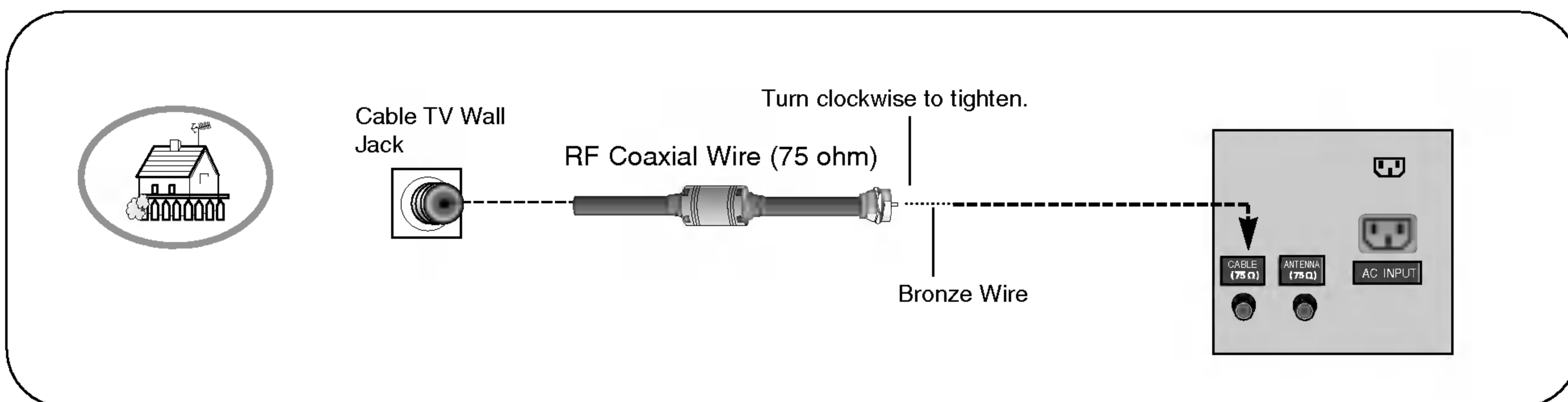

3. Analog and Digital TV signals provided on cable and antenna

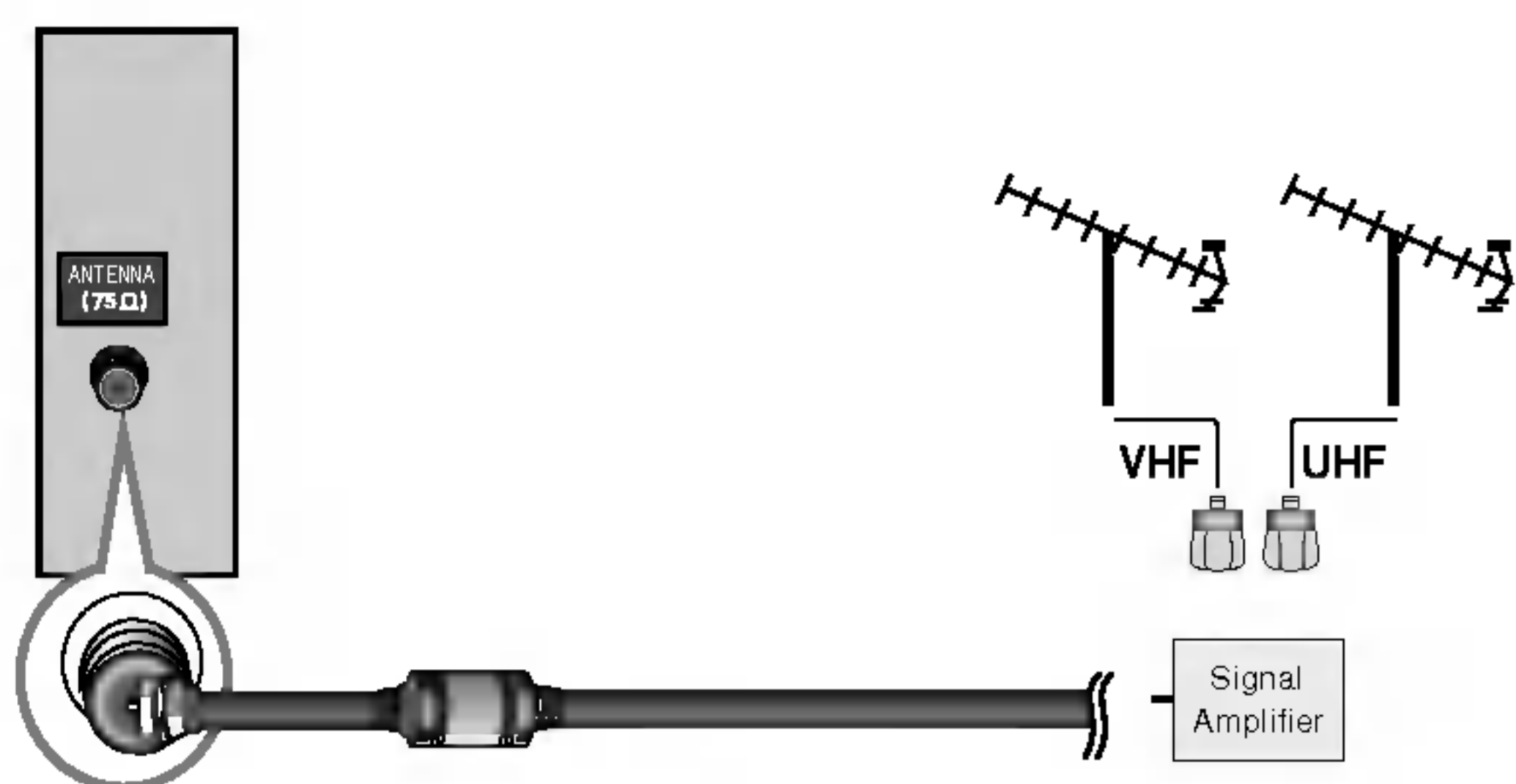
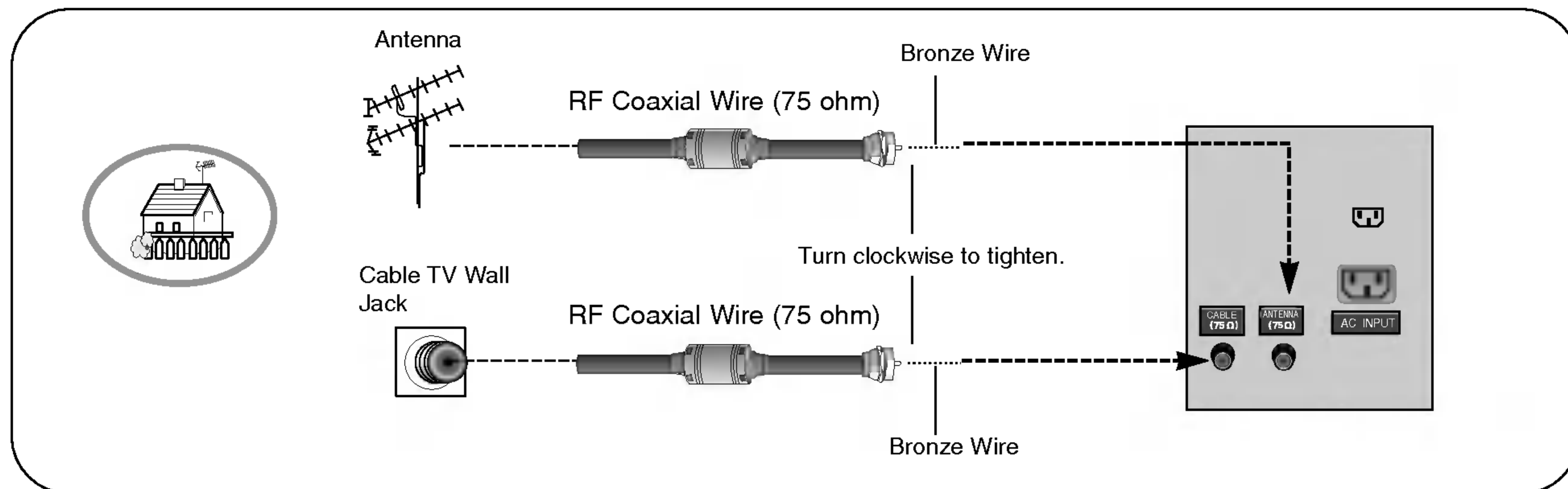

- To improve the picture quality in a poor signal area, please purchase a signal amplifier and install properly.
- If the antenna needs to be split for two TV's, install a "2-Way Signal Splitter" in the connections.
- If the antenna is not installed properly, contact your dealer for assistance.

VCR Setup

- To avoid picture noise (interference), leave an adequate distance between the VCR and TV.
- Use the ISM Method (on the Option menu) feature to avoid having a fixed image remain on the screen for a long period of time. If the 4:3 picture format is used; the fixed images on the sides of the screen may remain visible on the screen.

Connection Option 1

Set VCR output switch to channel 3 or 4 and then tune the TV to the same channel number.

Connection Option 2

1. Connect the audio and video cables from the VCR's output jacks to the TV input jacks, as shown in the figure. When connecting the TV to VCR, match the jack colors (Video = yellow, Audio Left = white, and Audio Right = red). If you connect an S-VIDEO output from VCR to the S-VIDEO input, the picture quality is improved; compared to connecting a regular VCR to the Video input.
2. Insert a video tape into the VCR and press PLAY on the VCR. (Refer to the VCR owner's manual.)
3. Select the input source with using the **TV/VIDEO** button on the remote control. Note that this TV finds the connected input sources automatically for Video, Front Video and Component 1-2. It is presumed that RGB, HDMI1/DVI and HDMI2 sources are connected.

 Do not connect to both Video and S-Video at the same time.

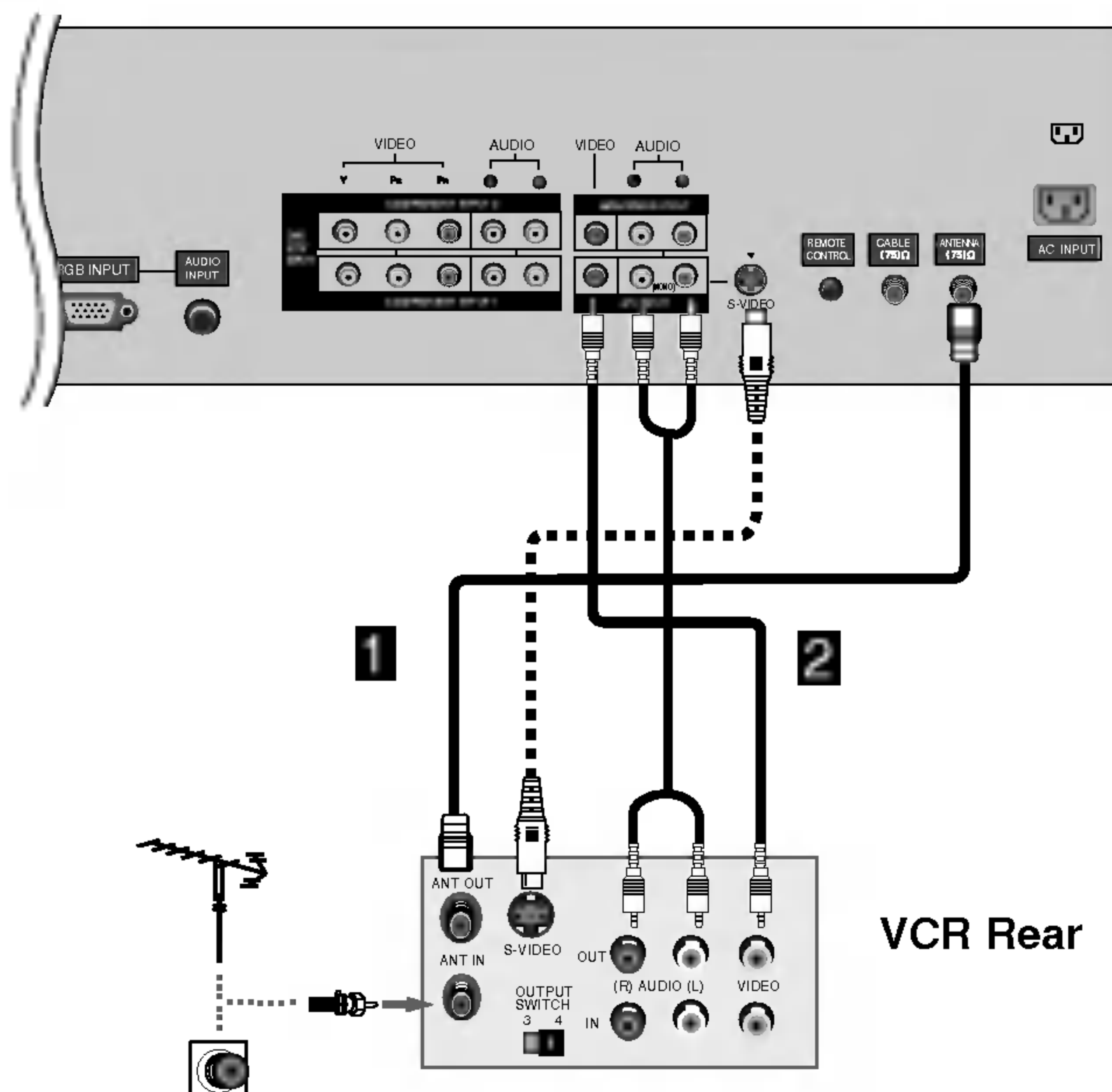

External A/V Source Setup

How to connect

Connect the audio and video cables from the external equipment's output jacks to the TV input jacks, as shown in the figure.

When connecting the TV to external equipment, match the jack colors (Video = yellow, Audio Left = white, and Audio Right = red).

How to use

1. Select the input source with using the **TV/VIDEO** button on the remote control. Note that this TV finds the connected input sources automatically for Video, Front Video and Component 1-2. It is presumed that RGB, HDMI1/DVI and HDMI2 sources are connected.
2. Operate the corresponding external equipment. For connection instructions to operate the TV Guide On Screen system, see page 23~24.

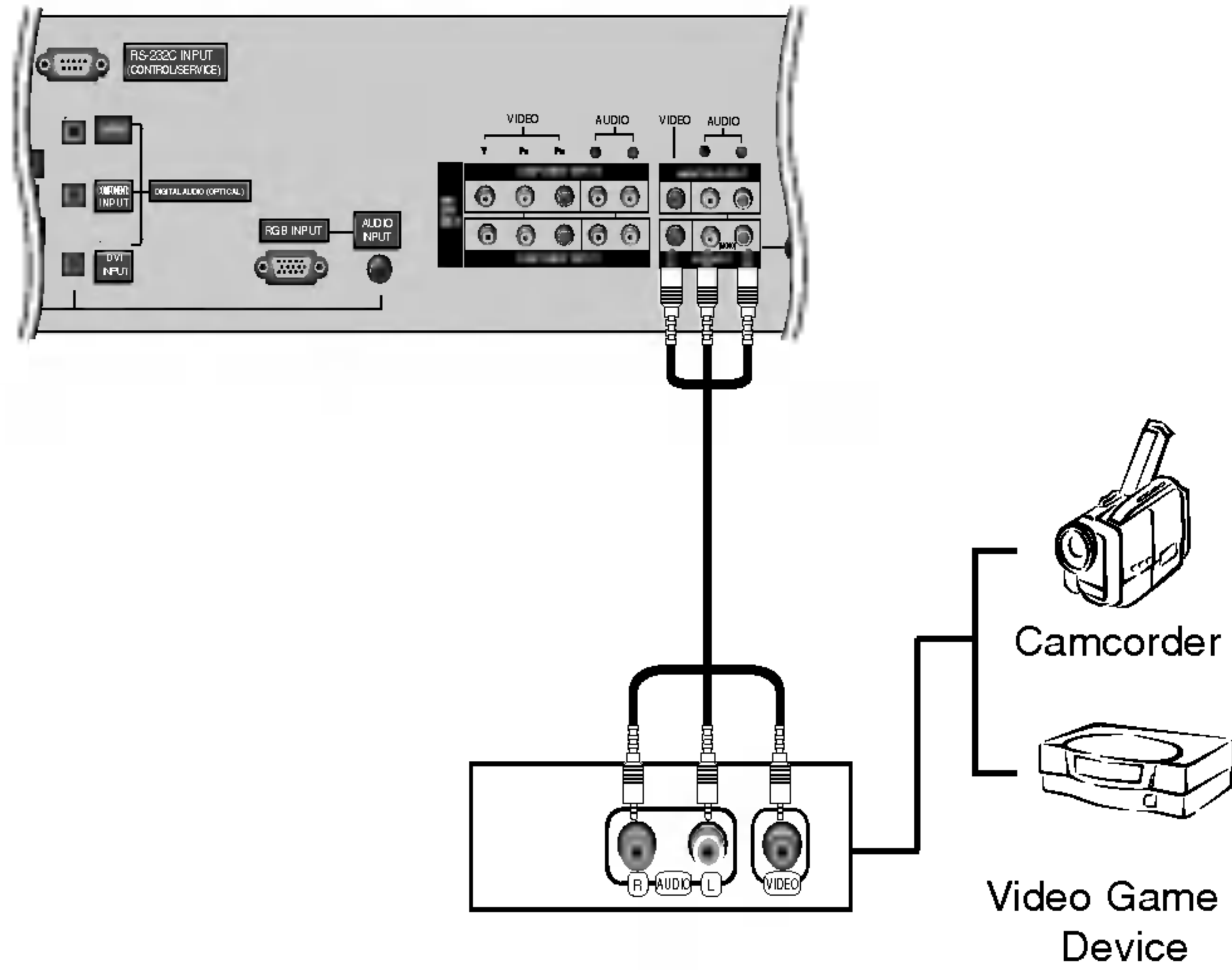

DVD Setup

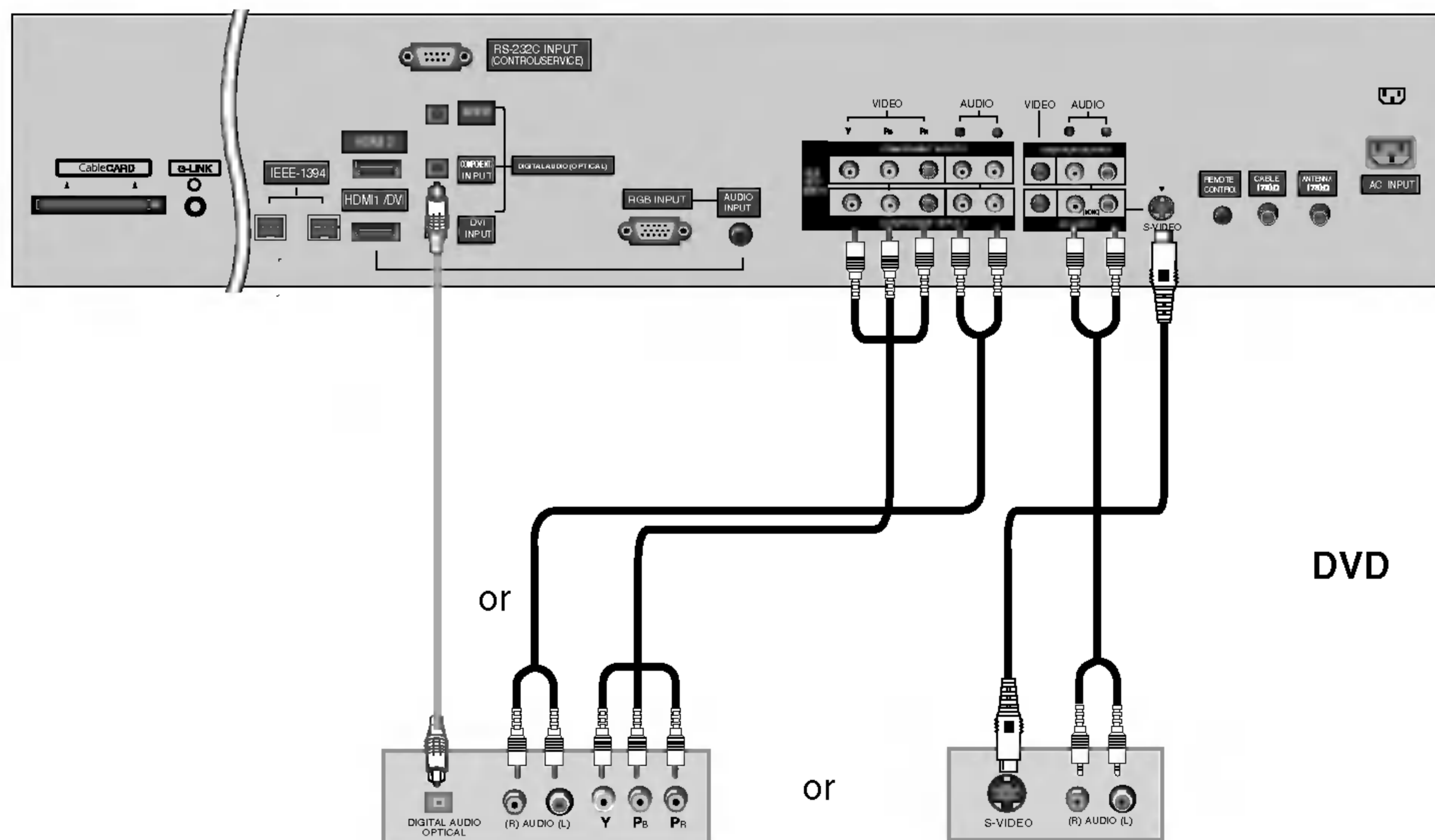

How to connect

1. Connect the DVD video outputs (Y, PB, PR) to the COMPONENT (Y, PB, PR) INPUT jacks on the TV and connect the DVD audio outputs to the AUDIO INPUT jacks on the TV, as shown in the figure.
2. If your DVD only has an S-Video output jack, connect this to the S-VIDEO input on the TV and connect the DVD audio outputs to the AUDIO INPUT jacks on the TV, as shown in the figure.

Note: If your DVD player does not provide component video output, use S-Video output.

How to use

1. Turn on the DVD player and then insert a DVD.
2. Use the **TV/VIDEO** button on the remote control to select **Component 1** or **Component 2**. (If connected to S-VIDEO, select the **Video** or **Front Video** external input source.)
3. Refer to the DVD player's manual for operating instructions.

• Component Input ports

To get better picture quality, connect a DVD player to the component input ports as shown below.

Component ports on the TV	Y	Pb	Pr
Video output ports on DVD player	Y	Pb	Pr
	Y	B-Y	R-Y
	Y	Cb	Cr
	Y	PB	PR

Notes:

- Digital Audio will not work for Component 1 input source.
- Digital Audio operation has priority if Digital Audio and AUDIO L/R are connected at the same time.

CableCARD™ Setup

How to use

Insert the CableCARD™ received from the cable service provider to the CableCARD™ slot of TV back panel.

If the pairing information about this TV and the CableCARD is automatically displayed on the screen, contact with the cable service provider.

Note :

- CableCARD™ have the types of Motorola, Scientific Atlanta, SCM etc.. These 3 types of CableCARD™ can be used for this PLASMA TV.



Caution: When removing the CableCARD™, do not drop it as this may cause damage to the CableCARD™.

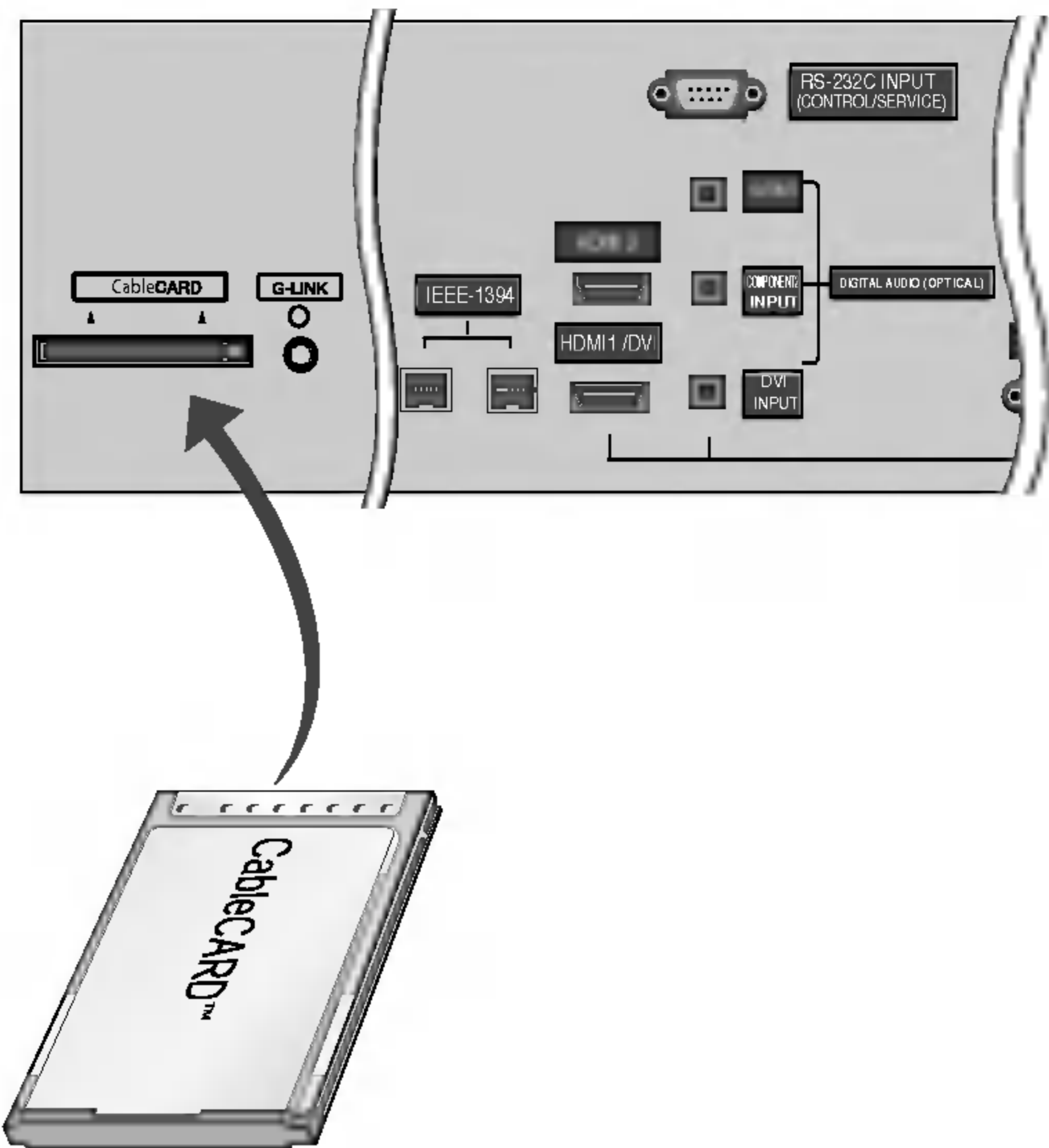

HDSTB Setup

- This TV can receive Digital Over-the-air/Cable signals without an external digital set-top box. However, if you do receive Digital signals from a digital set-top box or other digital external device, refer to the figure as shown below.
- This TV supports HDCP (High-bandwidth Digital Contents Protection) protocol for Digital Contents (480p,720p,1080i).

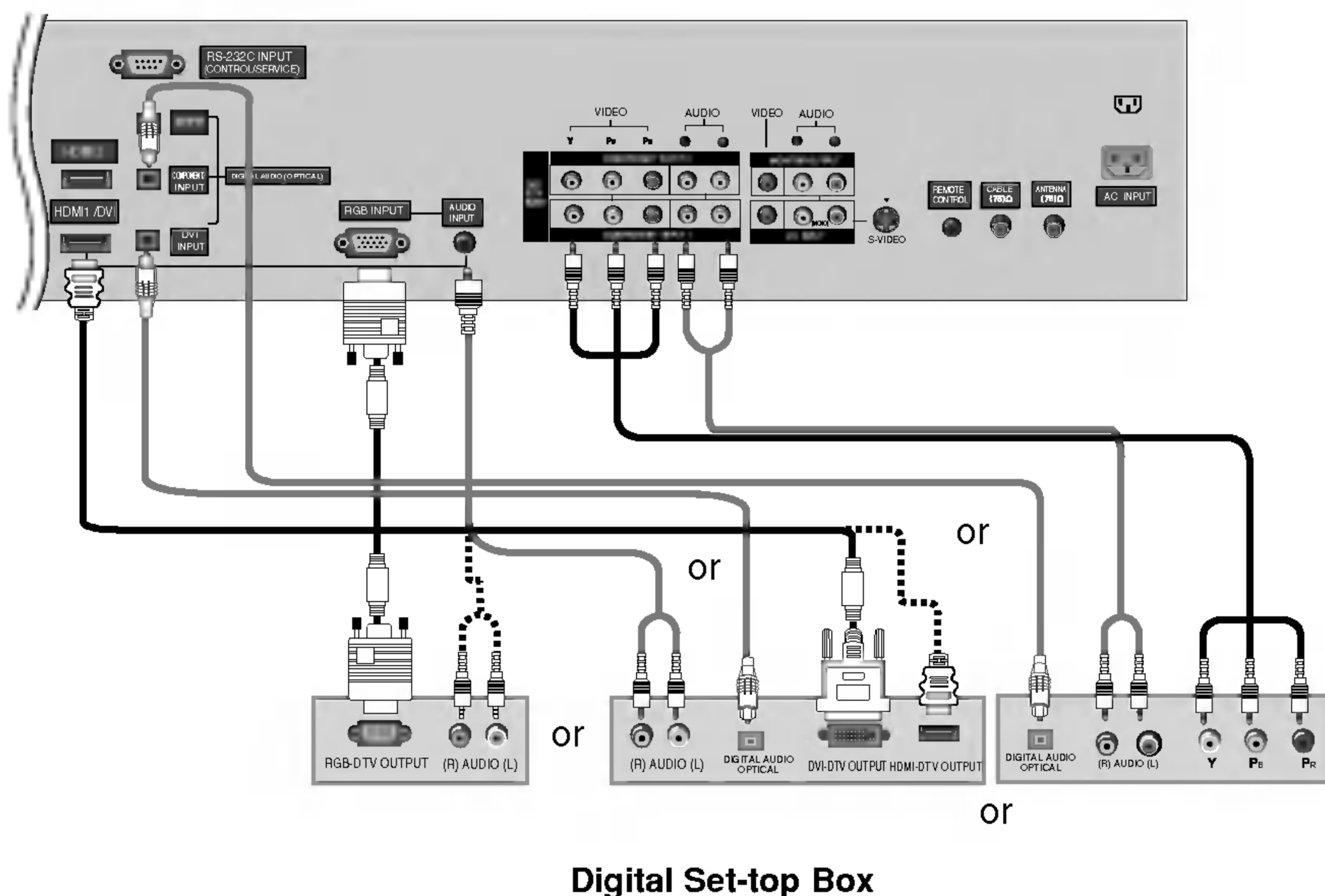

How to connect

Use the TV's COMPONENT (Y, PB, PR) INPUT, RGB, HDMI1/DVI or HDMI2 jack for video connections, depending on your set-top box connector. Then, make the corresponding audio connections.

How to use

1. Turn on the digital set-top box. (Refer to the owner's manual for the digital set-top box.)
2. Use **TV/VIDEO** on the remote control to select **Component 1**, **Component 2**, **RGB-DTV**, or **HDMI1/DVI**, **HDMI2** source.

Signal	Component 1/2	RGB-DTV,HDMI1/DVI,HDMI2
480i	Yes	No
480p	Yes	Yes
720p	Yes	Yes
1080i	Yes	Yes

PC Setup

- This TV provides Plug and Play capability, meaning that the PC adjusts automatically to the TV's settings.
- The TV perceives 640x480, 60Hz as DTV 480p based on the PC graphic card, change the screen scanning rate for the graphic card accordingly.

<When the PC supports DVI>

How to connect

1. Connect the PC to HDMI1/DVI port of this TV with an HDMI-to-DVI cable(not supplied with this product).
If you do not need to connect audio, HDMI2 port is also available for the DVI video connection.
2. If the PC(or the sound card of the PC) has a fiber optic digital audio output connector, connect the PC's audio output to DIGITAL AUDIO(OPTICAL) port for DVI INPUT.
3. If the PC(or the sound card of the PC) has an analog audio output connector, connect the PC's audio output to AUDIO INPUT port located on the right side of RGB INPUT port.

How To Use

1. To get the best picture quality, adjust the PC graphics card to 1024x768, 60Hz.
2. Select HDMI1/DVI input source in main input option of SETUP menu.(Refer to P.64)
TV/VIDEO button is also available for this purpose.
3. Check the image on your TV. There may be noise associated with the resolution, vertical pattern, contrast or brightness in PC mode. If noise is present, change the PC output to another resolution, change the refresh rate to another rate or adjust the brightness and contrast on the VIDEO menu until the picture is clear. If the refresh rate of the PC graphic card can not be changed, change the PC graphic card or consult the manufacturer of the PC graphic card.

<When the PC supports RGB>

How to connect

1. Connect the PC to RGB INPUT port of this TV with a RGB cable(not supplied with this product).
2. If the PC(or the sound card of the PC) has an analog audio output connector, connect the PC's audio output to AUDIO INPUT port located on the right side of RGB INPUT port.

How To Use

1. To get the best picture quality, adjust the PC graphics card to 1024x768, 60 Hz.
2. Select **RGB-PC** input source in main input option of SETUP menu.(Refer to P.64)
Once you select **RGB-PC** in main input option of SETUP menu, **TV/VIDEO** button is also available for this purpose.
3. Check the image on your TV. There may be noise associated with the resolution, vertical pattern, contrast or brightness in PC mode. If noise is present, change the PC output to another resolution, change the refresh rate to another rate or adjust the brightness and contrast on the VIDEO menu until the picture is clear. If the refresh rate of the PC graphic card can not be changed, change the PC graphic card or consult the manufacturer of the PC graphic card.

Monitor Display Specifications (RGB-PC)

Resolution	Horizontal Frequency(KHz)	Vertical Frequency(Hz)	Resolution	Horizontal Frequency(KHz)	Vertical Frequency(Hz)
720x400	31.469	70.08	800x600	35.156	56.25
	37.927	85.03		37.879	60.31
640x480	31.469	59.94		48.077	72.18
				46.875	75.00
	37.861	72.80		53.674	85.06
	37.500	75.00		1024x768	48.363
	43.269	85.00	56.476		70.06
			60.023	75.02	

Monitor Display Specifications (HDMI/DVI Mode)

Resolution	Horizontal Frequency(KHz)	Vertical Frequency(Hz)	Resolution	Horizontal Frequency(KHz)	Vertical Frequency(Hz)
640x480	31.469	59.94	1024x768	48.363	60.00
	37.861	72.80		56.476	70.06
	37.500	75.00		60.023	75.02
800x600	35.156	56.25			
	37.879	60.31			
	48.077	72.18			
	46.875	75.00			

Monitor Out Setup

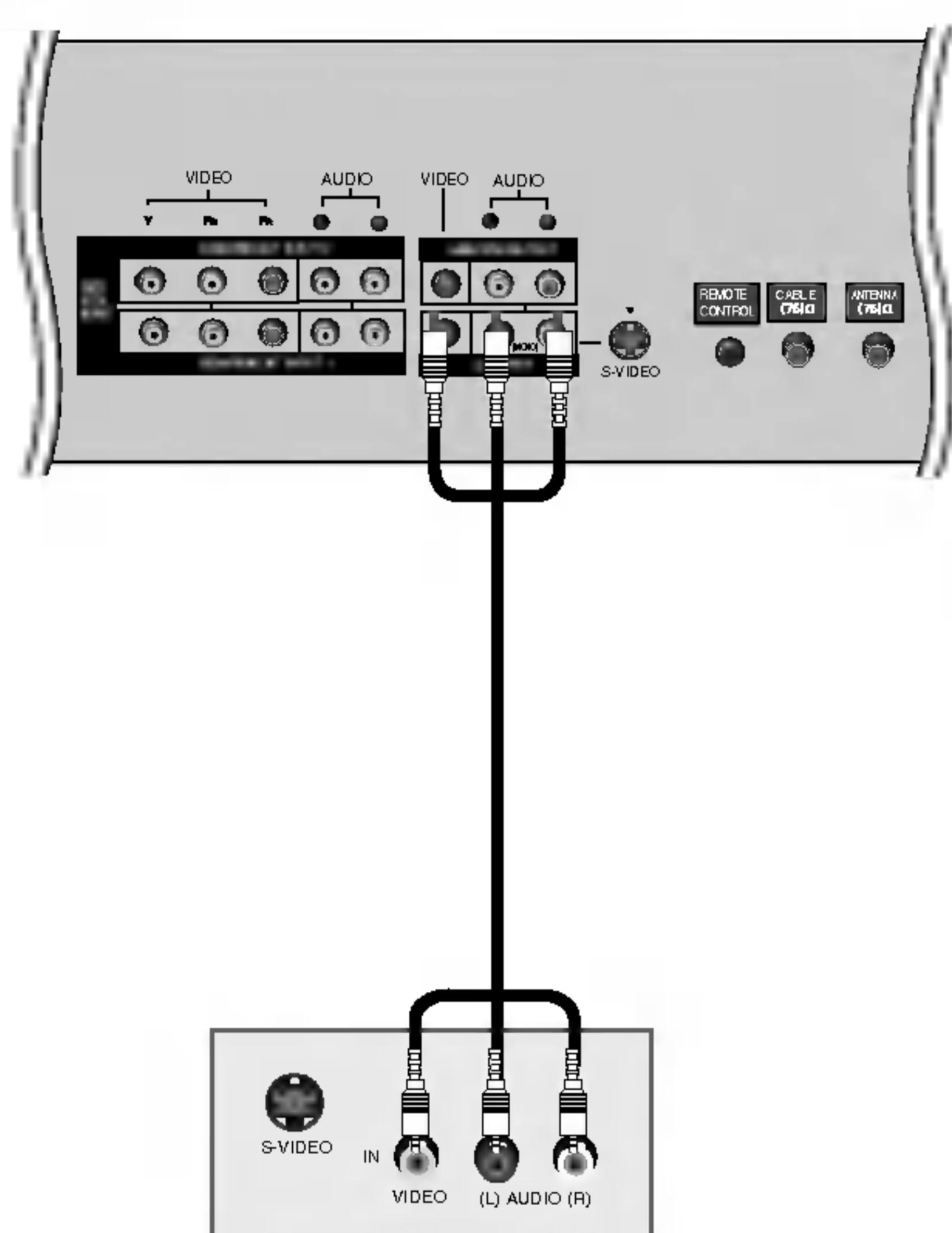

The TV has a special signal output capability which allows you to hook up the second TV or monitor.

Connect the second TV or monitor to the TV's MONITOR OUTPUT. See the Operating Manual of the second TV or monitor for further details regarding the device's input settings.

Notes:

- Component 1-2, RGB-PC/RGB-DTV, HDMI1/DVI, HDMI2, DTV input sources cannot be used for Monitor out.
- When connecting with external audio equipments, such as amplifiers or speakers, please turn the TV speakers off. (Refer to p.67)
- We recommend to use the video and audio output jacks for VCR recording.

Digital Audio Output

Send the TV's audio to external audio equipment (stereo system) via the Digital Audio Output (Optical) port.

How to connect

1. Connect one end of an optical cable to the TV Digital Audio (Optical) Output port.
2. Connect the other end of the optical cable to the digital audio (optical) input on the audio equipment.

See the external audio equipment instruction manual for operation.

Note: When connecting with external audio equipments, such as amplifiers or speakers, please turn the TV speakers off. (Refer to p.67)



Caution: Do not look into the optical output port. Looking at the laser beam may damage your vision.

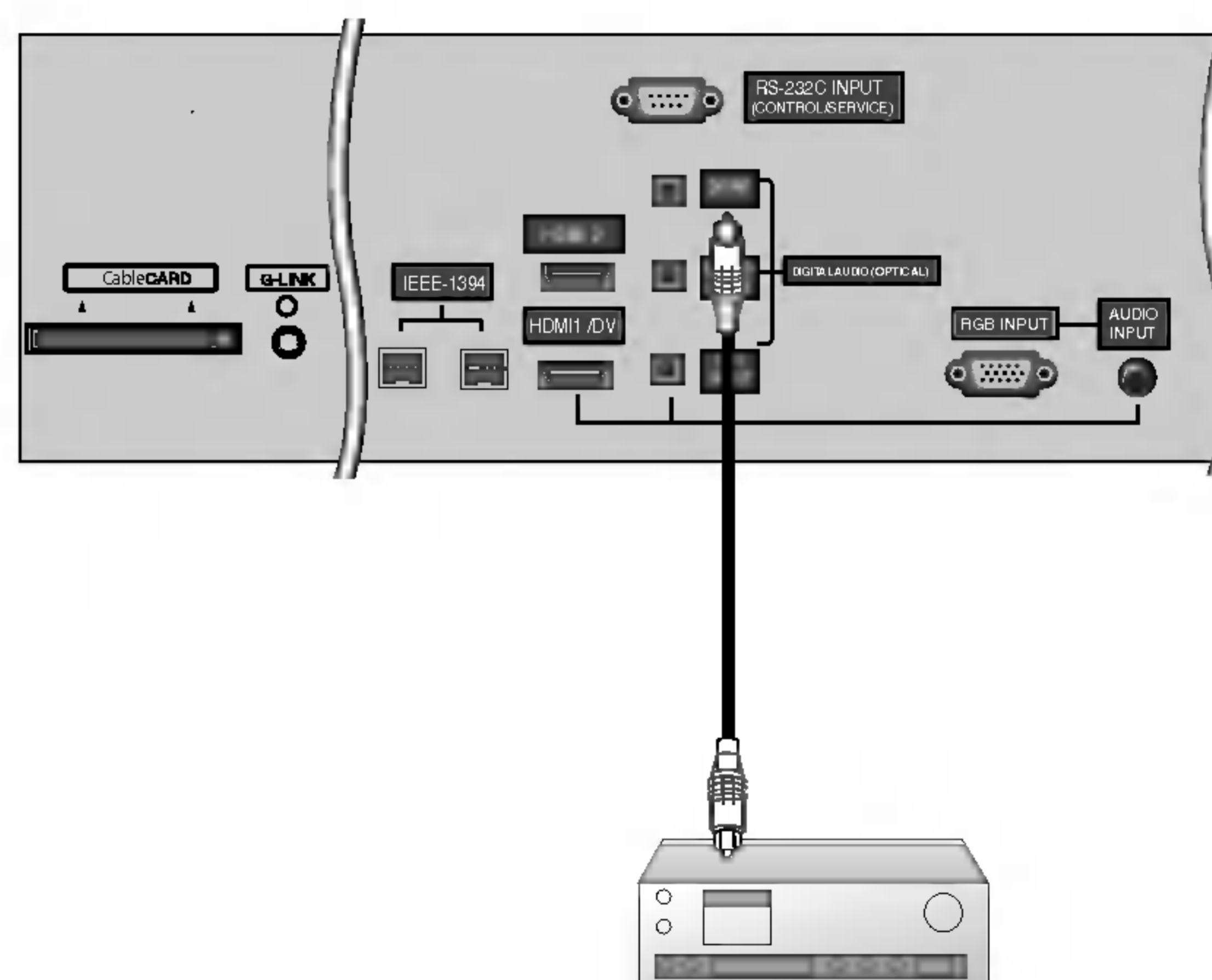

HDMI



- HDMI™, the HDMI logo and High-Definition Multimedia Interface is a trademark or registered trademark of HDMI Licensing.
- This TV can receive the High-Definition Multimedia Interface(HDMI) or the Digital Visual Interface(DVI).
- This TV supports HDCP(High-bandwidth Digital Contents Protection) Protocol for 720x480p, 1280x720p, and 1920x1080i resolution.
- When you connect this TV with a source device(DVD player, Set Top Box or PC) supporting Auto HDMI/DVI function, the output resolution of the source device will be automatically set to 1280x720p.
- If the source device does not support Auto HDMI/DVI, you need to set the output resolution appropriately.
To get the best picture quality, adjust the DVD Player or Set Top Box's output resolution to 1280x720p, and the PC graphics card's output resolution to 1024x768, 60Hz.
- If the source device has an HDMI output, no other audio connection is necessary because HDMI-to-HDMI connection includes both video and audio.
- If the source device has a DVI output and no HDMI output, a separated audio connection is necessary.

<When the source device(DVD player or Set Top Box) supports HDMI>

How To Connect

1. Connect the source device to HDMI1/DVI or HDMI2 port of this TV with an HDMI cable(not supplied with this product).
2. No separated audio connection is necessary.

How To Use

- If the source device supports Auto HDMI function, the output resolution of the source device will be automatically set to 1280x720p.
- If the source device does not support Auto HDMI, you need to set the output resolution appropriately.
To get the best picture quality, adjust the output resolution of the source device to 1280x720p.
- Select HDMI1/DVI or HDMI2 input source in main input option on the SETUP menu.(Refer to P.64)
TV/VIDEO button is also available for this purpose.

<When the source device(DVD player or Set Top Box) supports DVI>

How To Connect

1. Connect the source device to HDMI1/DVI port of this TV with a HDMI-to-DVI cable(not supplied with this product).
Do not use HDMI2 port for DVI connection if you want to connect audio.
2. A separated audio connection is necessary.
3. If the source device has a fiber optic digital audio output, connect the audio output to DIGITAL AUDIO(OPTICAL) port for DVI INPUT.
4. Connect the PC's audio output to AUDIO INPUT port located on the right side of RGB INPUT port.

How To Use

- If the source device supports Auto DVI function, the output resolution of the source device will be automatically set to 1280x720p.
- If the source device does not support Auto DVI, you need to set the output resolution appropriately.
To get the best picture quality, adjust the output resolution of the source device to 1280x720p.
- Select HDMI1/DVI input source in main input option on the SETUP menu.(Refer to P.64)
TV/VIDEO button is also available for this purpose.

Reference

Cable sample

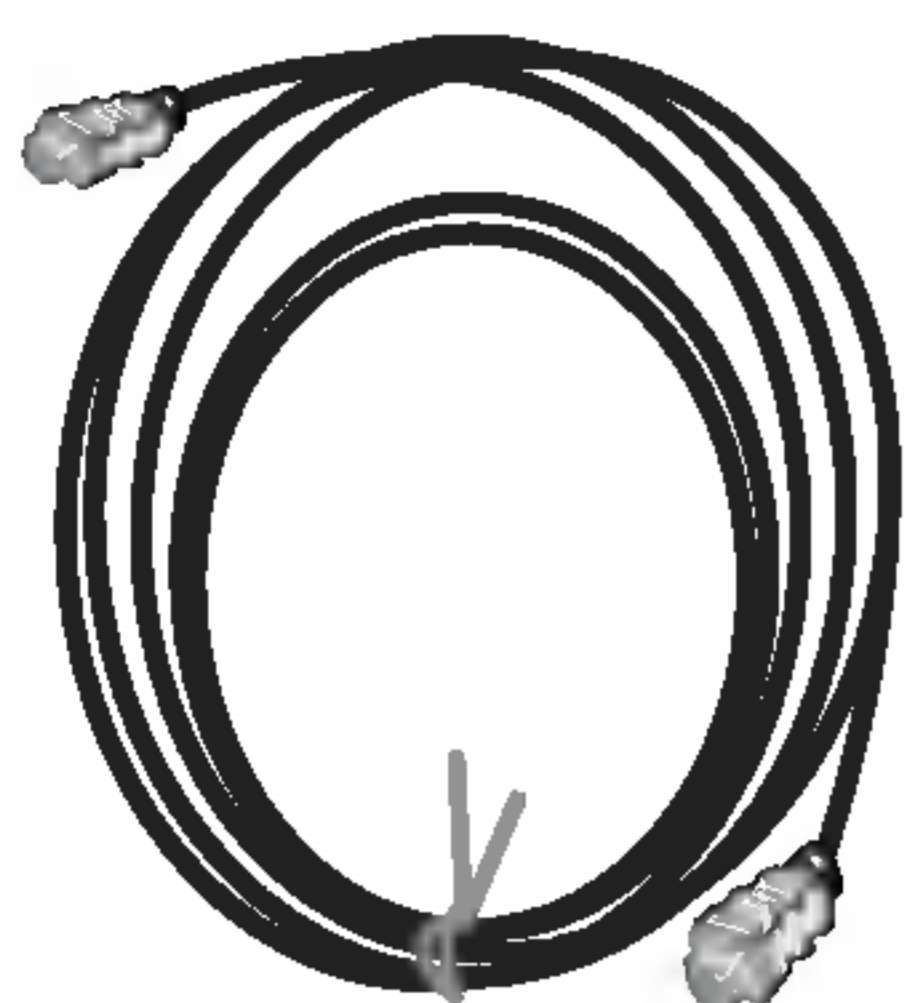

HDMI Cable
(not supplied with the product)

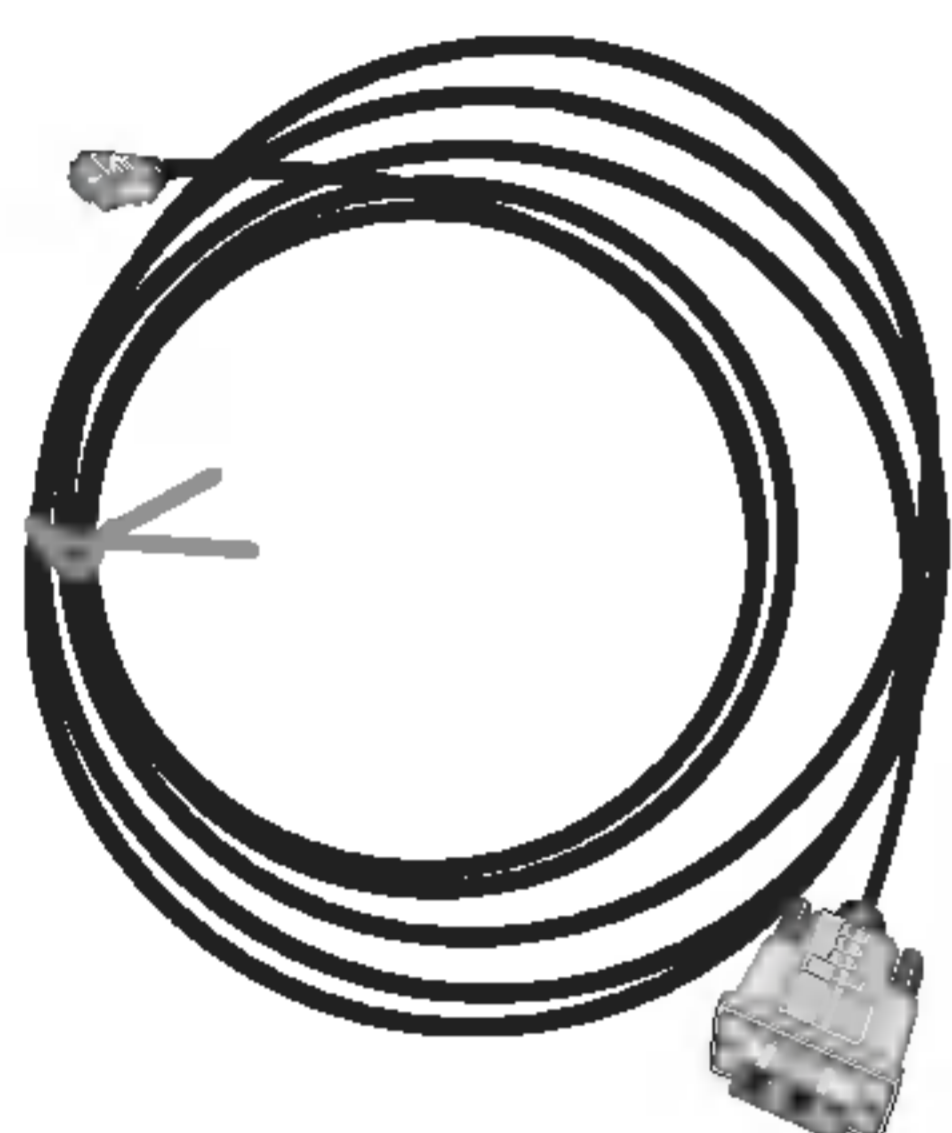

HDMI to DVI Cable
(not supplied with the product)



Fiber Optic Digital Audio Cable
(not supplied with the product)



Analog Audio Cable(RCA type)
(not supplied with the product)



Analog Audio Cable(Stereo to RCA type)
(not supplied with the product)

How to use

1. Connect the HDMI1/DVI Source Devices(DVD Player or Set Top Box or PC) and the TV SET.
2. Turn on the display by pressing the POWER button on the TV SET and HDMI1/DVI Source Devices remote control.
3. Select HDMI1/DVI Input source in Main Input option on the SETUP menu.(Refer to P.64)
4. Check the image on your TV SET. There may be noise associated with the resolution, vertical pattern, contrast or brightness in HDMI1/DVI Source Devices. If noise is present, change the HDMI1/DVI Source Devices to another resolution, change the refresh rate or adjust the brightness and contrast on the menu until the picture is clear. If the refresh rate of the PC graphics card can not be changed, change the PC graphics card or consult the manufacturer of the PC graphics card.

Notes:

- Depending on the graphics card, DOS mode may not work if a HDMI to DVI Cable is in use.
- Avoid keeping a fixed image on the screen for a long period of time. The fixed image may become permanently imprinted on the screen. Use the Orbiter feature on the ISM Method menu.
- When Source Devices connected with HDMI1/DVI Input, output PC Resolution(VGA, SVGA, XGA), Position and Size may not fit to Screen. As shown in the picture below, press the **ADJUST** button to adjust the screen Position of TV SET and contact a PC graphics card service center.
- When Source Devices connected with HDMI1/DVI Input, output TV SET Resolution(480p, 720p, 1080i) and TV SET Display fit EIA/CEA-861-B Specification to Screen. If not, refer to the Manual of HDMI1/DVI Source Devices or contact your service center.
- In case HDMI1/DVI Source Devices is not connected Cable or poor cable connection, "NO SIGNAL" OSD display in HDMI1/DVI Input. In case that Video Resolution is not supported TV SET output in HDMI1/DVI Source Devices, "INVALID FORMAT" OSD display. Refer to the Manual of HDMI1/DVI Source Devices or contact your service center.

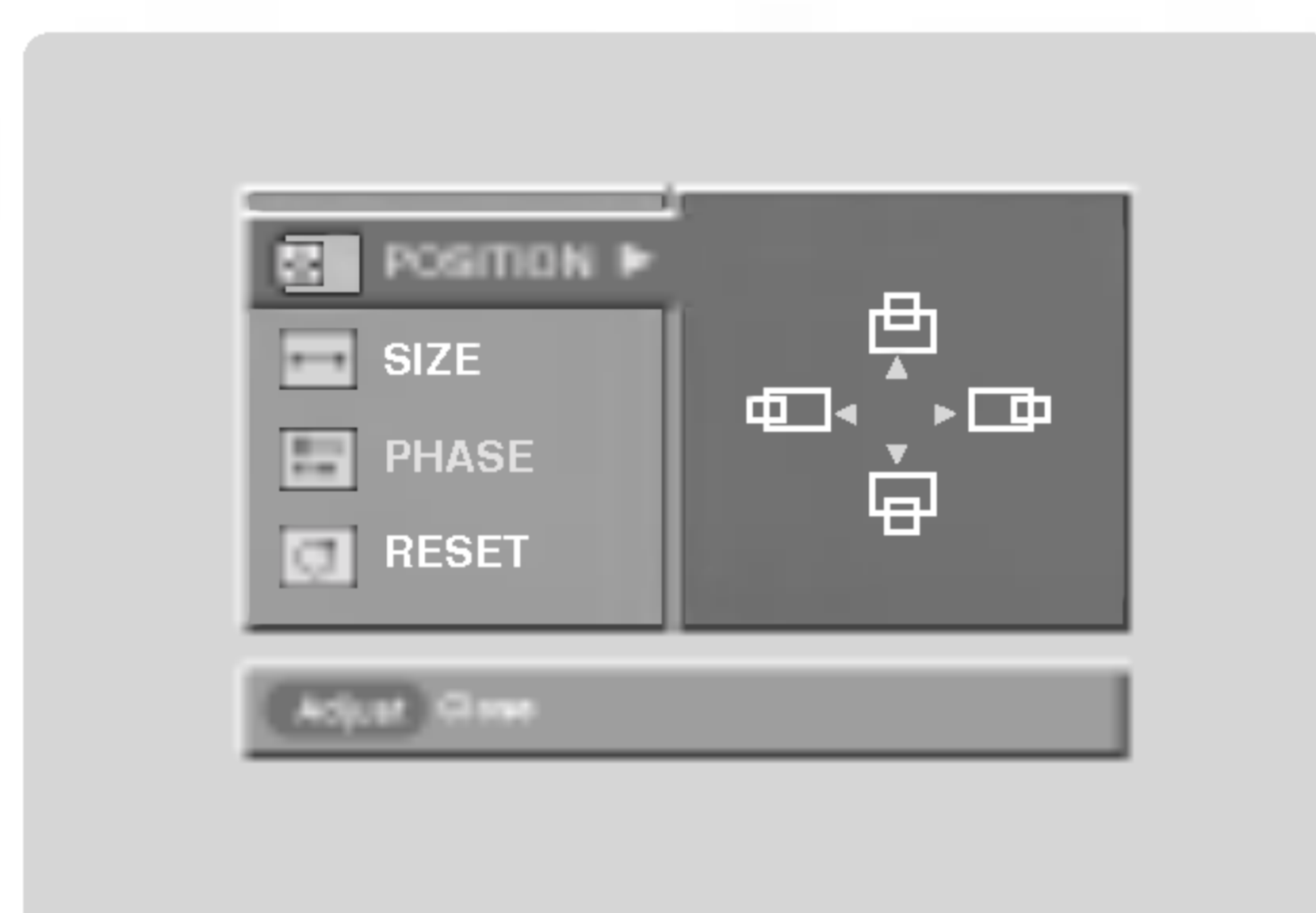
**PC mode****In This Mode, the Supported TV SET Resolution Specification**

- 1920 x 1080 I @ 59.94Hz / 60Hz, 16:9
- 1280 x 720 P @ 59.94Hz / 60Hz, 16:9(preferred format)
- 720 x 480 P @ 59.94Hz / 60Hz, 16:9
- 720 x 480 P @ 59.94Hz / 60Hz, 4:3

In This Mode, the Supported PC Resolution Specification

- 640 x 480 @ 60Hz
- 640 x 480 @ 72Hz
- 640 x 480 @ 75Hz
- 800 x 600 @ 56Hz
- 800 x 600 @ 60Hz
- 800 x 600 @ 72Hz
- 800 x 600 @ 75Hz
- 1024 x 768 @ 60Hz(preferred format)
- 1024 x 768 @ 70Hz
- 1024 x 768 @ 75Hz

TV Guide On Screen Setup

- The TV Guide On Screen system uses Setup information to provide you with show listings and lineups in your area—which are updated several times a day.
- Once you set up the TV according to manufacturer's instructions, you are ready to set up the TV Guide On Screen system.
- To download program listings the TV Guide On Screen system needs to be able to change channels on your cable box when the TV is not in use. Please connect the supplied G-LINK cable to the G-LINK jack of the TV. After you connect the G-LINK cable you will be able to control your cable box using the TV's remote.

Notes:

- The TV Guide On Screen system provides listings for cable-ready, cable box, and digital cable services as well as over-the-air broadcast. It does not provide listings for satellite services.
- You may use to connect directly without Cable Box.

How to connect VCR and Cable Box

Antenna Service

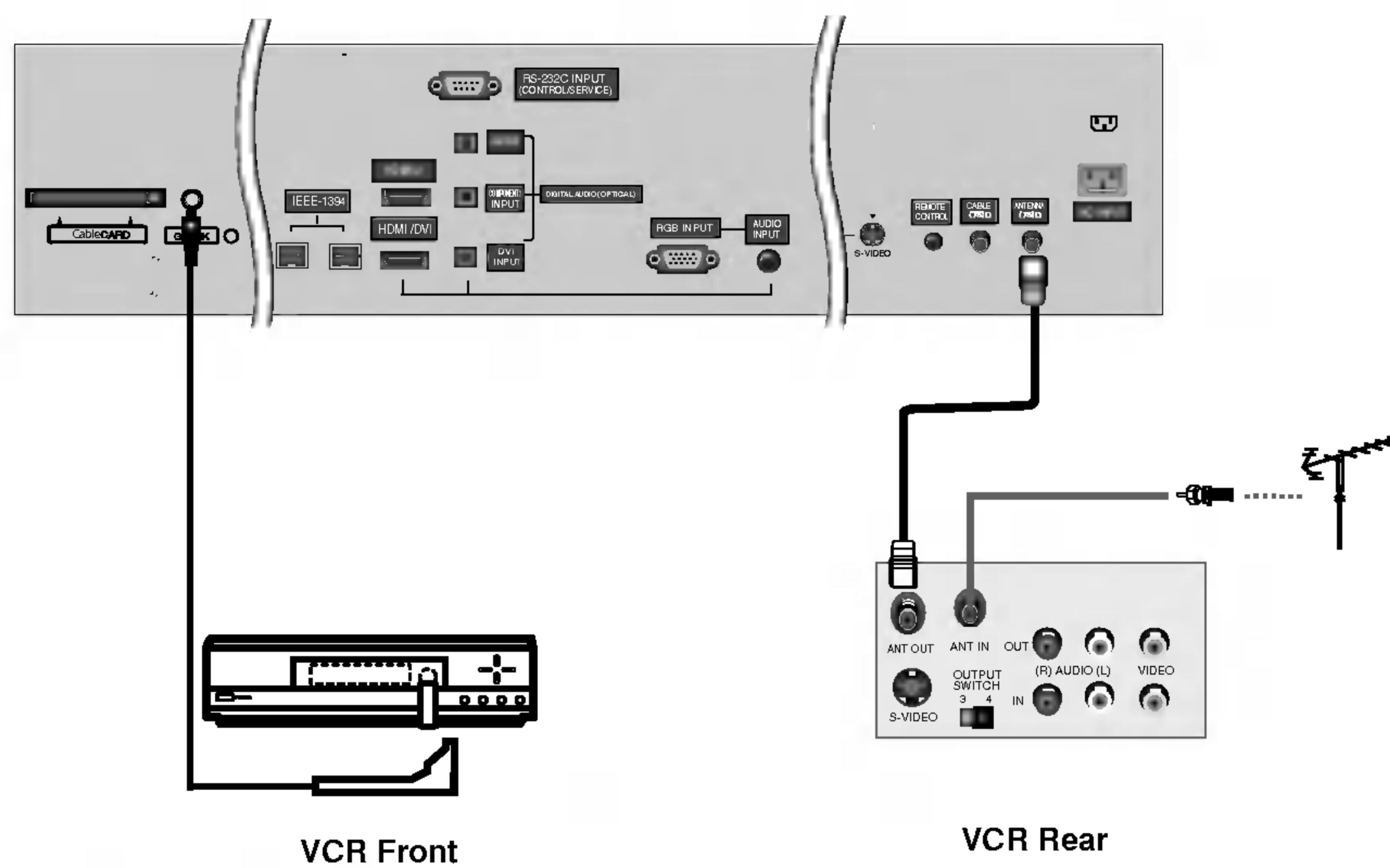

Cable Service without a Cable Box

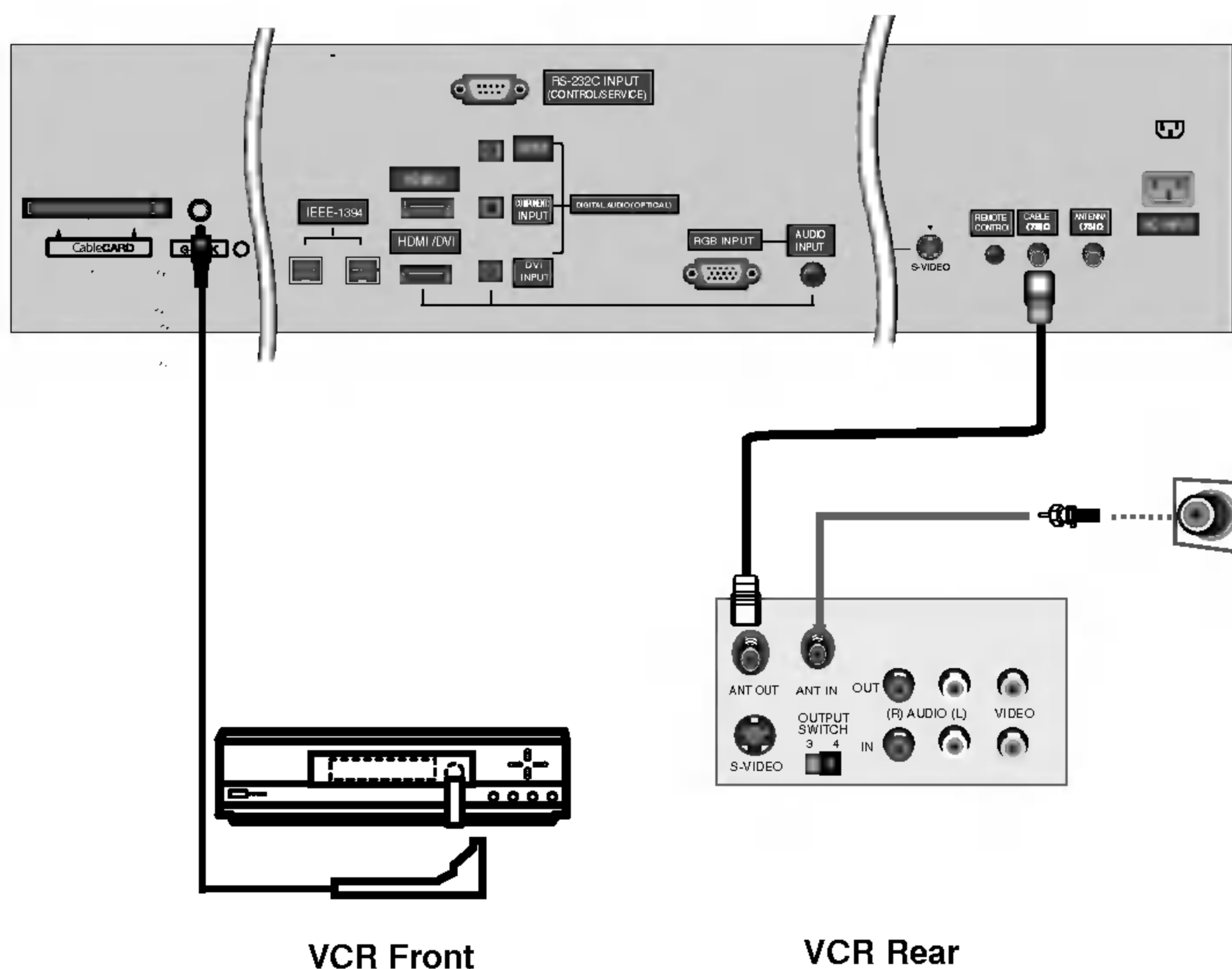

Cable Service with a Cable Box

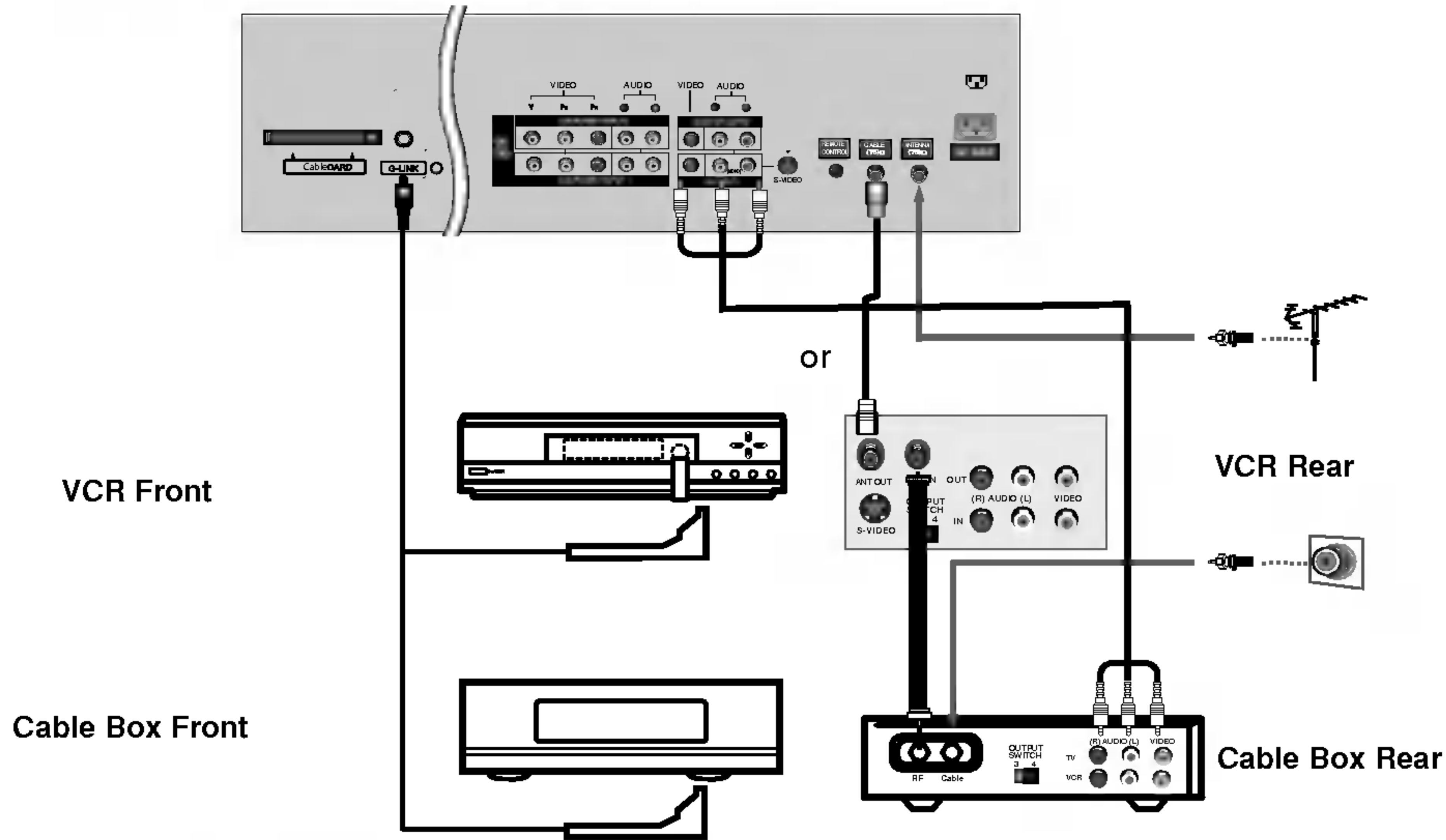

Antenna and Cable Service without a Cable Box

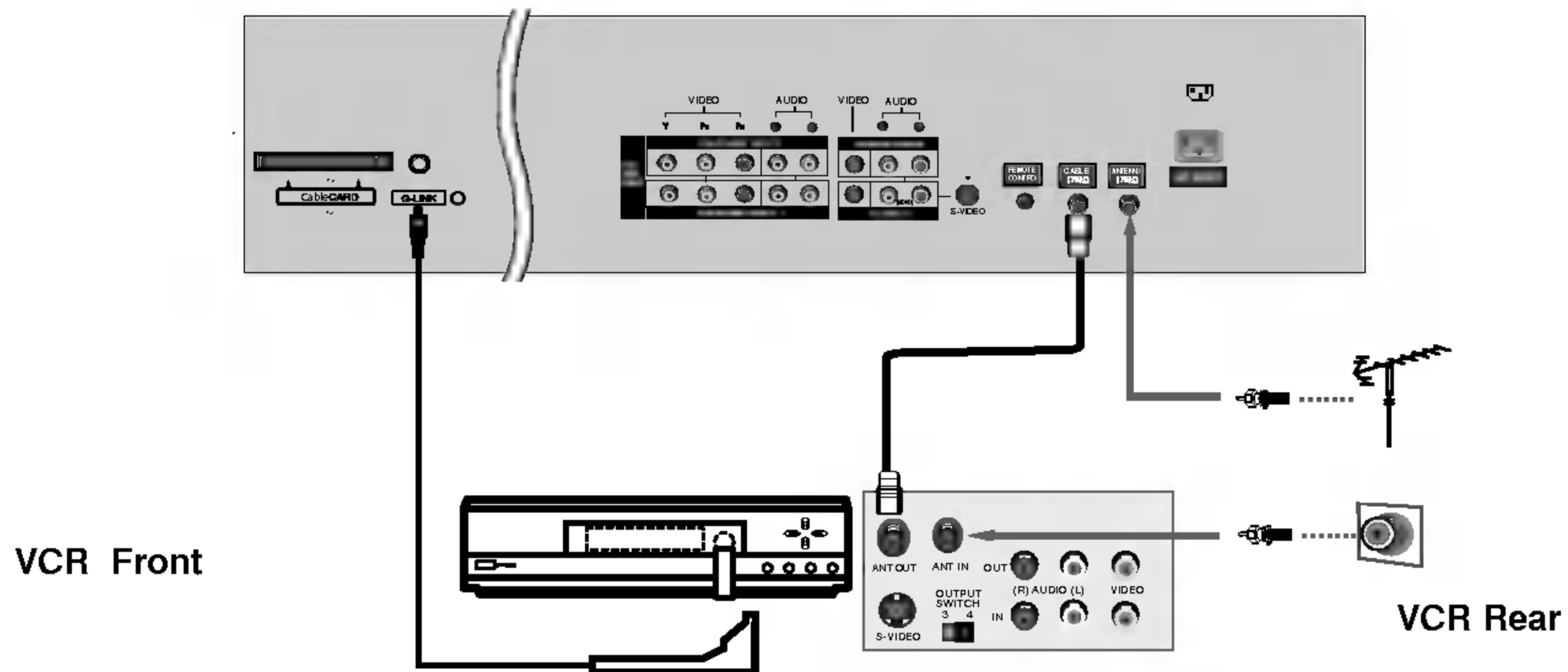

Antenna and Cable Service with a Cable Box

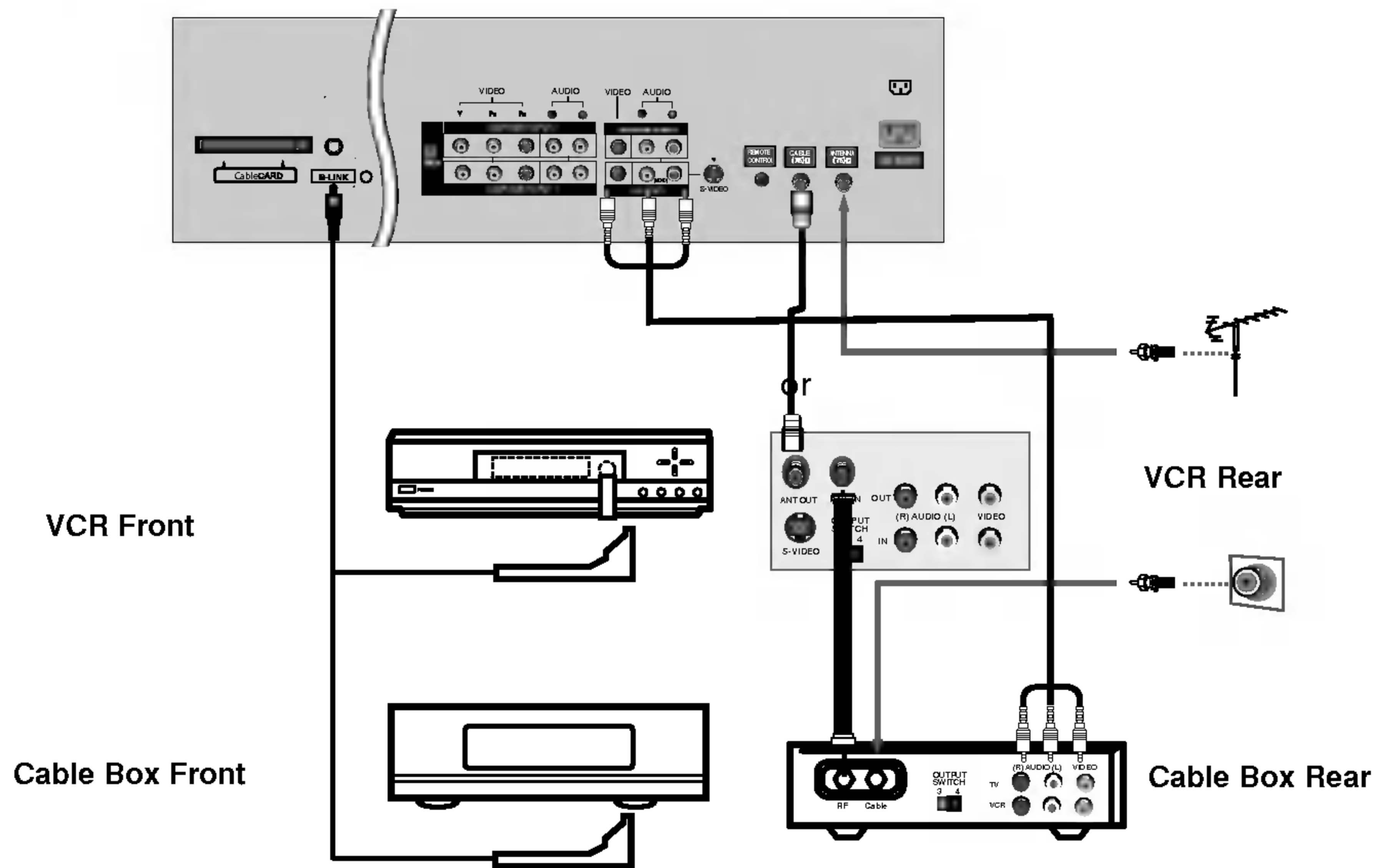

Note:

- The G-LINK™ cable is necessary for the TV Guide On Screen system to work with your Cable Box and VCR. See Page 23~24 for G-LINK™ connection instructions.

TV Guide On Screen Setup

1. Welcome Screen

The TV Guide On Screen system's Welcome Screen appears:

- by pressing the TV Guide key
- when you power On your TV if you previously skipped "Set up TV Guide On Screen now" on the Reminder Screen.

The Welcome Screen highlights features of the TV Guide On Screen system.

Press **ENTER** to begin Setup.



2. Reminder Screen

The TV Guide On Screen system's Reminder Screen appears:

- after initial TV set up
- if you power Off the TV and then power it back On

To make a selection, use the ▲ / ▼ button to highlight an option, and press **ENTER**.

- "Set up TV Guide On Screen now," displays the Welcome Screen. Press **ENTER** to begin Setup.
- "Remind me to set up later" returns you to watching TV.
- "Don't remind me again" returns you to watching TV and stops the reminder screen from appearing upon power On.

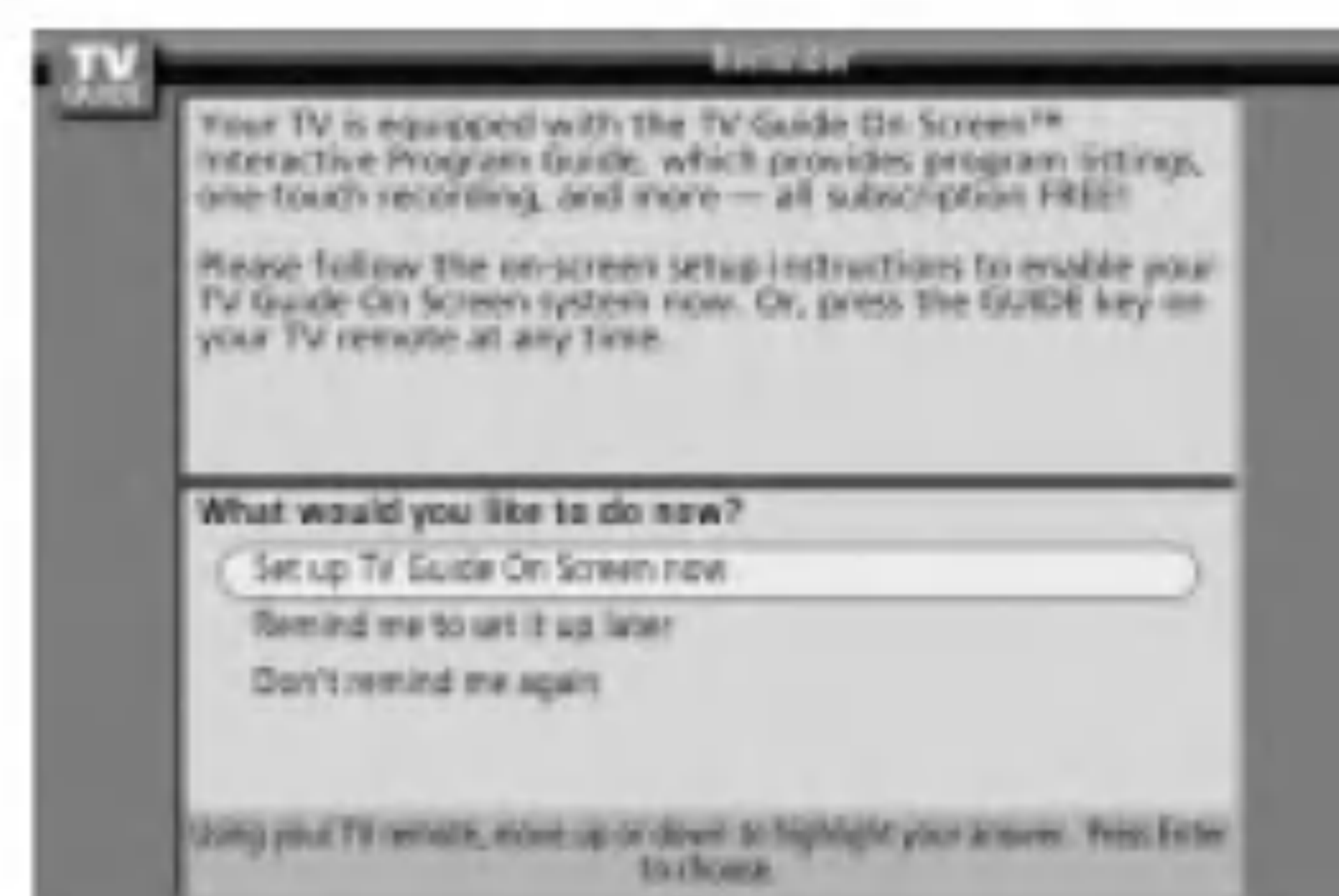

How to use

1. Screen 1: Country

- This screen asks you the location of your TV.
- Use the ▲ / ▼ button to highlight a country.
- Press **ENTER** to display Screen 2.

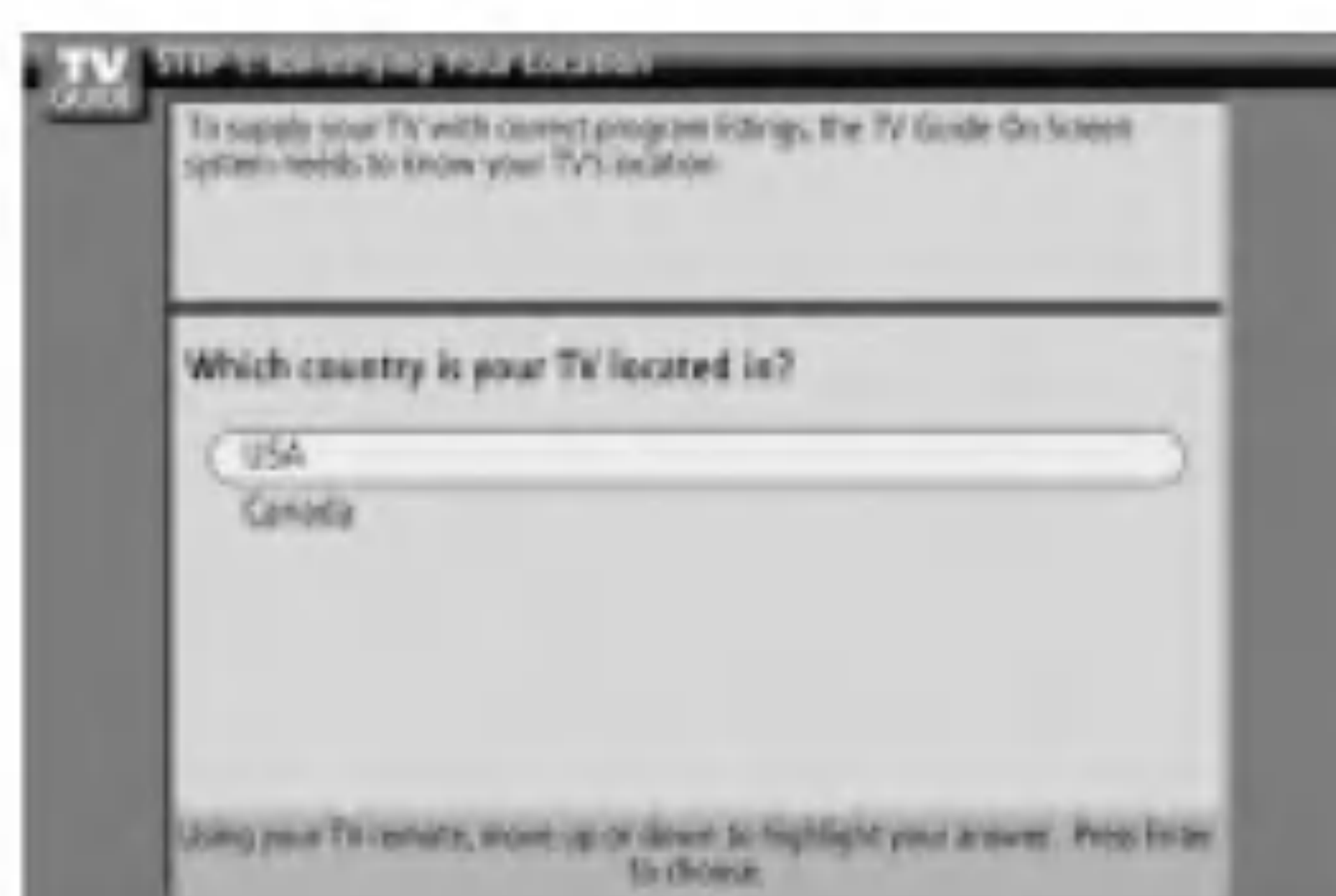

2. Screen 2: Enter ZIP or Postal Code

Option 1

- If you selected USA in Screen 1, you see the ZIP Code screen.
- You input numbers by either pressing the number keys on the remote or using the ▲ / ▼ button to display a number, and then the ◀ / ▶ button to move to another field.
- Press **ENTER** to display Screen 3.

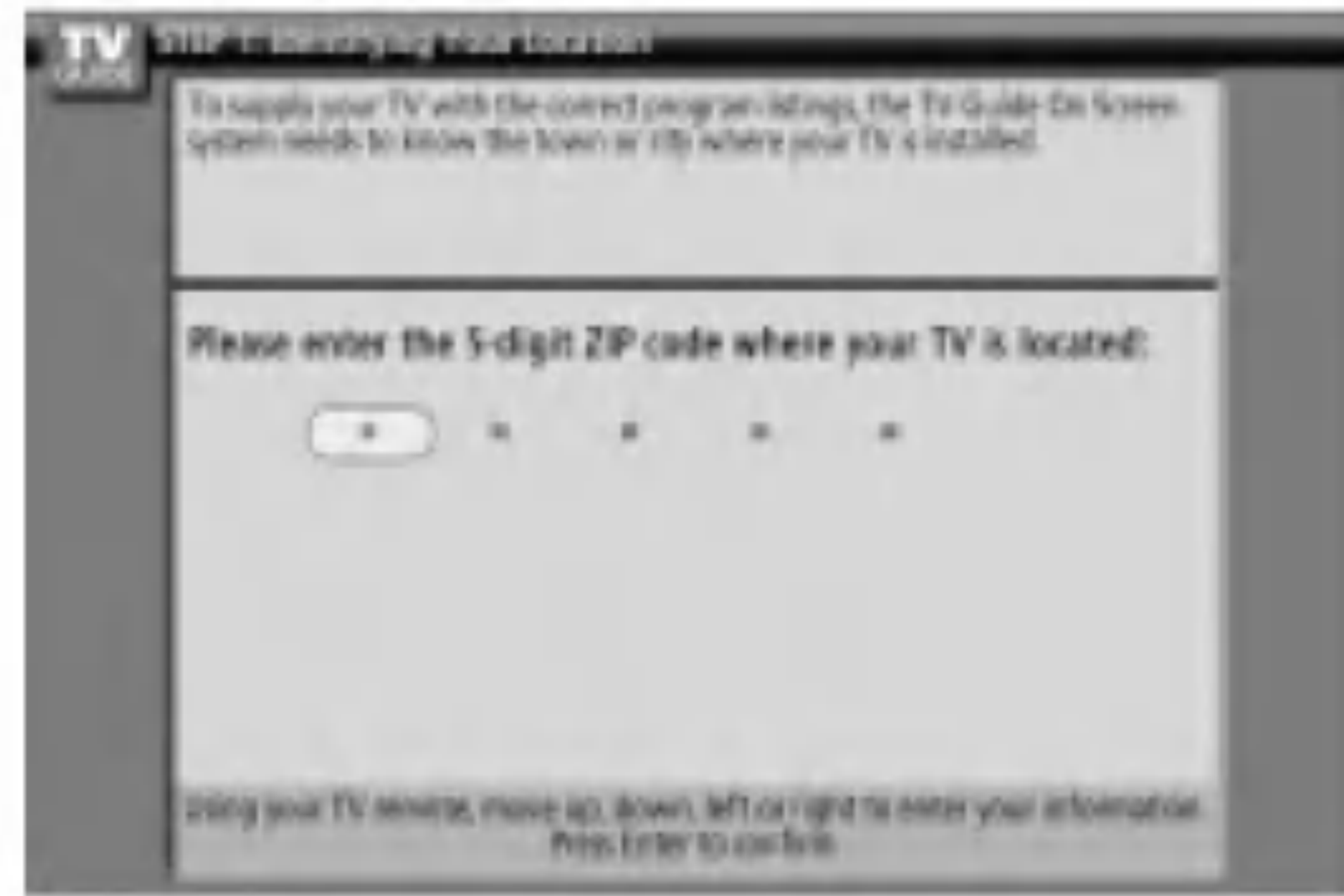

Option 2

- If you selected Canada in Screen 1, you see the Postal Code screen.
- You input characters by using the ▲ / ▼ button, and then the ◀ / ▶ button to move to another field.
- Press **ENTER** to display Screen 3.

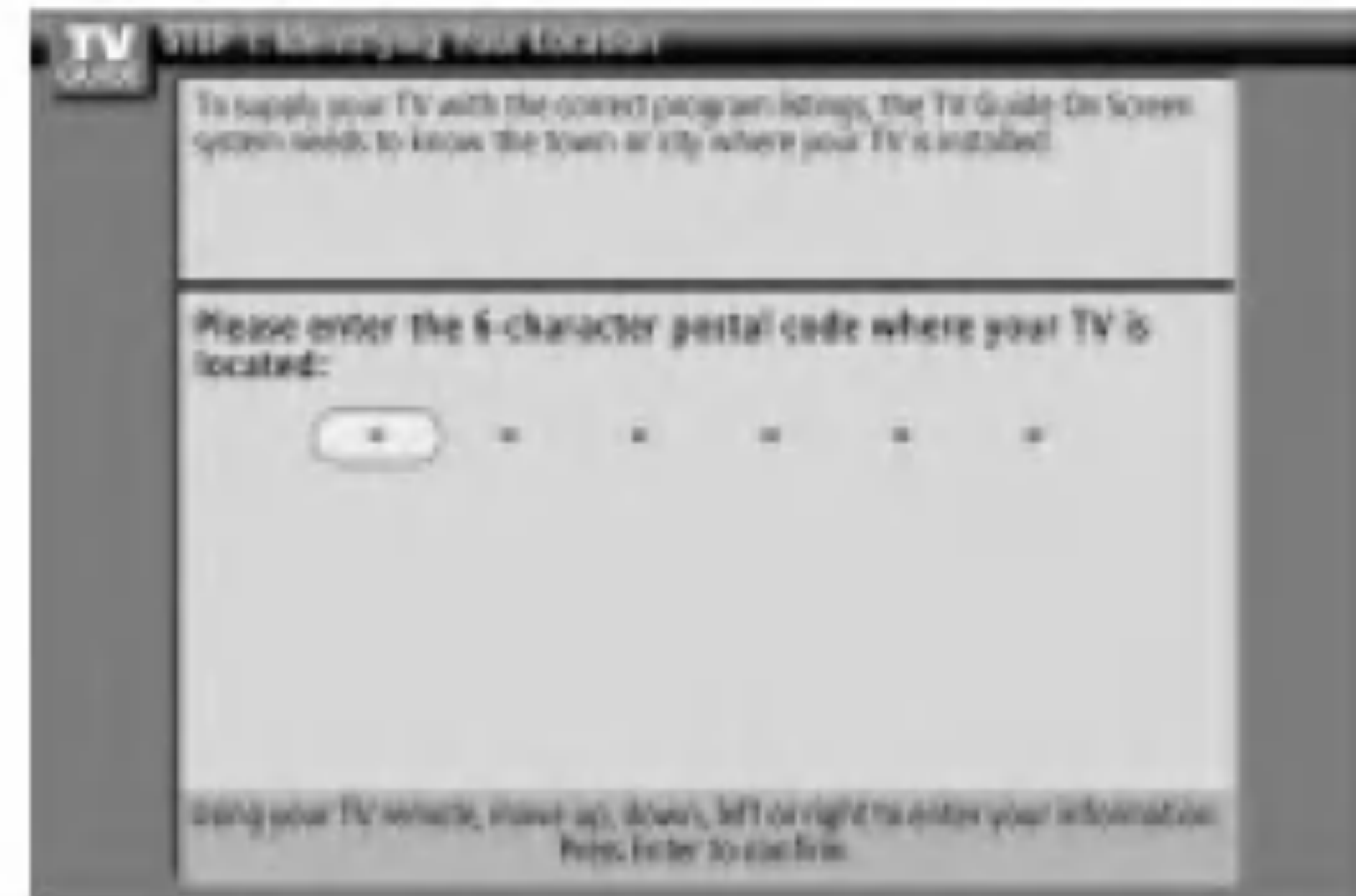

3. Screen 3: Do you have Cable Service connected?

- If you select Yes, you see Screen 4.
- If you select No, you see Screen 12.

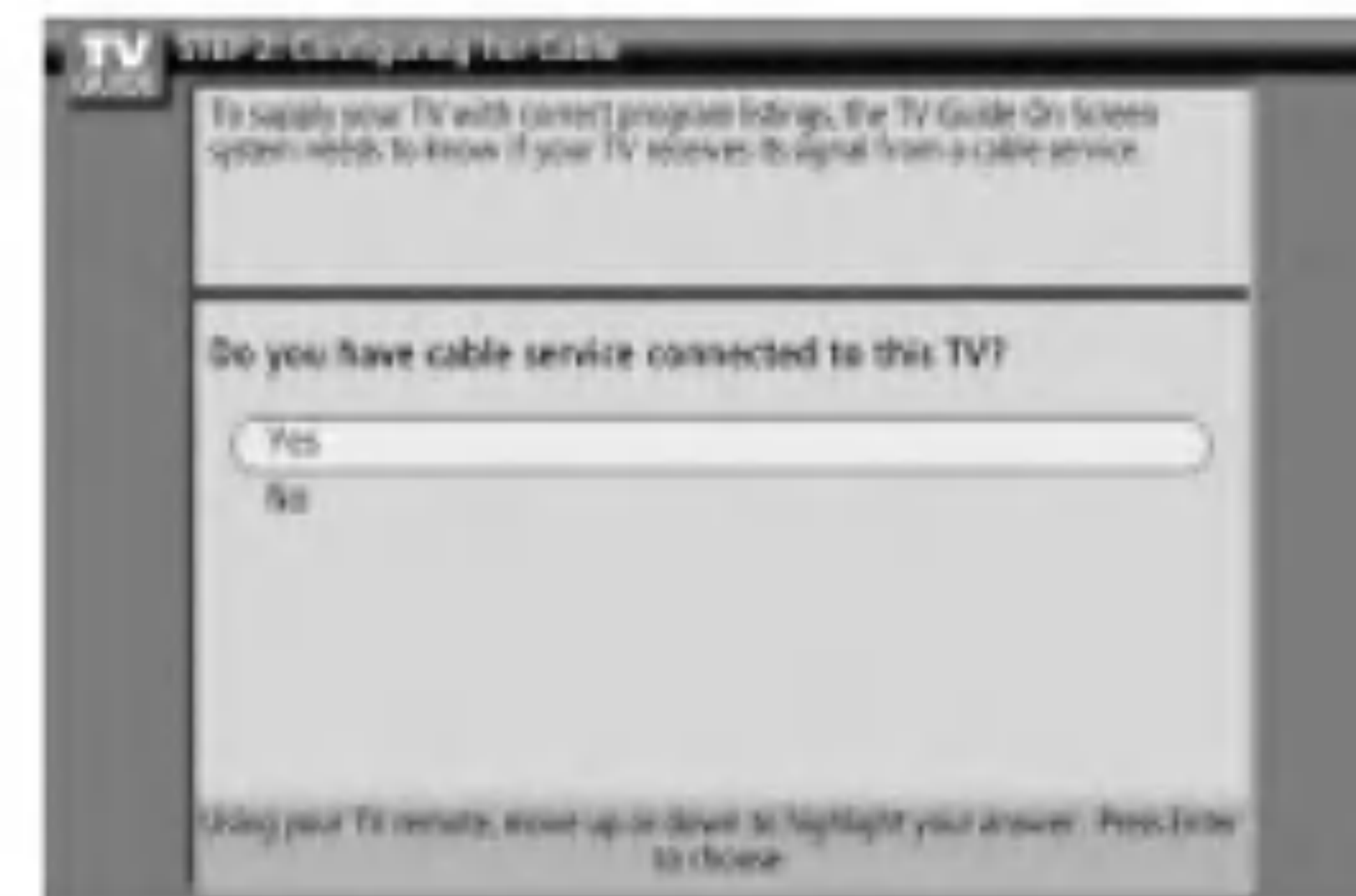

4. Screen 4: Do you have a Cable Box?

- If you select Yes, you see Screen 5.
- If you select No, you see Screen 12.

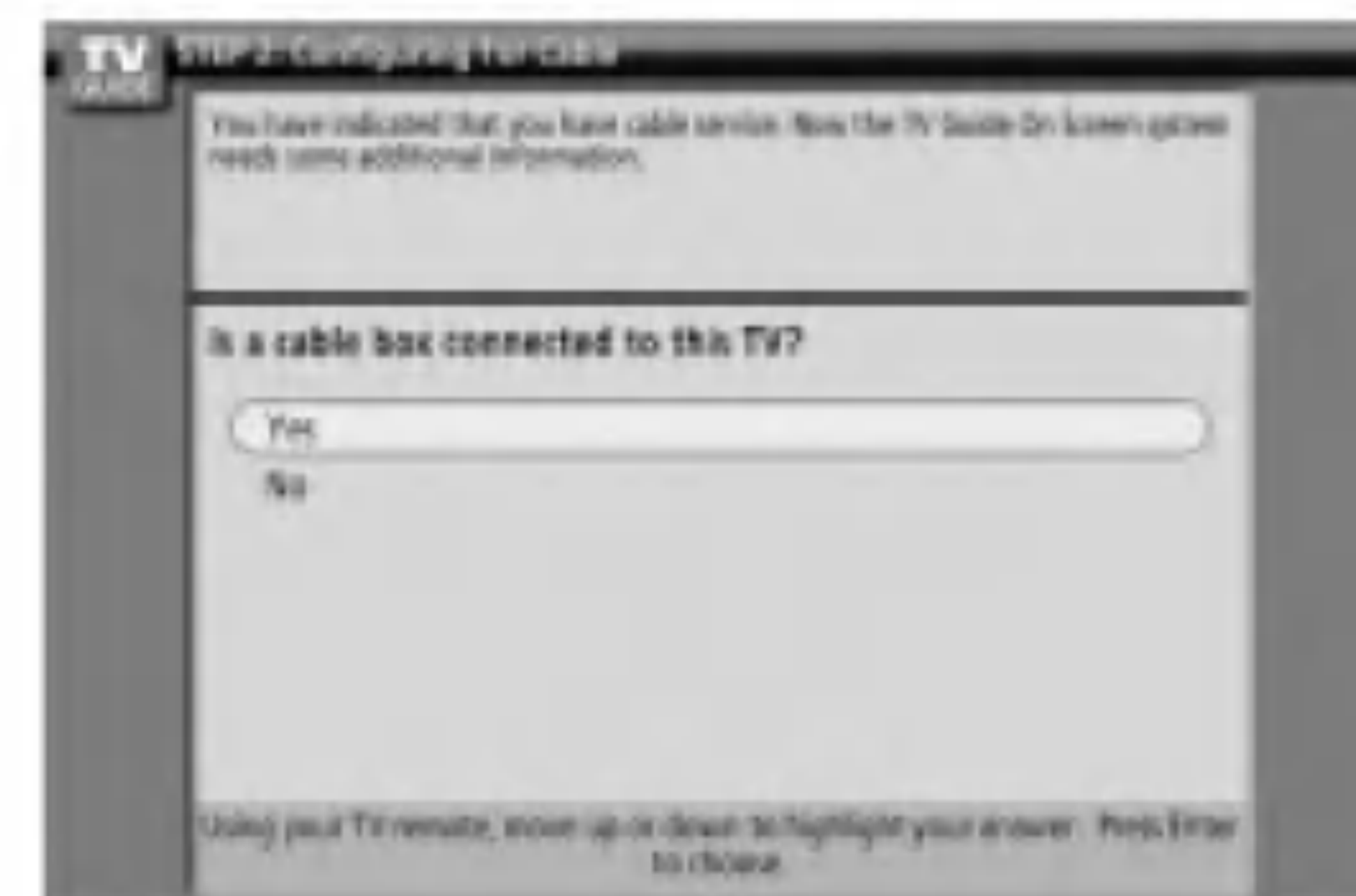

5. Screen 5: Which TV input is the cable box plugged into?

- If you select Cable, you see Screen 6.
- If you make any other choice, you see Screen 7 .

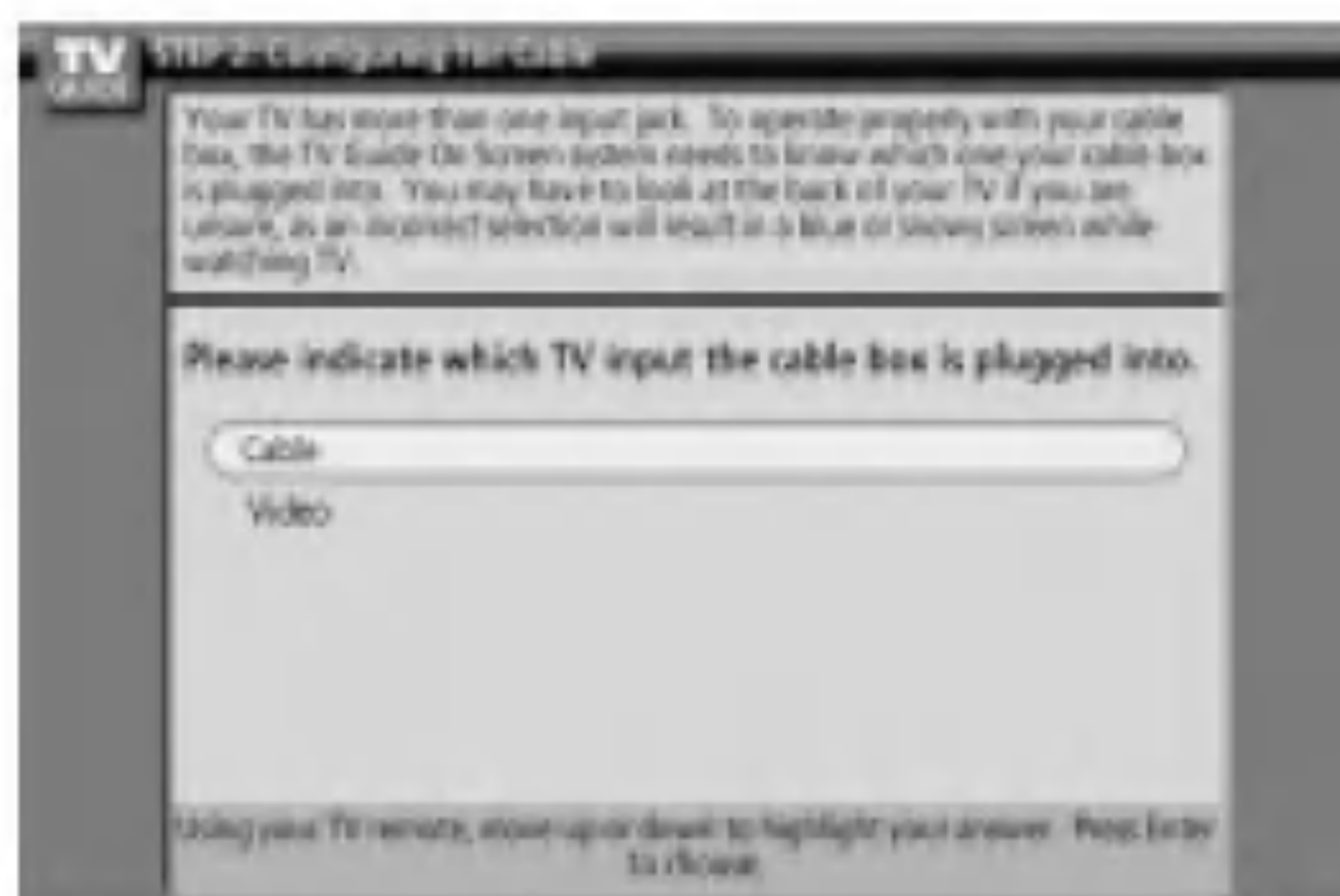

6. Screen 6: Cable Box Tuning Channel

- Select the channel used for the cable box.
- Press **ENTER** to display Screen 7.

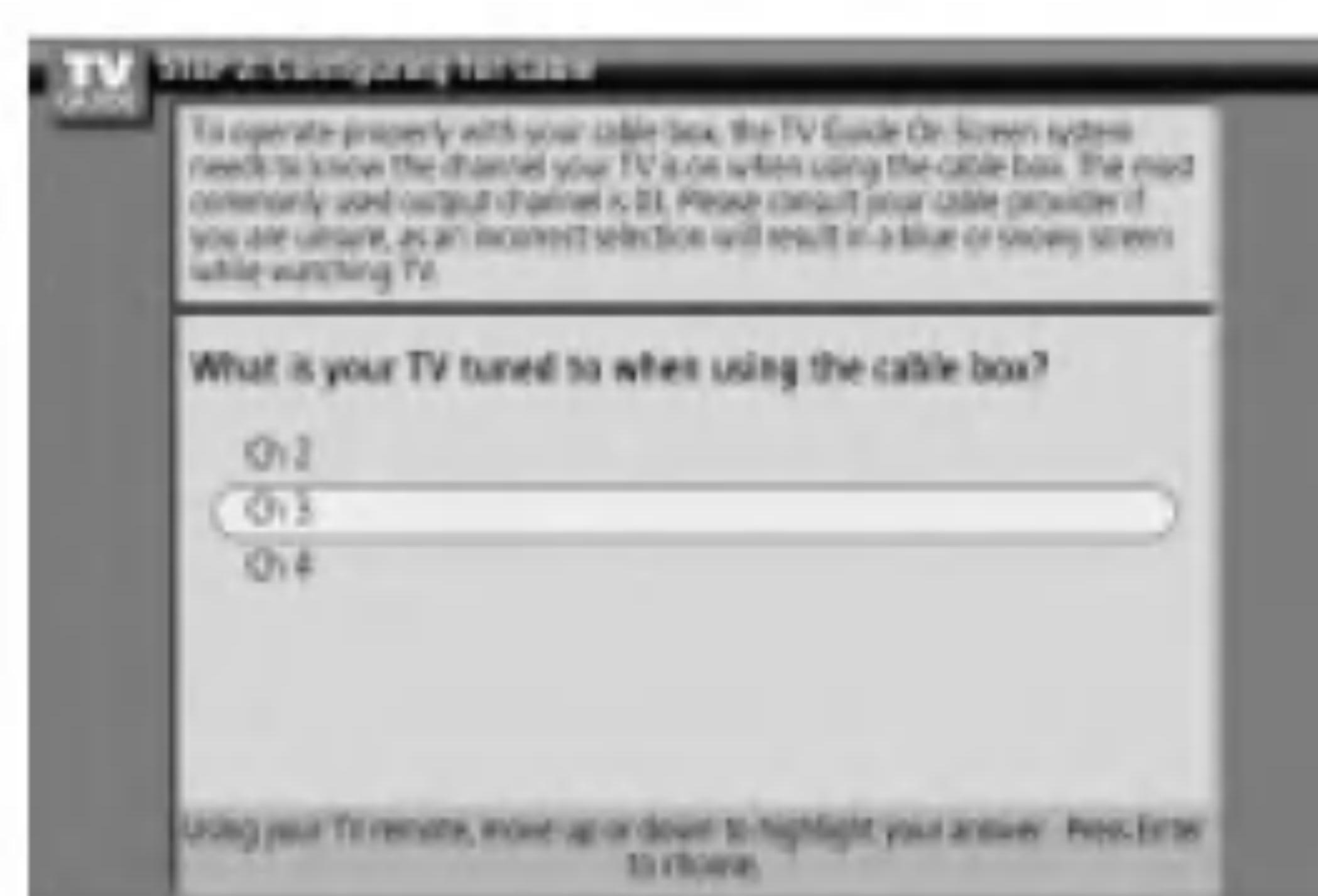

7. Screen 7: Cable Box Configuration Diagram

- The diagram shows the correct way to install the G-LINK Cable from the back of the device to the cable box.
- **Make sure the G-LINK™ Cable is properly installed.**
- Press **ENTER** to display Screen 8.

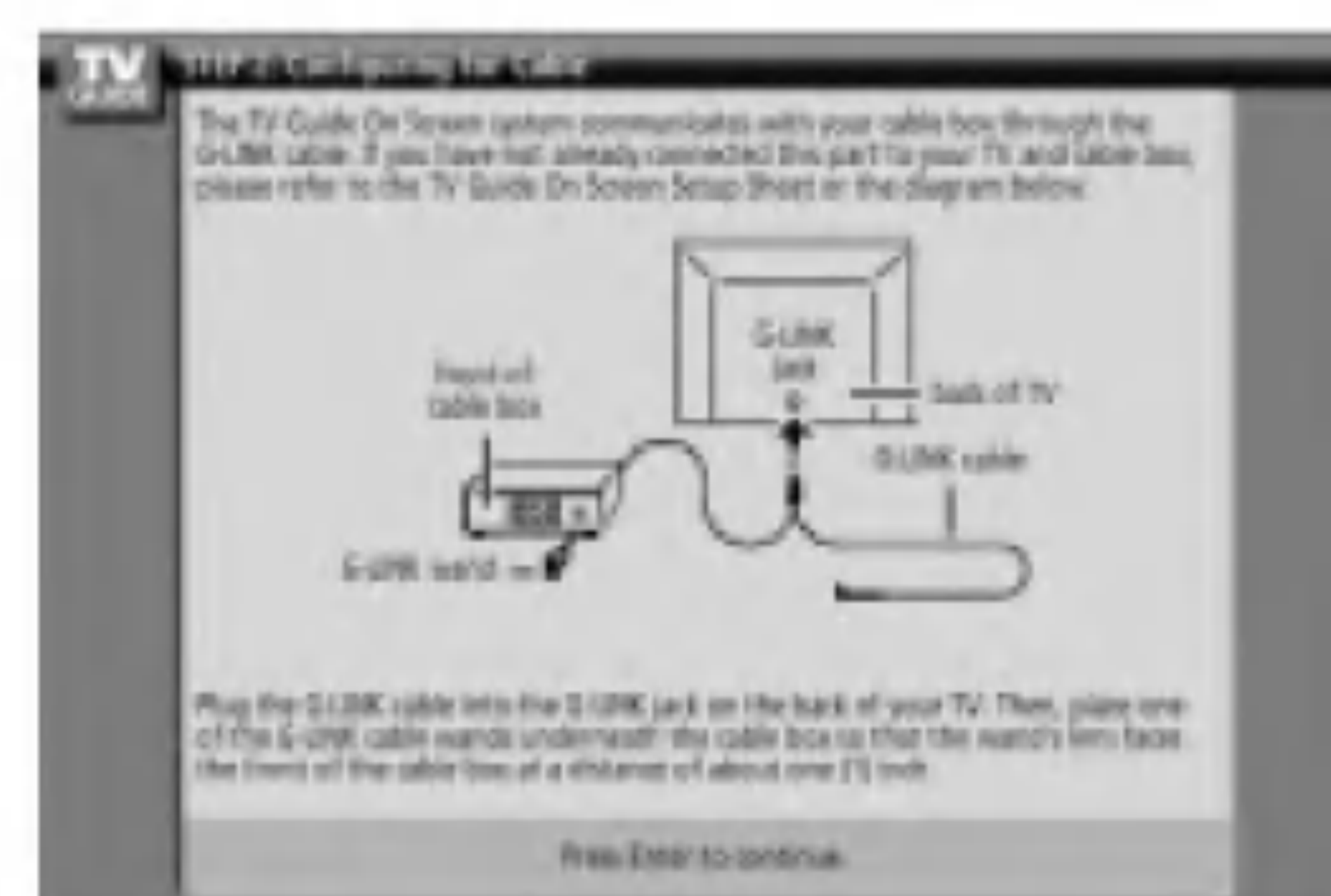

8. Screen 8: Cable Box Brand Name

- Use the ▲ / ▼ button to select a cable box brand.
- Press ENTER to display Screen 9.

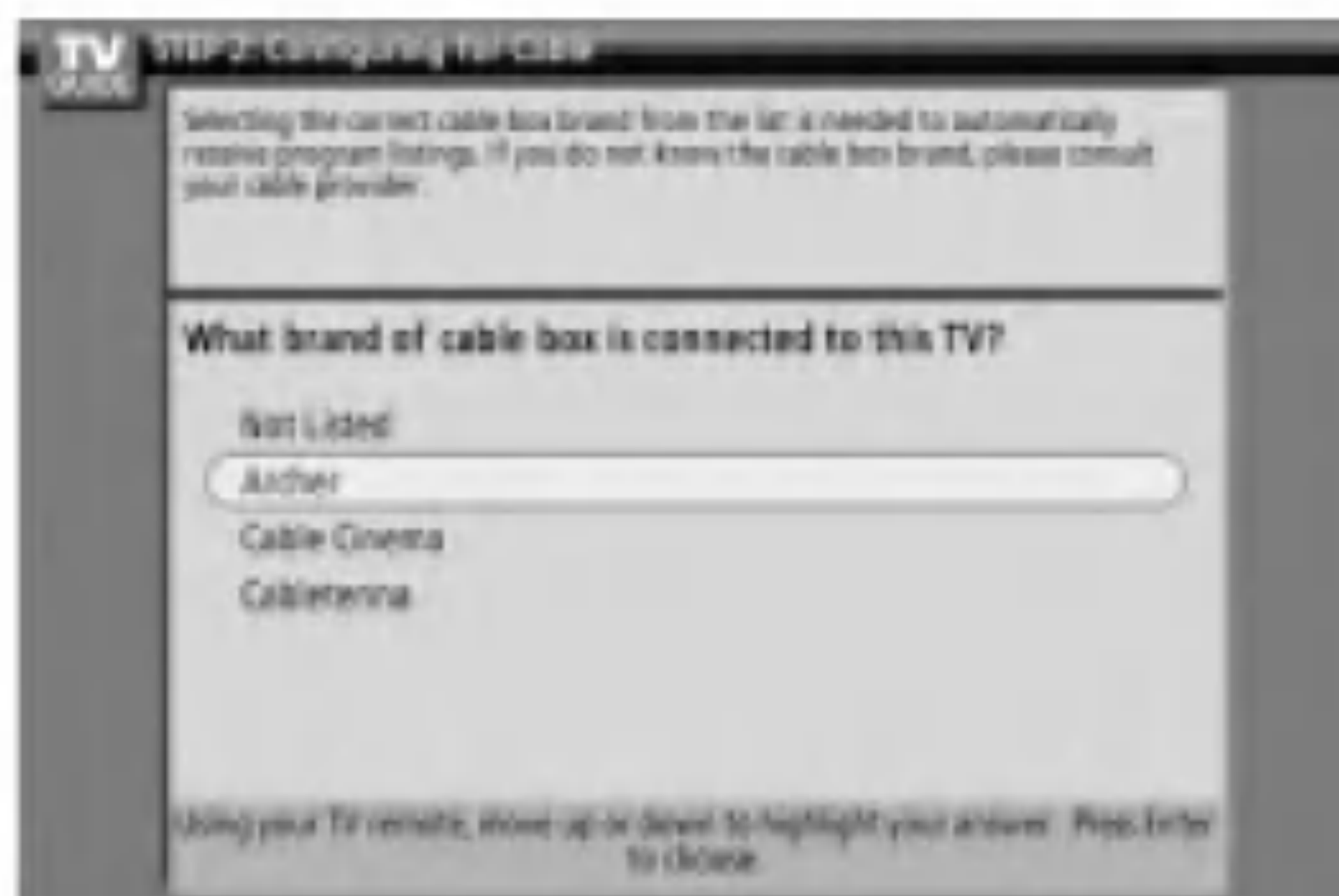

9. Screen 9: Cable Box Preparation

- Follow the on-screen instructions, and press ENTER to display Screen 10.

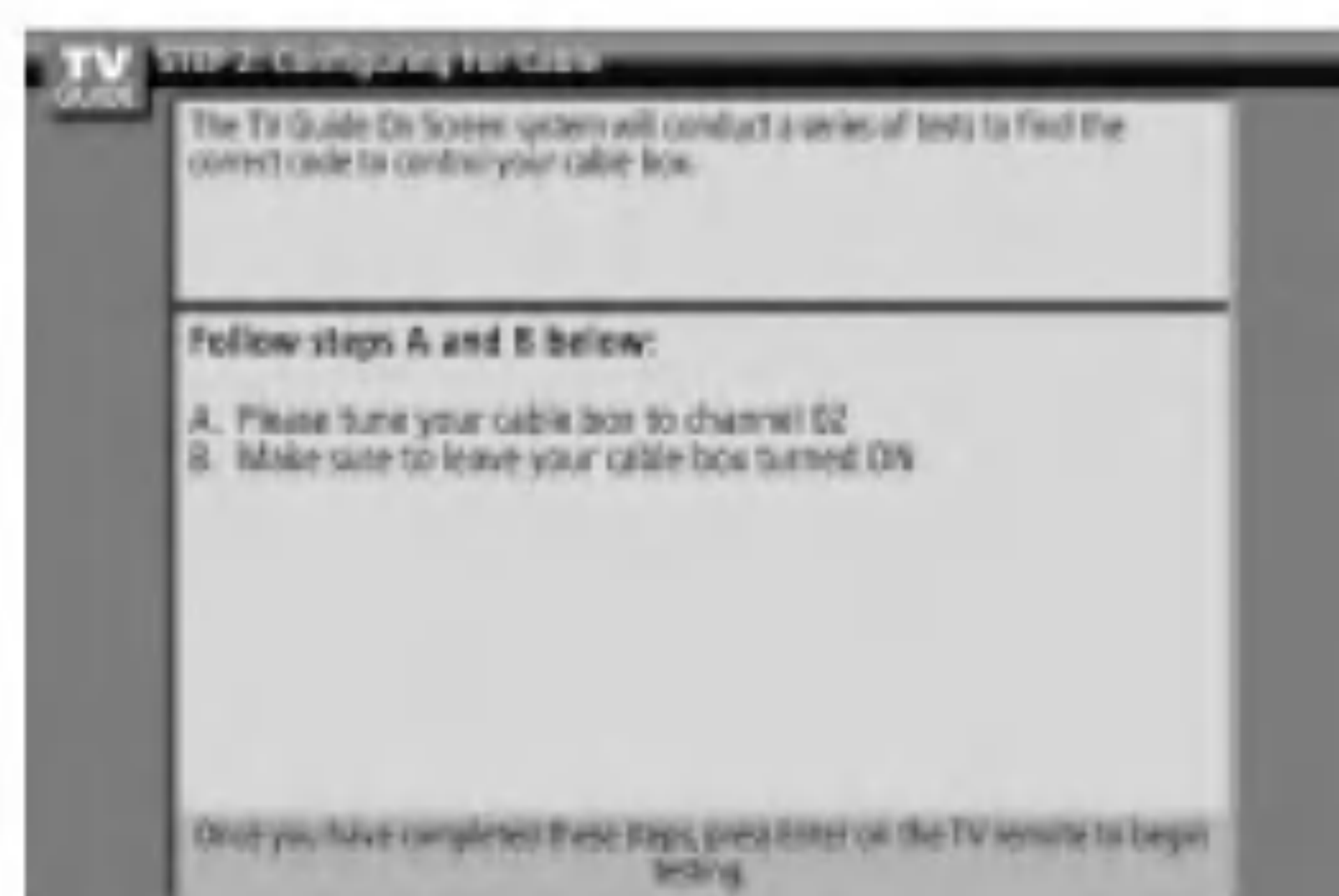

10. Screen 10: Cable Box Code Testing

- When testing is done, Screen 11 displays automatically.

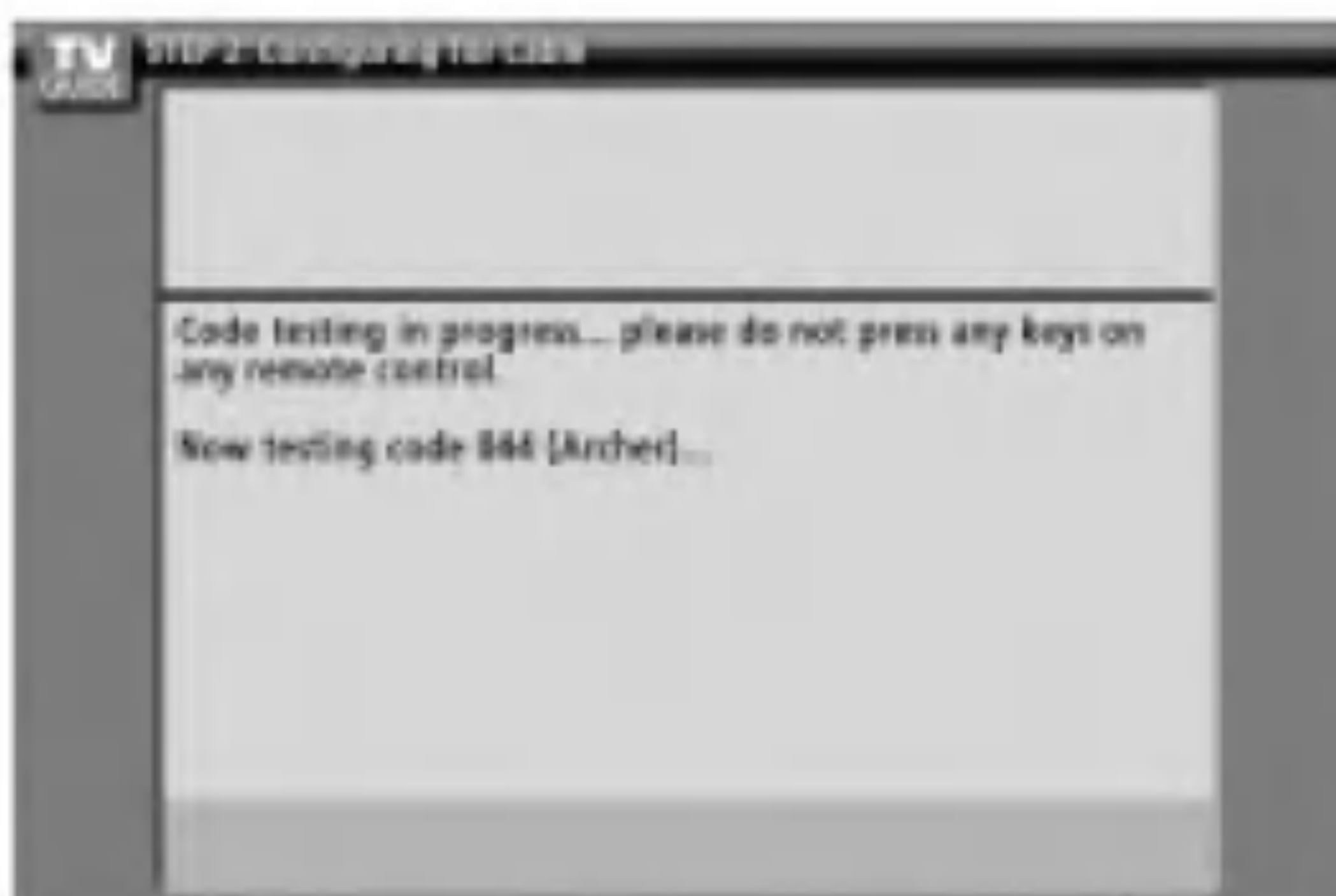

11. Screen 11: Cable Box Tuned to Channel 9?

- If you select Yes, you see Screen 12.
- If you select No, a different code is tested in Screen 10.

Note:

- Many Cable Boxes require testing more than one code.
- If you select Test this code again, the same code is tested again in Screen 10.

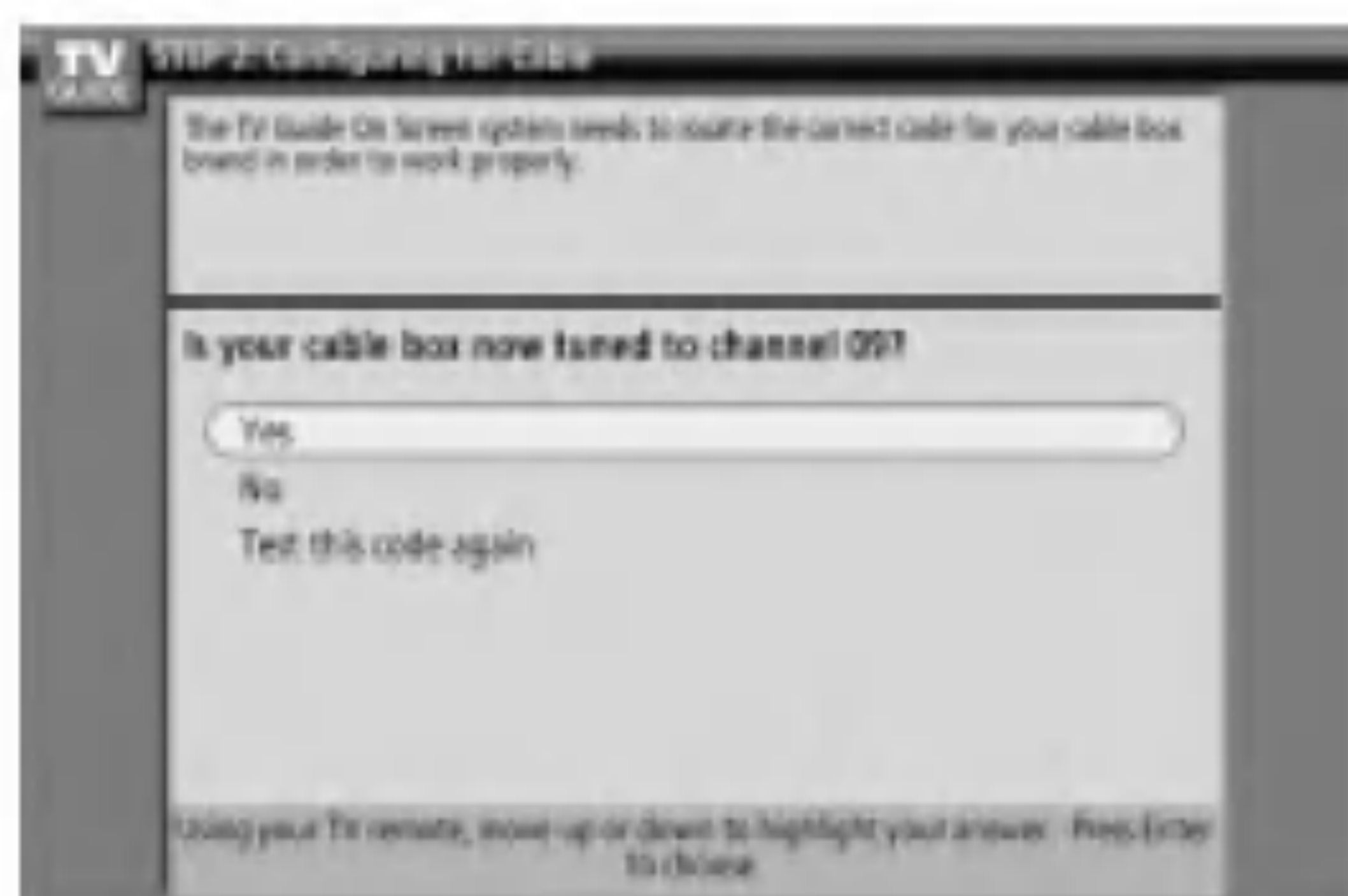

12. Screen 12: Do you have an antenna connected?

- If you select Yes, you see Screen 13.

Note:

- If you selected No in Screen 3 then you must select Yes in this screen to receive a channel lineup and listings.

- If you select No, you see Screen 13.

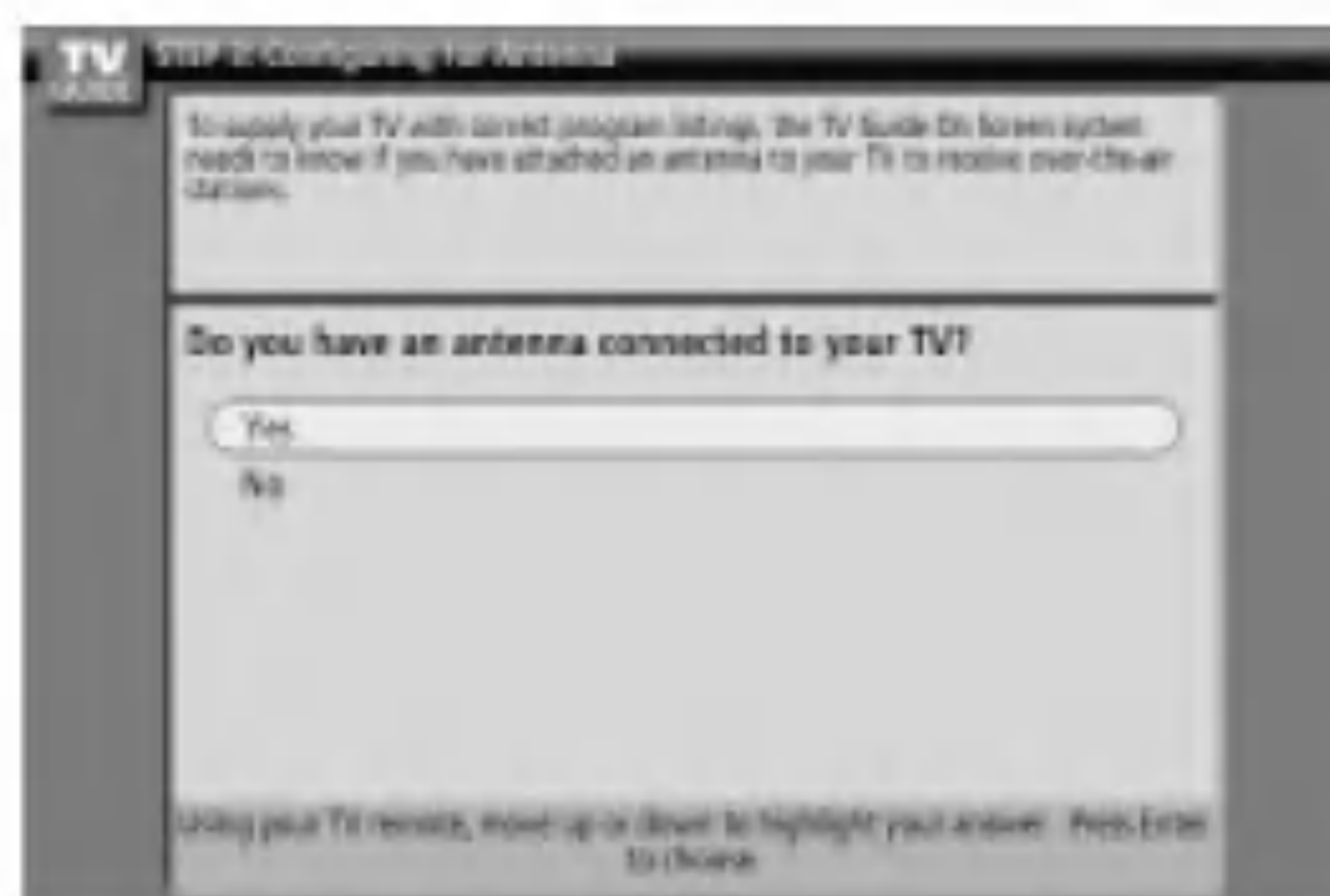

13. Screen 13: Are your basic settings correct?

- If you select Yes, you see Screen 14.
- If you select No, you see Screen 1.

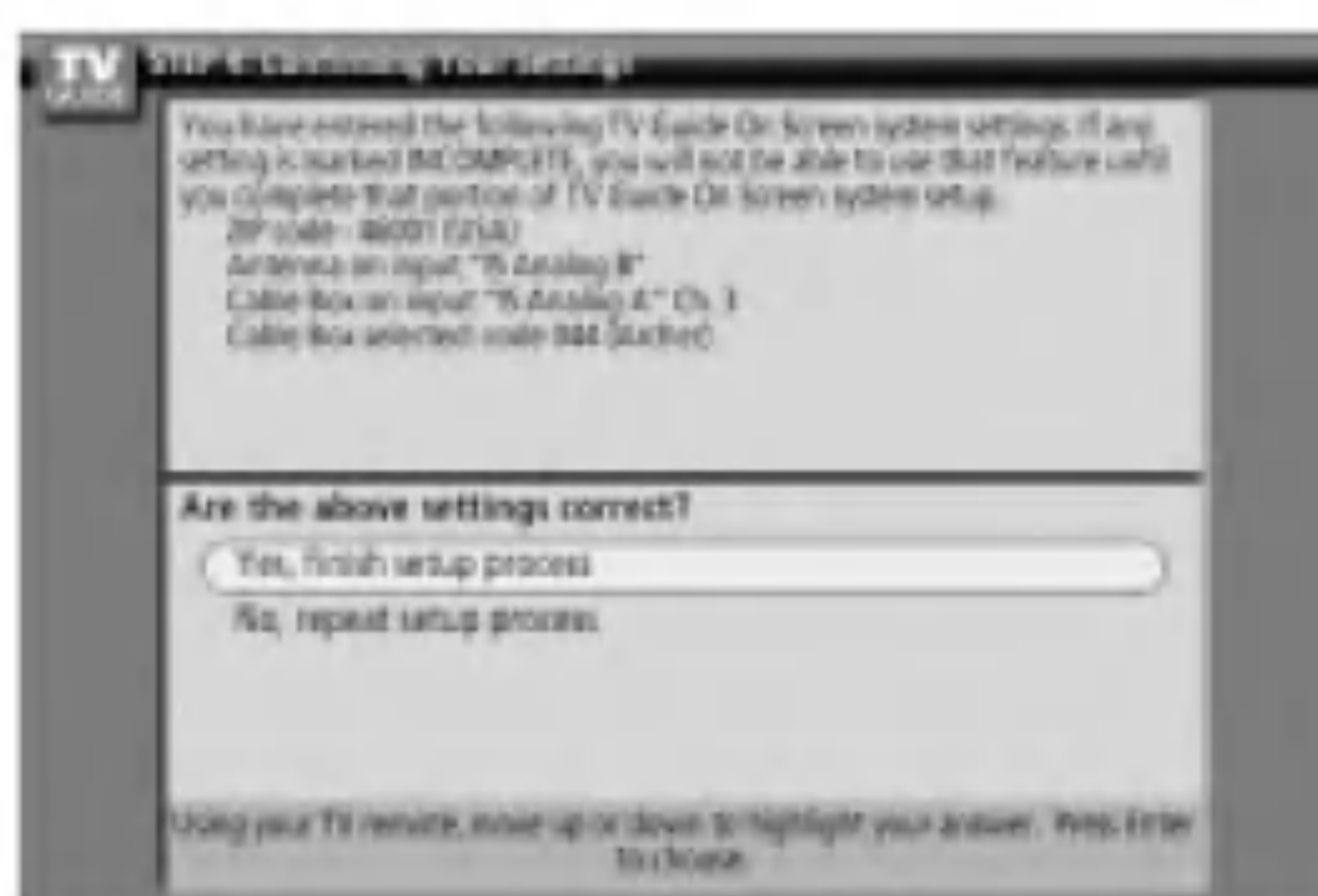

14. Screen 14: Congratulations

- Press ENTER to display Screen 15.

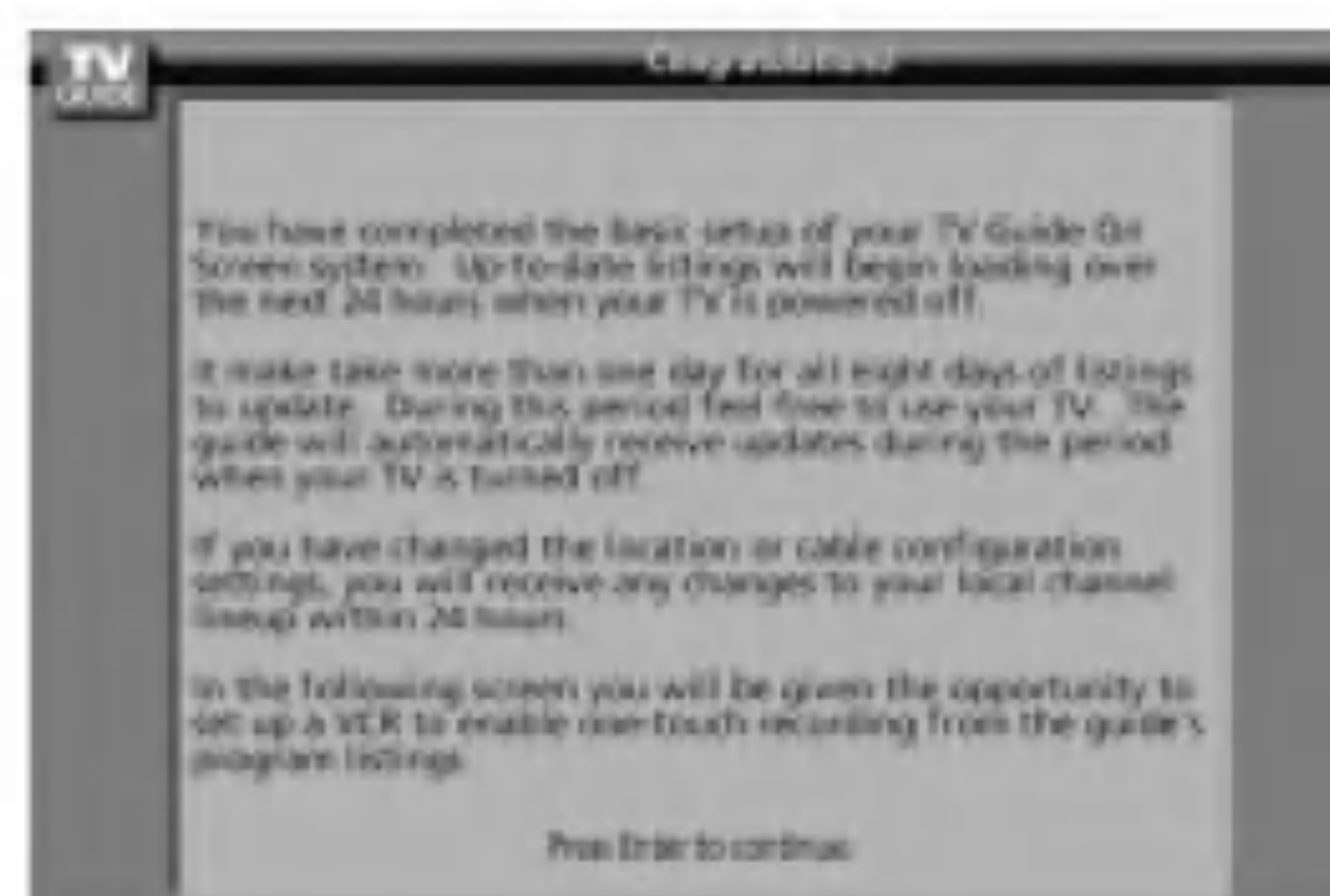

15. Screen 15: Is a VCR Connected?

- If you select Yes, you see Screen 16.
- If you select No, you see Screen 21.

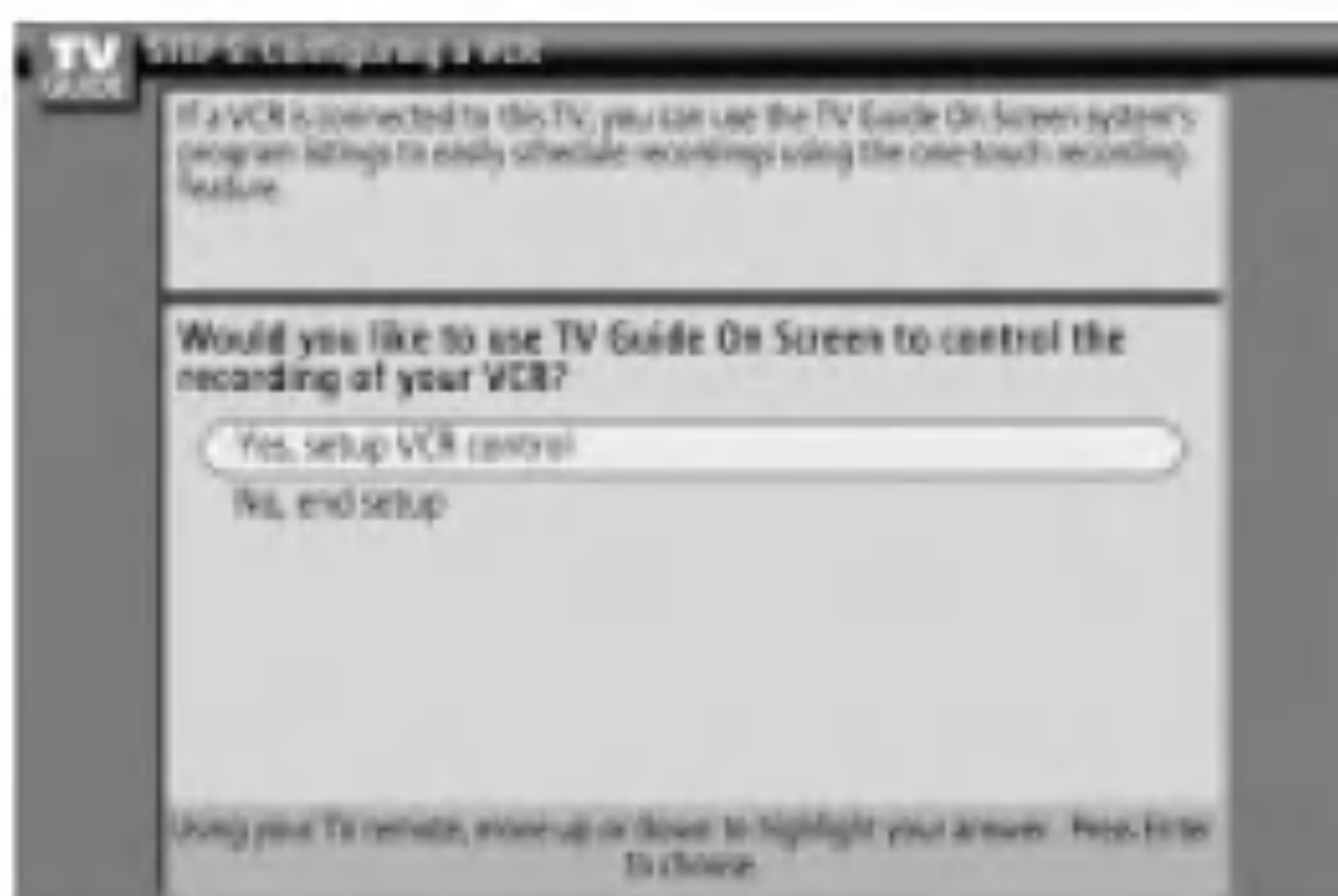

16. Screen 16: VCR Configuration Diagram

- This screen shows the correct way to install the G-LINK™ Cable from the back of the TV to the Recording device.
- **Make sure the G-LINK™ Cable is properly installed.**
- Press **ENTER**, and you see Screen 17.

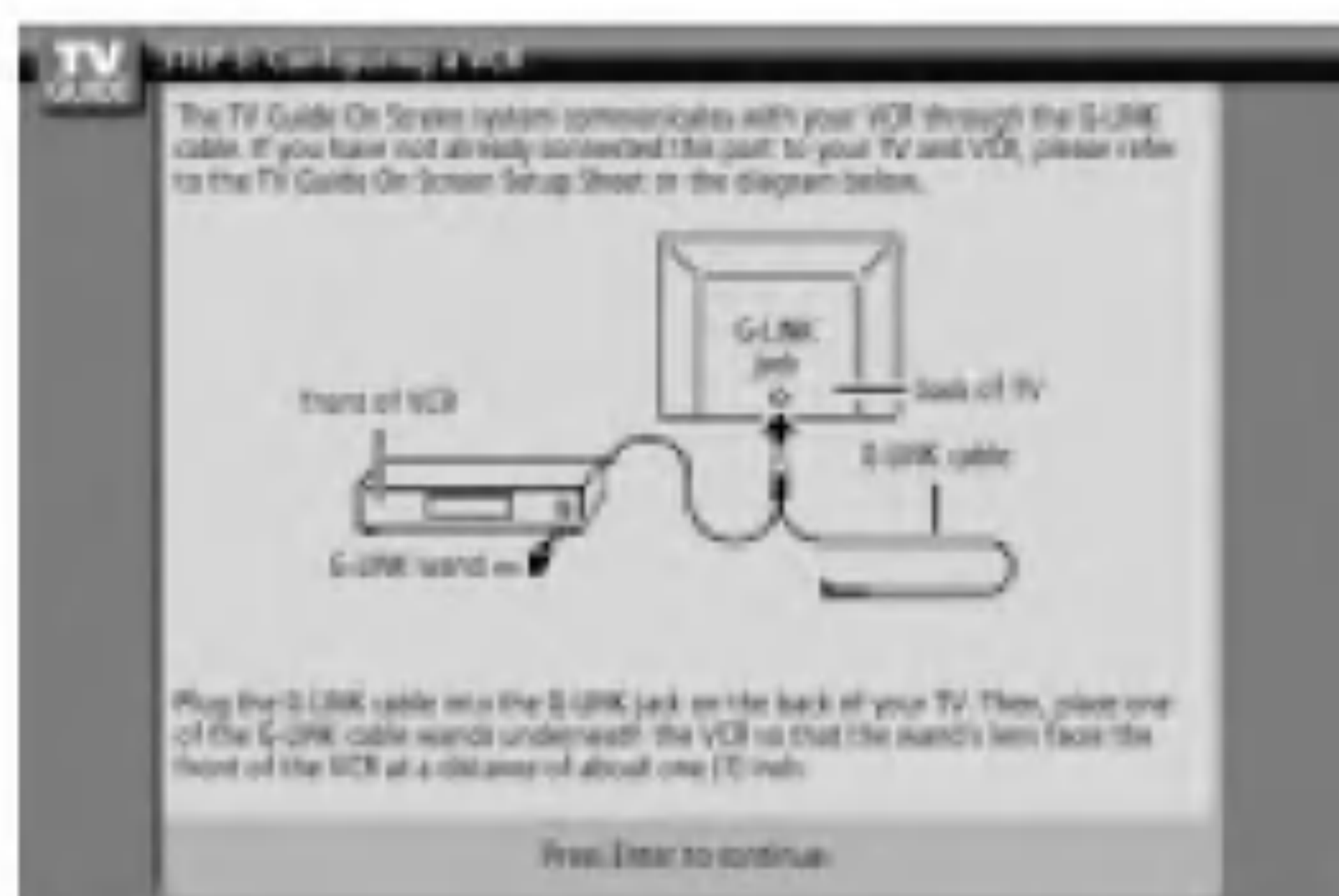

17. Screen 17: VCR Brand Name

- Use the ▲ / ▼ button to select the brand of the recording device.
- Press **ENTER**, and you see Screen 18.

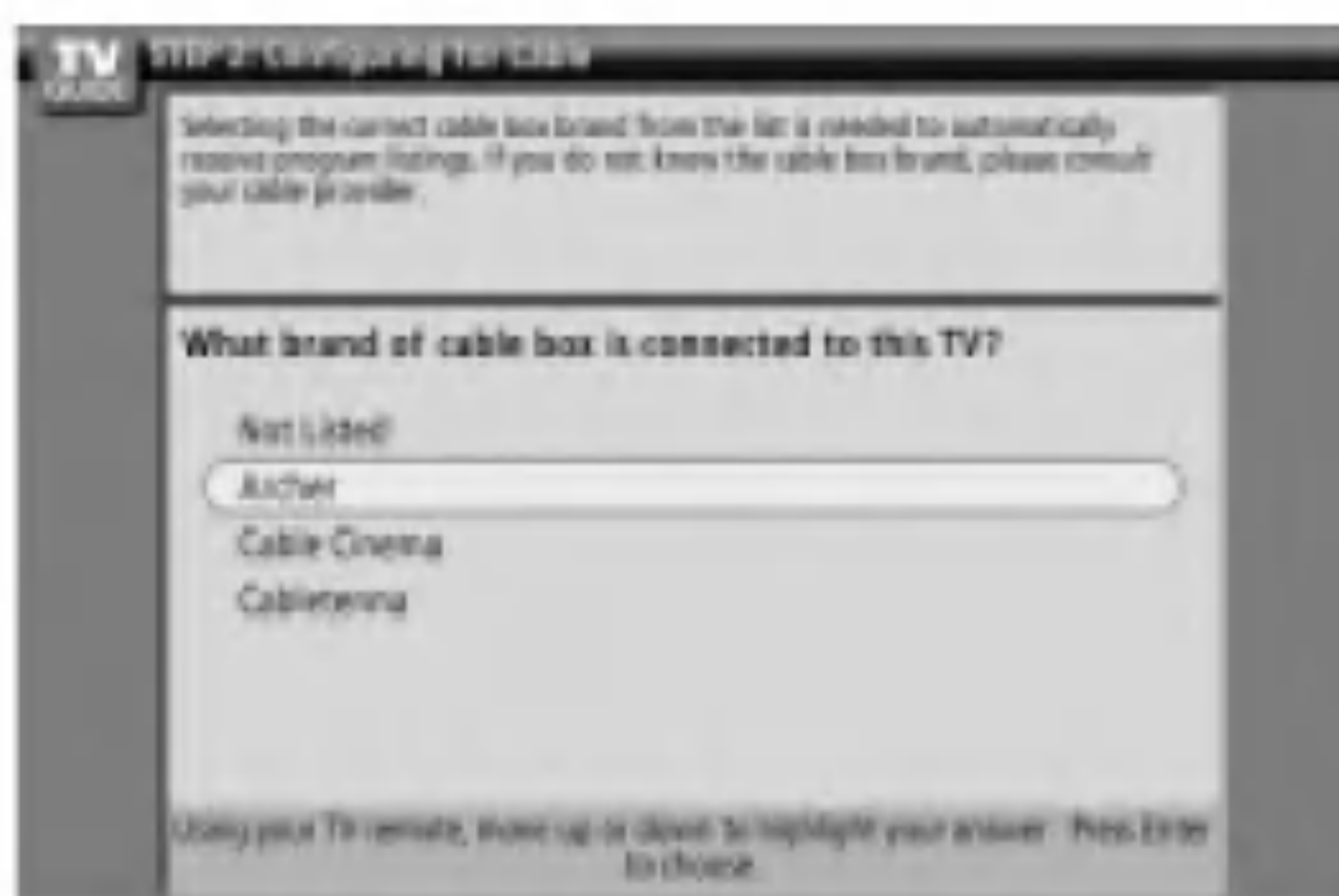

18. Screen 18: VCR Preparation

- Follow the on-screen instructions, and press **ENTER** to display Screen 19.

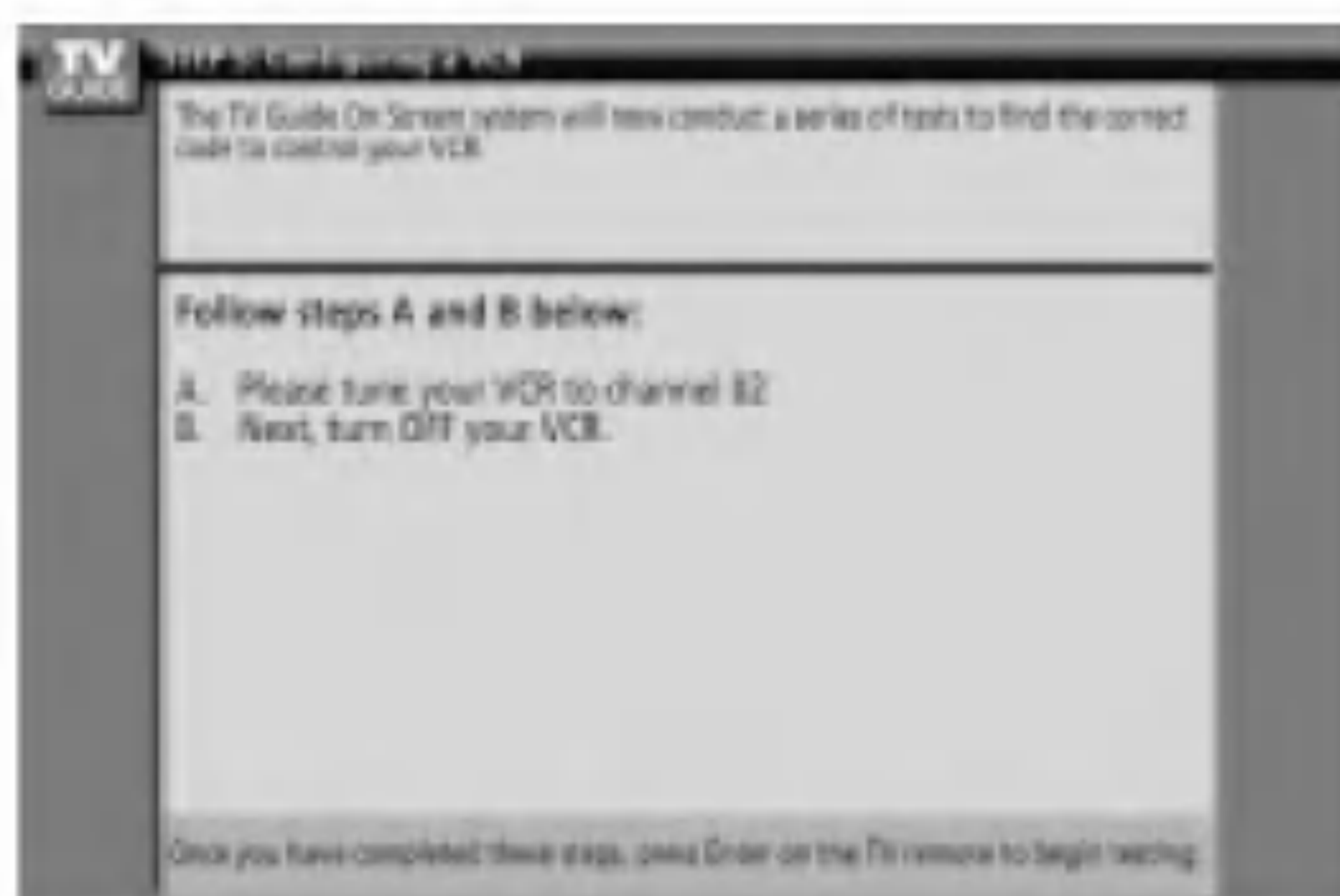

19. Screen 19: VCR Code Testing

- When testing is done, Screen 20 displays automatically.

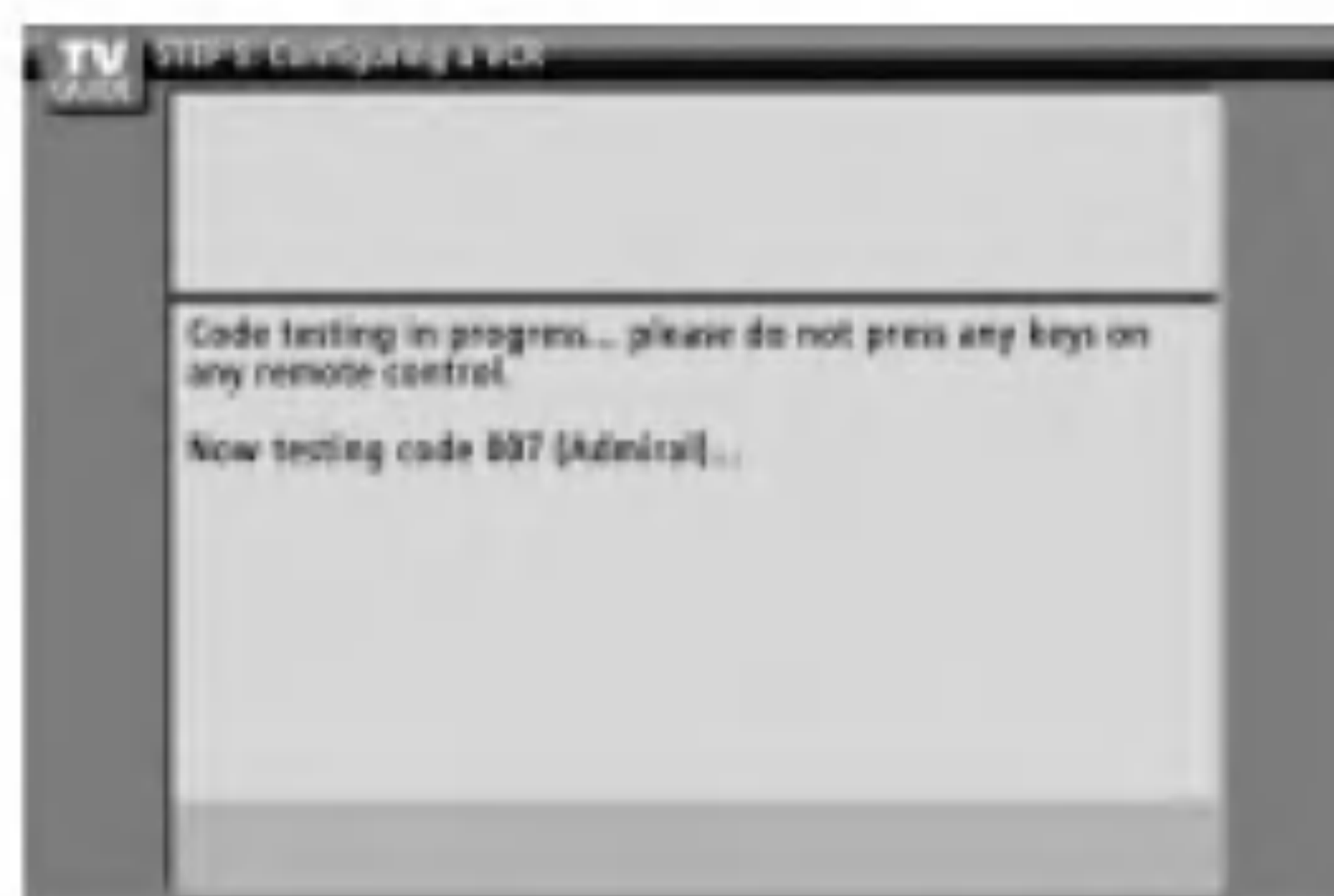

20. Screen 20: VCR Tuned to Channel 9?

- If you select Yes, you see Screen 21.
- If you select No, a different code is tested in Screen 19.

Notes :

- Many VCRs require testing more than one code.
- If you select Test this code again, the same code is tested again in Screen 19.

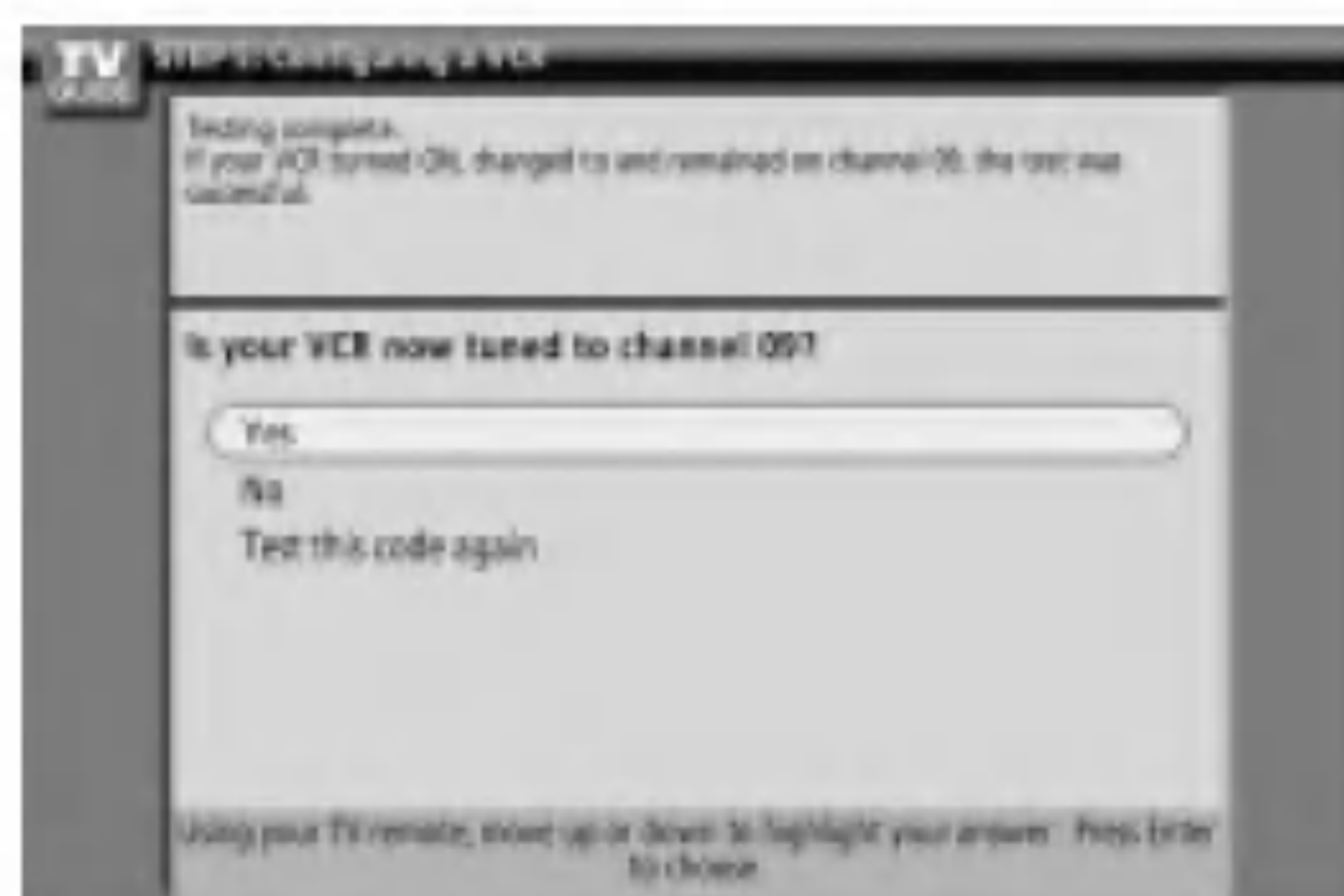

21. Screen 21: Confirming Your Settings

- Verify the Setup information is correct.
- If it is, select Yes, end setup, and you see Screen 22.
- If it is not, select No, repeat setup process, and you see Screen 1.

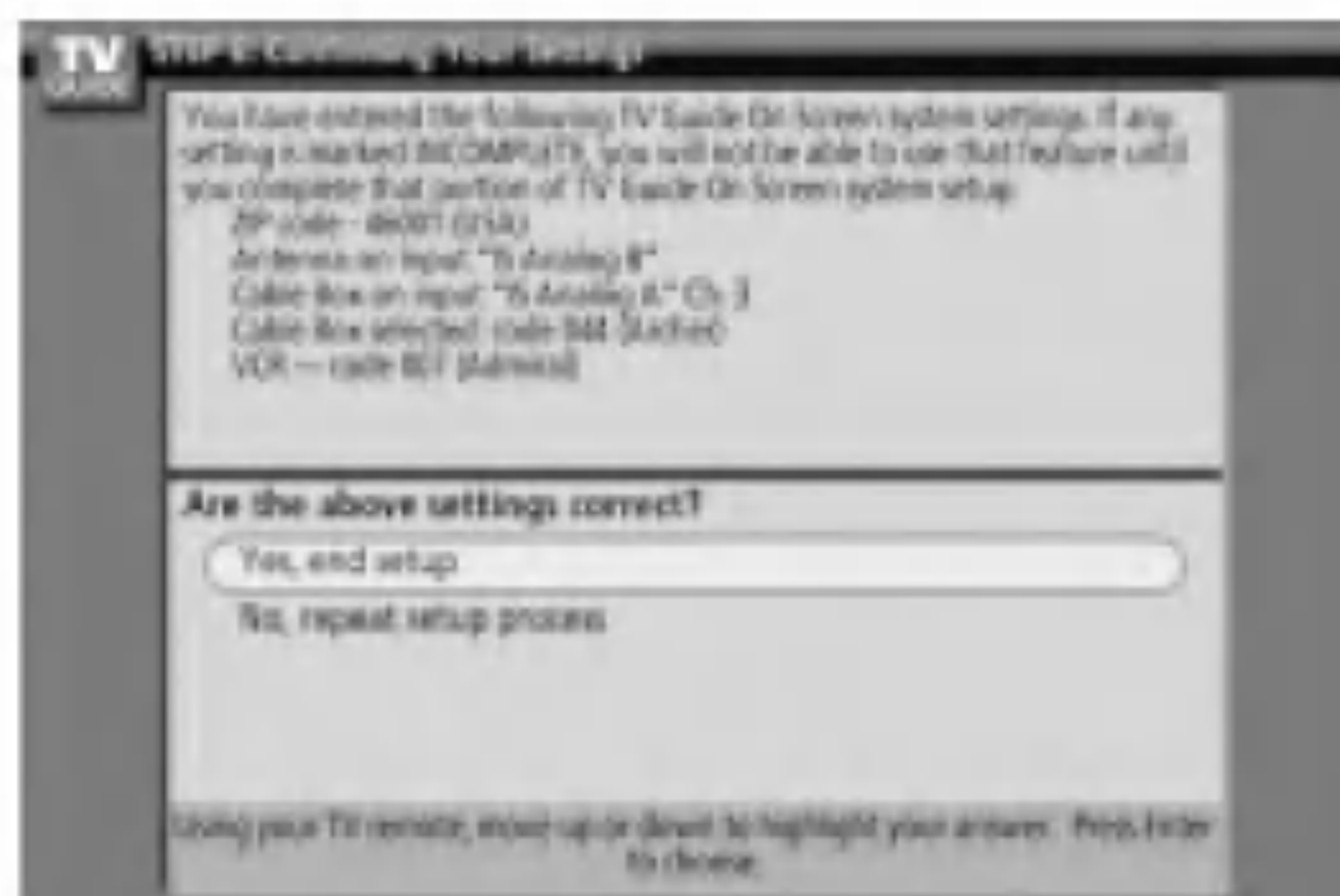

22. Screen 22: Congratulations

- You have successfully completed Setup!
- Press **ENTER** and you see Screen 23.

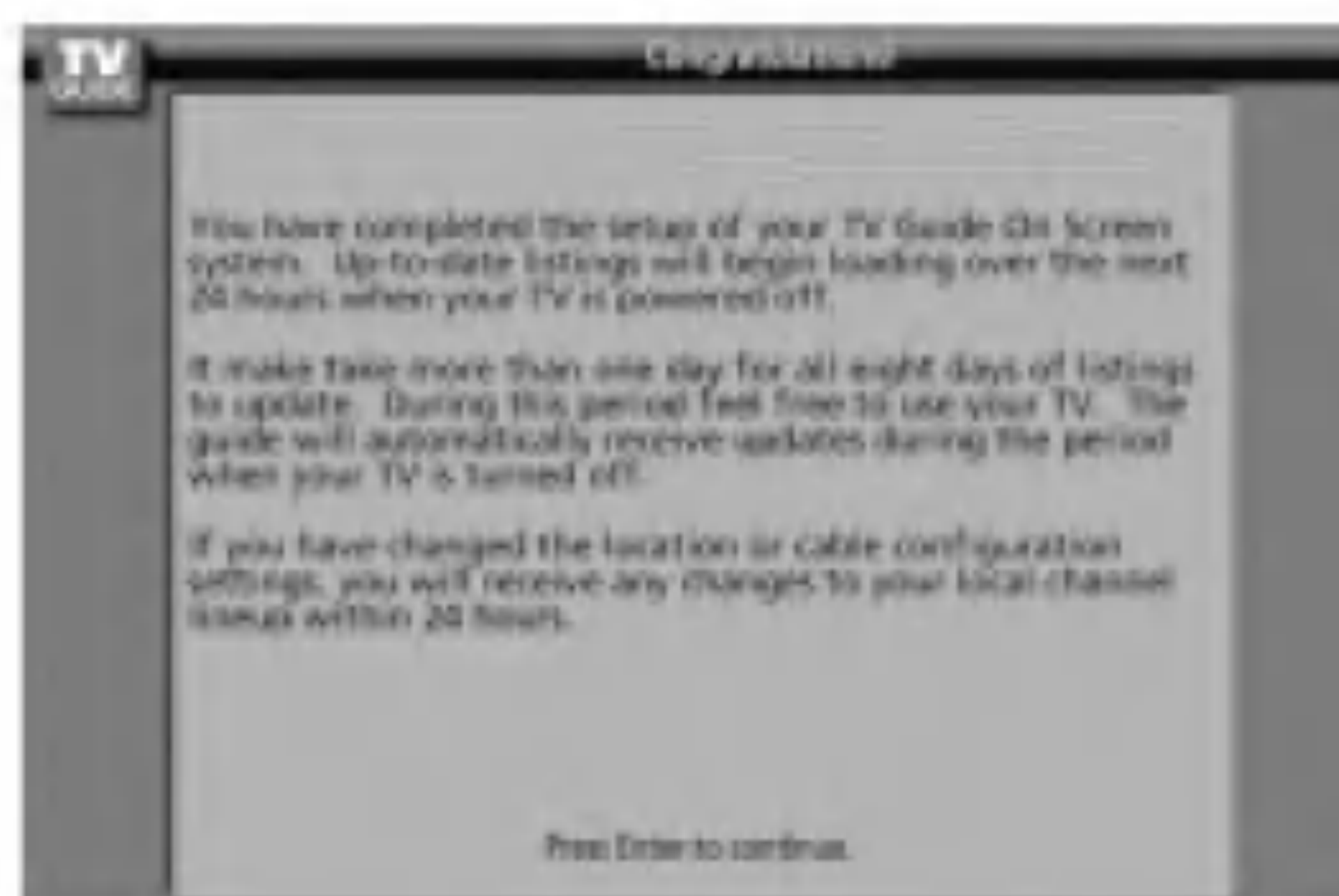

23. Screen 23: Helpful Information

- This screen tells you valuable information on using your TV Guide On Screen system
- Press **ENTER** to watch TV.

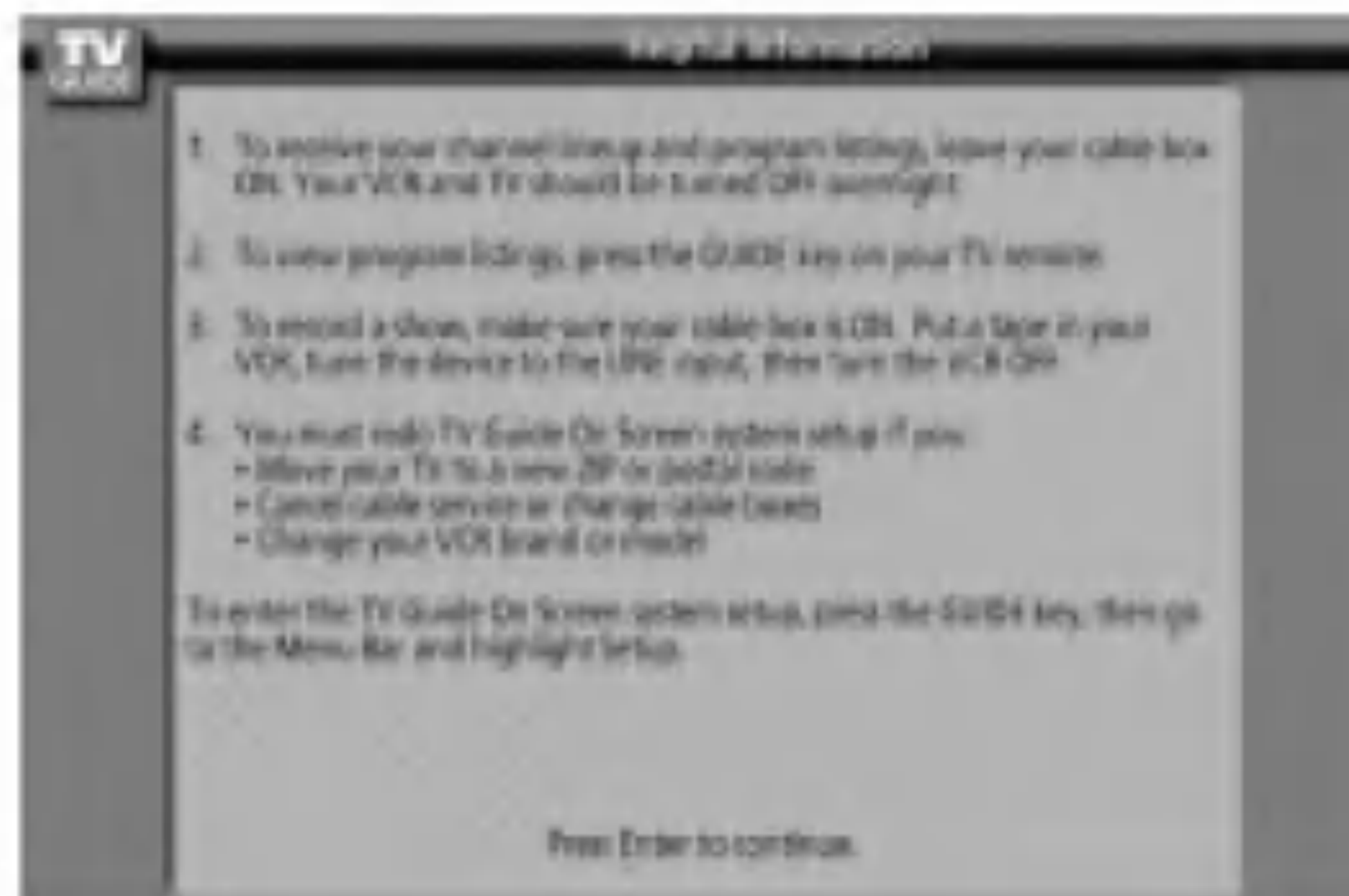

Notes:

- The TV Guide On Screen system receives program listings data through your cable or over-the-air video signal. In order to receive regular program listings, please remember to do the following:

1. Turn OFF your TV when it is not in use. (Do not unplug the power cord.)
2. If you have a Cable box connected, leave the cable box On, but turn the TV Off.
3. If you have a VCR connected, turn it OFF when not in use. (Do not unplug the power cord.)
4. If you have more than one Cable system in your area, you may be prompted to select which Cable system's program data to download. If so prompted, please follow the on-screen instructions.

- Program listings are updated several times a day. It may take up to 24 hours to begin to receive any TV program listings. It may take up to one week to receive all eight days of TV program listings.

● IEEE 1394 Functions

- It's available to communicate to either direction and you can give and take a image, sound, or each control command with one cable.

◆ How to connect the 1394

- To operate the IEEE1394, these methods are available as shown below.

1. When connecting the DVHS or the MicroMV Camcorder, as shown in the (a) or (b) figure, press the  button to show the control panel.

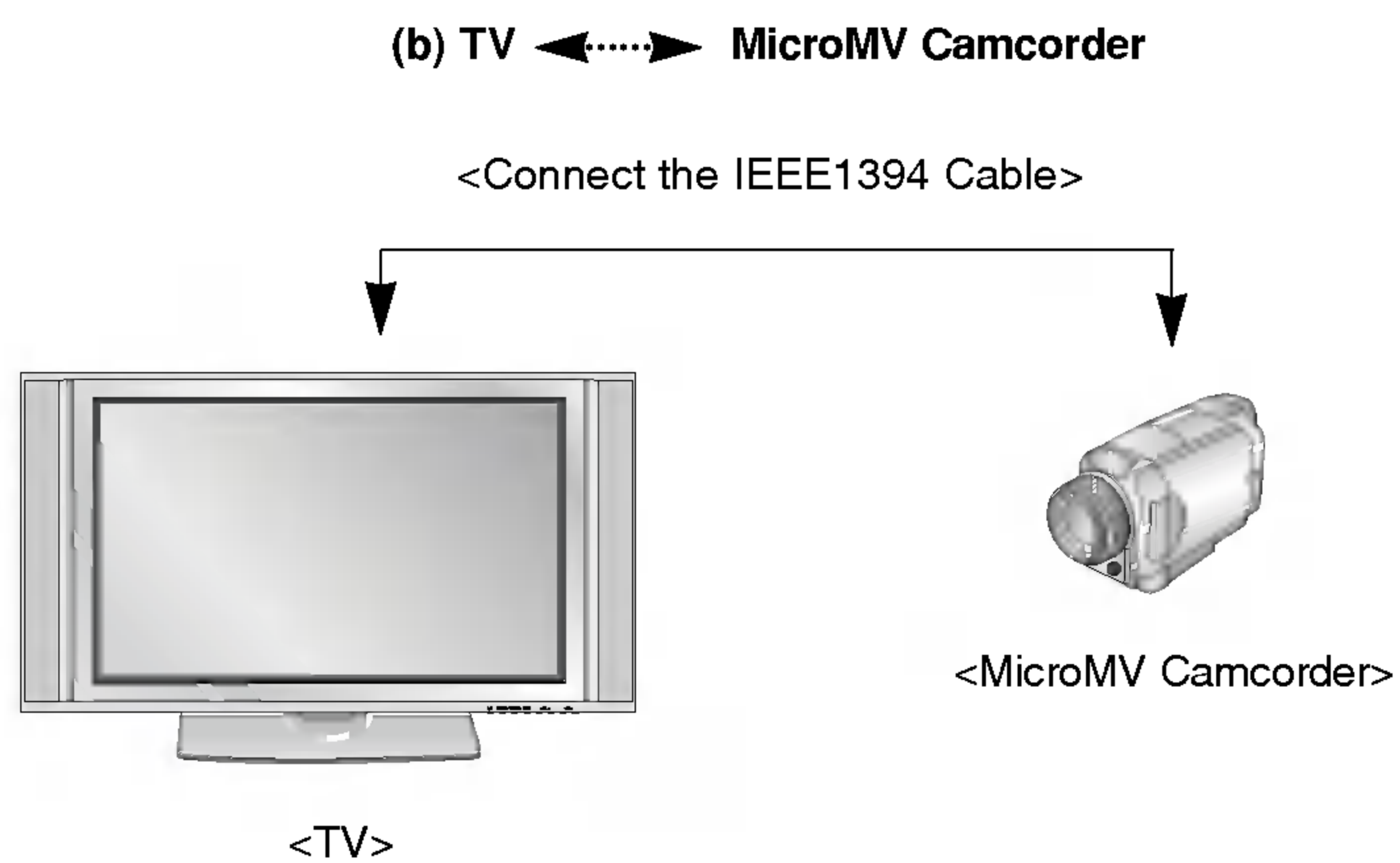
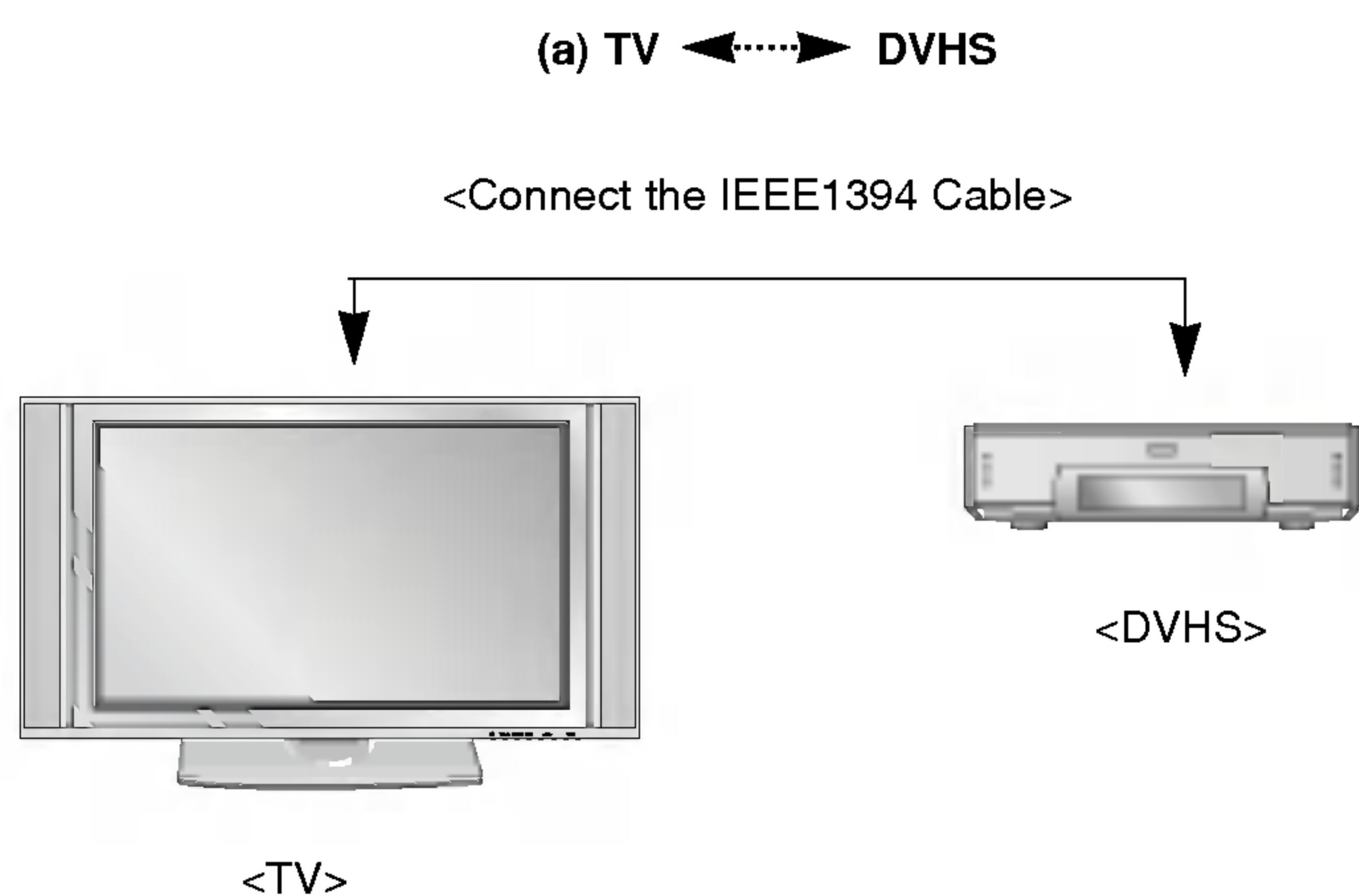

Note: When connecting the DVHS and the MicroMV Camcorder, in case of showing 'input error' on the MicroMV Camcorder window, it's okay.

IEEE 1394 Functions

2. When connecting the DVHS and the MicroMV Camcorder, as shown in the (c) or (d) figure, press the  button to show the control panel and then select the DVHS or the MicroMV Camcorder.

(c) TV  DVHS + MicroMV Camcorder

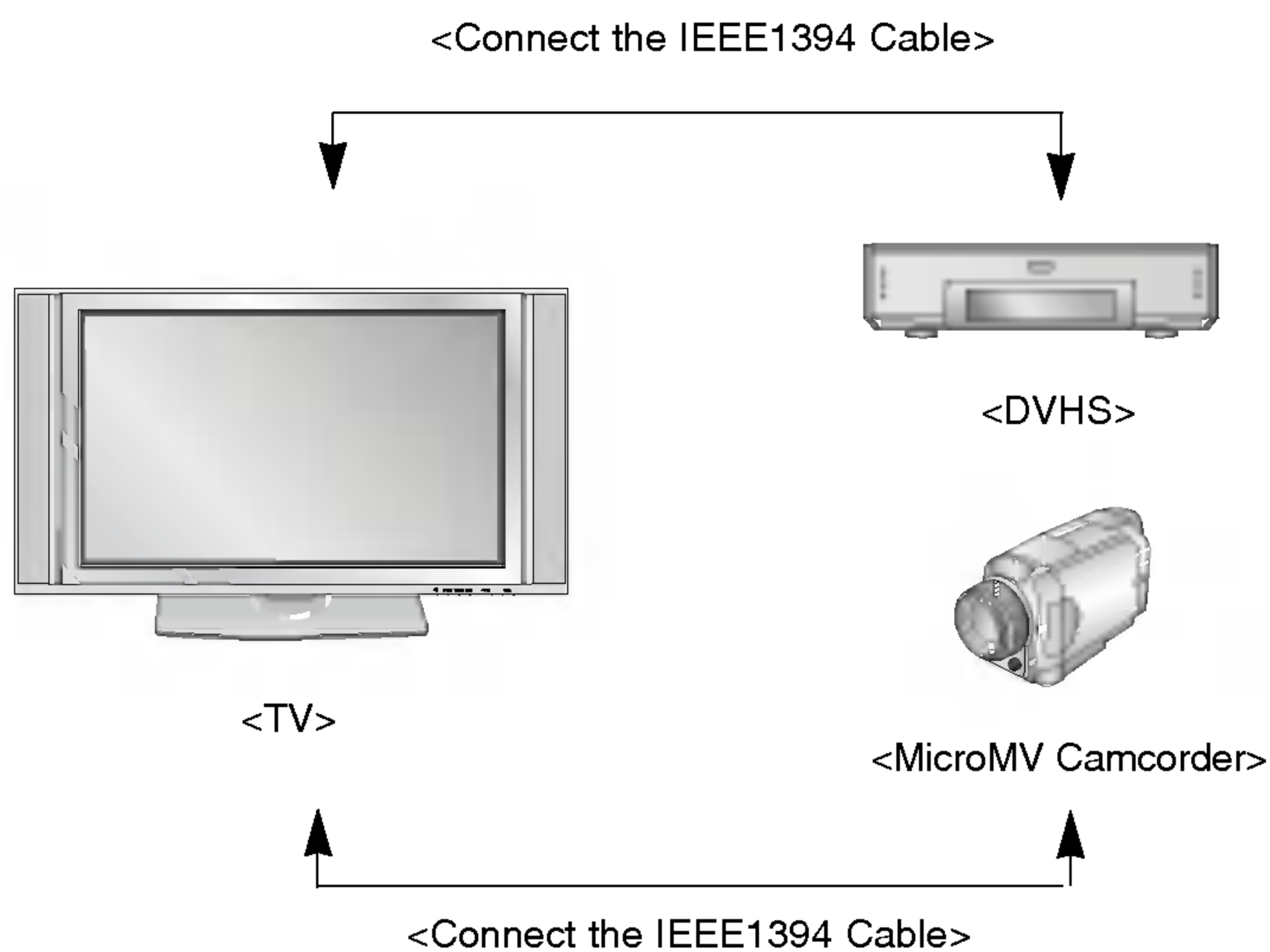

(d) Daisy Chain Connection

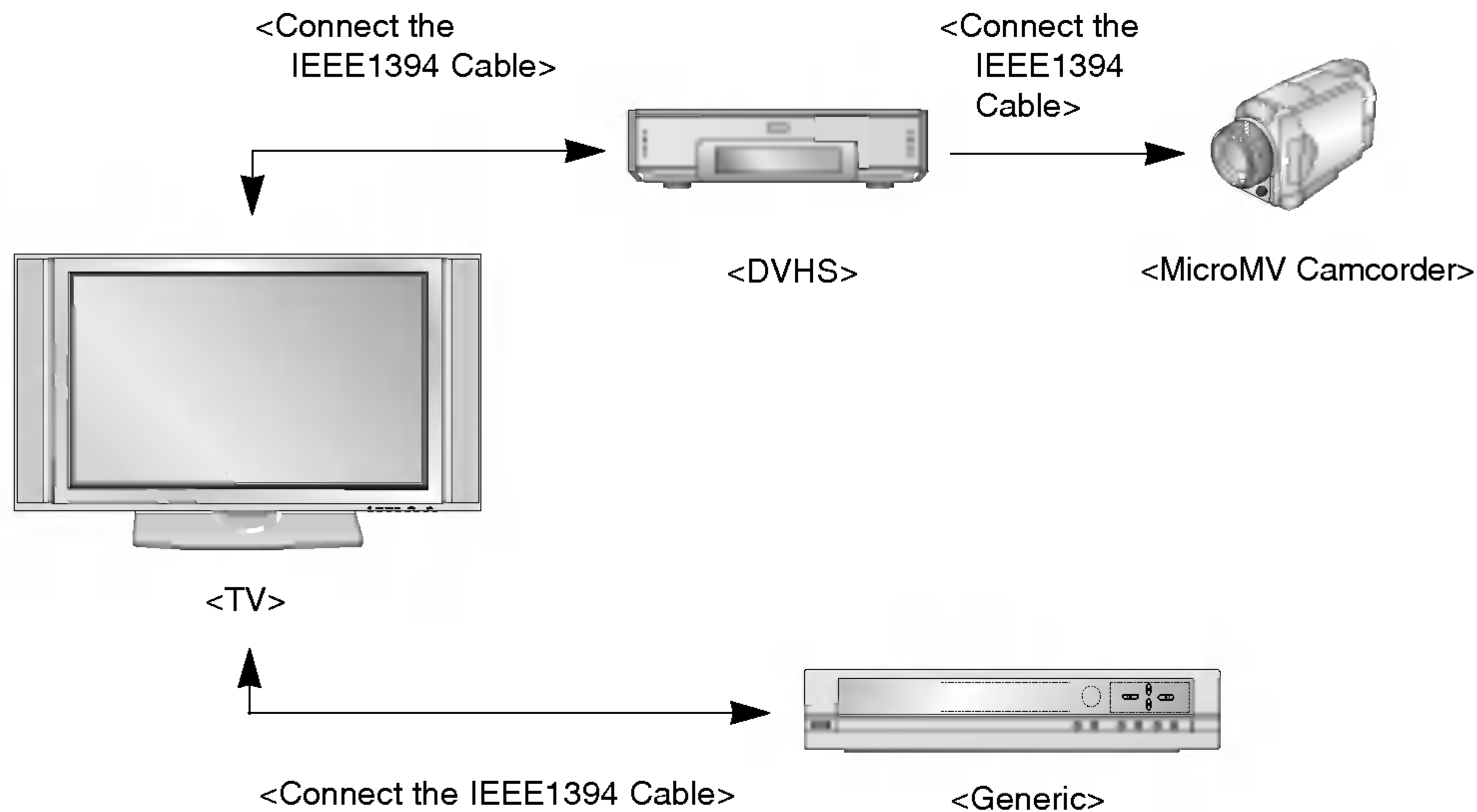

-When connecting the 1394 and then playing, you must use the original DVHS tape. If not, it may occur errors.

-If the operation normally doesn't work on Daisy Chain connection, please change an arrangement of connected device.

DVHS

◆ How to play the DVHS

1. Connect the IEEE 1394 jack at the TV to the IEEE 1394 jack at the DVHS with IEEE 1394 Cable.

2. When watching the TV, press the  button.

<Connect the IEEE1394 Cable>

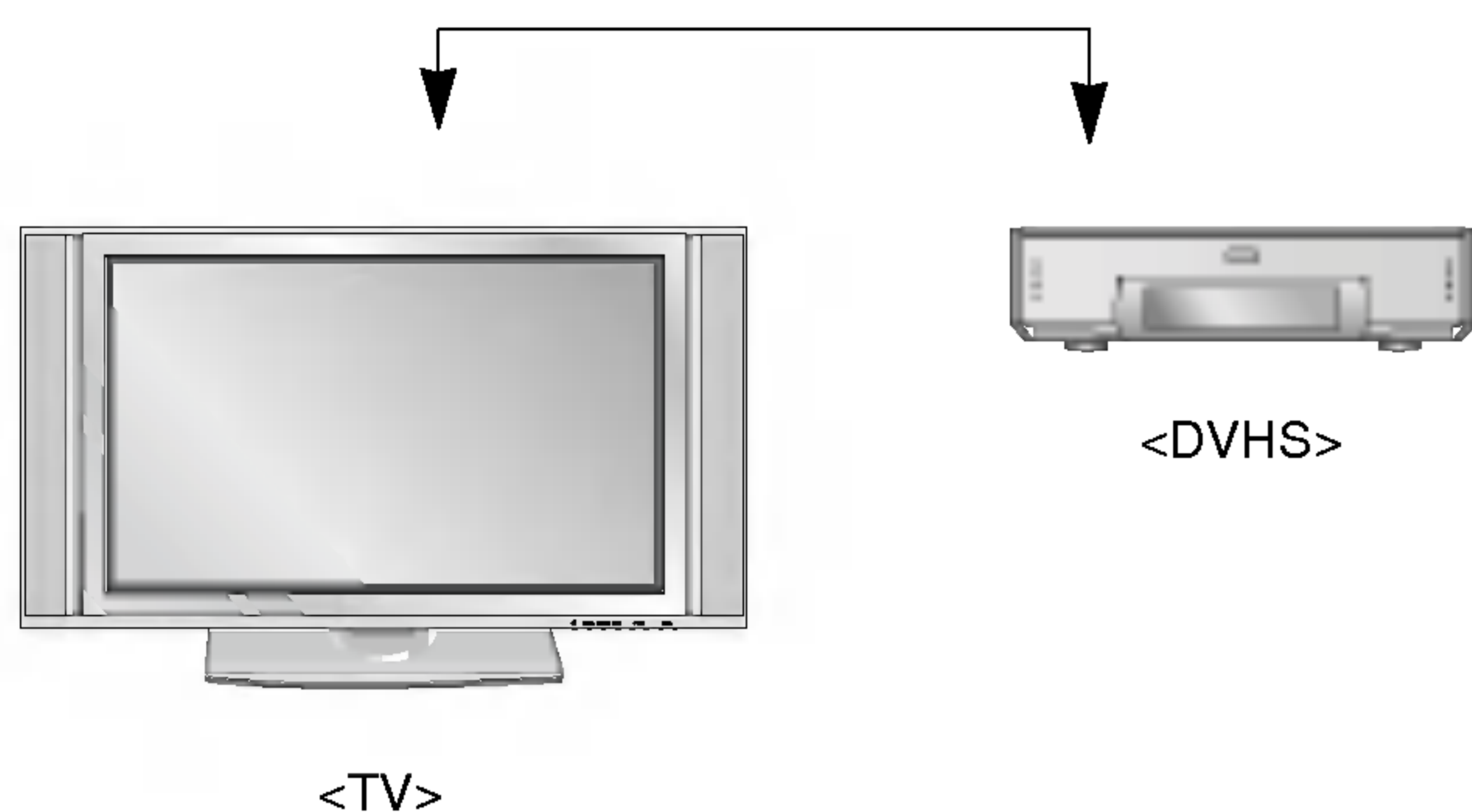

• Show the control panel of DVHS.



• The control panel of DVHS

-Depending on the connected equipment, marked control panel may be different.

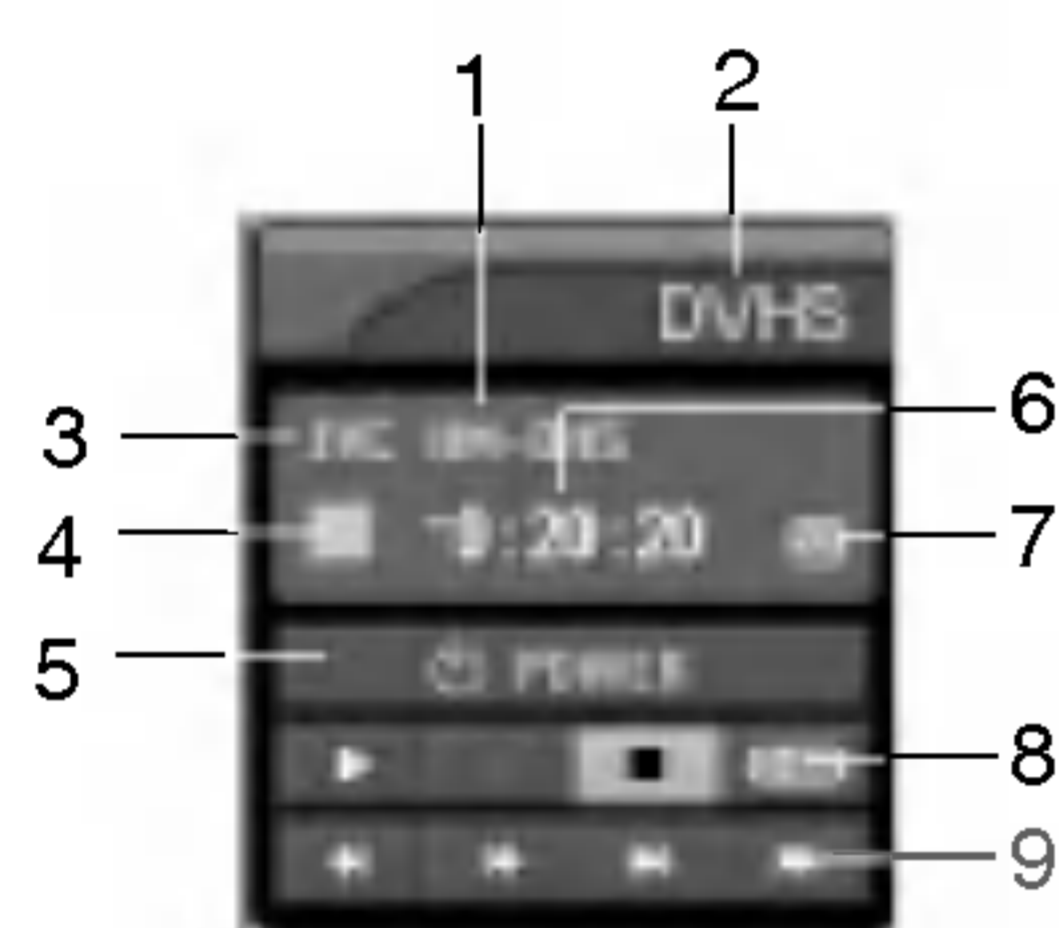

1. DVHS Model
2. Connected Equipment to the 1394
3. DVHS Company
4. DVHS Operating Status
5. Power On/Off
6. DVHS Play Time
7. Tape Status
 - Tape shape Icon - Tape in or not
 - Lock shape Icon - Writable or not
8. Initializing Play Time
9. DVHS Play, Pause, Stop, Search, Skip.

* Supported DVHS List

- JVC(HM-DH40000K)
- JVC(HM-DH40000U)
- JVC(HM-DH5U)
- MITSUBISHI(HV-HD1000)
- PANASONIC(NV-DH2)

(Notes:

- Skip- This function is for a fast search. It searches the program's start point. On skipping, Search (◀▶), Pause (||) and Play (▶) are displayed on the Control Panel. In some models, it's not available to operate the Skipping (◀▶) function.

Notes:

- In case the DVHS have a incorrect recognition, the power cord of DVHS is completely pull out and then connect again.
- When searching the screen(◀▶), the DVHS may be strangely seen. And also the DVHS may late respond by devices.

IEEE 1394 Functions

MicroMV Camcorder

◆ How to play the MicroMV Camcorder

1. Connect the IEEE 1394 jack at the TV to the IEEE 1394 jack at the MicroMV Camcorder with IEEE 1394 Cable.

2. When watching the TV, press the  button.

<Connect the IEEE1394 Cable>

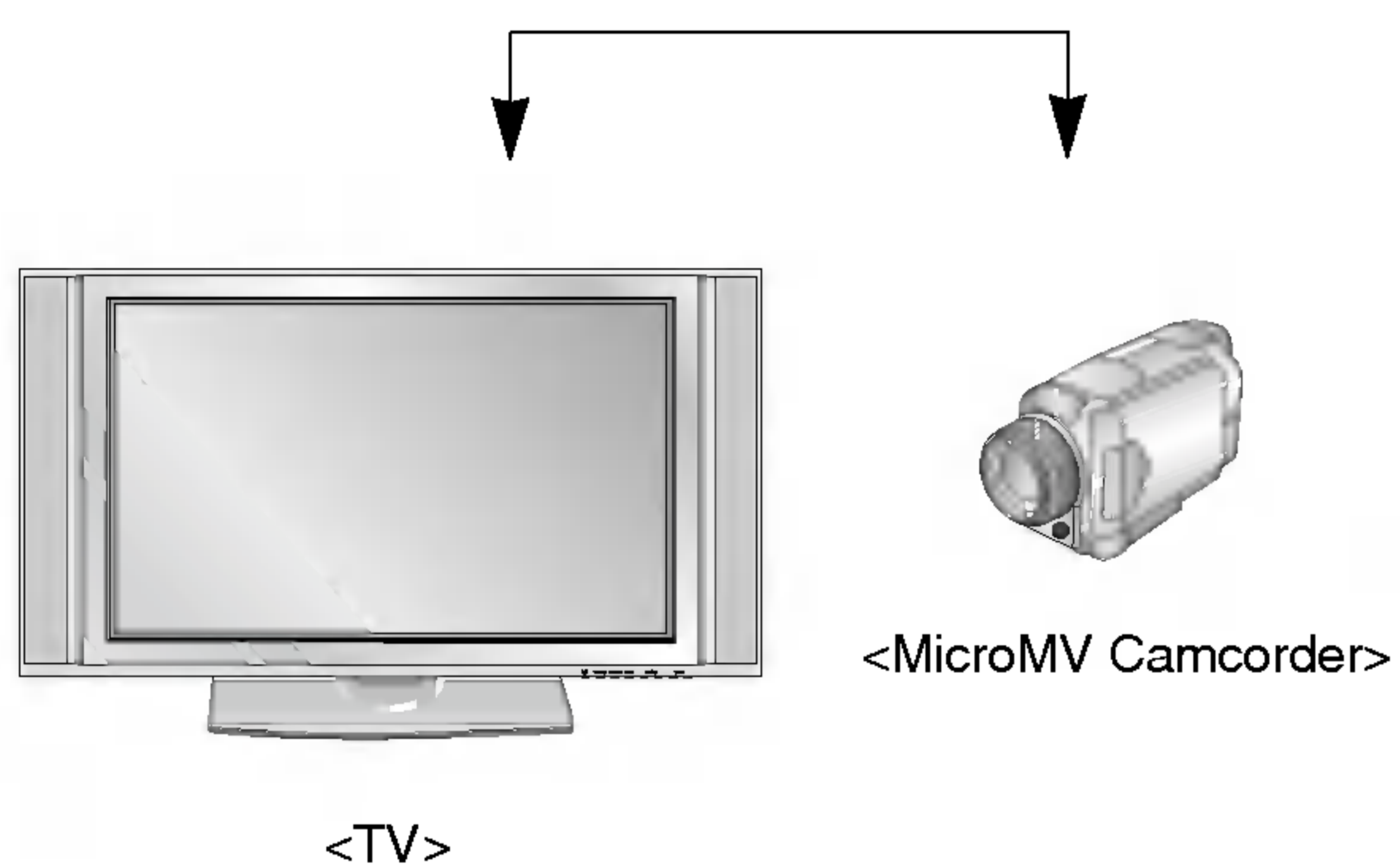

• Show the control panel of MicroMV Camcorder.



• In camera mode of MicroMV Camcorder, this control panel is showed.

• Show the control panel of CAM.



- The control panel of MicroMV Camcorder
- Depending on the connected equipment, marked control panel may be different.

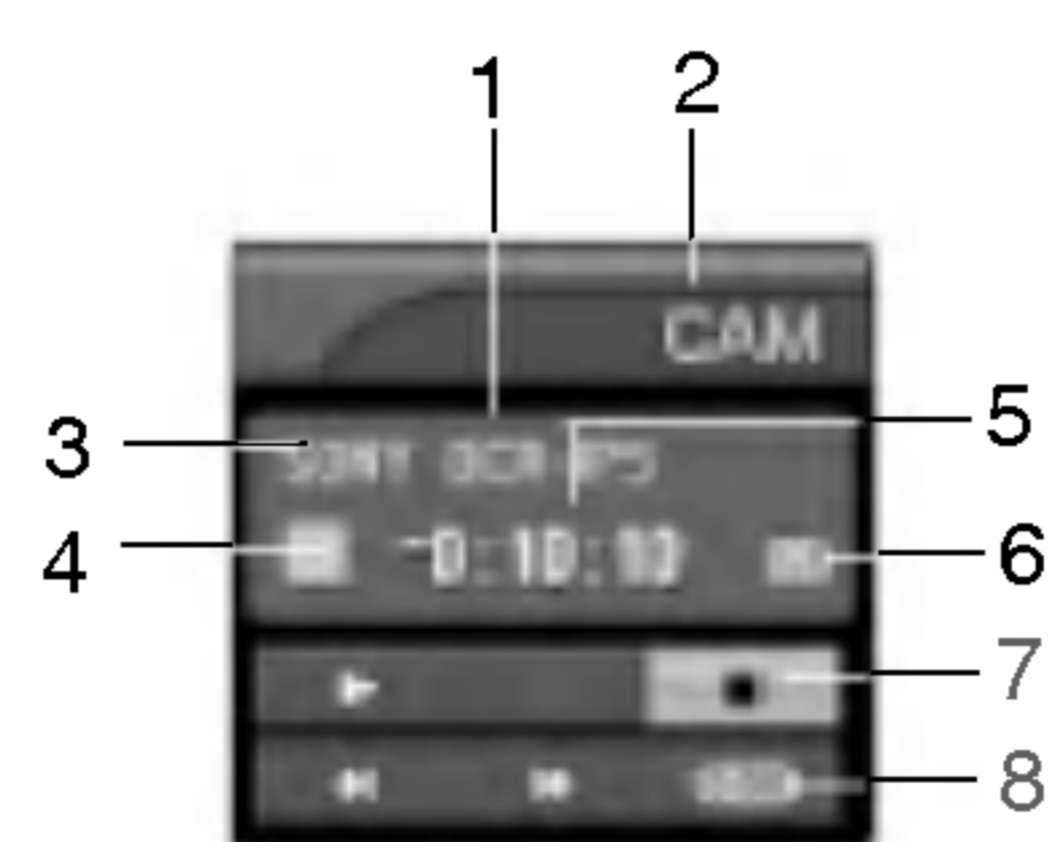

1. MicroMV Camcorder Model
2. Connected Equipment to the 1394
3. MicroMV Camcorder Company
4. MicroMV Camcorder Operating Status
5. MicroMV Camcorder Play Time
6. Tape Status
 - Tape shape Icon - Tape in or not
7. MicroMV Camcorder Play, Search, Pause or Stop
8. Initializing Play Time

* Supported MicroMV Camcorder List

SONY DCR IP-1
SONY DCR IP-5
SONY DCR IP-45
SONY DCR IP-210

Notes:

- In memory mode of MicroMV Camcorder, it doesn't apply to connect the IEEE1394.
- Regardless of a mode of MicroMV Camcorder, if the tape is ejected, it doesn't apply to connect the IEEE1394.

IEEE 1394 Functions

MicroMV Camcorder and DVHS

◆ How to play the MicroMV Camcorder and DVHS

1. Synchronously, connect the IEEE 1394 jack of the TV to the IEEE 1394 jack of the DVHS and the MicroMV Camcorder with IEEE 1394 Cable.



2. Press the ▲ / ▼ button to select device, then press **ENTER** button to play it . And then selected device will be showed OSD.



DTV Link : DTV Link applies to 1394 connection of device labeled DTV Link logo.



*** What's the DTV Link?**

It is normal standard of CEA which restricts by a remote and displays OSD and plays to stream of a remote control by using a connection of IEEE1394.

◆ **How to play the DTV Link**

1. Connect the IEEE 1394 jack of the TV to the IEEE 1394 jack of the DTV Link supported device IEEE 1394 Cable.

2. When watching the TV, press the  .

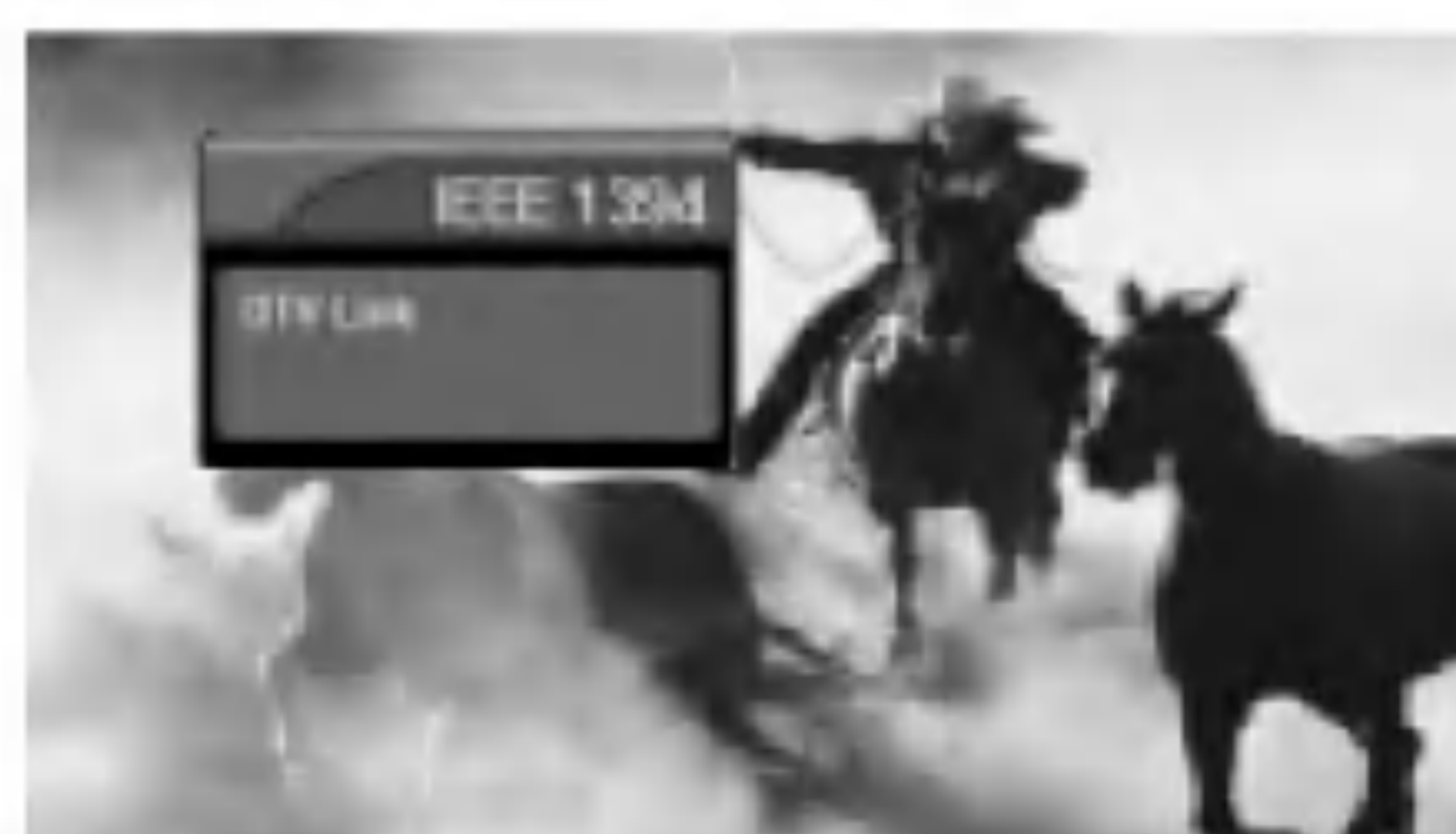
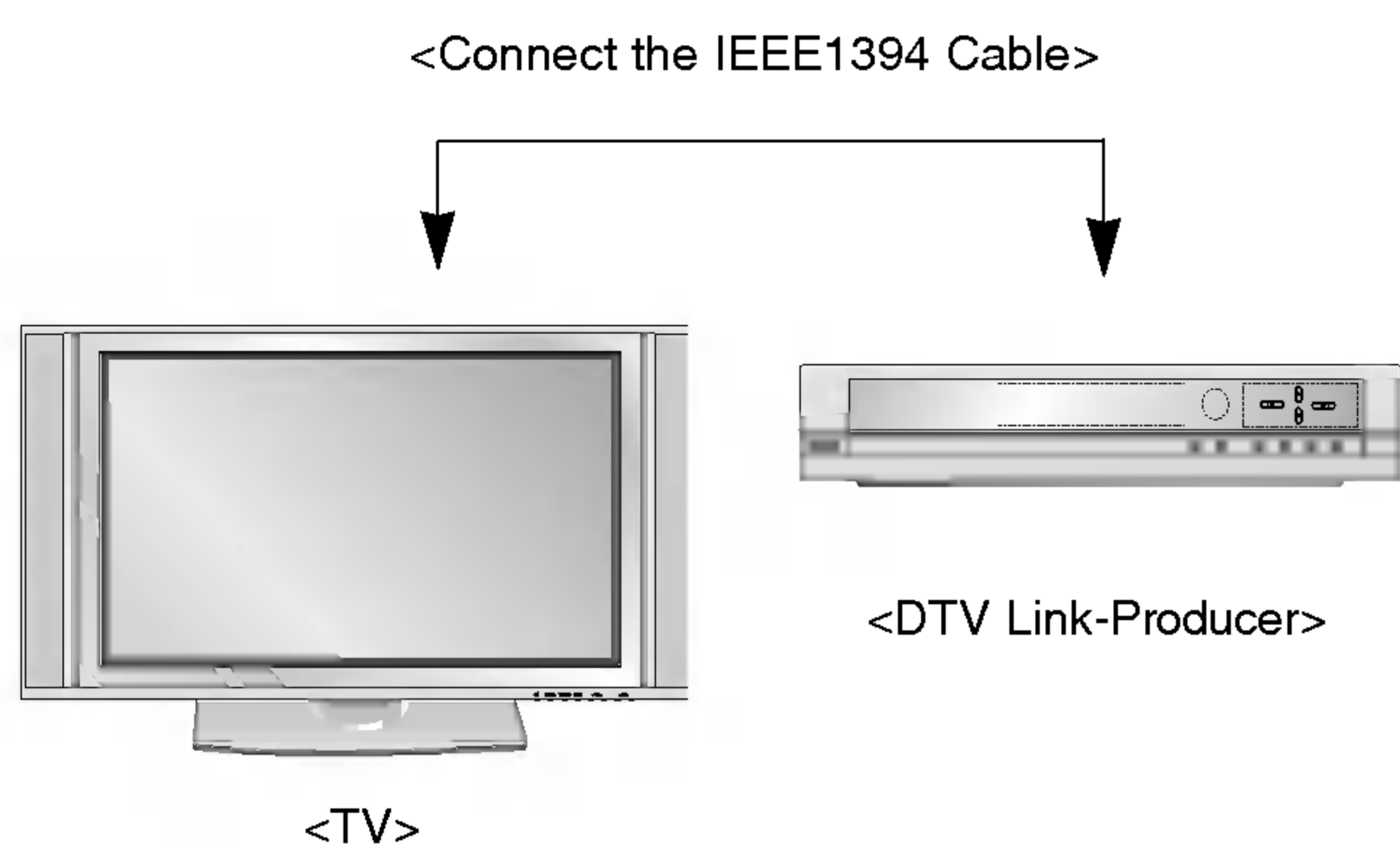

3. Press the **TV INPUT** button to stop the IEEE1394 function.

Notes:

- On a condition of connecting the IEEE 1394, you can control the DTV Link device while watching the OSD through DTV and DTV remote control.
(ex: change of channel, play, record, a show of recording list etc.)
- Analog channel is not supported.
- In case a device outputting MPEG2 TS Data through IEEE1394 port but it doesn't support to DTVLink, you are able to see a screen even if it doesn't control directly on TV.

● IEEE 1394 Functions

◆ Don't connect !

- When connecting with these 2 methods, the **IEEE1394 will not work properly.**

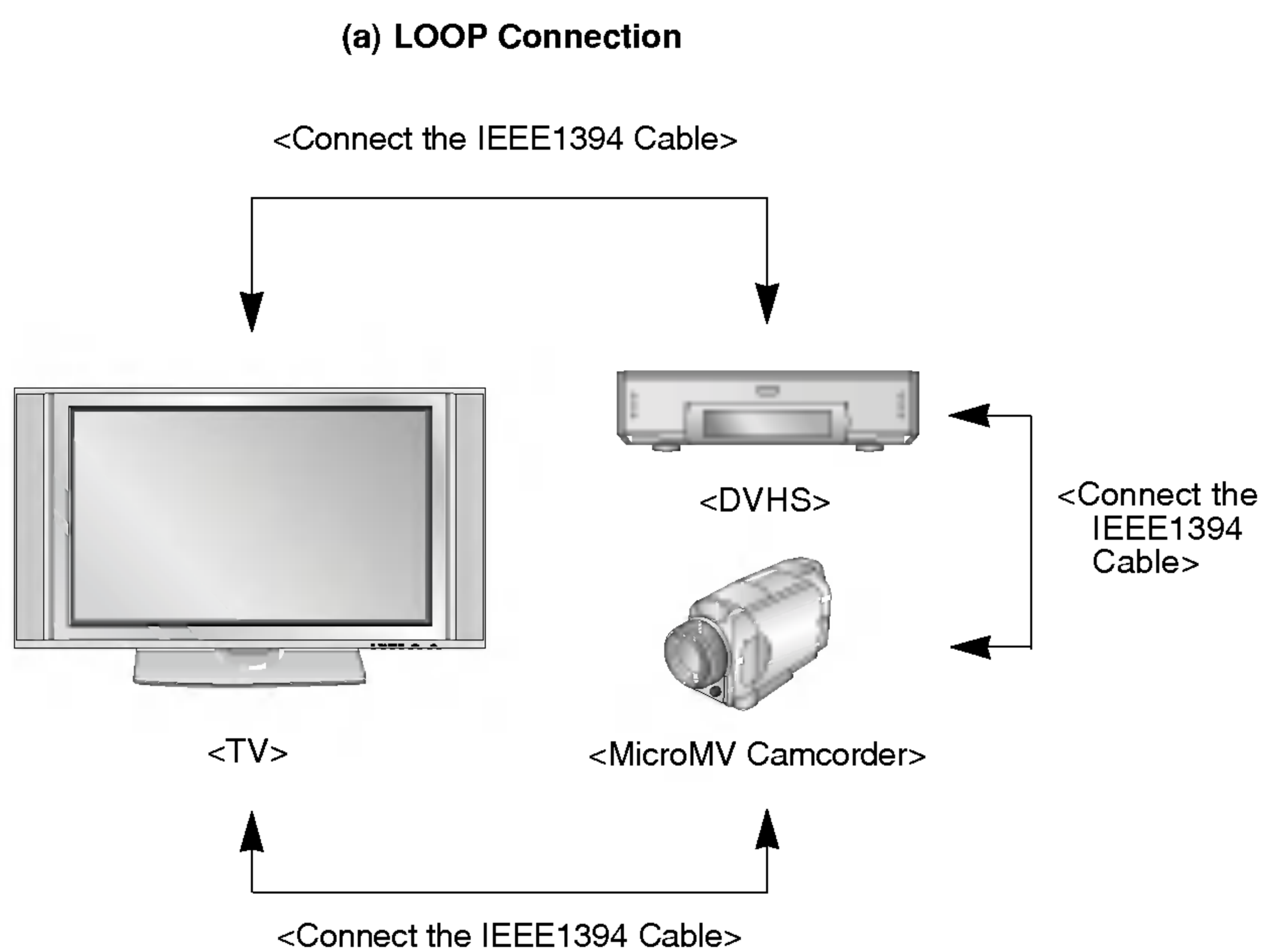

- (b) When connecting the 4 devices and over, the 1394 will not work properly.

Note: When the same devices connect with 2 devices and over, it's undesirable.

TV Guide On Screen™ System

Overview

- Your new TV contains the TV Guide On Screen Interactive Program Guide.
- The TV Guide On Screen system has features that help you get the most out of your viewing experience.

TV Guide On Screen system Overview

The TV Guide On Screen system has the following features:

- Eight days of show listings (today plus seven days).
- Icons that indicate show rating, stereo, HDTV, new episode, etc.
- Intuitive up/down/left/right navigation using your remote control.
- Set shows to Record.
- Schedule show Reminders.
- Search shows by category (e.g., Movies, Sports, Children, etc.).
- Search for shows based on keywords or alphabetically by title.
- Direct tuning to a channel.
- Show information while watching TV.
- Streamlined System Setup and default setting options.
- Channel lineup customization.
- Help screens while in the TV Guide On Screen system.

● TV Guide On Screen™ System

Screen Components

- The screens displayed in the TV Guide On Screen system share many of the same components, as shown in the following figure:



- Video Window** - displays TV video while the TV Guide On Screen system is displayed
- Service Bar** - provides access to the 4 main Guide Services
- Current Service Label** - indented to indicate current Service displayed
- Tile** - displays show title
- Highlight** - indicates an active tile
- INFO Box** - provides information for a highlighted item
- INFO Button** - indicates you can cycle through the various Info Box sizes
- Channel Logo** - identifies network
- Record/Remind Icons** - indicates a show is set to Record or set as a Reminder
- Panel Ad** - location where show- or product-specific information appears (and also where Panel Menu appears)

Panel Menu



- A Panel Menu appears when the Menu key is pressed on a highlighted tile and additional options are available. It also appears when you press **ENTER** on a show starting in the future.
- When a Panel Menu appears, the highlighted tile changes color to indicate the Panel Menu relates to this tile.
- The Panel Menu displays below the Video Window.
- Help is available for a displayed Panel Menu by pressing the **INFO** button.
- The **▲ / ▼** button move between the options within the Panel Menu.
- The left and right arrows move to adjacent options unless the highlight is on an odometer, where these arrows change the odometer choice.
- Pressing **ENTER** from an odometer or number entry box moves the highlight to the default command button of that Panel Menu, for example, Schedule Reminder.
- Pressing **ENTER** from a highlighted command button executes the action and closes the Panel Menu (e.g., Schedule Reminder, Cancel).
- Select Cancel to cancel any changes and press **ENTER** to close this menu.
- Pressing Menu is a shortcut to Cancel. Press Menu to cancel any changes and close the menu.
- If a Panel Menu contains more menu options than can be displayed on a single screen, **▲ / ▼** button appear at the top or bottom of a menu. Simply scroll down to access these options.

TV Guide On Screen™ System

Main Services

Listings

- Access Listings by pressing the TV Guide button on your remote or on the front panel of your TV.
- Listings is always the first Service displayed in the TV Guide On Screen system.
- With Listings highlighted, press the Info button to display a Help screen. Press the Info button again to close the screen.

Use the ▲ / ▼ / ◀ / ▶ buttons to move the highlight within Listings to:

- View 8 days of show listings
- Read show descriptions
- Tune directly to a show currently airing
- Set a show to Remind
- Set a show to Record
- Lock and unlock the Video Window
- Access Panel and Channel Ads

Notes:

- There may be times when the TV Guide On Screen system could display partial or no program listings. The reasons for this include:

1. Program schedule information was not provided to TV Guide On Screen.
2. The transmission of the program listings was interrupted.
3. The phrase "No Listings" will be replaced with program information during the next transmission, which should occur within the next 24 hours.
4. Please remember to turn off your TV when not in use in order to receive program listings.

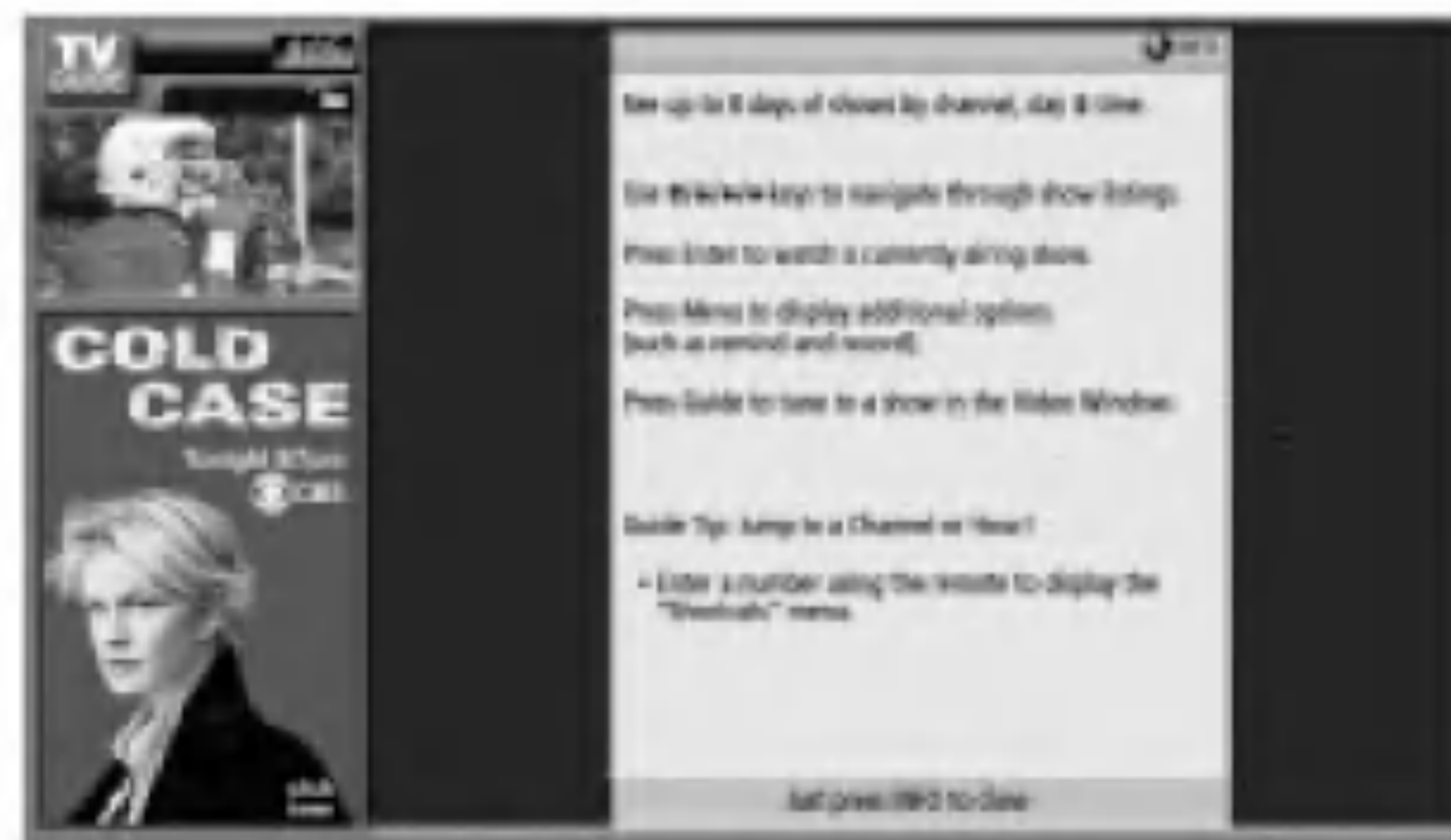

Search

- Search lets you find shows by category (Alphabetical, Movies, Sports, Children, Educational, News, Variety, Series, HDTV) or by Keyword.
- With Search highlighted, press the **INFO** button to display a Help screen. Press the **INFO** button again to close the screen.

•Category Search Example: Movies

1. From Search, use the ▼ button to highlight Movies.

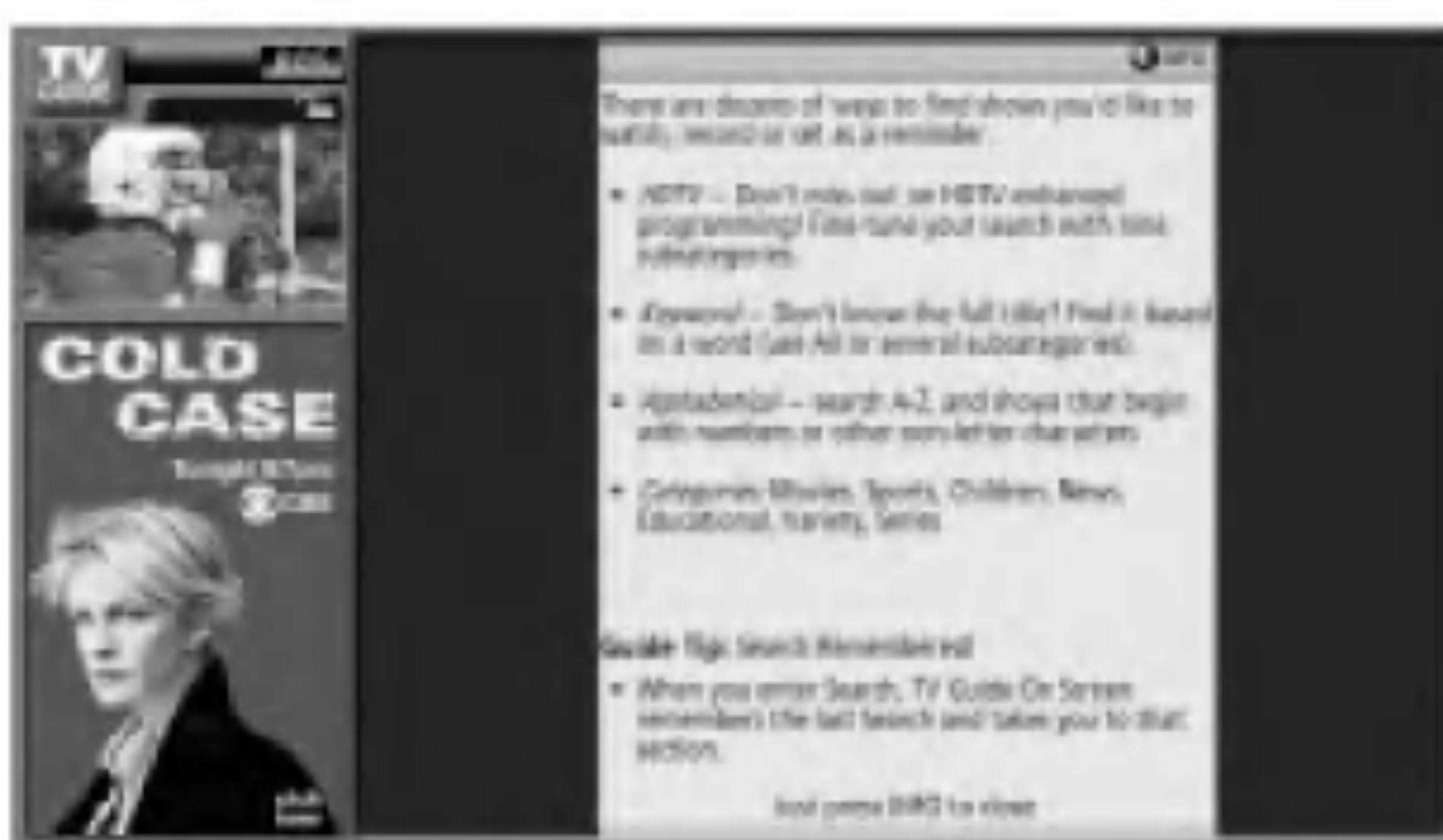

● TV Guide On Screen™ System

2. Use the ▼ button to highlight a subcategory (for example, All).
3. Press **ENTER** to display a list of all Movies, organized by date and time.



4. Highlight a show and press **ENTER** to watch (if on now) or the Menu key to display the Episode Options menu.



You can choose to set a recording, a reminder, or tune to the channel.

Go to Service Bar - closes the menu, changes no information, and returns to the Search Service Bar.

Tune to Channel - exits the TV Guide On Screen system and tunes to the channel of the highlighted show (show airs in the future).

Note: This option reads Watch Now if the show is currently airing.

Set Recording - displays the Record Options menu, from which you can set frequency, start and end time, etc.

Set Reminder - displays the Remind Options menu, from which you can set frequency, start time, automatically power On, and auto-tune the TV.

Cancel - closes the menu, changes no information, and returns to the highlighted show.



• Keyword Search

- **Keyword search** lets you enter a word(s) to look for a particular show by category or for every show title that matches.

1. Highlight the Keyword navigation label, and press **ENTER** button to display the Keyword **Search** menu.
2. Highlight New Search, and press **ENTER** button.



3. The Search Options menu is displayed.
4. Highlight Category, and use the ◀ / ▶ button to select a category to search (e.g. All, HDTV, Children, Sports, etc.). When finished, use the ▼ button to highlight Enter Keyword.
5. Highlight Enter Keyword, and press **ENTER**.



6. Use the ▲ / ▼ / ◀ / ▶ button to highlight a character, and press **ENTER** to display it. When complete, highlight Done and press **ENTER**.



● TV Guide On Screen™ System

7. A list of all matching shows for that keyword is displayed.

You can highlight a show, and press **ENTER** to display all airings. You can then highlight a specific listing and press **ENTER** to watch (if On now) or the Menu key to display the Episode Options menu.

From the Episode Options menu, choose to set a recording, a reminder, or tune to the channel, as previously described.



The TV Guide On Screen system stores all the keywords you create. To edit or delete a keyword, highlight the keyword and press the Menu key. A Search Options menu is displayed.

Go to Service Bar - closes the menu, changes no information, and returns to the Search Service Bar.

Edit Search - displays the keyboard, where you can change the keyword.

Delete Search - A Confirm menu is displayed.

- **Yes** - deletes the Search
- **No** - closes the panel menu



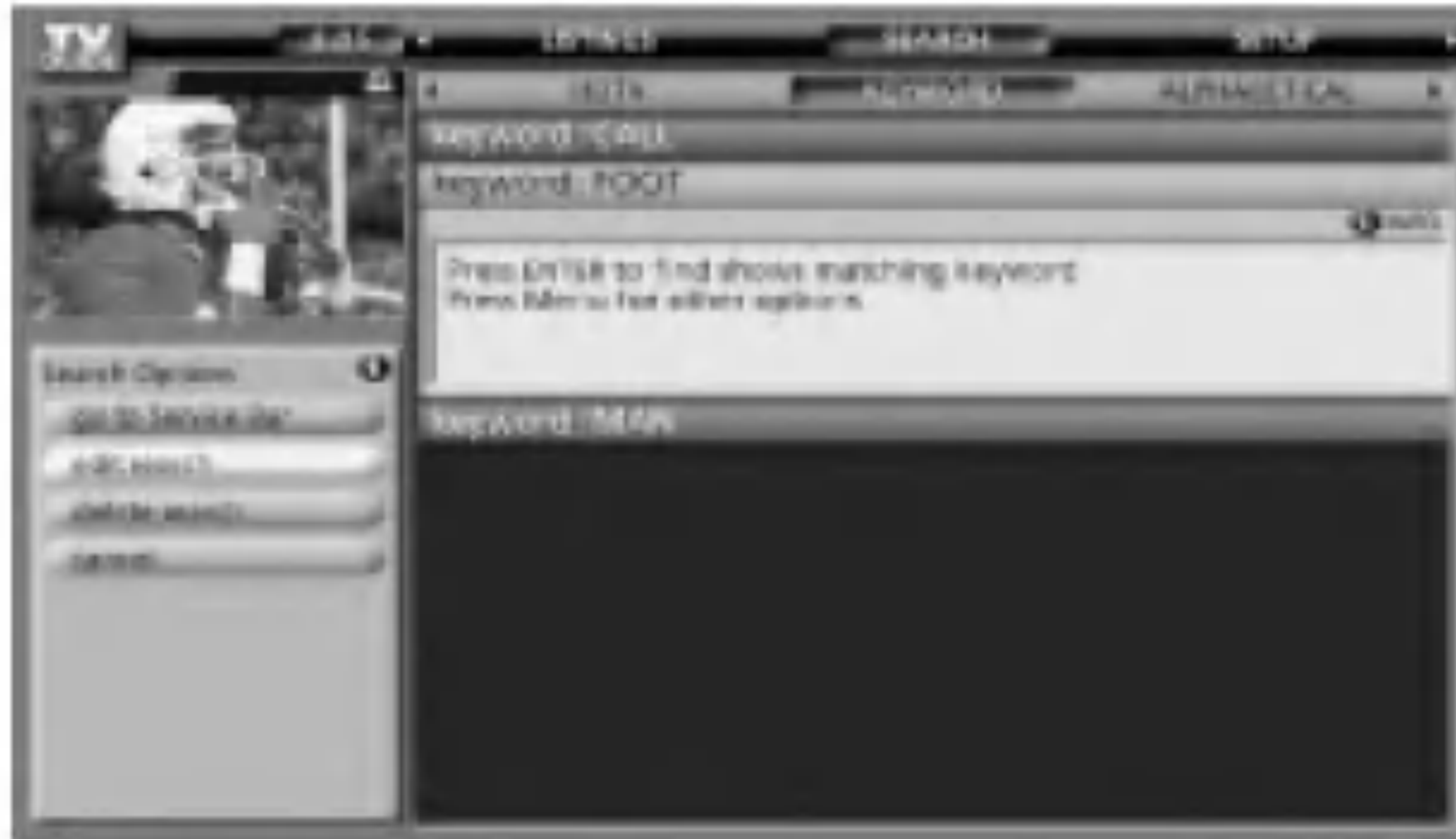

Cancel - closes the menu, changes no information, and returns to the highlighted show.



Schedule





- Schedule lets you review, edit, or delete Record and Remind events that you set previously.
- With Schedule highlighted, press the **INFO** button to display a Help screen. Press the **INFO** button again to close the screen.
- An icon identifies the event type:

Record

- ◆ Once  —records the show one time
- ◆ Regularly  —records the show every time the show airs on the same channel and starts at the same time
- ◆ Weekly  —records the show each time the show airs on the same day of the week, on the same channel and starts at the same time
- ◆ Off  —keeps the show in the list but will not record this show until the frequency is changed.



Remind

- ◆ Once  —sets a show reminder one time
- ◆ Regularly  —sets a show reminder every time the show airs on the same channel and starts at the same time
- ◆ Weekly  —sets a show reminder each time the show airs on the same day of the week, on the same channel and starts at the same time
- ◆ Off  —keeps the show in the list but will not remind until the frequency is changed

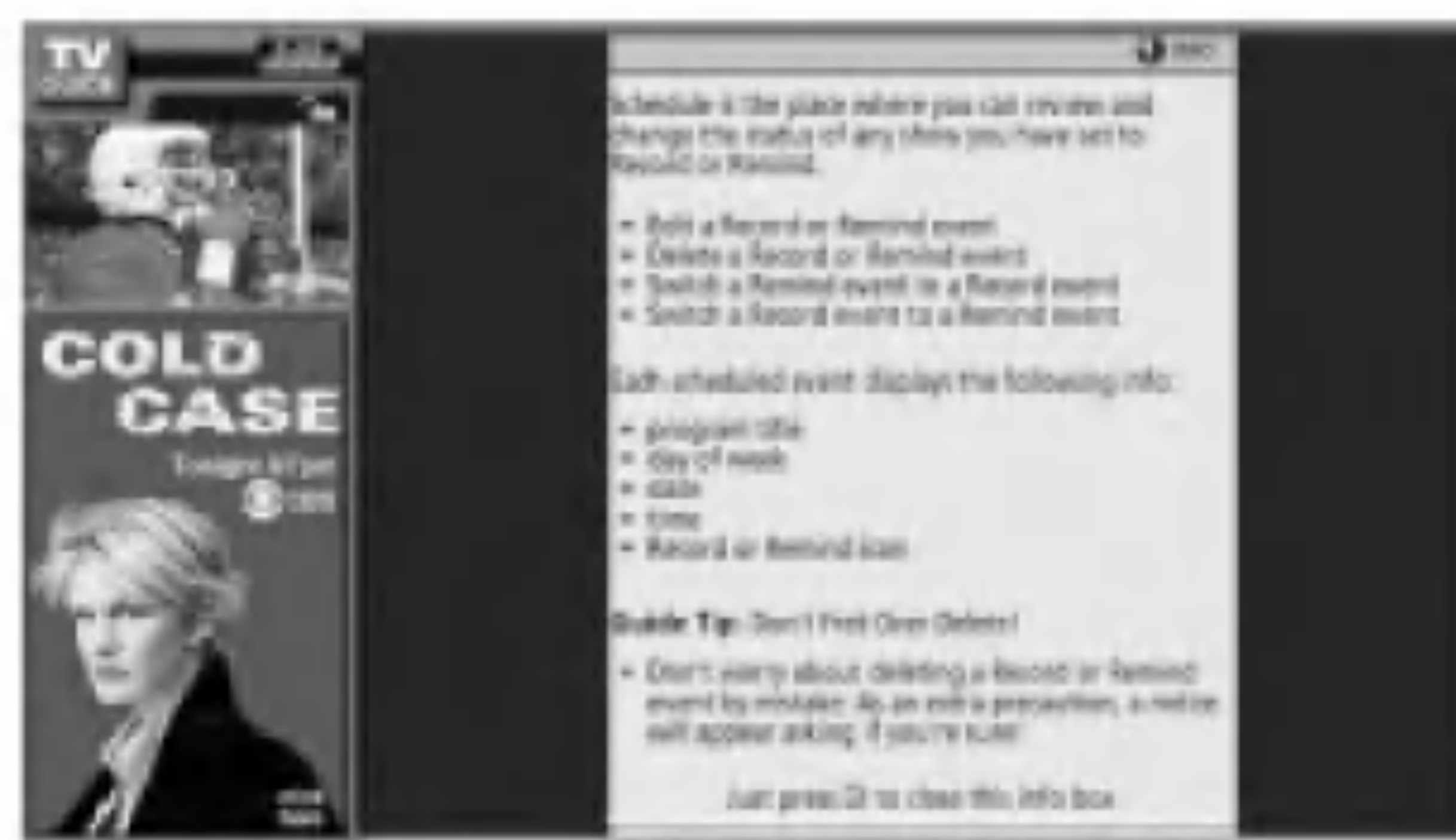

Highlight an event, and press the Menu key for options.

Go to Service Bar - closes the menu, changes no information, and returns to the Schedule Service Bar.

Tune to channel - exits the TV Guide On Screen system and tunes to the highlighted show.

Delete Recording - removes the recording from the Schedule, after a Confirm screen.

Edit Recording - opens a menu from which you can change existing recording information.

Set Reminder - opens a menu from which you can set a Reminder for the show (Record is not cancelled).

Cancel - closes the menu, changes no information, and returns to the highlighted show.



TV Guide On Screen™ System

Setup

- After you initially complete Guide Setup, you can make changes to Guide settings in the following areas:

- Change System Settings
- Change Channel Display
- Change Default Options

Highlight a choice, press **ENTER**, and follow the on-screen instructions.

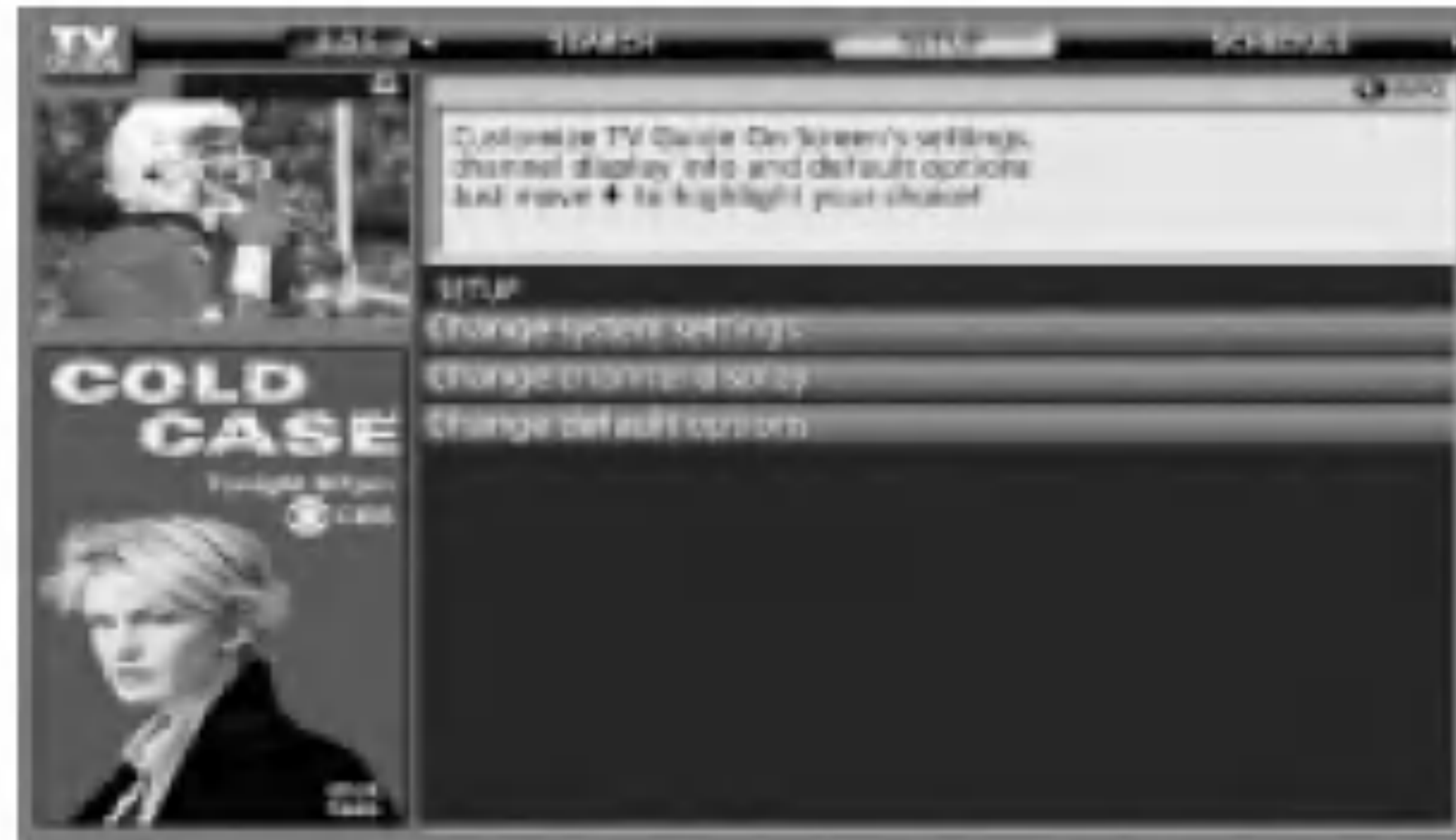

With Setup highlighted, press the **INFO** button to display a Help screen. Press the **INFO** button again to close the screen.

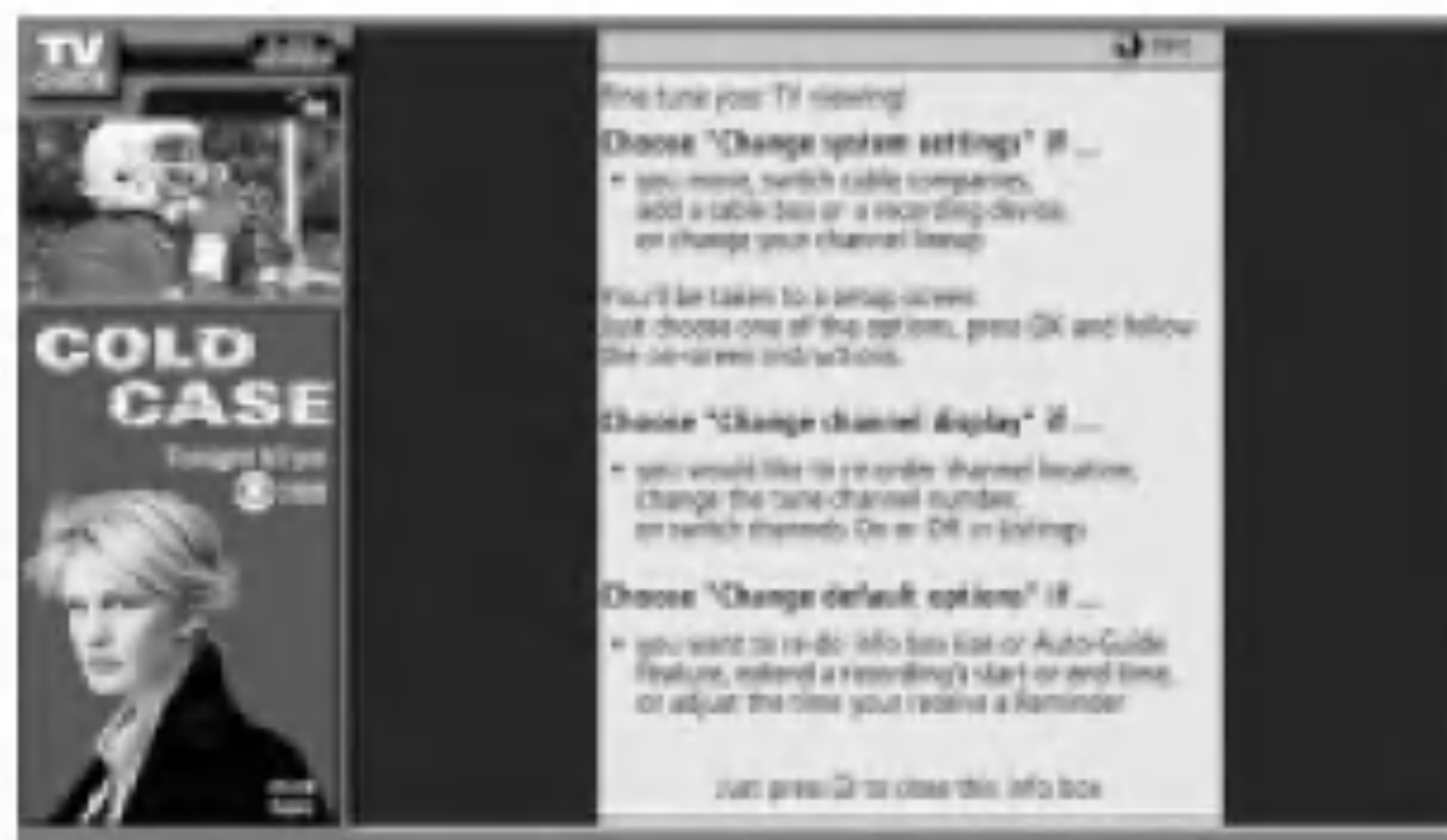

• Change System Settings

This option appears after you have completed the initial Guide Setup process.

Press **ENTER** to display the Confirming Your Settings screen. You see your current settings.

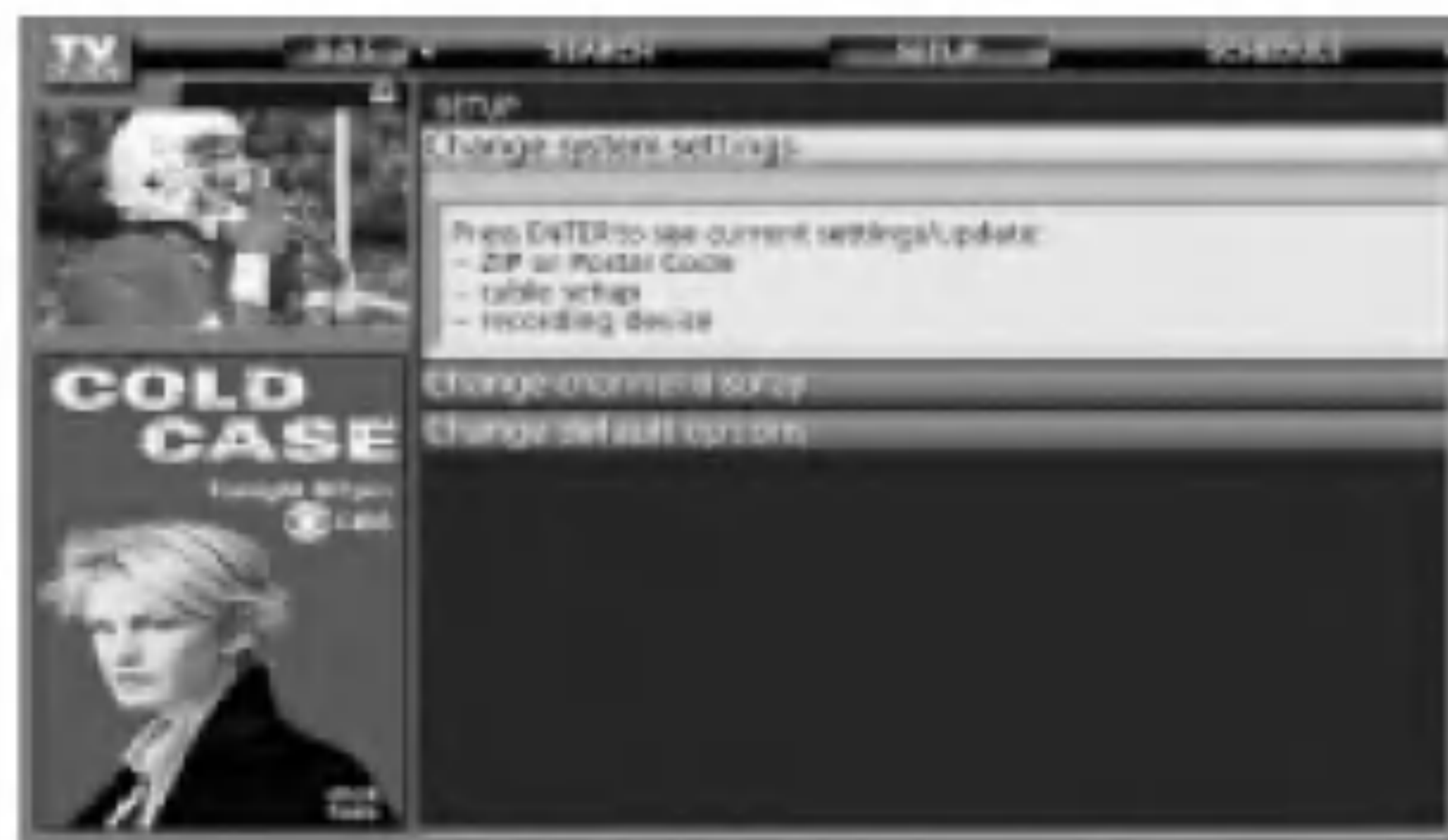

Choose one of the options, press **ENTER**, and follow the on-screen instructions.

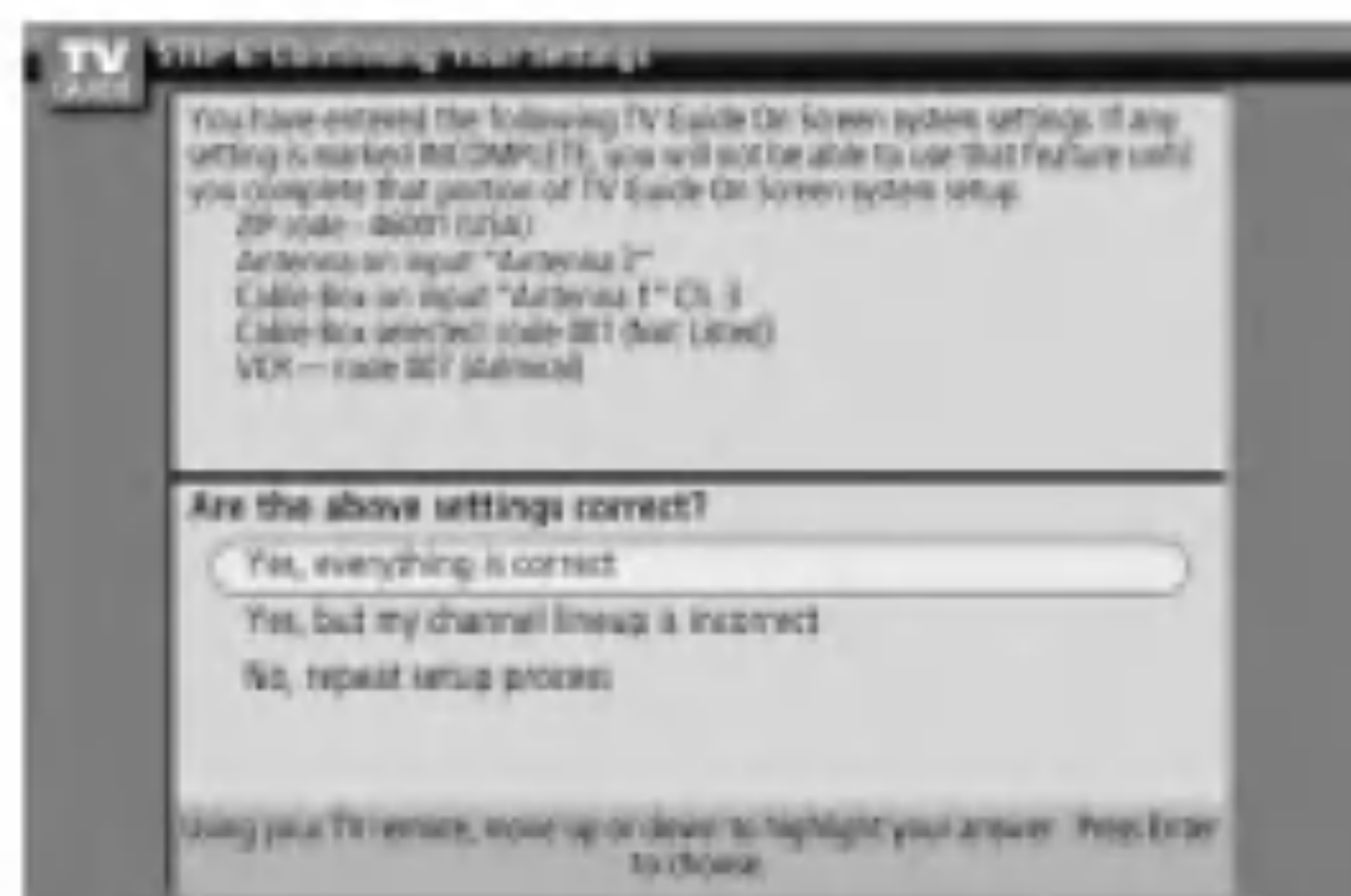

• **Change Channel Display**

Change Channel Display lets you edit channel information that appears in Listings. With Change Channel Display you can :

- Change the position number to indicate where in the Listings the channel displays
- Change the tune channel number
- Switch a channel
 - ◆ On - the channel is always displayed
 - ◆ Off - the channel is never displayed
 - ◆ Auto-Hide - the channel is only displayed when program information is available.

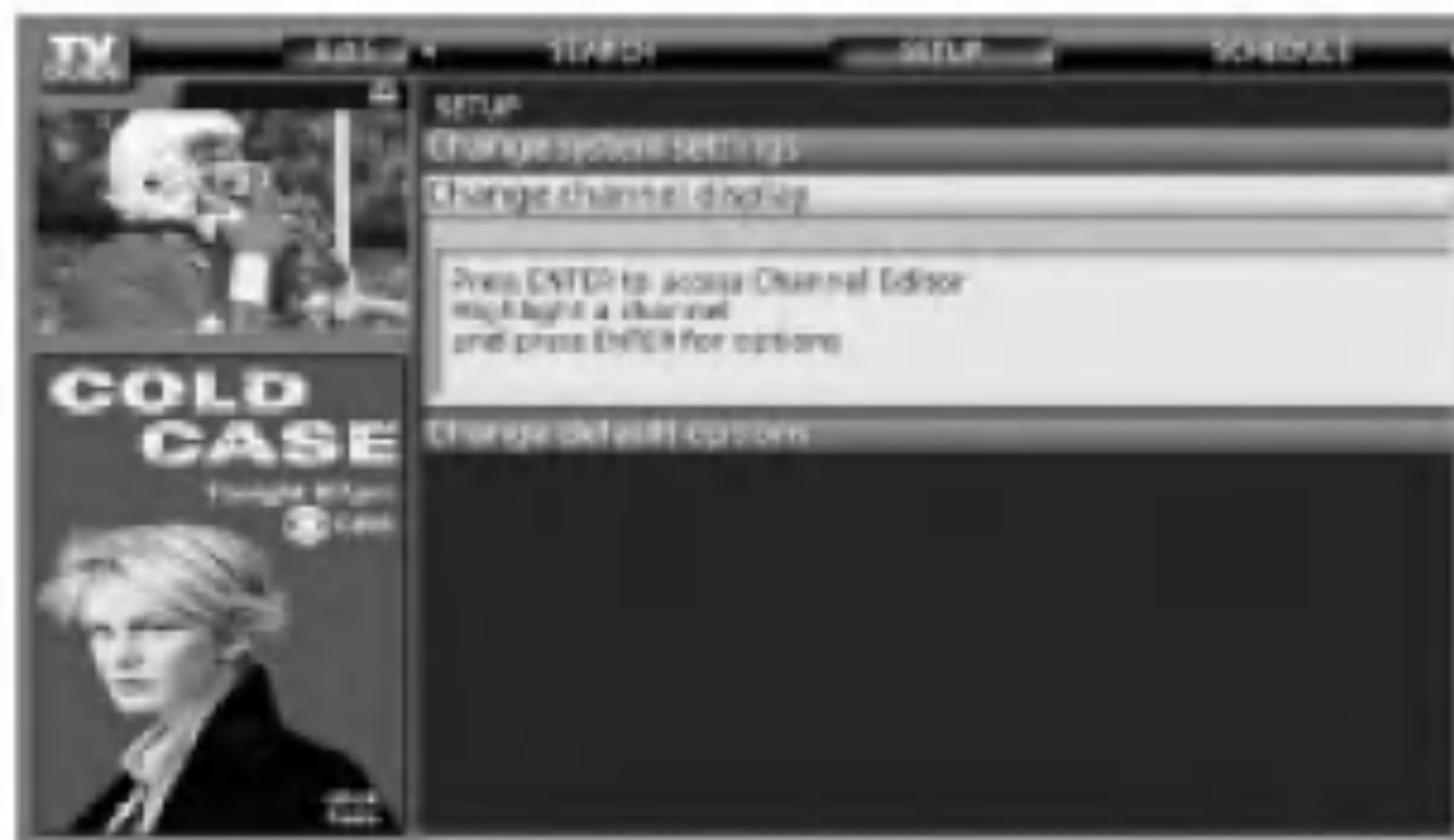

Press **ENTER** to display the Channel Editor screen.

Then, highlight a channel and press Menu. A Grid Options menu is displayed.

Highlight Go Back to Setup to close the menu, change no information, and return to the Setup Service Bar.

Or make changes and when finished, press **ENTER** to highlight Done. Press **ENTER** again to close the menu and accept the changes.

Highlight Cancel to close the menu, change no information, and return to the highlighted channel.



● TV Guide On Screen™ System

• Change Default Options

Change Default Options lets you change default settings in the following categories:

- General Default Options
- Record Defaults
- Remind Defaults

Highlight Change Default Options, and press **ENTER**.



<General Default Options>

General Default Options lets you set defaults for the following:

- The initial Info Box size when the TV Guide On Screen system is entered.
Choices are No, Small, Large, and Last Used (Default = Last Used).
- The Info Box size rotation when the Info key is pressed while in the TV Guide On Screen system.
Choices are No only, Small only, Large only, No & Small, No & Large, Small & Large, All (Default = All)
- Automatic entry into the TV Guide On Screen system (Auto-Guide) when the TV is powered On.
Choices are On and Off (Default = On).

Highlight General Default Options, and press the Menu key to display the General Default Options menu.

Highlight Go to Service Bar to close the menu, change no information, and return to the Setup Service Bar.

When finished, press **ENTER** to highlight Done. Press **ENTER** again to close the menu and accept the changes.

Highlight Cancel to close the menu, change no information, and return to the highlighted option.

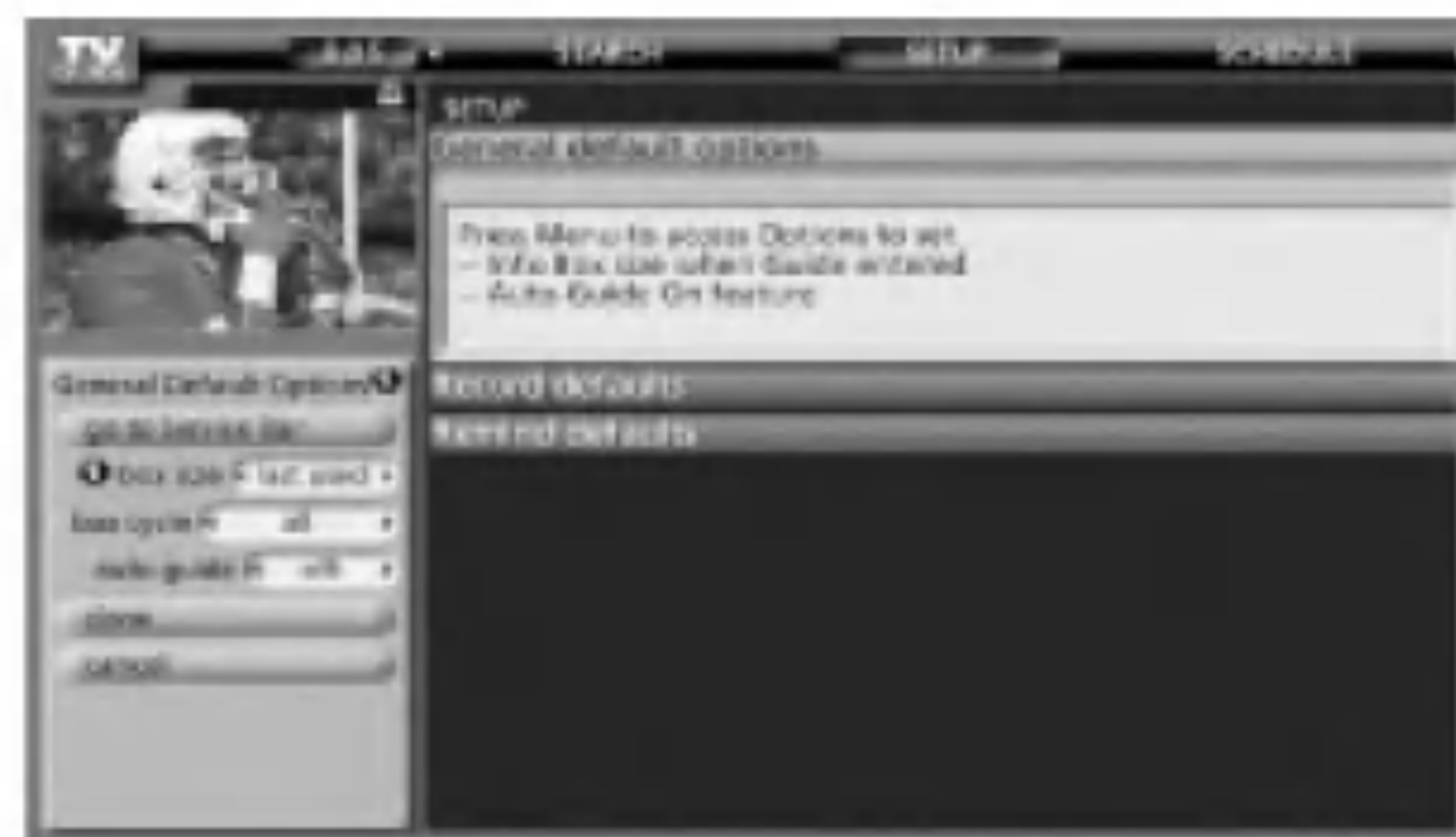

< Record Defaults>

- Record Default Options lets you set defaults for the following:
- When to start the record event. Choices are 120 minutes early to 120 minutes late, to On time. (Default = On time)
- When to end the record event. Choices are 120 minutes early to 120 minutes late, to On time. (Default = On time)
- Recorder choice: Please choose the VCR only. This TV does not support other devices with a recording feature.



Highlight Record Defaults, and press the Menu key to display the Record Default Options menu.

Highlight Go to Service Bar to close the menu, change no information, and return to the Setup Service Bar.

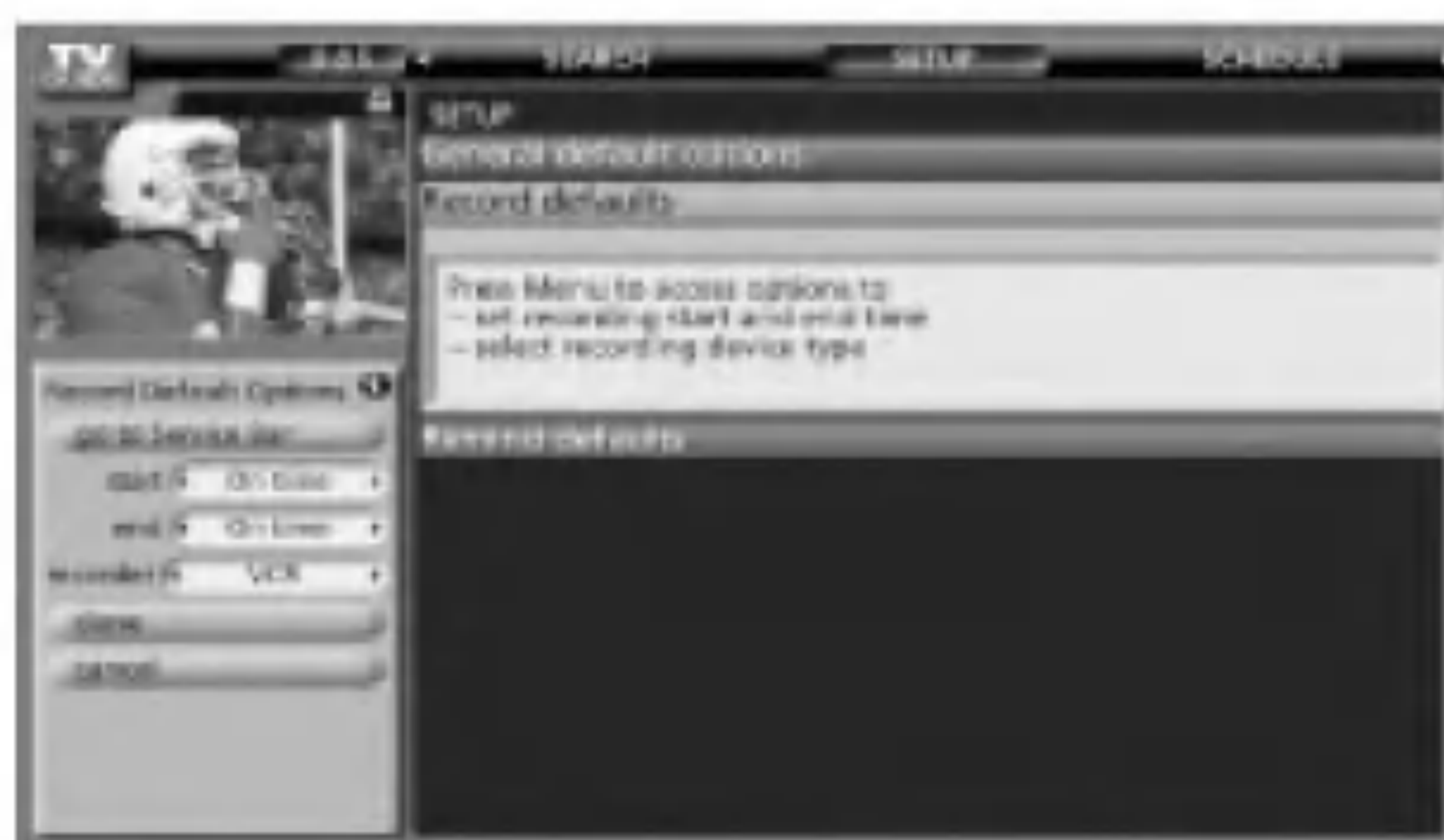

< Remind Defaults>

Remind Default Options lets you set defaults for the following:

- Power On the TV, if Off, when a Reminder is scheduled. Choices are Yes and No. (Default = No)
- Automatically tune the TV to the channel (TV must be On), when a Reminder is scheduled. Choices are Yes and No. (Default = No)
- When to display the reminder screen. Choices are 30 seconds to 15 minutes early, to 30 seconds to 15 minutes late, to On time. (Default = 1 min early)



Highlight Remind Defaults, and press the Menu key to display the Remind Default Options menu.

Highlight Go to Service Bar to close the menu, change no information, and return to the Setup Service Bar.

When finished, press **ENTER** to highlight Done. Press **ENTER** again to close the menu and accept the changes.

Highlight Cancel to close the menu, change no information, and return to the highlighted option.



TV Guide On Screen™ System

Record And Remind Features

Record

You can set a show to Record in Listings, Search, and Schedule or change Record settings for a show in Schedule.

There are 3 ways to set a show to Record:

1) Using the Record Button on the Remote



- Press the Record button on the remote to record the show Once with current default settings (Start and End recording On Time). Each time you press the Record button, you change the record frequency (but not the default settings) among Once (default), Regularly, Weekly, Off, and then Cancel.

Note: The proper Record icon appears on the show tile, as the Record button is pressed.

2) From a Panel Menu

- Highlight a show, and press Menu to display the Episode Options menu.
- Highlight Set Recording, and press **ENTER** to display the Record Options menu.
- Highlight the Frequency option, and use the left and right arrows to choose among Once, Regularly, Weekly, and Off, as previously described.
- Recorder choice: Please choose the VCR only. This TV does not support other devices with a recording feature.

Note: Video Window Lock is switched to on or off using PIP button in Listings mode.

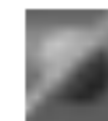
- ◆ **Once**  —records the show one time
- ◆ **Regularly**  —records the show every time the show airs on the same channel and starts at the same time
- ◆ **Weekly**  —records the show each time the show airs on the same day of the week, on the same channel and starts at the same time
- ◆ **Off (not cancel)**  —keeps the show in the list but will not record this show until the frequency is changed.
- ◆ **Cancel (no icon displayed)**—does not record



When finished, press **ENTER** to highlight Schedule Recording.

Press **ENTER** again to close the menu. You see a Record icon for the selected frequency next to the show title.

Highlight Cancel to close the menu, change no information, and return to the highlighted show.



3) Manual Recording

- Highlight the Schedule Service label, and press Menu to display the Schedule Options menu.
- Use the ▲ / ▼ / ◀ / ▶ buttons to move through the options. Use the number or the ▲ / ▼ / ◀ / ▶ buttons to change the information, as necessary.
- Highlight New Manual Recording and press **ENTER** to display the Record Options menu.

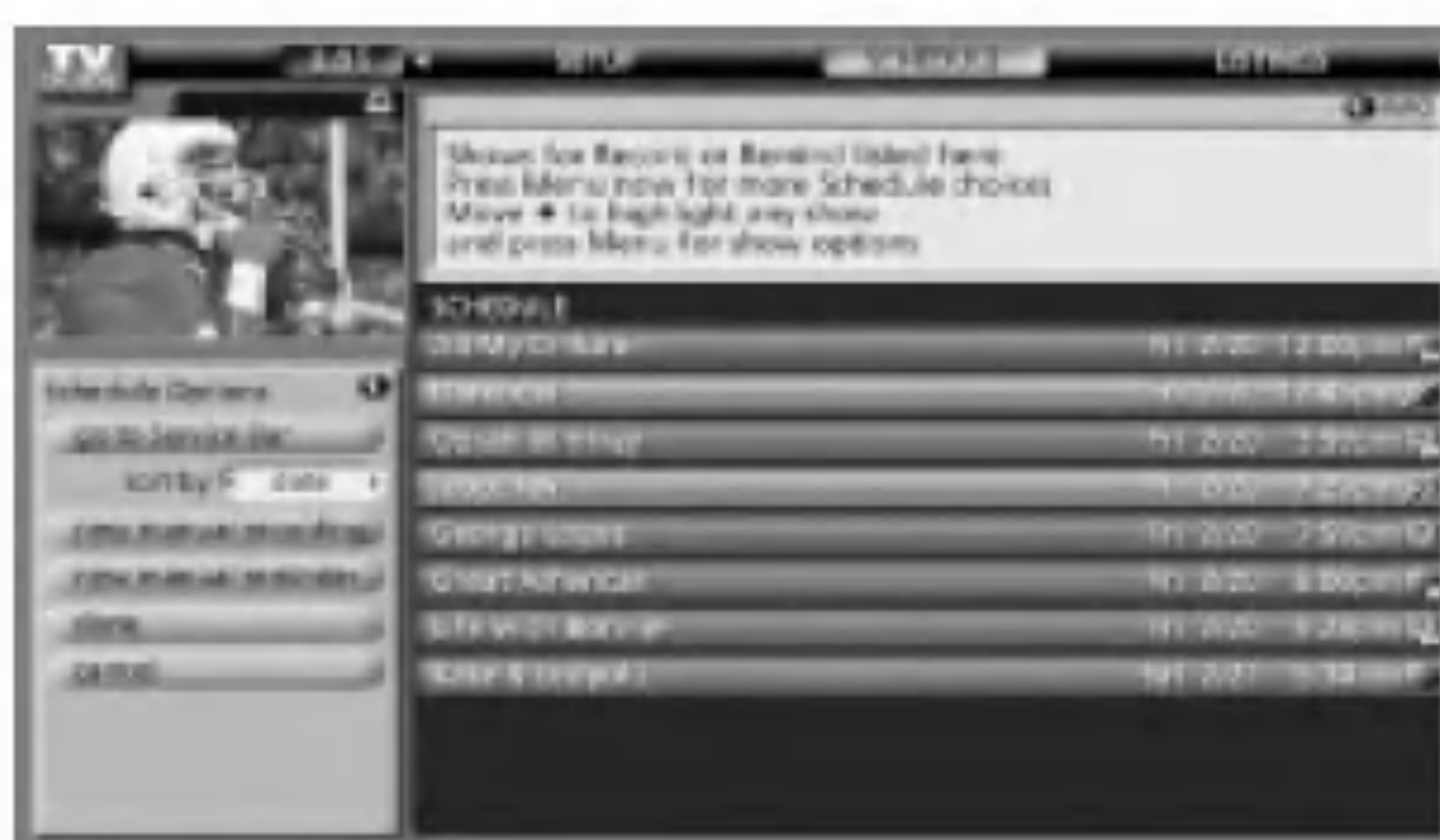

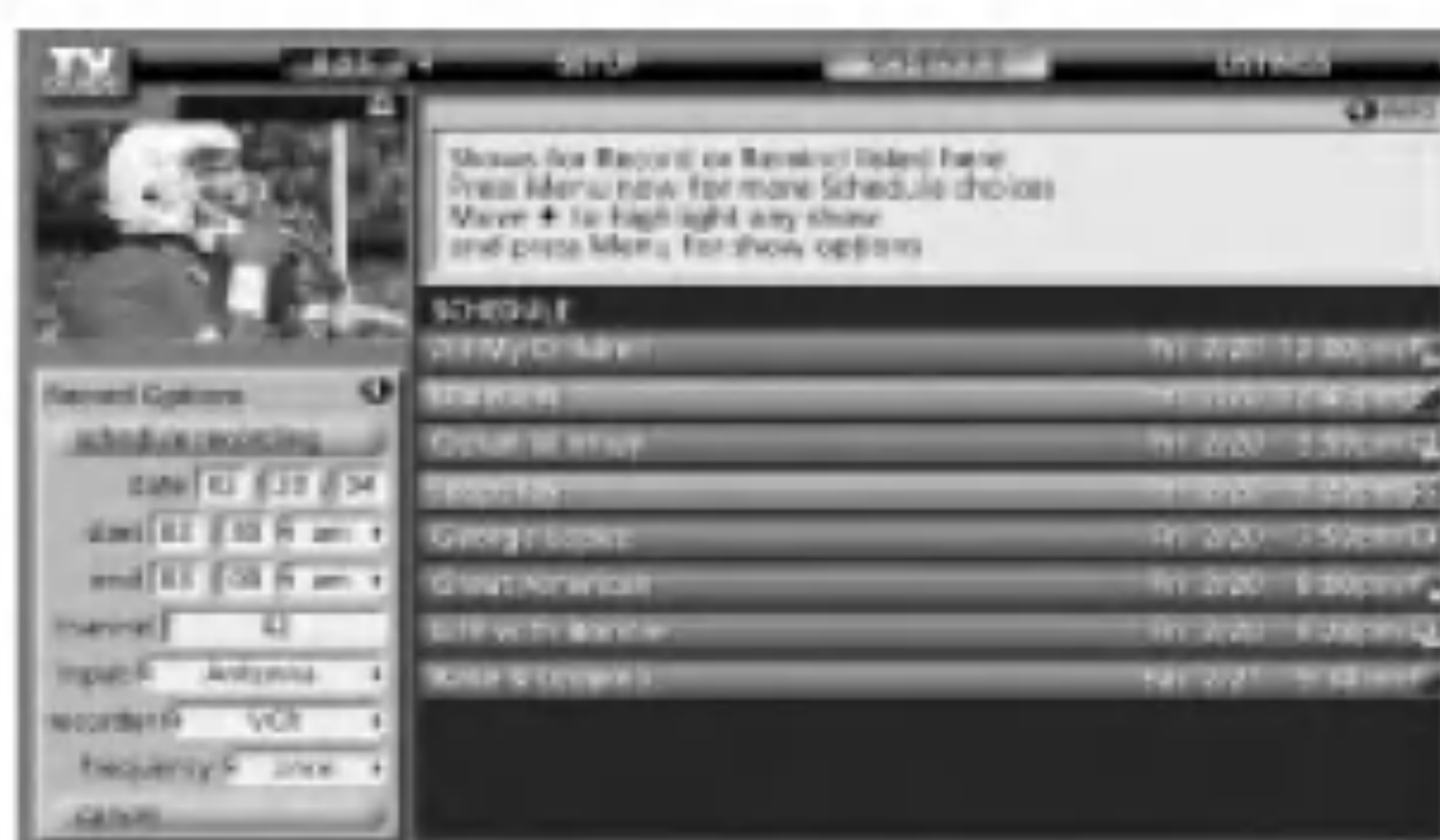

- Current information (i.e., date, start and end times, channel, input) is displayed.
- Recorder choice: Please choose the VCR only. This TV does not support other devices with a recording feature.



● TV Guide On Screen™ System

• Use the left and right arrows to choose between Once, Daily, Weekly, and Off, as follows.

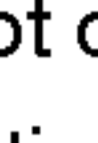
- ◆ Once  —records the time, channel, input, recorder combination one time.
- ◆ Daily  —records the time, channel, input, recorder combination Monday through Friday.
- ◆ Weekly  —records the time, channel, input, recorder combination once a week on the selected day of the week.
- ◆ Off (not cancel)  —keeps the time, channel, input, recorder combination in the list without recording until the frequency is changed.



When finished, press **ENTER** to highlight Schedule Recording.

Press **ENTER** again to close the menu. You see a Record icon for the selected frequency next to the show title.

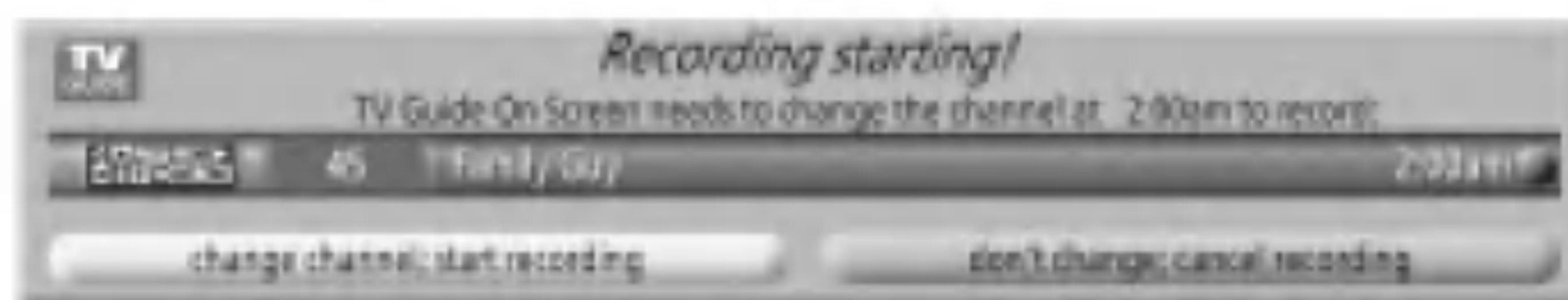

Note: Manual recording is listed by channel number.

Highlight Cancel to close the menu, change no information, and return to the highlighted show.

Before a recording begins, a notification screen appears if your TV is On. At that time, you can choose to start or cancel recording. If the TV is not On, the recording occurs as scheduled. If there is no activity for 3 minutes, the notification screen automatically closes and completes the highlighted item.

Record Conflict

A conflict message appears for the following reasons:

- a show set to Record overlaps with any part of another show previously set to Record,
- a show set to Record overlaps with a show previously set to auto-tune

Select one of these options:

- ◆ record anyway - this show will override an existing show set to Record or auto-tune
- ◆ don't record this show - cancel the Recording

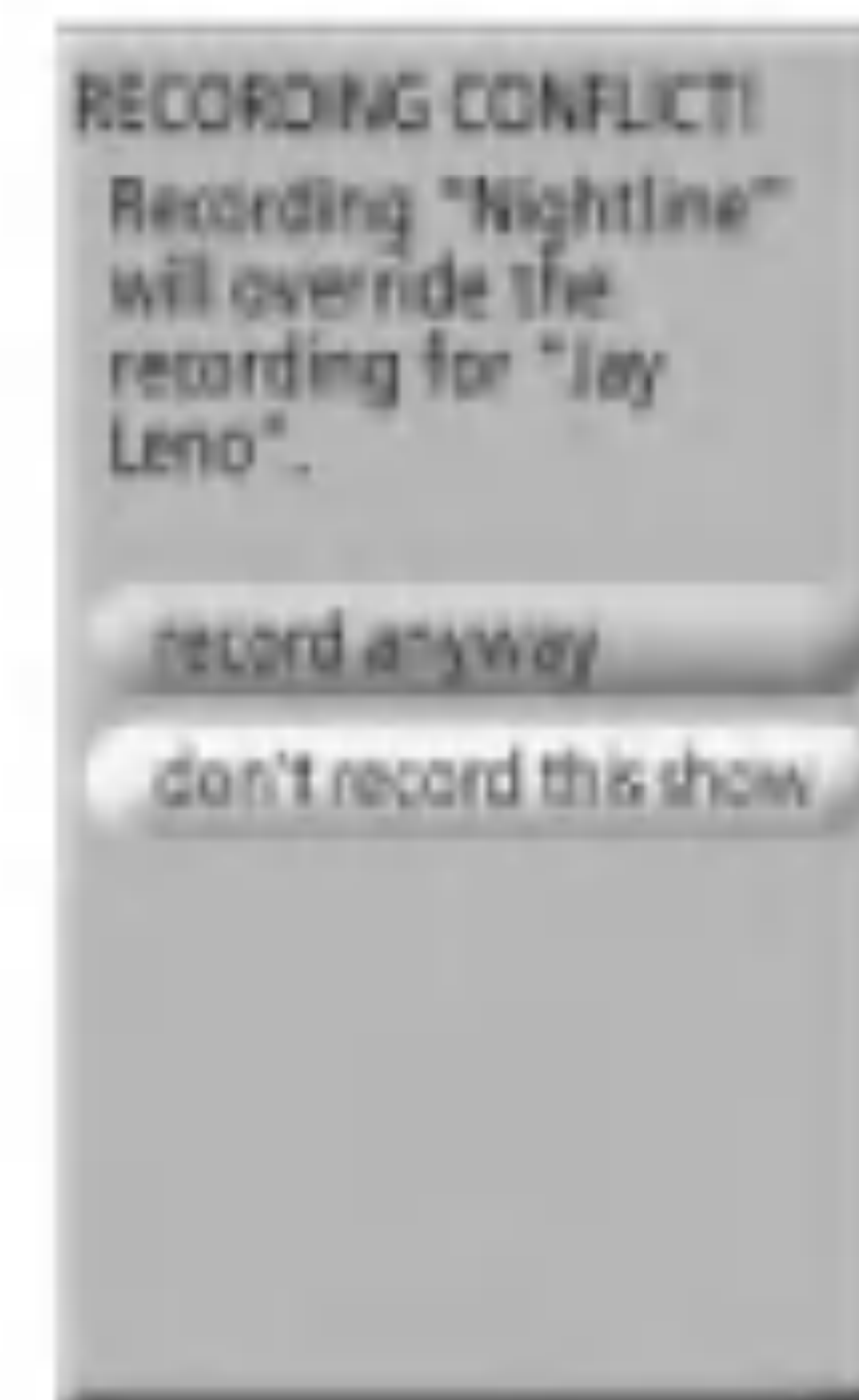
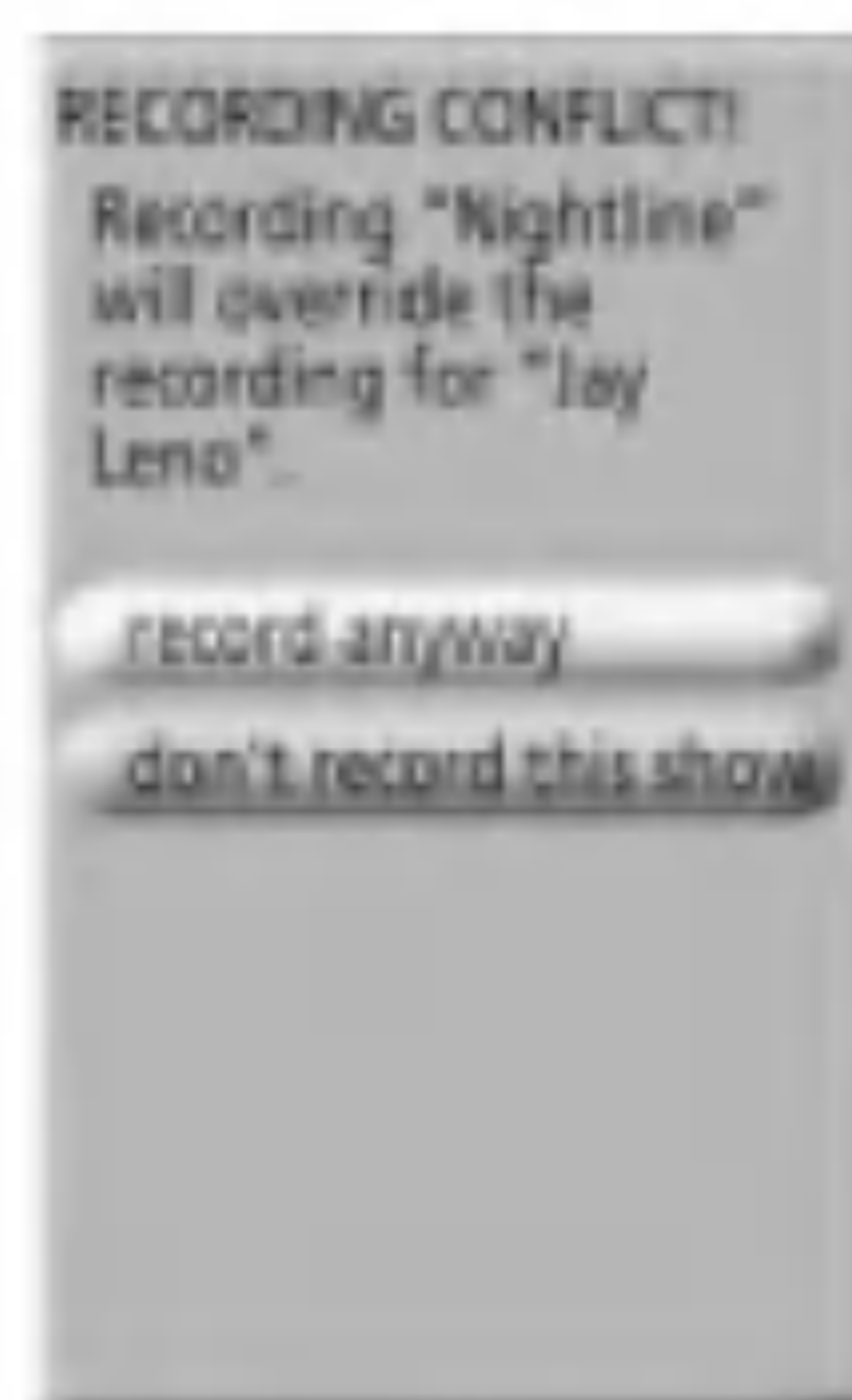

Remind

You can set a show Reminder in Listings, Search, and Schedule or change Reminder settings for a show in Schedule.

There are 2 ways to set a show Reminder:

1) From a Panel Menu

- Highlight a show, and press Menu to display the Episode Options menu.
- Highlight Set Reminder, and press **ENTER** to display the Remind Options menu.



- Highlight the Frequency option, and use the left and right arrows to choose between:

- ◆ Once —sets a show reminder one time
- ◆ Regularly —sets a show reminder every time the show airs on the same channel and starts at the same time
- ◆ Weekly —sets a show reminder each time the show airs on the same day of the week, on the same channel and starts at the same time
- ◆ Off —keeps the show in the list but will not remind until the frequency is changed



- Power On the TV, if Off, when a Reminder is scheduled. Choices are Yes and No. (Default = No)
- Automatically tune the TV to the channel (TV must be On), when a Reminder is scheduled. Choices are Yes and No. (Default = No)
- When to display the reminder screen. Choices are 30 seconds to 15 minutes early, to 30 seconds to 15 minutes late, to On time. (Default = 1 min early)

When finished, press **ENTER** to highlight Schedule Reminder.



Press **ENTER** again to close the menu. You see a Remind icon for the selected frequency next to the show title.

Highlight Cancel to close the menu, change no information, and return to the highlighted show.



TV Guide On Screen™ System

2) Manual Reminder

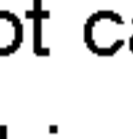
- Highlight the Schedule Service label, and press the Menu key to display the Schedule Options menu.
- Use the ▲ / ▼ / ◀ / ▶ buttons to move through the options. Use the number or ▲ / ▼ / ◀ / ▶ buttons to change the information, as necessary.
- Highlight New Manual Reminder and press the **ENTER** key to display the Remind Options menu.
- Current information (i.e., date, start and end times, channel, input, frequency, etc.) is displayed.
- Highlight the Frequency option, and use the ◀ / ▶ buttons to choose among Once, Daily, Weekly, and Off, as follows.
 - ◆ Once  —sets a show reminder for the time, channel, and input combination one time
 - ◆ Daily  —reminds for the time, channel, and input combination Monday through Friday
 - ◆ Weekly  —sets a show reminder for the time, channel, and input combination once a week on this selected day of the week
 - ◆ Off (not cancel)  —keeps the time, channel, input, destination combination in the list without reminding until the frequency is changed
- Power On the TV, if Off, when a Reminder is scheduled. Choices are Yes and No (Default =No).
- Automatically tune the TV to the channel (TV must be On), when a Reminder is scheduled. Choices are Yes and No (Default = No).

When finished, press **ENTER** to highlight Schedule Reminder. Press **ENTER** again to close the menu. You see a Remind icon for the selected frequency next to the show title.

Note: Manual reminder is listed by channel number.

Highlight Cancel to close the menu, change no information, and return to the highlighted show.

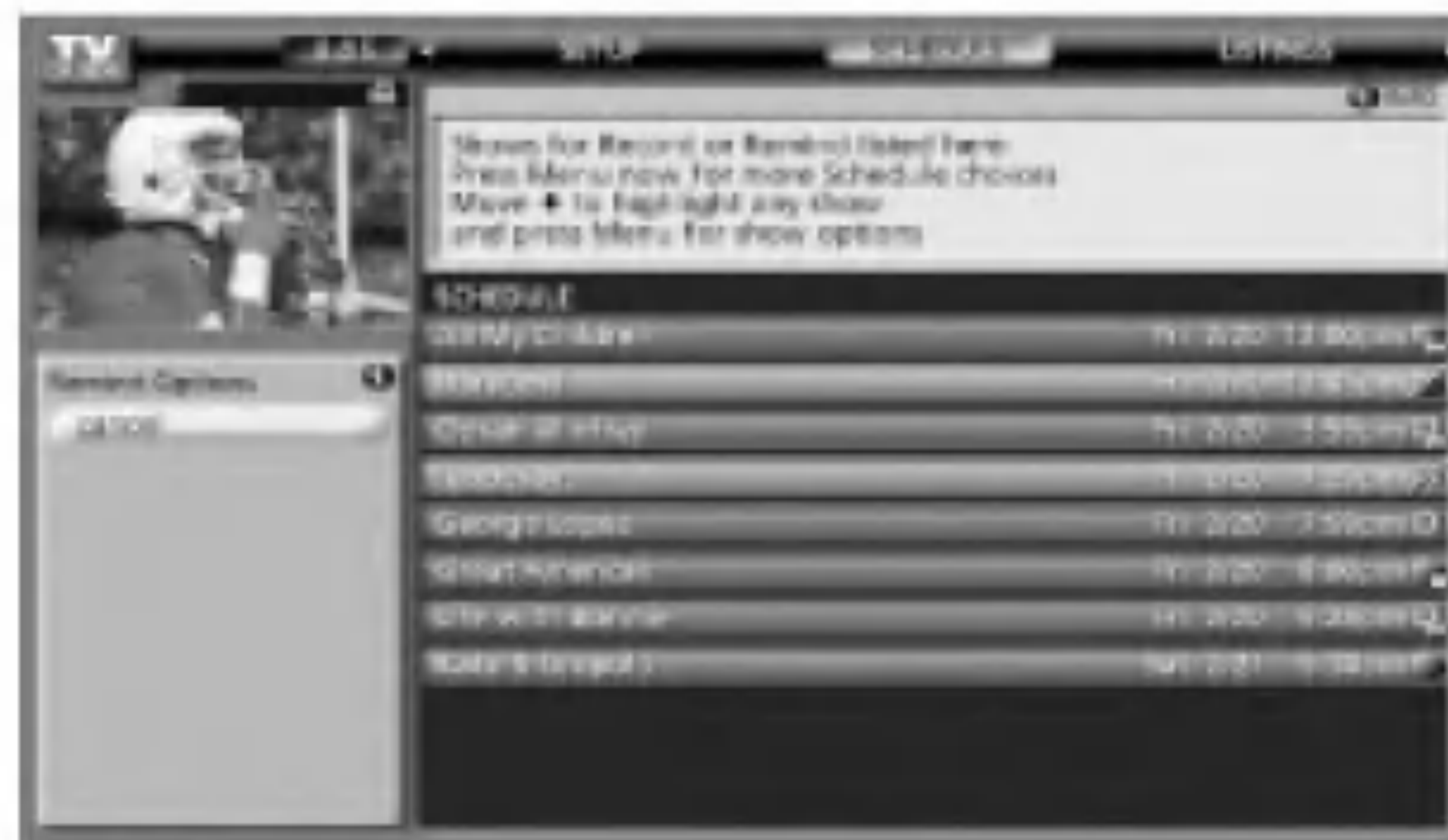
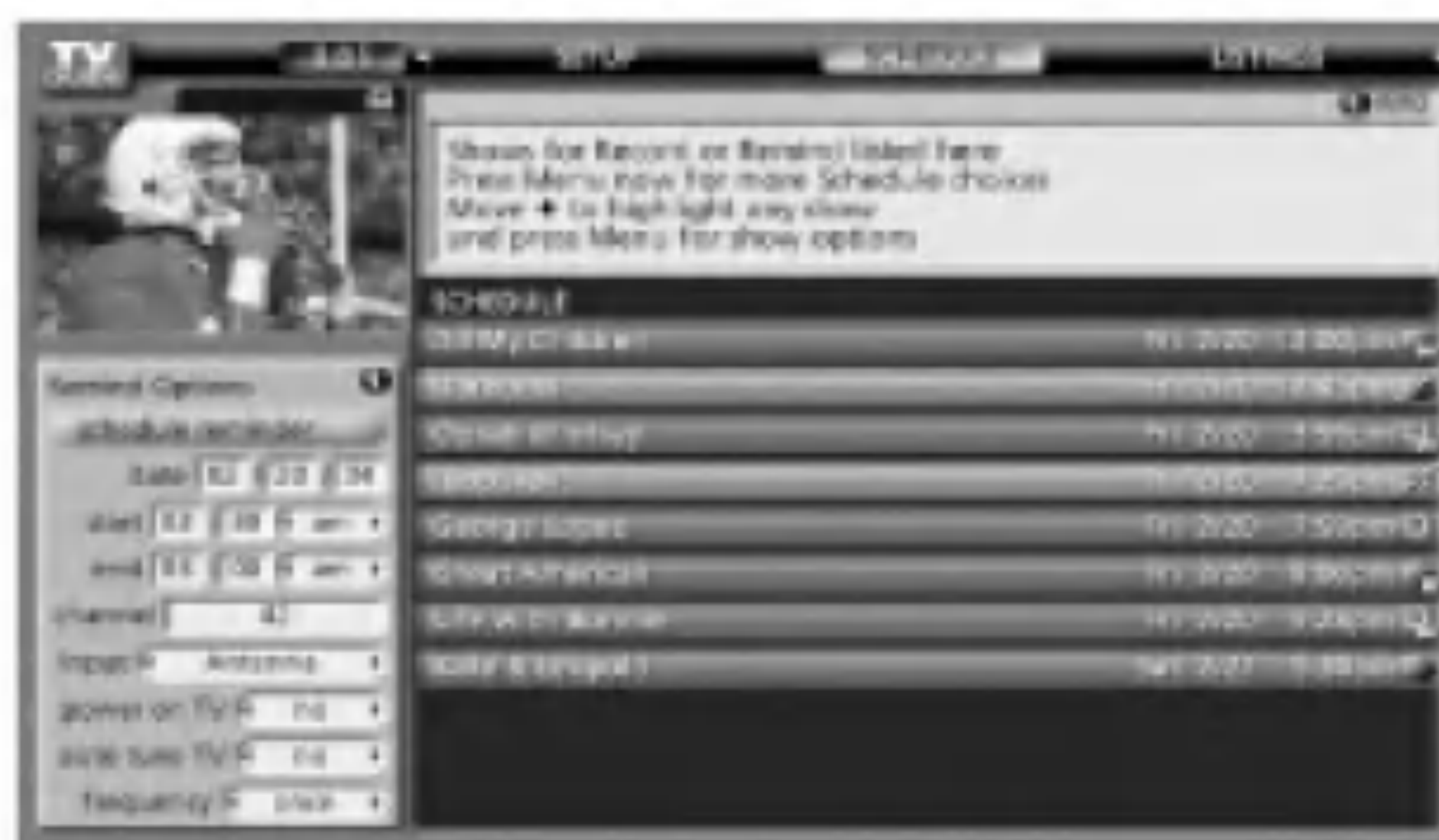
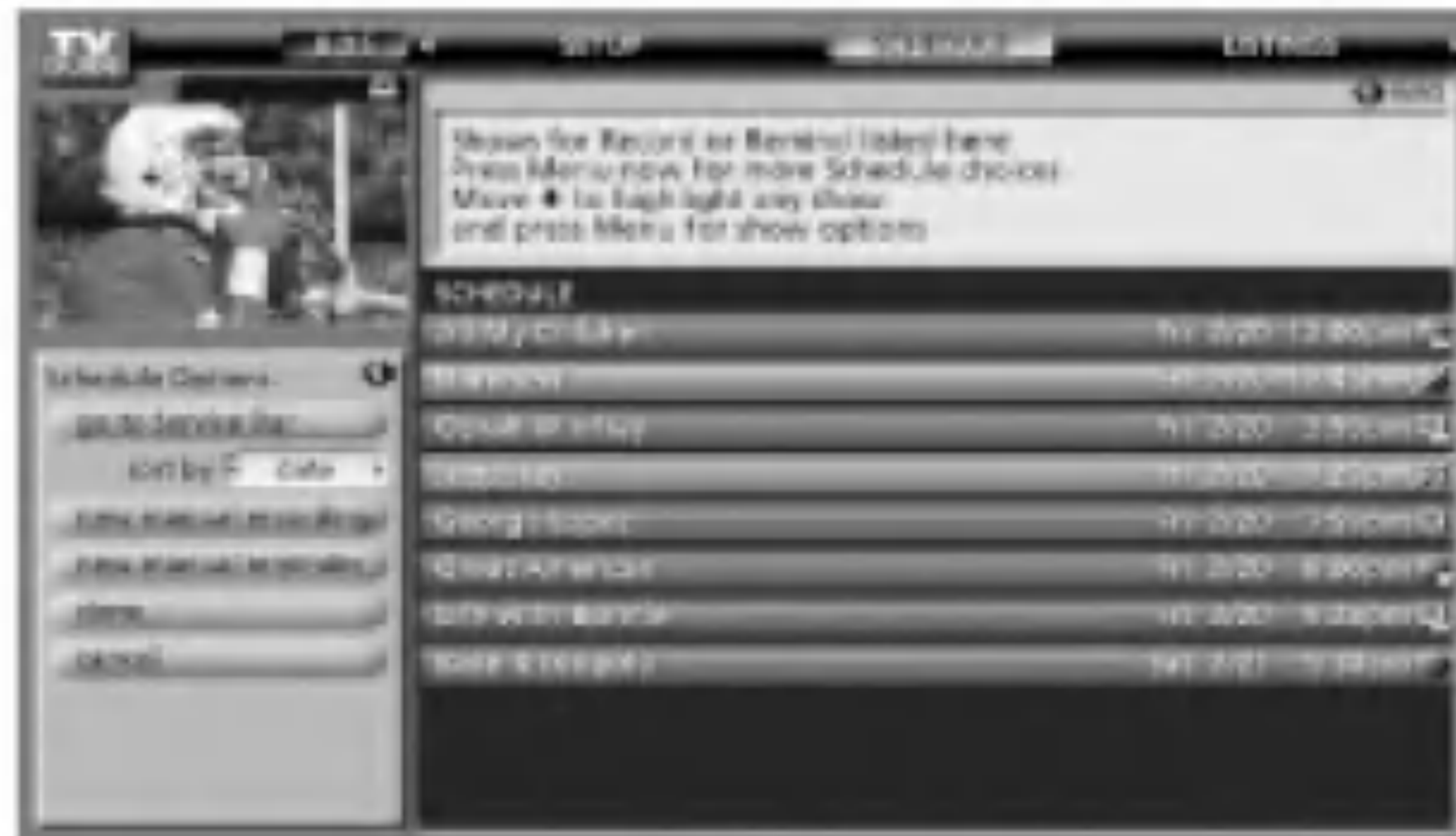

Based on your option settings, a notification screen will appear, if your TV is On at the reminder time. You can then choose to hide the reminder, or highlight the show, and press **ENTER** to tune to the show. If there is no activity for 3 minutes, the notification screen automatically closes and completes the highlighted item (hide reminders).

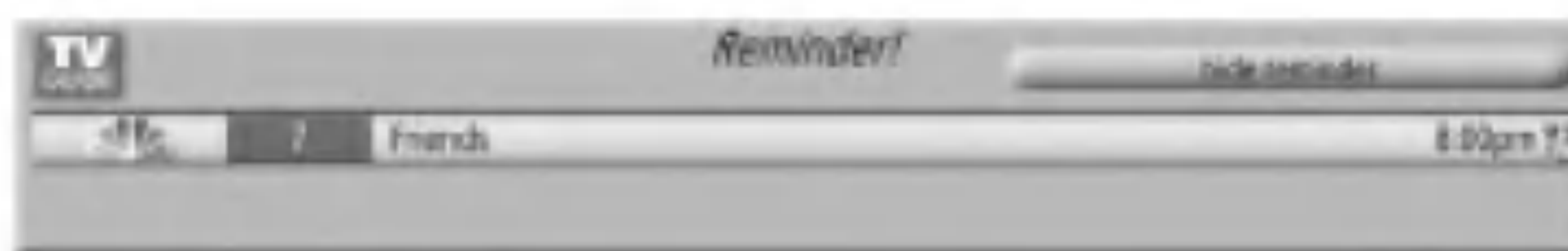

If you choose Hide Reminders, the window closes for the show or shows, but does not affect other Reminders you set.



Note: If more than 2 reminders are set for the same time, arrows appear on the Reminder screen. Use the ▲ / ▼ buttons to view the shows.

Remind Conflict

A conflict message appears for the following reasons:

- a show set with an Auto-Tune Reminder has the same start time as an existing Auto-Tune Reminder.
- If you are using a cable box, a show set with an Auto-Tune Reminder overlaps with a Recording already scheduled.

Select one of these options:

- ◆ auto-tune anyway - this show will override an existing show set to auto-tune
- ◆ proceed, no auto-tune - set the show as a Reminder but do not auto-tune
- ◆ don't set this reminder - cancel the Reminder

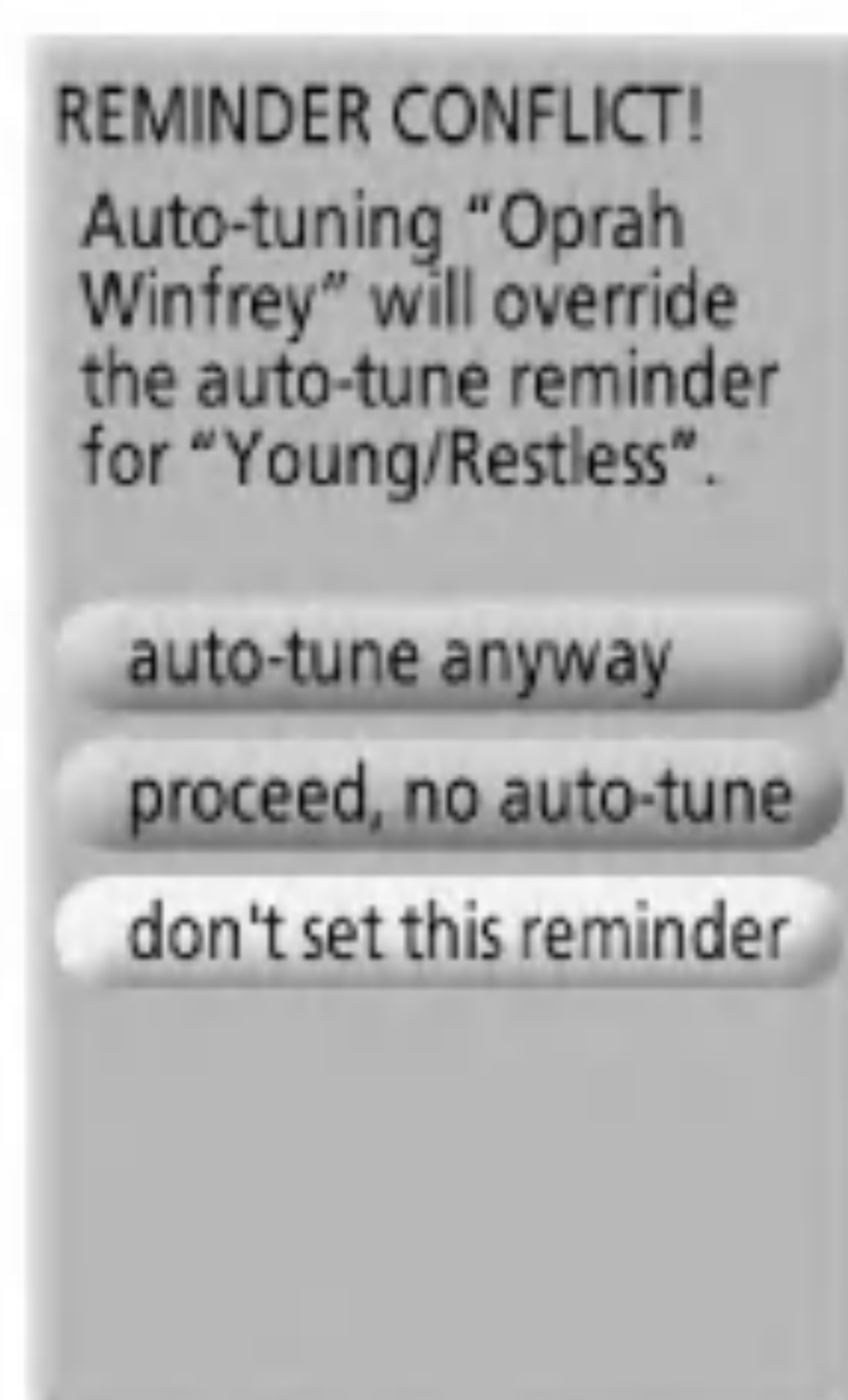
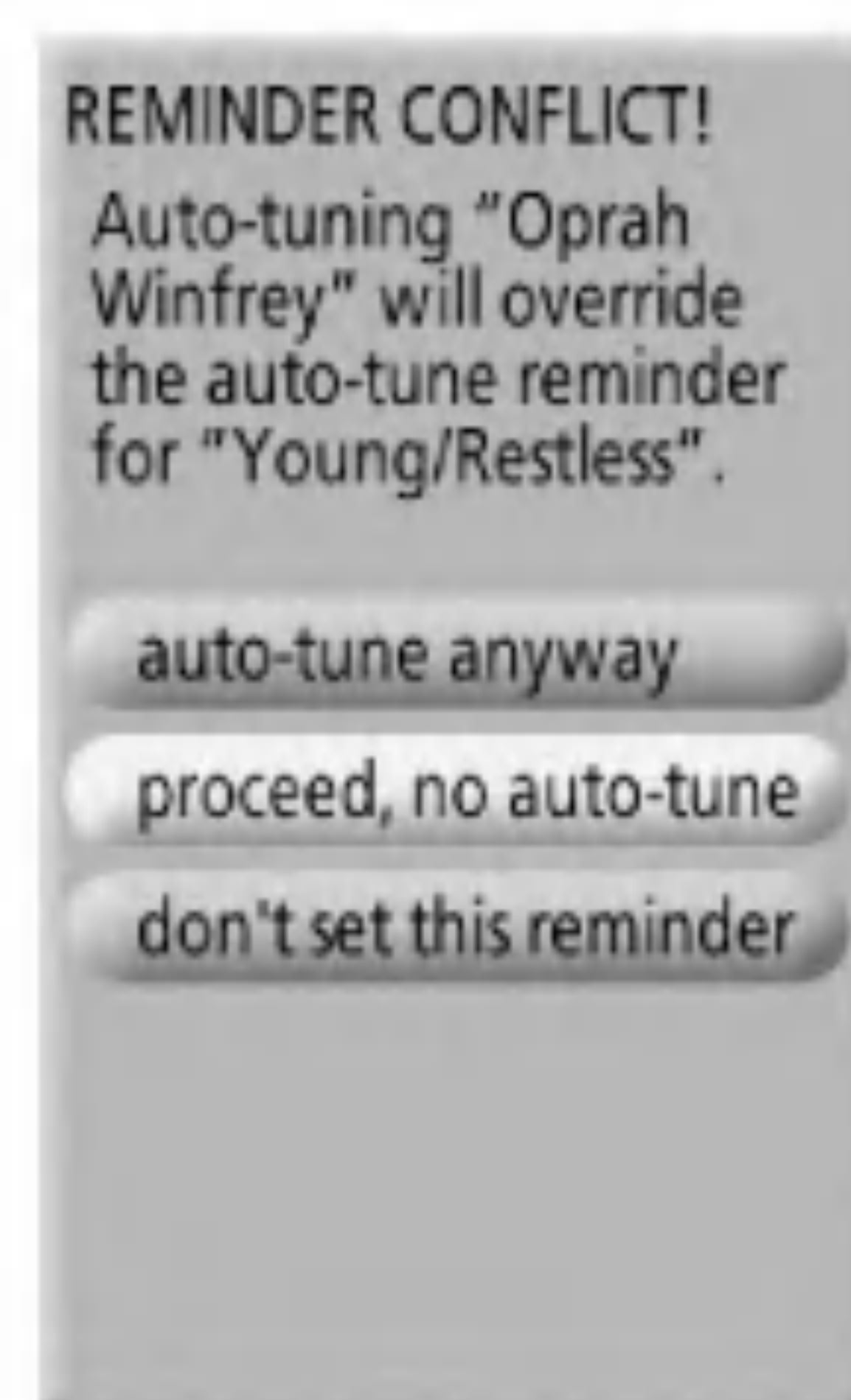
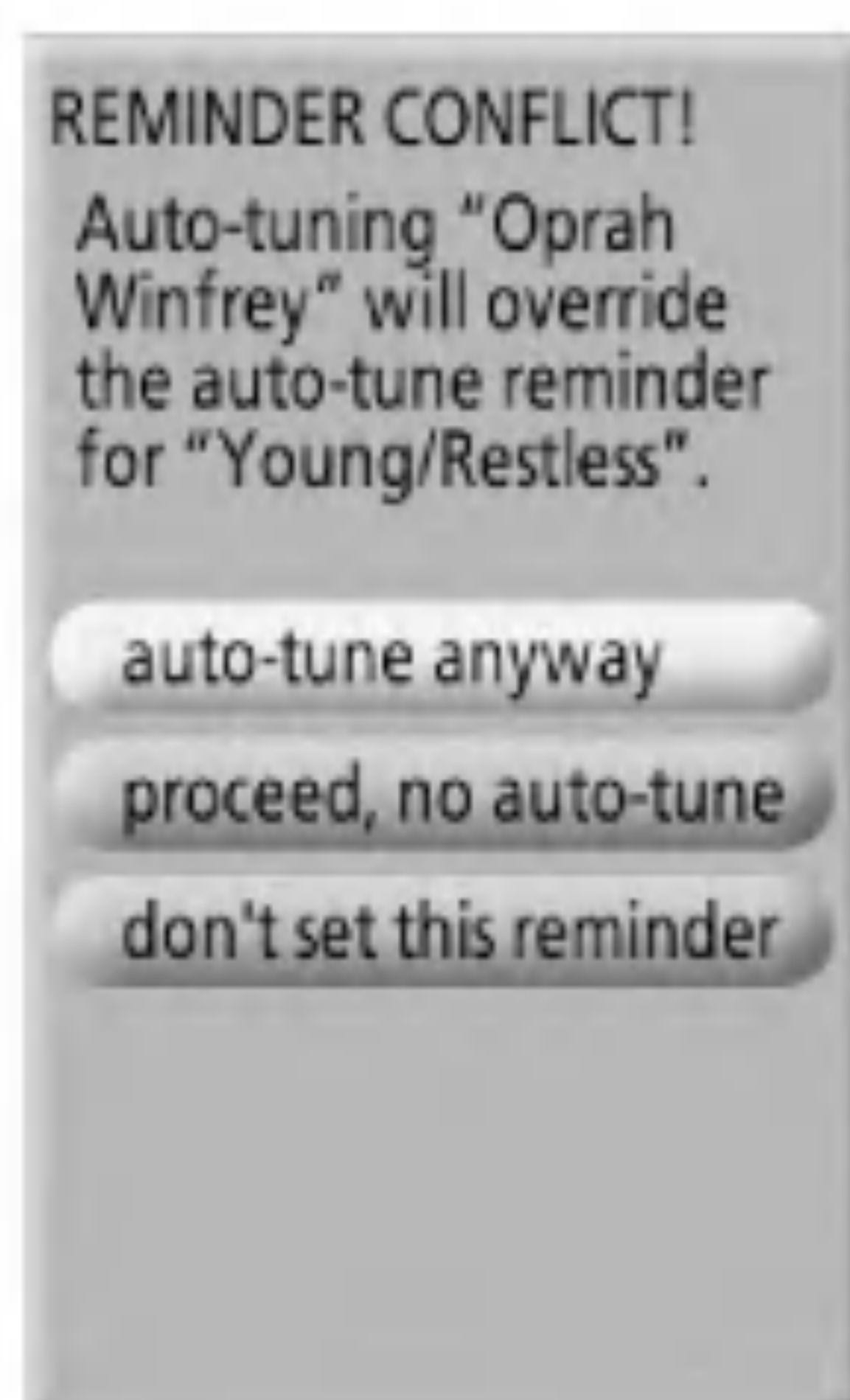

Operation

Turning the TV On

* In this manual, the OSD (On Screen Display) may be different from your TV's because it is just an example to help you with the TV operation.

1. First, connect power cord correctly. At this moment, the TV switches to standby mode.

In standby mode to turn TV on, press the **TV/VIDEO**, **CH (▲ / ▼)** button on the TV or press the **POWER**, **TV/VIDEO**, **TV INPUT**, **CH (▲ / ▼)**, **Number (0 ~ 9)** button on the remote control.

2. Select the viewing source by using **TV/VIDEO**, **TV INPUT** button on the remote control.

This TV is programmed to remember which mode it was last set to, even if you turn the TV off.

3. When finished using the TV, press the **POWER** button on the remote control. The TV reverts to standby mode.

Notes:

- If you intend to be away on vacation, disconnect the power plug from the wall power outlet.
- After turning on the TV, it will take up to a week for the TV Guide On Screen system to receive full listings data.
- Illuminates orange in standby mode. When the TV is turned on, the indicator will blink green for 3-4 seconds before the picture is seen.
- When the TV is turned On, the TV Guide On Screen system is automatically displayed. The screen may be slightly delayed if the TV was unplugged and then powered On.

● TV Setup

On-screen Menu Language Selection

- The menus can be shown on the screen in the selected language. First select your language.

1. Press the **MENU** button and then use ▲ / ▼ button to select the **OPTION** menu.
2. Press the ► button and then use ▲ / ▼ button to select **Language**.
3. Press the ► button and then use ▲ / ▼ button to select your desired language.
From this point on, the on-screen menus will be shown in the selected language.
4. Press **EXIT** button to return to TV viewing or press **MENU** button to return to the previous menu.



Setup Menu Options

EZ Scan (Channel Search)

- Automatically finds all channels available through antenna or cable inputs, and stores them in memory on the channel list.
- Run EZ Scan again after any Antenna/Cable connection changes.
- A password is required to gain access to EZ Scan menu if the Lock System is turned on.

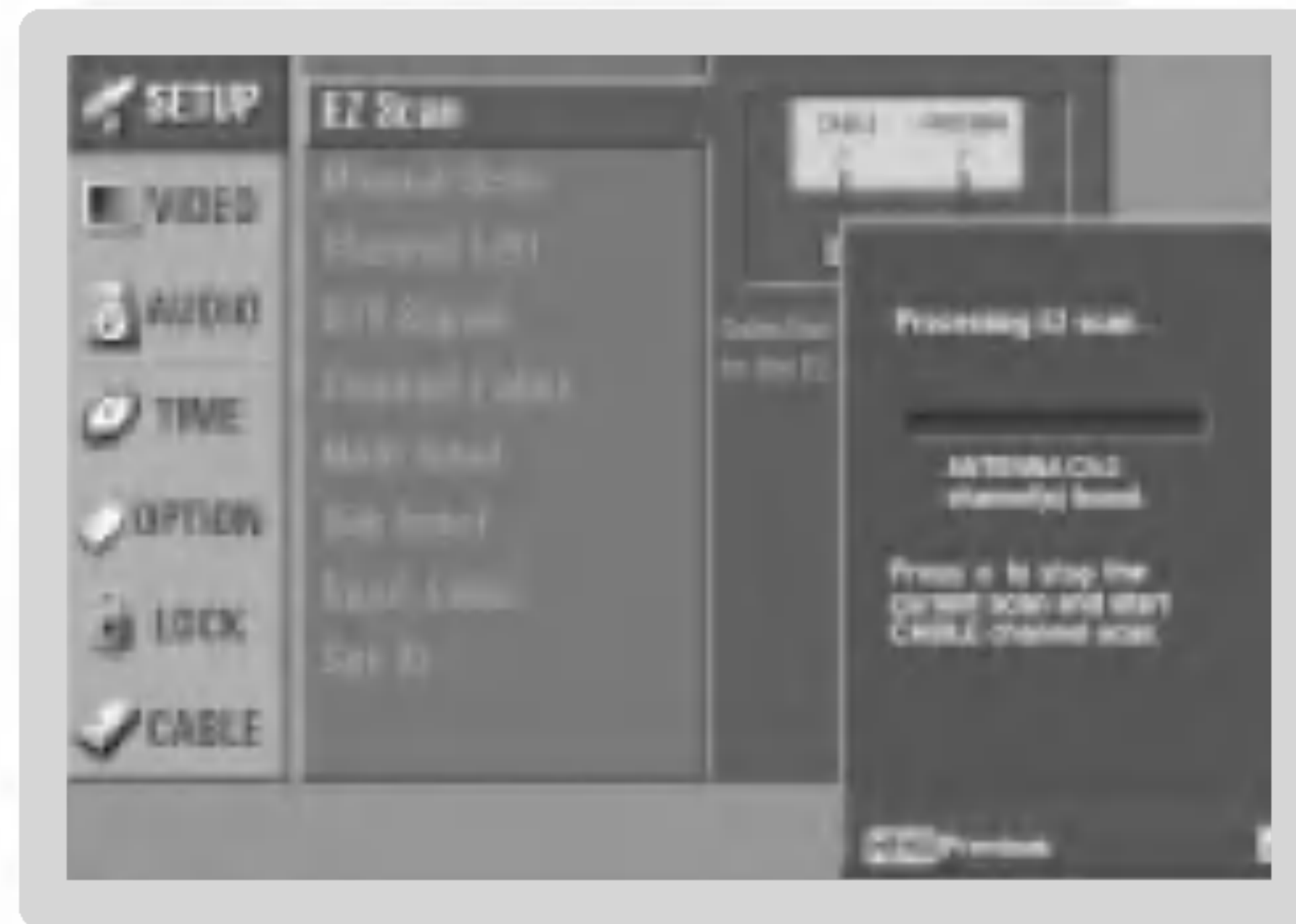
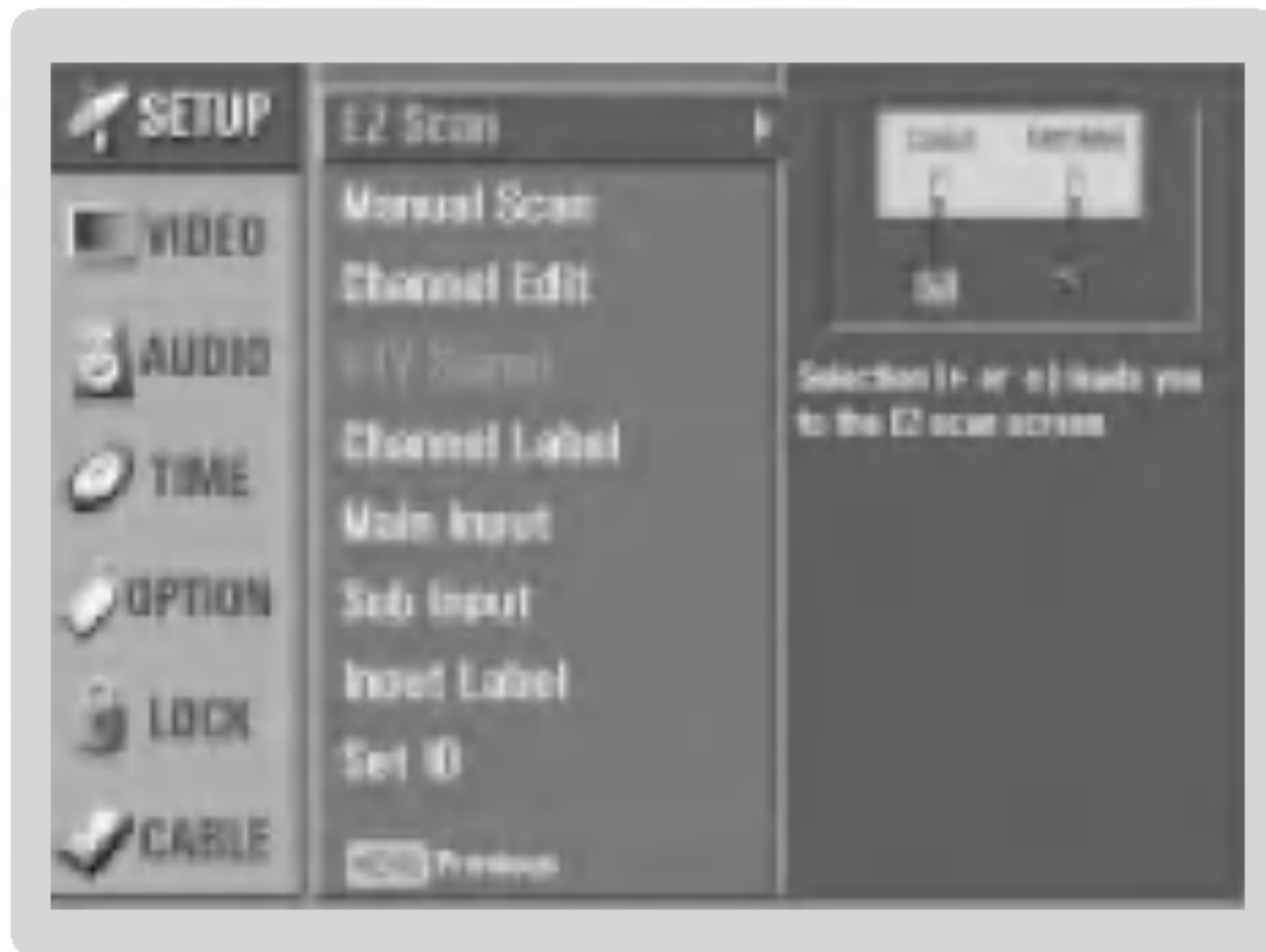

1. Press the **MENU** button and then use ▲ / ▼ button to select the **SETUP** menu.
2. Press the ► button and then use ▲ / ▼ button to select **EZ Scan**.
3. Press the **ENTER** button to begin the channel search.
Allow EZ Scan to complete the channel search cycle for ANTENNA, and CABLE.

Manual Scan

- A password is required to gain access to Manual Scan menu if the Lock System is turned on.

1. Press the **MENU** button and then use ▲ / ▼ button to select the **SETUP** menu.
2. Press the ► button and then use ▲ / ▼ button to select **Manual Scan**.
3. Press the ► button and then use ▲ / ▼ button to select TV, DTV, CATV, and CADTV.
4. Press the ► button and then use ▲ / ▼ button to select channel number you want to add or delete.
5. Press the **ENTER** button to add or delete for the channel number.
6. Press **EXIT** button to return to TV viewing or press **MENU** button to return to the previous menu.



Notes:

- This channel number is a physical channel number, which is different from the normal channel number shown in Channel Edit.
- When a cable box connects to the physical channel 2,3 or 4 in the TV Guide On Screen system Setup, cable channels(CATV or CADTV) will not be scanned by EZ Scan or Manual Scan.
- When inserting the CableCARD™, CATV, CADTV is not working in Manual Scan.
- TV: analog antenna(over-the-air) TV signal
DTV: digital antenna(over-the-air) TV signal
CATV: analog cable TV signal
CADTV: digital cable TV signal

Channel Edit

- Create two different types of channel lists in memory: "Custom List" and "Favorite List" from the default channel list created from the EZ Scan channel search.
- A Custom List can be created by toggling each channel on or off with **ENTER** button. The channels in the Custom List are displayed in black color, and the channels deleted from the Custom List are displayed in gray color. Once a channel is highlighted you can add or delete the channel by referring to the small window at the top-left corner of the screen. You can create your own Favorite List. Use the **FAV** button on the remote control when a channel is highlighted and then you can add or delete the channel to/from the Favorite List.

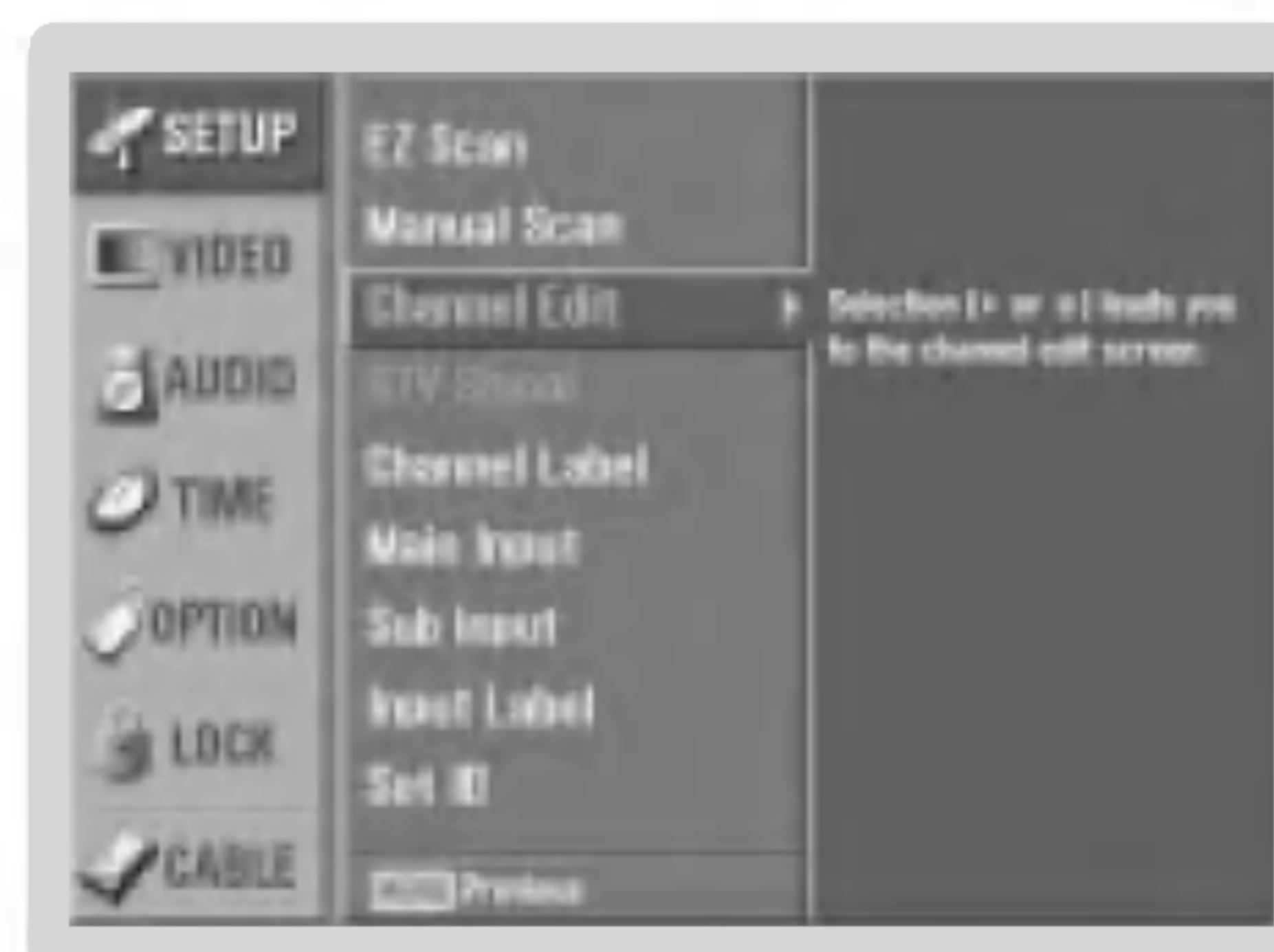

1. Press the **MENU** button and then use **▲ / ▼** button to select the **SETUP** menu.
2. Press the **▶** button and then use **▲ / ▼** button to select **Channel Edit**.
3. Press the **▶** button. You will now see a screen filled with channel numbers and a preview picture.
4. Use **▲ / ▼ / ◀ / ▶** button to select a channel and then use the **ENTER** button to add or delete it. Press **FAV** button to add the channel to the Favorite List.
5. Press **EXIT** button to return to TV viewing or press **MENU** button to return to the previous menu.



Note:

- When a cable box connects to the physical channel 2, 3, or 4 in TV Guide On Screen Setup, cable channels (CATV or CADTV) will not be editable by Channel Edit. Instead, use the cable box's Channel Edit if available.

DTV Signal Strength

- Shows DTV signal levels which are received to your TV whether you need to adjust your antenna or digital cable input. The higher the signal strength, the less likely you are to experience picture degradation.
- DTV Signal: Only when the input signal is DTV or CADTV, this function is available.

1. Press the **MENU** button and then use **▲ / ▼** button to select the **SETUP** menu.
2. Press the **▶** button and then use **▲ / ▼** button to select **DTV Signal**.
3. View the on-screen signal strength monitor to see the quality of the signal being received.
4. Press **EXIT** button to return to TV viewing or press **MENU** button to return to the previous menu.

Setup Menu Options

Channel Label Setup

- Choose preset labels for your channels.
- If a channel label is provided on the signal from the broadcasting station, the TV displays a short name for a channel - even if you didn't preset a label for the channel.

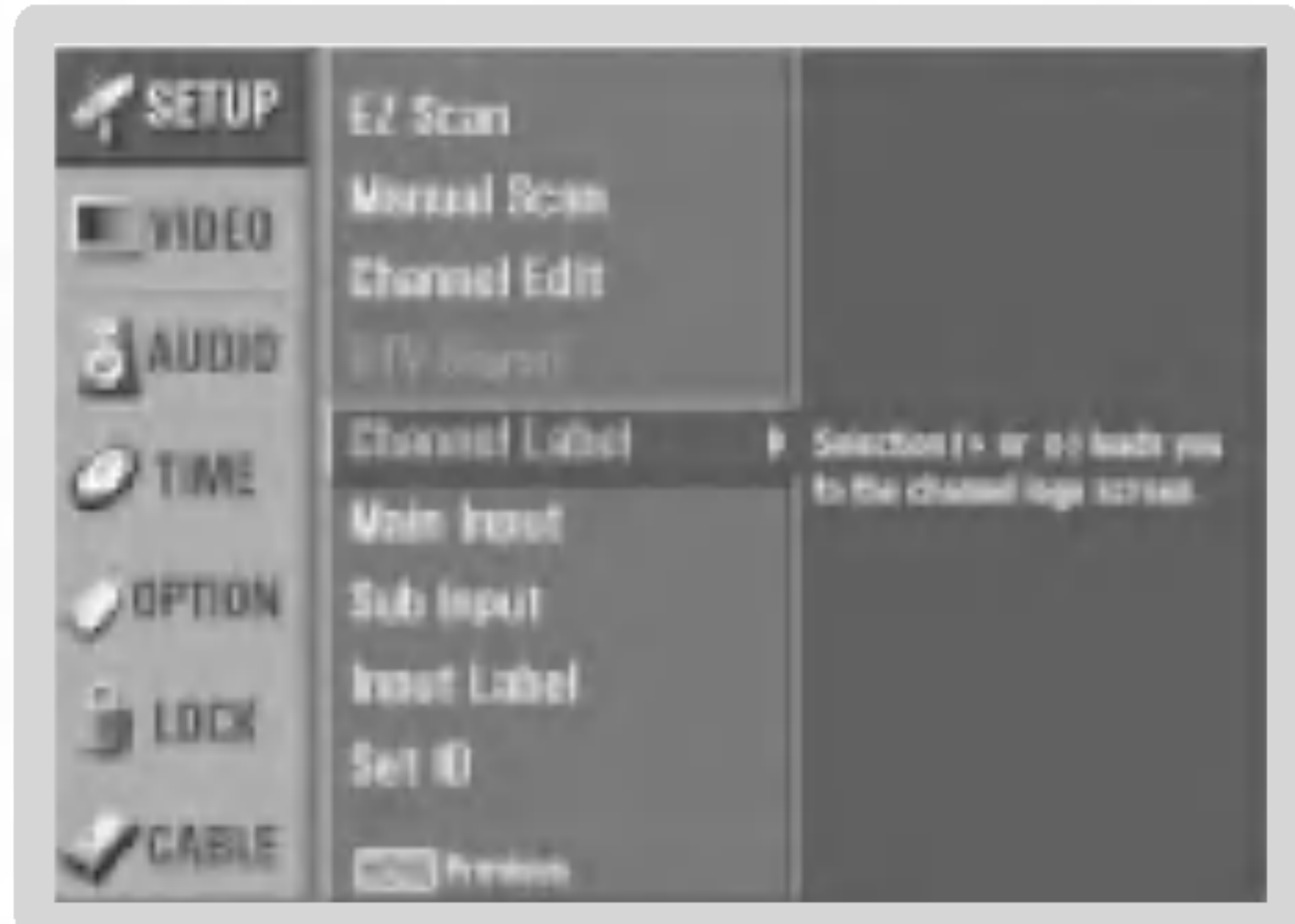

1. Press the **MENU** button and then use **▲ / ▼** button to select the **SETUP** menu.
2. Press the **▶** button and then use **▲ / ▼** button to select **Channel Label**.
3. Press the **▶** button. You will now see a screen filled with Labels and a preview screen.
4. Use the **CH ▲/▼** button to select a channel to Label.
5. Use **▲ / ▼ / ◀ / ▶** button to select the appropriate label for the channel, then press **ENTER** button to set the Label to the selected channel.

- If you press **ENTER** button in TV viewing mode, you will see the channel banner.

• For example:



Main Picture Source Selection

- Change the picture source so you can watch your TV, cable TV, VCR, DVD, or any other devices that are connected to your TV.

1. Press the **MENU** button and then use **▲ / ▼** button to select the **SETUP** menu.
2. Press the **▶** button and then use **▲ / ▼** button to select **Main Input**.
3. Press the **▶** button and then use **▲ / ▼** button to select the source: Antenna, Cable, Video, Front Video, Component1, Component2, RGB-DTV (or RGB-PC), HDMI1/DVI or HDMI2.
4. Press **EXIT** button to return to TV viewing or press **MENU** button to return to the previous menu.

Note:

- To toggle RGB-DTV and RGB-PC, select RGB-DTV(or RGB-PC) and press **▶** button.

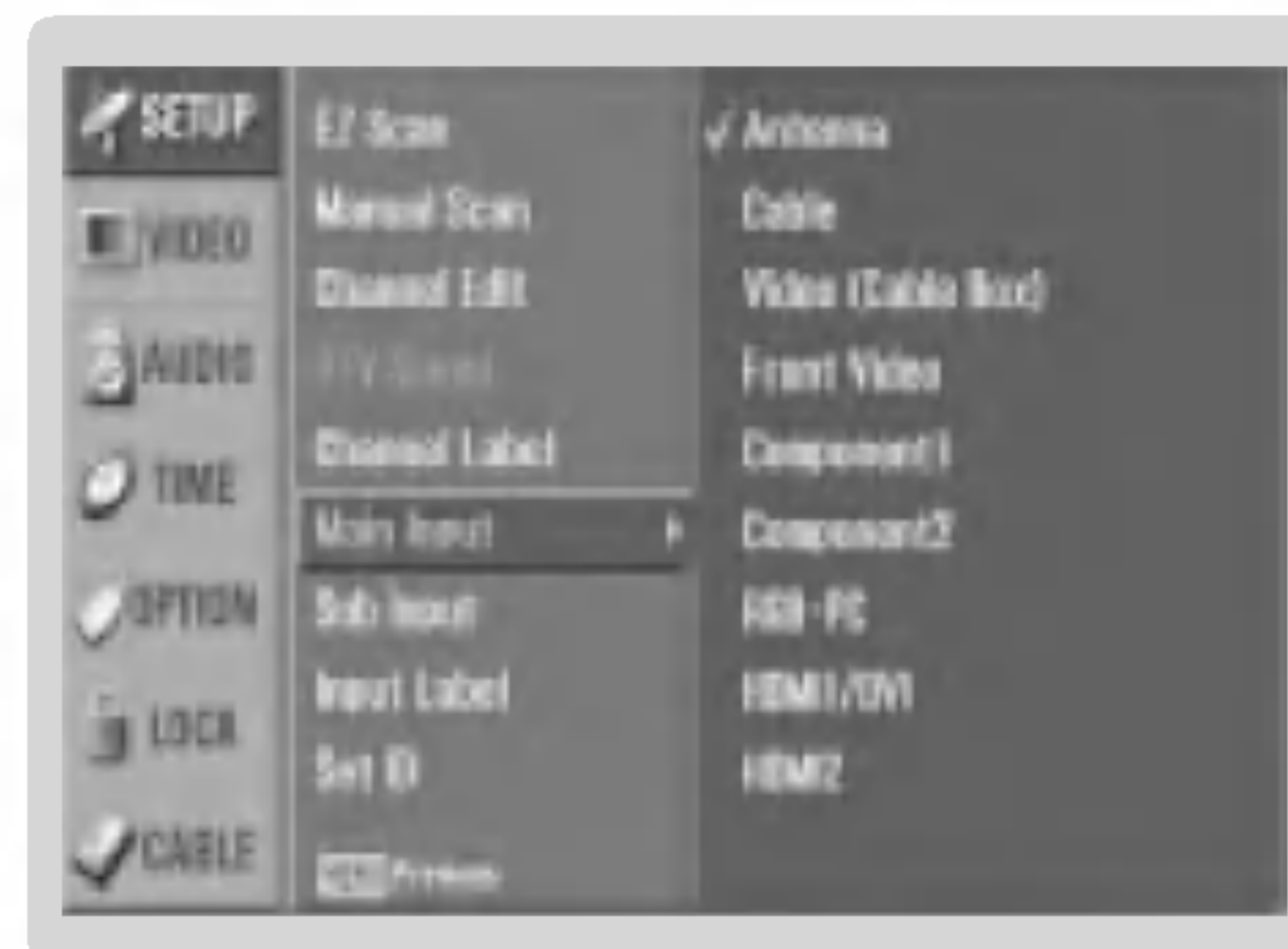

Input Label

- Sets a label to each input source or lets you skip the input source which is not in use when you press **TV/VIDEO** button.

1. Press the **MENU** button and then use **▲ / ▼** button to select the **SETUP** menu.
2. Press the **▶** button and then use **▲ / ▼** button to select **Input Label**.
3. Press the **▶** button and then use **▲ / ▼** button to select the source: Video, Front Video, Component1, Component2, RGB, HDMI1/DVI or HDMI2.
4. Press the **◀ / ▶** button to select the label.
5. Press **EXIT** button to return to TV viewing or press **MENU** button to return to the previous menu.



Video Menu Options

EZ Picture

- EZ Picture adjusts the TV for the best picture appearance. Select the preset value in the EZ Picture menu based on the program category.
 - When adjusting Video menu options (contrast, brightness, color, sharpness, tint, and color temperature) manually, EZ Picture automatically changes to **Custom**.
 - **Daylight, Normal, Night Time, Movie, Video Game, and Sports** settings are preset for optimum picture quality at the factory and are not adjustable.
1. Press the **EZ PIC** button repeatedly to select the picture appearance setup option as shown below:
 - **Custom** (your own settings), **Daylight, Normal, Night Time, Movie, Video Game, and Sports**.
 - You can also use the **VIDEO** menu to adjust **EZ Picture**.
 2. Press the **EXIT** button to save and return to TV viewing or press **MENU** button to return to the previous menu.

Manual Picture Control (**Custom** option)

- Adjust the picture appearance to suit your preference and viewing situations.
1. Press the **MENU** button and then use **▲ / ▼** button to select the **VIDEO** menu.
 2. Press the **▶** button and then use **▲ / ▼** button to select the desired picture option (**Contrast, Brightness, Color, Sharpness, or Tint**).
 3. Press the **▶** button and then use **◀ / ▶** button to make appropriate adjustments.
 4. Press **EXIT** button to return to TV viewing or press **MENU** button to return to the previous menu.

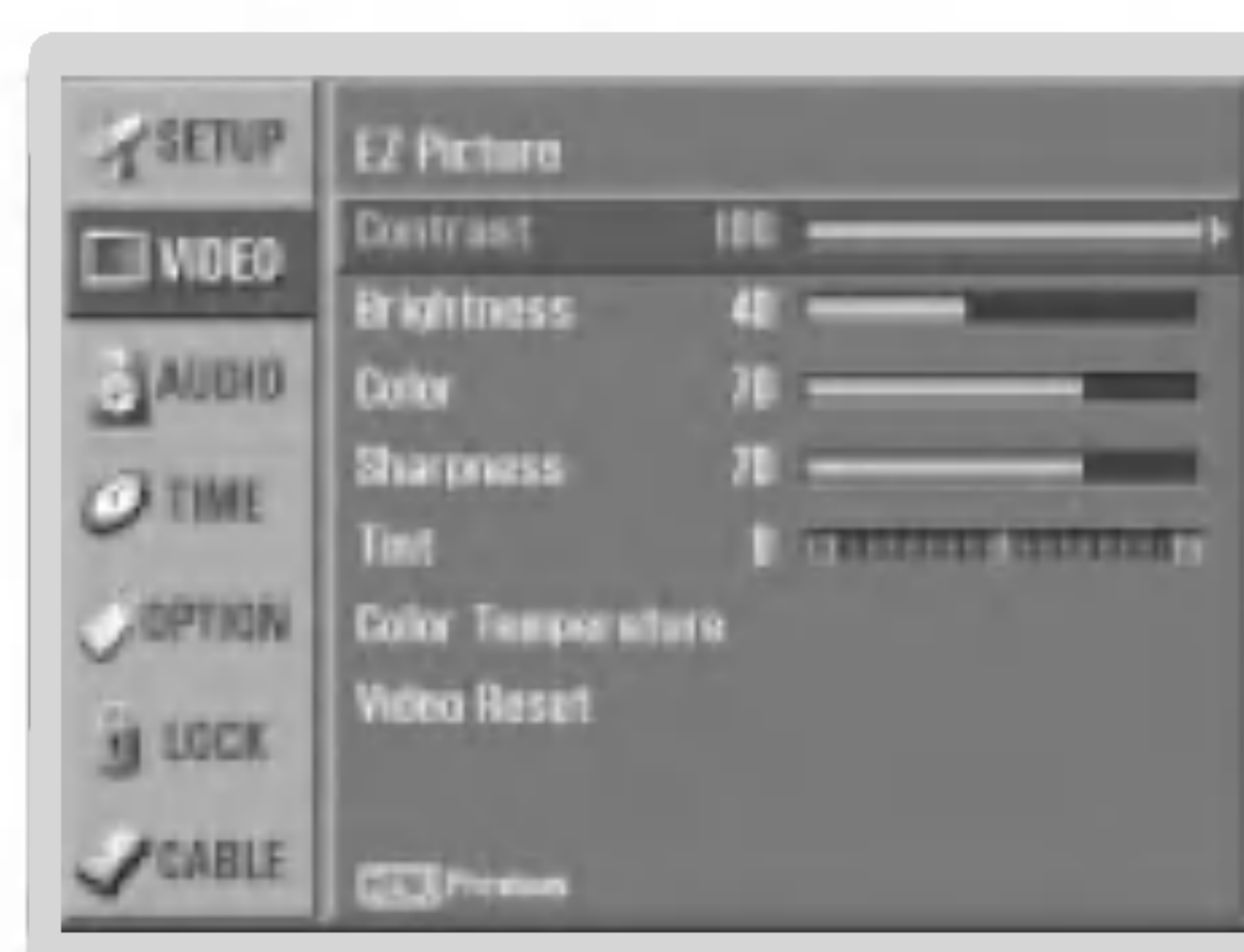

Color Temperature Control

- Choose one of three automatic color adjustments. Set to warm to enhance hotter colors such as red, or set to cool to see less intense colors with more blue.
1. Press the **MENU** button and then use **▲ / ▼** button to select the **VIDEO** menu.
 2. Press the **▶** button and then use **▲ / ▼** button to select **Color Temperature**.
 3. Press the **▶** button and then use **▲ / ▼** button to select either **Cool, Medium** or **Warm**.
 4. Press **EXIT** button to return to TV viewing or press **MENU** button to return to the previous menu.



Video Reset

- Use to quickly reset all the Video menu options to their original factory preset values.
1. Press the **MENU** button and then use **▲ / ▼** button to select the **VIDEO** menu.
 2. Press the **▶** button and then use **▲ / ▼** button to select **Video Reset**.
 3. Press the **▶** button to reset the Video menu options to original values.



Audio Menu Options

Audio Language

- Other languages may be available if a digital signal is provided by the broadcasting station.
1. Press the **MENU** button and then use ▲ / ▼ button to select the **AUDIO** menu.
 2. Press the ► button and then use ▲ / ▼ button to select **Audio Language**.
 3. Press the ► button and then use ▲ / ▼ button to select: English, Spanish, or French.
 4. Press **EXIT** button to return to TV viewing or press **MENU** button to return to the previous menu.

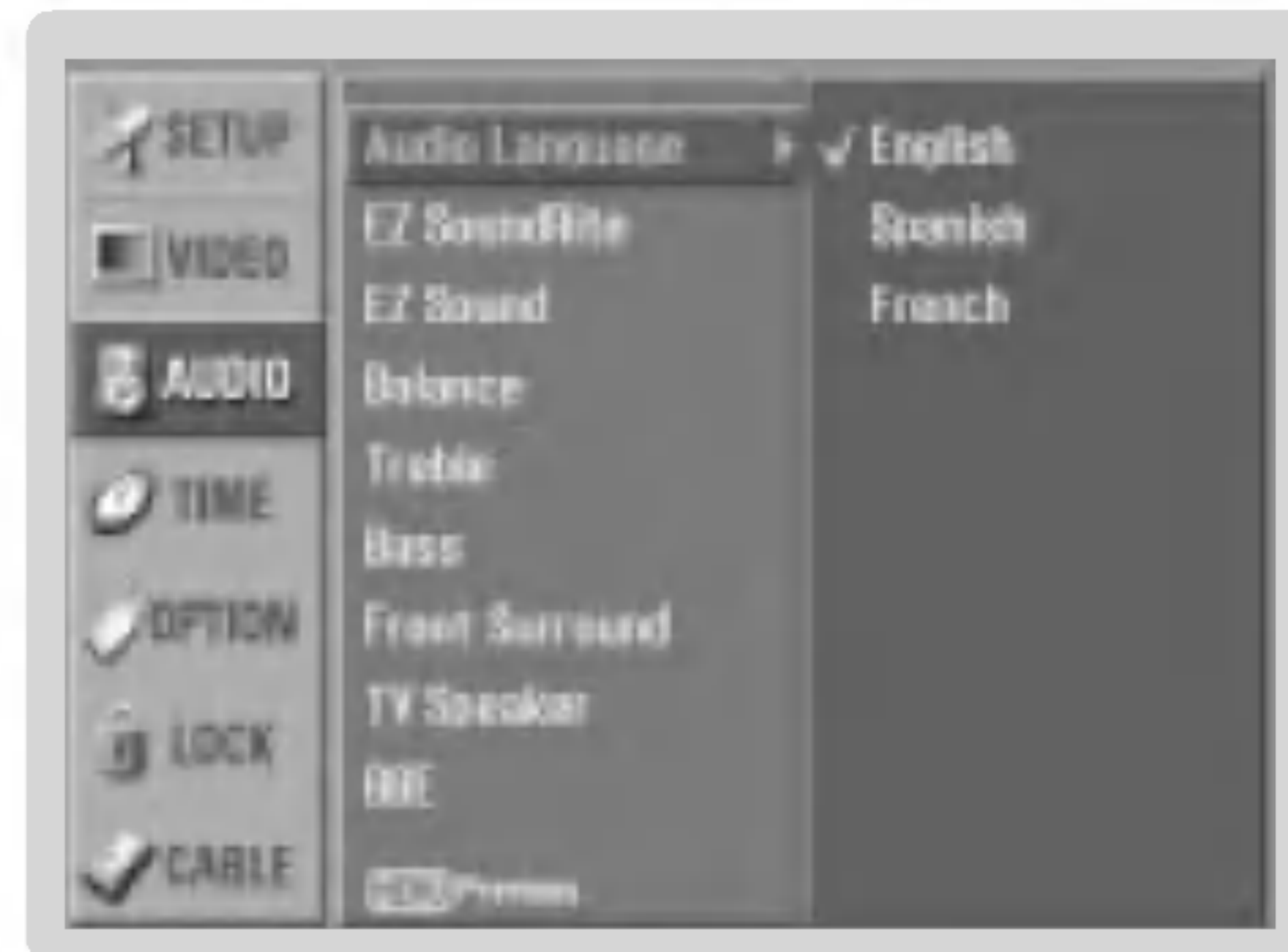

EZ SoundRite

- Scans for changes in sound level during commercials, then adjusts the sound to match the specified audio level. EZ SoundRite makes sure that the volume level remains consistent whether you are watching a commercial or a regular TV program.
1. Press the **MENU** button and then use ▲ / ▼ button to select the **AUDIO** menu.
 2. Press the ► button and then use ▲ / ▼ button to select **EZ SoundRite**.
 3. Press the ► button and then use ▲ / ▼ button to select **On** or **Off**.
 4. Press **EXIT** button to return to TV viewing or press **MENU** button to return to the previous menu.



EZ Sound

- EZ Sound lets you enjoy the best sound without any special adjustment because the TV sets the appropriate sound options based on the program content.
 - When adjusting sound options (treble, bass, and front surround) manually, EZ Sound automatically switches to **Custom**.
 - **Normal, Stadium, News, Music, and Theater** are preset for good sound quality at the factory and are not adjustable.
1. Press the **EZ SOUND** button repeatedly to select the appropriate sound setup as shown below: **Custom** (your own settings), **Normal, Stadium, News, Music, and Theater**.
 - You can also adjust **EZ Sound** in the **AUDIO** menu.
 2. Press **EXIT** button to save and return to TV viewing or press **MENU** button to return to the previous menu.

Manual Sound Control (**Custom** option)

- Adjust the sound to suit your taste and room situations.
1. Press the **MENU** button and then use ▲ / ▼ button to select the **AUDIO** menu.
 2. Press the ► button and then use ▲ / ▼ button to select the desired sound option (**Balance, Treble, or Bass**).
 3. Press the ► button and then use ◀ / ▶ button to make appropriate adjustments.
 4. Press **EXIT** button to return to TV viewing or press **MENU** button to return to the previous menu.



Front Surround

-  is a trademark of SRS Labs, Inc.
- TruSurround XT technology is incorporated under license from SRS Labs, Inc.
- Manufactured under license from Dolby Laboratories. "Dolby" and the double-D symbol are trademarks of Dolby Laboratories.

1. Press the **MENU** button and then use **▲ / ▼** button to select the **AUDIO** menu.
2. Press the **▶** button and then use **▲ / ▼** button to select **Front Surround**.
3. Press the **▶** button and then use **▲ / ▼** button to select **Off**, **3D EchoSound System** or **SRS (Sound Retrieval System) TruSurround XT**.

• 3D EchoSound System

Creates a stunning simulated stereo effects from any mono sound and a realistic three-dimensional sound with a very wide and deep sound stage into stereo sound.

• SRS TruSurround XT

Takes advantage of any multi-channel format without needing to add extra speakers or equipment. Dialog clarity, bass enrichment, and the addition of stereo audio enhancement that produces an immersive sound experience from standard stereo material.

4. Press **EXIT** button to return to TV viewing or press **MENU** button to return to the previous menu.



TV Speakers On/Off Setup

- Turn TV speakers off if using external audio equipment. Feature turns the TV Speakers option On or Off.

1. Press the **MENU** button and then use **▲ / ▼** button to select the **AUDIO** menu.
2. Press the **▶** button and then use **▲ / ▼** button to select **TV Speaker**.
3. Press the **▶** button and then use **▲ / ▼** button to select **On** or **Off**.
4. Press **EXIT** button to return to TV viewing or press **MENU** button to return to the previous menu.

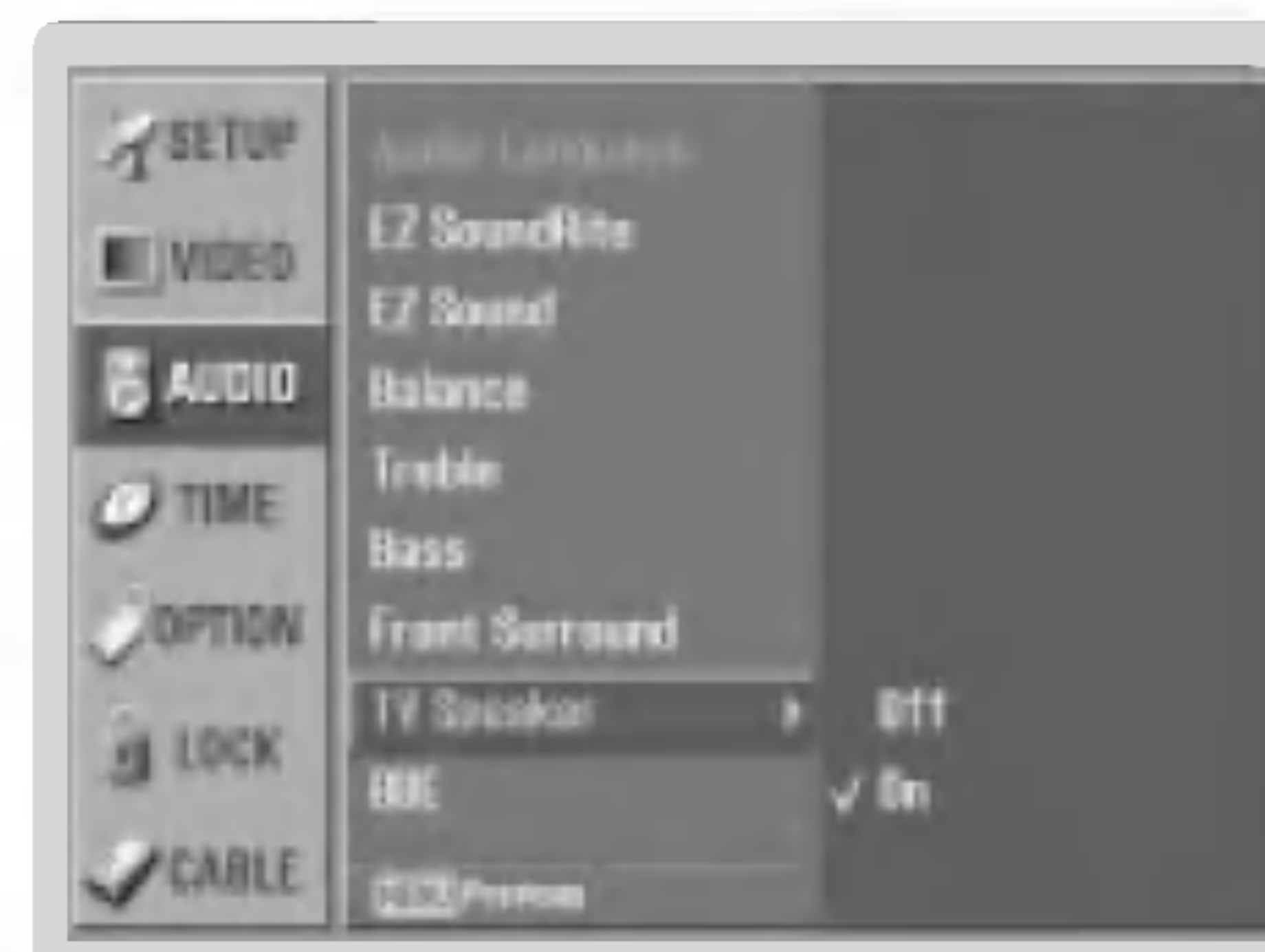

Audio Menu Options

BBE

- BBE High Definition Sound restores clarity and presence for better speech intelligibility and music realism.

1. Press the **MENU** button and then use ▲ / ▼ button to select the **AUDIO** menu.
2. Press the ► button and then use ▲ / ▼ button to select **BBE**.
3. Press the ► button and then use ▲ / ▼ button to select **On** or **Off**.
4. Press **EXIT** button to return to TV viewing or press **MENU** button to return to the previous menu.

- **BBE**. Manufactured under license from BBE Sound, Inc.
- Treble, Bass or BBE aren't suitable for **SRS TSXT** mode.



Stereo/SAP Broadcasts Setup

- This TV can receive MTS stereo programs and any SAP (Secondary Audio Program) that accompanies the stereo program; if the station transmits an additional sound signal as well as the original one.
- When having selected Stereo or SAP button on the remote control, this TV can only receive the signal when the TV station transmits the proper signals.
- Mono sound is automatically received if the broadcast is only in Mono; even though Stereo or SAP has been selected.
- Select Mono if you want to listen to mono sound during stereo/SAP broadcasting.
- Stereo or SAP can be received in a Analog channel.

1. Use the **SAP** button to select your desired MTS mode in a analog signal. Each time you press the **SAP** button, **Mono**, **Stereo**, or **SAP** appear in turn.
 - If other languages are available on the digital signal, select them with the **SAP** button.
2. Press **EXIT** button to save and return to TV viewing.

Time Menu Options

Auto Clock Setup

- The time is set automatically from a digital channel signal.
- The digital channel signal includes information for the current time provided by the broadcasting station.
- Set the clock manually, if the current time is set incorrectly by the auto clock function.
- When you set up the TV Guide On Screen system, **Auto Clock** menu is not selected.

01. Press the **MENU** button and then use **▲ / ▼** button to select the **TIME** menu.
2. Press the **▶** button and then use **▲ / ▼** button to select **Auto Clock**.
3. Press the **▶** button and then use **▲ / ▼** button to select **On** or **Off**.
4. Press the **▶** button and then use **▲ / ▼** button to select your viewing area time zone: **Eastern, Central, Mountain, Pacific, Alaska, or Hawaii**.
5. Press **EXIT** button to return to TV viewing or press **MENU** button to return to the previous menu.



Manual Clock Setup

- If current time setting is wrong, reset the clock manually.
- When you set up the TV Guide On Screen system, **Manual Clock** menu is not selected.

1. Press the **MENU** button and then use **▲ / ▼** button to select the **TIME** menu.
2. Press the **▶** button and then use **▲ / ▼** button to select **Manual Clock**.
3. Press the **▶** button and then use **◀ / ▶** button to select either the year, date, or time option. Once selected, use the **▲ / ▼** button to set the year, date, and time options.
4. Press **EXIT** button to return to TV viewing or press **MENU** button to return to the previous menu.



On/Off Timer Setup

- Timer function operates only if the current time has been set.
- Off-Timer function overrides On-Timer function if they are both set to the same time.
- The TV must be in standby mode for the On-Timer to work.
- If you do not press any button within 2 hours after the TV turns on with the On Timer function, the TV will automatically revert to standby mode.

1. Press the **MENU** button and then use **▲ / ▼** button to select the **TIME** menu.
2. Press the **▶** button and then use **▲ / ▼** button to select **Off Timer** or **On Timer**.
3. Press the **▶** button and then use **▲ / ▼** button to select **On**.
 - To cancel **On/Off timer** function, select **Off**.
4. Press the **▶** button and then use **▲ / ▼** button to set the hour.
5. Press the **▶** button and then use **▲ / ▼** button to set the minutes.
6. **For only On timer function**
 - Press the **▶** button and then use **▲ / ▼** button to select the channel at turn-on.
 - Press the **▶** button and then use **▲ / ▼** button to set the sound level at turn-on.
7. Press **EXIT** button to return to TV viewing or press **MENU** button to return to the previous menu.

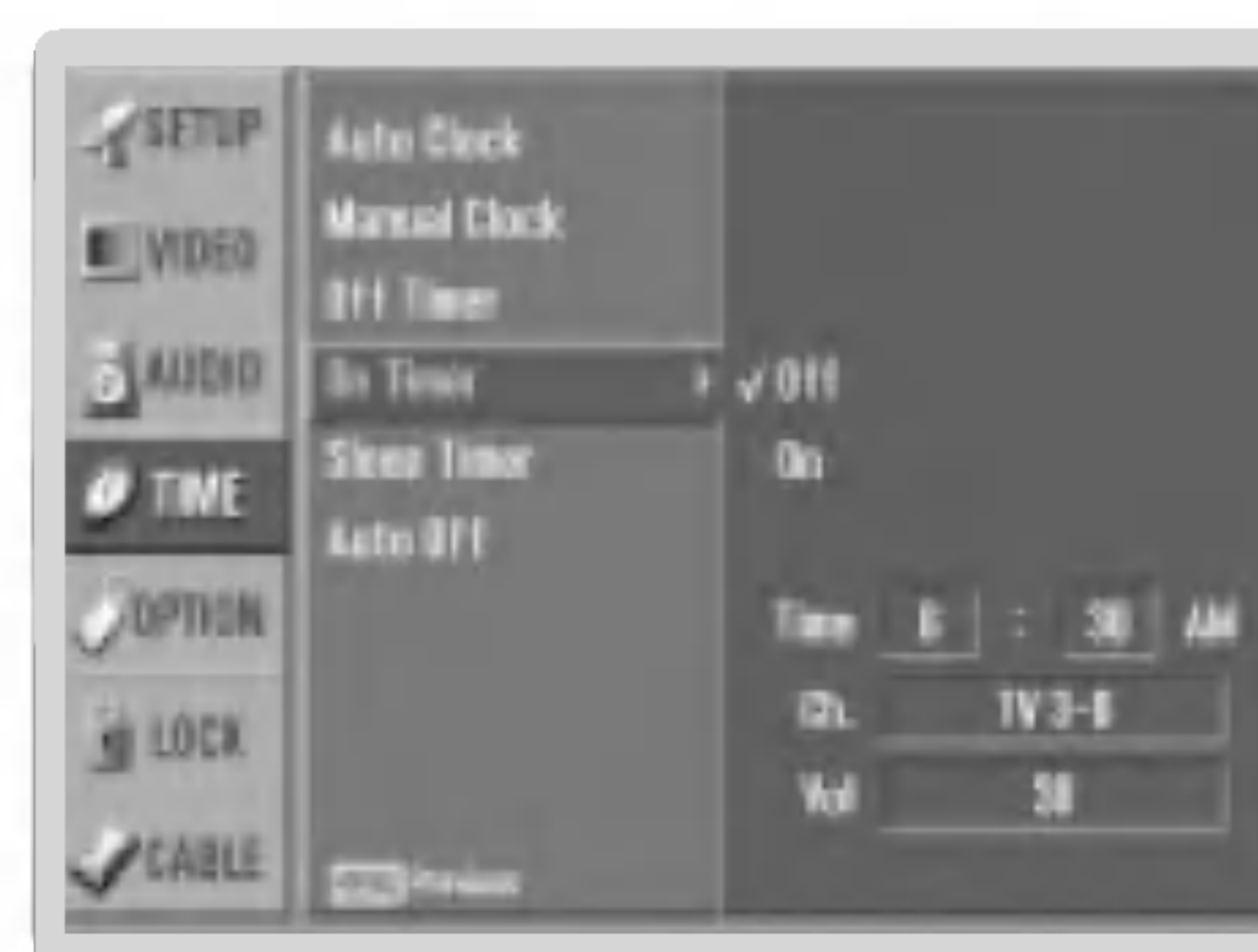

Time Menu Options

Sleep Timer

- The Sleep Timer turns the TV off at the preset time. Note that this setting is cleared when the TV is turned off.
 - You can also set up the **Sleep Timer** in the **TIME** menu.
1. Press the **TIMER** button repeatedly to select the number of minutes. First the **Off** option appears on the screen, followed by the following sleep timer options: 10, 20, 30, 60, 90, 120, 180, and 240 minutes.
 2. When the number of minutes you want is displayed on the screen, press the **ENTER** button. The timer begins to count down from the number of minutes selected.
 3. To check the remaining minutes before the TV turns off, press the **TIMER** button once.
 4. To cancel the Sleep Timer, press the **TIMER** button repeatedly to select **Off**.

Auto Off

- If set to on and there is no input signal, the TV turns off automatically after 10 minutes.
1. Press the **MENU** button and then use **▲** / **▼** button to select the **TIME** menu.
 2. Press the **▶** button and then use **▲** / **▼** button to select **Auto Off**.
 3. Press the **▶** button and then use **▲** / **▼** button to select **On** or **Off**.
 4. Press **EXIT** button to return to TV viewing or press **MENU** button to return to the previous menu.



Option Menu Features

Aspect Ratio Control

- Lets you choose the way an analog picture with a 4:3 aspect ratio is displayed on your TV with a 16:9 ratio picture format. When you receive an analog picture with a 4:3 aspect ratio on your 16:9 TV, you need to specify how the picture is to be displayed.
- If you are viewing a picture with a 16:9 aspect ratio, you can't use the Horizon aspect ratio option.
- Horizon aspect ratio is not available for Component 1-2 (480p/720p/1080i)/RGB-DTV (480p/720p/1080i)/HDMI1/DVI-DTV (720p/1080i)/DTV(720p/1080i), HDMI2-DTV(720p/1080i) input source.
- In RGB-PC/DVI-PC input source, only use 4:3 or 16:9 aspect ratio are available.
- **Note:** If a fixed image is displayed on the screen for a long time, it image may become imprinted on the screen and remain visible.

1. Press the **RATIO** button repeatedly to select the desired picture format. You can also adjust **Aspect Ratio** in the **OPTION** menu.

• Set By Program

Select the proper picture proportion to match the source's image. (4:3 → 4:3, 16:9 → 16:9)

• 4:3

Choose **4:3** when you want to view a picture with an original 4:3 aspect ratio, with gray bars appearing at both the left and right sides.

• 16:9

Choose **16:9** when you want to adjust the picture horizontally, in a linear proportion to fill the entire screen.

• Horizon

Choose **Horizon** when you want to adjust the picture in a non-linear proportion, that is, more enlarged at both sides, to create a spectacular view.

• Zoom 1

Choose **Zoom 1** when you want to view the picture without any alteration. However, the top and bottom portions of the picture will be cropped.

• Zoom 2

Choose **Zoom 2** when you want the picture to be altered, both vertically extended and cropped. The picture taking a halfway trade off between alteration and screen coverage.

• Cinema Zoom

Choose **Cinema Zoom** when you want to enlarge the picture in correct proportion. **Note:** When enlarging or reducing the picture size, the image may become distorted.

You can adjust the enlarge proportion of Cinema Zoom using ▲ / ▼ button. The adjustment range is 1~16.

Cinema 3:2 Mode Setup

- Most movies are 24 frames/sec, but TV signal is 30 frames/sec. This option lets the TV do 3:2 pull-down operation for you to watch movies at the best motion appearance.

1. Press the **MENU** button and then use ▲ / ▼ button to select the **OPTION** menu.
2. Press the ► button and then use ▲ / ▼ button to select **Cinema 3:2 Mode**.
3. Press the ► button and then use ▲ / ▼ button to select **On** or **Off**.
4. Press **EXIT** button to return to TV viewing or press **MENU** button to return to the previous menu.

Note: This feature operates only in 480i mode.

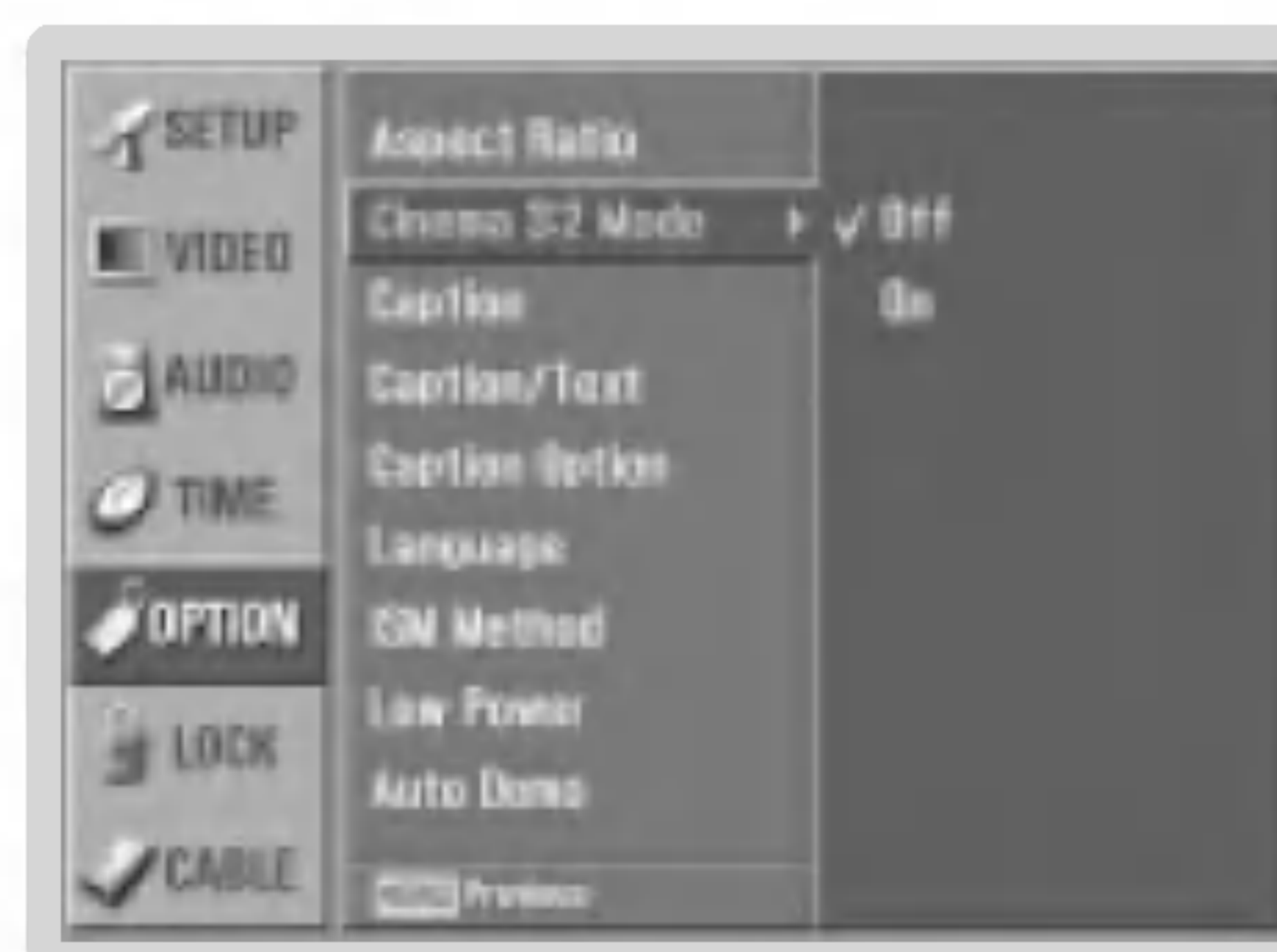

Option Menu Features

Caption

1. Press the **MENU** button and then use **▲ / ▼** button to select the **OPTION** menu.
2. Press the **▶** button and then use **▲ / ▼** button to select **Caption**.
3. Press the **▶** button and then use **▲ / ▼** button to select **On** or **Off**.
4. Press **EXIT** button to return to TV viewing or press **MENU** button to return to the previous menu.



Caption/Text

Analog Broadcasting System Captions

- Select a caption mode for displaying captioning information if provided on a program.
- Analog caption displays information at any position on the screen.
- Text displays information, usually at the bottom position and is used for a data service.
- Caption/Text, if provided by the broadcaster, would be available for both digital and analog channels on the Antenna/Cable.
- This TV is programmed to memorize the caption/text mode which was last set to, when you turn the power off.

1. Use the **CC** button repeatedly to select Caption **CC1, CC2, CC3, CC4, Text1, Text2, Text3, or Text4**.
 - **EZ Mute** shows the selected captions option (if available on program) when the TV sound is muted
2. Press **EXIT** button to save and return to TV viewing.

- You can also use the **OPTION** menu to select **Caption/Text**.

1. Press the **MENU** button and then use **▲ / ▼** button to select the **OPTION** menu.
2. Press the **▶** button and then use **▲ / ▼** button to select **Caption/Text**.
3. Press the **▶** button and then use **▲ / ▼** button to select caption: **CC1, CC2, CC3, CC4, Text1, Text2, Text3, or Text4**.

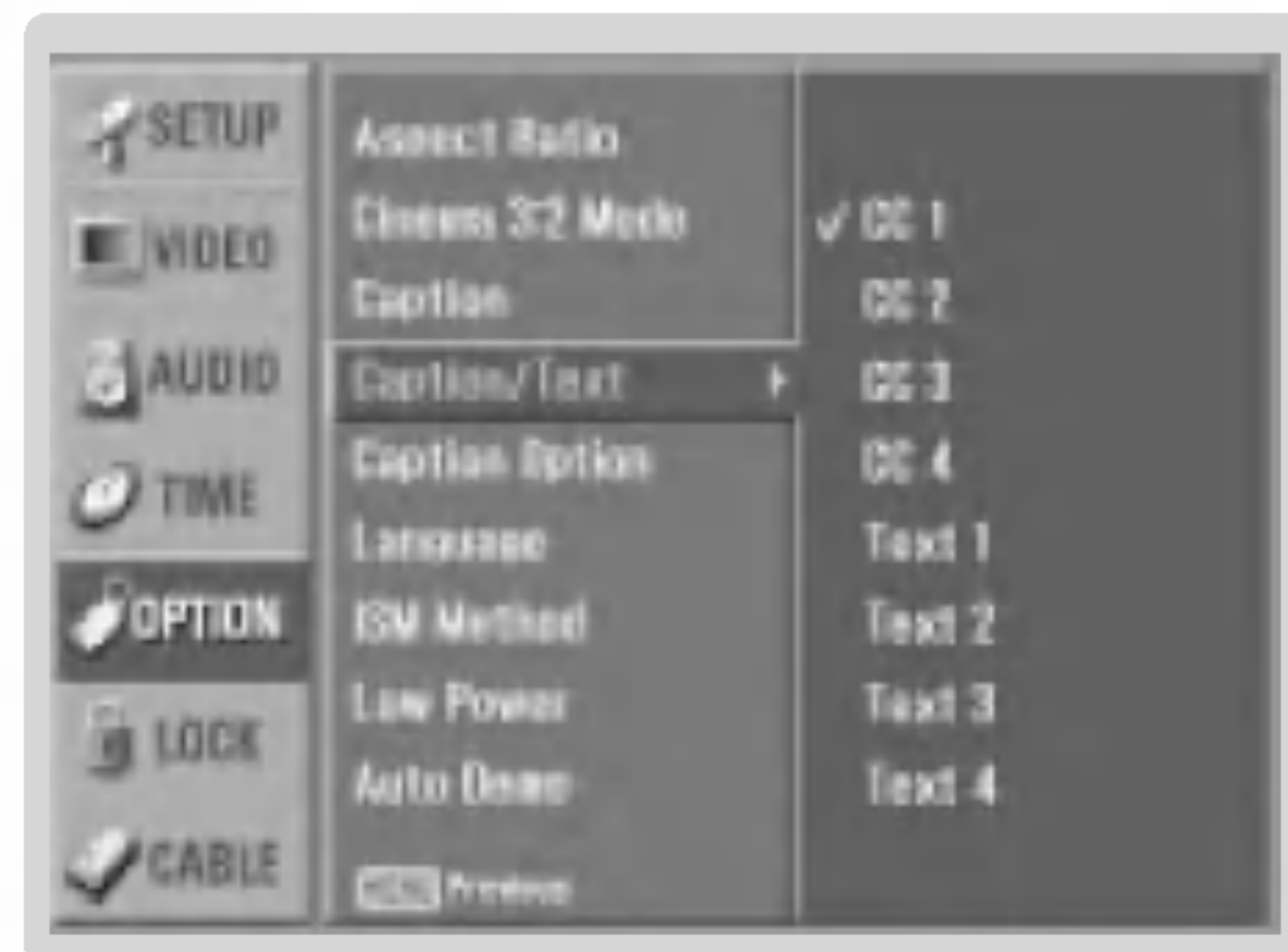

- **CAPTION**
The term for the words that scroll across the bottom of the TV screen; usually the audio portion of the program provided for the hearing impaired.
 - **TEXT**
The term for the words that appear in a large black frame and almost cover the entire screen; usually messages provided by the broadcaster.
4. Press **EXIT** button to return to TV viewing or press **MENU** button to return to the previous menu.

Digital Broadcasting System Captions

- Choose the language you want the DTV/CADTV Captions to appear in.
- Languages can be chosen for digital sources only if they are included on the program.

1. Press the **MENU** button and then use **▲ / ▼** button to select the **OPTION** menu.
2. Press the **▶** button and then use **▲ / ▼** button to select **Caption/Text**.
3. Press the **▶** button and then use **▲ / ▼** button to select available caption languages: **English, Spanish, or French**.
4. Press **EXIT** button to return to TV viewing or press **MENU** button to return to the previous menu.

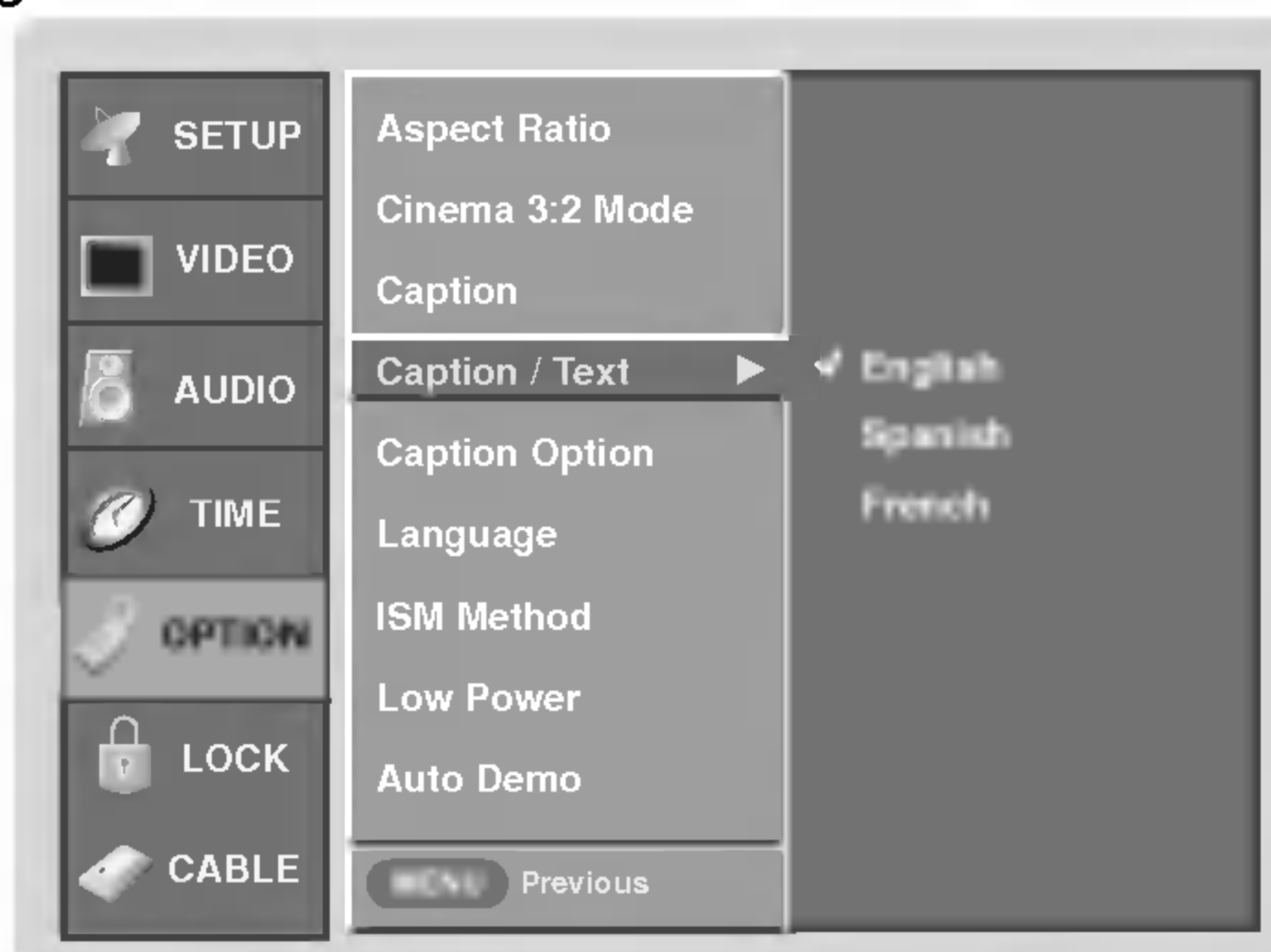

Caption Option

- Customize the DTV/CADTV captions that appear on your screen.

1. Press the **MENU** button and then use **▲ / ▼** button to select the **OPTION** menu.
2. Press the **▶** button and then use **▲ / ▼** button to select **Caption Option**.
3. Press the **▶** button and then use **◀ / ▶** button to select **Custom**.
4. Use **▲ / ▼** button to customize the Style, Font, etc., to your preference. A preview icon is provided at the bottom of the screen, use it to see the caption language.

- **Size:** Set the size of the words.
- **Font:** Select a typeface for the words.
- **Text Color:** Choose a color for the text.
- **Text Opacity:** Specify the opacity for the text color.
- **Bg (Background) Color:** Select a background color.
- **Bg (Background) Opacity:** Select the opacity for the background color.
- **Edge Type:** Select an edge type.
- **Edge Color:** Select a color for the edges.

5. Press **EXIT** button to return to TV viewing or press **MENU** button to return to the previous menu.



Option Menu Features

ISM (Image Sticking Minimization) Method

- A frozen still picture from a PC/video game displayed on the screen for prolonged periods will result in a ghost image ; even though the image is changed. Use our unique method to minimize any fixed image on the screen.

1. Press the **MENU** button and then use **▲ / ▼** button to select the **OPTION** menu.
2. Press the **▶** button and then use **▲ / ▼** button to select **ISM Method**.
3. Press the **▶** button and then use **▲ / ▼** button to select either **Normal**, **White Wash**, **Orbiter** or **Inversion**.

- **Normal**

If image sticking is never a problem, ISM is not necessary - set to Normal.

- **White Wash**

White Wash removes permanent images from the screen.

Note: An excessive permanent image may be impossible to clear entirely with White Wash. To return to normal viewing, press the any button.

- **Orbiter**

Orbiter may help prevent ghost images. However, it is best not to allow any fixed image to remain on the screen. To avoid a permanent image on the screen, the image will move once per 2 minutes: Left → Right → Upside → Downside → Right → Left → Downside → Upside.

- **Inversion**

Inversion will automatically invert the plasma display panel color every 30 minutes.

4. Press **EXIT** button to return to TV viewing or press **MENU** button to return to the previous menu.



Low Power

- Low power reduces the plasma display power consumption.

1. Press the **MENU** button and then use ▲ / ▼ button to select the **OPTION** menu.
2. Press the ► button and then use ▲ / ▼ button to select **Low Power**.
3. Press the ► button and then use ▲ / ▼ button to select **On** or **Off**.
 - When you select **On**, the screen darkens.
4. Press **EXIT** button to return to TV viewing or press **MENU** button to return to the previous menu.

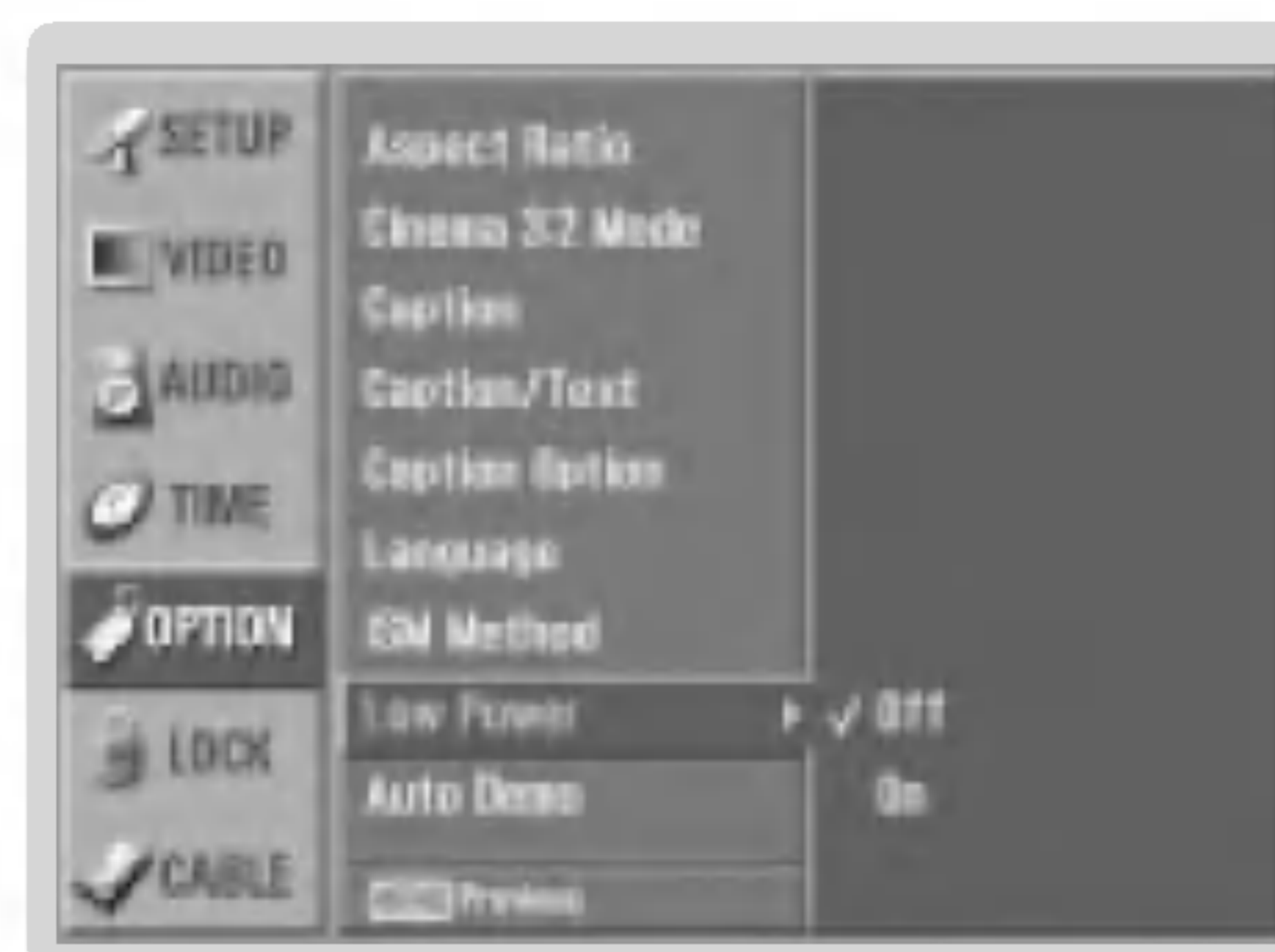

Auto Demo

- Displays the slide show to explain the main features of this TV.

1. Press the **MENU** button and then use ▲ / ▼ button to select the **OPTION** menu.
2. Press the ► button and then use ▲ / ▼ button to select **Auto Demo**.
3. Press **EXIT** button to stop Auto Demo.

Note : The images on the Auto Demo may differ from the actual products.

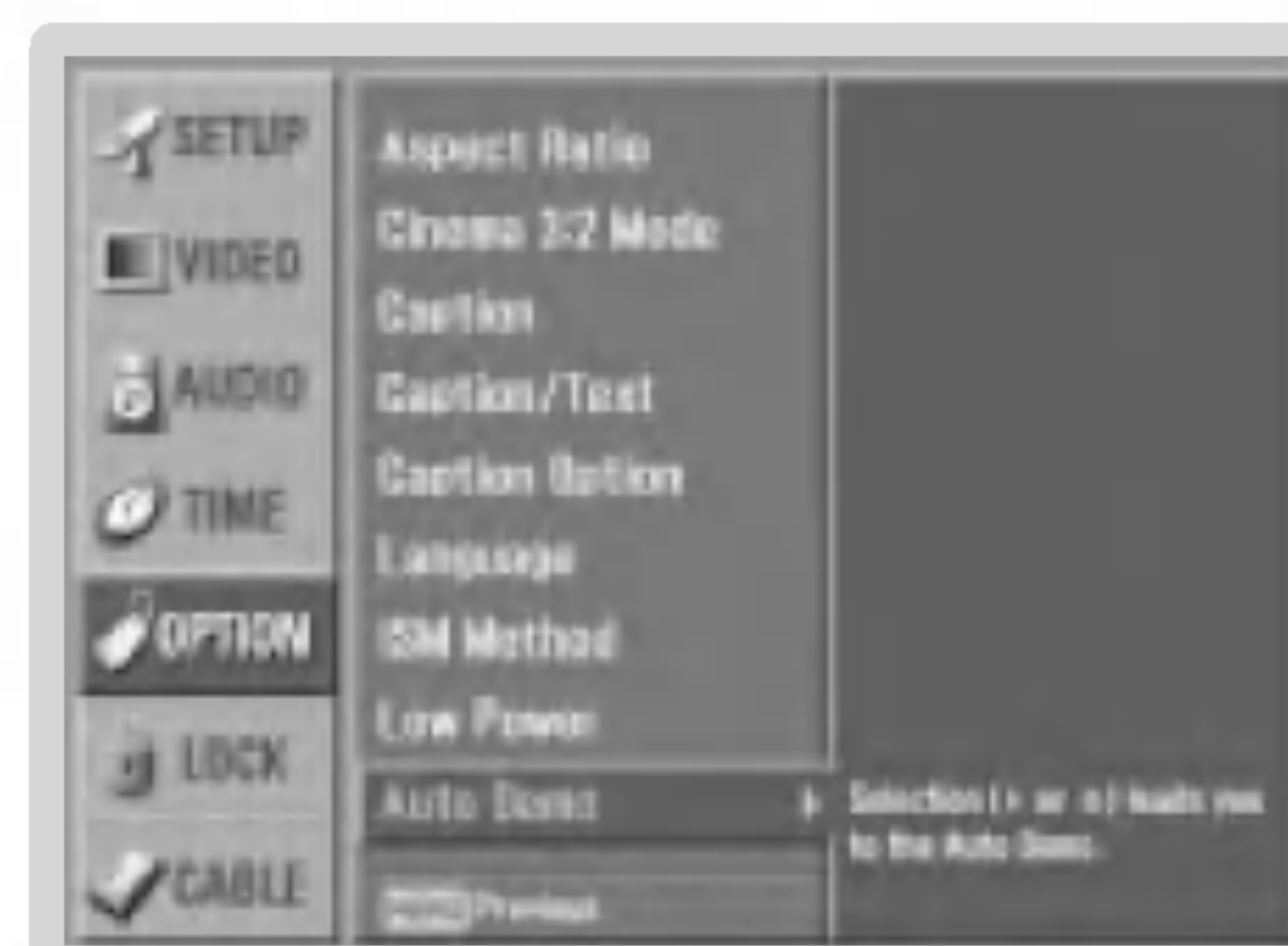

Lock Menu Options

Parental Control can be used to block specific channels, ratings and other viewing sources.

The Parental Control Function (V-Chip) is used to block program viewing based on the ratings sent by the broadcasting station. The default setting is to allow all programs to be viewed. Viewing can be blocked by choosing the type of the program and the categories. It is also possible to block all program viewing for a time period. To use this function, the following must be done :

1. Set ratings and categories to be blocked.
2. Specify a password
3. Enable the lock

V-Chip rating and categories

Rating guidelines are provided by broadcasting stations. Most television programs and television movies can be blocked by TV Rating and/or Individual Categories. Movies that have been shown at the theaters or direct-to-video movies use the Movie Rating System (MPAA) only.

Ratings for Movies previously shown in theaters:

Movie Ratings :

- Blocking Off (Permits all programs)
- G (General audience)
- PG (Parental guidance suggested)
- PG-13 (Parents strongly cautioned)
- R (Restricted)
- NC-17 (No one 17 and under admitted)
- X (Adult only)

If you set PG-13 : G and PG movies will be available , PG-13, R, NC-17 and X will be blocked.

Ratings for Television programs including made-for-TV movies :

- TV-G (General audience)
- TV-PG (Parental guidance suggested)
- TV-14 (Parents strongly cautioned)
- TV-MA (Mature audience only)
- TV-Y (All children)
- TV-Y7 (Children 7 years older)

TV Rating Children:

- Age (applies to TV-Y, TV-Y7)
- Fantasy Violence (applies to TV-Y7)

TV Rating General:

- Age (applies to TV-G, TV-PG, TV-14, TV-MA)
- Dialogue - sexual dialogue (applies to TV-PG, TV-14)
- Language - adult language (applies to TV-PG, TV-14, TV-MA)
- Sex - sexual situations (applies to TV-PG, TV-14, TV-MA)
- Violence (applies to TV-PG, TV-14, TV-MA)

Input Block

- Video, Front Video (On, Off)
- Component 1, 2 (On, Off)
- RGB, HDMI1/DVI, HDMI2 (On, Off)

Parental Lock Setup

- Set up blocking schemes to block specific channels, ratings, and external viewing sources.
- A password is required to gain access to this menu.

1. Press the **MENU** button and then use **▲ / ▼** button to select the **LOCK** menu. Then, press the **▶** button

- The TV is set up with the initial password "0-0-0-0".

2. Use the **▲ / ▼** button to choose from the following Lock Menu options. Once the option is selected, change the settings to your preference.

- **Lock System:** Enables or disables the blocking scheme you set up previously.
- **Set Password:** Change the password by inputting a new password twice.
- **Block Channel:** Blocks any channels that you do not want to watch or that you do not want your children to watch.
- **Movie Rating (MPAA):** Blocks movies according to the movie ratings limits specified, so children cannot view certain movies. You can set the ratings limit by blocking out all the movies with the ratings above a specified level. Keep in mind that the movie ratings limit only applies to movies shown on TV, not TV programs, such as soap operas.
- **TV Rating-Children:** Prevents children from watching certain children's TV programs, according to the ratings limit set. The children rating does not apply to other TV programs. Unless you block certain TV programs intended for mature audiences in the TV Rating - sub menu, your children can view those programs.
- **TV Rating-General:** Based on the ratings, blocks certain TV programs that you and your family do not want to view.
- **Input Block:** Enables you to select a source to block from the external source devices you have hooked up.

3. Press **EXIT** button to return to TV viewing or press **MENU** button to return to the previous menu.

Note:

- If you ever forget your password, key in '7', '7', '7', '7' on the remote control.



CableCARD™ Function

* In this manual, the OSD (On Screen Display) may be different from your TV's because it is just example to help the TV operation.

Cable menu options

- The Cable sub menu displays when inserting the CableCARD™ to the TV.
- The CableCARD™ type is Motorola, Scientific Atlanta (SA), or SCM etc. The OSD (On screen display) is different from your TV according to your CableCARD™ type.

1. Press the **MENU** button and then use ▲ / ▼ button to select the **CABLE** menu.
2. Press the ► button and then use ▲ / ▼ button to select your desired item.
3. Press the ► button.
4. Press **EXIT** button to return to TV viewing.

In case of Scientific Atlanta CableCARD™



i.e) CableCARD™/ Host ID Screen



As shown, the pairing number means your TV and CableCARD™ ID. For further information regarding cable TV service, contact your local cable TV service provider(s).

Scrambled channel

- Insert the CableCARD™. If you do it at first, it takes about 1 minute to exchange the data between the TV and the CableCARD™. Then, TV screen displays as shown right.
- Let your cable TV service provider know CableCARD™ ID and Host ID.
- If your cable TV service provider is registered CableCARD™ ID and Host ID, you can watch the premium or high value channel.
- If you ever registered to the cable TV service provider, you can watch the premium or high value channel without a message.



- If the certificate doesn't match between the TV and the CableCARD™, the OSD (On screen display) displays as shown left.

Cable Channel List

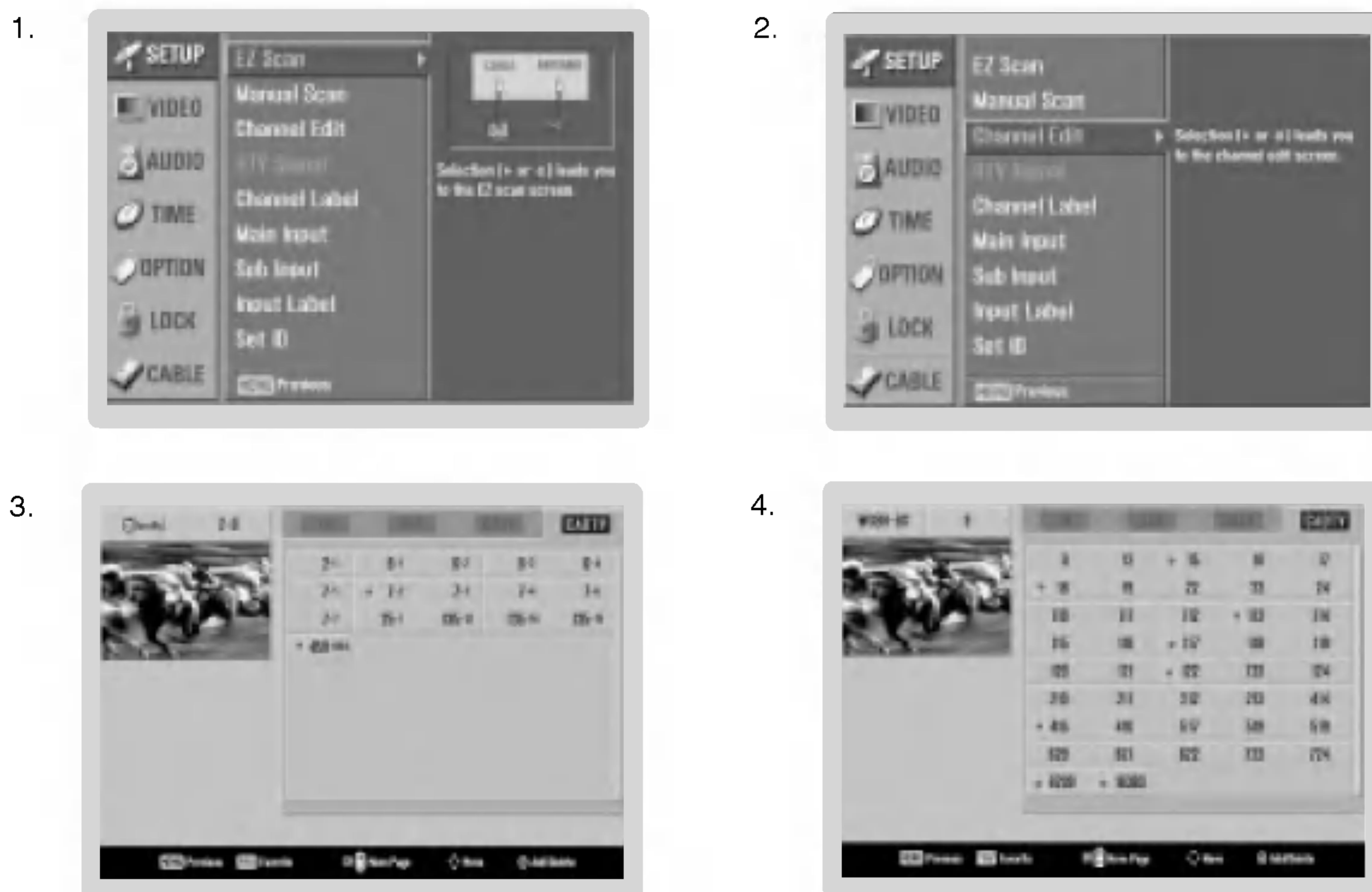

1. If you enter the **Channel Edit** after running the EZ Scan without CableCARD™, you can see the cable channel list as the picture 3 above.
2. Insert the CableCARD™. Then, the TV receive a new cable channel list which is usually one part channel. It takes about 2~3 minutes to gather the cable channel list after inserting the CableCARD™ as the picture 4 above. (Occasionally more than that time)

Emergency Alert Message

- If an emergency situation occurs during watching the TV/DTV/CATV/CADTV, you can receive a message from cable TV service provider(s).
- When receiving an emergency message, the message is displayed on the screen as shown below or the channel is changed automatically to a channel that maintains the emergency message. The message will automatically disappear after some time and return to the last channel.





- It's available to play the Photo / Music file on Memory Card.

Notes on Memory Card

What is Memory Card

This is a device equipment to communicate the data between AV external equipment. It's used to a digital camera, camcorder, MP3 player, notebook or PDA.

Precaution for Using the Memory Card

- Please be sure to insert the correct memory card type in the right direction.
(Confirm between the two memory slots before insertion.)
- Don't insert the metal substances into the slots of the memory card.
- Do not bend, drop or apply strong shock to memory card.
- After pulling the memory card out from the TV, please keep the memory stick in a appropriate case to prevent it from static shock.
- The stored data may be changed or lost as a result of misuse, static electricity.
- Do not turn the power off while the memory card is in operation.
- Don't eject the memory card while in use. Otherwise, it may cause a data loss or card damage.
- Insert only one card to each slot.
- To prevent a change or loss for stored data, don't misuse the TV or don't let static electricity or electrical noise for TV.
- This Company takes no responsibility for problems such as the damage or malfunction that occurs while using the TV set, inappropriate TV settings, or any other reasons, except for defects or malfunctions intrinsic to the product.
- Ensure to use a memory card that lists the manufacturers name and serial number.
- The manufacturer will not be responsible for any data damage. Making back up data is strongly recommended.
- Make sure to comply with the following steps when ejecting a memory card.
- Each Memory Card is complied with standard.

How to insert and eject the Memory Card

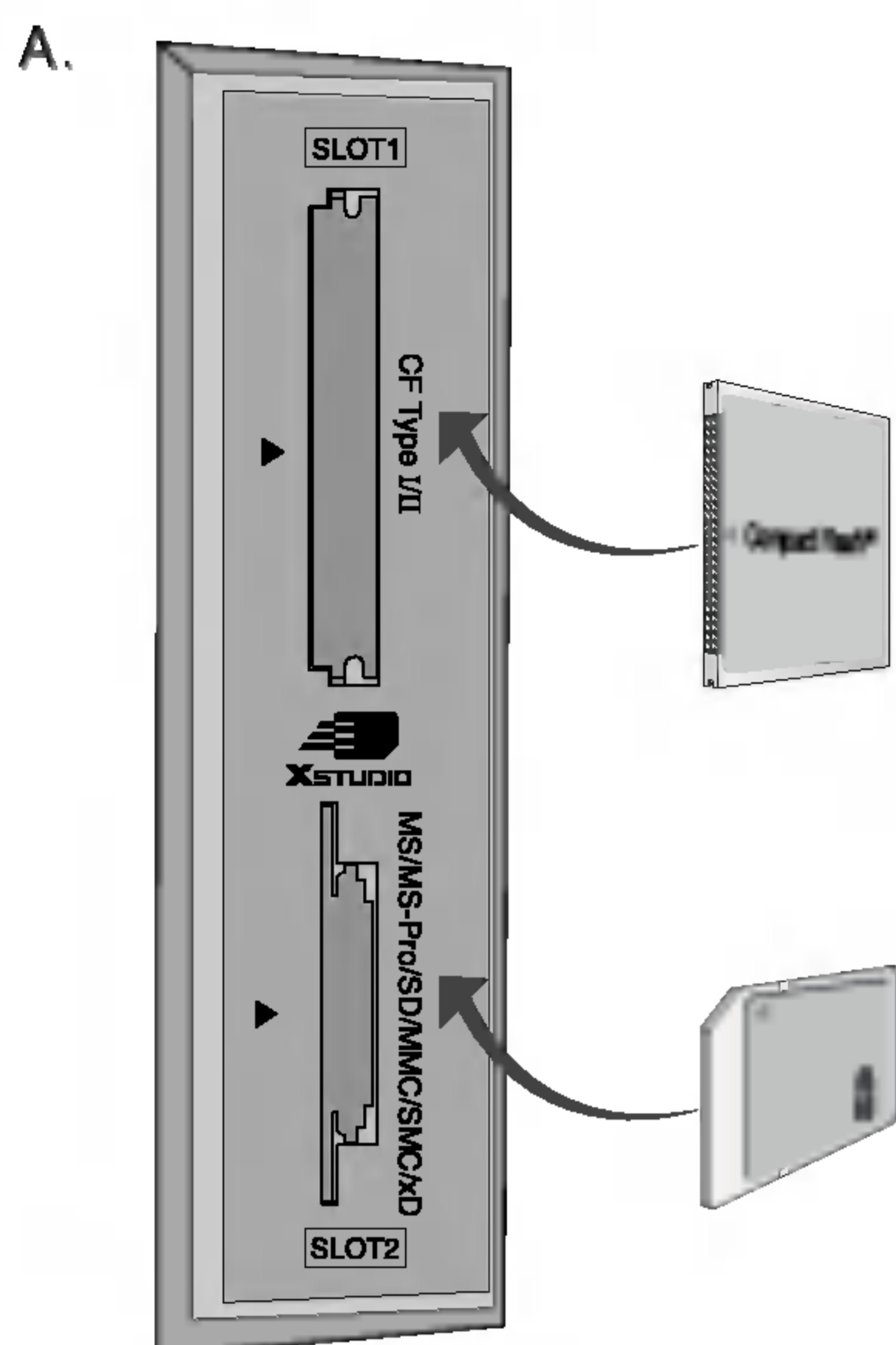

◆ Inserting a Card

1. Insert the Memory Card to Memory card slots of TV side panel.
2. Two slots support different types of the Memory Cards.
3. If a Memory Card is not inserted, each slot is disabled.

◆ Ejecting a card

1. Press the **M/C EJECT** button on the remote control.
2. Select the **Slot 1** or **Slot 2** based on the inserted card location.
If you select **Cancel**, OSD will disappear.
3. Eject the card by the hand.



Caution: Press the **M/C EJECT** button of remote control before removing the memory card. Failure to do so may damage the card.

Memory Card type

- Use the specified card based on the slot location.
- 9 types of Memory Card can be used for this Plasma TV.
- Some MagicStor Plus card is not complied with the TV.

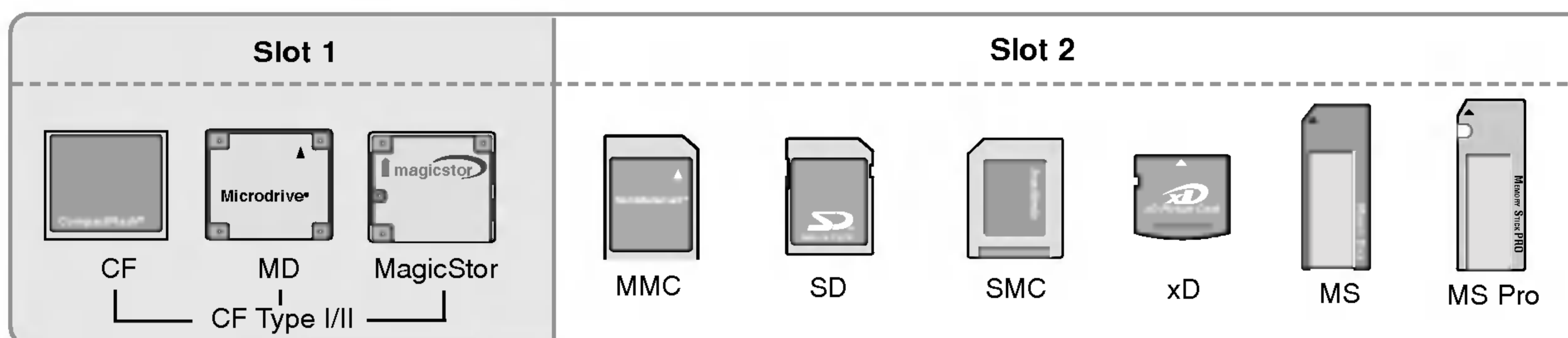

Available file in XSTUDIO mode

A sort of file	Photo Image (JPEG)	Music File (MP3)
Compatibility	*.jpg	*.mp3
Memory card capacity	CF (CompactFlash) : 4GB MD (Microdrive) : 4GB CF+II (MagicStor) : 2.2GB SD (Secure Digital) : 1GB MMC (MultiMedia Card) : 1GB An error may occur if you use a memory card with greater than the specified capacity.	MS (Memory Stick) : 128MB MS Pro (Memory Stick Pro) : 1GB SMC (Smart Media Card) : 128MB xD (Extream Digital Picture Card) : 512MB
Unsupported or damaged file	Unsupported or damaged JPEG or MP3 files can cause errors. Do not try to change the file extension of unsupported file types to the file extension of supported file types.	

Notes on Memory Card

Select the Photo or Music

- When you plug the Memory Card, this screen is displayed, automatically.

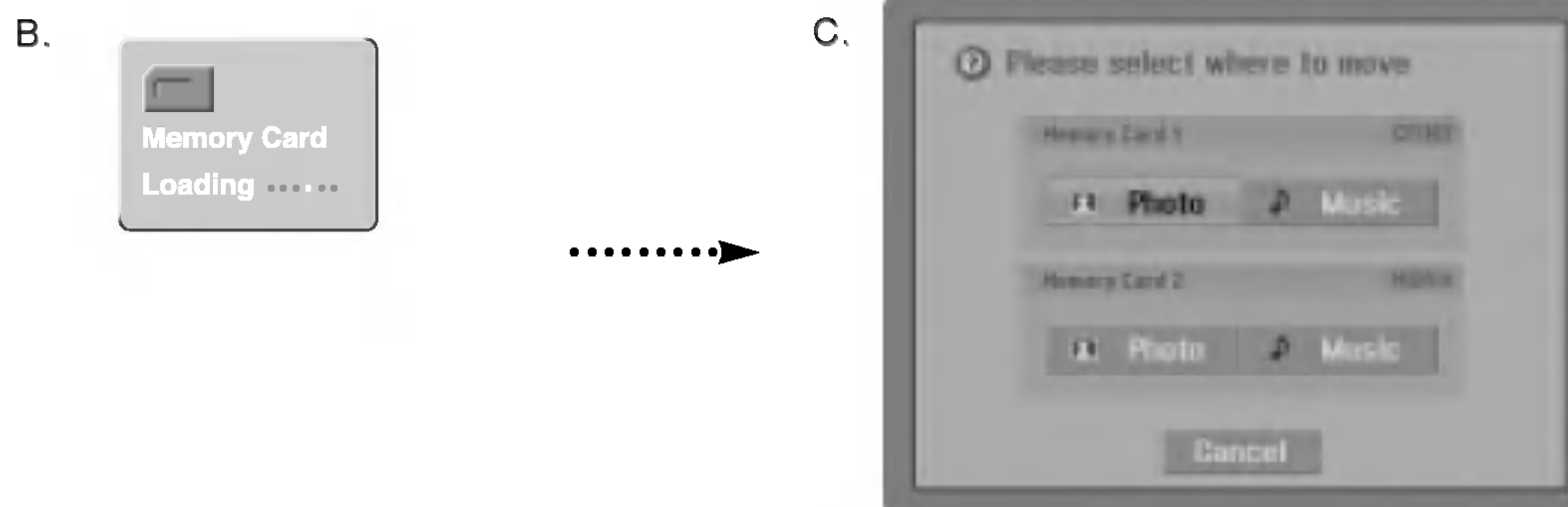

- When you plug a memory card or press the  button, the above screens will be displayed.

1. Press **▲ / ▼ / ◀ / ▶** button to select either **Photo** or **Music** on **Memory Card 1** or **Memory Card 2**.
2. Press **ENTER** button to view **Photo List** or **Music List** of each slot.
3. Press **EXIT** button or  button to return to TV viewing.

Note: In 30 seconds later, "Loading" message is disappeared.

Photo List

- When you select **Photo** in entry menu, you will now see a screen filled with thumbnail photos.

* In this manual, the OSD (On Screen Display) may be different from your TV's because it is just an example to help you with the TV operation.

Screen Components

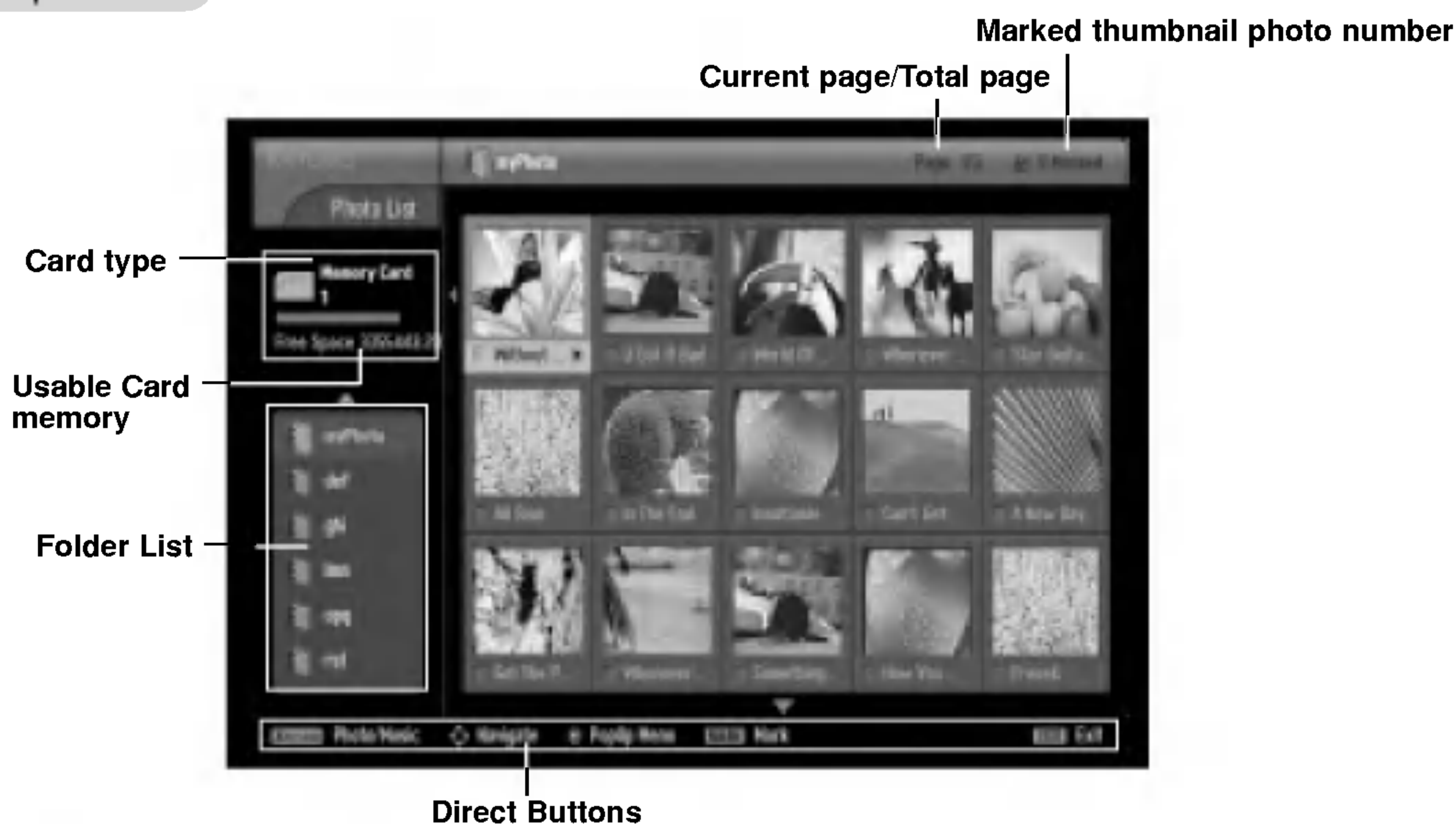
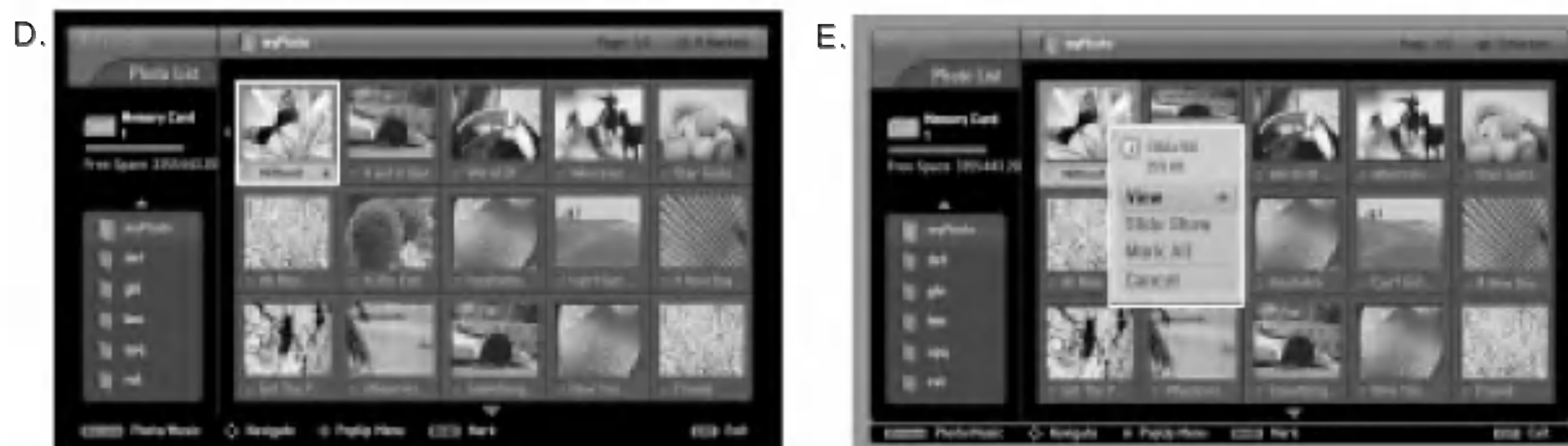

Photo Selection and PopUp Menu



1. Use the **CH ▲/▼** button to navigate thumbnail photos in pages.
2. Use **MARK** button to mark or unmark a photo. When one or more photos are marked, you can view or slideshow only the marked ones. If no photo is marked, you can view or slideshow all photos in the folder.
3. Use **▲ / ▼ / ◀ / ▶** button to navigate the appropriate thumbnail photos, then press the **ENTER** button to show the PopUp menu.
 - **View:** See the selected item to the full screen.
View state change to slide show state by pressing the **PLAY (▶)** button.
 - **Slide Show:** Start a slide show with all photos in the folder. The slide show state can be changed to the view state by pressing the **Pause (||)** button. Before starting a slide show, you can choose the slide show interval (3,6 or 9 seconds). **Note:** 4 hours later, Slide Show is ended, automatically.
 - **Mark All:** Mark all photos on the screen.
 - **Unmark All:** Unmark all marked photos.
 - **Cancel:** Hide the pop-up menu.
4. Repeatedly, press **EXIT** button to return to TV viewing or press **Xtreme** button to return to the entry menu.

Music List

- When you select **Music** in the entry menu, you will now see a screen filled with music titles.
- **Purchased MP3/music files may contain copyright restrictions. Playback of these files may not be supported by this model.**

* In this manual, the OSD (On Screen Display) may be different from your TV's because it is just an example to help you with the TV operation.

Screen Components



1. Use the **CH ▲ / ▼** button to navigate music titles in pages.
 2. Use **MARK** button to mark or unmark a music title. When one or more music titles are marked, the marked music will be played by turns. For example, if you want to listen to only one music repeatedly, just mark the music only and play it. If no music title is marked, all the music in the folder will be played in sequence.
 3. Use **▲ / ▼ / ◀ / ▶** button to navigate the appropriate music titles, then press the **ENTER** button to set the pop-up menu.
 - **Play:** Play the selected music.
 - **Stop Play:** Stop the play.
 - **Play With Photo:** Start playing the selected music by turns and then move to the Photo List.
 - **Mark All:** Mark all music titles in the folder.
 - **Unmark All:** Unmark all marked music.
 - **Cancel:** Hide the pop-up menu.
 4. Repeatedly, press **EXIT** button to return to TV viewing or press  button to return to the entry menu.
- If you don't press any button for 40 seconds, the play information box (as shown in the below) will float as a screen saver.

 * The **'Screen Saver'**?
Screen saver is to prevent screen pixel burning caused by long time still picture.



Notes:

- When music is playing,  is displayed in front of the music title.
- If you press any button except **VOL ▲ / ▼**, **MUTE**, **▶**, **||**, **■**, **◀◀**, **▶▶** buttons, screen saver is stopped.
- The **▶**, **||**, **■**, **◀◀**, **▶▶** buttons on the remote control are also available in this mode.

Remote Control

PIP (Picture-In-Picture) / POP / Twin Picture

- PIP lets you view 2 different inputs (sources) on your TV screen at the same time. One source will be large, and the other source will show a smaller inset image.
- Twin Picture mode splits the screen into two images, allowing two picture sources to be shown on the TV screen at the same time. Each source is given half the screen.
- In PIP/POP/Twin Picture mode, the screen savers such as "**No Signal**", "**Rating Blocked**", "**Channel Blocked**", or "**Aux Blocked**" may not be displayed on screen.

Watching PIP/POP/Twin Picture

Press the PIP button to access the sub picture. Each press of PIP changes the PIP options as shown below.

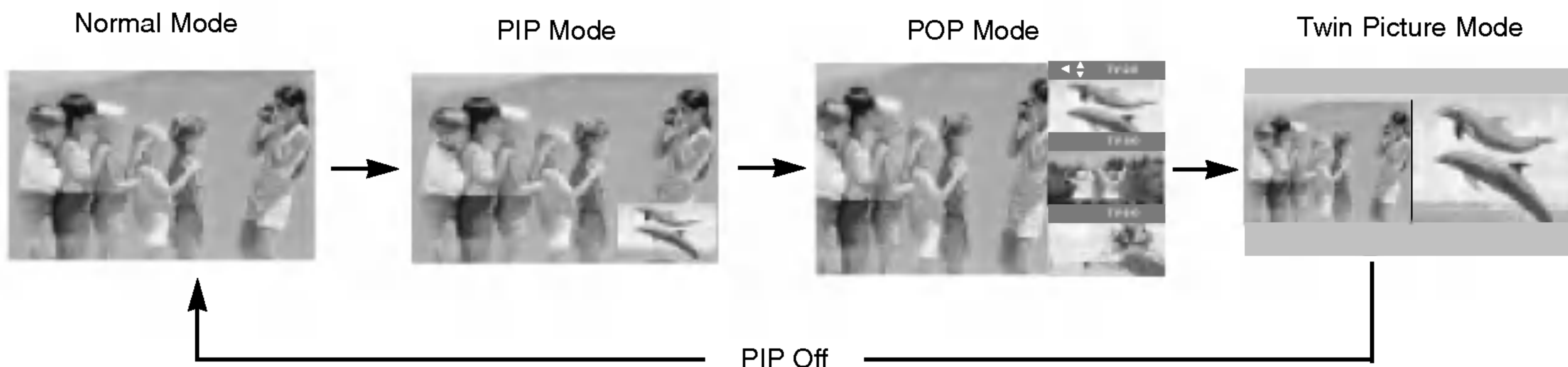

Selecting an Input Signal Source for PIP/Twin Picture

Use the **PIP INPUT** button to select the input source for the sub picture. Each press of **PIP INPUT** button changes the PIP source. You can also select sources for the **Sub Input** in the **SETUP** menu.

Main Picture Source	Available Sub Picture Sources
DTV	Analog, Video, and Front Video
Analog	DTV, Analog, Video, and Front Video

Swapping the PIP/Twin Picture

Repeatedly, press the **SWAP** button to switch the main and sub pictures.

- Component 1, Component 2, RGB-PC (or RGB-DTV), HDMI/DVI input sources for the main picture can't be used to swap the main and sub pictures.



TV Program selection for PIP

1. Press the **PIP** button.
2. Select the Antenna or Cable option on the Sub input menu or with the PIP INPUT button. Use the **PIPCH+** / **PIPCH-** button to select a channel for the sub picture. (You can't select DTV for main and sub picture simultaneously).

Moving the PIP sub picture

In PIP mode, press the ▲ / ▼ / ◀ / ▶ button to move the sub picture to a different location on the screen.



Adjusting Main and Sub Picture Sizes for Twin Picture

Use the ▲ / ▼ / ◀ / ▶ button to change main and sub picture sizes in Twin Picture mode.

i.e)



If screen is adjusted to the maximal size, the large screen is filled with entire screen vertically as shown.

POP (Picture-out-of-Picture: Channel Scan)

- Use POP to search the programs of all the memorized channels one-by-one on the 3 PIP screen displays, (while the main picture source remains the current channel). The pictures of all the programmed channels are searched with the 3 POP screens.

- **Notes:**

- Run EZ Scan channel search before using POP mode.
- When Sub pictures are changed from the TV/DTV to CATV/CADTV in POP mode, it may make a noise from the Tuner switch.

1. Press the **PIP** button to activate the POP mode while in PIP mode.

- **Channel selection:** Use ◀ button to enlarge the selected channel being searched on the PIP screen to shift it for viewing on the Main screen.
- **PIP selection:** Use ▲ / ▼ button to select one of 3 PIP screen pictures in POP mode.
- When watching TV on Main picture, TV or DTV on Sub pictures are in channel scanning. However, when watching DTV on Main picture, only TV on Sub picture is in channel scanning.



2. Press the **EXIT** button to cancel POP mode.

APM (Adaptive Picture Mode)

- Allows a viewer to select their preferred picture mode after comparing the four different picture (**Daylight**, **Normal**, **Night Time** and **Custom**) settings.



1. Press the **APM** button at once. As shown below, the screen is divided to 4-split.
Use the **▲ / ▼ / ◀ / ▶** button to navigate 4 EZ Pictures. By pressing the **ENTER** button, you can select the desired mode.



2. Press the **APM** button, again. As shown below, the 4-same screens are displayed.
You can easily compare with 4 modes.
3. Use the **▲ / ▼ / ◀ / ▶** button to navigate 4 EZ Pictures. By pressing the **ENTER** button, you can select the desired mode.

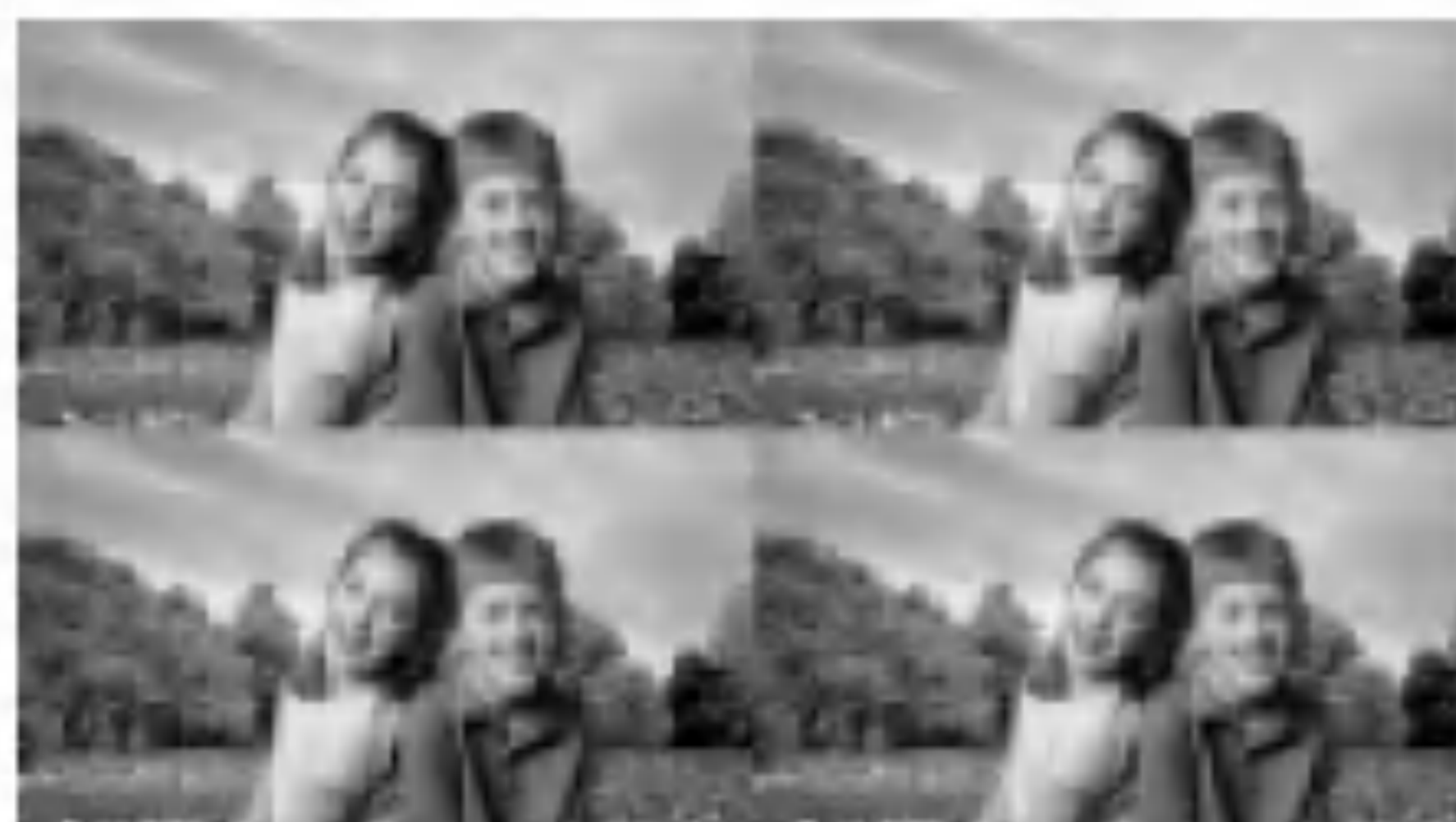

4. Press **EXIT** button to return to TV viewing.





Note: While operating the 4-split, any button except **APM**, **ENTER**, **EXIT**, **VOLUME ▲ / ▼**, **MUTE** button on the remote control are not available.

Brief Info.

- Brief Info shows the present screen information.
- Press the **INFO** button to show the Brief Info on the screen.
- **INFO** button does not work in Component1, Component2, RGB, and HDMI/DVI modes.
- Press the **INFO** button or **EXIT** button to exit.

- Operation:
- Watching TV/DTV/CATV/CADTV
 - Watching Video, Front Video
 - Watching IEEE 1394
 - In Component1, Component2, RGB, HDMI/DVI modes, **INFO** button is not working.

- Function:
- Show the present screen information.
 - On Watching with the upper Input signal, press the **INFO** button.
 - Press the **INFO** button or **EXIT** button to exit.
- A: Banner information
 B: Program title
 C: Day of week, Month, Year
 D: Program start time
 E: Program progress bar
 F: Program finish time
 G: Present time
 H: Additional information. Refer to the icon explanation on the right.

	The original aspect ratio of the video is 4:3
	The original aspect ratio of the video is 16:9(wide)
480i	The video resolution is 720x480i
480p	The video resolution is 720x480p
720p	The video resolution is 1280x720p
1080i	The video resolution is 1920x1080i
	Multilingual : The program contains two or more audio services. Press the SAP button to select wanted Audio.
	Caption: => The program contains one or more caption services. Press the CC button to select wanted Closed caption.
	The program contains V-Chip information. Refer to the <LOCK Menu>. D (Dialogue), L (Language), S (Sex), V (Violence), FV (Fantasy Violence)



EZ Mute

- Nothing to do with Caption on/Off using **Mute** button, the mode selected Caption/Text is to be displayed.
- When you repeatedly press the **Mute** button, the sound mode is changed in turn. (Refer to the picture below)

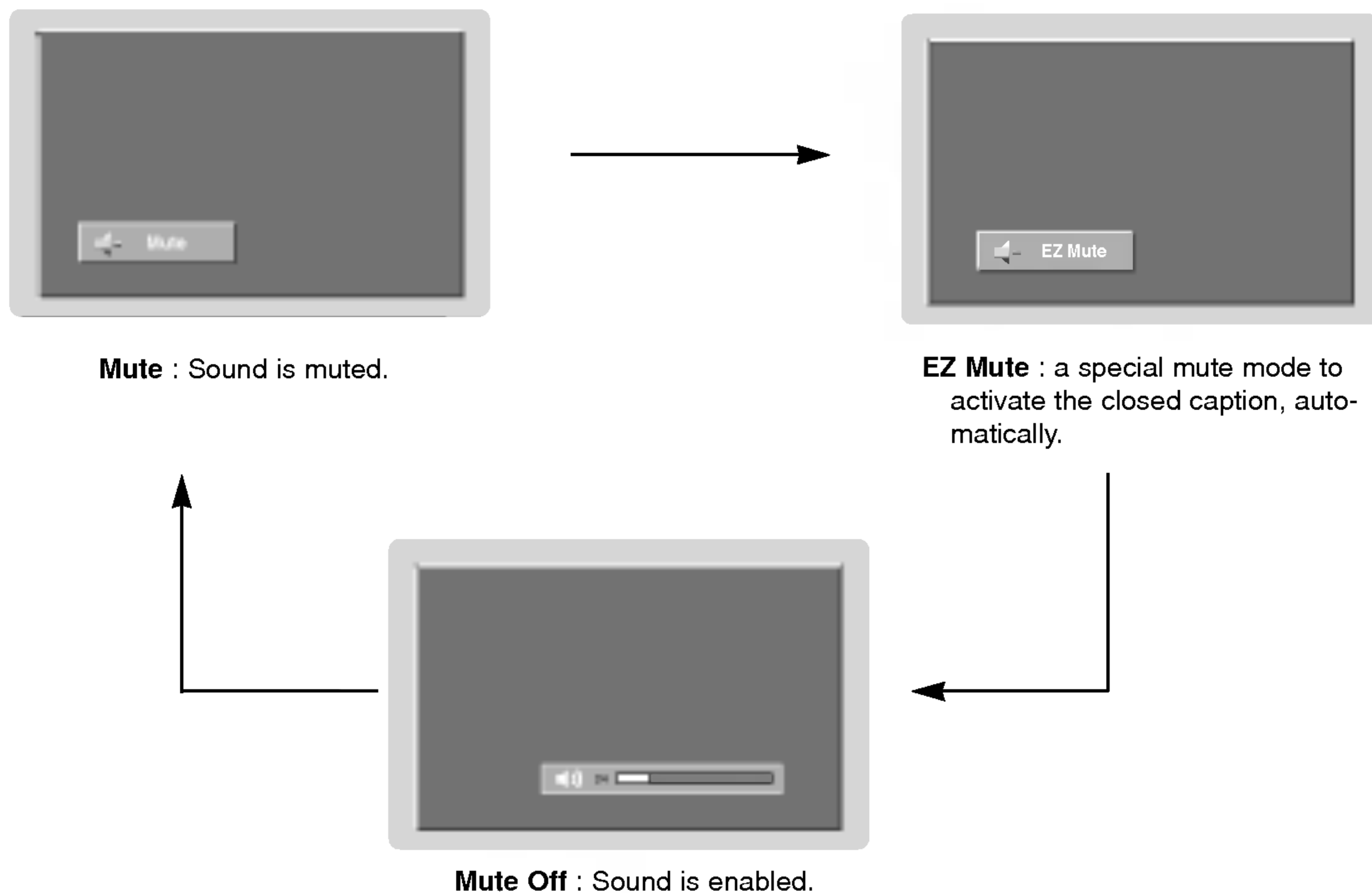

Note:

- EZ Mute does not operate in Component/RGB/HDMI/DVI modes.

Freeze & Magnify (DTV/CADTV 720p, or 1080i mode only)

- Enlarges the picture with correct proportions.
- When enlarging the picture, the image may become distorted.

1. Press the **FREEZE** button in 720p or 1080i mode.
2. Use the **▲ / ▼ / ◀ / ▶** buttons to select the screen section to be magnified.
3. To return to normal viewing, press the **FREEZE** button again.

Note : The Magnify feature is available only in 720p or 1080i mode, but the **FREEZE** button works in all video formats.



Screen Setup for PC mode

Operation

- When RGB connect to PC input and select the RGB-PC in Main Input, this function is used.
- When HDMI/DVI connect to PC input and select HDMI/DVI input, this function is used.
- In RGB-DTV mode, SIZE and PHASE is not available.

Adjustment for screen Position, Size, Phase, Reset

- After connecting RGB-PC or HDMI/DVI to PC input and checking the screen quality.
 - Display PC Adjust Menu using **Adjust** button.
 - Position : Adjust the screen position. After displaying the Adjust, select the screen position.
 - Size : Adjust the screen size.
 - Phase : Adjust the phase of Pixel clock.
In HDMI/DVI-PC mode, PHASE is not available.
 - Reset : Initializing Size, Position, Phase adjustment.

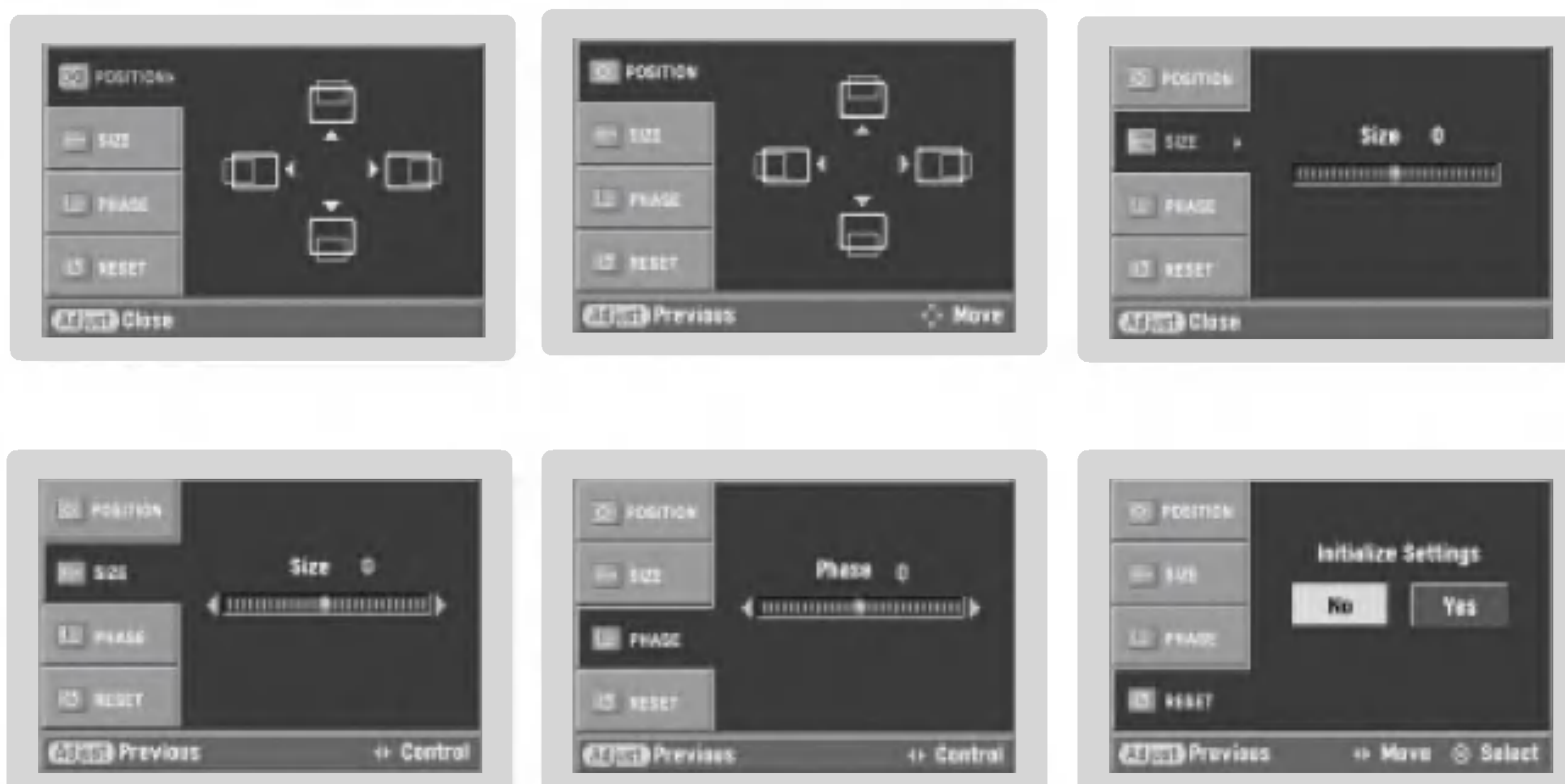

External Control Device Setup

- Connect the RS-232C input jack to an external control device (such as a computer or an A/V control system) and control the TV's functions externally.
- Connect the serial port of the control device to the RS-232C jack on the TV back panel.
- RS-232C connection cables are not supplied with the TV.

RS-232C Setup

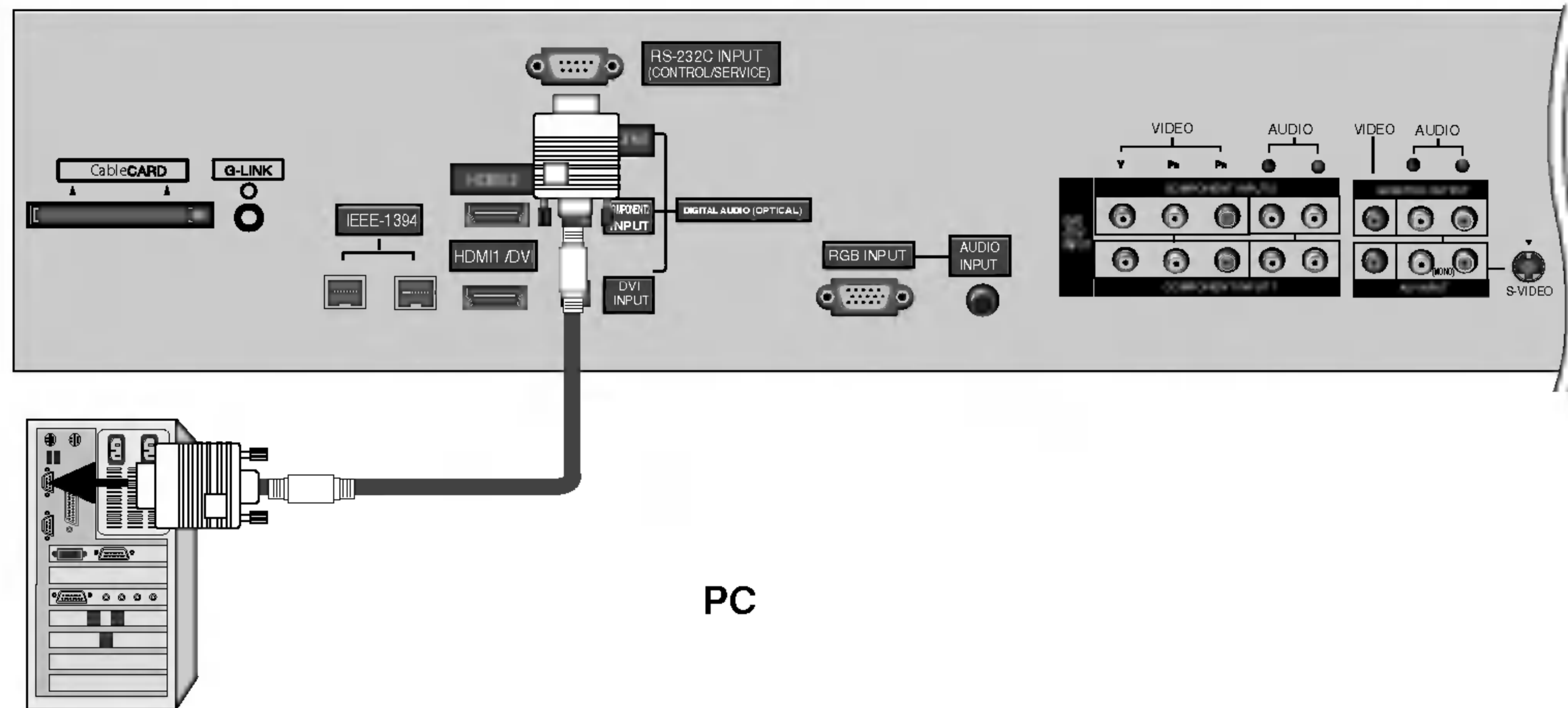

Type of Connector; D-Sub 9-Pin Male

No.	Pin Name
1	No connection
2	RXD (Receive data)
3	TXD (Transmit data)
4	DTR (DTE side ready)
5	GND
6	DSR (DCE side ready)
7	RTS (Ready to send)
8	CTS (Clear to send)
9	No Connection

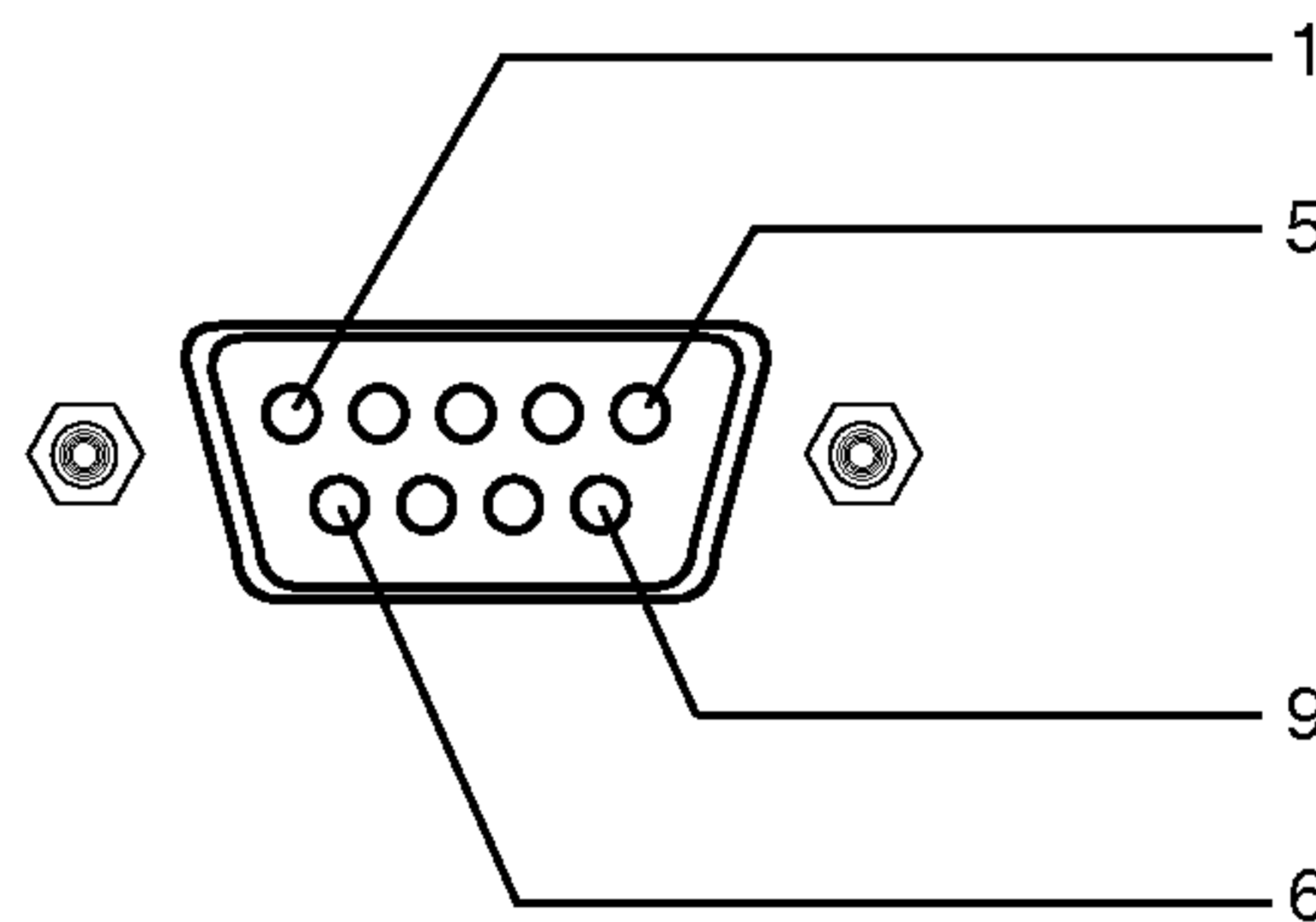

RS-232C Configurations

7-Wire Configurations (Standard RS-232C cable)

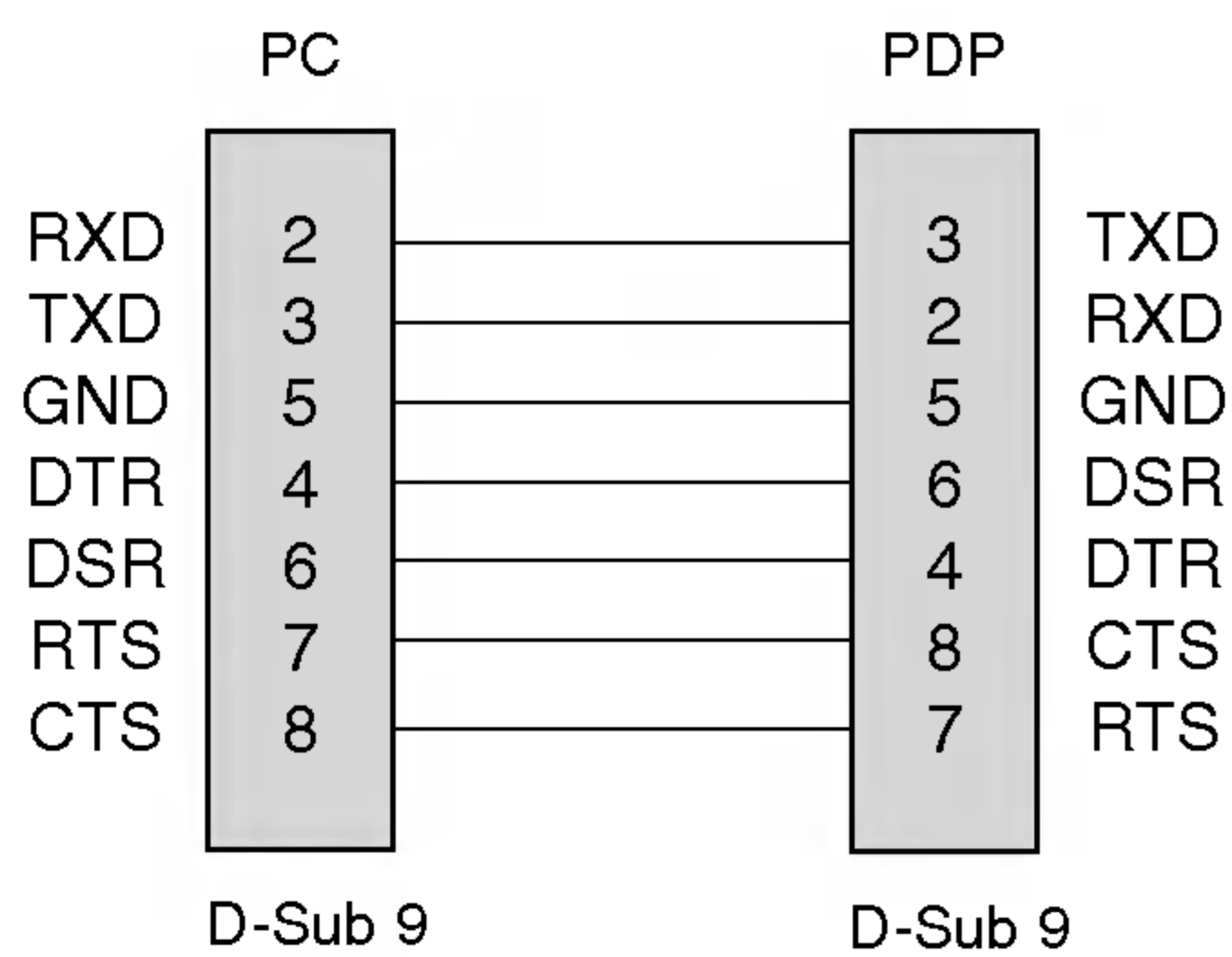

3-Wire Configurations (Not standard)

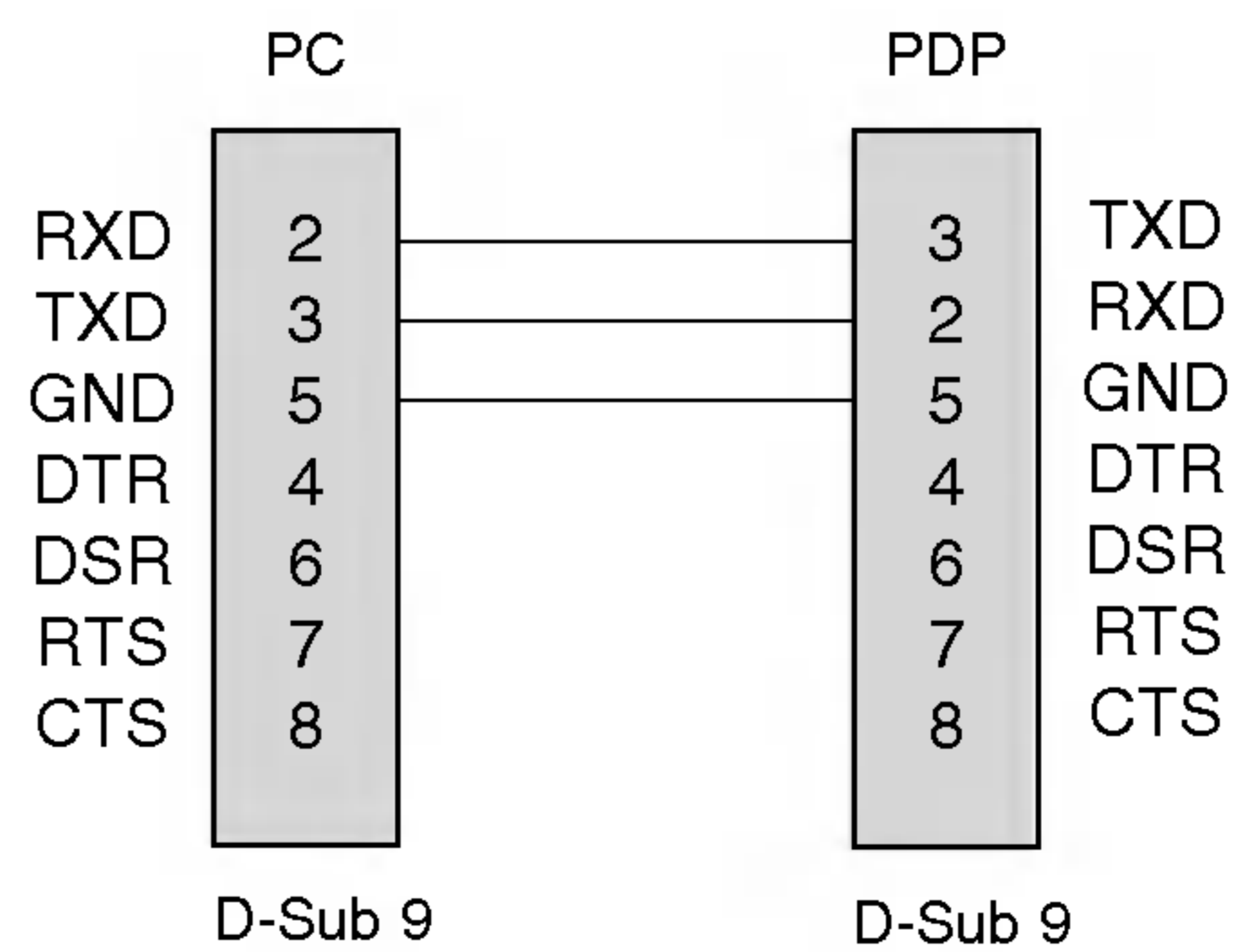

Set ID

Use this function to specify a TV ID number.
Refer to 'Real Data Mapping'. See page 94.

1. Press the **MENU** button and then use **▲** / **▼** button to select the **SETUP** menu.
2. Press the **▶** button and then use **▲** / **▼** button to select **SET ID**.
3. Press the **▶** button and then use **▲** / **▼** button to adjust **SET ID** to choose the desired TV ID number. The adjustment range of **SET ID** is 1 ~ 99.
4. Press **EXIT** button to return to TV viewing or press **MENU** button to return to the previous menu.



Communication Parameters

- Baud rate : 9600 bps (UART)
- Data length : 8 bits
- Parity : None
- Stop bit : 1 bit
- Communication code : ASCII code

* Use a crossed (reverse) cable.

Transmission / Receiving Protocol

Transmission

[Command1][Command2][][Set ID][][Data][Cr]

- * [Command 1]: First command to control the set. (j or k)
- * [Command 2]: Second command to control the set.
- * [Set ID]: You can adjust the set ID to choose desired TV ID number in Setup menu. Adjustment range is 1 ~ 99. When selecting Set ID '0', every connected the TV is controlled. Set ID is indicated as decimal (1~99) on menu and as Hexa decimal (0x0~0x63) on transmission/receiving protocol.
- * [DATA]: To transmit command data.
Transmit 'FF' data to read status of command.
- * [Cr]: Carriage Return
ASCII code '0x0D'
- * []: ASCII code 'space (0x20)'

OK Acknowledgement

[Command2][][Set ID][][OK][Data][x]

- * The TVr transmits ACK (acknowledgement) based on this format when receiving normal data. At this time, if the data is data read mode, it indicates present status data. If the data is data write mode, it returns the data of the PC computer.

Error Acknowledgement

[Command2][][Set ID][][NG][Data][x]

- * The TV transmits ACK (acknowledgement) based on this format when receiving abnormal data from non-viable functions or communication errors.

- Data 1: Illegal Code
2: Not supported function
3: Wait more time

Command Reference List

	COMMAND 1	COMMAND 2	DATA (Hexadecimal)
01. Power	k	a	0 ~ 1
02. Input Select	k	b	0 ~ 9
03. Aspect Ratio	k	c	*
04. Screen Mute	k	d	0 ~ 1
05. Volume Mute	k	e	0 ~ 2
06. Volume Control	k	f	0 ~ 64
07. Contrast	k	g	0 ~ 64
08. Brightness	k	h	0 ~ 64
09. Color	k	i	0 ~ 64
10. Tint	k	j	0 ~ 64
11. Sharpness	k	k	0 ~ 64
12. OSD Select	k	l	0 ~ 1
13. Remote Control Lock Mode	k	m	0 ~ 1
14. PIP/POP/Twin	k	n	0,1,2,5
15. PIP Position	k	q	0 ~ 3
16. Treble	k	r	0 ~ 64
17. Bass	k	s	0 ~ 64
18. Balance	k	t	0 ~ 64
19. Color Temperature	k	u	0 ~ 2
20. PIP Input Source	k	y	0 ~ 3
21. ISM Method	j	p	1,2,4,8
22. Low Power	j	q	*
23. Orbiter Time Setting	j	r	1 ~ FE
24. Orbiter Pixel Setting	j	s	1 ~ 3

	COM- MAND 1	COM- MAND 2	DATA 0 (Hexadecimal)	DATA 1 (Hexadecimal)	DATA 2 (Hexadecimal)	DATA 3 (Hexadecimal)	DATA 4 (Hexadecimal)	DATA 5 (Hexadecimal)
25. Channel Tuning	m	a	01 ~ 87	01 ~ 87	00 ~ FE	00 ~ FF	00 ~ FF	00 ~ FF
26. Channel Add/Del	m	b	00 ~ 01					
27. Key	m	c	*					
28. Input Select	x	b	*					
29. PIP Input Select	x	y	*					

01. Power (Command2:a)

- ▶ To control Power On/Off of the TV.

Transmission

```
[k][a][ ][Set ID][ ][Data][Cr]
```

Data 0 : Power Off 1 : Power On

Acknowledgement

```
[a][ ][Set ID][ ][OK][Data][x]
```

* In a like manner, if other functions transmit 'FF' data based on this format, Acknowledgement data feedback presents status about each function.

02. Input Select (Command2:b) (Main Picture Input)

- ▶ To select input source for the TV.

Transmission

```
[k][b][ ][Set ID][ ][Data][Cr]
```

Data 0: DTV	5: Component 2
1: Analog	6: RGB-DTV
2: Video	7: RGB-PC
3: Front Video	8: HDMI1/DVI
4: Component 1	9: HDMI2

Acknowledgement

```
[b][ ][Set ID][ ][OK][Data][x]
```

03. Aspect Ratio (Command2:c) (Main picture format)

- ▶ To adjust the screen format.
You can also adjust the screen format using the RATIO button on remote control or in the Option menu.

Transmission

```
[k][c][ ][Set ID][ ][Data][Cr]
```

Date 1: 4:3	6: Set by program
2: 16:9	10: Cinema Zoom (1)
3: Horizon	⋮
4: Zoom 1	⋮
5: Zoom 2	1F: Cinema Zoom (16)

Acknowledgement

```
[c][ ][Set ID][ ][OK][Data][x]
```

04. Screen Mute (Command2:d)

- ▶ To select screen mute on/off.

Transmission

```
[k][d][ ][Set ID][ ][Data][Cr]
```

Data 0 : Screen mute off (Picture on)
1 : Screen mute on (Picture off)Acknowledgement

```
[d][ ][Set ID][ ][OK][Data][x]
```

05. Volume Mute (Command2:e)

- ▶ To control volume mute on/off.
You can also adjust mute using the MUTE button on remote control.

Transmission

```
[k][e][ ][Set ID][ ][Data][Cr]
```

Data 0 : Volume mute off (Volume on)
1 : Volume mute on (Volume off)
2 : Volume mute on, Caption onAcknowledgement

```
[e][ ][Set ID][ ][OK][Data][x]
```

06. Volume Control (Command2:f)

- ▶ To adjust volume.
You can also adjust volume with the volume buttons on remote control.

Transmission

```
[k][f][ ][Set ID][ ][Data][Cr]
```

Data Min : 0 ~ Max : 64

- Refer to 'Real data mapping' as shown below.

Acknowledgement

```
[f][ ][Set ID][ ][OK][Data][x]
```

07. Contrast (Command2:g)

- ▶ To adjust screen contrast.
You can also adjust contrast in the Video menu.

Transmission

```
[k][g][ ][Set ID][ ][Data][Cr]
```

Data Min : 0 ~ Max : 64

- Refer to 'Real data mapping' as shown below.

Acknowledgement

```
[g][ ][Set ID][ ][OK][Data][x]
```

08. Brightness (Command2:h)

- ▶ To adjust screen brightness.
You can also adjust brightness in the Video menu.

Transmission

```
[k][h][ ][Set ID][ ][Data][Cr]
```

Data Min : 0 ~ Max : 64

- Refer to 'Real data mapping' as shown below.

Acknowledgement

```
[h][ ][Set ID][ ][OK][Data][x]
```

* **Real data mapping**

0	: Step 0 (SET ID ALL)
1	: Step 1 (SET ID 1)
⋮	
A	: Step 10 (SET ID 10)
⋮	
F	: Step 15 (SET ID 15)
10	: Step 16 (SET ID 16)
⋮	
63	: Step 99 (SET ID 99)
64	: Step 100

09. Color (Command2:i)

- ▶ To adjust the screen color.
You can also adjust color in the Video menu.

Transmission

```
[k][i][ ][Set ID][ ][Data][Cr]
```

Data Min : 0 ~ Max : 64

- Refer to 'Real data mapping'. See page 94.

Acknowledgement

```
[i][ ][Set ID][ ][OK][Data][x]
```

10. Tint (Command2:j)

- ▶ To adjust the screen tint.
You can also adjust tint in the Video menu.

Transmission

```
[k][j][ ][Set ID][ ][Data][Cr]
```

Data Red : 0 ~ Green : 64

- Refer to 'Real data mapping'. See page 94.

Acknowledgement

```
[ j ][ ][Set ID][ ][OK][Data][x]
```

11. Sharpness (Command2:k)

- ▶ To adjust the screen sharpness.
You can also adjust sharpness in the Video menu.

Transmission

```
[k][k][ ][Set ID][ ][Data][Cr]
```

Data Min: 0 ~ Max: 64

- Refer to 'Real data mapping'. See page 94.

Acknowledgement

```
[k][ ][Set ID][ ][OK][Data][x]
```

12. OSD Select (Command2:l)

- ▶ To select OSD (On Screen Display) on/off.

Transmission

```
[k][l][ ][Set ID][ ][Data][Cr]
```

Data 0: OSD off 1: OSD on

Acknowledgement

```
[l][ ][Set ID][ ][OK][Data][x]
```

13. Remote Control Lock Mode (Command2:m)

- ▶ To lock the remote control and the front panel controls on the set.

Transmission

```
[k][m][ ][Set ID][ ][Data][Cr]
```

Data 0: Lock off 1: Lock on

Acknowledgement

```
[m][ ][Set ID][ ][OK][Data][x]
```

14. PIP / POP / Twin Picture (Command2:n)

- ▶ To control the PIP (Picture-in-Picture)/POP/Twin picture.
You can also control the PIP/POP/Twin picture using the PIP button on the remote control.

Transmission

```
[k][n][ ][Set ID][ ][Data][Cr]
```

Data 0: PIP off 2: Twin Picture
1: PIP 5: POPAcknowledgement

```
[n][ ][Set ID][ ][OK][Data][x]
```

15. PIP Position (Command2:q)

- ▶ To select sub picture position for PIP.

Transmission

```
[k][q][ ][Set ID][ ][Data][Cr]
```

Data 0: Right down on screen
1: Left down on screen
2: Left up on screen
3: Right up on screenAcknowledgement

```
[q][ ][Set ID][ ][OK][Data][x]
```

16. Treble (Command2:r)

- ▶ To adjust treble.
You can also adjust treble in the Audio menu.

Transmission

```
[k][r][ ][Set ID][ ][Data][Cr]
```

Data Min: 0 ~ Max: 64

- Refer to 'Real data mapping'. See page 94.

Acknowledgement

```
[r][ ][Set ID][ ][OK][Data][x]
```

17. Bass (Command2:s)

- ▶ To adjust bass.
You can also adjust bass in the Audio menu.

Transmission

```
[k][s][ ][Set ID][ ][Data][Cr]
```

Data Min: 0 ~ Max: 64

- Refer to 'Real data mapping'. See page 94.

Acknowledgement

```
[s][ ][Set ID][ ][OK][Data][x]
```

18. Balance (Command2:t)

- ▶ To adjust balance.
You can also adjust balance in the Audio menu.

Transmission

```
[k][t][ ][Set ID][ ][Data][Cr]
```

Data Min: 0 ~ Max: 64

- Refer to 'Real data mapping'. See page 94.

Acknowledgement

```
[t][ ][Set ID][ ][OK][Data][x]
```

19. Color Temperature (Command2:u)

► To adjust color temperature.
You can also adjust color temperature in the Video menu.

Transmission

```
[k][u][ ][Set ID][ ][Data][Cr]
```

Data 0: Medium 1: Cool 2: Warm

Acknowledgement

```
[u][ ][Set ID][ ][OK][Data][x]
```

20. PIP Input Select (Command2:y)

► To select input source for sub picture in PIP/Twin picture mode.

Transmission

```
[k][y][ ][Set ID][ ][Data][Cr]
```

Data 0: DTV
1: Analog
2: Video
3: Front Video

Acknowledgement

```
[y][ ][Set ID][ ][OK][Data][x]
```

21. ISM Method (Command2:p)

► To avoid having a fixed image remain on screen.

Transmission

```
[j][p][ ][Set ID][ ][Data][Cr]
```

Data 1: Inversion
2: Orbiter
4: White Wash
8: Normal

Acknowledgement

```
[p][ ][Set ID][ ][OK][Data][x]
```

22. Low Power (Command2:q)

► To control the Low Power function on/off.
You can also adjust Low Power in Option menu.

Transmission

```
[j][q][ ][Set ID][ ][Data][Cr]
```

Data 0: Low Power off
1: Low Power on

Acknowledgement

```
[q][ ][Set ID][ ][OK][Data][x]
```

23. Orbiter Time Setting (Command2:r)

► To adjust orbiter operation time term.

Transmission

```
[j][r][ ][Set ID][ ][Data][Cr]
```

Data Min: 1 ~ Max: FE

Acknowledgement

```
[r][ ][Set ID][ ][OK][Data][x]
```

24. Orbiter Pixel Setting (Command2:s)

► To adjust pixel number in orbiter function.

Transmission

```
[j][s][ ][Set ID][ ][Data][Cr]
```

Data Min: 1 ~ Max: 3

Acknowledgement

```
[s][ ][Set ID][ ][OK][Data][x]
```

25. Tune Command (Command: m a)

► To tune channel to following physical/major/minor number

Transmission

```
[m][a][ ][Set ID][ ][Data0][ ][Data1][ ][Data2][ ][Data3][ ][Data4][ ][Data5][Cr]
```

Data 0: Physical Channel Number(Transmit by Hexadecimal code)
NTSC air:02~45
NTSC cable: 01, 0E~7D
ATSC air:01~45
ATSC cable:01~87

Data1,Data2: Major Channel Number (two part)/ Channel Number (One part)

Data1: High byte

Data2: Low byte

Two part channel number: Major number-Minor number

One part channel number: If the channel band is ATSC digital cable, it can be used. In case of using one part channel number, minor channel does not need.

Data3, Data 4: Minor Channel Number Data3: High byte Data4: Low byte

Data 5:

7	Main/Sub Picture	6	Two/One Part Channel	5	Using Physical Channel	4 Reserved	3	2	1	0	Step
0	Main	0	Two	0	Use	x	0	0	0	0	NTSC Air
1	Sub	1	One	1	No Use	x	0	0	0	1	NTSC Cable
						x	0	0	1	0	ATSC Air
						x	0	0	1	1	ATSC Cable_std
						x	0	1	0	0	ATSC Cable_hrc
						x	0	1	0	1	ATSC Cable_irc
						x	0	1	1	0	ATSC cable_auto
						x	0	1	1	1	Reserved
						x	x	x	x	x	...
						x	1	1	1	1	Reserved

* All data are transmitted by Hexadecimal code

*Two/One part Channel: 6th bit

This bit is used in a cable-ready system.

*Using physical channel: 5th bit

If the channel band is NTSC air or NTSC cable, channel tuning can be done by only physical channel. In this case, using physical channel bit must be low(0).

But if the channel band is ATSC air or ATSC cable, there are two cases that physical channel enable or disable.

If the physical channel sending is meaningful, you should set this bit low(0). If the physical channel sending is meaningless, you should set this bit high(1).

Example)

1. Analog channel: NTSC cable, channel number(35), main picture Command: ma 00 23 xx xx xx xx 01 attribute(0x01): main picture, two part(it's not mandatory), using physical channel, NTSC cable 'xx' data: don't care major and minor channel number in case analog channel tuning.

2. Digital channel: ATSC air, channel number(don't know physical channel, major(30), minor(3)), sub picture Command: ma 00 xx 00 1E 00 03 A2 attribute(0xA2): sub picture, two part, not using physical channel, ATSC air 'xx' data: don't care analog channel number in case digital channel tuning.

3. Digital channel: ATSC air, channel number(physical(20),major(20), minor(3)), sub picture Command: ma 00 14 00 14 00 03 82 attribute(0x82): sub picture, two part, using physical channel, ATSC air.

Acknowledgement

[a][][Set ID][][OK][Data0][Data1][Data2][Data3][Data4][Data5][x]
[a][][Set ID][][NG][Data0][x]

26. Channel Add/Del (Command: m b)

► To add and delete the channels

Transmission

[m][b][][Set ID][][Data][Cr]

Data 0: Channel Delete
1: Channel Add

Acknowledgement

[b][][Set ID][][OK][Data][x]
[b][][Set ID][][NG][Data][x]

27. Key (Command: m c)

► To send IR remote key code

Transmission

[m][c][][Set ID][][Data][][Cr]

Data Key code: Refer to page 99.

Acknowledgement

[c][][Set ID][][OK][Data][x]

28. Input select(Command: x b) (Main Picture Input)

► To select input source for TV.

Transmission

[x][b][][Set ID][][Data][Cr]

Data Structure

DATA(Hex)	INPUT
00	DTV (Antenna)
01	DTV (Cable)
10	Analog (Antenna)
11	Analog (Cable)
20	Video
21	Front Video
40	Component 1
41	Component 2
50	RGB DTV
60	RGB PC
90	HDMI1/DVI
91	HDMI2

Acknowledgement

[b][][Set ID][][OK/NG][Data][x]

29. PIP Input Select(Command: x y)

► To adjust input source for sub picture in PIP mode

Transmission

[x][y][][Set ID][][Data][Cr]

Data Structure

DATA(Hex)	INPUT
00	DTV (Antenna)
01	DTV (Cable)
10	Analog (Antenna)
11	Analog (Cable)
20	Video
21	Front Video

Acknowledgement

[y][][Set ID][][OK/NG][Data][x]

IR Codes

How to Connect

- ▶ Connect your wired remote control to the Remote Control port on the TV.

Remote Control IR Codes

▶ Output waveform

Single pulse, modulated with 37.917KHz signal at 455KHz

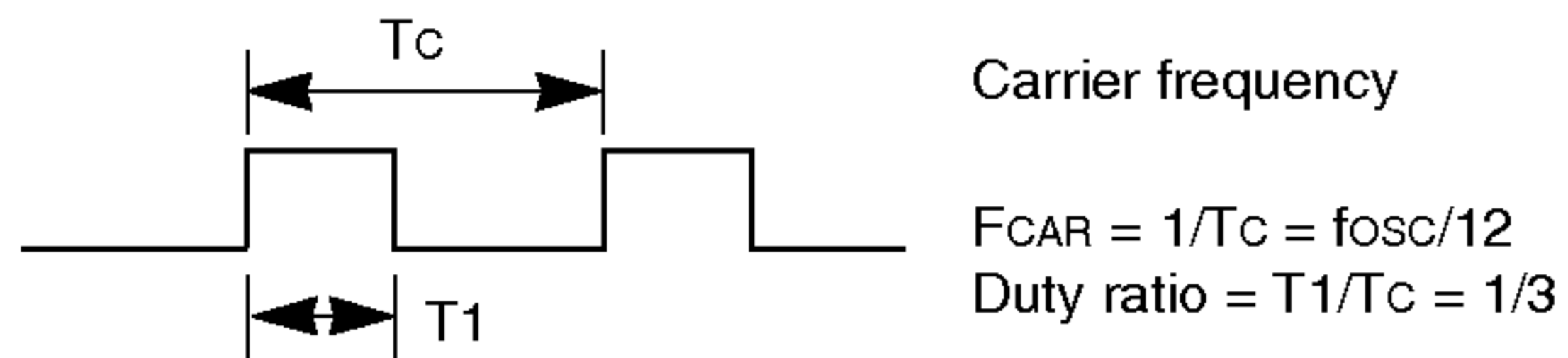

▶ Configuration of frame

- 1st frame

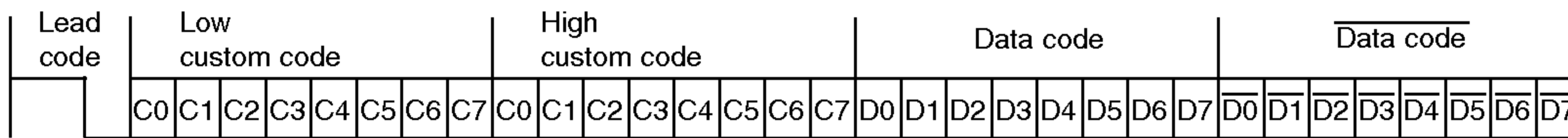

- Repeat frame

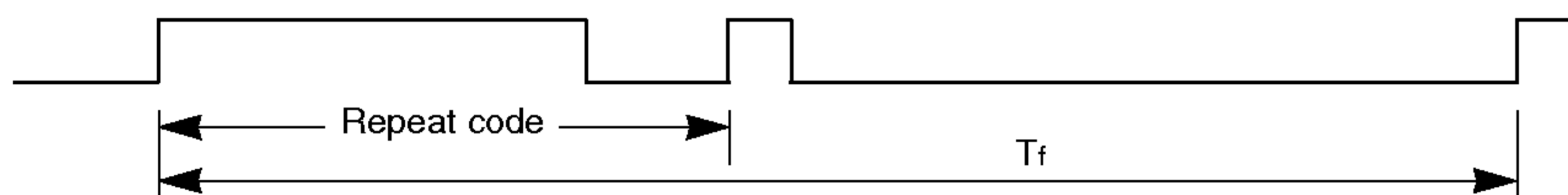

▶ Lead code

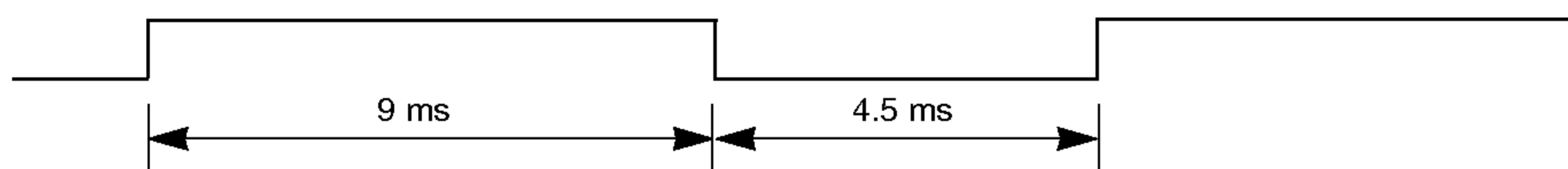

▶ Repeat code

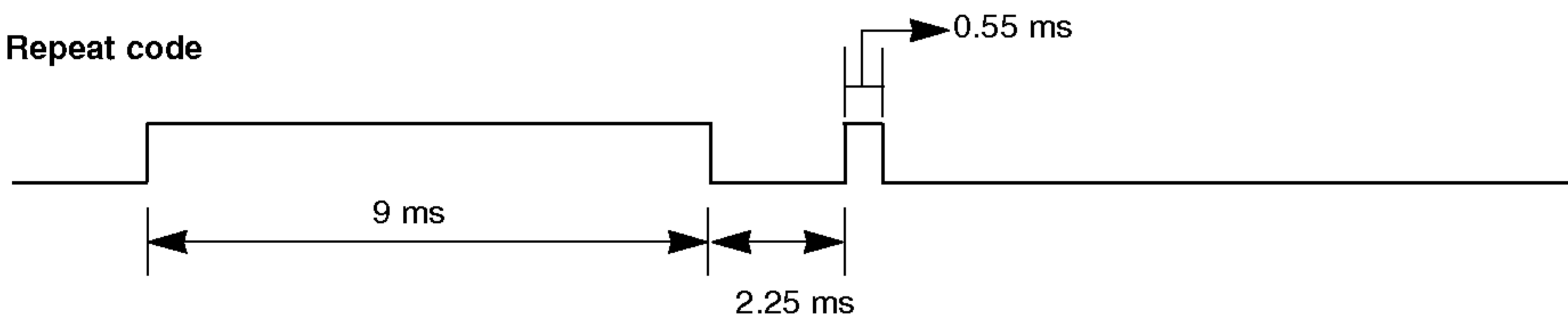

▶ Bit description

- Bit "0"

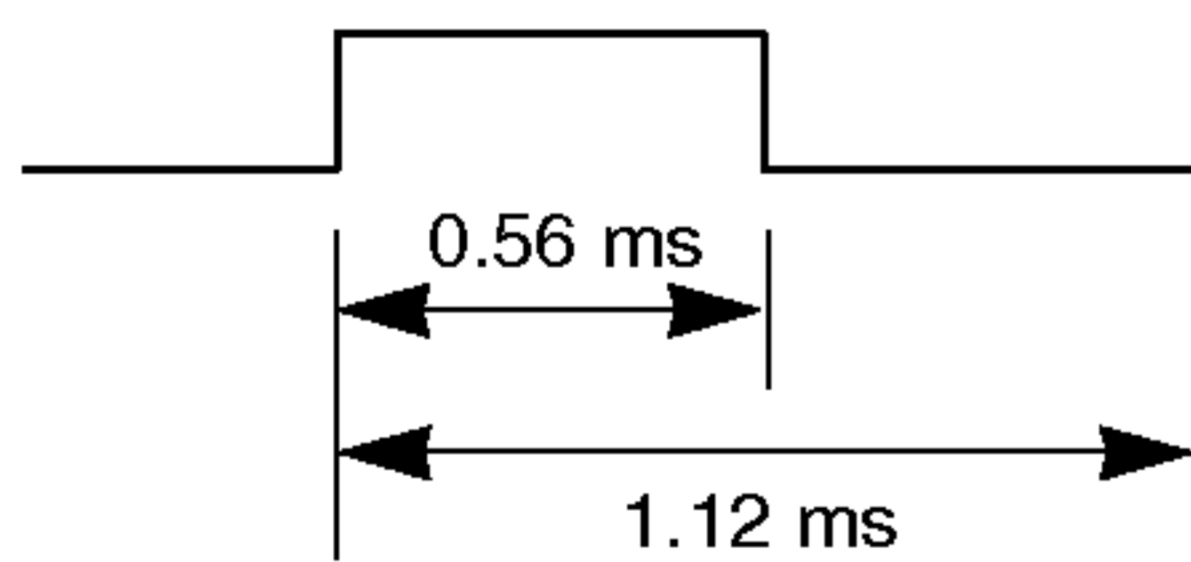

- Bit "1"

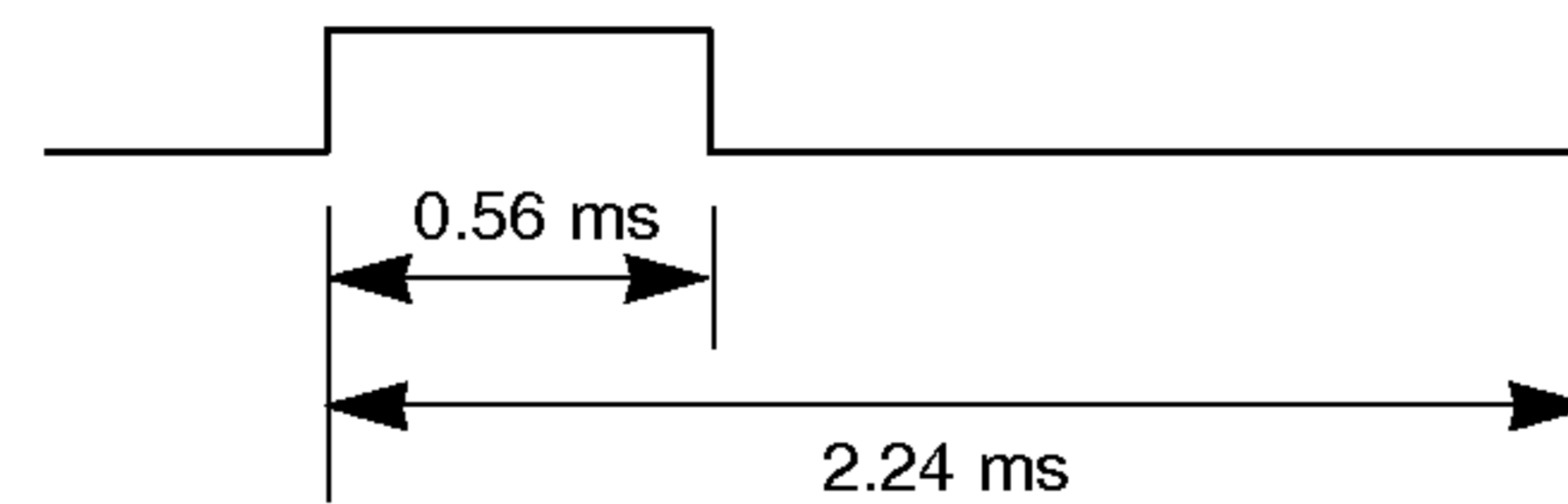

▶ Frame interval : Tf

The waveform is transmitted as long as a key is depressed.

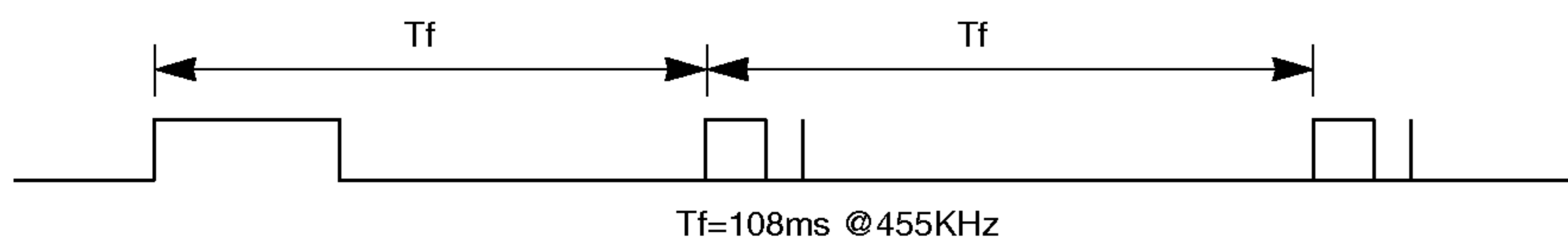

Code (Hexa)	Function	Note
0F	TV INPUT	R/C Button
0B	TV/VIDEO	R/C Button
08	POWER	R/C Button (Power On/Off)
C4	POWER ON	Discrete IR Code (Only Power On)
C5	POWER OFF	Discrete IR Code (Only Power Off)
79	RATIO	R/C Button
0E	TIMER	R/C Button
10 ~ 19	Number Key 0~ 9	R/C Button
4C	- (Dash)	R/C Button
1A	FLASHBK	R/C Button
09	MUTE	R/C Button
02	VOL ▲	R/C Button
03	VOL ▼	R/C Button
00	CH ▲	R/C Button
01	CH ▼	R/C Button
1E	FAV	R/C Button
AA	INFO	R/C Button
39	CC	R/C Button
40	▲	R/C Button
41	▼	R/C Button
07	◀	R/C Button
06	▶	R/C Button
44	ENTER	R/C Button
43	MENU	R/C Button
52	EZ SOUND	R/C Button
4D	EZ PIC	R/C Button
5B	EXIT	R/C Button
60	PIP	R/C Button
72	PIPCH -	R/C Button
71	PIPCH +	R/C Button
61	PIP INPUT	R/C Button
63	SWAP	R/C Button
65	FREEZE	R/C Button
0A	SAP	R/C Button
CB	ADJUST	R/C Button
D6	TV	Discrete IR Code (TV Input Selection)
5A	VIDEO	Discrete IR Code (Video Input Selection)
D0	Front Video	Discrete IR Code (Front Video Input Selection)
BF	COMPONENT 1	Discrete IR Code (Component1 Input Selection)
D4	COMPONENT 2	Discrete IR Code (Component2 Input Selection)
D5	RGB-PC	Discrete IR Code (RGB-PC Input Selection)
D7	RGB-DTV	Discrete IR Code (RGB-DTV Input Selection)
C6	HDMI1/DVI	Discrete IR Code (HDMI/DVI Input Selection)
CC	HDMI2	Discrete IR Code (HDMI2 Input Selection)
76	Ratio 4:3	Discrete IR Code(Only 4:3 Mode)
77	Ratio 16:9	Discrete IR Code (Only 16:9 Mode)
AF	Ratio Zoom	Discrete IR Code (Only Zoom1 Mode)
70	POP	Discrete IR Code (Channel Search)
87	1394	R/C Button
B0	PLAY	R/C Button
BA	PAUSE	R/C Button
B1	STOP	R/C Button
BD	REC	R/C Button
8F	REW	R/C Button
8E	FF	R/C Button
B2	GOTOPREV	R/C Button
B3	GOTONEXT	R/C Button
A9	TV GUIDE	R/C Button
92	APM	R/C Button
CA	MC EJECT	R/C Button
80	AUTO DEMO	R/C Button
C8	X STUDIO	R/C Button
7D	MARK	R/C Button

Programming the Remote

- ▶ The remote is a multi-brand or a universal remote. It can be programmed to operate most remote-controllable devices of other manufacturers.
Note that the remote may not control all models of other brands.

Programming a code into a remote mode

1. To find out whether your remote can operate the device without programming, turn on the device such as a VCR and press the corresponding mode button on the remote.
After that, press the **POWER** button. If the device is turned off then it responds properly and the remote need not to be programmed. If not, the remote should be programmed to operate the device. The programming procedures are explained below.
2. Press the **MENU** and **MUTE** button continuously at the same time for 2 seconds, the current selected device button will be illuminated.
If you don't press any button for 20 seconds, the light on the mode button will be turned off. In that case, you have to repeat from step 2.
3. Enter code numbers using the number button on the remote by referring the code table on the following pages. When pressing the button, the light blinks at a time. If the device turned off, the programming is successful.
4. Press the **MENU** button to store the code. After blinking twice, this code is stored.
5. Test the remote functions to see if the device responds properly. If not, repeat from step 2.

Programming Codes

VCRs

Brand	Codes	Brand	Codes	Brand	Codes	Brand	Codes
AIWA	034	KENWOOD	014 034 039 043	PORTLAND	108	TATUNG	039 043
AKAI	016 043 046 124 125 146		047 048	PULSAR	072	TEAC	034 039 043
AMPRO	072	LG (GOLDSTAR)	001 012 013 020	QUARTZ	011 014	TECHNICS	031 033 070
ANAM	031 033 103	LLOYD	034	QUASAR	033 066 075 145	TEKNIKA	019 031 033 034 101
AUDIO DYNAMICS	012 023 039 043	LXI	003 009 013 014	RCA	013 020 033 034	THOMAS	034
BROKSONIC	035 037 129	MAGIN	040		040 041 062 063	TMK	006
CANON	028 031 033	MAGNAVOX	031 033 034 041	REALISTIC	107 109 140 144 145 147	TOSHIBA	008 013 042 047 059 082 112 131
CAPEHART	108	MARANTZ	067 068		003 008 010 014	TOTEVISION	040 101
CRAIG	003 040 135		012 031 033 067	RICO	053 054 101	UNITECH	040
CURTIS MATHES	031 033 041	MARTA	069	RUNCO	058	VECTOR RESEARCH	012
DAEWOO	005 007 010 064 065 108 110 111 112 116 117 119	MATSUI	101	SALORA	148	VICTOR	048
DAYTRON	108	MEI	027 030	SAMSUNG	014	VIDEO CONCEPTS	012 034 046
DBX	012 023 039 043	MEMOREX	031 033		032 040 102 104	VIDEOSONIC	040
DYNATECH	034 053		003 010 014 031		105 107 109 112	WARDS	003 013 017 024 031 033 034 040 053 054 131
ELECTROHOME	059		033 034 053 072	SANSUI	113 115 120 122		
EMERSON	006 017 025 027 029 031 034 035 036 037 046 101 129 131 138 153	MGA	101 102 134 139	SANYO	125	YAMAHA	012 034 039 043
FISHER	003 008 009 010	MINOLTA	045 046 059		022 043 048 135	ZENITH	034 048 056 058 072 080 101
FUNAI	034	MITSUBISHI	013 020 045 046 049 051 059 061 151	SCOTT	102 134		
GE	031 033 063 072 107 109 144 147	MTC	034 040	SEARS	017 037 112 129 131		
GO VIDEO	132 136	MULTITECH	024 034		003 008 009 010		
HARMAN KARDON	012 045	NEC	012 023 039 043 048	SHARP	013 014 017 020		
HITACHI	004 018 026 034 043 063 137 150	NORDMENDE	043	SHINTOM	031 042 073 081 101		
INSTANTREPLAY	031 033	OPTONICA	053 054	SONY	031 054 149		
JCL	031 033	PANASONIC	066 070 074 083 133 140 145		003 009 031 052 056 057 058 076 077 078 149		
JCPENNY	012 013 015 033 040 066 101	PENTAX	013 020 031 033 063	SOUNDESIGN	034		
JENSEN	043	PHILCO	031 034 067	STS	013		
JVC	012 031 033 043 048 050 055 060 130 150 152	PHILIPS	031 033 034 054 067 071 101	SYLVANIA	031 033 034 059 067		
		PILOT	101	SYMPHONIC	034		
		PIONEER	013 021 048	TANDY	010 034		

CATV

Brand	Codes	Brand	Codes	Brand	Codes	Brand	Codes
ABC	003 004 039 042 046 052 053	GOLDEN CHANNEL	030		065 085 090	SPRUCER	047 078
AJIN	112	HAMLIN	049 050 055	PIONEER	034 051 052 063 076	STARCOM	002 004 008 009
ANTRONIK	014	HITACHI	052 055	POST NEWS WEEK	016	STARGATE	008 030
ARCHER	005 007 014 024	HOSPITALITY	070 077	PRUCER	059	TADIRAN	030
CABLE STAR	026	JERROLD	002 003 004 008 009 010 052 069 074	PTS	011 048 071 072 073 074	TAEKWANG	110
CENTURION	092			PULSAR	100	TAIHAN	105
CENTURY	007	LG (GOLDSTAR)	001 106 101 005	RCA	047	TANDY	017
CITIZEN	007	M-NET	037	REGAL	049 050	TEXSCAN	029
COLOUR VOICE	065 090	MACOM	033	REGENCY	057	TOCOM	039 040 056
COMBANO	080 081	MAGNAVOX	010 012 064 079	REMBRANT	025	TOSHIBA	100
COMTRONICS	019 030	MEMOREX	100	SAMSUNG	102 107 030 068	UNIKA	007 014 024
DIAMOND	023	MOVIE TIME	028 032	SCIENTIFIC ATLANTA	003 011 041 042 043 045 046	UNITED CABLE	004 053
EAGLE	020 030 040	NSC	015 028 038 071 073	SHERITECH	022	UNIVERSAL	005 007 014 024 026 027 032 035
EASTERN	057 062 066	OAK	016 031 037 053	SIGNAL	030	VIEWSTAR	012 015 018 086 087 088 089
ELECTRICORD	032	PANASONIC	044 047	SIGNATURE	052	ZENITH	100 114 060 093
GE	072	PARAGON	100	SL MARX	030		
GEMINI	008 022 025 054	PHILIPS	006 012 013 020				
GI	052 074						

HDSTB

Brand	Codes	Brand	Codes	Brand	Codes	Brand	Codes
ALPHASTAR DSR	123		133 134	PAGE SKY SATELLITE	143		088 090 107 130
AMPLICA	050	GENERAL INSTRUMENT	003 004 016 029	PANASONIC	060 142	TOSHIBA	137
BIRDVIEW	051 126 129		031 059 101	PANSAT	121	UNIDEN	002 127
CHANNEL MASTER	013 014 015 018	HITACHI	139 140	PERSONAL CABLE	117		016 025 042 043
	036 055	HOUSTON TRACKER	033 037 039 051	PHILIPS	071		044 045 048 049
CHAPARRAL	008 009 012 077		057 104	PICO	105		078 079 080 086
CITOH	054	HUGHES	068	PRESIDENT	019 102	VIEWSTAR	101 135 136
CURTIS MATHES	050 145	JANIEL	060 147	PRIMESTAR	030 110 111	WINEGARD	115
DRAKE	005 006 007 010	JERROLD	061	PROSAT	072	ZENITH	128 146
	011 052 112 116	KATHREIN	108	RCA	066 106		081 082 083 084
	141	LEGEND	057	REALISTIC	043 074		091 120
DX ANTENNA	024 046 056 076	LG	001	SAMSUNG	123		
ECHOSTAR	038 040 057 058	LUTRON	132	SATELLITE SERVICE CO	028 035 047 057		
	093 094 095 096	LUXOR	062 144		085		
	097 098 099 100	MACOM	010 059 063 064	SCIENTIFIC ATLANTA	032 138		
	122		065	SONY	103		
ELECTRO HOME	089	MEMOREX	057	STARCAST	041		
EUROPLUS	114	NEXTWAVE	028 124 125	SUPER GUIDE	020 124 125		
FUJITSU	017 021 022 027	NORSAT	069 070	TEECOM	023 026 075 087		

Audio

Brand	Codes	Brand	Codes	Brand	Codes	Brand	Codes
AIWA	014 028 070 096	JVC	004 013 141	PHILIPS	026 112 143		147 218
	125 129 139 229	KEC	185 186 187	PIONEER	039 042 043 063	TOSHIBA	137
	230	KENWOOD	038 050 067 089		065 091 093 094	THE	061
AKAI	163		170 171 197 206		115 123 127 250	VICTOR	088 131
ANAM	003 014 017 023		215 222	QUASAR	113	WARDS	089
	059 106 189 216	KOHEL	030	RCA	080	YAMAHA	054 055 066 092
	217 235 236	NAD	045 046	RCX	092		199
BURMECTER	252	LOTTE	014 016 036 098	REALISTIC	103 106		
CARVER	086		100 172 173 174	SAMSUNG	124 145 146 182		
CLARION	199		175 176 177 178		193 194 195 203		
DAEWOO	027 053 060 084		179 180 181 183		204 244 245 246		
	102 148 198 221		201 202 208 213	SANSUI	011 135 138 144		
DENON	015 075 130 143		214 219 223 232	SANYO	019 083 234		
FANTASIA	071		238 240	SCOTT	106 186		
FINEARTS	022	LXI	103	SHARP	031 032 051 052		
FISHER	089 099	MAGNAVOX	111		072 082 117 119		
LG(GOLDSTAR)	001 021 024 029	MARANTZ	002 018 020 025		156 184 199 200		
	087 107 108 110		034 041 081 090	SHERWOOD	005 006 158		
	190 191 192 210		097 112	SONY	044 045 109 114		
	211 212 239	MCINTOSH	049		118 126 248 249		
HAITAI	034 035 188 222	MCS	104	TAEKWANG	012 020 073 074		
HARMAN/KARDON	068	MEMOREX	107		076 077 105 161		
INKEL	037 058 062 069	NAD	046		162 163 164 165		
	078 079 095 121	ONKYO	013 040 041 047		166 167 168 169		
	122 149 150 151		048 056 057 132		205 231 233 242		
	152 153 154 155		133 140	TEAC	010 085 106 136		
	157 158 159 160	OPTIMUS	158		185 187 237		
	189 207 222 224	PANASONIC	007 033 064 113	TECHNICS	101 113 128 134		
	225 226 227 243		142 220 241 251				
	247	PENNEY	104				

DVD

Brand	Codes	Brand	Codes	Brand	Codes	Brand	Codes
APEX DIGITAL	022	MAGNAVOX	013	PHILIPS	013	SONY	007
DENON	020 014	MARANTZ	024	PIONEER	004 026	THOMPSON	005 006
GE	005 006	MITSUBISHI	002	PROCEED	021	TOSHIBA	019 008
HARMAN KARDON	027	NAD	023	PROSCAN	005 006	YAMAHA	009 018
JVC	012	ONKYO	008 017	RCA	005 006	ZENITH	010 016 025
LG	001 010 016 025	PANASONIC	003 009	SAMSUNG	011 015		

Troubleshooting Checklist

No picture & No sound

- Check whether the TV is turned on.
- Is the power cord inserted into wall power outlet?
- Test the wall power outlet, plug another product's power cord into the outlet where the TV's power cord was plugged in.

Picture OK & No sound

- Press the **VOLUME** (▶) button.
- Sound muted? Press **MUTE** button.

The remote control doesn't work

- Check to see if there is any object between the TV and the remote control causing obstruction.
- Are batteries installed with correct polarity (+ to +, - to -)? (Refer to p.11)
- Correct remote operating mode set: TV, VCR etc.?
- Install new batteries. (Refer to p.11)

Picture appears slowly after switching on

- This is normal, the image is muted during the TV startup process. Please contact your service center, if the picture has not appeared after five minutes.

No or poor color or poor picture

- Select **Color** in the **Video** menu and press the **VOLUME** (▶) button. (Refer to p.65)
- Keep a sufficient distance between the TV and the VCR.
- Activate any function to restore the brightness of the picture. (If still picture is on the screen for more than 5 minutes, the screen gets dark.)

Horizontal/vertical bars or picture shaking

- Check for local interference such as an electrical appliance or power tool.

No output from one of the speakers

- Adjust **Balance** in the **AUDIO** menu. (Refer to p.66)

Unusual sound from inside the TV

- A change in ambient humidity or temperature may result in an unusual noise when the plasma display is turned on or off and does not indicate a fault with the TV.

Maintenance

- Early malfunctions can be prevented. Careful and regular cleaning can extend the amount of time you will have your new TV. Be sure to turn the power off and unplug the power cord before you begin any cleaning.

Cleaning the Screen

1. Here's a great way to keep the dust off your screen for a while. Wet a soft cloth in a mixture of lukewarm water and a little fabric softener or dish washing detergent. Wring the cloth until it's almost dry, and then use it to wipe the screen.
2. Make sure the excess water is off the screen, and then let it air-dry before you turn on your TV.

Cleaning the Cabinet

To remove dirt or dust, wipe the cabinet with a soft, dry, lint-free cloth.
Please be sure not to use a wet cloth.

Extended Absence



If you expect to leave your TV dormant for a long time (such as a vacation), it's a good idea to unplug the power cord to protect against possible damage from lightning or power surges.

Product Specifications

MODELS	42PX4D-UB / 42PX5D-UB
Width (inches / mm)	49.3 / 1252
Height (inches / mm)	27.8 / 705.5
Depth (inches / mm)	11.3 / 286.7
Weight (pounds / kg)	85.3 / 38.7
Resolution	1024x768 (Dot)
Power requirement	AC100-240V ~ 50/60Hz
Television System	NTSC-M, ATSC, 64 & 256 QAM
Program Coverage	VHF 2 ~ 13, UHF 14 ~ 69, DTV 2 ~ 69, CATV 1 ~ 135, CADTV 1 ~ 135.
External Antenna Impedance	75 Ω
Operating Temperature Range	32 ~ 104°F (0 ~ 40°C)
Operating Humidity Range	Less than 80%

- The specifications shown above may be changed without prior notice for quality improvement.

Notes



LG ELECTRONICS, INC.
PLASMA TV — U.S. LIMITED WARRANTY

Your LG Plasma TV will be repaired or replaced in accordance with the terms of this warranty, at LGE's option, if it proves to be defective in material or workmanship under normal use, during the warranty period ("Warranty Period") listed below, effective from the date ("Date of Purchase") of original consumer purchase of the product. This warranty is good only to the original purchaser of the product and effective only when used in the United States, including Alaska, Hawaii, and U.S. Territories.

WARRANTY PERIOD:

LABOR and PARTS: 2 YEARS from the Date of Purchase. Your unit will be repaired or replaced with a new, substitute model or factory reconditioned unit, at LGE's option. If repaired, parts used in the repair may be new or remanufactured.

Replacement Units and Repair Parts are warranted for the remaining portion of the original unit's warranty period.

EFFECTIVE DATE OF WARRANTY: Your warranty period begins on the date of sale to the original consumer/end user. KEEP THE DEALER'S DATED BILL OF SALE OR PROOF OF DELIVERY as evidence of the purchase date. You will be required to submit a legible copy of your bill of sale or proof of delivery when requesting warranty service.

HOW SERVICE IS HANDLED:

In-Home Service: Please retain dealer's dated bill of sale or delivery ticket as evidence of the Date of Purchase for proof of warranty, and submit a copy of the bill of sale to the service person at the time warranty service is provided.

Please call 1-800-243-0000 to locate your nearest LGE Authorized Service Center.

Visit our website at:

<http://www.lgservice.com>

THIS WARRANTY IS IN LIEU OF ANY OTHER WARRANTY, EXPRESS OR IMPLIED, INCLUDING WITHOUT LIMITATION, ANY WARRANTY OF MERCHANTABILITY OR FITNESS FOR A PARTICULAR PURPOSE. TO THE EXTENT ANY IMPLIED WARRANTY IS REQUIRED BY LAW, IT IS LIMITED IN DURATION TO THE EXPRESS WARRANTY PERIOD ABOVE. NEITHER THE MANUFACTURER NOR ITS U.S. DISTRIBUTOR SHALL BE LIABLE FOR ANY INCIDENTAL, CONSEQUENTIAL, INDIRECT, SPECIAL, OR PUNITIVE DAMAGES OF ANY NATURE, INCLUDING WITHOUT LIMITATION, LOST PROFITS, LOST OR CORRUPTED PROGRAMMING OR DATA, OR ANY OTHER DAMAGE WHETHER BASED IN CONTRACT, TORT, OR OTHERWISE. Some states do not allow the exclusion or limitation of incidental or consequential damages or limitations on how long an implied warranty lasts, so the above exclusion or limitation may not apply to you. This warranty gives you specific legal rights and you may also have other rights that vary from state to state.

CONCERNING PIXEL FUNCTIONALITY: Your Plasma TV contains about one million individual pixels. Plasma TV typically contain a small number of pixels that do not function normally. Your display has been inspected and is in compliance with manufacturer's specifications, indicating that any pixel defects do not effect the operation or use of your display.

IMPORTANT: Please fill out and mail in your Product Registration Card or go to www.lgservice.com to register your product online. This information will allow us to reach you promptly should we discover a safety or reliability problem that could affect you.

THIS LIMITED WARRANTY DOES NOT APPLY TO:

<ul style="list-style-type: none">● damage caused in shipping or transit● service required as a result of improper installation, including incorrect or insufficient AC supply (please consult the owner's manual for power supply requirements)● installation or repair of antenna systems, cable converters, cable company supplied equipment, or other components in a video system● set-up or adjustment on consumer controls, or damage caused by improper adjustments● damage caused by other system components● any panel that has been modified or incorporated into any other product● replacement of batteries on the remote control.● damage (including cosmetic damage), failure, loss or personal injury due to misuse, abuse, negli-	<p>gence, improper maintenance or storage, or to acts of nature or other causes beyond our control. (Causes beyond our control include but are not limited to lightning strike, power surges, power outages and water damage.)</p> <ul style="list-style-type: none">● image burn-in● repair or replacement of warranted parts by other than LGE authorized service centers.● units purchased or serviced outside of the coverage area.● product where the original factory serial numbers have been removed, defaced or changed in any way.● product sold and labeled as "as is, where is" or similar disclaimer.
---	--

The cost of repair or replacement under these excluded circumstances shall be borne by the consumer.

CUSTOMER INTERACTIVE CENTER NUMBERS:

<p>To obtain customer assistance, product information or Dealer or Service locations</p>	<p>Call 1-800-243-0000 24 hours a day, 365 days per year</p>
---	---

FOR SERVICE:

Before you call for warranty service, check your operating guide – you may avoid a service call.

For warranty service information, please contact the LGE Customer Interactive Center telephone number.

When calling for service, **please have your product model number, serial number and the date of purchase or the date of original installation available.**

If a replacement unit is required, under some circumstances you may be asked to provide a reserve deposit to the LGE Service Center against a credit card number as surety for advanced shipment. Your credit card will not be charged if you return the defective unit within 10 working days.

If a replacement unit is received, please use the carton and packaging from that unit in returning the defective unit to the LG®Brand Service Center.

Parts and service in accordance with the LGE warranty are LGE's responsibility and will be provided without charge. Other service requirements will be at the owner's expense. If you have problems in obtaining satisfactory warranty service, write or call the LGE Customer Interactive Center. Service may be provided by independently owned and operated service organizations.

To assure proper credit and avoid unnecessary charges, you must obtain an LGE Return Authorization before returning any product to the LGE Service Center. Contact the Customer Interactive Center for details.

TO CONTACT THE LGE CUSTOMER SERVICE CENTER BY MAIL:

LGE Customer Interactive Center
P.O. Box 240007
201 James Record Road
Huntsville, Alabama 35824
<http://www.lgservice.com>

P/NO : 3828VA0528B©(3828VB0002M)